



PUMP COMPANY

Zoeller Family of Water Solutions™

Accessories, Controls and Package Systems

Package Systems

Check Valves

Float Switches

Alarm Systems

Control Panels

Rail Systems



Your Peace of Mind is Our Top Priority®

WHAT SETS ZOELLER SYSTEMS APART?

Since 1939, Zoeller Company has been manufacturing water pumps of many types. From pedestal pumps in the beginning to large HP submersible, non-clog pumps in recent years, we have gained invaluable manufacturing experience from our humble beginning in August Zoeller's basement workshop.

Over the years, one of our most important mottos has been, 'We excel at 1,000 little things'. From start to finish, we take pride in our products. When you have residential or commercial wastewater issues, you can count on Zoeller to deliver the very best solutions. Our commitment to unsurpassed quality offers years of service and durability with a responsive and knowledgeable product support team just a phone call away.

- **SUPPORTING THE WHOLE PACKAGE...**

In pumping systems, the "whole package" encompasses far more than just high quality pumps. The control, alarm, valves, disconnects, piping and container are all important components of a complete system. Zoeller understands that an installation is only as good as the weakest element, so we have gone to great lengths to provide accessory items that are as reliable as our legendary pumps. While we manufacture most of our products from start to finish, including check valves and rail systems, we recognize that producing certain specialized accessories requires a different skill set than our roots provide. In order to offer you the best components for your project, we have partnered with other specialized manufacturers, all of them leaders in their respective fields. You can be assured that the vein of Zoeller quality runs top to bottom throughout our entire product offering.

- **QUALITY CONTROL AT ALL LEVELS...**

You may have heard that all of Zoeller's submersible pumps are 100% factory tested underwater prior to shipment. However, you may not be aware that before any new product is judged fit to carry a Zoeller label, we first subject it to a barrage of durability and performance tests. We pressurize check valves until they burst, cycle float switches until they give out, and crush basins until they collapse. These over-the-top abuses have very practical goals. They ensure that our products will withstand the rigors of your real world applications. We follow this testing with inspections of all materials that come through our doors in order to ensure the highest level of quality and consistency. At Zoeller, we realize that your projects are our projects and that your successes are our successes.

- **FULL BREADTH OF PRODUCT LINE...**

Zoeller is your 'one stop shop' when dealing with dewatering and wastewater systems. We offer everything from a small fractional sump pump to a large, 100 HP non-clog pump. From battery back-ups, check valves, sewage grinder systems, small prepackaged residential units or large prepackaged municipal systems, Zoeller can offer it all. Next time you are looking for a water or wastewater system, reach for the only catalog you will ever need... Zoeller Company!



900 Series

Preassembled Sump Pump Systems



SPECIFICATIONS:

- No assembly required! Drop it in the hole and go!
- Pump switch is installed 180° from inlet.
- Discharge pipe is plumbed with a predrilled 3/16" (5 mm) vent hole.
- Electrical cord seal is installed in cover.
- Cover is sealed and bolted down.
- Basin is filled with environmentally-safe peanuts for safe transit. Just add water and they dissolve!
- Automatic cast iron or thermoplastic pump with tank and all hardware.
- 18"x22" (45.7x55.9 cm) basin with 4" inlet
- Deluxe unit has a radon-approved basin and cover for radon prevention.
- Standard and economy models use a polyethylene basin and cover.
- Standard and economy covers have a 2" vent, 1-1/2" discharge.
- Deluxe cover has a 3" vent, 1-1/2" discharge.
- Fast, easy and job ready!

See FM2124 for further information.

SUMP PUMP SERIES	MODEL PUMP WITH BASIN	SYSTEM TYPE	WEIGHT (lbs/kg)
900-0001	M53	DELUXE	48 lbs/21.8 kg
900-0002	M53	STANDARD	53 lbs/24.0 kg
900-0003	M72	ECONOMY	44 lbs/20.0 kg

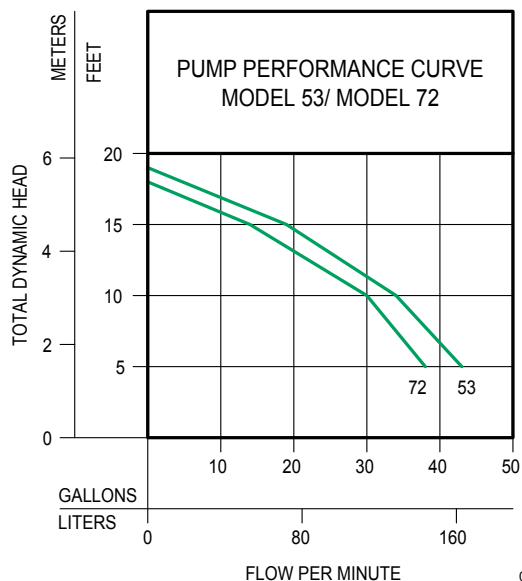

015887A

910 Systems

Unassembled Simplex and Duplex Sewage Package Systems



Ideal for homes, farms, trailer courts, motels, restaurants and institutions where drain facilities are below existing sewer lines. Maximum temperature rated at 130°F (54°C).

Duplex System for Indoor Sewage Applications (unassembled)



INCLUDES:

- (2) automatic pumps (M264 or M267)
- (1) 10-0804 Smart-Pak residential alternator with alarm
- (1) 31-1105 30"x36" (76.2x91.4 cm) poly-foam basin with 2" vent/discharge
- (2) 30-0101 Tri-Check® valves

See FM0454 for further information.

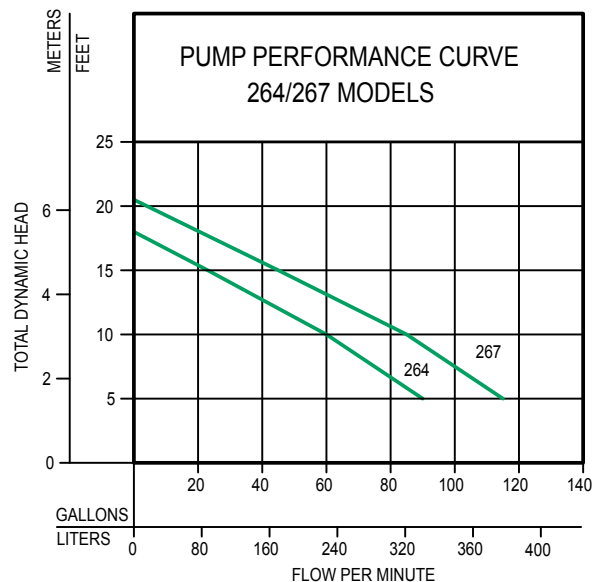

009969A

915 Grinder Package

1/2 HP Grinder Package

The industry's only 115 volt, 1/2 HP grinder pump stands up to the toughest applications where traditional sewage pumps fail. This job-ready system uses our innovative, stainless steel cutter, which requires little or no maintenance. The built-in scouring system and baffle keep debris from obstructing float operation. Small yet powerful, this efficient 7 amp pump handles most debris including: socks, denim, sanitary napkins, diapers, etc. The system is 100% preassembled for ease of installation.

Patent No. 9,004,381. Other Patents Pending

APPLICATIONS:

- Residential wastewater
- Light commercial
- 2" sewage ejection retro fits for most existing sewage basins

SPECIFICATIONS:

- 1-1/4" top discharge
- 1/2 HP, 115 V motor
- Cast iron motor housing with corrosion-resistant, powder-coated epoxy finish
- Includes high water indoor alarm and 1-1/4" "silent" check valve
- Available in 18"x30" (46x76 cm) polystructural foam or 24"x24" (61x61 cm) poly basin
- Stainless steel carriage directs inflow and reduces clogging
- Thermally-protected motor

See FM2795 for further information.



24"x24" (61x61 cm)



THE SHARK
Series



Cutter Blade



18"x30" (46x76 cm)

For complete product information, visit:
www.zoeller.com

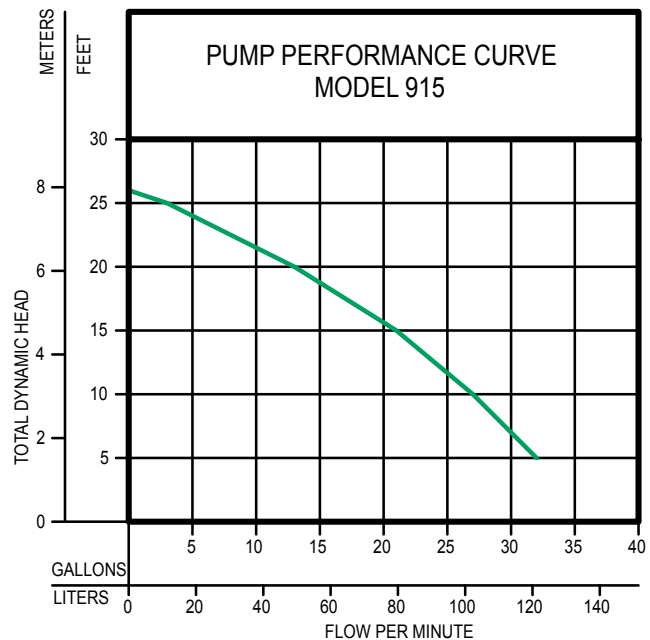

151790

915 Grinder Package, continued

1/2, 3/4, 1 HP Grinder Packages

The fractional HP grinder pumps are now available in package systems. This job-ready (non-suspended) system uses our innovative, stainless steel Tri-slice® cutter, which requires little or no maintenance. The hardened stainless steel cutter is ideal for handling difficult solids such as wipes, rags, towels, etc. that can jam traditional style ejector pumps.



18"x30" (46x76 cm)



Cutter Blade

APPLICATIONS:

- Residential wastewater
- Light commercial

SPECIFICATIONS:

- 1-1/4" top discharge
- 803 - 1/2 HP, 805 - 3/4 HP, 807 - 1 HP
- Cast iron construction
- Oil filled for optimal heat dissipation
- Available in 18" x 30" (46 x 76 cm) polystructural foam or 24" x 24" (61 x 61 cm) poly basin. Consult factory for additional options.
- Thermally-protected motor

For complete product information, visit:
www.zoeller.com



24"x24" (61x61 cm)

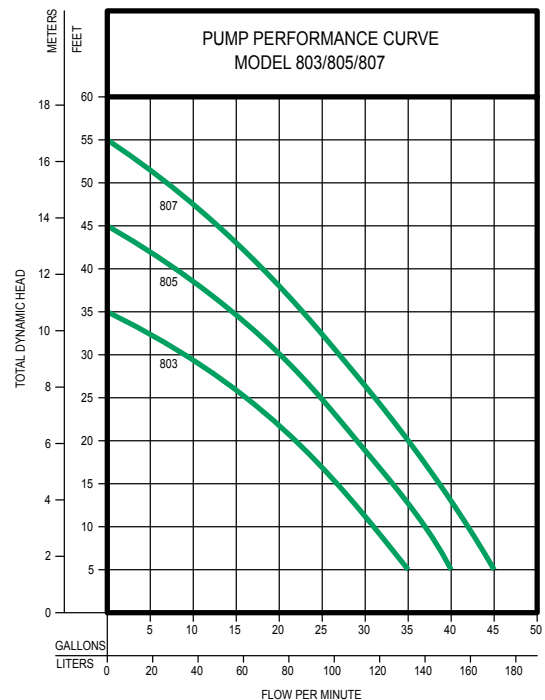

153604

912 Systems

Simplex Sewage Package Systems (job ready/assembled)



SPECIFICATIONS:

- More choices, easier installation and fast delivery
- Saves labor and reduces installation errors
- 2" (50 mm) solids-handling pump
- 2" PVC discharge pipe, 30" (76 cm) long on 18"x30" (46x76 cm), 24" (61 cm) long on 24"x24" (61x61 cm) and 36" (91 cm) long on 24"x36" (61x91 cm)
- Basins - polyethylene, poly-foam or fiberglass construction with poly or solid steel covers and 4" pipe seal hub, 4" PVC hub (deluxe) or 4" cast iron hub on L.A. Code Systems
- Check valve options - 30-0151, 30-0020, 30-0021, 30-0101 or 30-0103 (not included)
- Systems available with alarms and preinstalled alarm float.
- Premium indoor systems have a split cover for easy pump inspection, torque stops and an anti-flotation device.
- Side discharge systems rated for outdoor burial: solid polyethylene structural foam lid and basin with 2" discharge on side
- 3/16" (5 mm) vent hole drilled

See FM2164 for further information.

24" X 24" Simplex Sewage System



See FM2810 for further information.

Sump & Sewage Basins

SPECIFICATIONS:

- Available in high-density polyethylene structural foam (PSF), polyethylene or fiberglass
- Ideal for residential, commercial and industrial applications
- Complete with necessary sealing hardware and flanges
- Available with 2" or 3" vent and 2" or 3" discharge
- Lid with gasket and 4" cast iron inlet hub with anti-corrosion coating are included with the sewage basins
- Centerline of hub is located 10-1/2" (26.7 cm) from top of basin (std.). Custom locations available
- Polyethylene sewage pump basins are IAPMO approved. For 10' (3 m) stack test models, refer to charts on FM0487.
- Sealed (radon) basins for sump pumps in 18"x22" (45.7x55.9 cm) and 18"x30" (45.7x76.2 cm) sizes
- Polyethylene sump basin available with plastic unsealed covers in 18"x22" (45.7x55.9 cm)
- Sewage basins are watertight and gas-tight when properly installed
- Durable steel cover with gasket standard on simplex and duplex sewage basins
- One piece, seamless construction on all basins
- Duplex covers include two pump plates and inspection plate
- Ready to install for economical and simple installation
- Dimensional engineering data available
- Temperature rated 130°F (54°C)
- Fiberglass models available that will pass the 10' (3 m) water stack test. (Refer to charts on FM0487) (L. A. - RR-5311)
- Various custom diameters and lengths available in fiberglass. Consult factory. Also with 10' (3 m) water stack test.

See FM0487 for further information and accessories.

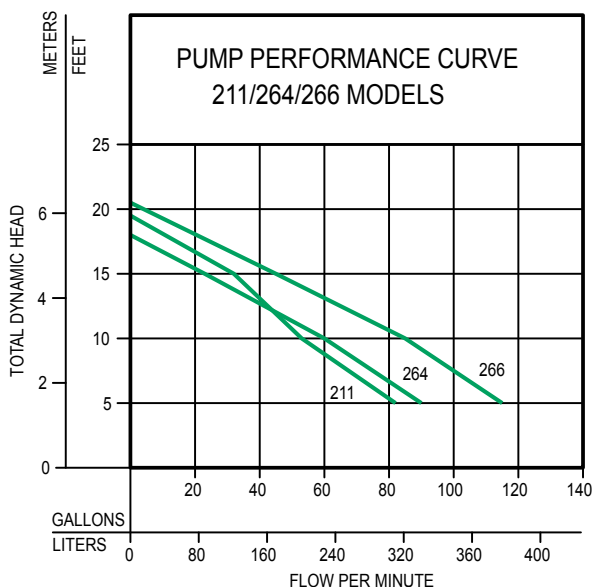

009969B

151790

Qwik Pak LS

Wastewater Universal Lift Station

While current systems require the pump to be included in the package, the Qwik Pak LS allows a Zoeller pump to be purchased separately or provided from existing stock. Gone is the headache of having to purchase a pump that you may already have in stock! The Qwik Pak LS with a Z-Rail® Disconnect System is designed to be used in dewatering, sump, effluent, sewage or grinder systems. The piping configuration provides the flexibility for up to a 2" discharge. Use the Qwik Pak LS when a speedy installation is required. The prepackaged station, in conjunction with an accessory kit, provides everything required to install a complete system. The discharge piping is installed along with the check valves and ball valves.



Basin Sizes:

- 24" (61 cm) diameter simplex units available in 60" or 84" (152 or 213 cm) depths
- 36" (91 cm) diameter duplex units available in 60" or 84" (152 or 213 cm) depths

Lift Stations Include:

- Fiberglass basin with anti-floatation device and solid outdoor-rated, fiberglass cover
- 4" pipe seal (loose for field installation)
- Ductile iron Z-Rail® disconnect system for easy pump removal
- 1.25", 1.5" or 2" slide rail assembly for use on multiple pumps
- Stainless steel lift cable(s)
- 2" PVC ball valve and 2" cast iron check valve
- 2" SCH. 40 PVC discharge piping
- (3) 15' (5 m) variable level float switches with installed float tree
- Kits available for commercial duty effluent, sewage or grinder pumps
- Can be used with smaller residential pumps with adaptor (consult factory)

Optional Accessories include:

- Access riser assemblies
- Junction boxes
- Outdoor vents

Commercial Duty

Prepackaged Lift Station

The Zoeller prepackaged unit is designed to be an all-inclusive lift station. With the rail system, variable level floats, discharge piping and optional junction box installed along with the submersible pumps and control panel, all the contractor has to do is install the 4" hub, dig the hole and attach the discharge piping. The configurations shown in our catalog are just the tip of the iceberg. Zoeller's engineering and manufacturing staff can design-build ALMOST any prepackaged system that can be imagined! Whether the system is designed for a dewatering, effluent, sewage or grinder pump, all components are guaranteed to work when they arrive at the jobsite due to the fact that EACH system is reviewed for compatibility prior to being built and then tested for proper fit after assembly.



922-0009 pictured

Basin Sizes:

- 24" (61 cm) diameter simplex units available in 48" - 96" (122 - 244 cm) standard depths
- 36" (91 cm) diameter duplex units available in 48" - 96" (122 - 244 cm) standard depths

Lift Stations Include:

- Fiberglass basin with anti-floatation device with solid, outdoor-rated, fiberglass cover
- 4" pipe seal (loose for field installation)
- Zoeller "square guide" disconnect system for easy pump removal
- 1.25", 1.5" or 2" discharge configurations for use on multiple pumps
- Stainless steel lift cable(s)
- PVC ball valve and cast iron check valve installed
- Sch. 40 PVC discharge piping

Optional Accessories include:

- Cover material (steel, fiberglass, gas-tight, indoor etc.)
- Custom valve boxes (attached and detached)
- Stainless steel and bronze non-spark systems for hazardous environment pumps
- 3" and 4" discharge configurations
- Basins up to 96" (244 cm) diameter and 240" (610 cm) depths are available – consult factory
- Custom design/build package systems

Valves: Check, Ball, & Plug

Full-Flow Unichecks

30-0152 / 30-0160
30-0163 / 30-0164
1-1/4" - 3" Cast Iron



SPECIFICATIONS:

- Vertical or horizontal installation
- Full-flow design, no restrictions
- Stops backflow of water
- Standard, 1-1/4", 1-1/2", 2", 3" female NPT pipe
- Neoprene polyester, reinforced flapper, smooth edge design, with cast iron and non-corrosive metal backing plates and stainless steel fastener
- Corrosion-resistant, powder coated epoxy finish
- Rated at 50 PSI (115' [35 m] of head) at 130°F (54°C)
- Stainless steel bolts
- Suitable for installation below basin cover



30-0021 / 30-0151 2" Plastic or Cast Iron Slip Union



SPECIFICATIONS:

- Full 2" flow design - meets BOCA (P.604.2) 2" full flow pump code
- Checks backflow of water
- Simple to install (no threading of pipe required). Save time and material costs
- Neoprene gasket and flapper, weighted with heavy stainless steel metal backing plates and rivet
- Vertical or horizontal installation
- Slips over ABS, PVC, steel or copper pipe
- Reduces motor and pump noise
- Flexible neoprene slip x slip union includes stainless steel clamps for low pressure systems. Avoid more than 10' (3 m) static head above the check valve. 4.3 PSI at 130°F (54°C)
- Extra wide hinge to reduce stress
- Plastic check has PVC body and can be installed with solvent-welded couplings for pressure systems to 25 PSI, 57' (17.4 m) of head (30-0023)
- Model 30-0151 has corrosion-resistant, powder coated epoxy finish.
- Stainless steel sleeves available to meet Illinois Plumbing Code. (Cast Iron 30-0201 / PVC 30-0202)
- Meets requirements of Wisconsin Uniform Plumbing Code

Full-Flow Unichecks

30-0181 / 30-0200
**1-1/4" - 1-1/2" Slip x Slip
Union**



SPECIFICATIONS:

- Flapper bends over a radius, no sharp 90° edges — lengthens life of flapper hinge
- PVC plastic check body, ultrasonically welded and can be solvent-welded for rigid, pressure-rated piping systems to 25 PSI, (57' [17.4 m] of head) at 130°F (54°C) (30-0182)
- Vertical or horizontal installation
- Available in individual packages for pegboard display (30-0191)
- All stainless steel screws, nuts and clamps on model 30-0200 only
- Slip x slip for 4.3 PSI, 10' (3 m) of head at 130°F (54°C). Avoid more than 10' (3 m) static head above the check valve.
- Designed to reduce water hammer

30-0214 / 30-0215 / 30-0216 1-1/4" - 2" Cast Iron NPT High-Temperature



SPECIFICATIONS:

- Use with 2000 and 3000 series high-temperature pumps
- Vertical or horizontal installation
- Full-flow design, no restrictions
- Stops backflow of water
- Standard 1-1/4", 1-1/2", 2" female NPT pipe
- EPDM strand-reinforced flapper, smooth-edge design with cast iron and non-corrosive metal backing plates & stainless steel fastener.
- Corrosion-resistant, powder coated epoxy finish
- Rated at 50 PSI (115' [35 m] of head) at 200°F (93°C)
- Stainless steel bolts



Valves: Check, Ball, & Plug, *continued*

Tri-Check®

30-0100 / 30-0101 1-1/2" - 2" PVC Check Valve/Ball Valve Union Combination



The Combo

30-0102 / 30-0103 1-1/2" - 2" PVC Check Valve Union Combination



SPECIFICATIONS:

- Full-flow check valve design
- Threaded union allows pump to be removed without disrupting discharge piping
- Saves time and money - easy to install
- Neoprene gasket and flapper, weighted with stainless steel backing plates and rivet
- Can be installed on vertical or horizontal pipe
- Meets plumbing codes requiring a ball valve installed in conjunction with a check valve

SPECIFICATIONS:

- All stainless steel screws
- Replaceable flapper in the check valve
- Extra wide hinge to reduce stress
- Rated for 25 psi, 57' (17.4 m) of head

Quiet Check - PVC Solvent Weld with Union Check Valve



P/N 30-0040
White PVC

P/N 30-0041
Clear PVC

P/N 30-0046
White PVC

P/N 30-242
Clear PVC

SPECIFICATIONS:

- 1/2 lb. (0.23 kg) spring eliminates water hammer
- Reduces motor and pump noise
- Designed for both horizontal and vertical usage
- Full-flow, non-clog design installation
- Durable PVC check body and compression end fittings
- Solvent-weld ends allow for easy installation
- 30-0044 and 30-0045 have no unions
- No threading of pipe required - saves time and money
- Pressure rated at 50 PSI (115' [35 m])
30-0241 & 30-0242 Slip Union: 40 PSI (92' [28 m])
30-0243 & 30-0244 Slip Union: 30 PSI (69' [21 m])
- Consult factory for use over 130°F (54°C)
- Suitable for installation below basin cover

P/N	SERVICE PART
152294	1-1/2" union assembly
152293	2.0" union assembly

QUIET CHECKS PVC SOLVENT WELD

Item Number	Pipe size	Valve Body	Weight (lbs/kg)	Length (in/mm)	Carton Qty
30-0239	1-1/4"	White	0.75 lbs/0.3 kg	9.50"/241 mm	12
30-0040	1-1/2"	White	2 lbs/0.9 kg	9.50"/241 mm	12
30-0041	1-1/2"	Clear	2 lbs/0.9 kg	9.50"/241 mm	12
30-0042	2"	White	3 lbs/1.4 kg	10.50"/267 mm	12
30-0043	2"	Clear	3 lbs/1.4 kg	10.50"/267 mm	12
30-0044	3"	White*	3 lbs/1.4 kg	9.50"/241 mm	8
30-0045	3"	Clear*	3 lbs/1.4 kg	9.50"/241 mm	8

QUIET CHECKS PVC SLIP UNION

30-0241	1-1/2"	White	1.2 lbs/0.5 kg	10.50"/267 mm	12
30-0242	1-1/2"	Clear	1.2 lbs/0.5 kg	10.50"/267 mm	12
30-0243	2"	White	1.8 lbs/0.8 kg	11.50"/292 mm	12
30-0244	2"	Clear	1.8 lbs/0.8 kg	11.50"/292 mm	12

QUIET CHECKS WITH QUARTER TURN BALL VALVES

30-0046	1-1/2"	White	3 lbs/1.4 kg	14.75"/375 mm	12
30-0047	1-1/2"	Clear*	3 lbs/1.4 kg	14.75"/375 mm	12
30-0048	2"	White	4 lbs/1.8 kg	16.12"/409 mm	12
30-0049	2"	Clear*	4 lbs/1.8 kg	16.12"/409 mm	12

*Solvent weld only. No unions included (see chart).

GENERAL CAUTION: Water hammer creates momentary high pressure surges. These surges can cause severe damage to check valves and the piping system. Consideration for water hammer must be included in the piping system design. Reference ASPE Data Book, Chapter 2.33. May require check valves with special non-slam features or other engineered solutions.

Valves: Check, Ball, & Plug, *continued*

Compression

1-1/2" - 3" Compression Unichecks



ITEM NO.	PIPE SIZE	WEIGHT (lbs/kg)	LENGTH (in/mm)	CARTON QTY
30-0015	1-1/2"	1.1 lbs/0.5 kg	7-1/2"/180 mm	12
30-0020	2"	1.7 lbs/0.8 kg	9-3/4"/248 mm	12
30-0030	3"	5 lbs/2.3 kg	14"/356 mm	2

Pressure rated to 125 psi (861 kPa) at 285' (86.9 m) at 75°F (24°C)

3" & 4" Flanged Check Valves



SPECIFICATIONS:

- Heavy-duty ductile iron construction
- Angled seal for non-slam closure
- Non-clog design
- Reinforced disc
- Drip-tight seating
- Rated up to 250 PSIG
- Designed for both horizontal and vertical usage
- Optional backflow actuator and mechanical indicator

PART NO.	VALVE SIZE	"A" (in/mm)	"B" (in/mm)	"C" (in/mm)	"D" (in/mm)	"E" (in/mm)	"F" (in/mm)	"G" (in/mm)	"H" (in/mm)	WEIGHT (lbs/kg)
6030-0197	2-1/2"	8-1/2"/ 215.9 mm	5-1/2"/ 139.7 mm	7"/ 177.8 mm	11/16"/ 175 mm	1-1/2"/ 63.5 mm	3-3/8"/ 85.7 mm	5/8"/ 15.9 mm	4"/ 101.6 mm	32 lbs/ 14.5 kg
6030-0202	3"	9-1/2"/ 241.3 mm	6"/ 152.4 mm	7-1/2"/ 196.5 mm	3/4"/ 19.1 mm	3"/ 76.2 mm	5-1/8"/ 130.2 mm	5/8"/ 15.9 mm	4"/ 101.6 mm	37 lbs/ 16.8 kg
6030-0203	4"	11-1/2"/ 292.1 mm	7-1/2"/ 190.5 mm	9"/ 228.6 mm	15/16"/ 23/9 mm	4"/ 101.6 mm	5-3/4"/ 146.1 mm	5/8"/ 15.9 mm	8"/ 203.2 mm	63 lbs/ 28.6 kg

REF NO.	PART NAME	MATERIAL
1	Body	Ductile iron ASTM A536, Grade 65-45-12
2	Cover	Ductile iron ASTM A536, Grade 65-45-12
3	Disc	Buna-N w/ steel and nylon reinforcement
4	Gasket	Compressed non asbestos fiber
5	Cover Bolt	Alloy steel SAE Grade 5

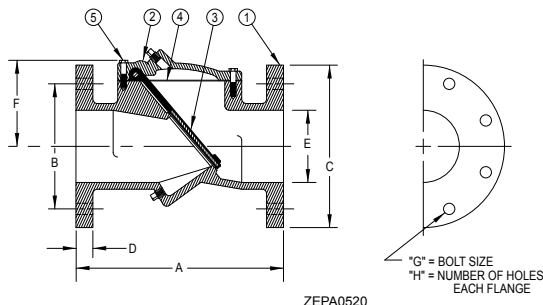

Inline

30-0238 Inline Check Valve



SPECIFICATIONS:

- Rubber coupling with stainless steel clamps
- Threads into pump discharge
- Pre-drilled weep hole
- 4.3 PSI, 10' (3 m) of head max
- Vertical installation only

2", 3" & 4" Cast Iron Plug Valves



SPECIFICATIONS:

- Designed to handle solids-bearing flows
- Cast iron housing - rated 175 psi
- 99% pure nickel welded seat
- 1/4 turn Buna plug
- Upper and lower ball bearings
- Provided with hand lever*



*Hand lever not shown in photos

THREADED MODELS				
SIZE	PART NO.	WIDTH (in/mm)	HEIGHT (in/mm)	WEIGHT (lbs/kg)
2"	6030-0082	5-1/4"/ 133.4 mm	7-1/8"/ 181.0 mm	12 lbs/12.4 kg
3"	6030-0083	8-3/4"/ 222.3 mm	14-1/8"/ 358.8 mm	45 lbs/20.4 kg

FLANGED MODELS				
SIZE	PART NO.	WIDTH (in/mm)	HEIGHT (in/mm)	WEIGHT (lbs/kg)
3"	6030-0085	8"/ 203.2 mm	14-1/8"/ 358.8 mm	53 lbs/24.0 kg
4"	6030-0086	9"/ 228.6 mm	16-3/4"/ 425.5 mm	66 lbs/29.9 kg

GENERAL CAUTION: Water hammer creates momentary high pressure surges. These surges can cause severe damage to check valves and the piping system. Consideration for water hammer must be included in the piping system design. Reference ASPE Data Book, Chapter 2.33. May require check valves with special non-slam features or other engineered solutions.

Switch-Mate Piggyback

Variable Level Float Switch

SPECIFICATIONS:

- Converts nonautomatic pump to automatic pump
- Simple installation
- Adjustable/variable level
- Standard 15' (5 m) and 20' (6 m) SJOW CPE cord with molded plug. 10-0055 and 10-0065 - 10' (3 m) cord standard
- Float is constructed of durable PVC/polypropylene
- Standard - normally open (NO) ("pumps down")
- Optional - normally closed (NC) ("pumps up") Consult factory
- Maximum operating temperature for 10-0748: 120°F (49°C). All other switches: 140°F (60°C)
- Float is omnidirectional
- Includes mounting clamp
- Designed for EFFLUENT, SEWAGE and DEWATERING applications
- Variable level float switch, for use in 18" (45.7 cm) minimum diameter basins
- 10-0748 - 25' (8 m) cord standard, no molded plug. Can be used as a control switch to operate an external magnetic or combination starter on three phase pumps
- Vertical piggyback float switch. Ideal for narrow diameter basins. 6.5" (16.5 cm) maximum cycle range
- Use recommendation chart for switch selection

Single Piggyback Variable Level Float Switch

13 AMP MAXIMUM	15 AMP MAXIMUM	20 AMP MAXIMUM
Normally Open (NO)	Normally Open (NO)	Normally Open (NO)
10-0055 - 115 V - 10' (3 m)	10-0032 - 115 V - 15' (5 m)	10-0748 - 115 V/230 V - 25' (8 m)
10-0034 - 115 V - 15' (5 m)	10-0033 - 230 V - 15' (5 m)	
10-0035 - 230 V - 15' (5 m)	10-0705 - 115 V - 20' (6 m)	
10-0063 - 115 V - 20' (6 m)	10-0559 - 230 V - 20' (6 m)	
10-0706 - 230 V - 20' (6 m)		
Normally Closed (NC)	Normally Closed (NC)	
10-0065 - 115 V - 10' (3 m)	10-0064 - 115 V - 15' (5 m)	
10-0037 - 115 V - 15' (5 m)		
10-0062 - 230 V - 15' (5 m)		



Note: All variable level float switches in this section are mechanically activated and do not contain mercury.



Single Piggyback Vertical Float Switch

13 AMP MAXIMUM NORMALLY OPEN (NO) VERTICAL
10-2041 - 115 V - 10' (3 m)
10-2042 - 115 V - 15' (5 m)
10-2043 - 115 V - 20' (6 m)



Double Piggyback Variable Level Float Switch

MECHANICAL
10-1964 - 115 V - 15 Amp - 15' (5 m)
10-1965 - 230 V - 15 Amp - 15' (5 m)



Variable Level Control Switches

APPLICATIONS:

- Simplex or duplex pump control and high level alarm on electrical alternating control panel systems
- For dewatering, effluent and sewage applications
- Switch for A-Pak

SPECIFICATIONS:

- Float is constructed of durable PVC/polypropylene
- Standard mechanical variable level control switches are rated for 115/230 V, 5 Amps
- Low-current, mechanical variable level control switches are rated for 125 VAC/30 VDC, 0.1 Amps
- 18/2 Type SJOW CPE cord standard
- Cords are available in 15-25-35-50' (5-8-11-15 m) lengths
- Temperature rating of 140°F (60°C)
- Approximately 1.5" (38 mm) liquid level differential in switching action

ADJUSTABLE WEIGHT: (P/N 10-0689) provides an accurate pivot point for suspended float switches

- Gripping teeth on clip and weight channel securely lock float cable into place
- Cable weight can be adjusted without the use of tools

HOUSING: 1lb 12oz. (0.8 kg), 2.8"x3.3" (7.1x8.4 cm), impact-resistant and non-corrodible, PVC housing for liquids up to 140° F (60° C)

CLIP: injection-molded acetal plastic

WIRE/CABLE ACCOMODATED: SJOW, SJTW, 18/2, 18/3, 16/3, 14/2, 14/3

SHIP WEIGHT: 2 lbs. (0.9 kg)



FLOAT SWITCHES			
Mechanical		Cord Length (ft/m)	Mounting Method
Standard P/N*	Low Current P/N**		
10-0743	10-2060	15/5	Clamp
10-0744	10-2061	20/6	Clamp
10-1877	10-2062	25/8	Clamp
10-1878	10-2063	35/11	Clamp
10-1879	10-2064	50/15	Clamp
10-1880	10-2065	15/5	Adjustable Weight
10-1881	10-2066	25/8	Adjustable Weight
10-1882	10-2067	35/11	Adjustable Weight
10-1883	10-2068	50/15	Adjustable Weight

FLOAT SWITCH TREES			
Mechanical		Cord Length (ft/m)	Mounting Method
Standard P/N*	Intrinsically Safe P/N**		
10-1456	10-1456	---	Tree Only
10-1886	10-2069	15/5	(3) 15' (5 m) Floats & Tree
10-1887	10-2070	15/5	(4) 15' (5 m) Floats & Tree

* Not for use with intrinsically-safe control systems.

** For use with intrinsically-safe control systems only.

Products may not be exactly as pictured.



SmartPak® Plus

10-0804 Residential Alternator System

SPECIFICATIONS:

- Alternates two automatic pumps up to 1/2 HP, 12 amps each, 115V, single phase (not to be used with grinder pumps)
- Extends pump life
- Compact design easily mounts in confined spaces
- Circuit fault protection
- Specially designed for humid areas
- Universal connection for alarm switch replacement
- Auxiliary output contacts (normally open) for remote alarm connection
- Solid green LED lights for Pump 1, Pump 2 and Power
- Flashing red LED lights for alarm conditions
- 9' (2.7 m) power cord
- Multiple alarm modes will alert user to potential problems and protect property by switching to the other pump when necessary

Alarms include:

- High water
- Loss of power
- Continuous pump run
- Breaker tripped
- Pump failure
- Button for Silence and Reset
- Built-in, rechargeable battery will operate the alarm and LED lights for a limited time during power outage



Z Control® Gateway

10-4144

SPECIFICATIONS:

- Using the Gateway's input terminals, get email, text and push notifications from any device with auxiliary outputs
- Utilizes your free account on the Z Control® Cloud
- When used with the Z Control® Enabled products that require the Gateway, additional features such as remote control and monitoring are included
- Power adapter included
- Connects to existing router using either Wi-Fi® or ethernet.



Real Time Peace of Mind™



Qwik Box

Pump Control and Alarm

The Qwik-Box is a junction box designed for easy hookup of pumps and alarm systems. It is used in septic effluent, sewage, or dewatering applications, and requires a connection outside the building or residence. The Qwik-Box eliminates the need for junction wiring boxes inside sewage and septic tanks, and consists of UL listed components.

SPECIFICATIONS:

- No need to cut off plugs
- Sealed watertight enclosure
- Available in 115 Volt or 230 Volt design
- Corrosion-resistant PVC construction
- Easy hookup of indoor alarm with terminal strip exposed for low voltage wiring
- Rated for NEMA 4X
- Water-tight rubber cord seal for pump and switch cables
- Optional indoor tank alert alarm with silence switch and LED indicator
- Installation and wiring instructions included
- Meets NEC requirements for a disconnect

See FM1420 for further information.

10-2616 Auto-Dialer System

The Auto-Dialer is a single channel voice dialer that can be used with any device that can provide a normally open / closed contact. It can be programmed to store up to four contact numbers, including standard (voice) telephones, most cell phones, and pagers. It will provide a 16 second pre-recorded message.



SPECIFICATIONS:

- Voice-Chip technology (NO TAPES)
- Record your own personal messages
- Dials each contact number up to four times
- Internal 9V battery back-up (battery NOT Included)
- Tone or pulse dial only (NOT intended for digital phone lines)

Products may not be exactly as pictured.

Flood Alert®

10-0763 High Water Alarm

SPECIFICATIONS:

- Operates on (3) AAA batteries
- Low battery alarm
- Warns you when sensor contacts water
- Loud intermittent horn rated at 103 +/- 3 db at 1' (30 cm)
- On/Off silence switch
- Stainless steel sensor contacts
- Easy to install, portable and safe!
- Compact design (3-1/4" x 2-1/4" [8.3x5.7 cm])
- No adjustments needed
- Solid state electronic components
- 5' (1.5 m) of lead wire
- 12-month limited warranty
- AC power adapter capability. Requires Class 2 transformer, Input: 120 VAC/60 Hz, output: 4.5 VDC/150 mA, tip positive, type B plug. (Not included, but available at most electronics stores)

Flexible sensor wire allows this alert to be used in many applications. Alerts you of overflowing:

- Sump pump • Toilets • Broken pipes
- Dishwashers or washing machines • Laundry sinks
- Air conditioning pans • Bath tubs or hot tubs



APak[®] Alarm Systems

The all new APak[®] alarm is more compact and easier to install. It is CSA approved in a NEMA 1 enclosure. Battery life is over 1 year from 2 AA batteries. Alarm may be used as AC only, DC only, or AC/DC applications. The APak[®] alarm system sounds a horn when a potentially threatening liquid level condition occurs. The horn can be silenced, but the alarm light remains on until the condition is remedied.

A green "POWER ON" light indicates 120 V primary power to the alarm. A low battery chirp feature indicates when the battery should be replaced. A red "ALARM" light indicates a high-level condition.

NOTE: It is always recommended to power the alarm from a separate circuit than the pump to avoid losing power to both during a tripped breaker scenario.



10-4012

SPECIFICATIONS:

- NEMA 1 enclosure (INDOOR USE ONLY)
- Automatic alarm reset
- Horn is rated 87 decibels at 10' (3 m)
- 2 AA battery back-up (battery not included)
- 15' (5 m) alarm (12 V) tethered switch
- 6' (2 m) power cord
- Auxiliary dry contacts (use 10-4014)



10-4011

SPECIFICATIONS:

Same standard features of our 10-4012 with:

- 15' (5 m) alarm reed switch
- Auxiliary dry contacts (use 10-4013)

Z Control[®] Enabled Models 10-4013 and 10-4014

SPECIFICATIONS:

- 10-4013 comes with reed sensor
- 10-4014 comes with mechanical float switch
- All the Standard features plus:
- 2nd Input for additional monitoring ability
- Dry contacts for connection to home security system, etc.
- Z Control Enabled
 - Wi-Fi[®] equipped
 - Receive free text, email, and push alerts on:
 - Power outage
 - Low battery
 - Input 1 or 2 triggers
 - Loss of contact with Z Control[®]
 - Remotely Silence, Reset alarm.
 - Free Z Control App and Web interfaces
 - Free Z Control account
 - No monthly cost
 - Simple setup
 - Z Control connectivity LED



10-0623 Indoor/Outdoor

SPECIFICATIONS:

- NEMA 3R enclosure (6.5"x4.5"x3") (16.5x11.4x7.6 cm)
- Top-mounted alarm beacon
- Automatic alarm reset, horn silence switch and alarm test switch
- Horn is rated 85 decibels at 10' (3 m)
- Pre-mounted terminal block with connections for pump and float switch
- 15' (5 m) alarm (12 V) tethered switch
- Power connections are field-wired



NOTE: All variable level float switches in this section are mechanically activated and do not contain mercury.

10-0682 Deluxe

SPECIFICATIONS:

Same standard features of our 10-0623 with:

- 20' (6 m) alarm (12 V) tethered switch
- 6' (2 m), 115 V power cord with water-tight cord connectors

10-0126 Indoor/Outdoor

SPECIFICATIONS:

Same standard features of our 10-0623 with:

- NEMA 4X thermoplastic enclosure (6"x4"x3") (15.2x10.2x7.6 cm)
- Horn is rated 88 decibels at 10' (3 m)
- 5A auxiliary dry contacts



Electrical Alternator Control Panel

For Duplex Installations

An Electrical Alternator is used on a Duplex pump application where automatic alternation of the pumps is desired for added protection in residential or commercial applications. With one pump operating to handle normal flow, a second pump becomes operational in the event the water level continues to rise. The built-in alarm system, a standard feature, can be connected to sound either when the second pump becomes operational with a 3-float switch system or independently with a 4-float switch system. All electrical systems must be installed by a qualified electrician and according to the National Electrical Code. (see Section 430-71 through 430-113, plus any others that apply).

SPECIFICATIONS:

- Hand-off-auto toggle switch for each pump
- Green pump run pilot light for each pump
- Alarm test and silence switches
- Red pilot light (NEMA1 only) and audible alarm with 83 to 85 decibel rating for a high-water condition
- Red alarm beacon included with NEMA 4x enclosure
- Auxiliary dry contact
- High water alarm
- Single phase - circuit breaker for each pump
- Three phase - motor protective switch with overload protection
- Magnetic starter for each pump
- Alternating mechanism
- Numbered terminal strip for connecting pumps and variable level float switches
- NEMA 1 - general purpose or NEMA 4x - watertight enclosures available
- Integral auxiliary terminal board connections (dry contact) for remote alarm devices
- 3 or 4 variable level float switch control operation
- Three 20' (6 m) float switches included with single phase panels
- Off-the-shelf components provide easy field maintenance and repair
- Float switches not included with three phase panels



Electrical Alternator Control Panel

CONTROL PANELS USED WITH SINGLE PHASE PUMPS			
NEMA 1 ENCLOSURE WITH 20' (6 m) FLOAT SWITCH			
Order No.	Dimensions HxWxD in (cm)	Volts	Amp Range
10-1039	12"x10"x6" (30x25x15 cm)	115	7-15
10-1040	12"x10"x6" (30x25x15 cm)	115	15-20
10-0092*	12"x10"x6" (30x25x15 cm)	115/200/230	0-20
NEMA 4X ENCLOSURE WITH 20' (6 m) FLOAT SWITCH			
10-1041	12"x10"x6" (30x25x15 cm)	115	7-15
10-1042	12"x10"x6" (30x25x15 cm)	115	15-20
10-1043	12"x10"x6" (30x25x15 cm)	115/200/230	0-7
10-1044	12"x10"x6" (30x25x15 cm)	115/200/230	7-15
10-1045	12"x10"x6" (30x25x15 cm)	115/200/230	15-20
10-1046	12"x10"x6" (30x25x15 cm)	115/200/230	20-30
10-0093*	12"x10"x6" (30x25x15 cm)	115/200/230	0-20

*Branch circuit protection provided by installing electrician.

CONTROL PANELS USED WITH THREE PHASE PUMPS			
NEMA 4X ENCLOSURE (Float Switches not included)			
Order No.	Dimensions HxWxD in (cm)	Volts*	Amp Range
10-1102	14"x12"x6" (36x30x15 cm)	200/230/460	1.0-1.6
10-1104	14"x12"x6" (36x30x15 cm)	200/230/460	1.6-2.5
10-1106	14"x12"x6" (36x30x15 cm)	200/230/460	2.5-4.0
10-1108	14"x12"x6" (36x30x15 cm)	200/230/460	4.0-6.3
10-1110	14"x12"x6" (36x30x15 cm)	200/230/460	6.3-10.0
10-1111	14"x12"x6" (36x30x15 cm)	200/230/460	9.0-14.0
10-1112	14"x12"x6" (36x30x15 cm)	200/230/460	13.0-18.0
10-1114	14"x12"x6" (36x30x15 cm)	200/230/460	17.0-23.0
10-1115	14"x12"x6" (36x30x15 cm)	200/230/460	20.0-25.0
10-1183	14"x12"x6" (36x30x15 cm)	200/208	23.0-32.0
10-1154	14"x12"x6" (36x30x15 cm)	575	1.6-2.5
10-1156	14"x12"x6" (36x30x15 cm)	575	2.5-4.0
10-1158	14"x12"x6" (36x30x15 cm)	575	4.0-6.3

*Three phase panel has multi-tap transformer with secondary fusing.

NOTE: All variable level float switches in this section are mechanically activated and do not contain mercury.

NOTE: 600 and X600 Series single phase pumps require special panels that include start components. See Selection Guide FM1228 and FM1705 for correct panel selection.

Electrical Simplex Control Panels

An Electrical Control Panel is used on a Simplex pump application where automatic electrical cycling of the pump is desired for added protection in residential or commercial applications. A Control Panel is required for all systems using a nonautomatic pump. The built-in alarm system, a standard feature, will activate when the water level becomes unusually high. All electrical systems must be installed by a qualified electrician and according to the National Electrical Code (see Section 430-71 through 430-113, plus any others that apply).

Single Phase Control Panel

SPECIFICATIONS:

- 115-208-230 Volts
- Dead front panel
- Complete with (3) 20' (6 m) control float switches
- Clear inner door (10-0125 only)
- Equipment disconnect (10-0125 only)
- Motor contactor (all models except 10-1019 and 10-1023)
- NEMA 4X watertight enclosure with lockable latch
- Top-mounted alarm light
- Alarm horn provides audio warning of alarm condition (83 to 85 decibel rating)
- Pump run indicator light
- Horn silence and alarm test toggle switches
- HOA switch
- Dry auxiliary contact (not available in plug-in panels)



Plug-in Control Panel Single Phase

SPECIFICATIONS:

- 115V (10-1019) or 230V (10-1023)
- NEMA 4X enclosure with hinged cover
- Receptacle for use with piggyback pump switch
- Alarm horn (83 to 85 decibel rating)
- Terminal strip
- Horn silence switch to turn alarm on or off
- Alarm float only



Three Phase

SPECIFICATIONS:

- 208-230-460-575 Volts
- NEMA 4X - watertight enclosure with lockable latch
- Hand-off-auto toggle switch
- Green pump run light
- Alarm test & silence switches
- Red alarm beacon and audible alarm for a high water condition (83 to 85 decibel rating)
- Motor protection switch with overload protection
- Magnetic starter
- Numbered terminal strip for connecting pumps and variable level float switches
- Dry auxiliary contacts for remote alarm devices
- Three float operation (floats not included - see FM0526)
- Off-the-shelf components provide easy field maintenance and repair

THREE PHASE SIMPLEX PUMP CONTROL PANELS			
Model	Dimensions HxWxD in (cm)	Volts	Amp Range
10-1074	12"x10"x6" (30x25x15 cm)	208/230/460	1.0 - 1.6
10-1076	12"x10"x6" (30x25x15 cm)	208/230/460	1.6 - 2.5
10-1078	12"x10"x6" (30x25x15 cm)	208/230/460	2.5 - 4.0
10-1080	12"x10"x6" (30x25x15 cm)	208/230/460	4.0 - 6.3
10-1082	12"x10"x6" (30x25x15 cm)	208/230/460	6.0 - 10.0
10-1083	12"x10"x6" (30x25x15 cm)	208/230/460	9.0 - 14.0
10-1084	12"x10"x6" (30x25x15 cm)	208/230/460	13.0 - 18.0
10-1086	12"x10"x6" (30x25x15 cm)	208/230/460	17.0 - 23.0
10-1132	12"x10"x6" (30x25x15 cm)	575	1.6 - 2.5
10-1134	12"x10"x6" (30x25x15 cm)	575	2.5 - 4.0
10-1136	12"x10"x6" (30x25x15 cm)	575	4.0 - 6.3

SINGLE PHASE SIMPLEX PUMP CONTROL/ALARM SYSTEM					
Model #	Volts	Dimensions HxWxD in (cm)	Amp Range	Float switches included	Features
10-1019	115V	8"x6"x4" (20x15x10 cm)	0-15	Alarm float only	Plug-In
10-1023	230V	8"x6"x4" (20x15x10 cm)	0-15	Alarm float only	Plug-In
10-1036	115V, 208-230V	8"x6"x4" (20x15x10 cm)	0-7	Three 20' (6 m) control floats	Circuit breaker disconnect
10-1037	115V, 208-230V	8"x6"x4" (20x15x10 cm)	7-15	Three 20' (6 m) control floats	Circuit breaker disconnect
10-1038	115V, 208-230V	8"x6"x4" (20x15x10 cm)	15-20	Three 20' (6 m) control floats	Circuit breaker disconnect
10-0125*	115V, 208-230V	10"x8"x4" (25x20x10 cm)	0-20	Three 20' (6 m) control floats	Equipment disconnect

* 10-0125 Branch Circuit Protection provided by the installing electrician.

Control Panels for Explosion Proof Pumps

Simplex and Duplex with Intrinsically-Safe Relays

These intrinsically-safe control panels are used on pump applications defined as a hazardous duty location. Lift stations in some regions fall under this classification. The intrinsically-safe panel, in conjunction with an explosion-proof pump, will provide a system that will not allow ignition of explosive gases. The purpose of the control panel is to cycle a pump automatically. Each panel comes standard with pump run light(s), a high water audible and visual alarm, seal fail indicator(s), and a UL Listing. All panels come standard with a NEMA 4X rating for indoor or outdoor use.



These panels MUST NOT be in the space classified as needing explosion-proof equipment. Special fittings that either prevent the passage of hot gases, in the case of an explosion in a Class I area, or the passage of combustible dust, fibers, or flyings in a Class II or III area (NEC 501-5 and 502-5) are required. A qualified electrician must install all electrical systems. National Electrical Code (NEC) Articles 500 through 503 explain in detail the requirements for the installation of wiring or electrical equipment in hazardous locations. These articles, along with other applicable regulations, local governing inspection authorities, insurance representatives, and qualified engineering/technical assistance, should be your guides to the installation of wiring or electrical equipment in any hazardous or potentially hazardous location.

SPECIFICATIONS:

- Intrinsically-safe relays
- NEMA 4X enclosure
- Top-mounted alarm light
- Hands-off-auto toggle switch for each pump
- UL Listed
- Alarm horn with silence switch
- Magnetic motor contactor
- Lockable Latch
- Auxiliary dry contact/high water alarm
- Circuit breaker pump disconnect
- 3 or 4 variable float switch control operation
- Off-the-shelf components provide for relatively easy field maintenance and repair
- Green pump run pilot light for each pump
- Seal fail indicator light(s)
- Thermal cutouts for 3 phase
- Duplex only - lead/lag alternating circuit



Tested to UL Standard UL 508

STANDARD ENCLOSURE DIMENSIONS		
Panel	Phase	Dimensions (HxWxD)
Simplex	1	16"x14"x6" (41x36x15 cm)
Duplex	1	16"x14"x6" (41x36x15 cm)
Simplex	3	16"x14"x6" (41x36x15 cm)
Duplex	3	16"x14"x6" (41x36x15 cm)

Products may not be exactly as pictured.

Nema-4X Junction-boxes

Economy Junction Box (Field Assembled)

PVC plastic box with removable cover for use in sewage, effluent, dewatering, or corrosive environments. Box is 4"x4"x2" (10x10x5 cm) and is field-drilled for maximum flexibility in each installation.



SPECIFICATIONS:

- 10-0770-Box includes 2 UF cord seals for 12 or 14 gage UF cable and 3 round cord seals for 16-3, 16-2, 18-3, or 18-2 SO type cords
- 10-0776-Box includes one 3/4" PVC conduit adapter and 3 round cord seals for 16-3, 16-2, 18-3, 18-2 SO type cords
- 10-0777-Box includes one 3/4" PVC conduit adapter and 4 round cords seals for 16-3, 16-2, 18-3, 18-2 SO type cords
- 10-0778-Box includes one 3/4" PVC conduit adapter and 5 round cord seals for 16-3, 16-2, 18-3, 18-2 SO type cords

Sewage/Waste Junction Boxes

NEMA-4X Junction Boxes are electrical enclosures that are watertight, dust-tight, and corrosion resistant. Boxes are completely assembled with cord seals and terminal strip for easy field wiring.

Pump Model	Type	LxWxH	Cord Grips	Part No.
611, 621, 631, 641, 651, 661 (under 20 Amps)	Simplex	6"x6"x 4-3/8"	1 each-Pump 3 each-Floats	10-0985
	Duplex	8"x8"x 4-1/2"	2 each-Pump 4 each-Floats	10-1015
651, 661 (20 Amps & up)	Simplex	6"x6"x 4-3/8"	1 each-Pump 3 each-Floats	10-0987
	Duplex	8"x8"x 4-1/2"	2 each-Pump 4 each-Floats	10-1016

Starter Kits

A Starter kit is required for all single phase model 611, 621, 631, 641, and 651 pumps. A Starter Kit consists of the single phase capacitors and relay required to run the pump. These components are shipped loose and are installed into the pump's control panel.

Starter Kit P/N	Pump Model
10-0914	611/621 (before 10/1/07)
10-2221	611/621 (after 10/1/07)
10-0915	631/641
10-1434	651

Nema-4X Junction-boxes

Deluxe Junction Box (Factory Assembled)

High-impact, corrosion-resistant, weatherproof thermoplastic enclosure with flexible PVC gasket and brass screws. Preassembled at the factory for convenience and ease of installation.



DELUXE (Factory Assembled) Pump Model	Type	LxWxH	Hub Size	Cord Grips	Part No.
51, 53, 55, 57, 59, 98, 137, 139, 140, 142, 151,152, 153, 161 (except 115 V), 163 (except 115 V), 165, 185, 186 (3 phase), 188 (3 phase), 189 (460 & 575V), 264, 266, 267, 268, 270, 282, 284, 293, 294 (3 phase), 295 (460V & 575V only), 404 (230/460/575V 3 phase), 405 (230/460/575V 3 phase) and all effluent STEP Systems.	Simplex	4" x 4" x 4"	3/4"	4 small & 1 plug	10-1398
	Simplex	4" x 4" x 4"	1-1/2"	4 small & 1 plug	10-1399
	Simplex	6" x 6" x 4"	1-1/2"	4 small & 1 plug	10-1402
	Simplex/ Duplex	6" x 6" x 4"	1"	5 small & 1 plug	10-1401
	Duplex	6" x 6" x 4"	1"	6 small & 1 plug	10-1633
	Duplex	6" x 6" x 4"	2"	5 small & 1 plug	10-1403
161 (115 V), 163 (115 V), 186 (single phase), 188 (single phase), 189 (200 & 230 V), 191, 292, 294 (single phase), 295 (200 & 230 V), 404 (single phase & 200 V 3 phase), 405 (single phase & 200 V 3 phase).	Simplex	6" x 6" x 4"	1-1/2"	3 small, 1 large & 1 plug	10-1404
	Duplex	6" x 6" x 4"	2"	4 small, 2 large & 1 plug	10-1405

Note: Small cord grips are for 16 ga. and 18 ga. cable.
Large cord grips are for 12 ga. 4 conductor cable and 14 ga. 4 conductor cable.

Disconnect & Rail Systems

Z-Rail® Threaded Rail Systems 1-1/4" - 3" NPT Discharge Pumps

SPECIFICATIONS:

- Sewage, storm water, effluent and grinder pump systems
- For use in concrete, steel, or fiberglass tanks
- Allows for removal of pumps from ground level
- No confined space entry to service pump
- No pull rods or hold down rods
- Disconnect fitting with positive machine fit and o-ring provides a reliable seal
- Seals up to 370' TDH (160 psi) and supports a weight up to 300 lbs.
- Guide rails direct the pump to and from the disconnect fitting. Systems are supplied complete with disconnect fitting, guide plate, rail guide, and upper rail support bracket
- All systems use 3/4" schedule 40 pipe rails (not included)



2" Z-Rail® unit shown.

3" & 4" Flanged Rail Systems Horizontal Discharge

SPECIFICATIONS:

- For 600 and X600 Series solids-handling pumps
- For basins of any depth
- Cast iron construction with stainless steel hardware
- Easy engagement and disengagement of pump from ground level.
- Suitable for most horizontal discharge pumps having a 3" or 4" ANSI flange.
- Seals up to 100' TDH (43.9 psi) and supports a weight up to 500 lbs.
- Includes base elbow, pump adaptor plate, sealing gasket, rail guide and upper rail support.
- All systems use 2" schedule 40 rail pipes (not included)



4" Non-sparking unit shown.

Disconnect Only 1-1/4" - 2" Discharge



SPECIFICATIONS:

- Economical, reduces time and cost of removing pump
- Safety: keeps personnel out of pits & out of contact with contaminants
- Used for shallow systems where guide rails are not necessary (pull rod not included)

Square Guide Rail Systems 1-1/4" - 2" NPT Vertical Discharge

SPECIFICATIONS:

- Economical rail system for shallow depth basin packages
- Single, rigid stainless steel square rail design
- Cast iron pump and support plates
- Stainless steel rail, nuts, bolts, fasteners and lifting bail
- Cast iron angle arm bracket and pump guide bracket
- Galvanized piping is standard. Stainless steel piping is optional
- Red brass disconnect fittings with Teflon-coated Buna O-ring seal
- PVC ball valve and cast iron check valve



COMPANY

Zoeller Family of Water Solutions™

ABOUT THE ZOELLER FAMILY OF WATER SOLUTIONS

Founded in 1939, Zoeller Company is one of the oldest independently-owned professional pump manufacturers in North America. Headquartered in Louisville, Kentucky USA, Zoeller has over 800 employees worldwide and close to 600,000 sq. ft. of manufacturing facilities in our seven operations in North America and Asia.

Zoeller Company has established itself as an innovative leader in pumping equipment and water treatment systems by continuous research and development. The quality of our products is demonstrated by UL, CSA, CE, and NSF listings as well as continued growth throughout the United States, Canada, Mexico, and over 40 other countries around the globe. The company has also expanded to include five brands, which have become the foundation of Zoeller.



The original Zoeller product line now resides in Zoeller Pump Company, which offers a broad range of submersible pumps from fractional to 7-1/2 HP for residential and commercial sump, effluent, dewatering and grinding applications.



Flint & Walling, founded in 1866 in Kendallville, Indiana USA, specializes in 4" submersible well pumps ranging from 5 GPM to 1,000 GPM, as well as centrifugal, jet and booster pumps up to 7-1/2 HP. It is the only pump company in the U. S. to manufacture its own motors for jet pumps, centrifugal pumps and 4" submersible well pumps.



Founded in 1952, Wolf Pump is a manufacturer of submersible turbine pumps located in Abernathy, Texas. Wolf currently produces 4" to 8" pumps with capacities ranging from 35 to 1000 GPM. These pumps are known for their efficiency and durability in demanding water applications including irrigation, municipal water supplies, dewatering applications, dairy production, mining, the oil and gas industries, aquaculture, and more.



Zoeller Engineered Products provides products for storm water removal, sewage pumping stations and hazardous environment applications for residential, commercial and municipal markets. Available from 1/2 BHP to 100 BHP, each pump is customized by design, manufacture and installation according to exact application needs.



Clarus Environmental offers sustainable environmental products, solutions, and services for the collection, treatment, and dispersal of residential and community wastewater. This line specializes in onsite pumps, pressure sewers, biological and mechanical treatment processes, disinfection, and discharge of safe water.

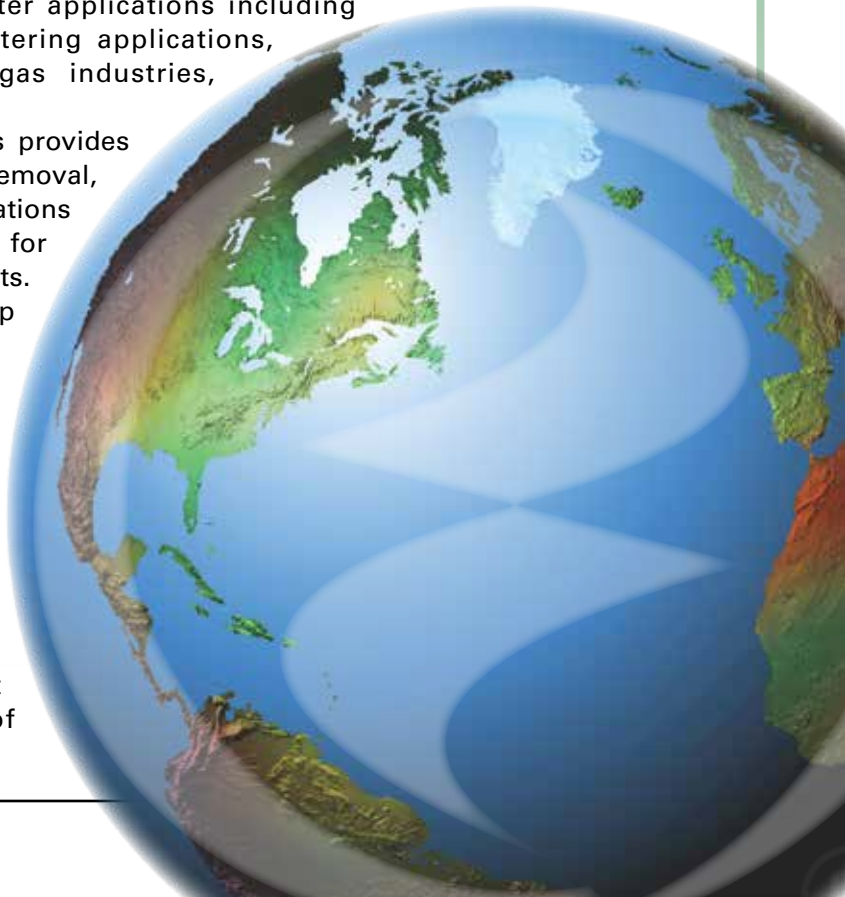

FM2819
1216
Supersedes
0314



PUMP COMPANY

Zoeller Family of Water Solutions™

3649 Cane Run Road • Louisville, KY 40211 • 502-778-2731 • 1-800-928-7867 • www.zoeller.com