



CONTROLS - USER GUIDE

IMPORTANT INFORMATION FOR THE INSTALLER
AND THE OWNER

INCLUDED : USING THE MIA® SERIES CONTROLS

TABLE OF CONTENTS

THE MIA® SERIES CONTROLS

INSTALLATION	4
USER GUIDE	5 - 15
MAINTENANCE	16 - 18
TROUBLESHOOTING	19 - 20
WARRANTY	21 - 22
DRILLING TEMPLATES	23 - 26

956, chemin Olivier
Saint-Nicolas (Québec)
G7A 2N1

T 418.831.7701

1.800.463.2187

F 418.831.6623

1.800.382.8587

info@bainultra.com



MIA® & MIAPLUS® CONTROLS

INSTALLATION

REQUIRED TOOLS

1	Fine teeth jigsaw
2	Drill
3	1/4 in. drill bit

LOCATION

Determine the most convenient location, on either the wall or the deck, to install the control module or consult the specifications sheet for the suggested location. To avoid drilling in an air intake zone or an electric component, always check under the deck before drilling. If you have to install the control to the wall, remove the protective film of sticker behind the control. You can add a silicone bead to secure it.

DRILLING

Refer to the drilling template **on the last page** for the location and diameter of the holes.

INSTALLING THE TOUCHPAD

1	Push wiring through drilled holes.
2	Remove protective film from watertight seal.
3	Secure touchpad into place on either the podium or the wall by using 2, 8-32 x 1" studs and 2 wing nuts.
4	Tighten sufficiently to insure seal is airtight.

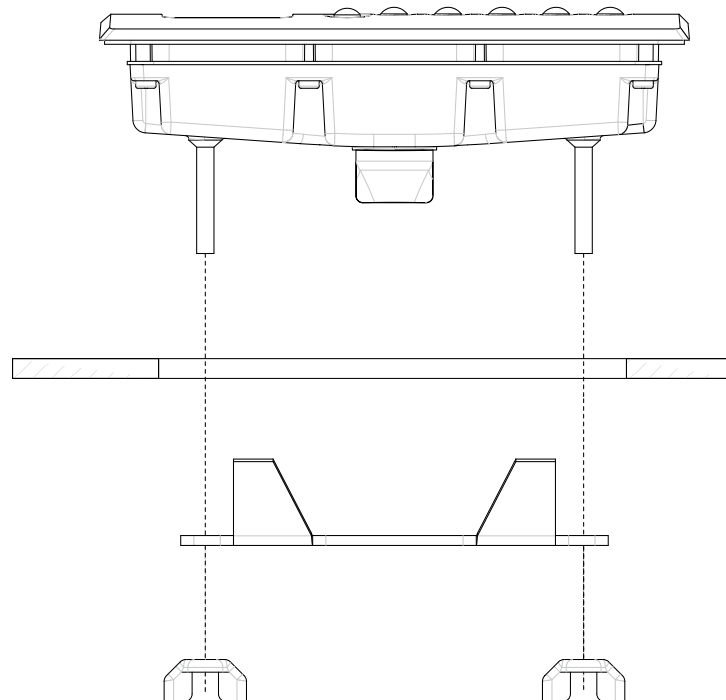
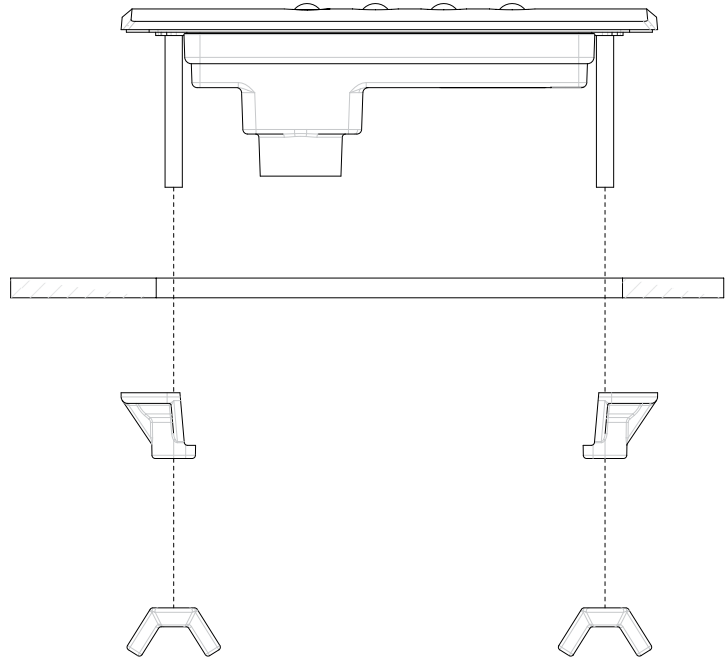

WARNING



- If control was not factory-installed, **it will be attached to the turbine.**

ON/OFF
On

Press the (on/off) key  to start or to stop the turbine and the Mia® control panel.

ADJUST AIR JET PRESSURE



Air jet pressure can be adjusted for maximum comfort and a remarkably effective massage. Default pressure is set to 60%.

Increase or decrease the pressure of the air jets by repeatedly pressing the  or  keys until the desired intensity is reached.

TO ACTIVATE THE DRYING CYCLE

This function completely drains the conduits and dries them for 90 seconds, regardless of whether or not the system was activated. By eliminating any water left in the conduits, the **Drying cycle** ensures perfect hygiene.

- No stagnant water
- No water left over from the previous bath

To activate the **Drying cycle**, press . The operation will cease after 90 seconds. If you do not activate the function, the drying process will begin automatically after 15 minutes. If the bath is used for soaking only, activate the drying cycle manually by pressing . You can use the **Drying cycle** function immediately after a Hydro-thermo massage™ session or whenever you wish.



The Mia® control panel comes standard with the following baths:

- Azur
- Basa™
- Thalassa

MAIN FUNCTIONS

- Increase or decrease air jet pressure
- Activate **Drying cycle** function

NOTE

- The heat for the heated backrest is controlled simultaneously with the intensity of the jet pressure.

MIAPLUS®

USER GUIDE

KEYS AND FUNCTIONS



Press this key to start or to stop the turbine and the MiaPlus® control panel.



Press this key to return to function adjustment. The **Massage** function appears on the screen by default.



Press either of these keys to navigate the main menu of the MiaPlus® control panel.

Press the ► key to see the next function.

Functions are displayed in the following order:

- **Massage** (air jet pressure)
- **Duration**
- **Chroma** (Chromatherapy option)
- **Backrest** (heated backrest)
- **Care**
- **Save**
- **Drying cycle**
- **Lock**
- **Contrast** (screen contrast)
- **Language**
- **Contact us**



Press either of these keys to navigate the options of each function.

Press the ▲ key to go up.

Press the ▼ key to go down.



Press this key to save the selected options and settings.



The Mia® control panel comes standard with the following lines of baths:

- **Meridian™**
- **Origami®**
- **Thermal**
- **Amma®**
- **TMU**
- **Elegancia™**

MAIN FUNCTIONS

MiaPlus® lets you personalize your Hydro-thermo massage™ with the following functions and options:

- Adjust air jet pressure
- Select duration of session
- Select light color (Chromatherapy option)
- Adjust backrest temperature
- Personalize session settings for up to 4 different users
- Personalize drying cycle for water jet conduits
- Lock controls when bath is not in use
- Adjust screen contrast
- Select display language

Settings are automatically saved until they are modified.

MASSAGE

This function allows the user to regulate air jet pressure for personalized comfort and a remarkably effective Hydro-thermo massage™. The default pressure is the same for the previous bath.

Increase or decrease the pressure of the air jets by repeatedly pressing the ▲ or ▼ key until the desired pressure is reached. Pressure increases in 10% increments.

Pressing **OK** is optional.

DURATION

This function lets you program the duration of your bath from 5 to 30 minutes. The selected duration will remain in the memory until it is modified.

To select the **Duration**, press the ► key on the menu until the **Duration** function is displayed.

Select the desired duration using the ▲ or ▼ keys.

Pressing **OK** is optional.

Use the arrows ◀ or ▶ or the 🏠 key to return to the basic **Massage** screen.

CHROMA (OPTION)

This function uses color to provide increased comfort to body and soul.

To use the **Chroma** function, press the ► key on the menu until the **Chroma** function appears on the screen.

- **To turn off the Chroma function,** select **Off**.

THE CHROMA FUNCTION FEATURES EIGHT OPTIONS

▪ Off	Deactivates the chromatherapy function.
▪ Violet	Immunizing and relaxing. Boosts the immune system, detoxifies the body, and reduces stress.
▪ Blue	Soothing and relaxing. Reduces arterial pressure and hyperactivity and soothes the soul.
▪ Green	Provides calm and balance. Relaxes entire body and stabilizes emotions.
▪ Yellow	Digestion and creativity. Helps digestion and regularity and calms brain activity.
▪ Orange	Healing and pain relief. Boosts respiratory system and soothes aching muscles.
▪ Red	Stimulating and exciting. Activates circulation and wakes up the senses.
▪ Scan	Goes through each color in turn.

NOTE

- Should you not see the colors on the screen, pressing ▼ the first time will start the color scan. Pressing a second time will freeze the lights on their color, and the third time will turn the lights off.

CHROMA (NEXT)

Choosing a color

Choose the desired color using the ▲ and ▼ keys.

Press **OK** to validate your choice of color.

Selecting Scan

Select the **Scan** option using the ▲ or ▼ keys.

Press **OK** to validate your choice.

Use the arrows ◀ or ▶ or the 🏠 key to return to the basic **Massage** screen.



BACKREST

For maximum relaxation and exceptional comfort, one or two heated backrests can be installed in your bath and heated individually.

Select the **Backrest** function by pressing the ▶ key until the **Backrest** function is displayed.

Four options are available:

- **Off**
- **Low**
- **Medium**
- **High**

NOTE: Models with 2 backrests will specify backrest 1 and backrest 2.

Choose the desired option using the ▲ or ▼ keys.

Press **OK** to validate your choice.

Use the arrows ◀ or ▶ or the 🏠 key to return to the basic **Massage** screen.

NOTE: Selecting the **Off** option will turn off the backrests.



CARE

This function lets you vary air jet intensity for a deeper or gentler massage.

To select the **Care** function, press the ► key on the menu until the **Care** function appears.

Six options are available:

- **Message** – Even intensity throughout the session
- **Wave** – Jet intensity cycles from 10% to maximum desired intensity
- **Bather 1, 2, 3, 4** – Stores each bather's selection

Use the ▼ or ▲ keys to select an option.

Press **OK** to validate your choice.

Use the arrows ◀ or ▶ or the 🏠 key to return to the basic **Message** screen.



SAVE

The MiaPlus® control system lets you save up to four personalized presets. This save function lets you conveniently preselect settings adapted to various users or purposes. Simply set the functions and options according to your tastes and save them under Bather 1, Bather 2, etc. These personalized settings will stay saved until modified.

Select a bather and save personalized settings

Press the ► key on the menu until the **Save** function appears.

Use the ▲ or ▼ keys to select a user number.

Press **OK**.

Use the arrows ◀ or ▶ or the 🏠 key to return to the basic **Message** screen.

Repeat these steps for each user.



DRYING CYCLE

This function completely drains the conduits and dries them for 90 seconds. By eliminating any water left in the conduits, the **Drying cycle** ensures perfect hygiene.

- No stagnant water
- No water left over from the previous bath

Drying is mandatory after a Hydro-thermo massage™ session.

Two options are available:

- **Daily**
- **After Bath**

Even when the daily drying cycle is programmed, the automatic drying cycle will activate after each use.

Select After Bath

The **After Bath** option lets you program the **Drying cycle** to start up to 60 minutes after a bath.

To select the **After Bath** option, press the ► key on the menu until the **Drying cycle** function appears.

Use the ▲ and ▼ keys to select the **After Bath** option.

Press **OK**.

Dry Delay is displayed.

Press the ▲ key to select a value from 5 to 60 minutes.

Press **OK** to validate.

Use the arrows ◀ or ▶ or the 🏠 key to return to the basic **Massage** screen.

If no value is selected, the **Drying cycle** will start up automatically 15 minutes after the bath.



DRYING CYCLE (NEXT)
Select Daily

The **Daily** option lets you dry and clean the air jet system conduits at a specific time of day rather than within an hour of a Hydro-thermo massage™ session.

To select the **Daily** option, press the ► key on the menu until the **Drying cycle** option appears.

Use the ▲ and ▼ keys to select the **Daily** option.

Press **OK**.

Start Time is displayed.

Use the ▲ or ▼ keys to select the time of day the **Drying cycle** function should start.

Press **OK**.

Current Time is displayed.

Press and hold the ▲ or ▼ keys or press them repeatedly to set the preprogrammed current time in 10 minute slots.

Press **OK**.

Once the **Daily** option is set, the **Drying cycle** will start every day at the same time until the setting is modified.

Use the arrows ◀ or ▶ or the 🏠 key to return to the basic **Massage** screen.

NOTE: The time format is preset as follows:

French: 24 hour

English: 12 hour (AM and PM)

Spanish: 24 hour



LOCK

This function lets you lock the control system in order to prevent the turbine from starting unexpectedly or accidentally.

It is also a child safety device, as it prevents children from starting the turbine by pressing the  key.

To **activate** the **Lock** function

Press the  key on the menu until the **Lock** function appears.

Use the  or  keys to select the **Activate** option.

Press **OK** to validate your choice.

When you stop the bath, the **Lock** function locks the  key, making it impossible to restart the turbine.

To restart the turbine when the Lock function is activated

Press the  key.

Lock is displayed. Press **OK**.

The turbine starts.

To **deactivate** the **Lock** function

Press the  key on the menu until the **Lock** function appears.

Use the  and  keys to select the **Off** option.

Press **OK**.



CONTRAST

This function controls the brightness of the MiaPlus® display screen. No matter which setting you select, the screen is always clear and easy to read from any angle, regardless of the lighting conditions of the room where your bath is installed.



CONTRAST (NEXT)

NOTE: The screen automatically dims after 2 minutes.

To set display screen contrast, press the ▲ or ▼ key on the menu until the **Contrast** function appears.

NOTE: Use the ◀ key to access this function more quickly when you start the turbine.

Press ▲ or ▼ until the desired percentage (%) of contrast is displayed.

Press **OK** to validate your choice.

Use the arrows ◀ or ▶ or the 🏠 key to return to the basic **Massage** screen.

LANGUAGE

The MiaPlus® control system lets you select one of the following three display languages:

- **French**
- **English**
- **Spanish**

NOTE: The factory-selected language is English.

To choose the display language, press the ▶ or ◀ key on the menu until the **Language** function appears.

NOTE: Use the ◀ key to access this function more quickly when you start the turbine.

Press ▲ or ▼ to select your desired language.

Press **OK**.

Use the arrows ◀ or ▶ or the 🏠 key to return to the basic **Massage** screen.



CONTACT US

Feel free to contact Bain Ultra for any information you may need about your Thermomasseur® bath and the MiaPlus® control system.

Simply call the telephone number that appears on this screen for answers to any question.

1.800.463.2187

BainUltra® wishes you complete relaxation!

MIAMULTI®





USER GUIDE

MIAMULTI®

The MiaMulti® control features the **same functions as the MiaPlus®**, but also comes with a convenient and easy-to-use remote control. You enjoy all the benefits of a personalized Hydro-thermo massage™ without having to leave the bath. Just lie back and relax!



REMOTE - HYDRO-THERMO MASSAGE™

1.	Key  Operates the remote
2.	Backrest 1 + key Increases the temperature of backrest 1
3.	Backrest 1 – key Decreases the temperature of backrest 1
4.	Backrest 2 + key Increases the temperature of backrest 2
5.	Backrest 2 – key Decreases the temperature of backrest 2
6.	Blower + key  Increases air jet pressure
7.	Blower – key  Decreases air jet pressure
8.	Duration key  Selects bath duration. Press the key to increase bath duration. Each time you press the key, your bath time increases 5 minutes, to the nearest round number.
9.	Chroma key  Selects the chromatherapy function. To change the color, press the key until the desired color is displayed.

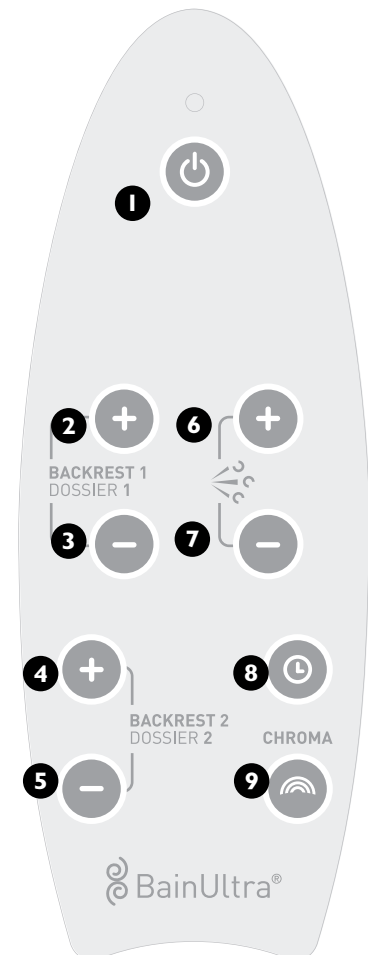

NOTE: To work efficiently, the remote must be pointed toward the MiaMulti® wall-mounted control in the room where your bath is.

**PROGRAMMING PROCEDURE
FOR REMOTE CONTROLLER 2010 AND UP**

PROGRAMMING MIAMULTI® - BATH

Press key **REWIND** and keep it pushed. **BACKREST 2 DOSSIER 2**

Press key **POWER** and keep both keys pushed for 2 seconds.

Once red light is switched on, release both keys.

Immediately press keys sequence:

BACKREST 1 DOSSIER 1 **BACKREST 1 DOSSIER 1**

Red light will switch off at every key.

Once sequence is terminated, red light will stay switch off.



NOTE: To work efficiently, the remote must be pointed toward the MiaMulti® wall-mounted control in the room where your bath is.

MAINTENANCE

ACRYLIC

Technical information

- All BainUltra® ThermoMasseurs® are made of Lucite acrylic.

Maintenance

- Clean acrylic with a mild non-abrasive product.
- Abrasive products such as powder, paint thinners, turpentine and gas can damage the shine and lustre of the acrylic.
- For particularly tough stains, use a small amount of wood alcohol (methyl hydrate).

Safety instructions

- When applying wood alcohol (methyl hydrate), use gloves to protect hands. Rinse thoroughly after use.
- Ensure that essential oils or other therapeutic products added to bath water will not damage the acrylic finish.

ACRYLIC (MINOR REPAIRS)

Maintenance

- For minor surface damage, use a polishing putty for acrylic surfaces or automobiles.

Safety instructions

- Follow polish manufacturers' instructions.

The BainUltra® ThermoMasseur® is as simple to care for as a conventional acrylic bath. There are no pumps, valves, pipes, nor accessories to take apart or clean. Thanks to its design, the system is perfectly hygienic and completely dry. The automatic and programmable drying cycles completely empty the air channel. No standing water. Nothing left over from the previous bath. The user does not have to worry about the air channels nor the turbine. Simply clean the surface of the bath with a non-abrasive cleanser.





	Scratch
	Paper grade 220
	Paper grade 400
	Paper grade 600
	Paper grade 800
	Paper grade 1200
	Polish

Table - Sandpaper grade

IMPORTANT

- Any product added to your ThermoMasseur® must be dissolved in the water or if not, be mixed with an emulsifier (see the Therapy Guide for more details) in order to ensure the longevity of your bath's acrylic as well as the efficiency of its system, along with the exceptional quality of care offered by your BainUltra® bath.

ACRYLIC (DEEPER SCRATCHES)
Maintenance

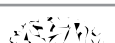
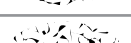
- For slightly deeper scratches, sand the spot with a wet sandpaper before polishing.
- Depth of abrasion or scratch will determine grade of sandpaper required:
 - Slight to moderate damage — grade 600, 800, then 1200 sandpaper
 - Deeper damage — grade 400, 600, 800, then 1200 sandpaper
- When sanding, start with lowest grade sandpaper (e.g. 400), working your way up as you sand a slightly larger area with each new grade. Finish with polishing putty.

ACRYSTAL™ MyBODYREST™ COMPONENTS (FOR TEKURA™)
Maintenance

- The Acrystal™ MyBodyRest™ kit requires the same easy maintenance as our other acrylic (standard) parts (See page 76)
- Clean Acrystal™ components using a mild, non abrasive cleaning product, such as those used for glass and mirrors, and a soft cloth.

SYSTEM
Technical information

- An automatic drying cycle starts 10 minutes after each use ensuring the dryness of the channel.
- It is normal to hear the turbine working at a certain time of day. This means that the drying cycle has been programmed.

Maintenance

- **BainUltra® recommends to start the system once every 90 days.**
- BainUltra® recommends to start the drying cycle everytime the bath is used as a shower or just to soak.

WOOD MyBODYREST™ COMPONENTS (FOR TEKURA™)
Maintenance

- Components should be cleaned with a damp cloth or with a very mild soap, if required. Avoid any harsh cleaning products. Simply sponge off any film or residues that are left on the wood after use.

CEDAR WOOD (TMU 5454/6060)
Technical information

- The cedar wood components (step and/or shelf) are protected by a highly durable and resilient coat of catalyzed polyurethane.
- This protective coating is designed for a high humidity environment and ensures a long-lasting, stain and water resistant finish.

CEDAR WOOD (TMU 5454/6060) NEXT
Maintenance

- To protect the wood finish, do not leave any soaps or detergents on wood surfaces for long periods of time.
- Clean the wood with mild soap and a cotton cloth. Do not use abrasive or corrosive products.

LYPTUS WOOD (AYOURA®)
Technical information

- The Ayoura® freestanding model has a lip made of Lyptus wood treated with polyurethane oil.
- Lyptus wood is known for its resistance to moisture and mildew.

Maintenance

- Use polyurethane oil or another natural oil (e.g., Watco, Varathane) available in a hardware store.
- Apply with a rag.
- Buff 3 to 4 times per year.

MASSAGE TABLE
Technical information

- The massage table is covered in Whisper™ vinyl. Its structure is wood and the supports are polyurethane.

Maintenance

- Clean table (vinyl, wood, and urethane) with a cloth, warm water, and some dish soap. Rinse with a clean, moist cloth.
- Clean polyurethane blocks that come into contact with the bath to prevent scratching bath with sand, dust, or other abrasive particles.
- A storage space of at least 45" x 40" x 16" (115 cm x 102 cm x 41 cm) is required for the table.

TROUBLESHOOTING

Your BainUltra® ThermoMasseur® has been manufactured and inspected with the greatest care. In addition, it has been thoroughly tested on a test bench to offer you a product of superior quality satisfying your highest expectations. The following troubleshooting chart will assist you in correcting a problem. If you continue to have problems, contact your retailer or the manufacturer.

SITUATION	SOLUTIONS
Your bath will not start.	<ul style="list-style-type: none"> ▪ Make sure breaker is "ON." ▪ Shut off and restart breaker. ▪ Check junction box connections to bath (for Canada only).
Breaker trips continually.	<ul style="list-style-type: none"> ▪ Make sure that your bath is the only appliance connected to circuit. ▪ Check for a short circuit between bath and breaker box. ▪ Breaker may too sensitive, defective or old. Try a new breaker. This component must be new.
Turbine stops working after only a few minutes.	<p>Turbine and air-heater are equipped with heat sensors designed to cut off power in case of overheating. Insufficient air circulation may be the cause.</p> <ul style="list-style-type: none"> ▪ Make sure turbine has sufficient ventilation. ▪ Make sure turbine intake is not obstructed.
A few airjets do not work at lowest speeds.	<p>To meet everyone's needs, particularly those of children, your bath is designed to work at a very low speed. Air jets in half-seat or those closest to drain in TMU models, especially larger models, may remain inactive at lowest speeds. This is normal and can be easily remedied by slowly raising speed to "open" inactive air jets and then lowering it to desired level. Furthermore, your bath is pre-programmed in the factory at a low, regular or high intensity depending on the size. To change the intensity level, please contact BainUltra® directly. Certain conditions may amplify this occurrence.</p> <ul style="list-style-type: none"> ▪ Check for turbine intake obstruction, too great a distance between turbine and bath, too many directional changes (elbows), and, if adequate piping has been used. See TURBINE RELOCATION paragraph.

SITUATION	SOLUTIONS
<p>Air jets seem cool.</p>	<p>Temperature of air injected into bath is directly proportional to the speed of the turbine. The higher the speed, the warmer the air is. A simple way to check if your air-heater or heaters are working properly is to turn on the system at the highest speed (if your control offers a range of intensities) with no water in the bath (there is absolutely no risk to the system). After 3 to 5 minutes, the heated backrest or backrests should be warm to the touch and jets should also seem warm when you bring your hands close to them.</p> <ul style="list-style-type: none"> ▪ Check the turbine air intake. It should not be too cold nor too warm. Ideally, the temperature should be between 72°F (20°C) and 86°F (30°C). ▪ Check that distance between turbine and bath is not too great. If possible, insulate air line along its entire length. See turbine installation section of this manual.
<p>LED does not work.</p>	<p>An LED has a 100 000-hour lifecycle.</p> <ul style="list-style-type: none"> ▪ Verify wiring and connections. <p>IMPORTANT: THESE INSTRUCTIONS ONLY APPLY IF THE LED CAN BE ACCESSED FROM BATH EXTERIOR.</p> <ul style="list-style-type: none"> ▪ Upon verification, if LED still does not work, disconnect and replace the LED by doing the following: <ul style="list-style-type: none"> - Remove the LED module by pulling on the white part of the plug. If the module is difficult to remove, use a pair of vice-grips. - Detach the wire from the bath. - Unplug the wire from the chromatherapy control module. - Plug the wire into the chromatherapy control module. - Plug the LED module back into its socket. <p>NOTE: IT IS NOT NECESSARY TO REATTACH THE WIRE TO THE BATH.</p>

THE BAINULTRA® LIMITED WARRANTY

LIMITED WARRANTY

This limited warranty is extended only to the original purchaser of the unit under warranty and is valid only when bought through and registered by an authorized BainUltra® retailer. BainUltra® products are designed for residential use only. BainUltra® products used for commercial or display applications will be limited to a two-(2) year warranty against defaults in materials and workmanship regardless of the various defective components of the products. BainUltra® products sold outside of North America will be limited to a parts-only warranty through the dealer of the sale. Our service department will help diagnose the problem and will provide parts only for repairs or replacements covered by the warranty. All parts will be shipped to the dealer in North America. BainUltra® will not be responsible for cost of shipping or servicing outside of North America.

Your BainUltra® ThermoMasseur® or soaking bath is covered by the best warranty in the industry. BainUltra Inc. guarantees the acrylic and motor turbine of your bath for a twenty-(20) year period from the original purchase date against defects in materials and workmanship. In the case of the electronic components of the ThermoMasseur®, the Vedana® or the Temazkal® and the massage table for the Ayoura®, BainUltra Inc. guarantees against defects in materials and workmanship for a five-(5) year period from the original purchase date.

For wooden parts of certain models and for MyBodyRest™ kit, BainUltra Inc. guarantees that in their original manufacturing form, these parts are free of any manufacturing, dimensional or strongly apparent natural defects for a one-(1) year period from the original purchase date.

EXCLUSIONS

The above-stated limited warranty applies as long as damage is not caused by an accident, abuse, misuse, fire, insects, use of abrasive products, force majeure or an act of God. Transport, handling or installation damages are also excluded. Any part that must be changed during the warranty period will be covered by the original warranty or for a two-(2) year period following replacement, according to the first contingency.

Because of their organic nature, wood components will expand and contract with seasonal changes and normal heating variations. With time, normal exposure to sunlight will slightly alter the wood tint. These changes are not covered by the warranty. The vinyl surface and the sheet of Ayoura's optional massage table are not covered by this warranty.

Moreover, this warranty is void if your BainUltra® ThermoMasseur® bath, your Vedana® or your Temazkal®, or any other BainUltra® product is installed by anyone but a licensed contractor.

This warranty is also void if your BainUltra® bath, your Vedana®, your Temazkal®, or any other BainUltra® product or part thereof has been modified or if any repairs have been attempted by anyone other than BainUltra Inc., an authorized dealer or representative of BainUltra Inc. Any and all components that are not provided by BainUltra Inc., as well as any items attached or installed on your BainUltra® ThermoMasseur®, your Vedana® or your Temazkal®, or on any other BainUltra® product after the date of manufacture are expressly excluded from this limited warranty.

The warranty is void if the unit is installed outdoors, or has not been installed in accordance with the manufacturer's instructions and/or in compliance with local codes and ordinances.

PROCEDURE

Any defect involving the manufacturer's liability shall be reported to BainUltra Inc. within ten (10) days of its occurrence. Units claimed to be defective shall be held until inspected by an authorized representative of BainUltra Inc., and upon their specific instructions, units found to be defective will be repaired or replaced at BainUltra Inc.'s choice. The liability of BainUltra Inc. with respect to the sale of this unit shall be limited to repair or replacement by a similar product as provided above and does not include any cost of removal, reinstallation, transport of defective product, loss of time, salary or any other expenses as well as any consequential damages of any kind. BainUltra Inc. and its representatives shall not be held liable for any injury, loss, cost or other damage, whether consequential or incidental, that arise from any defect covered under this limited warranty, even if BainUltra Inc. has been advised of the possibility of such damage. An adequate access way to mechanical and electrical parts of your BainUltra® ThermoMasseur® bath, your Temazkal®, or any other BainUltra® product must be anticipated and prepared before an authorized representative arrives on the premises to carry out a repair. The costs incurred to provide access to the motor turbine, the electronic module or the heating system will not be covered by this warranty.

LIMITATIONS

This limited warranty replaces all other warranties, expressed or implied, in face or at law, including implied warranties of merchantability and fitness for a particular purpose. The terms of this limited warranty cannot be modified or extended in any way whatsoever by any agent, dealer, distributor, service company or other party other than BainUltra Inc.

LEGAL RIGHTS

This limited warranty gives specific legal rights and is not applicable if it interferes with any law or regulation in any state, province or country.



IMPORTANT

Drawing is to scale.

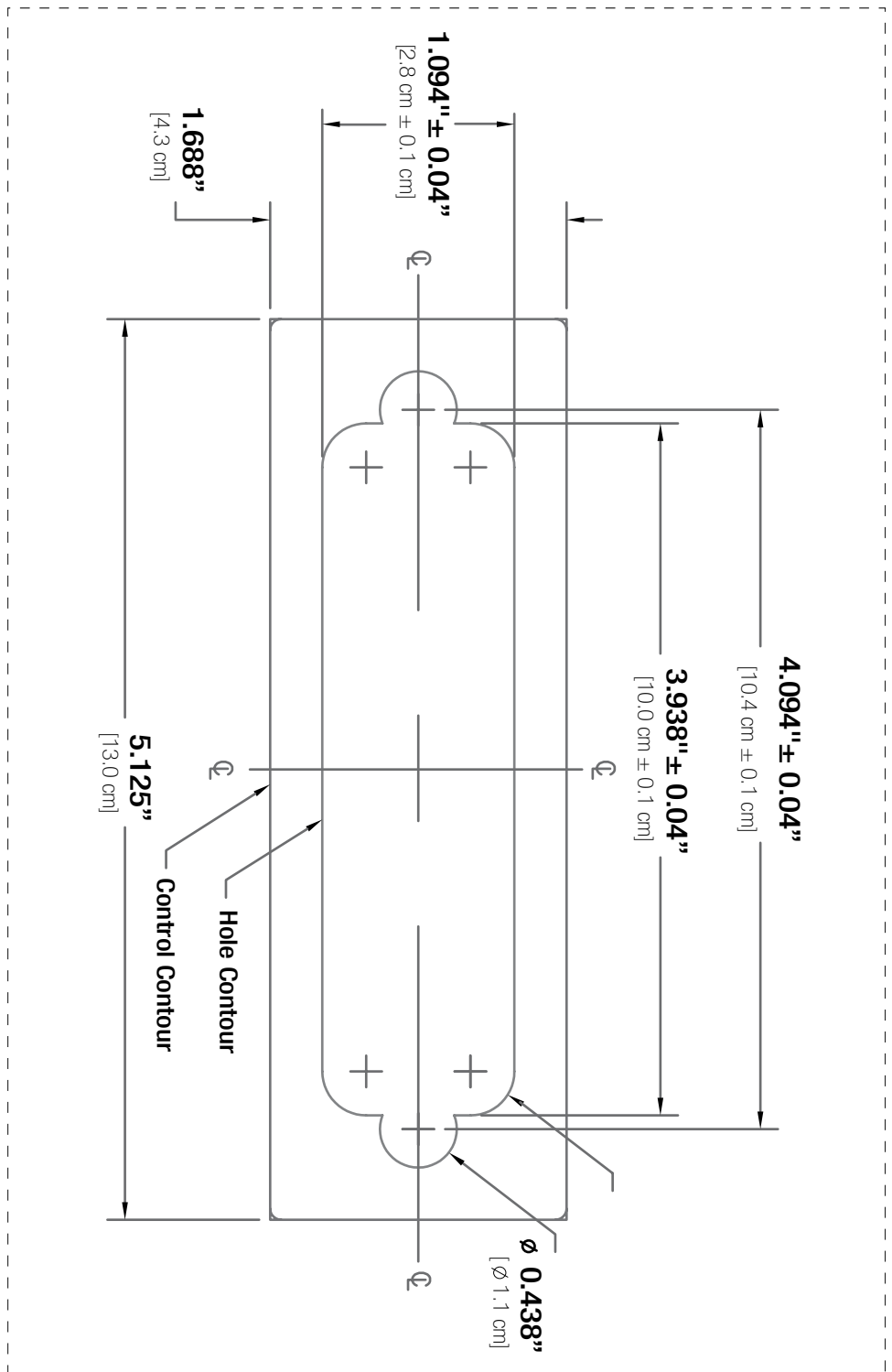

Drawing of Mia® Control hole

MIAPLUS® & MIAMULTI®
 DRILLING TEMPLATES

IMPORTANT

Drawing is to scale.

Drawing of MiaPlus® and MiaMulti® control hole (same template).

IR could be installed at arms reach or maximum up to 15 feet away from the bath.

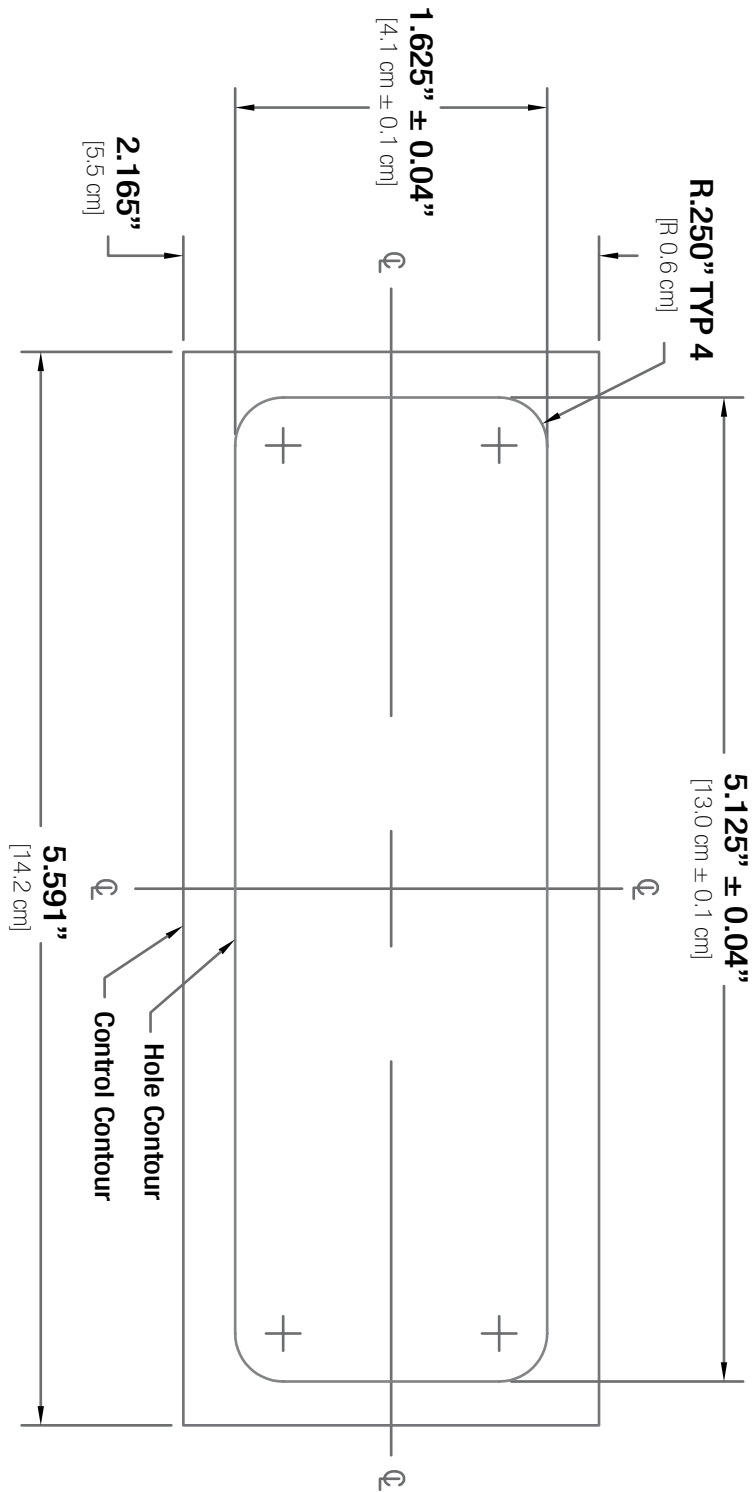

Drawing of IR hole for MiaMulti®

