

Cleaning and care

Cleaning the milk pipework

The milk pipework must be cleaned with the cleaning agent. Cleaning takes approx. 7 minutes.

You need one packet of the Miele cleaning agent for milk pipework.

The cleaning process cannot be cancelled once it has started. The process has to be carried through to the end.

- Touch "Maintenance"  in the main menu and then "Clean the milk pipework". The process will start.
- Follow the instructions in the display.

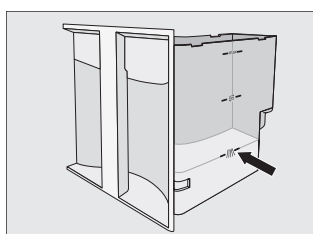

- Fill the water container with lukewarm water up to the level marker  and add 1 packet of Miele milk pipework cleaning agent to it. Replace the water container.

When "Fill and replace the water container" appears in the display:

- Remove the water container and rinse it carefully with clean water.

Make sure that no cleaning agent is left in the water container.

The cleaning process is finished when "Process finished" appears in the display.

Descaling

Degreasing the brew unit

After 200 portions have been dispensed, "Degrease the brew unit" will appear in the display. This message will not go out until the brew unit has been degreased.

You need 1 Miele cleaning tablet to degrease the brew unit. The process takes approx. 10 minutes.

The cleaning process cannot be cancelled once it has started. The process has to be carried through to the end.

- Touch "Maintenance"  in the main menu and then "Degrease the brew unit". The process will start.
- Follow the instructions in the display.

When "Place a cleaning tablet in the ground coffee chute and close the chute" appears in the display:

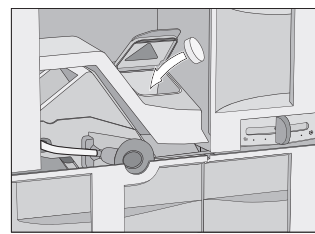

- Remove the coffee chute cover and open the lid of the coffee chute. Place a cleaning tablet into the coffee chute.
- Follow the instructions given in the display.

The brew unit has been degreased when "Process finished" appears in the display.

Descaling must be carried out and takes approx. 20 minutes.

- You will need 2 descaling tablets.

The descaling process cannot be cancelled once it has started. The process has to be carried through to the end.

- Touch "Maintenance"  in the main menu and then "Descal the appliance". The descaling process will now start.
- Follow the instructions in the display.

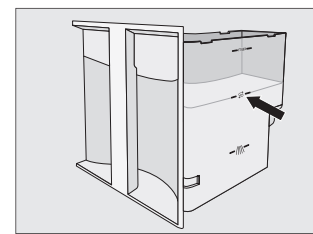

- Fill the water container with lukewarm water up to the level marker  and drop 2 descaling tablets in it. Replace the water container.

Follow the instructions on the packet for the mixing ratio carefully. It is important that you fill the water container with the correct amount of water (not less or more), otherwise descaling will be cut short and must then be repeated.

When "Fill the water container with fresh tap water up to the descaling mark  appears in the display:

- Remove the water container and rinse it carefully with clean water.

Make sure that no descaling agent is left in the water container.

Descaling is finished when  appears in the display.

Tips for use

Changing the portion size or drink parameters

The changed portion size or drink parameter is always stored in the current profile. The name of the current profile is shown in the top left of the display.

Start in the drinks menu.

- Place the desired cup under the main dispenser.
- Touch "Edit" and then "Change drink".
- Swipe the screen until the drink you want appears, then touch it to select it. You can now "Change the portion size" or program "Drink parameters".

Changing the portion sizes

The desired drink will be prepared and "Save" will appear in the display.

- Touch "Save" when the cup has been filled to the level you want.

Touch "Save" when the cup has been filled to the level you want.

The ingredients selected will have a check beside them.

- Touch "OK".

Touch "Save" when the amount you want of the particular ingredient has been dispensed.

- Save the portion size required for the selected ingredients.

The programmed mix of ingredients and portion sizes will now be dispensed every time that particular drink is selected.

Tip: You can cancel portion size programming as long as "Stop" is showing in the display.

Setting the drink parameters

- Touch "Drink parameters"

The following parameters can be set:

- Amount of coffee
- Brew temperature
- Pre-brewing

- Touch "OK" when you have set the parameters to your requirements.

Resetting drinks

To reset the portion sizes and the parameters for all drinks back to their factory default setting:

- Touch "Edit" in the Drinks menu and then "Reset drinks".

"Reset all drinks to default?" will appear in the display.

- Touch "Yes".

Profiles

You can set up individual user profiles and save individual portion sizes for all drinks for each profile.

The name of the current profile is shown in the top left of the display.

Accessing a profile

- Touch "Profiles"  in the main menu or touch "Profiles" in the bottom right of the Drinks menu.

Creating a profile

- Touch "Create profile".
- The keyboard will open in the display.
- Enter the name you want and touch "OK".

If you have already created a profile, the following options are available to you:

- Select profile
- Change name
- Delete profile
- Change profile (The coffee machine changes "Manually", "After each use" or "When turned on").

Creating drinks for a profile

You can create your own drinks for each profile and set the portion size and drink parameters individually.

You can change the names of drinks in a profile.

- Select the profile you want.

Creating a drink

- Touch "Create drink" and select the required drink from the standard drinks.
- Change the drinks parameters as required. Save the amount you want of the individual ingredients.

After dispensing, the keyboard will open in the display.

- Enter a name for the new drink and touch "Save".

If you have already created a drink, the following options are available to you:

- Change drink
- Delete drink

You can save a maximum of 9 drinks in a profile.

MyMiele



You can display drinks you make frequently, drinks from profiles and maintenance programmes in the MyMiele screen.

Opening the MyMiele  menu

- Touch "MyMiele"  in the main menu. You can now configure "MyMiele" and add entries ("Add entry").

To add entries

You can select options listed in the following categories:

- Drinks 
- Profiles 
- Maintenance 
- Touch "Add entry".

If you have already added some entries, you can carry out the following under "Edit":

- sort or
- delete entries

Settings

Changing settings

- Select "Settings"  in the main menu
- Select the menu option you want and change the setting as required.

- Touch "OK" to save the setting.

Tip: Touch "Back" to return to the previous menu.

Option	Available settings	Notes
Language	Deutsch, English and other languages Country	Tip: If you select the wrong language by mistake, you can find the "Language" option by following the flag symbol  .
Time	Display (On / Off / Night dimming) Clock type (Analog / Digital) Clock format (12 h / 24 h) Set	Your choice of display will affect the energy consumption of your coffee machine. A message about this will appear in the display.
Date	Year / Month / Day	
Timer	Timer 1 (Turn on at, Turn off at, Turn off after) Timer 2 (Turn on at, Turn off at)	For "Turn on at" and "Turn off at", the timer must be activated and at least one day of the week must be allocated.
Eco mode	On / Off	
Lighting	Brightness (Machine turned on or turned off) Turn off after	
Start screen	Main menu Drinks menu Profiles MyMiele	
Info		Number of drinks No. of uses until descaling / degreasing the brew unit.
System lock	On / Off	When the system lock is activated, the "Turn on at" option for the timer cannot be selected.
Water hardness	Soft, Medium, Hard, Very hard	
Display brightness	Set	
Volume	Buzzer tones Keypad tones	
Showroom program	Demo mode (On / Off)	Only for demonstration purposes in showrooms or exhibitions. Do not activate this setting for domestic use!
Plate & Cup warmer	Automatic / On / Off	
Dispenser adjustment	On / Off	The height of the main dispenser cannot be adjusted manually.
Factory default	Settings MyMiele	Please note that the following settings will not be reset: Language, Time, Number of drinks dispensed, User profiles
Plumbed water supply	On / Off	(Only applies to CVA 6805)

Quick Guide  
Built-in Coffee System



This Quick Guide does not replace the Operating and Installation Instructions. It is essential to read the Operating and Installation Instructions to familiarize yourself with how to use the coffee machine before using it for the first time. Please pay particular attention to the IMPORTANT SAFETY INSTRUCTIONS.

CLEANING AND CARE / DESCALING

TIPS FOR USE

SETTINGS

## Important information

### Before using for the first time

⚠ The coffee machine must be correctly installed and connected before it is used for the first time. For more information please see the Operating and installation instructions.

- Before filling the coffee machine with water and coffee beans, clean the coffee machine and the milk container thoroughly.
- Please see "First steps to use" in the Operating and installation instructions.

### Water hardness

Set the water hardness level on the coffee machine to the water hardness level for the local area to ensure that the machine functions correctly and is not damaged. See the Operating and installation instructions for more information.

## Controls and display

### Sensor controls

On/Off sensor ①	For turning the coffee machine on and off
"Back"	For returning to the previous menu, cancelling unwanted actions

### Touch display

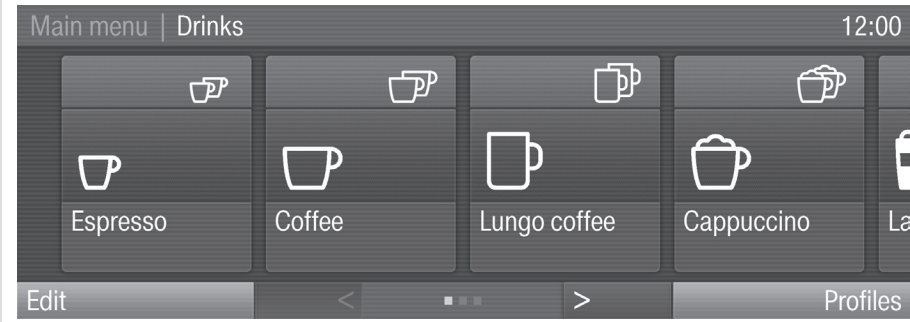

**Selecting or accessing a menu** ■ Touch the field you want once with your finger.

**Scrolling** ■ Swipe the screen, i.e. place your finger on the Touch display and swipe it in the direction you want.  
■ Or: Touch the < or > arrows to scroll from left to right.

**Exiting a menu** ■ Touch "Back".  
Entries made before this which have not been confirmed with "OK" will not be saved.

**Entering numbers** You can enter numbers by swiping and touching the roller or via the numerical keypad.  
Roller:  
■ Swipe the roller up or down to select the number you want  
Numerical keypad:  
■ Touch in the bottom right of the input field.  
The numerical keypad will appear:  
■ Touch the numbers you want.  
When you enter a valid number, the "OK" field will light up green.  
■ Use the arrow to delete the last entered number.  
■ Touch "OK".

**Entering letters** Names are entered using a keyboard. It is best to select short names.  
■ Touch the letters or characters you want.  
■ Touch "Save".

## Guide to the machine

### Exterior view

- On/Off sensor ①
- Touch display
- "Back" sensor
- Handle
- Hot water dispenser
- Drip tray
- Main dispenser with lighting and automatic height adjustment
- Milk container and lid

### Interior view

- Ground coffee chute cover
- Brew unit
- Ground coffee chute
- Grind control to select fineness of ground coffee
- Coffee bean container
- Water container
- Drip tray with grid
- Waste unit
- Drip catcher
- Main dispenser connector
- Service cover

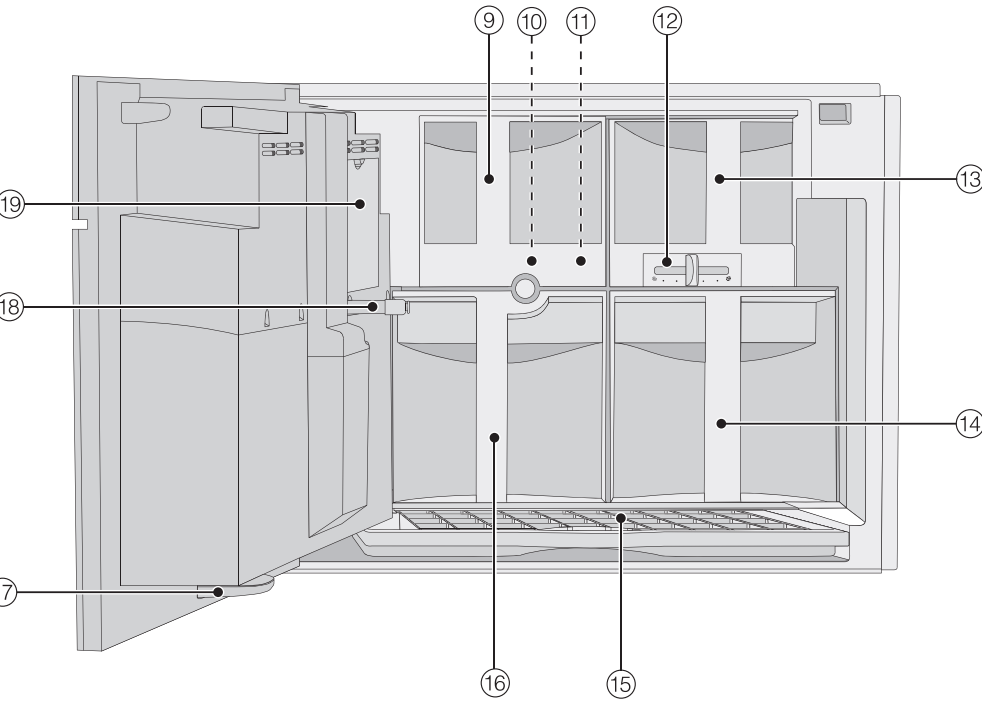
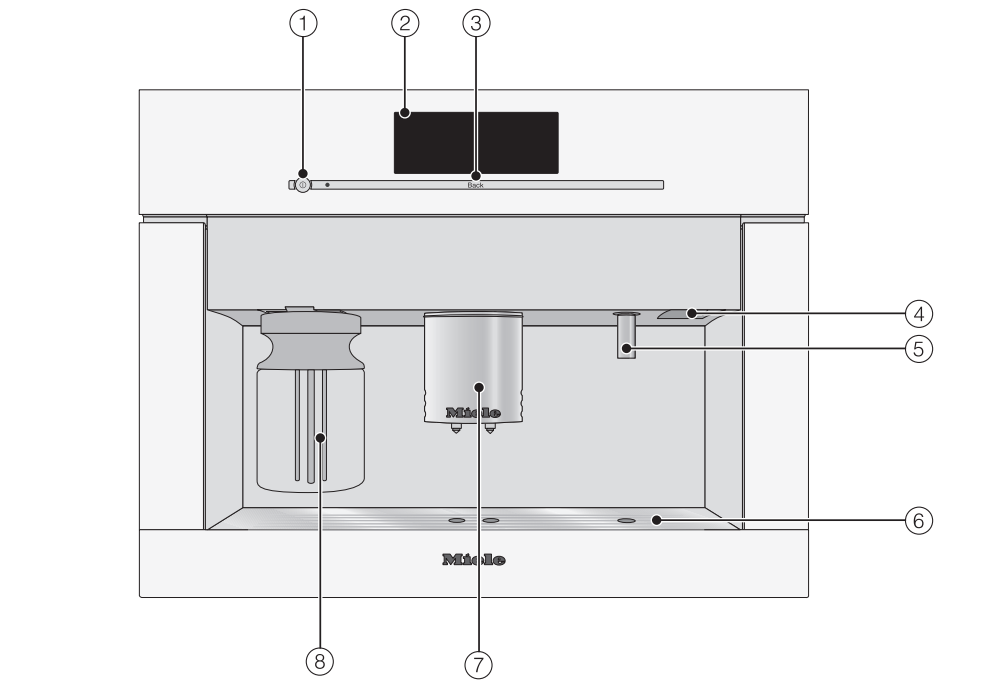

## Preparing for use

### Filling the water container

Change the water every day to prevent a build-up of bacteria.



- Fill the water container with fresh, cold tap water up to the "Max." marker.

### Filling the coffee bean container

Warning. Only put roasted espresso/coffee beans in the container.

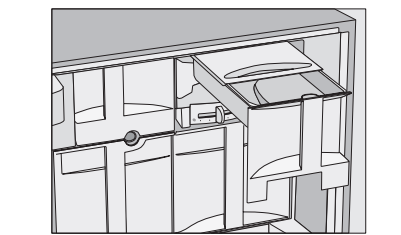

- Open the front of the machine and remove the coffee bean container.
- Fill the container with roasted coffee beans.

## Making drinks

### Fill the container with roasted coffee beans.

- Place a cup under the main dispenser.
- Touch the field for the drink you want:
  - Espresso
  - Coffee
  - Lungo coffee

The coffee or espresso will be dispensed from the main dispenser into the cup.

### Making two portions



- To fill two cups at the same time:
- Place a cup under each of the main dispensers.
  - Touch the two cup symbol for the drink you want.
- Two portions of the desired drink will be dispensed from the main dispenser.

### Canceling preparation

- To cancel preparation:
- Touch "Cancel" or "Stop".

### Drinks with milk

#### Notes on the milk container

The milk will not keep cool in the milk container. It should therefore be kept in the fridge if you are not going to be using milk for a long period. Cold milk (below 55°F/13 °C) gives the best results for milk froth.

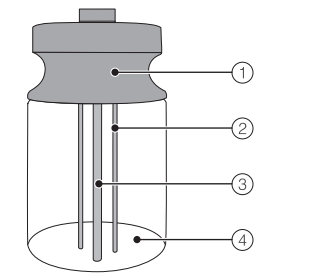

- Lid
- Sensor rod
- Milk intake tube
- Glass container

- Fill the container with milk up to a maximum of 3/4" (2 cm) below the rim.

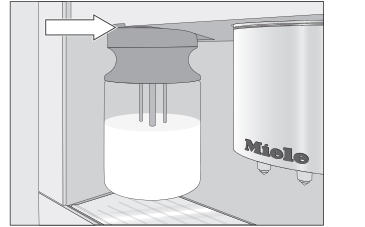

- Push the milk container fully back into the coffee machine.

### Making drinks with milk

- Place a suitable container underneath the main dispenser.
- Touch the drink you want:
  - Cappuccino
  - Latte macchiato
  - Caffè Latte
  - Hot milk
  - Milk froth

The selected drink will now be made.

### Hot water

- Place a suitable container underneath the hot water dispenser.
  - Select "Hot water" .
- Hot water is dispensed into the container under the dispenser.

To cancel preparation:

- Touch "Cancel" or "Stop".

## Cleaning and care

Please observe the detailed information on cleaning and care in the Operating instructions. Clean the coffee machine every day after use.

Please observe the detailed information on cleaning and care in the Operating instructions. Clean the coffee machine every day after use.	What do I have to clean / maintain?
Every day (at the end of the day)	<ul style="list-style-type: none"> <li>the milk container and lid</li> <li>the water container</li> <li>the waste unit</li> <li>the drip tray and grid</li> </ul>
Once a week (or more often if needed)	<ul style="list-style-type: none"> <li>the main dispenser</li> <li>the main dispenser connector</li> <li>clean the milk valve with the cleaning brush</li> <li>the interior</li> <li>the small drip catcher inside the front of the machine</li> <li>the brew unit</li> <li>the front of the machine (especially straight after descaling)</li> </ul>
Once a month	<ul style="list-style-type: none"> <li>lubricate the cap on the main dispenser connector</li> </ul>
When prompted	<ul style="list-style-type: none"> <li>the milk pipework (using the cleaning agent for milk pipework)</li> <li>the brew unit (degrease with the cleaning tablets)</li> <li>descal the machine</li> </ul>
As required	<ul style="list-style-type: none"> <li>the coffee bean container</li> <li>remove any blockages from the milk pipework</li> </ul>

The following items are not dishwasher safe:

- Main dispenser cover
- Brew unit
- Coffee bean container and lid
- Service cover

All other removable components of the coffee machine are dishwasher safe.