

Dear Customer,

Thank you for choosing this quality product from ASKO.

We hope it will meet your expectations and fulfill your needs for many years to come. Scandinavian design combines clean lines, everyday functionality, and high quality. These are key characteristics of all our products and the reason they are greatly appreciated throughout the world.

To get the most out of your new dishwasher, we recommend that you read the operating instructions before using it. The operating instructions also include information on how you can help protect the environment.

Do you need this Use&Care Guide in spanish? Log onto www.askona.com/customer-care to download.

¿Necesita esta Instrucciones de uso y cuidado en español? Entre en www.askona.com/customer-care y descárguesela.



Operating Instructions

Dishwasher
ASKO D5634XXLHS



Contents

Front panel	2	Care and maintenance instructions	12
Important safety instructions	3	Troubleshooting	14
Before washing for the first time	4	Technical information	17
Loading the dishwasher	5	Service	18
Using the dishwasher	7	Program chart	19
Settings	10		

Front panel

The panel is fitted with touch buttons with audible feedback (see the chapter Settings).

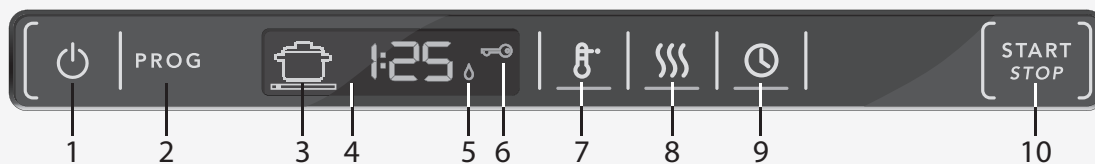

- | | | |
|--------------------|----------------------------|-----------------|
| 1 On/Left-on mode | 5 Rinse aid indicator | 9 Delayed start |
| 2 Program selector | 6 Child lock (button lock) | 10 Start/Stop |
| 3 Program symbol | 7 High temperature | |
| 4 Display | 8 Long dry | |

NOTE!

- Two minutes after the last button press, the panel backlight enters energy saving mode. Close and reopen the door, or press the On/Left-on mode button, to reactivate the panel.

Important safety instructions

SAVE THESE INSTRUCTIONS FOR FUTURE REFERENCE

WARNING!

This manual does not cover all possible conditions and situations that may occur. Common sense and caution should always be used when installing, operating, and maintaining any appliance.

- Read all instructions before using the dishwasher.
- Dishwashers must be electrically grounded. Read the Installation Instructions for details.
- Use the dishwasher only for its intended purpose.
- Do not run the dishwasher while you are out of the home.
- Use only automatic dishwasher detergents and rinse agents.
- To reduce the risk of injury, keep detergents and rinse aids out of the reach of children.
- Do not load sharp items near the door; you could damage the door seal.
- Place sharp knives in the cutlery basket with the sharp ends down to avoid the risk of cut-type injuries.
- Do not wash plastic items unless they are marked "dishwasher safe" or the equivalent. For items not marked, check the manufacturer's recommendations. Items not dishwasher safe could become deformed or melt and create a potential fire hazard.
- Do not operate the dishwasher unless all enclosure panels are properly in place (i.e., guard plate, access panel, toe kick, etc.).
- Do not tamper with controls by removing or changing.
- Do not abuse, sit on, or stand on the dishwasher door or baskets.
- To reduce the risk of injury, do not allow children to play in or on a dishwasher.
- Under certain conditions, hydrogen gas may be produced in a hot water system that has not been used for two weeks or more. HYDROGEN GAS IS EXPLOSIVE. If the hot water system has not been used for two weeks, before using the dishwasher turn on all hot water faucets and let the water flow from each for several minutes. This will release any accumulated hydrogen gas. As the gas is flammable, do not smoke or use an open flame during this time.
- When removing an old dishwasher from service or discarding it, remove the door to the washing compartment.
- Do not store or use combustible materials, gasoline, or other flammable vapors and liquids in the vicinity of this or any other appliance.
- Disconnect electrical power to dishwasher before servicing.
- Repairs should be done by a qualified technician.
- Read the grounding instructions in the installation instructions.

Child safety

TIP!

Dishwasher detergents and rinse aids are corrosive, so always keep them out of reach of children.

- Should a child swallow dishwasher detergent or rinse aid, give plenty to drink immediately, i.e., one or two glasses of milk or water. Do not try to induce vomiting. Seek medical advice immediately: Call the National Capital Poison Center at 1-800-222-1222.
- Always close the door and start the dishwasher as soon as you put in the detergent.
- Always keep small children away from the machine when it is open. There may be some detergent residue left inside the machine.
- If dishwasher detergent gets in someone's eyes, rinse them with plenty of water for at least 15 minutes.
- Do not allow children to use or play in or on the dishwasher.
- Load sharp objects with the pointed end facing the back of the dishwasher. Sharp items loaded in the cutlery basket should be loaded with pointed ends down.

Activate child lock (Kid Safe™)

You can activate the child lock (button lock) to prevent children from starting the dishwasher (see the section Settings).

Winter storage/Transport

- Store the dishwasher where the temperature remains above freezing.
- Avoid long transport distances in very cold weather.
- Transport the dishwasher upright or laying on its back.

Overflow guard function

The overflow protection starts pumping out the machine and turns off the water supply if the water level in the dishwasher exceeds the normal level. If the overflow protection is triggered, turn off the water supply and call the Customer Care Center.

Care and maintenance instructions

When cleaning the edge around the door, use only a slightly damp cloth. Do not spray water around the edge! Moisture can make its way into the lock, which contains electrical components.

Packing material

Please sort waste materials in accordance with local guidelines.

Disposal

- When the machine has reached the end of its service life and is to be disposed of, it should immediately be made unusable. Pull out the power cable and cut it as short as possible.
- The dishwasher is manufactured and labeled for recycling.
- Contact your municipality for information about where and how your dishwasher can be recycled correctly.

Before washing for the first time

Water supply

The machine can be connected to either a hot (max. 160 °F, 70 °C) or cold water supply. We recommend a cold water supply. The water pressure should be 4.2-140 psi. See also the section Economic dishwashing in the chapter Loading the dishwasher.

Program key

Some dishwashers include program keys in different languages. Attach the program key in the appropriate language to the top of the door.

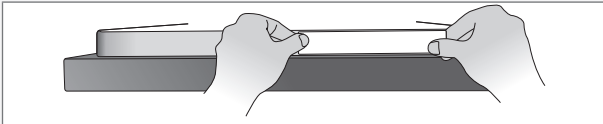

Checking water hardness

Contact the local water utility to check the water hardness in your area. This is important to determine how much detergent and rinse aid to use.

Top up with rinse aid

Drying is faster if you use rinse aid.

- 1 Open the rinse aid compartment lid.
- 2 Carefully top up with rinse aid. Only add rinse aid to the level marked **max**.
- 3 Wipe up any spilled rinse aid around the compartment.
- 4 Close the lid firmly.

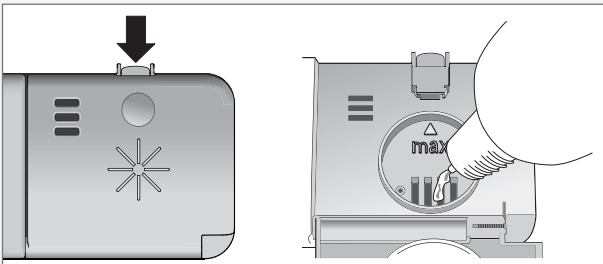

Selecting the rinse aid dosage

Rinse aid dispensing can be set from **0** (Off) to **5** (High dose). (Factory settings: **5**)

Increase the rinse aid dosage:

- If the dishes have water marks.

Reduce the rinse aid dosage:

- If the dishes have a sticky white/blue film.
- If the dishes are streaked.
- Heavy foaming. If you have very soft water, the rinse aid can be diluted 50:50 with water.

Setting the rinse aid dosage

The section Settings describes how to set the rinse aid dosage.

Refill rinse aid indicator

When the rinse aid needs topping up, the above symbol lights on the display.

NOTE!

After topping up, it may take a while before the symbol goes out.

Loading the dishwasher

Economic dishwashing

Run programs only with a full load

Wait until the dishwasher is fully loaded before running a program, this way you save energy. Use the Rinse & Hold program to rinse the dishes if there are any unpleasant odors while you wait for the dishwasher to become fully loaded.

Run programs at a lower temperature

If the dishes are only lightly soiled, you can select a lower temperature with certain programs. See also the section Selecting Options in the chapter Using the dishwasher.

Select a program with Short dry

To save energy, use Short dry. The drying result will be better if, once the program is finished, you leave the door slightly open.

Do not rinse under running water

Simply scrape off large food particles before loading the dishwasher.

Choose a green detergent

Read the environmental declaration on the packaging!

Connect to cold water...

If you use oil or electricity to heat your home.

Connect to hot water (max. 160 °F (70 °C))...

If you use district heating, solar power, or geothermal power to heat your home. Choosing a hot water connection cuts program times and reduces the dishwasher's electricity consumption.

Fragile dishes

Some cookware is not dishwasher safe. This can be for several reasons. Some materials cannot withstand high temperatures, others can be damaged by dishwasher detergent.

Fragile decoration

Porcelain with decoration on top of the glazing (the items feel rough) should not be washed in a dishwasher.

Crystal/Glass

Position items so that they do not touch each other during the wash. Use the lowest possible wash temperature and the shortest possible program. Select Short dry. Antique and very fragile items should not be washed in a dishwasher.

Glass washed in a dishwasher at high temperatures can gradually develop a gray film that cannot be removed. Wash fragile glasses at a low temperature and with a small amount of detergent.

Silver

Silver and stainless steel items should not come into contact, as the silver can become discolored.

Cutlery with glued handles

Some types of glue are not dishwasher safe. In such cases, the handles may loosen.

Wood

Wooden items should only be washed in a dishwasher if marked dishwasher safe.

Aluminum

Aluminum can lose its shine if washed in a dishwasher. However, good quality aluminum pans can be washed in a dishwasher, even if some of the shine will be lost.

Plastic items

Avoid washing plastic items that cannot withstand high temperatures.

Typical load for 10 place settings

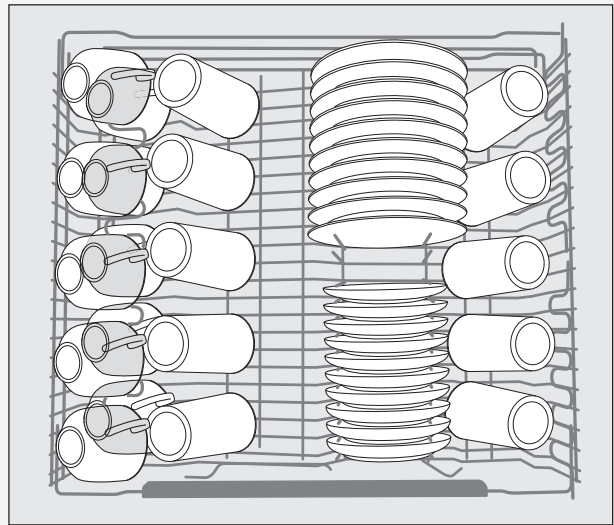

Upper basket with 10 place settings AHAM DW-1

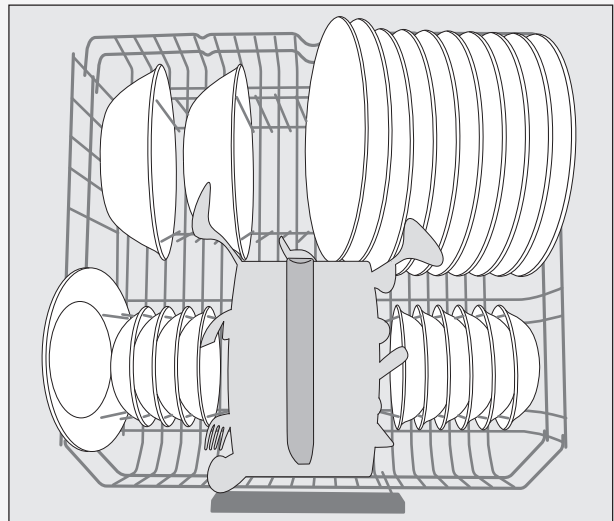

Lower basket with 10 place settings AHAM DW-1

Upper basket

Place glasses, cups, bowls, side plates, and saucers in the upper basket. Wine glasses are placed on the wine glass shelf and knives are placed in the knife stand on the right (if equipped).

NOTE!

All dirty surfaces should face in and down!

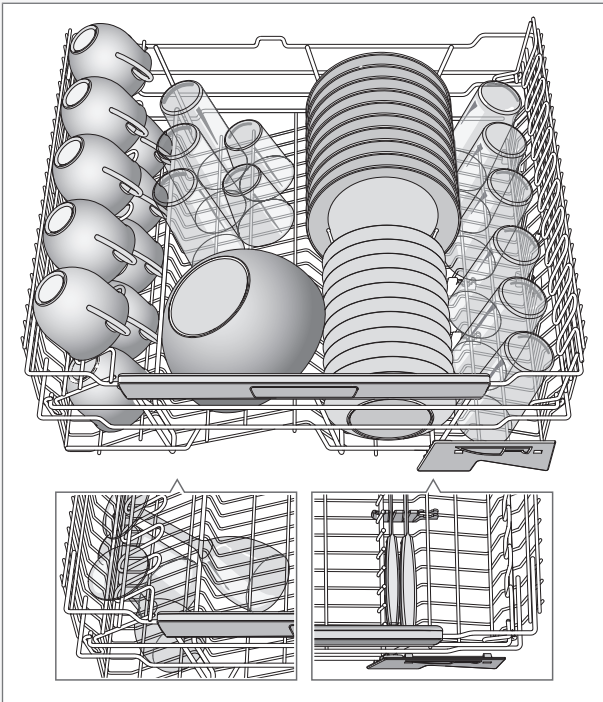

Lower basket

Place plates, side plates, serving dishes, pots, and cutlery (in the cutlery basket) in the lower basket.

Place pots and pans in the rear left of the lower basket to best utilize dishwashing performance from the rear spray nozzle (Power Zone™ Pot & Pans), which is intended for these types of dishes.

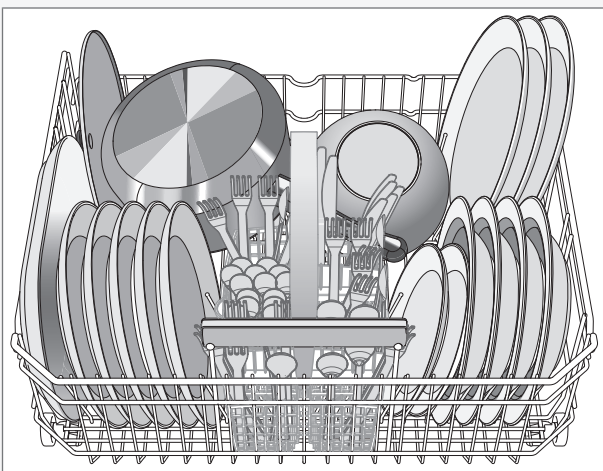

Fold-down plate supports

Lower the fold-down plate supports when washing pots.

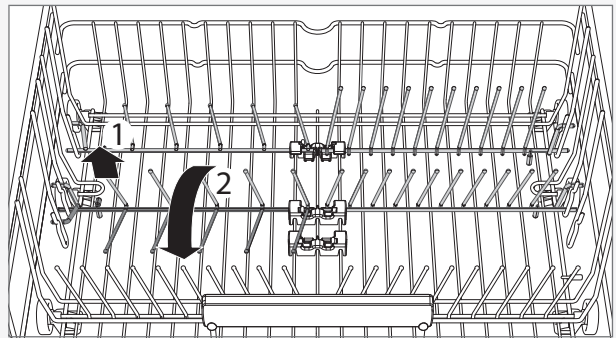

Forward mount for plate support

Used for plates with a diameter greater than 9 3/4" (25 cm).

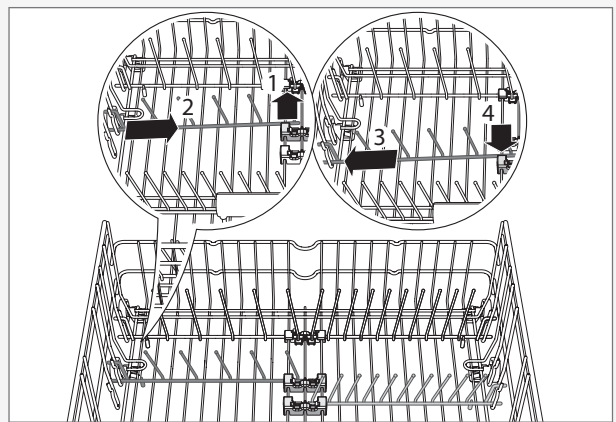

Cutlery basket

Place cutlery with the handles facing down, except for knives, and spread them out as much as possible. Ensure that spoons do not stack inside each other.

The cutlery basket is best placed in the middle at the front of the lower basket to best utilize dishwashing performance from the unique spray nozzle (Power Zone™ Cutlery), which is intended for the cutlery basket.

NOTE!

Do not place cutlery made of different materials, such as silver and stainless steel, in the same place (risk of discoloration).

⚠ WARNING!

Knives and other pointed items must be placed with the points down in the cutlery basket or horizontally in other baskets.

Fold-down section for small items

The cutlery basket has a fold-down section in the middle for small items, or small shafts, such as electric whisk attachments.

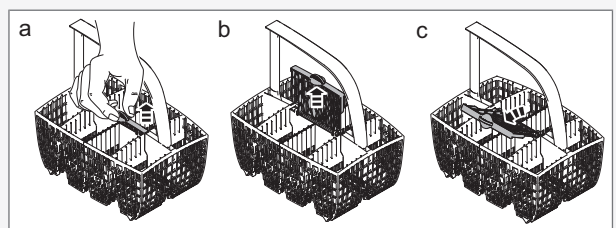

Using the dishwasher

Add detergent

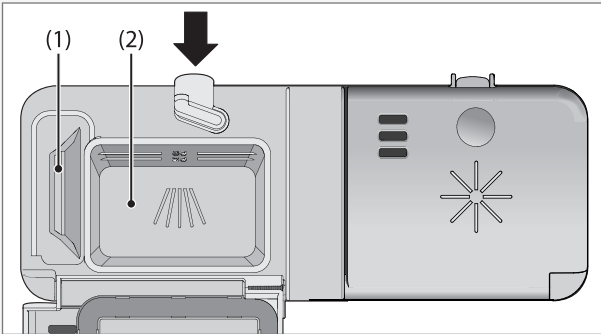

- 1 Prewash detergent compartment
- 2 Main wash detergent compartment

We recommend that you use only unscented, granular automatic dishwashing detergent. Using the wrong detergent could cause flooding and/or damage your dishwasher. Do not use detergent that has been wet and is clumped. Also, check the expiration date on the container.

The amount of detergent needed can vary due to differences in water hardness. To determine the water hardness in your area, contact your local water utility or area water softening company. The harder the water, the more detergent you may need. Refer to the chart below for the recommended detergent amounts based on water hardness. Remember, you should adjust the amount of detergent you use by small amounts until you find the correct amount. Twelve grains and higher is extremely hard water and detergent alone may not be enough. You may need to use a water softener to maximize the performance of your dishwasher. Also, in areas with hard water (9+) you may need to wash at lower temperatures to prevent hard water deposits from forming in tank and wash system. In hard water areas, both the dishes and the machine can develop a white or gray film after a while. If this happens, run the Normal program with high temperature and two tablespoons of citric acid or commercially available dishwasher cleaner in the detergent compartment (with no dishes in the machine).

NOTE!

We recommend that you do not add prewash detergent for the programs Quick or Super Quick.

NOTE!

If you use a dishwashing detergent with a rinse aid additive, you should not fill the rinse aid dispenser. This could cause a film on your dishes.

Recommended detergent amounts based on water hardness

Water hardness	Detergent amounts
Soft (0-3 grains per gallon)	Prewash 1 teaspoon Main wash 1 to 1-1/2 tablespoons
Medium (4-8 grains per gallon)	Prewash 1 teaspoon Main wash 1 to 2 tablespoons
Hard (9+ grains*)	Prewash 1 teaspoon Main wash 2 to 3 tablespoons

*12 grains and higher is extremely hard water.

⚠ WARNING!

Children must be supervised – dishwasher detergent is corrosive!

NOTE!

Use only dishwasher detergent! Liquid hand-washing detergent must not be used as the foam that forms prevents the dishwasher from operating effectively.

Dishwasher tablets

Halve the tablet if it is difficult to close the dispenser lid. There is a risk that the detergent will not be released properly if the lid is tight and cannot open correctly.

NOTE!

Dishwasher tablets are not recommended for short programs (less than 75 minutes). Use powder or liquid dishwasher detergent instead.

3-in-1/All-in-one detergent

Read through the directions for these products carefully. If anything is unclear, contact the detergent manufacturer.

Program selection

Press the Program selector one or more times until the desired program symbol appears on the display.



Sanitation

A program with the ability to help with most household germs and extra dirty dishware. This program will have a high final rinse temperature for a good drying result and germ treatment.

NOTE! Do not put in dishware that cannot stand high wash or rinse temperatures.



Normal

Use to wash normally soiled dishes, such as plates, serving dishes, cups, glasses, and so on.



Heavy

Program for very dirty dishes, such as pans, casserole dishes, and oven dishes. If these dishes do not completely fill the dishwasher, you can add plates and other dishes that can withstand a Heavy wash to fill out the load.



Quick

This program is used for glasses and porcelain that is lightly soiled, such as coffee cups.



Super Quick

Short program lasting about 15 minutes with acceptable results for very lightly soiled dishes.



Delicate

If the dishes are only lightly soiled, you can select Delicate. This program is intended for glasses and porcelain that have just been used and as such do not require such a powerful program.

This program can be used for fragile dishes. Select Short dry if you want to be especially cautious. See also the section Fragile dishes in the chapter Loading the dishwasher.

Eco Eco

Use when you want to save energy. For normally soiled dishes.



Rinse & Dry

This program consists of a rinse with heating and drying. This is a suitable program if, for example, you plan to make jam and want to rinse and heat clean glass jars.



Rinse & Hold

Use to rinse dishes while you wait for the dishwasher to become fully loaded.

Selecting Options

To select an option, press one of the option buttons. The field under the button lights when the option is activated. The available options depend on the selected program. Once you have started the program, the options you selected are saved for the next time you use the same program. An exception is the Delayed start option.



High temperature

Activate this option for improved dishwashing results. The machine then uses a higher temperature for the main wash.

If you want to use the lower temperature, press again so that the field under the button turns off.

You can vary the temperature as shown below:

	Sanitation:	130 °F (55 °C) / 160 °F (70 °C)
	Normal:	130 °F (55 °C) / 150 °F (65 °C)
	Heavy:	140 °F (60 °C)/150 °F (65 °C)
	Quick:	85 °F (30 °C) / 140 °F (60 °C)
	Super Quick:	85 °F (30 °C) / 140 °F (60 °C)
	Delicate:	105 °F (40 °C) / 120 °F (50 °C)
	Eco Eco:	120 °F (50 °C) / 140 °F (60 °C)



Long dry

A higher temperature in the final rinse and a longer drying phase improves the drying result if you activate the Long dry option. This causes a slight increase in energy consumption. This option can be used with all programs except Rinse & Dry and Rinse & Hold.

If you want a program with Short dry, press again so that the field under the button turns off.



Delayed start

When you select Delayed start, the dishwasher will start 1-24 hours after you press the Start/Stop button.

- 1 Press the button once to activate Delayed start. Press the button several times – or hold it in – to set the desired number of hours.
- 2 Press Start/Stop and the dishwasher counts down 1 hour at a time and starts after the selected delay.

Press and hold Start/Stop for three seconds if you want to cancel the Delayed start option.

NOTE!

Remember to press the Start/Stop button to start the program.

Start the dishwasher

Press and hold Start/Stop until the display shows (the door open symbol). This indicates that the dishwasher is ready to start. Close the door properly, otherwise the dishwasher will not start. The display flashes three times with the remaining time to indicate that the program has started.

NOTE!

If the machine does not start within 2 minutes of the last button press, the display returns to showing the last program run.

Time remaining

Once you have selected a program and options, the display indicates how long the program took the last time it was used. Once you have started the dishwasher, the display indicates how much program time remains. The remaining time is updated after the water for the final rinse has been heated.

This may differ somewhat from time to time depending on the temperature of the water supply, the amount of dishes, the ambient temperature, and other factors.

The time counts down while the program is running and the remainder of the program is displayed. The remaining time is displayed, e.g., 1:15, meaning that 1 minute 15 seconds of the program remains.

NOTE!

During the first run of each program, the remaining time displayed can be slightly misleading, as the dishwasher is estimating the time. When you run the program a second time, the dishwasher will calculate the remaining time based on the previous duration of the program.

Stopping or changing a program

If you want to change programs after starting the dishwasher, open the door then press and hold Start/Stop for three seconds. Add more detergent if the lid of the detergent dispenser has opened. Then choose a new program, press Start/Stop, and close the door.

Do you want to add more dishes?

Open the door. The dishwasher stops automatically. Add the dishes, close the door, and the dishwasher resumes the program.

If the dishwasher is turned off using the On/Left-on mode button or due to a power failure

If the program was not finished, the interrupted program resumes when power is restored.

NOTE!

During drying, the program is interrupted if the power is cut or the door is open for more than 2 minutes.

Once the program has finished

Once the program has finished, "End" appears on the display.

A buzzer also sounds at the end of the program. See the section Settings, which describes how to change this function.

Once the dishwasher has finished, it uses only standby power. Turn off the water supply valve after each use.

Settings

Do as follows to open the settings menu:





1. First, open the door. Turn off the dishwasher using the On/Left-on mode button (press and hold). Release the button.
2. Press and hold the On/Left-on mode button until the display lights up.
3. Within five seconds, press and hold the Program selector and the Long dry button.
4. Release the buttons when the display shows .

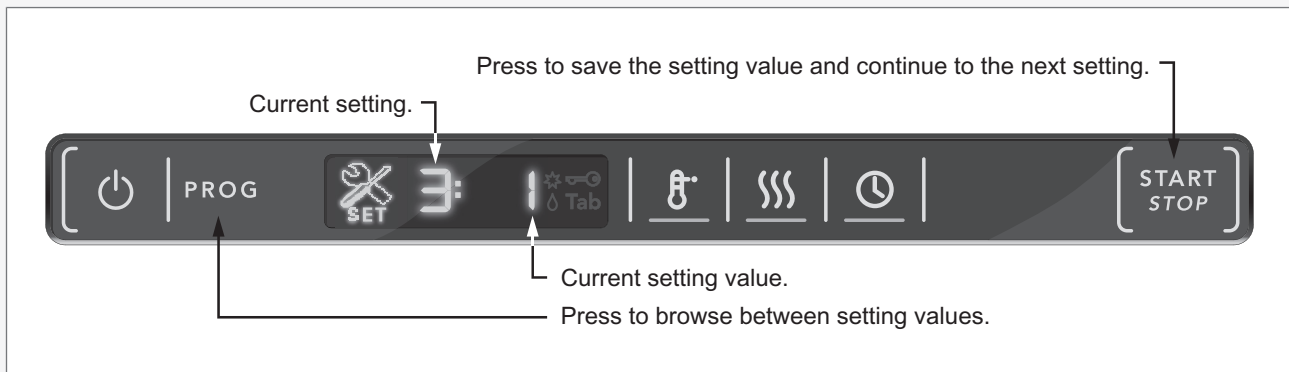







TIP!

Be sure to press right on the symbols, so as not to inadvertently activate any other button. Try again if you fail to open the settings menu the first time.



You can now adjust the following settings:

Button press	Options	Settings	Description
	<ul style="list-style-type: none"> ⏏ (Off) ⏏ (On) 	Child lock (Kid Safe™)	<p>You can activate the child lock (button lock) option to prevent children from starting the dishwasher.</p> <p>Press the High temperature and Long dry buttons simultaneously to temporarily deactivate the button lock when you want to start the dishwasher. The button lock is automatically reactivated after 2 minutes.</p> 
	<p>Press Start/Stop to save the setting value and continue to the next setting.</p> <p>If you do not want to change any other settings, keep pressing Start/Stop to step through the entire settings menu.</p>		
	<ul style="list-style-type: none"> 🔊 (Off) 🔊 1 (Low) 🔊 2 🔊 3 🔊 4 (High) 	Buzzer volume	<p>The dishwasher uses a buzzer to indicate when a program is finished or when a fault has occurred.</p>
	<p>Press Start/Stop to save the setting value and continue to the next setting.</p>		

Button press	Options	Settings	Description
PROG 	3: 0 (Off)	Operation volume	This sound is used to confirm each button press.
	3: 1 (Low)		
	3: 2		
	3: 3		
	3: 4 (High)		
START STOP 	Press Start/Stop to save the setting value and continue to the next setting.		
PROG 	4:- 1	LCD contrast (Display on the front of the door)	For adjusting the contrast of the display on the front door.
	4: 0		
	4: 1		
	4: 2		
	4: 3		
START STOP 	Press Start/Stop to save the setting value and continue to the next setting.		
PROG 	5:- 1 (Low)	LCD contrast (Display on the panel)	For adjusting the contrast of the display on the panel.
	5: 0		
	5: 1		
	5: 2		
	5: 3 (High)		
START STOP 	Press Start/Stop to save the setting value and continue to the next setting.		
PROG 	6: 0 (Off)	Rinse aid	Rinse aid dosage setting.
	6: 1 (Low dosage)		
	6: 2		
	6: 3		
	6: 4		
	6: 5		
	6: 6 (High dosage)		
START STOP 	Press Start/Stop to exit the settings menu.		

Care and maintenance instructions

Coarse filter

The coarse filter traps larger food particles, which cannot get past the drain pump. Empty the coarse filter as necessary.

- 1 Lift the coarse filter by the handle.
- 2 Empty the coarse filter. Remember to replace it!

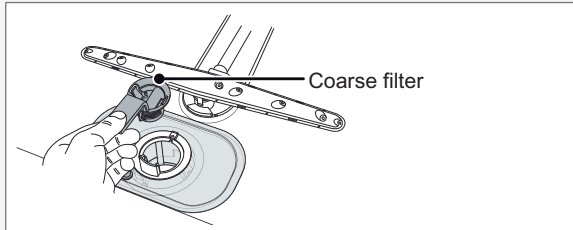

Fine filter

Debris that collects on the fine filter is automatically rinsed away during each wash. However, the fine filter and its pipe section should be cleaned a couple of times a year.

- 1 Turn the handle counterclockwise once.

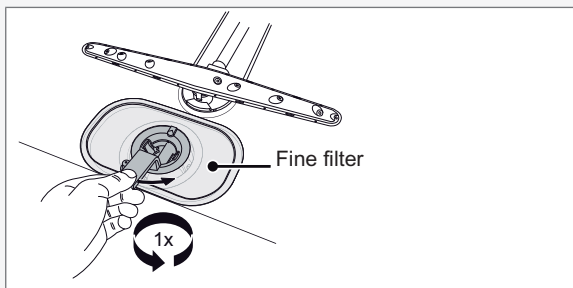

- 2 Lift the pipe section straight up by the handle. Free the coarse filter to clean the pipe section.
- 3 Remove and clean the fine filter.
- 4 Replace in reverse order. Check that the edges seal properly when replacing the fine filter.

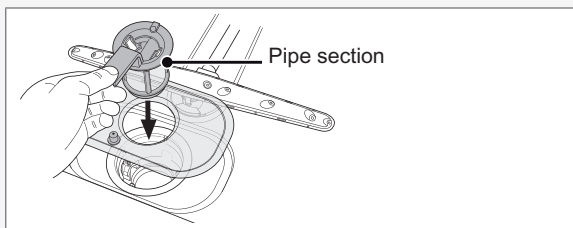

- 5 Lock the filter in place by turning the handle clockwise to the stop position. The handle should point straight out from the dishwasher.

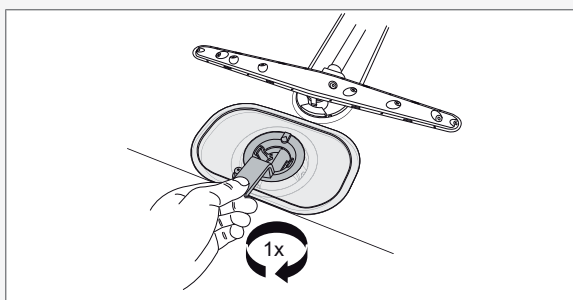

NOTE!

The dishwasher must not be used without the filters in place!

Dishwashing results may be affected if the coarse filter is incorrectly fitted.

Drain pump

The pump can be accessed from inside the dishwasher.

- 1 Cut the power to the dishwasher by unplugging the unit from the power outlet.
- 2 Remove the coarse filter and pipe section.
- 3 Remove the small yellow drain pump access cover at the left of the bottom drain (see illustration below).

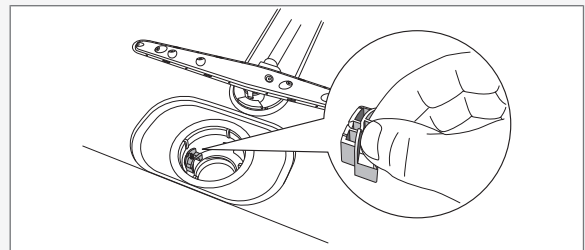

- 4 By inserting your finger into the hole, you can turn the pump blades to release anything blocking the pump.

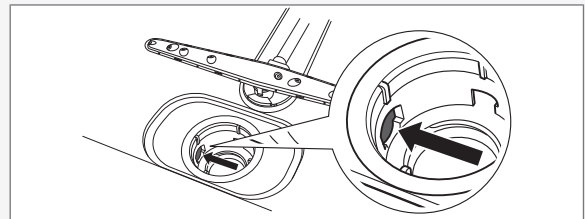

- 5 Reinstall the access cover and filters.

- 6 Plug the machine in again.

If the dishwasher still does not start and a whirring sound is heard, the overflow protection has been triggered.

- Shut off the water.
- Unplug the unit from the power outlet.
- Call the Customer Care Center.

NOTE!

Do not forget to reinstall the drain pump access cover.

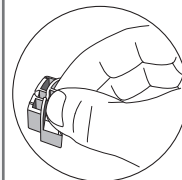

Lower spray arm

Holes and bearings can sometimes become blocked.

- 1 Pull the lower spray arm straight up to release it.
- 2 Remove any debris using a needle, toothpick, or some other similar pointed device. The spray arms also have holes underneath.

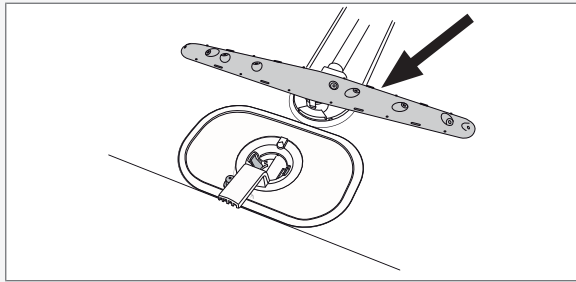

Upper spray arm

The upper basket must be removed before the upper spray arm can be released.

- 1 Pull out the upper basket and turn the basket catch on each runner outward (see illustration). The basket can now be removed.

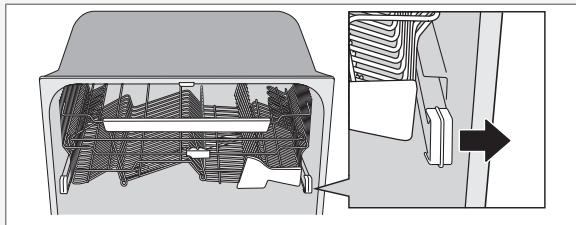

- 2 Loosen the upper spray arm in the same manner as the lower spray arm and clean it.

Door

When cleaning the edge around the door, use only a slightly damp cloth (with a little cleaner if necessary).

⚠ WARNING!

Do not use a spray bottle or the like around the door lock. This is to ensure that water does not penetrate the door catch and come into contact with the electrical components.

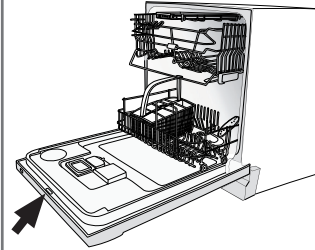

Limescale deposits

The dishwasher tub is made of stainless steel and is kept clean through normal use. However, if you have hard water, limescale deposits may form in the dishwasher. If this happens, run the Normal program with high temperature and two tablespoons of citric acid or commercially available dishwasher cleaner in the detergent compartment (with no dishes in the machine).

Front panel

Keep the touch buttons clean and free from grease. Wipe them clean with a dry or slightly damp cloth. Never use cleaners – they can scratch the surface. Use the On/Left-on mode button to turn off the dishwasher before cleaning the touch buttons to avoid activating any buttons unintentionally.





Troubleshooting

Display	Type of fault	Action
F: 10	Overfilling	Call the Customer Care Center.
F: 11	Water outlet fault	See "Water remains in the dishwasher above the filters" in the table below.
F: 12	Water inlet fault	Check that the water supply valve is on.
F:40	Inlet valve leakage	Turn off the water supply valve and call the Customer Care Center.

Turn off the machine with the On/Left-on mode button and then turn it on again to clear the error message from the display.

Problem	Possible causes	Action
The dishes are not clean.	The spray arms do not rotate.	Remove the arms and clean them. Check that the dishes are not blocking the spray arms.
	Detergent is too old. Detergent is a perishable product.	Avoid large packages.
	Incorrect detergent dosage.	Dose according to water hardness. Far too much or far too little detergent can result in poor dishwashing results.
	Dishwashing program too weak.	Select a higher temperature or a more powerful program.
	Dishes loaded incorrectly.	Do not cover dishes with large bowls or lids. Avoid placing very tall glasses in the corners of the baskets.
	Glasses and cups have toppled over during the program.	Load the dishes securely.
	The filter is not correctly fitted.	Screw the filter firmly into place. See the section Care and maintenance instructions.
Spots or films on the dishes.	Incorrect rinse aid dosage setting.	See the sections Before washing for the first time and Settings.
	Too high temperature and/or too much detergent can cause etching on crystal. Unfortunately, this cannot be repaired, only prevented.	Wash crystal at a low temperature and with a conservative amount of detergent. Contact the detergent manufacturer.
The dishes have a sticky white/blue film.	Rinse aid dosage setting too high.	Reduce the amount. See the sections Before washing for the first time and Settings. If you have very soft water, you may want to dilute the rinse aid 50:50 with water.
Spots on stainless steel or silver.	Some types of food, such as mustard, mayonnaise, lemon, vinegar, salt, and dressings, can mark stainless steel if left for too long.	Rinse off these types of food if not starting the dishwasher immediately. Or why not run the Rinse & Hold program?
	All stainless steel can cause spots on silver if they come into contact during dishwashing. Aluminum can also cause spots on dishes.	Silver and stainless steel items should not come into contact during dishwashing.
Spots left after washing.	Lipstick and tea can be difficult to wash off.	Use a detergent with a bleaching agent.

Problem	Possible causes	Action
Rattling sound when dishwashing.	The dishes are not correctly placed or the spray arms are not rotating.	Check that the dishes are placed securely. Spin the spray arms to make sure they can rotate.
The dishwasher does not start.	The Start/Stop start button has been pressed for too short a time.	Press and hold Start/Stop until the display shows  (the door open symbol). This indicates that the dishwasher is ready to start.
	The door is not properly closed.	Check.
	A fuse/circuit breaker has been tripped.	Check.
	The plug is not plugged into the power outlet.	Check.
	The water supply valve is turned off.	Check.
	Overflow/leaks.	Check.
	A whirring sound (the drain pump) is heard from the dishwasher and does not stop when the power is cut with the On/Left-on mode button.	Turn off the water supply valve. Pull out the plug and call the Customer Care Center.
	Check that the Delayed start option has not been selected.	Press and hold Start/Stop for three seconds if you want to cancel the Delayed start option.
1 minute appears on the display.	The program is taking longer than estimated.	None. Next time the program is run, the corrected time will be displayed.
Water remains in the dishwasher above the filters.	Blocked drain hose.	Loosen the drain hose from where it terminates. Check that no debris has clogged the hose. Is the cone-shaped part of the drain boot cut to the maximum size of the fitting where it attaches?
	Kink in drain hose.	Check that the hose is free from kinks and sharp bends.
	The filters are blocked.	Clean the coarse and fine filters.
	Debris in the drain pump.	Clean the drain pump. See the section Care and maintenance instructions.
Bad odor in dishwasher.	Dirt around the seals and in corners.	Clean with dish brush and low foaming cleaner.
	Low temperature programs have been selected for a prolonged period.	Run a program with a higher temperature about once a month.
The dishes are not dry enough.	Drying power too low.	Activate the Long dry option.
	The dishwasher is not fully loaded.	Fully load the dishwasher.
	Rinse aid needs topping up or dosage is set too low.	Top up with rinse add or increase the rinse aid dosage. See the sections Before washing for the first time and Settings.
		Open the door a little once the program has finished.
Cannot close door.	The baskets are not correctly positioned.	Check that the baskets are correctly positioned horizontally.
		Check that the dishes are not blocking the baskets from sliding properly into place.

Problem	Possible causes	Action
The touch buttons do not react when pressed.	You have pressed the touch buttons too soon after opening the door.	Wait a moment then try again.
	Dirt on the touch buttons.	Clean with a dry or slightly damp cloth.
	 If this symbol appears on the display, the door is not open enough.	Open the door until the display lights up.
	Child lock (button lock) activated.	See the section Settings.



Technical information

Technical data

Height:	34-3/8" - 36-1/2" (873-927 mm)
Width:	24" (610 mm)
Depth:	22-7/8" (581 mm)
Weight:	110 lb (50 kg) ¹⁾
Water pressure:	4.2–140 psi
Electrical connection:	See serial number tag and rating plate.
Rated power:	See serial number tag and rating plate.

¹⁾ *Weight can vary due to different specifications.*

LIMITED WARRANTY – RESIDENTIAL APPLIANCES

ASKO Distribution North America, LLC. (hereinafter "ASKO") warrants the original purchaser (the "ASKO Customer") of the ASKO product (the "ASKO Product"), who purchased the appliance from a distributor, dealer, manufacturer representative or other seller who has been authorized by ASKO ("Authorized ASKO Dealer"), that this ASKO Product is free of defects in material and workmanship, subject to the terms and conditions set forth herein. The limited warranty covers parts and labor, except as set forth in this Limited Warranty. Service must be provided by an ASKO designated service company. YOUR SOLE AND EXCLUSIVE REMEDY UNDER THIS LIMITED WARRANTY SHALL BE PRODUCT REPAIR AS PROVIDED HEREIN. The limited warranty is valid only in the United States or Canada and applies only when the appliance is used in the country in which it was purchased. Proof of original purchase date is required to obtain service under this limited warranty.

Residential ASKO Products Used Exclusively for Household/Personal Purposes:

Two (2) Years limited Warranty – Any warranty service claims for residential ASKO Products must be filed with ASKO within two (2) years from date of purchase.

Residential ASKO Products Not Used Exclusively for Household Purposes, used Commercially or Use in marine, Mobile or Aeronautical Applications:

One (1) Year limited Warranty – Any warranty service claims for ASKO Products not used exclusively for household and personal use, used commercially or used in marine, mobile, or aeronautical application must be filed with ASKO within One (1) year from date of purchase.

ITEMS EXCLUDED FROM WARRANTY

This limited warranty does not cover:

- 1 Replacement parts or repair labor if this appliance is used in a manner that is inconsistent to published user or operator instructions and/or installation instructions.
- 2 Service calls to correct the installation of your appliance, to instruct you on how to use your appliance, to replace or repair house fuses, or to correct house wiring or plumbing.
- 3 Consumable parts are excluded from warranty coverage.
- 4 Damage resulting from accident, alteration, misuse, abuse, fire, flood, acts of God, improper installation, installation not in accordance with electrical or plumbing codes, or use of products not approved by ASKO.
- 5 Cosmetic damage, including scratches, dents, chips or other damage to the finish of your appliance, unless such damage

results from defects in material or workmanship and is reported to ASKO within 5 days from date of purchase.

- 6 Pickup and delivery. This appliance is intended to be repaired in your home.
- 7 Repairs to parts or systems resulting from unauthorized modifications made to the appliance.
- 8 Expenses for travel and transportation for product service if your appliance is located in a remote area where service by an authorized ASKO servicer is not available.
- 9 The removal and reinstallation of your appliance if it is installed in an inaccessible location or is not installed in accordance with ASKO's published installation instructions.
- 10 Replacement parts or repair labor on appliances with original model/serial numbers that have been removed, altered or cannot be easily determined.

DISCLAIMER OF IMPLIED WARRANTIES

YOUR SOLE AND EXCLUSIVE REMEDY UNDER THIS LIMITED WARRANTY SHALL BE PRODUCT REPAIR AS PROVIDED HEREIN. ASKO SHALL NOT BE LIABLE FOR INCIDENTAL OR CONSEQUENTIAL DAMAGES. Some states and provinces do not allow the exclusion or limitation of incidental or consequential damages, so these limitations and exclusion may not apply to you. This warranty gives you specific legal rights, and you also may have other rights that vary from state to state or province to province.

If you think you need repair service, first see the "Trouble Shooting" section of the Use & Care Guide. If you are unable to resolve after checking "Trouble Shooting" additional help can be found by calling ASKO Customer Care at 1-800-898-1879











Read chapter Troubleshooting before contacting the Customer Care Center. Make a note of the details on the rating plate positioned on the right inside the dishwasher. Make a note of the service number (1), item number (2) and serial number (3).



Should you need further assistance, contact us at the address below:

ASKO Distribution North America, LLC.
Customer Care Center
PO Box 44848
MADISON WI 53744

Program chart

Program	Options	Prewashes	Main wash (°F)	Number of rinses	Final rinse temperature (°F)	Consumption values ¹⁾						
						Cold water ²⁾			Hot water ³⁾			Water consumption (gallon)
						Wash time (approx. hours:minutes)	Energy (approx. kWh)	Wash time (approx. hours:minutes)	Energy (approx. kWh)			
 Sanitation	-	2	140	3	140	3:40	1.5	3:10	0.7	5.2		
 Normal ⁴⁾	-	1	130	2	120	2:10	1.0	2:00	0.5	3.7		
 Normal		2	150	3	150	2:35	1.6	2:10	0.9	4.7		
 Heavy	-	1	140	2	150	2:00	1.4	1:40	0.8	3.5		
 Quick	-	0	85	2	-	0:20	0.2	0:20	0.1	2.7		
 Super Quick	-	0	85	2	-	0:15	0.2	0:15	0.1	2.7		
 Eco Eco	-	1	120	2	120	2:30	0.9	2:20	0.5	3.2		
 Rinse & Dry		0	-	1	120	0:50	0.5	0:40	0.3	0.9		
 Rinse & Hold	-	0	-	1	-	0:06	0.01	0:04	0.01	0.9		

1) Consumption values vary depending on the temperature of the incoming water, room temperature, load size, selected additional options, and more.

2) Connection to cold water, approx. 50 °F (10 °C).

3) Connection to hot water, approx. 120 °F (50 °C).

4) The energy label performance figures are based on this program.

Quick guide

1.

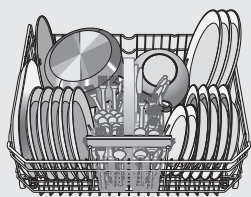

Load the baskets (see page 5)

Do not rinse dishes under running water before loading them in the dishwasher. Simply scrape off large food particles before loading the dishwasher.

2.

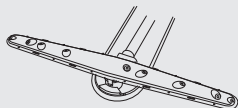

Check that the spray arms can rotate freely

Check also that the water supply valve is on.

3.

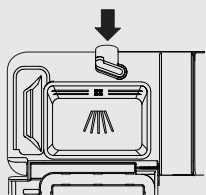

Add detergent (see page 7)

The detergent compartment has one smaller compartment for the prewash and one for the main wash.

4.



Press and hold the On/Left-on mode button  until the display lights up

5.



Select a program and any options (see page 7)

Two minutes after the last button press, the panel backlight enters energy saving mode. Close and reopen the door, or press the On/Left-on mode button, to reactivate the panel.

6.



Press and hold Start/Stop and close the door (see page 8)

ASKO

Swedish quality since 1950

www.askona.com



en (03-14)