

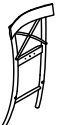

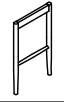





Assembly Instruction for (D680-21) Barstool-Beach/ Natural Metal LCL100BST

Caution: Please read instructions thoroughly before unpacking assembly parts. Sharp, exposed staple tips can cause injury, therefore, for your protection, please remove any exposed staples used in packing.

1. We recommend that you should assemble this product with the assistance of another person; this will make assembly easier, and will help to eliminate damage to the product or injury to persons during assembly.
2. Be sure to check all packing materials carefully for small parts that may have come loose inside the carton during shipment.
3. Please do not over tighten screws or bolts.
4. Please put all parts on a non-abrasive floor before assembly, and follow the assembly steps to assemble your newly purchased product correctly and efficiently.

| PARTS LIST: | | | | |
|-------------|-------------|---|---------------|-----|
| NO. | DESCRIPTION | SKETCH | PART CODE. | QTY |
| A | Back Frame |  | PLCL100BSTBFR | 1 |
| B | Front Leg |  | PLCL100BSTLEG | 1 |
| C | Seat |  | PLCL100BSTSEA | 1 |
| D | Stretcher |  | PLCL100BSTSTR | 2 |

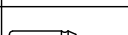
| HARDWARE LIST: | | | | |
|----------------|--|---|--------------|-----|
| NO. | DESCRIPTION | SKETCH | PART CODE. | QTY |
| 1 | Allen Bolt (1/4 x 3 1/2") |  | PLCL100BSTHW | 8 |
| 2 | Allen Bolt (1/4 x 2") |  | | 4 |
| 3 | Lock Washer (1/4 x 2/5" x 2mm) |  | | 12 |
| 4 | Flat Washer (1/4 x 5/8" x 2mm) |  | | 12 |
| 5 | Wood Screws (1/8 x 2") |  | | 4 |
| 6 | Allen Key (1/8") |  | | 1 |
| 7 | Phillips Screwdriver (Not provided) |  | | 1 |

Step 1

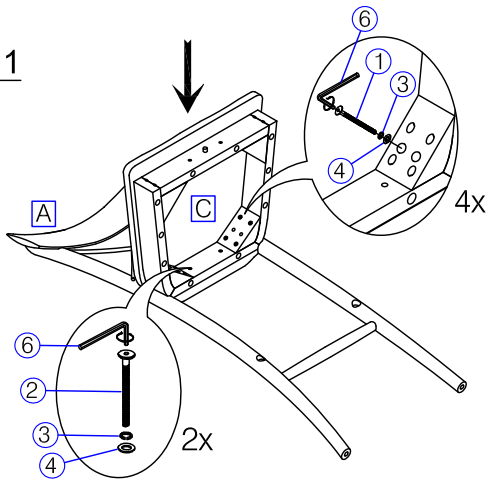

Step 2

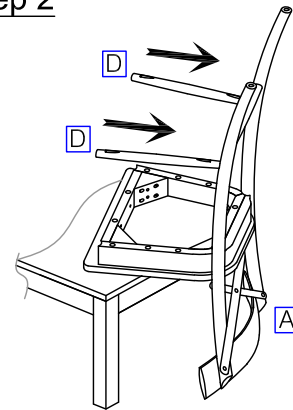

Step 3

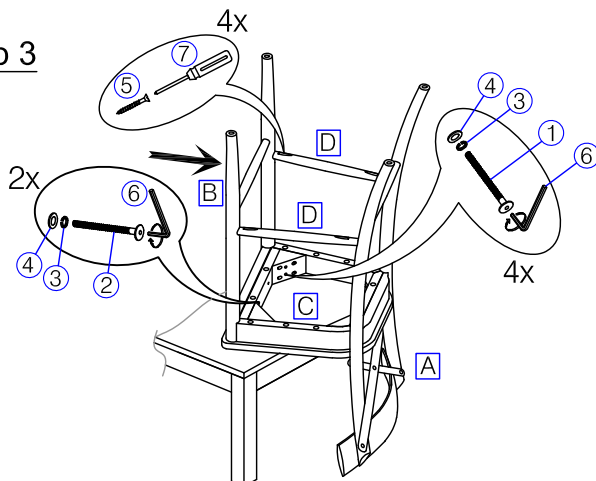

Step 4

