



Thank you for purchasing this quality product. Be sure to check all packing material carefully for small parts that may have come loose inside the carton during shipment

Key Parts			
No	Code	Qty	Description
1	252-28P24	1 pc	Table Top
2	252-28P02	4 pcs	Table Leg
3	252P01F	4 pcs	Floor Glide
4	252-28P26	4 pcs	Corner Block
5	252-28P01H	6 sets	Hinge
6	252-28P36	4 pcs	Leaf Support

Hardware kit 252-28P01			
No		Description	Qty
A		Flat washer	8 pcs
B		Lock washer	8 pcs
C		Nut $\varnothing 8$	8 pcs
D		Key wrench	1 pc

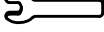
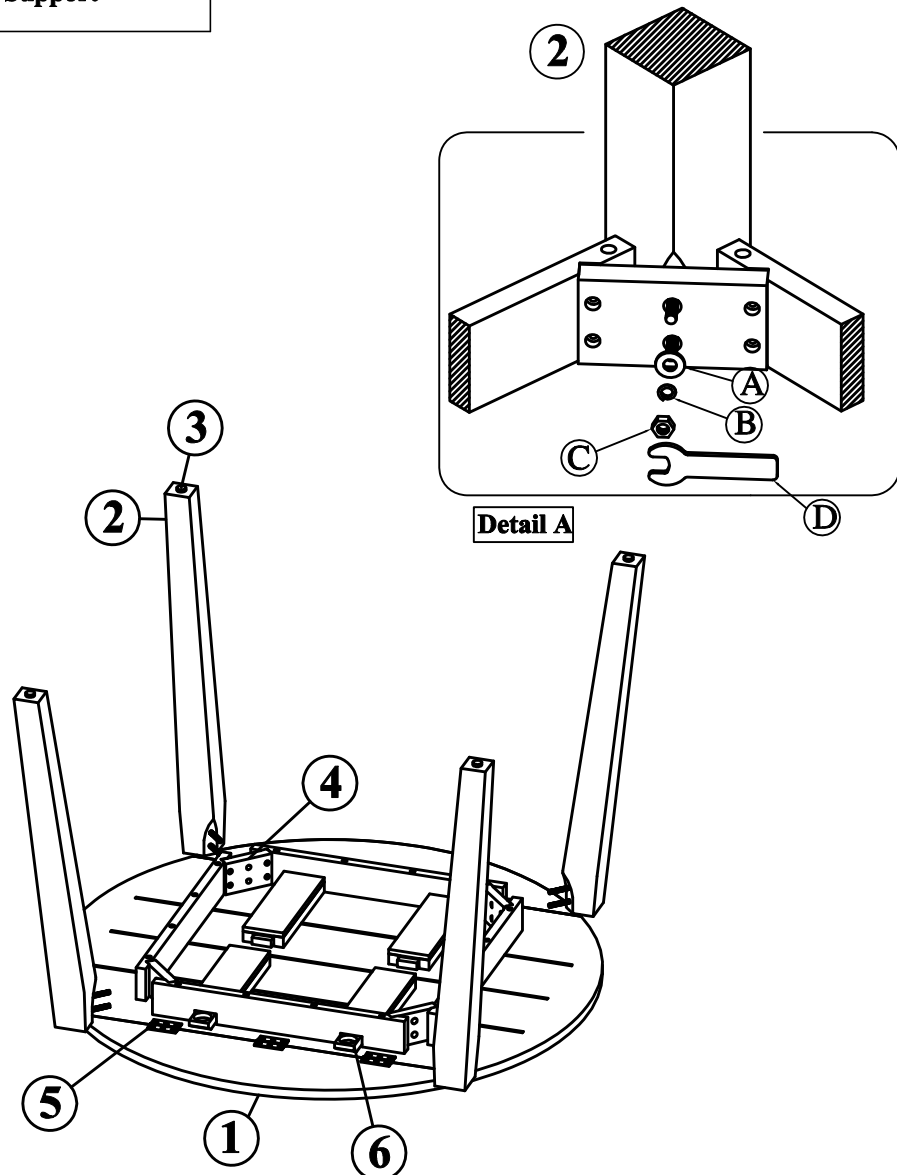

STEP 1

- Carefully lay Table Top upside down on a smooth flat surface to prevent scratches.
- Attach each Leg to each corner of the Table Top as shown in illustration. Insert a Flat Washer, Lock Washer and Nut on to the insert nut of each Leg
- Once all Legs are in place, fully tighten nuts by turning clockwise using provided Key Wrench until secure.