





Thank you for purchasing this quality product. Be sure to check all packing material carefully for small parts that may have come loose inside the carton during shipment

Key Parts			
No	Code	Q'Ty	Description
1	1959-84P24	1 pc	Table Top
2	1959-84P02	4 pcs	Table Leg
3	1959-84P01A	4 pcs	Apron Spacer
4	1959-84P01F	4 pcs	Floor Glide
5	1959-84P13	2 sets	Extension Mechanism
6	1959-84P13L	4 sets	Extension Lock
7	1959-84P36S	4 pcs	Metal Leaf Support
8	1959-84P26	4 pcs	Corner Block

Hardware kit 1959-84P01			
No		Description	Q'Ty
A		Flat washer 5/16"	8 pcs
B		Lock washer 5/16"	8 pcs
C		Nut 5/16"	8 pcs
D		Key wrench	1 pc

Two persons required to set up table

STEP 1

- Carefully lay Table Top upside down on a smooth flat surface to prevent scratches.
- Affix each Leg to each corner of the Table Top as shown in illustration. Insert a Flat Washer, Lock Washer and Nut on to the bolts of each Leg
- Once all Legs are in place, fully tighten nuts by turning clockwise using provided Key Wrench until secure. (See Detail A)

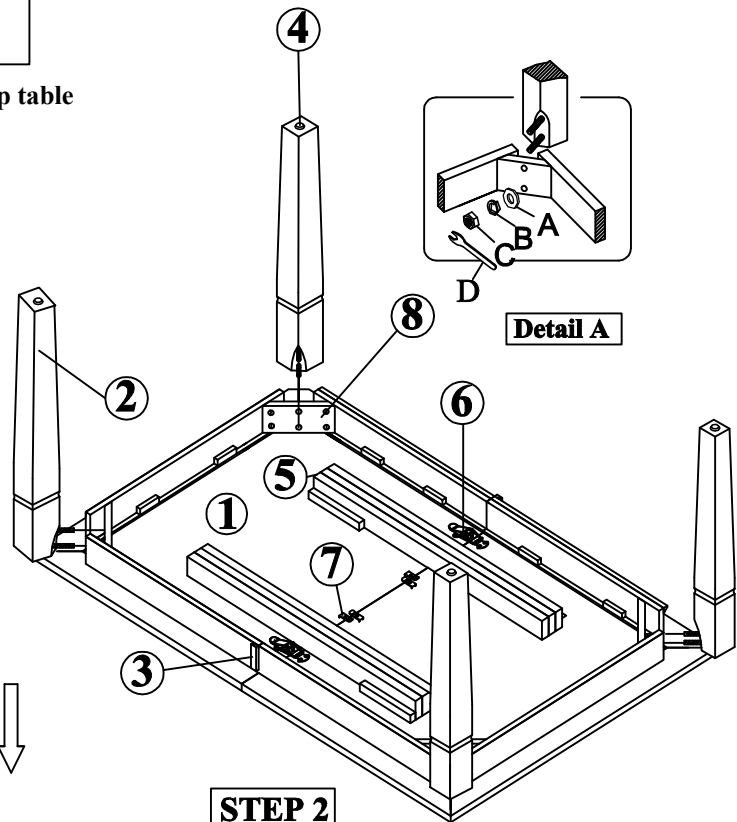

STEP 2

Fully extend both sides of the table and carefully place the removable leaf in place lining up the pins and holes with the table top. Reverse procedure for storage.

