











ITEM NO : 272 - BR13

**DESCRIPTION : QUEEN PANEL HEADBOARD
W/LIGHT**

Thank you for purchasing this quality product. Be sure to check all packing material carefully for small parts which may have come loose inside the carton during shipment. Identify and count all parts and compare with the parts list below :

PART LIST		
ITEM	DESCRIPTION	QTY
1	HEADBOARD PANEL W/LIGHTS 	1PC
2	LEFT HEADBOARD LEG 	1PC
3	RIGHT HEADBOARD LEG 	1PC

4 ASSEMBLY HARDWARE PACK FOR HEADBOARD		
ITEM	DESCRIPTION	QTY
A	JCBB SCREW M8 x 40mm 	6pcs
B	SPRING WASHER 5/16 x 15mm 	6pcs
C	FLAT WASHER 5/16 x 22mm 	6pcs
D	ALLEN KEY M5 	1pc
E	ADAPTOR 	1pc

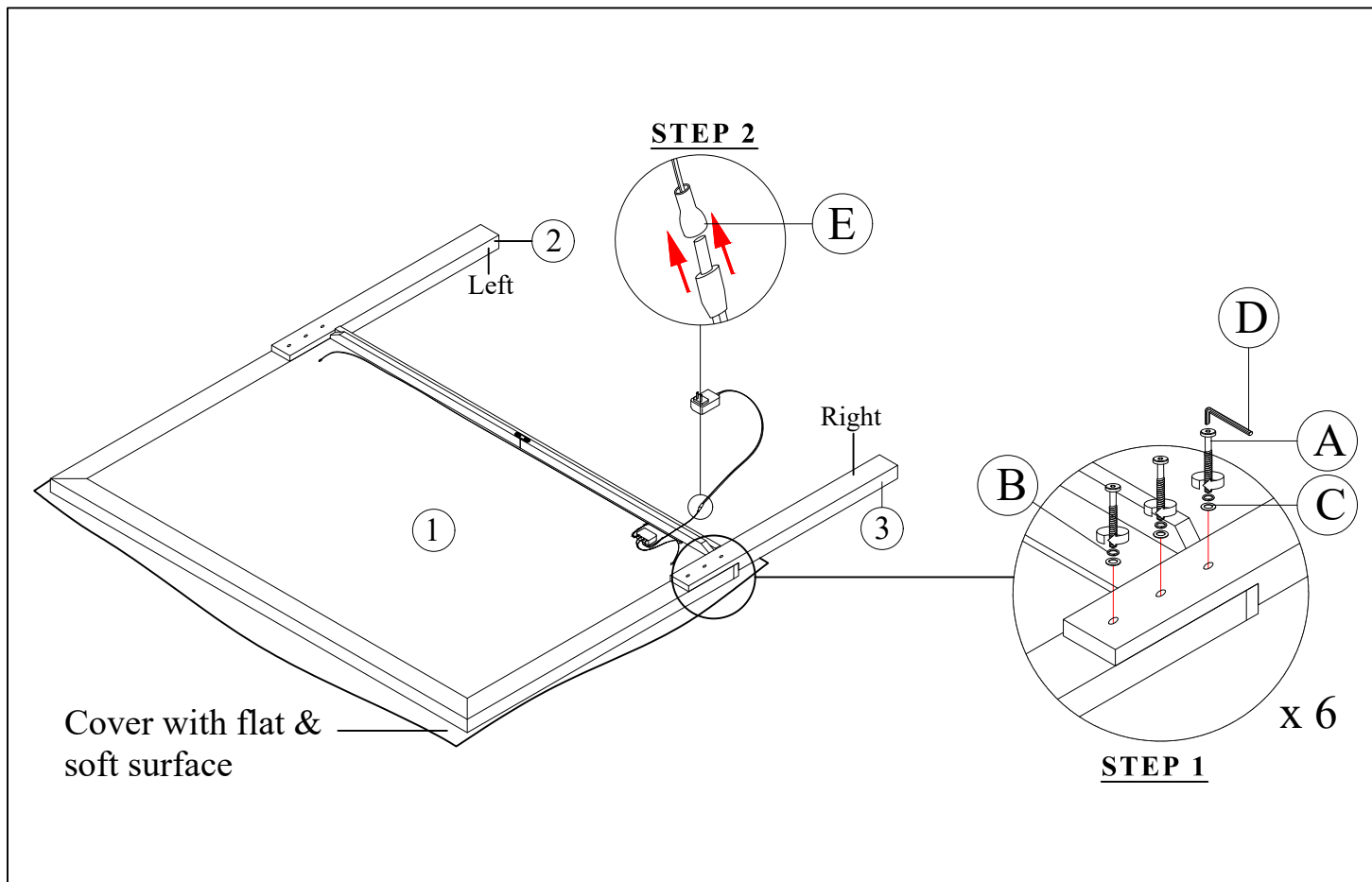

ASSEMBLY TIPS :

1. Remove hardware from box and sort by size.
2. Please check to see that all hardware and parts are present prior start of assembly.
3. Please follow attached instructions in the same sequence as numbered to assure fast and easy assembly.



WARNING !

1. Don't attempt to repair or modify parts that the broken or defective. Please contact the store immediately.
2. This product is for home use only and not intended for commercial establishments.