

# Café™ 36" All Gas Professional Range with 6 Burners (Natural Gas)

CGY366P4MW2 /CGY366P2MS1 / CGY366P3MD1

# CAFÉ

DISTINCT BY DESIGN™



ALSO AVAILABLE IN

CGY366P2MS1  
Stainless Steel with Brushed Stainless handle and knobs

CGY366P3MD1  
Matte Black with Brushed Stainless handle and knobs



## FEATURES & BENEFITS

Whip up an unforgettable meal with a **professional oven system** that combines reverse-air convection technology with an infrared broil and gas burner to provide superb baking results and fast preheating.

Enjoy a full range of heat settings from ultra-low simmers to intense boils, with **six sealed 18K BTU dual stack burners**.

Experiment with every cuisine with reversible burner grates that are flat on one side and contoured on the other to accommodate round-bottom cookware like woks.

Bake more batches at once with a **6.2 cu. ft. capacity caterer's oven** that can fit up to three full-size sheet trays.

Smoothly slide heavy roasts in and out of the oven with **full-extension, heavy-duty roller racks** that can also stay in the oven during self-cleaning cycles.

Confidently cook over a steady flame with the **electronic ignition's automatic reignition** feature that instantly revives any accidentally extinguished flames.

Observe sacred days with **Star-K certification**.

## APPEARANCE

Color Appearance	Matte White
Cooktop Burner Grate Color	Matte Black
Oven Door Features	Big Clear View Oven Window
Handle Design	GE Café
Control Knobs	Dishwasher Safe; Professional-Style

## FEATURES

Configuration	6 Burners
Cooking Technology	Convection
Oven Cleaning Type	Self-Clean
Burner - Left Front	18,000 BTU
Burner - Left Rear	18,000 BTU
Burner - Right Front	18,000 BTU
Burner - Right Rear	18,000 BTU
Burner - Center	18,000 BTU Front / 18,000 BTU Rear
Cooktop Burner Type	Sealed
Cooktop Surface	Porcelain-Enamel; Gray
Dishwasher Safe Knobs	Yes
Control Location	Front controls
Control Type	Digital Temperature Display with Timer Display
Valves (Degree of Turn)	270
Oven Control Features	Audible Preheat Signal; Auto Oven Shut-Off with Override; Auto Self Clean; Certified Sabbath Mode; Electronic Timer; Front Controls; In-Oven Broiling; Temperature Probe; Proof Mode; Self-Clean Cool Down Time Display
Oven Cooking Modes	Convection Bake; Convection Broil; Convection Roast
Temperature Management System	True Temp System
Cooktop Burner Grate Features	Heavy-Cast Edge-to-Edge Grates
Cooktop Burner Grate Material	Heavy Cast
Cleaning Time	Variable
Oven Rack Features	1 Self-Clean Roller Rack; 2 Self-Clean Flat Oven Racks; 5 Rack Positions
Fuel Type	Natural Gas (factory set)
Ignition System	Electronic w/Auto Reignition
Leveling System	4 Leveling Legs
Style	Commercial
Oven Interior	6 Halogen; Blue
Cooking System	Reverse Air Convection

## CAPACITY

Total Capacity (cubic feet)	6.2 cu ft
-----------------------------	-----------

## ACCESSORIES

LP Conversion Kit	Included
-------------------	----------

## WEIGHTS & DIMENSIONS

Depth with Door Open	43 7/8 in
Approximate Shipping Weight	462 lb
Net Weight	417 lb
Overall Height	35-1/4 in
Height to Cooking Surface (in.)	35-3/4 - 36 1/2
Overall Width	35-7/8 in
Cabinet Width	36 in
Overall Depth	30-3/4 in
Depth Without Handle	26-7/8 in
Oven Interior Dimensions (W x H x D) (in.)	28-1/4 x 16-3/8 x 19

# Café™ 36" All Gas Professional Range with 6 Burners (Natural Gas)

CGY366P4MW2 /CGY366P2MS1 / CGY366P3MD1

# CAFÉ

DISTINCT BY DESIGN™

## POWER / RATINGS

Top Burner BTU Rating - LP (000's BTU's)	(6) 15.0
Top Burner BTU Rating - Nat. Gas (000's BTU's)	(6) 18.0
Volts/Hertz/Amps	120v; 60Hz; 15A
Bake/Broiler BTU Rating - LP (000's BTU's)	23.0 Bake / 15.0 Broil
Bake/Broiler BTU Rating - Nat. Gas (000's BTU's)	24.5 Bake / 17.0 Broil

## WARRANTY

Parts warranty	Limited 1-year entire appliance
Labor warranty	Limited 1-year entire appliance
Warranty notes	See written warranty for full details

## DIMENSIONS AND INSTALLATION

**Electrical Requirements:** Ranges must be hooked up to a 120V, 60Hz properly grounded dedicated circuit protected by a 15-amp circuit breaker or time-delay fuse.

**GAS SUPPLY:** The natural gas models are designed to operate at 5" water column pressure. For proper operation, the pressure of the natural gas supplied to the regulator must be between 7" and 13" water column.

The LP models are designed to operate at 10" water column pressure. For proper operation, the pressure of the LP gas supplied to the regulator must be between 11" and 13" water column.

**Optional Backsplash Accessories:** The range requires a 12" minimum clearance to a vertical combustible surface at the rear. A backsplash is required for installations with less than 12" clearance. The following backsplash accessories are available, or a custom, non-combustible backsplash can be used.

Order one with a 36"-wide range backsplash  
 UX12B36PSS – 12" backsplash  
 UXADJB36PSS – 30"-36" adjustable-height  
 backsplash with warming shelf

**NOTE:** Professional ranges offer a number of choices in size and cooktop configurations. All Professional Ranges are factory set for natural gas. Conversion kits are included with the range. High Altitude kit, WB28K10553 for operation above 6,000 feet (for Natural and LP gas models), is also available. The kits must be installed by a qualified service technician at additional cost.

**Installation Information:** Before installing, consult installation instructions packed with product or online at [geappliances.com](http://geappliances.com) for current dimensional data.

A suitable 36" or wider vent hood is required for installation over ranges with a grill and recommended for all other ranges.

**Advance Planning:** Refer to dimensional drawings for appropriate placement and necessary clearances when planning the installation.

- Working areas adjacent to the range should have 18" minimum clearance between countertop and cabinet bottom.

- Clearance between range and side wall or combustible material must be at least 12" on each side.

- Installation must conform with local codes. In the absence of local codes, the range must comply with the National Fuel Gas Code, ANSI Z223.1-1990.

**WARNING:** Installations without a hood require 48" minimum to combustibles. A custom hood installation with exposed horizontal combustible surfaces must have an Auto-On feature. Refer to hood installation instructions for specific hood clearances.

The surface of the entire back wall above the range and below the hood must be covered with a non-combustible material such as metal, ceramic tile, brick, marble or other stone.

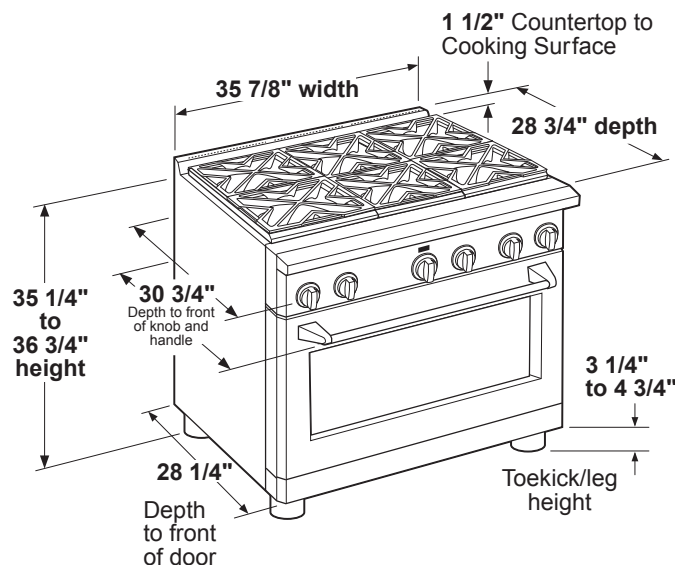

# Café™ 36" All Gas Professional Range with 6 Burners (Natural Gas)

CGY366P4MW2 / CGY366P2MS1 / CGY366P3MD1

# CAFÉ

DISTINCT BY DESIGN™

## UNIVERSAL UTILITY LOCATIONS

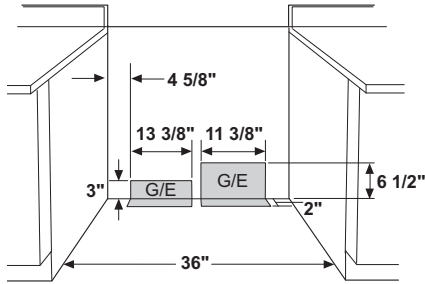

## SIDE VIEW WITH BACKSPLASH

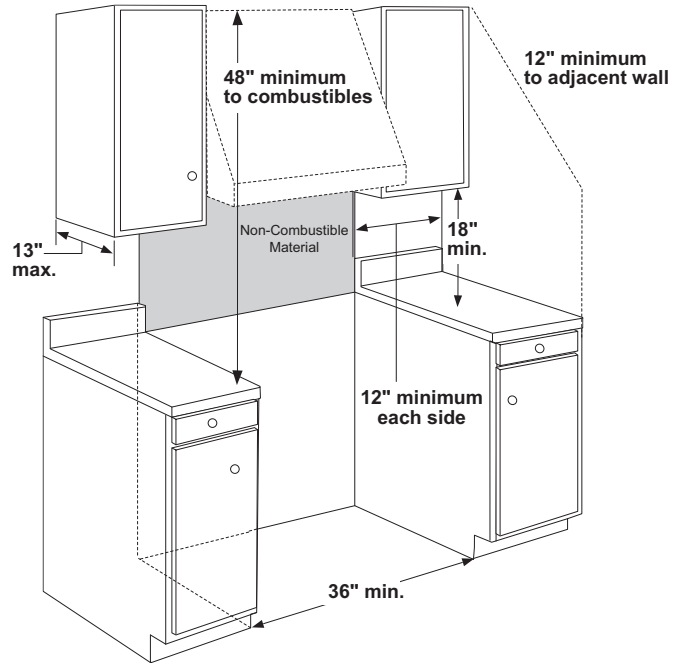
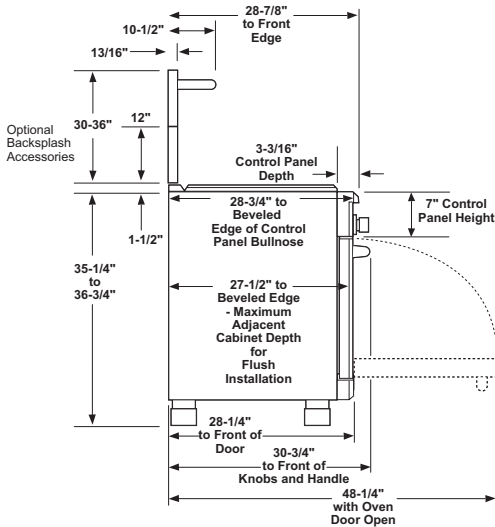

## ADDITIONAL CLEARANCES

Allow 12" minimum clearance to an adjacent wall on each side. Working areas adjacent to the rangetop should have 18" minimum clearance between countertop and the bottom of the wall cabinet.

## ADDITIONAL ACCESSORIES



CXPR6HKPMBZ  
Brushed Bronze  
1 handle, 8 knobs  
(standard on Matte White)



CXPR6HKPMSS  
Brushed Stainless  
1 handle, 8 knobs  
(standard on Matte Black)



UXADJB36PSS  
30"-36"H Stainless Steel  
Adjustable Height  
Backsplash with Shelf



CXPR6TKPMWS  
Matte White Toe Kick



CXPR6TKPMDS  
Matte Black Toe Kick



CXPR6HKPMBT  
Brushed Black  
1 handle, 8 knobs



CXPR6HKPMCU  
Brushed Copper  
1 handle, 8 knobs



UX12B36PSS  
12"H Stainless Steel  
Backsplash



CXPR6TKPMSS  
Stainless Steel Toe Kick