

PROPANE CONVERSION INSTRUCTIONS

⚠ WARNING This conversion must be performed by a qualified installer or gas supplier in accordance with the manufacturer's instructions and all codes and requirements of the authority having jurisdiction. Failure to follow ALL instructions could result in serious injury or property damage. The qualified agency performing this work assumes responsibility for the conversion.

The pressure regulator and the burner orifices are set for natural gas. To use propane gas, the regulator and burner orifices must be converted.

⚠ WARNING Do not operate the cooktop or oven burners of this range when using propane (bottled) gas before converting the pressure regulator and burner orifices for propane gas use. Failure to do so could cause high flames and toxic fumes which can result in serious injury.

The propane orifices for the cooktop burners are shipped on the back of the range in the location shown.

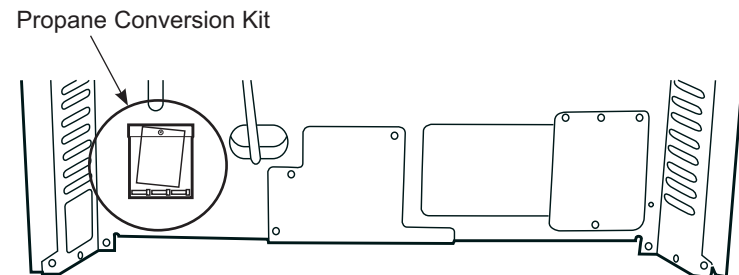

TOOLS REQUIRED:

- Adjustable wrench
- Socket wrench with 1/2" socket and extension
- Phillips head screwdriver
- Flat bladed screwdriver (blade approximately 3/32" across)
- Nut drivers: 1/4", 9/32" or 7mm

To adjust your range for use with propane gas, follow these instructions:

1. Disconnect all electrical power, at the main circuit breaker or fuse box.
2. Shut off the gas supply to the range by closing the manual shut-off valve.

CONVERTING THE PRESSURE REGULATOR

Remove the warming drawer and panel behind drawer. The pressure regulator is located in the lower, left hand rear corner of the range as viewed from the front.

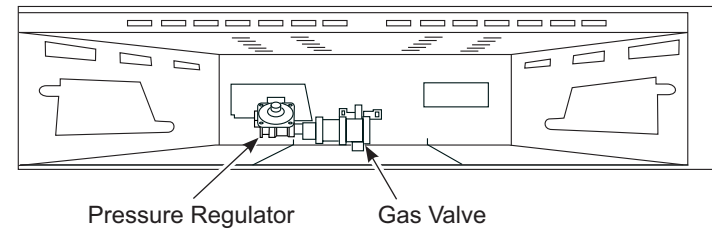

A. If this is your regulator:

1. Use an adjustable wrench to unscrew the hex-nut cap from the pressure regulator.
2. Completely remove the protective plastic cap off the threaded metal cap.

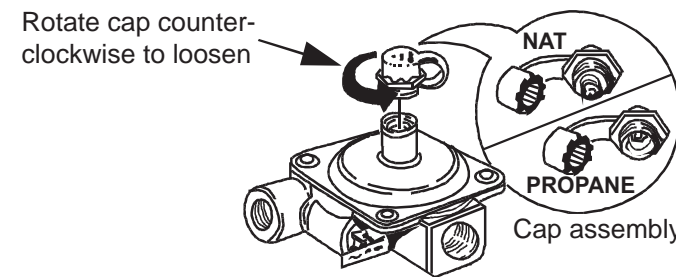

Regulator style A

3. Turn the metal cap so the type of gas being converted to is displayed and replace the protective plastic cover.
4. Screw the hex-nut cap back into the regulator. **(Do not over tighten)**

B. If this is your regulator:

1. Use an adjustable wrench to unscrew the hex-nut cap from the pressure regulator.
2. Turn the plastic cap 1/4 turn to disassemble.

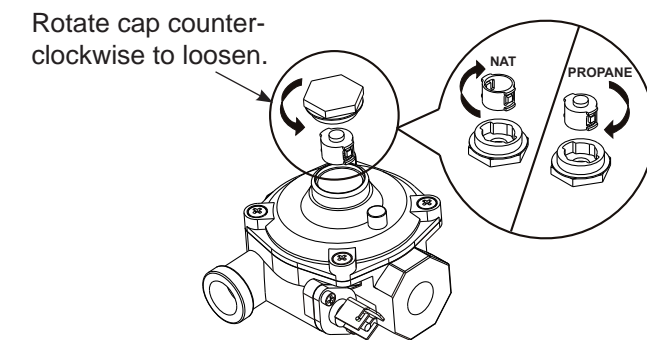

Regulator style B

3. Turn the plastic cap over and hook it into the slots. Rotate cap 1/4 turn to reassemble. The type of gas to be used should now be visible on the top of the cap.
4. Screw the hex-nut cap back onto the pressure regulator.

CONVERTING THE COOKTOP BURNERS

A. Remove the top grates, burner caps and burner heads.

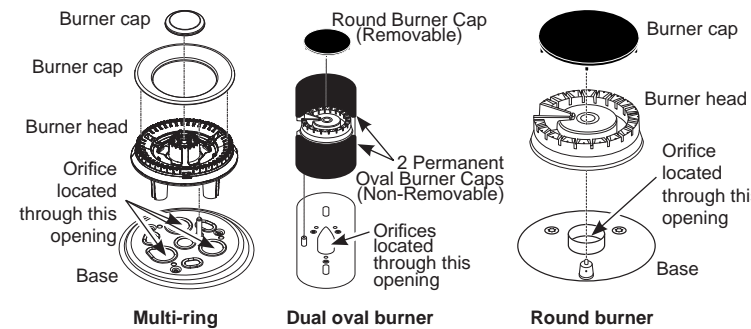

B. Using a 7 mm or 9/32" nut driver, remove the top burner orifices. These may be accessed through the burner opening in the base.

NOTICE:

Save these orifices for future conversion back to natural

C. Remove the propane orifices from the box provided. The propane orifices have the letter "L" on the top. To aid in identifying the proper location for the propane orifices during conversion from Natural Gas to Propane Gas, color codes have been added to the side or top of the orifice. See the chart below. Each orifice may also show a series of engraved marks (I, II, III . . .) located on the top.

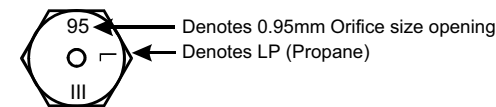

| BURNER OUTPUT RATINGS: BTU/HR | | | | |
|-------------------------------|----------|-------------------|-------------|---------|
| Propane Gas 10" W.C.P. | | | | |
| BURNER | BTU RATE | ORIFICE SIZE (mm) | COLOR | MARKING |
| LF | 15,000 | | | |
| LF1 | N/A | 0.025" (0.63) | Blue/Blue | 63L |
| LF2 | N/A | 0.025" (0.63) | Blue/Blue | 63L |
| LF3 | N/A | 0.025" (0.63) | Blue/Blue | 63L |
| LFC | N/A | 0.016" (0.35) | None | 40L |
| RF | 18,000 | 0.047" (1.19) | Red/Orange | 119L |
| LR | 5,000 | 0.026" (0.66) | Red/Yellow | 66L |
| RR | 9,500 | 0.035" (0.89) | Blue/Brown | 89L |
| C | 10,000 | | | |
| C1 | N/A | 0.035" (0.89) | Blue/Brown | 89L |
| C2 | N/A | 0.033" (0.84) | Brown/Green | 84L |
| BAKE | 16,000 | 0.047" (1.19) | Orange | .047 |
| BROIL | 12,000 | 0.041" (1.04) | Red | 041L |

D. Install the propane orifices in their precise locations.

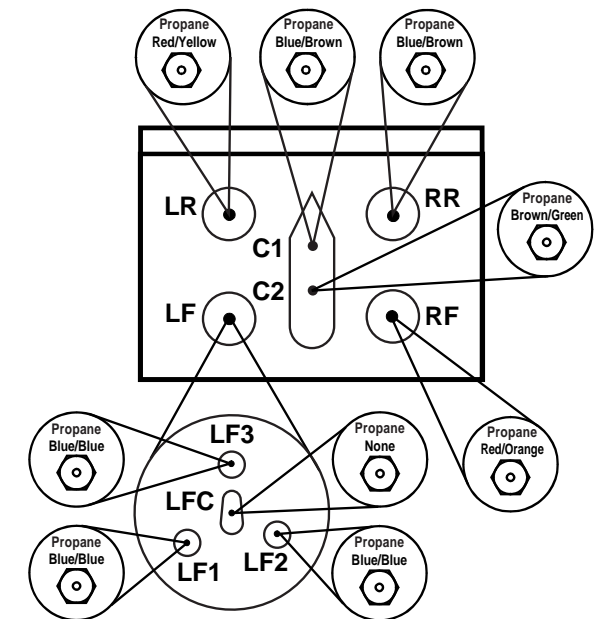

To prevent leakage, make sure the orifice spuds are securely screwed into the gas supply tubes.

E. Install the old orifice spuds into the metal box or bracket along with these instructions, and replace onto the back of the range for possible future conversion.

CONVERTING THE OVEN BURNERS

NOTICE:

This product cannot be converted to propane by adjusting the oven orifices. The orifices must be replaced for propane.

BAKE BURNER ORIFICE

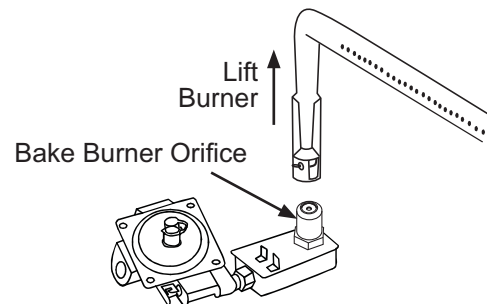

1. Remove oven racks, door and oven bottom. Remove the 1/4" hex screws securing the bake burner.
2. The bake burner orifice is on the gas valve located behind the warming drawer. Lift the burner off the orifice and apply a 1/2" socket on an extension to the hex base of the orifice on the gas valve. Loosen the orifice by turning counter-clockwise and remove.

NOTICE:

Save these orifices for future conversion back to natural gas.

3. Select the propane bake orifice from the kit and install it on the gas valve. Tighten until snug.

BROIL BURNER ORIFICE

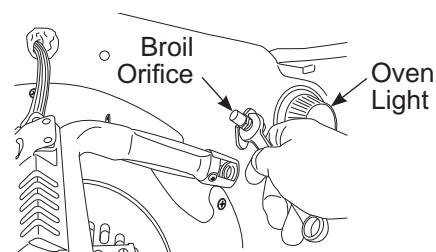

1. Remove the 1/4" hex screw securing the broil burner and allow it to hang down free of the broil orifice.
2. Apply a 1/2" wrench to the hex base of the orifice. Loosen the orifice by turning counter-clockwise and remove.
3. Select the propane broil orifice from the kit and install it on the broil elbow. Tighten until snug.
4. Replace the broil burner over the orifice and replace the screw securing the burner.

ADJUSTING AIR SHUTTER SETTINGS FOR OVEN BURNERS

1. With a Phillips head screwdriver, loosen the screws securing the air shutter on the bake burner. Adjust the air shutter to fully open.
2. Turn on the gas.
3. Turn on the electricity.
4. Reinstall the oven door.
5. Turn on the bake burner.

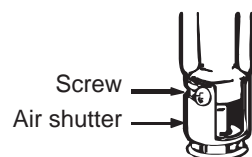

Oven burner flame must be observed with the door closed to properly check flame characteristics.

6. As you watch the flame with the oven door closed, check the following through the oven door window.
 - a. If the flames are yellow, open the air shutter more.
 - b. If the flames blow away or flutter from the burner, close the air shutter slightly.
7. Turn bake burner off and repeat with broil burner.

WARNING

If you attempt to measure the inner cone of the flame, please use caution: burns could result.

8. Checking the flame size: It should be approximately 1/2" to 3/4" long for the bake and broil burners.

The combustion quality of the burner flames needs to be determined visually.

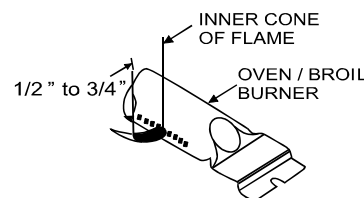

NOTE: If burner flames look like (A), further air shutter adjustment to the bake burner is required. Normal burner flames should look like (B) or (C), depending on the type of gas you use. With propane gas, some yellow tipping on the outer cones is normal.

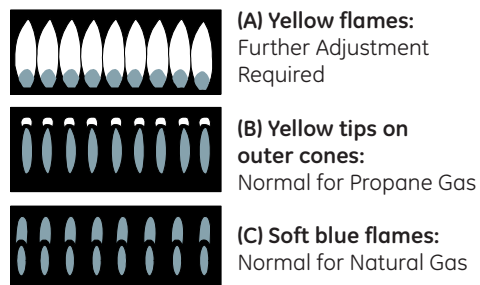

Foreign particles in the gas line may cause an orange flame at first, but this will soon disappear.

9. When all adjustments are made and the results are satisfactory:
 - a. Retighten the air shutter screws.
 - b. Replace the oven bottom.
 - c. Replace the storage drawer.

ADJUSTING LOW FLAME SETTING ON COOKTOP BURNERS

Low setting adjustments must be made with other burners in operation on a medium setting. This procedure prevents the low flame from being set too low, resulting in the flame being extinguished when other burners are turned on.

- A. Turn on all surface burners to medium setting.
- B. Turn the knob on the burner being adjusted to "LO".
- C. Remove the knob and insert a small, flat blade screwdriver into the valve shaft and/or side adjustment screw(s) as shown and turn clockwise to fully tighten down the bypass screw(s). Repeat for all valves.

- D. If flame appears too low or unstable, slowly turn bypass screw counterclockwise until a stable flame exists for each burner. Remember, other burners must be turned on to medium.

SPECIALTY BURNERS

Dual Oval Burner – This burner should be properly adjusted with both bypass screws completely screwed in.

Multi-Ring Burner – The outer ring of flames should be adjusted with the knob at the MED by adjusting the set screw in the center valve shaft. The flames should be adjusted so that they barely curl over the top edge of the burner cap. The center ring of flames should be adjusted with the knob at the LO setting by adjusting the set screw to the right of the valve shaft.

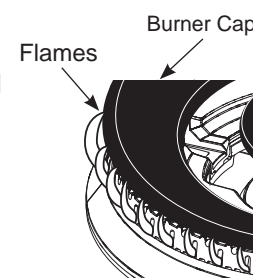

- E. Additionally, for each burner being adjusted, quickly open and close the oven door while observing flame. If flame is extinguished, continue adjusting bypass screw for a larger flame. Repeat door openings until flame is stable.
- F. Replace the knob.

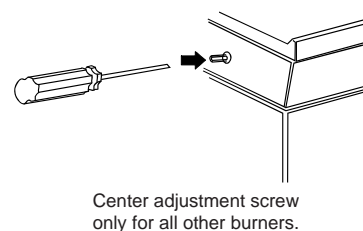
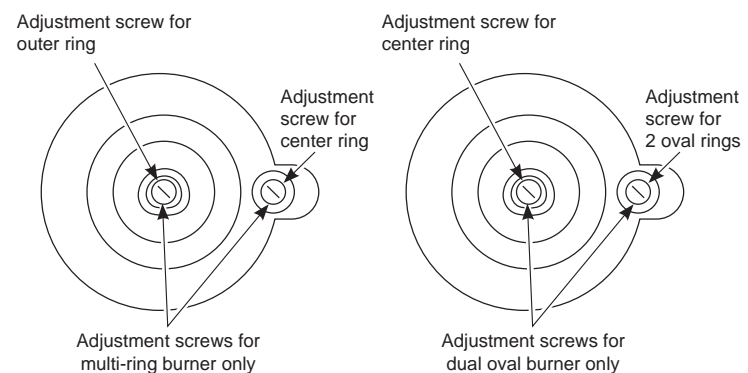

NOTICE:

Once the conversion is complete and confirmed, fill out the propane sticker and include your name, organization and date conversion was made. Apply the sticker to the range near the regulator to alert others in the future that this appliance has been converted to propane. If converting back to natural gas from propane, please remove the sticker so others know the appliance is set to use natural gas.

ADDITIONAL INFORMATION

BURNER OUTPUT RATINGS: BTU/HR

NG (Natural) Gas 5" W.C.P.

| BURNER | BTU RATE | ORIFICE SIZE (mm) | COLOR | MARKING |
|--------|----------|-------------------|--------------|---------|
| LF | 20,000 | N/A | | |
| LF1 | N/A | 0.043" (1.09) | Blue/White | 109N |
| LF2 | N/A | 0.043" (1.09) | Blue/White | 109N |
| LF3 | N/A | 0.043" (1.09) | Blue/White | 109N |
| LFC | N/A | 0.025" (0.63) | None | 63N |
| RF | 18,000 | 0.078" (1.98) | Purple | 198N |
| LR | 5,000 | 0.040" (1.01) | White/Purple | 101N |
| RR | 9,500 | 0.053" (1.36) | Green | 136N |
| C | 10,000 | | | |
| C1 | N/A | 0.055" (1.41) | Yellow | 141N |
| C2 | N/A | 0.053" (1.36) | Green | 136N |
| BAKE | 16,000 | 0.070" (1.78) | None | 50 |
| BROIL | 13,500 | 0.066" (1.67) | Red | 066N |

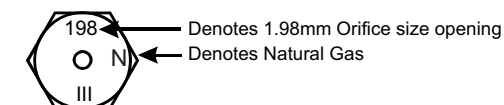

SPECIAL NOTE:

To convert the oven back to natural gas, reverse the instructions given in making propane adjustments.

PROPANE CONVERSION INSTRUCTIONS
31-10992-2 03-17 GEA
PGB930