

Bling Chandelier

HS524_

I.1



Fusion Jack™

GENERAL PRODUCT INFORMATION:



This product is suitable only for indoor dry locations and approved for use at any height above the finished floor.

Read through all the instructions before attempting installation.

CAUTION - RISK OF FIRE

This product requires installation by a qualified electrician. Before installing be sure to read all instructions and DISCONNECT POWER TO THE ELECTRICAL BOX.

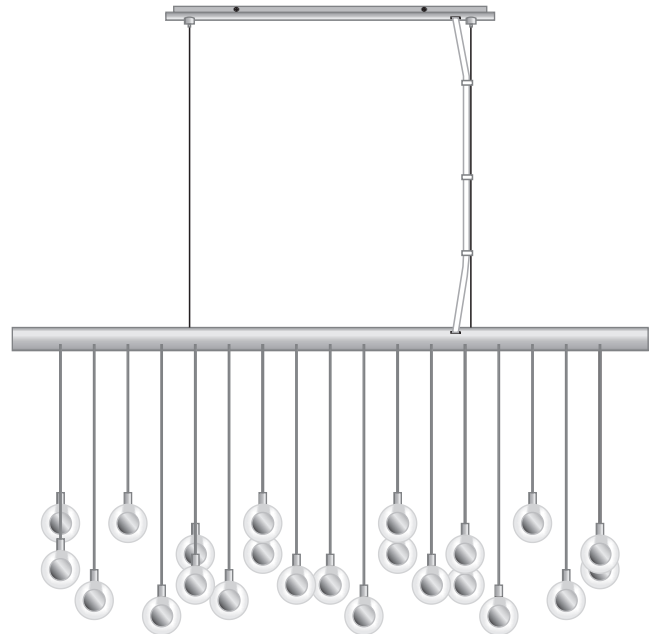

Mount the Backplate

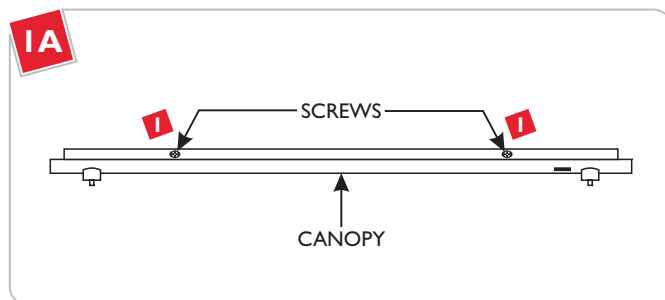

1 Remove all four screws from the sides of the canopy.

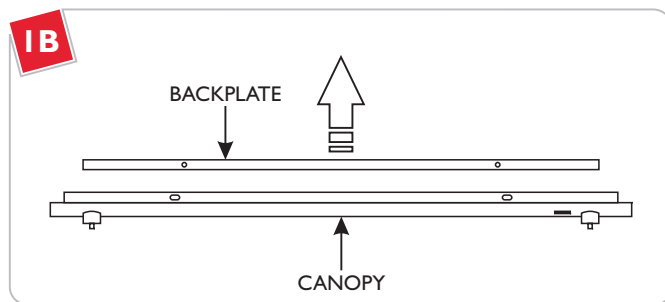

2 Lift the backplate out of the canopy.

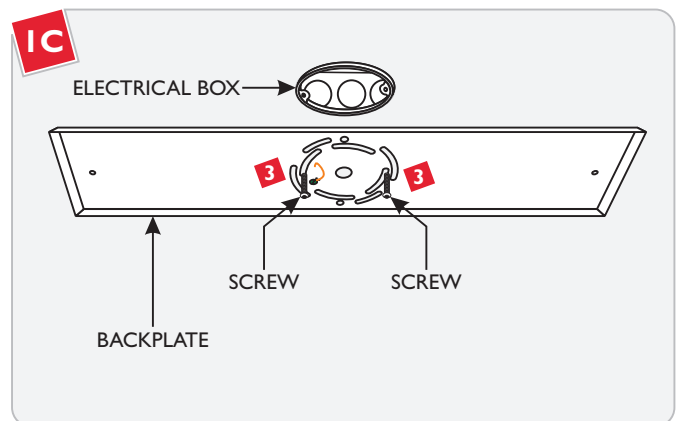

3 Line up the canopy as desired and mount the backplate to the electrical box with the two #8-32 button-head screws provided.

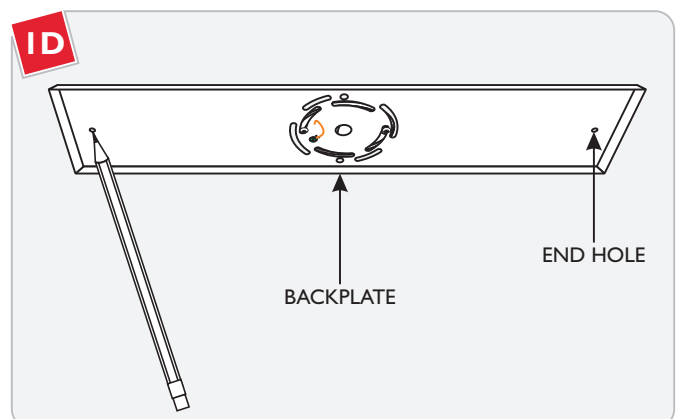

4 Mark the ceiling in the center of the backplate end holes.

5 Remove the backplate from the ceiling.

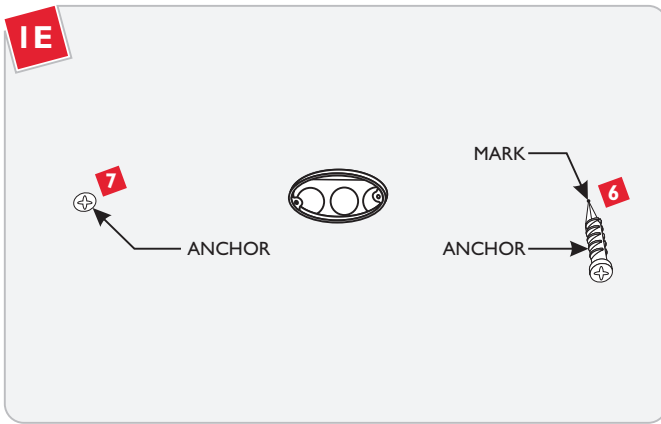

- 6** Line up an anchor tip with one of the marks on the ceiling, and push the anchor into the ceiling up to the threads.
- 7** Screw the anchor in the rest of the way with a screwdriver.
- 8** Repeat steps 6-7 for the other anchor.

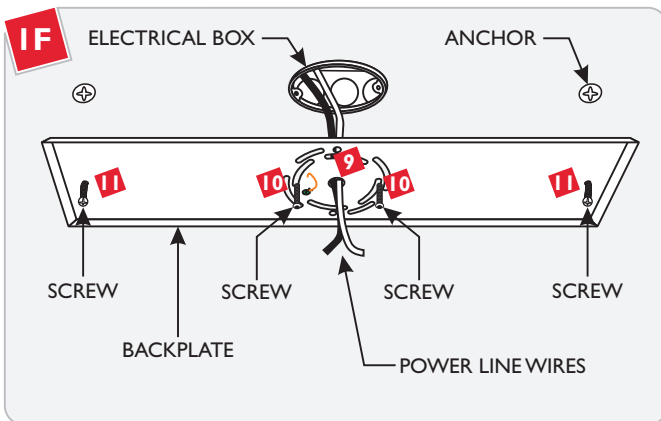

- 9** Feed the power line wires through the center backplate hole.
- 10** Mount the backplate to the electrical box with the two #8-32 button-head screws provided.
- 11** Secure the backplate to the anchors with the two countersunk-head screws.

Attach the Canopy and Boom

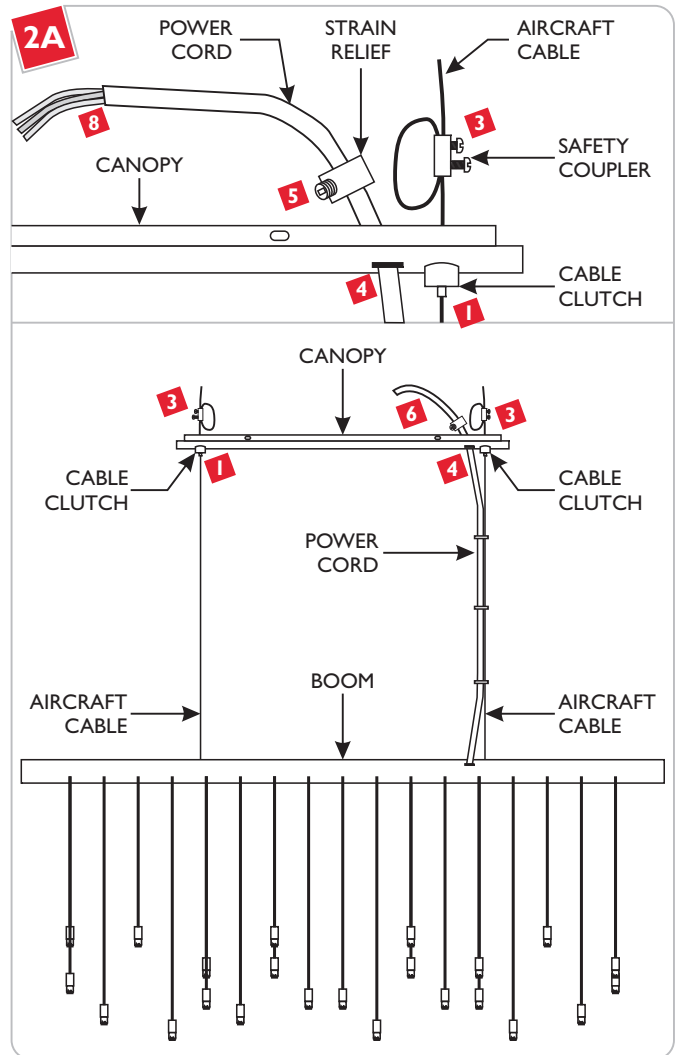

- 1** Feed the aircraft cables from the boom into the cable clutches in the canopy.
- 2** Adjust the aircraft cable to the approximate length desired.
- 3** Attach the safety coupler to each aircraft cable. Leave some extra length in the cable for later adjustment and cut off the excess cable.
- 4** Feed the power cord from the boom into the canopy port.
- 5** Slide the strain relief onto the power cord and tighten the screw. **Leave some slack:** The power cord is not intended to support the boom.
- 6** Leave at least 8" of the cord behind the canopy for power connections and cut the excess cord.
- 7** Remove the last 4" of the power cord insulation.
- 8** Strip 1/4" of the insulation from the wire ends.

Install the Lamp & Shade

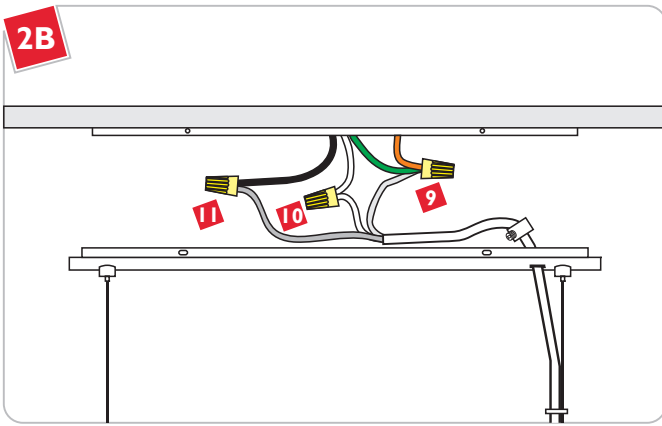

- 9** Connect the bare power cord wire and copper backplate wire to a suitable ground according to local electrical codes.
- 10** Connect the power cord wire with the white strip to the neutral power line wire with a wire nut.
- 11** Connect the other power cord wire to the hot power line wire with a wire nut.

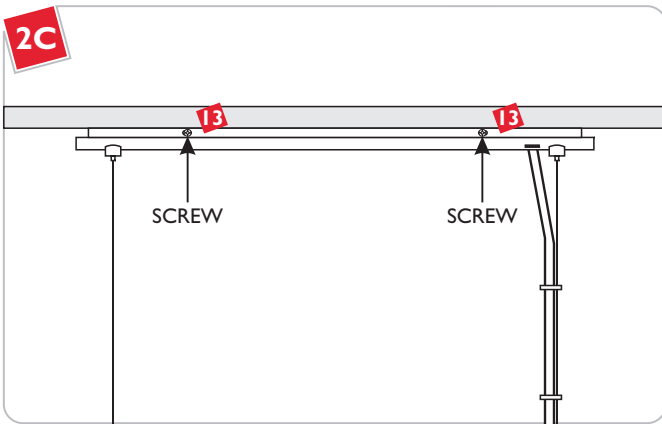

- 12** Place all wires, wire nuts, and cables inside the canopy.
- 13** Line up the canopy with the backplate and reinstall all four screws.

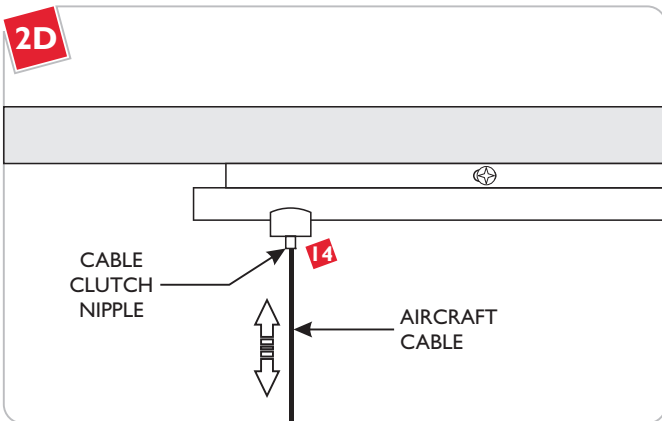

- 14** Adjust the aircraft cables until the boom is level. Feed the cable into the cable clutch to raise the boom. Push in on the cable clutch nipple to release the cable and lower the boom.

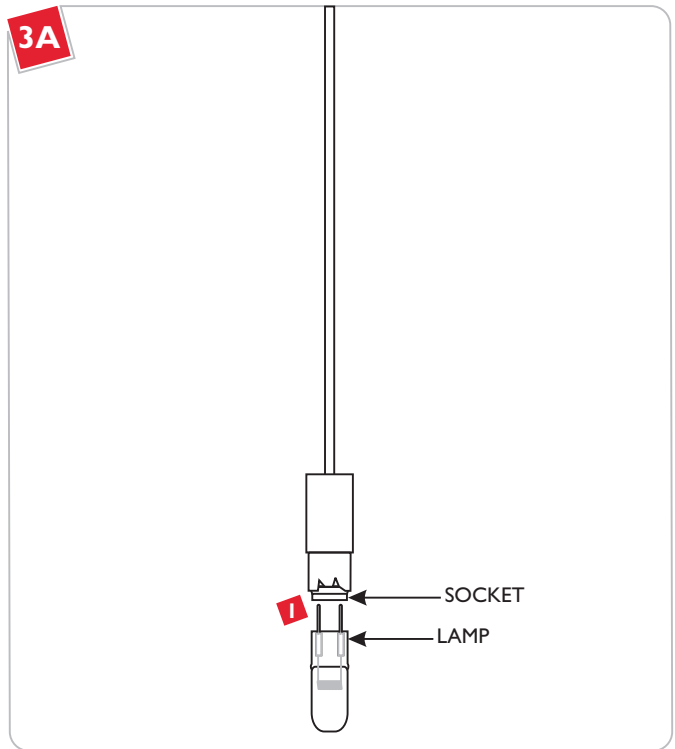

NOTE: Use only your fingers and a soft cloth to install the lamp.

Use **MAX 10** Watt Bi-Pin Xenogen (Xenon) Lamp.

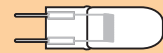

- 1** Push the lamp pins completely into the socket holes.

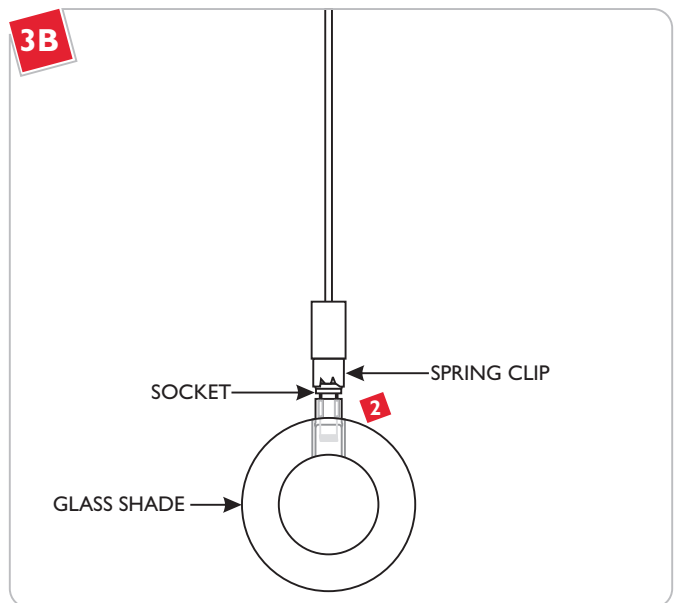

- 2** Push the glass shade completely onto the spring clip.

- 3** Repeat for all the lamps.

SAVE THESE INSTRUCTIONS!



LBL Lighting

7400 Linder Ave, Skokie, IL 60077

800.323.3226 - 847.626.6300

www.lblighting.com

© 2008 LBL Lighting. All rights reserved. The "LBL Lighting" graphic is a registered trademark of LBL Lighting. LBL Lighting reserves the right to change specifications for product improvements without notification.

A Generation Brands Company