

Circuit Protection Products



Introduction

This catalog presents the Edison branded circuit protection products available from Eaton.

For products necessary to complete their application, please see the Edison website at Eaton.com/Edison.

Table of contents

Product	Page
UL branch circuit fuses	
Class CC	
• EDCC time-delay	1
• HCLR fast-acting	3
• HCTR time-delay	3
Class G	
• SEC	5
Class J	
• JDL time-delay	7
• JFL fast-acting.	9
• JHL high speed	11
Class K5 and H one-time	
• KON 250 V / KOS 600 V	13
Class L	
• LCL time-delay / LCU fast-acting	15
Class RK1	
• LENRK 250 V / LESRK 600 V time-delay.	19
• NCLR 250 V / SCLR 600 V fast-acting	24
Class RK5	
• ECNR 250 V / ECSR 600 V time-delay.	27
Class T	
• TJN 300 V / TJS 600 V fast-acting	32
Plug fuses	
• S rejection base dual-element, time-delay	35
• SL rejection base time-delay	35
• SA rejection base/Edison base adapters	35
• W Edison base, fast-acting	36
• T Edison base dual-element, time-delay.	36
• TL Edison base time-delay.	36
• TC CSA Edison base time-delay	37
• P CSA Edison base one-time	37
Fuse reducers	
• Class J, R and H(K)	37
UL supplemental (midget/10x38)	
Fast-acting	
• MCL 600 V	38
• MOL 250 V	38
• EBS 600/250 V.	38
Time-delay	
• MEQ 500 V	40
• MEN 250 V	40
• MID 250/125/32 V	40

Product	Page
Automotive fuses	
Glass tube	
• SFE	42
Blade fuses	
• ATM, ATC and MAX	42
Small dimension (electronic ferrule and axial lead) fuses	
5x20 mm IEC fuses	
• S501 and S501-V.	43
• S500 and S500-V	43
• S506 and S506-V	43
5x20 mm N. American fuses	
• GMA and GMA-V	44
• GMC and GMC-V	44
• GMD and GMD-V	44
1/4" x 1-1/4" fast-acting fuses	
• AGC and AGC-V	45
• ABC and ABC-V	45
• GBB and GBB-V.	45
1/4" x 1-1/4" time-delay fuses	
• MDL and MDL-V	46
• MDA and MDA-V	46
Small dimension fuse displays, service kits and merchandisers	
Fuse assortments	
• ERFL (large) / ERFS (small)	47
Fuse service kits	
• CCFSK-45 Class CC fuse service kit	47
• MFSK-45 UL supplemental fuse service kit	47
• RK5FSK-39 Class RK5 fuse service kit	47
Display rack	
• MKE	47
Fuse blocks and holders	
• Class CC and G	48
• Class H(K)	49
• Class J.	50
• Class R.	52
• Class T.	53
• In-line Class CC, UL supplemental	53
• Box cover units	53
Fuse sizing for 600 V building electrical systems	54
Fuse cross reference guide.	56
Index by catalog symbol and fuse type.	Inside back cover

Edison circuit protection solutions comply with major industrial standards and agency requirements such as: BS, IEC, DIN, UL, NEMA, SAE, CSA, CE, C-UL, etc. and are manufactured at facilities that are ISO 9000 certified. This catalog is intended to present product data and provide technical information that will help the end user with design application. We reserve the right, without notice, to change design or construction of any products and to discontinue or limit distribution of any products. We also reserve the right to change or update, without notice, any technical information contained in this catalog. Once a product has been selected, it should be tested by the user in all possible applications. Further, we take no responsibility for errors or omissions contained in this catalog, or for misapplication of any Edison product. Extensive product information is available in the Edison product data sheets available online at Eaton.com/Edison. ©2019



Catalog symbol

EDCC 0.5-30 A, 600 Vac or less

Specifications

- Class CC current limiting, time-delay fuse

Ratings

- Volts
 - 600 Vac
 - 300 Vdc (0.5-2.5 A and 20-30 A)
 - 150 Vdc (2.8-15 A)
- Amps 0.5-30 A
- Interrupting rating
 - 200 kA RMS Sym.
 - 20 kA DC

Agency Information

- UL Listed, Class CC, File E162363, Guide JDDZ
- CSA Certified per C22.2, No. 248.4

Amp ratings				
0.5	1.5	3	6	12
0.6	1.6	3.2	6.25	15
0.8	1.8	3.5	7	20
1	2	4	7.5	25
1.125	2.25	4.5	8	30
1.25	2.5	5	9	—
1.4	2.8	5.6	10	—

Dimensions — in (mm)

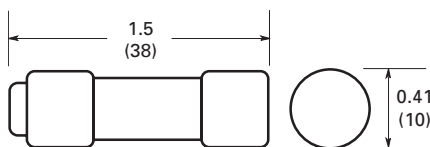

Edison EDCC Class CC fuses are extremely current-limiting fuses in a compact size. EDCC fuses are designed specifically for the protection of small horsepower motor circuits.

Recommended sizing for most applications is 200% FLA up to 15 amps and 300% from 20 to 30 amps FLA. Refer to time-current curves for specific applications.

Benefits

- Branch circuit rated for 600 Vac.
- Time-delay for motor branch circuit protection.
- Excellent current-limiting performance.
- Upgrade for standard “midget” fuses.

Applications

- Use for protection of small horsepower motor circuits or other circuits requiring small dimension, time-delay fuses.
- Can provide Type 2 “No Damage” protection for IEC or NEMA starters/contactors.
- For control transformer applications, refer to HCTR.

Cross reference		
Edison	Mersen	Littelfuse
EDCC	ATDR	CCMR

Time-current curve — average melt

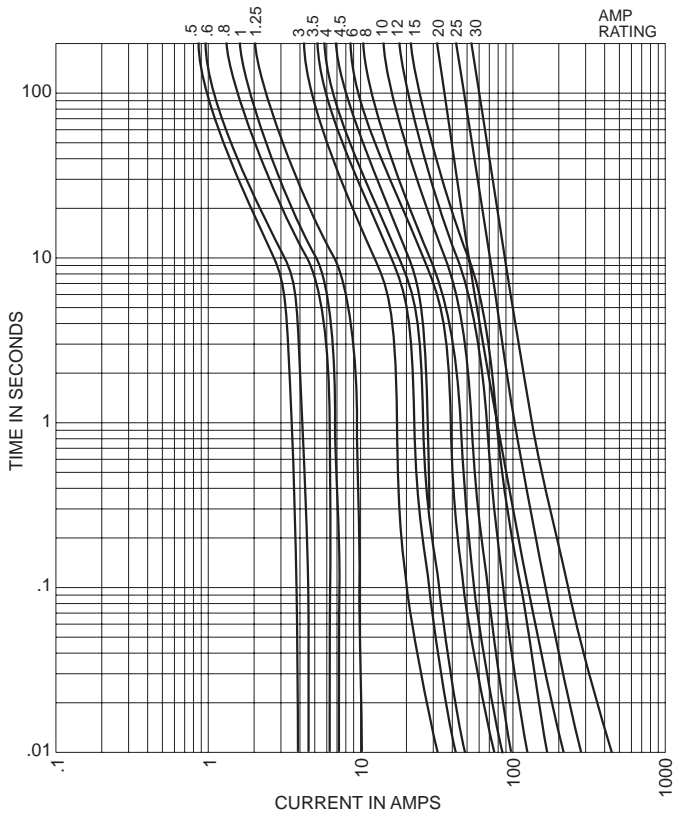

Peak let-through current curves

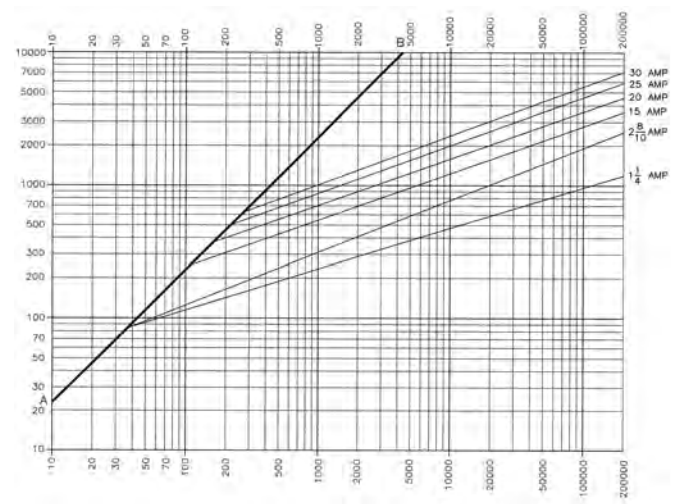

Current-limiting effects

Prosp. S.C.C.*	Let-through current (apparent RMS Sym.) versus fuse rating					
	1.25	2.8	15	20	25	30
1000	100	135	240	305	380	435
3000	140	210	350	440	575	580
5000	165	255	420	570	690	710
10,000	210	340	540	700	870	1000
20,000	260	435	680	870	1090	1305
30,000	290	525	800	1030	1300	1520
40,000	315	610	870	1150	1390	1700
50,000	340	650	915	1215	1520	1820
60,000	350	735	1050	1300	1650	1980
80,000	390	785	1130	1500	1780	2180
100,000	420	830	1210	1600	2000	2400
200,000	525	1100	1600	2000	2520	3050

* RMS Symmetrical amps short-circuit current.
 NOTE: To calculate I_p (I_{peak}) multiply IRMS value x 2.3.



Catalog symbol HCLR 0.1-30 A, 600 Vac or less

Amp ratings				
0.1	0.5	2.5	6	12
0.125	0.75	3	7	15
0.2	1	3.5	8	20
0.25	1.5	4	9	25
0.3	2	5	10	30

Dimensions – in (mm)

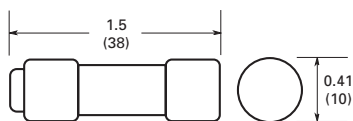

Specifications

- Class CC current limiting, fast-acting fuse

Ratings

- Volts
 - 600 Vac
 - 300 Vdc (15-20 A)
- Amps 0.1-30 A
- Interrupting rating
 - 200 kA RMS Sym.
 - 20 kA DC

Agency Information

- UL Listed, Class CC, File E162363, Guide JDDZ
- CSA Certified per C22.2, No. 248.4

Benefits

- Branch circuit rated for 600 Vac.
- Compact dimensions.
- Fast-acting design responds quickly to both overload and short-circuit current.

Applications

- Lighting and resistive heating loads.

Cross reference		
Edison	Mersen	Littelfuse
HCLR	ATMR	KLKR



Catalog symbol HCTR 0.25-30 A, 600 Vac or less

Amp ratings						
0.25	0.75	1.3	2	3.2	6.25	12
0.3	0.8	1.4	2.25	3.5	7.5	15
0.4	1	1.5	2.5	4	8	20
0.5	1.125	1.6	2.8	5	9	25
0.6	1.25	1.8	3	6	10	30

Dimensions – in (mm)

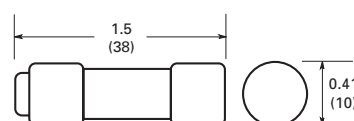

Specifications

- Class CC current limiting, time-delay fuse

Ratings

- Volts 600 Vac
- Amps 0.25-30 A
- Interrupting rating 200 kA RMS Sym.

Agency information

- UL Listed, Class CC, File E162363, Guide JDDZ
- CSA Certified per C22.2, No. 248.4

Benefits

- Branch circuit rated for 600 Vac.
- Compact dimensions.
- Time-delay design allows closer sizing for inductive loads such as control transformers and solenoids.

Applications

- Primary protection for control transformers.

Cross reference		
Edison	Mersen	Littelfuse
HCTR	ATQR	KLDR

Time-current curves — average melt

HCLR fast-acting

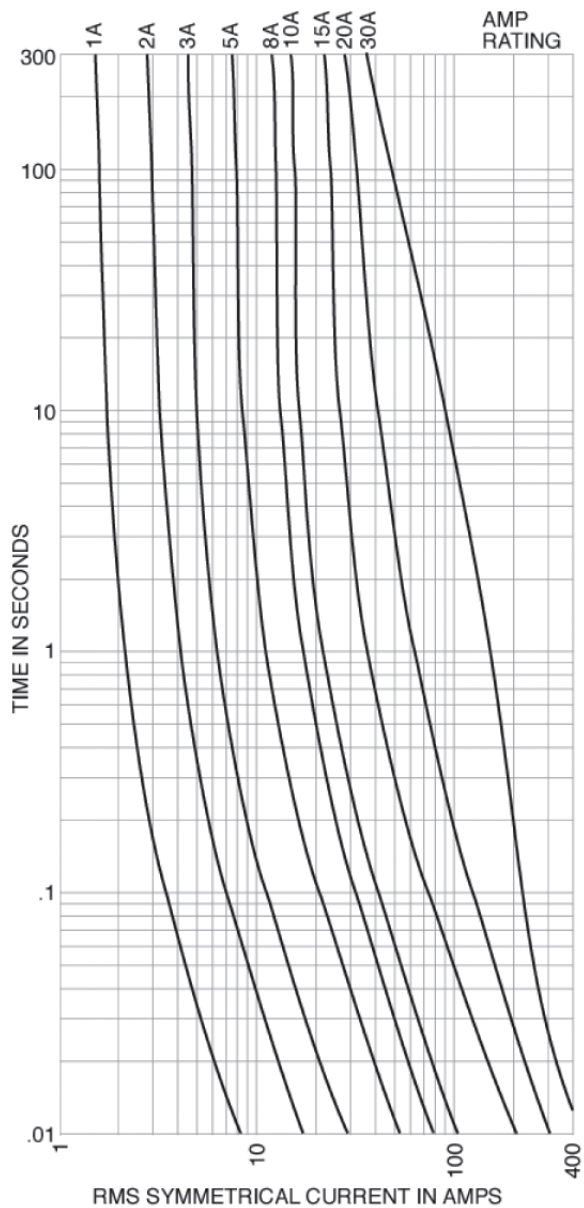

HCTR time-delay

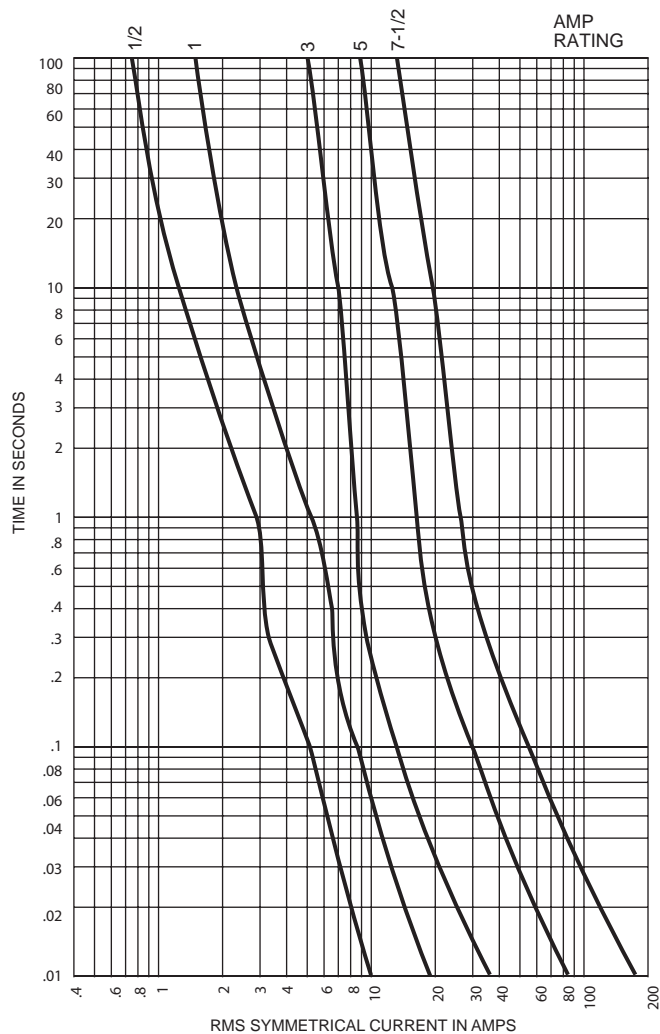

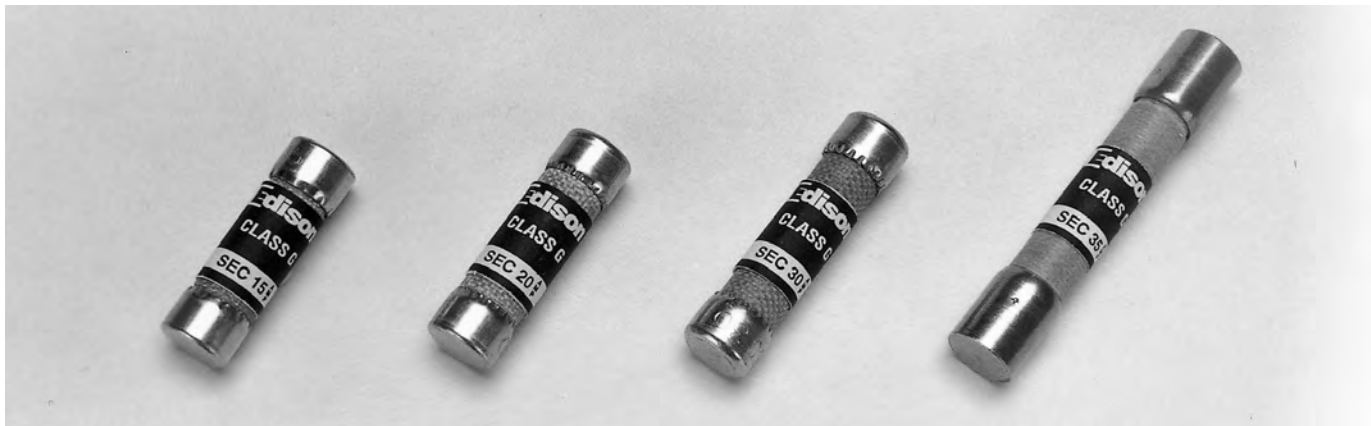

Catalog symbol

SEC 0.5-60 A, 600 Vac or Less

Specifications

Class G current limiting, fast-acting (0.5-6 A), time-delay (7-60 A) fuses

Ratings

- Volts
 - 600 Vac (0.5-20 A)
 - 480 Vac (25-60 A)
 - 170 Vdc (0.5-20 A*)
 - 300 Vdc (30 and 60 A only)

* Self-certified DC ratings.

- Amps 0.5-60 A
- Interrupting ratings
 - 100 kA RMS Sym.
 - 10 kA Amps DC

Agency Information

- UL Listed, Std. 248-5, Class G, File E162363, Guide JDDZ
- CSA Certified, C22.2 No. 248.5, Class 1422-01, File 700489

Amp ratings				
0.5	3	8	25	45
1	4	10	30	50
1.5	5	15	35	60
2	6	20	40	—

Dimensions — in	
Amps	Length
1-15	1.31
20	1.41
25-30	1.63
35-60	2.25

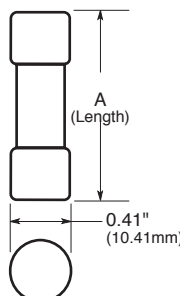

Benefits

- Branch circuit rated for 480 Vac.
- Compact size features varying length rejection feature which helps prevent overfusing.
- Time-delay of 12 sec. min. at 200% rating for amp sizes 6 through 60.

Applications

- General purpose for use in 120/208 and 277/480 circuits. Ideal for fluorescent fixture protection.
- Light inductive loads including motors, solenoids, etc. (For additional delay, refer to Edison EDCC or JDL).

Cross reference		
Edison	Mersen	Littelfuse
SEC	AG	SLC

Time-current curves — average melt

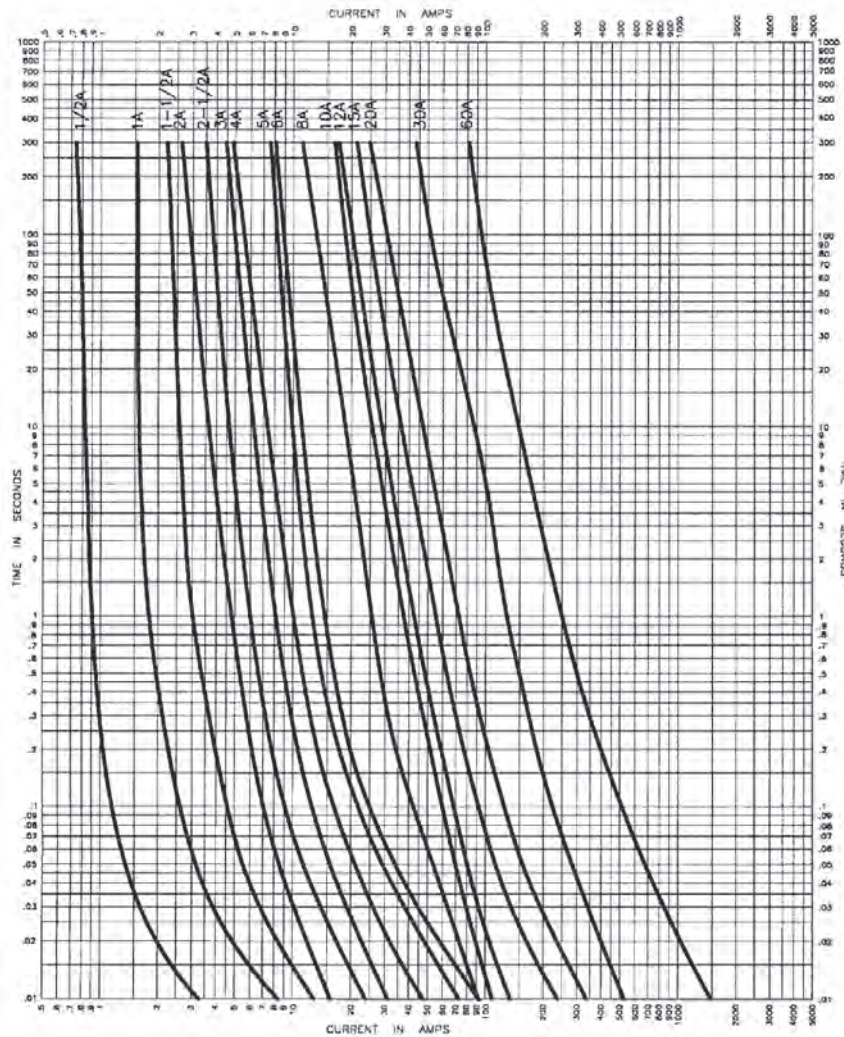

Peak let-through current curves

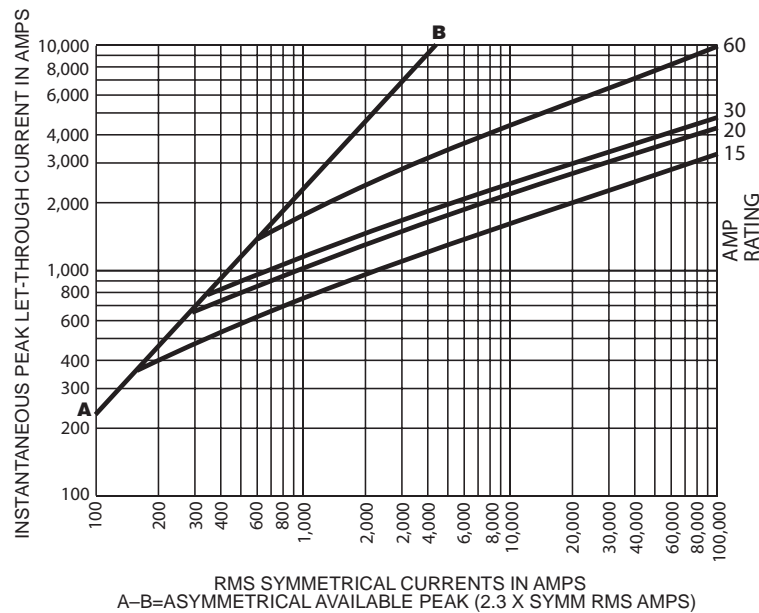



Catalog symbol

JDL 1-600 A, 600 Vac or Less

Specifications

- Class J, current limiting, dual-element, time-delay fuse

Ratings

- Volts
 - 600 Vac
 - 300 Vdc
- Amps 1-600 A
- Interrupting ratings
 - 200 kA RMS Sym.
 - 100 kA DC

Agency Information

- UL Listed, Class J, File E162363, Guide JDDZ
- CSA Certified per C22.2, No. 248.8

Amp ratings					
1	4	12	40	100	250
1.25	5	15	45	110	300
1.6	5.6	17.5	50	125	350
2	6	20	60	150	400
2.5	7	25	70	175	450
3	8	30	80	200	500
3.5	10	35	90	225	600

Edison JDL Class J fuses are among the most current limiting, time-delay fuses available. Their small physical size and high performance characteristics makes these Class J fuses ideal for any space-limited application.

Benefits

- Space saving dimensions vs. Class R.
- Dual-Element construction provides superior time-delay to pass harmless motor or transformer surges.
- High performance with fatigue-free cycling capabilities.
- Extremely current limiting.

Applications

- Recommended for Type 2 “No Damage” protection of IEC style motor starters and contactors.
- Use to protect lower interrupting rating circuit breakers.
- All general purpose circuits with inductive (high inrush) loads, including motor and motor branch circuits, and transformer circuits. Also suitable for lighting loads.

Cross reference		
Edison	Mersen	Littelfuse
JDL	AJT	JTD

JDL time-current curves – average melt

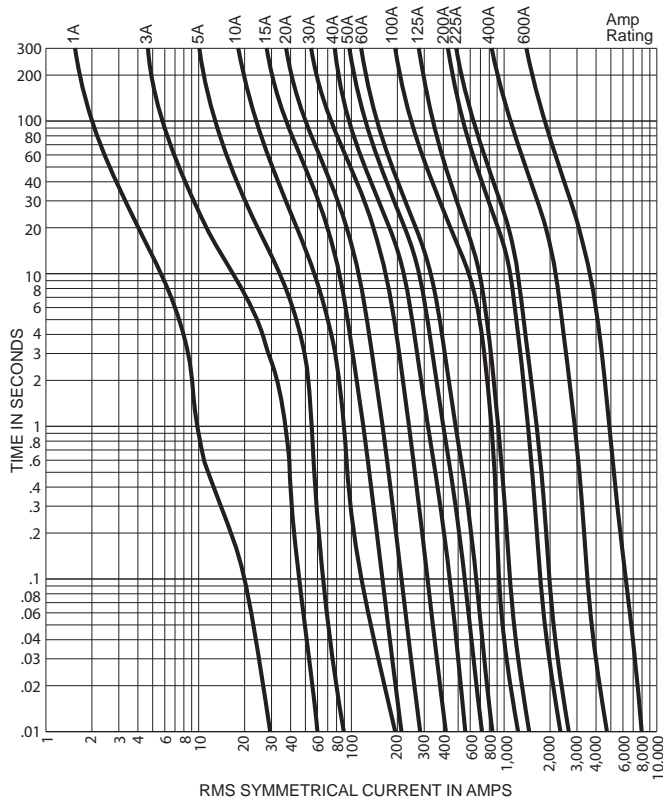

JDL peak let-through current curves

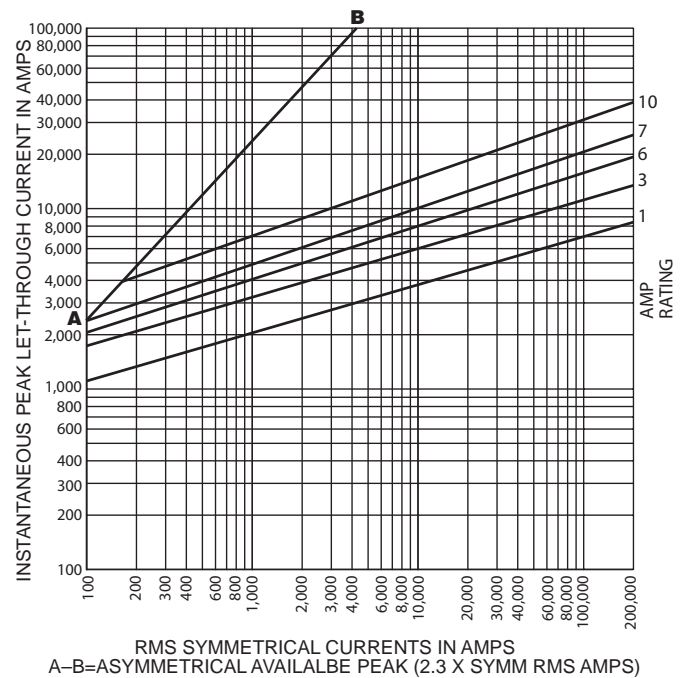

JDL current limitation table

*Prop. S.C.C.	Let-through current (apparent RMS Sym.) versus fuse rating						
	15 A	30 A	60 A	100 A	200 A	400 A	600 A
1,000	270	470	750	—	—	—	—±
3,000	370	670	1,130	1,640	2,360	—	—
5,000	450	800	1,420	1,910	2,760	4,400	—
10,000	550	1,000	1,730	2,450	3,520	5,540	8,000
15,000	625	1,220	1,890	2,850	4,000	6,420	9,000
20,000	700	1,330	2,120	3,090	4,400	7,000	10,000
25,000	750	1,440	2,250	3,400	5,000	7,500	11,100
30,000	800	1,530	2,370	3,650	5,140	8,000	11,800
35,000	820	1,600	2,580	3,780	5,430	8,330	12,500
40,000	900	1,640	2,670	4,000	5,640	9,000	13,270
50,000	925	1,760	2,790	4,470	6,000	9,380	13,820
60,000	1,000	1,850	3,000	4,670	6,420	10,000	15,000
80,000	1,160	2,000	3,220	5,000	7,400	11,270	16,000
100,000	1,220	2,150	3,520	5,360	7,950	12,180	17,270
150,000	1,400	2,460	4,000	6,170	9,000	14,360	19,270
200,000	1,560	2,640	4,450	7,000	10,000	15,820	20,600

* RMS Symmetrical amps short-circuit current.
NOTE: Data derived from current limiting curves.

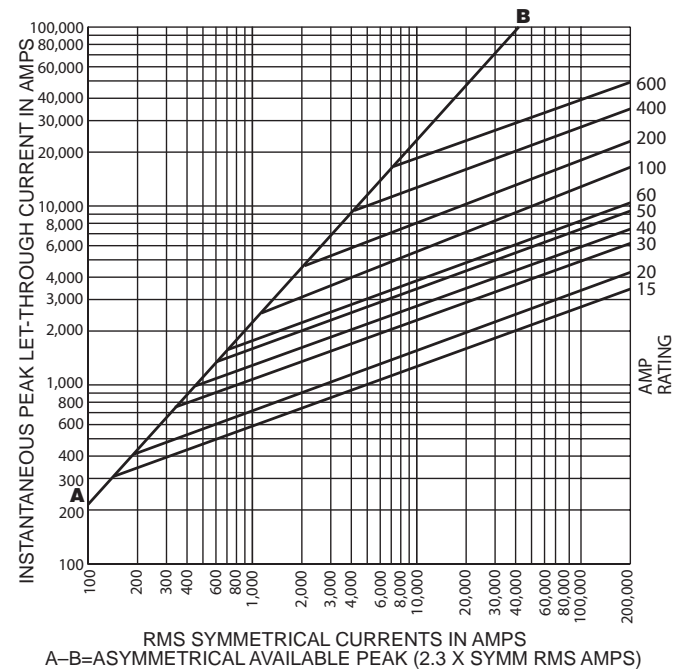

Dimensions

- Refer to JFL section on page 10.

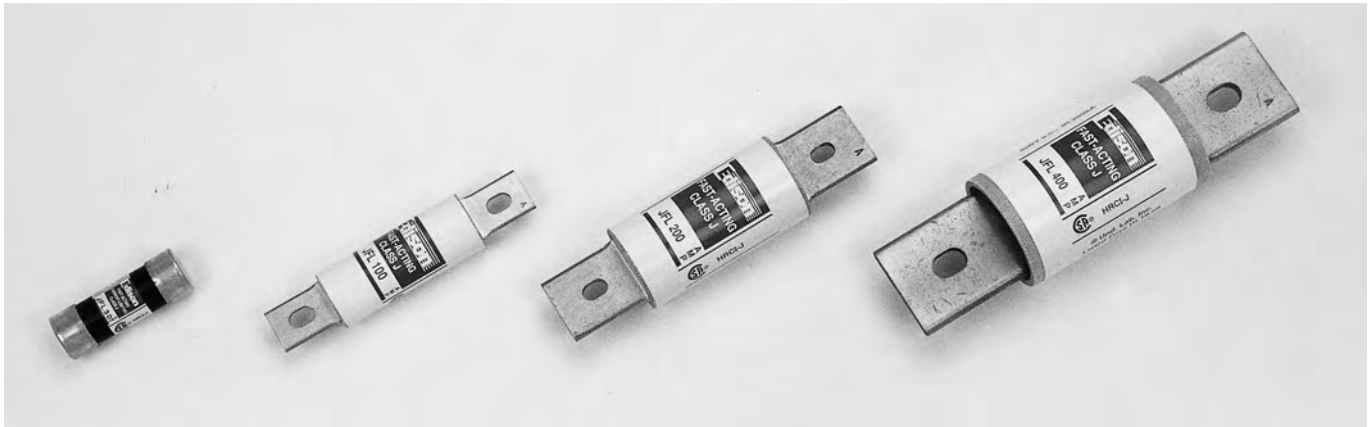

Catalog symbol

JFL (1-600 A) 600 Vac or Less

Specifications

- Class J current limiting, fast-acting fuse

Ratings

- Volts 600 Vac
- Amps 1-600 A
- Interrupting Rating 200 kA RMS Sym.

Agency Information

- UL Listed, Class J, File E162363, Guide JDDZ
- CSA Certified per C22.2, No. 248.8

Amp ratings					
1	8	30	70	150	350
2	10	35	80	175	400
3	12	40	90	200	450
4	15	45	100	225	500
5	20	50	110	250	600
6	25	60	125	300	—

Edison JFL Class J fuses are among the most current limiting fuses available. Their small physical size and high performance characteristics makes Class J fuses ideal for any space-limited application.

Edison JFL fuses are best suited for the protection of non-inductive loads such as resistive heating, and lighting circuits.

Benefits

- Space saving dimensions versus. Class R.
- Fast-acting design permits quick response for both overloads and shorts.
- Extremely current-limiting.

Applications

- Recommended for protection of non-inductive loads, such as lighting and resistance heating circuits.
- For motor applications, refer to Edison JDL.

Recommended Upgrade

- JDL.

Cross reference		
Edison	Mersen	Littelfuse
JFL	A4J	JLS

JFL and JDL Dimensions – in

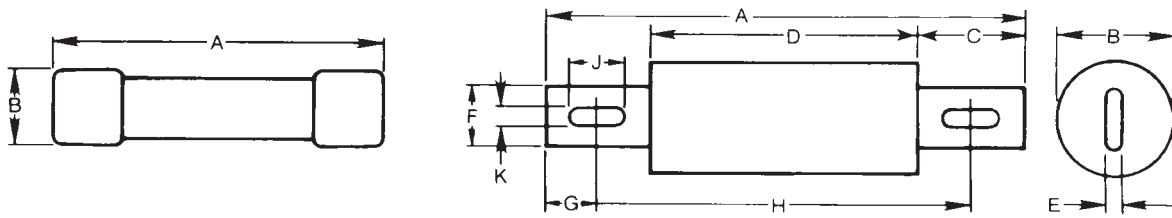

Amp range	A	B	C	D	E	F	Mounting Hole Spacing			
							G	H	J	K
1-30	2-1/4	13/16	—	—	—	—	—	—	—	—
35-60	2-3/8	1-1/16	—	—	—	—	—	—	—	—
70-100	4-5/8	1-1/18	1	2-5/8	1/8	3/4	1/2	3-5/8	3/8	9/32
110-200	5-3/4	1-5/8	1-3/8	3	3/16	1-1/8	11/16	4-3/8	3/8	9/32
225-400	7-1/8	2-1/8	1-7/8	3-3/8	1/4	1-5/8	15/16	5-1/4	17/32	13/32
450-600	8	2-5/8	2-1/8	3-3/4	3/8	2	1	6	11/16	17/32

JFL time-current curves – average melt

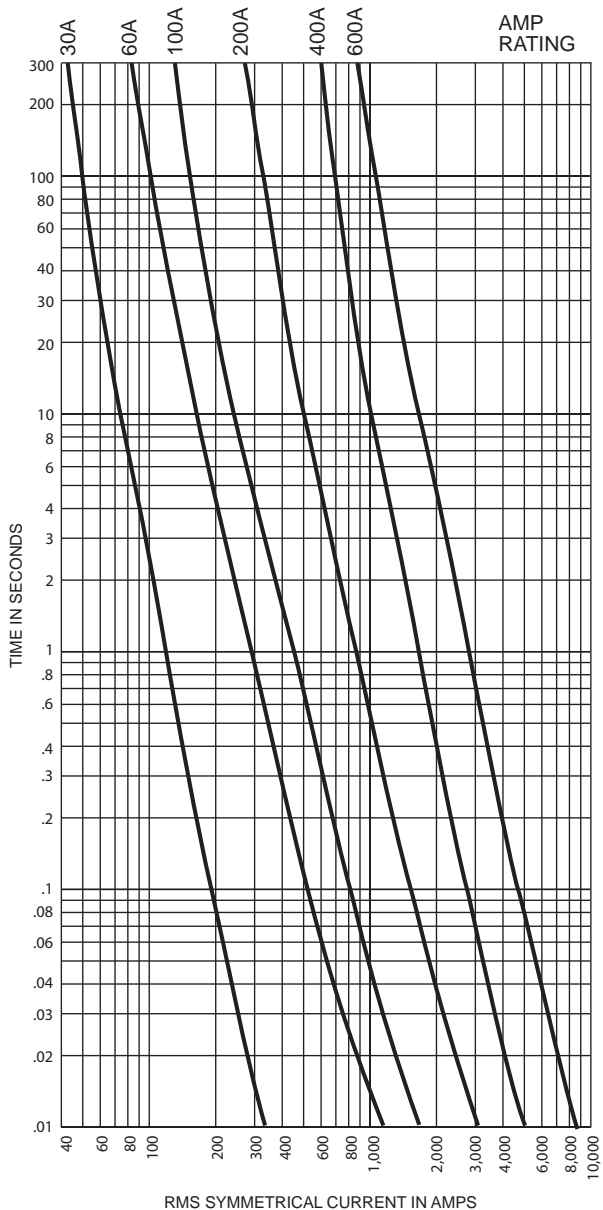

JFL peak let-through current curves*

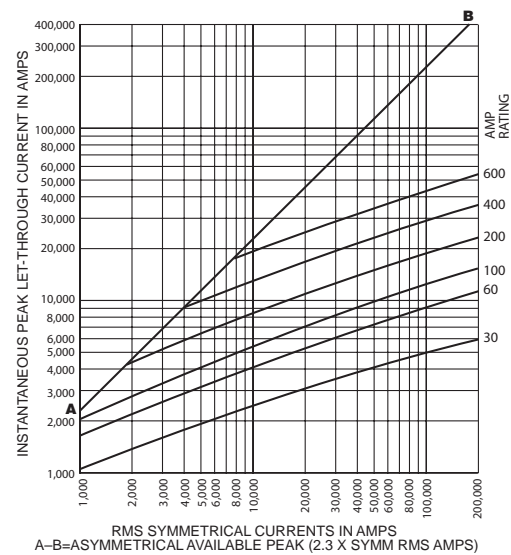

* Curves test data obtained at 15% short-circuit power factor when possible.

JFL Current limitation table**

Prospect S.C.C.	Fuse size											
	30		60		100		200		400		600	
	I _{RMS}	I _p	I _{RMS}	I _p	I _{RMS}	I _p	I _{RMS}	I _p	I _{RMS}	I _p	I _{RMS}	I _p
5,000	1	2	1	3	2	4	3	7	4	10	5	12
10,000	1	3	2	4	3	6	4	10	7	15	10	22
15,000	1	3	2	5	3	7	5	12	8	18	11	25
20,000	2	4	3	6	3	8	6	13	9	19	12	28
25,000	2	4	3	6	3	8	6	13	9	20	13	30
30,000	2	4	3	6	3	8	6	13	9	20	13	30
35,000	2	4	3	7	4	9	6	14	9	21	13	30
40,000	2	4	3	7	4	9	7	15	10	22	14	32
50,000	2	5	3	8	4	10	7	16	10	23	15	35
60,000	2	5	3	8	5	11	7	17	11	25	16	37
70,000	2	5	3	8	5	12	8	18	11	25	17	39
80,000	2	5	3	8	5	12	8	18	12	28	17	39
90,000	2	5	4	9	6	13	9	19	13	29	18	41
100,000	2	5	4	9	6	13	9	19	13	30	18	42
150,000	2	5	5	11	6	14	9	21	14	33	22	50
200,000	3	6	5	12	7	15	10	22	16	37	24	55

** "Apparent Let-Through Amps" values are read from "Peak Let-Through Current Curves" and the peak current value divided by 2.3 Asymmetry Factor.



Catalog symbol

JHL (1-600 A) 600 Vac (or less), 450 Vdc (or less)

Specifications

- Class J current limiting, high speed fuse

Ratings

- Volts
 - 600 Vac or less
 - 450 Vdc or less
- Amps 1-600 A
- Interrupting Rating
 - 200 kA RMS Sym.
 - 100 kA DC

Agency Information

- UL Listed, Std. 248-8, Class J, Guide JDDZ, File E162363
- CSA Certified, C22.2 No. 248.8, Class 1422-02, File 53787

Catalog numbers (Amps)			
JHL1	JHL15	JHL70	JHL225
JHL2	JHL20	JHL80	JHL250
JHL3	JHL25	JHL90	JHL300
JHL4	JHL30	JHL100	JHL350
JHL5	JHL35	JHL110	JHL400
JHL6	JHL40	JHL125	JHL450
JHL8	JHL45	JHL150	JHL500
JHL10	JHL50	JHL175	JHL600
JHL12	JHL60	JHL200	

Benefits

- Combine the performance of high speed semiconductor fuses and the convenience of Class J branch circuit fuses in on package.
- The Edison Drive Fuse will provide maximum protection for AC and DC drives and controllers and meet NEC® branch circuit protection requirements.
- Easily coordinated with existing and new variable speed drives and electric controllers.
- Standard Class J dimensions allowing the use of readily available fuse blocks, holders, and switches.
- Allows the lowest let-thru energy of any branch circuit overcurrent protective device.

Electrical characteristics

Rated current/ RMS amps	I ² t (A ² Sec) @ 600 Vac/100 kA		Watts loss
	Pre-arc	Clearing	
15	4	110	4.1
20	8	365	4.0
25	12	610	4.9
30	20	1000	5.5
35	55	1100	6.8
40	90	1900	8.6
50	140	2800	8.7
60	290	6000	8.5
70	450	3100	12
80	650	4600	13
90	1010	7200	13
100	1460	10,500	13
110	1710	9500	17
125	3580	20,000	15
150	5080	28,000	19
175	6310	35,000	23
200	9850	54,500	24
225	11,420	51,000	29
250	17,000	74,500	30
300	23,500	103,000	36
350	38,800	170,000	39
400	62,200	272,000	40
450	44,600	270,000	56
500	79,500	480,000	52
600	138,000	830,000	57

Cross reference

Edison	Mersen	Littelfuse
JHL	—	LDFJ

Time-current characteristic curves—average melt

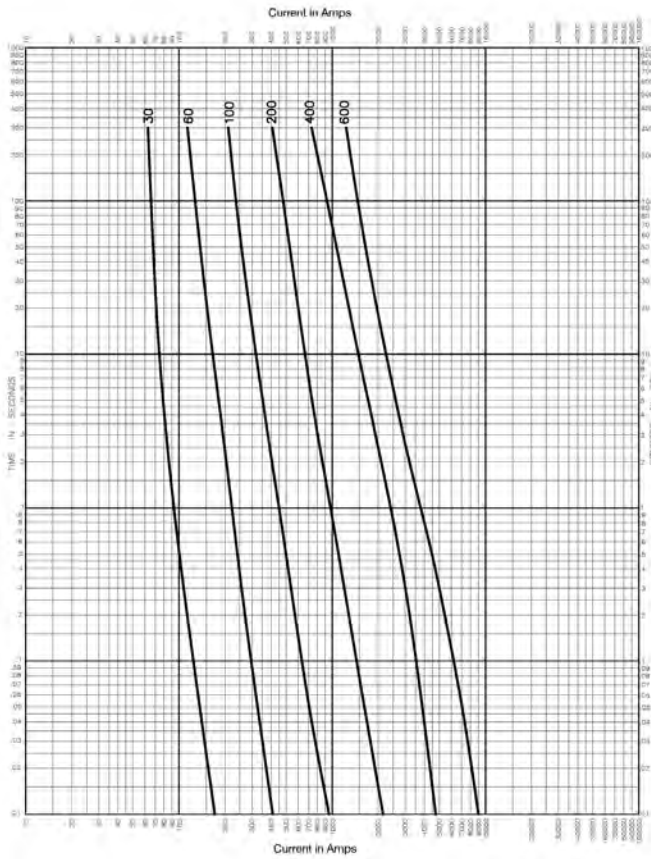

Peak let-through current curves*

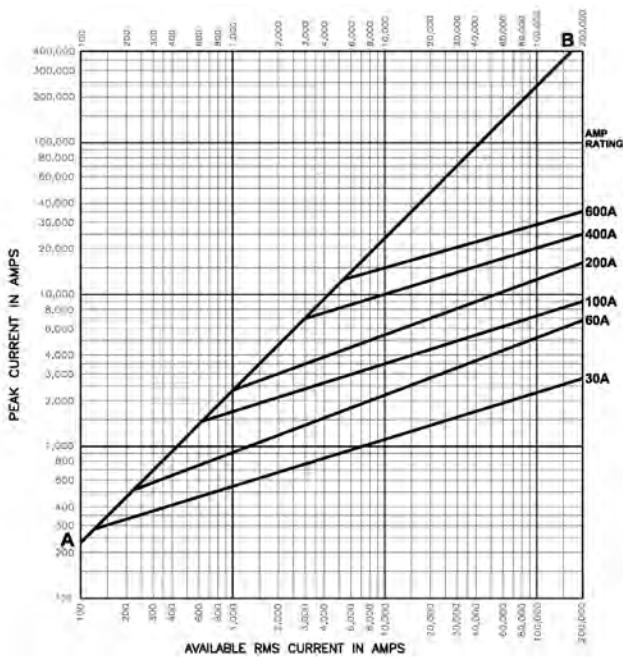

Dimensions – in



1 to 30 A

35 to 60 A

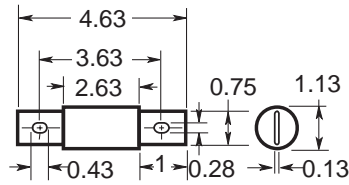

70 to 100 A

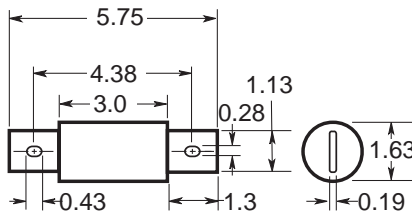

110 to 200 A

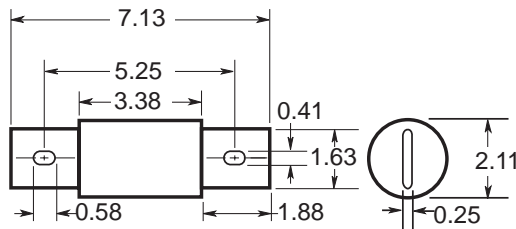

225 to 400 A

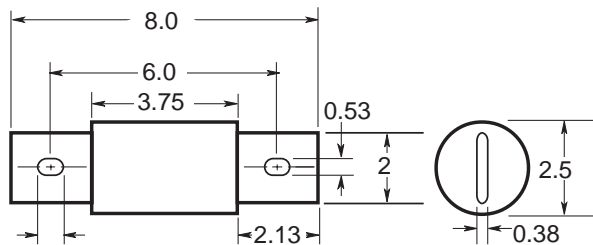

450 to 600 A



Catalog symbols

KON 1-600 A, 250 Vac or less

KOS 1-600 A, 600 Vac or less

Amp ratings					
KON 250 Vac					
1	7	25	60	125	300
2	8	30	70	150	350
3	10	35	80	175	400
4	12	40	90	200	450
5	15	45	100	225	500
6	20	50	110	250	600
KOS 600 Vac					
1	7	25	60	125	300
2	8	30	70	150	350
3	10	35	80	175	400
4	12	40	90	200	450
5	15	45	100	225	500
6	20	50	110	250	600

Specifications

- Class H(K) fast-acting “one time” fuses

Ratings

- Volts
 - 250 Vac (KON)
 - 600 Vac (KOS)
 - 250 Vdc* (KON 1-600 A)
 - 300 Vdc* (KOS (35-60 A))
 - 600 Vdc* (KOS (1-30 A, 70-600 A))

* Self certified

- Amps 1-600 A
- Interrupting ratings
 - 50 kA RMS Sym. (KON 1-60 A, KOS 15-60 A)
 - 10 kA RMS Sym. (KON 70-600 A, KOS 1-12 A, KOS 70-600 A)
 - 10 kA DC @ rated voltage

Agency information

- UL Listed, Class K5, UL248-9, File E162363, Guide JDDZ,
 - UL Listed, Class H, UL248-6, File E162363, Guide JDDZ
 - CSA Certified* HRC-K5 per C22.22, No. 248.9, LR700489
 - CSA Certified HRC-H per C22.22, No. 248.6, LR700489
- * NOTE: KON15-60 A are not CSA Certified. Refer to PONC for use in Canada.

Benefits

- Economical, for general purpose use.

Applications

- Lighting or heating circuits not subject to high levels of inrush current.
- Circuits having relatively low levels of available fault current.
- For motor applications, refer to Edison RK5 ECNR (250 Vac)/ ECSR (600 Vac).

Recommended upgrades

- Class RK1
 - LENRK (250 Vac)
 - LESRK (600 Vac)
- Class RK5
 - ECNR (250 Vac)
 - ECSR (600 Vac)

Cross reference		
Edison	Mersen	Littelfuse
KON	OT	NLN
KOS	OTS	NLS

Dimensions — in

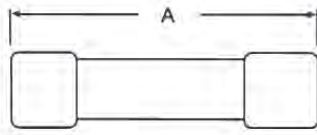

Up to 60 A

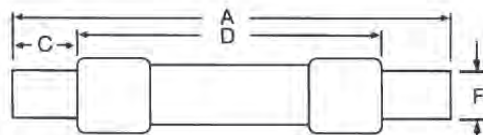

70-600 A

Catalog symbol/volts	Amps	A	B	C	D	E	F
KON 250 Vac	Up to 30	2	9/16	—	—	—	—
	35-60	3	13/16	—	—	—	—
	70-100	5-7/8	1-1/16	1	—	1/8	3/4
	110-200	7-1/8	1-5/8	1-3/8	4-1/8	3/16	1-1/8
	225-400	8-5/8	1-15/16	1-7/8	4-5/8	1/4	1-5/8
	450-600	10-3/8	2-5/16	2-1/4	5-3/16	1/4	2
KOS 600 Vac	Up to 30	5	13/16	—	—	—	—
	35-60	5-1/2	1-1/16	—	—	—	—
	70-100	7-7/8	1-1/16	1	—	1/8	3/4
	110-200	9-5/8	1-5/8	1-3/8	6-1/8	3/16	1-1/8
	225-400	11-5/8	2-3/4	1-7/8	7-1/8	1/4	1-5/8
	450-600	13-3/8	3-1/4	2-1/4	8-3/16	1/4	2

Time-current curves — average melt

KON 250 Vac

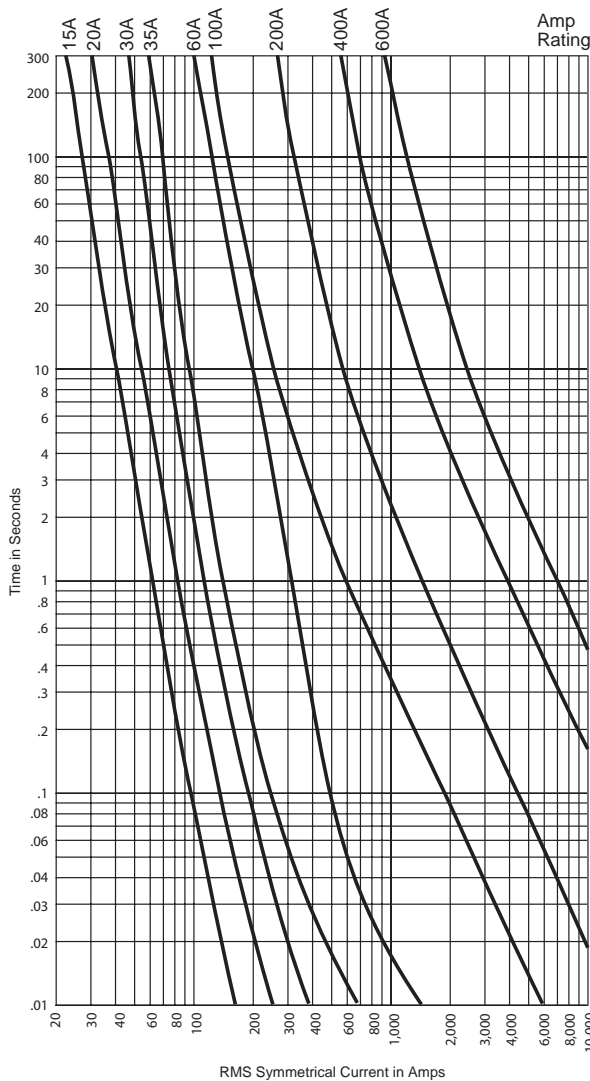

KOS 600 Vac

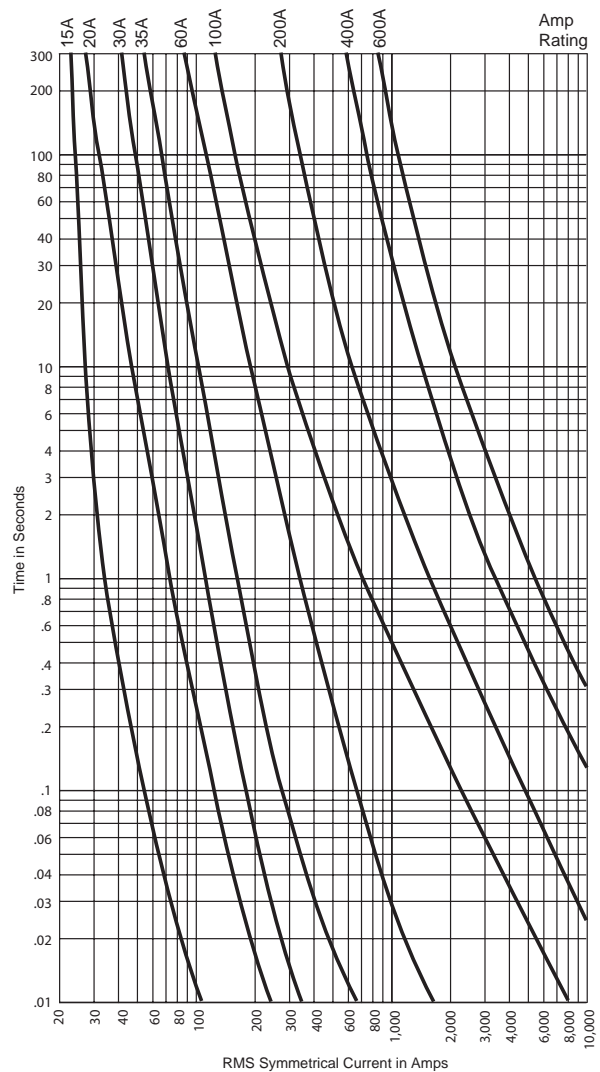



Catalog symbols

LCL 300-4000 A, time-delay 600 Vac or less

LCU 601-6000 A, fast-acting 600 Vac or less

Specifications

- UL Class L current limiting fuses
- LCL time-delay
- LCU fast-acting

Ratings

- Volts 600 Vac
- Amps
 - 300-4000 A (LCL)
 - 601-6000 A (LCU)
- Interrupting rating 200 kA RMS Sym.

Agency Information

- UL Listed, Class L, Guide JDDZ, File E162363
- CSA Certified HRC-L per C22.2, No. 248.10

Amp ratings					
LCL					
300*	650	801	1350	1800	3500
400*	700	900	1400	2000	4000
500*	750	1000	1500	2500	—
601	800	1200	1600	3000	—
LCU					
601	800	1350	1800	3000	6000
650	1000	1500	2000	3500	—
700	1200	1600	2500	4000	—

* Not UL Listed. LCL 300-500 amp fuses are physically the same as 800 amp size; Use in 800 amp switch where load current is not fully utilized and a smaller fuse amp size is desired. Also useful in new installations to allow for future upgrades in service.

LCL

Minimum time-delay 5 seconds at 500% rated current allows closer sizing.

Benefits

- “O-ring” construction insures maximum current limiting ability.
- Silver plated micro-peened terminals.
- High strength melamine fuse tubes.

Applications

- LCL: Recommended for AC power distribution system mains and large feeders.
- LCU: Recommended for non-inductive heating and lighting loads. Also suitable for protection of low interrupting rating circuit breakers.

Recommended sizing

LCL: 150% or more of motor full load current.

Cross reference		
Edison	Mersen	Littelfuse
LCL	A4BY	KLP-C, KLLU
LCU	None	None

Time-current curves — average melt

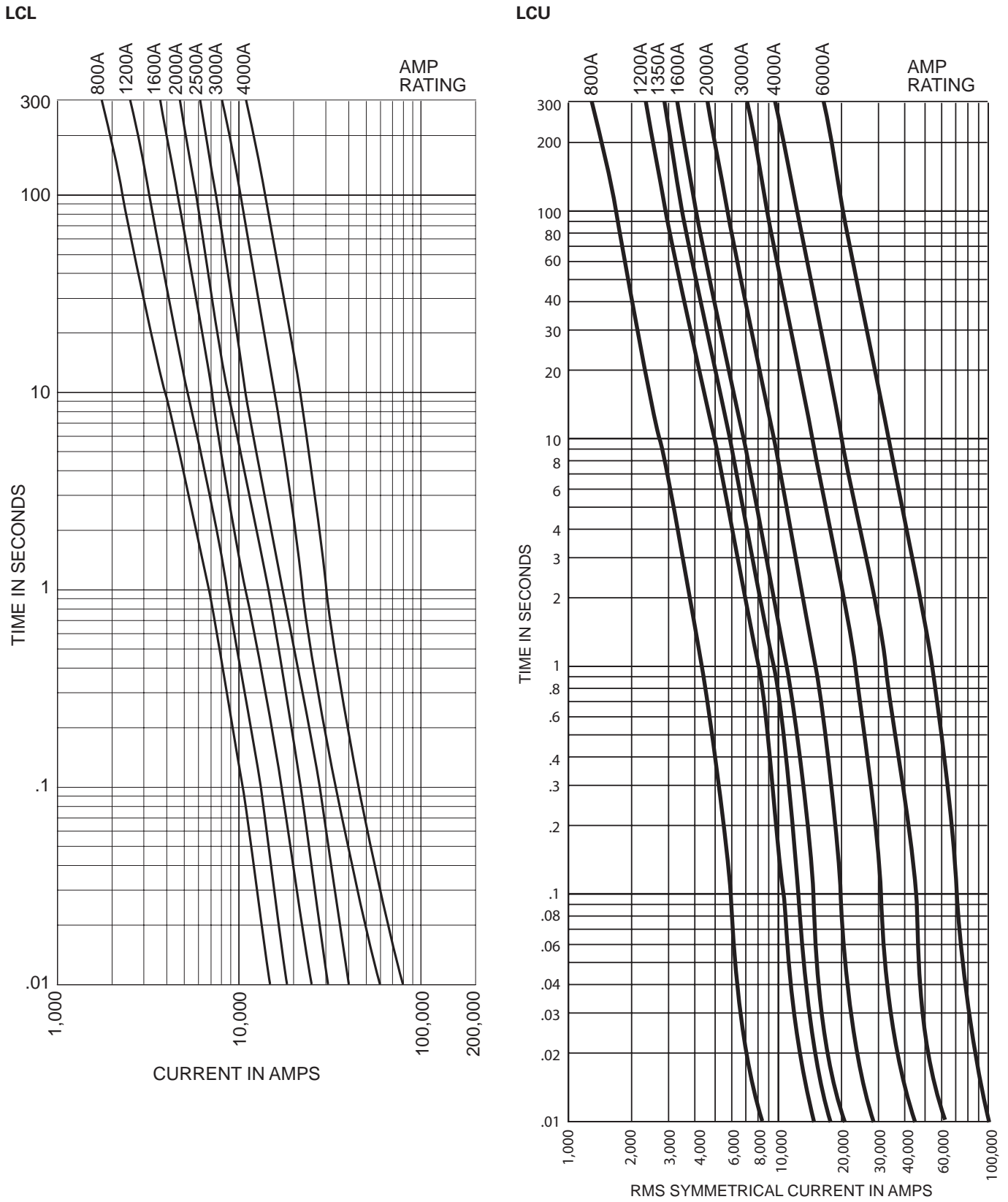

Peak let-through current curves*

LCL

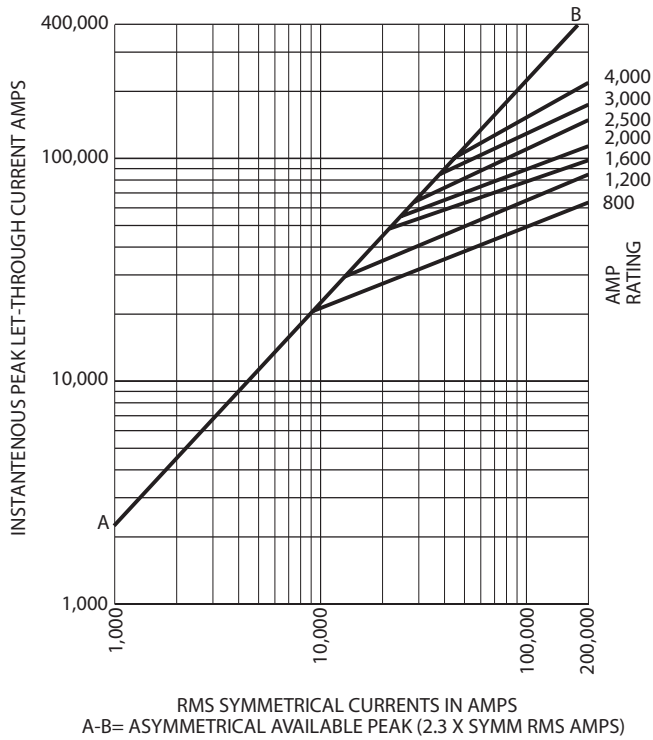

LCU

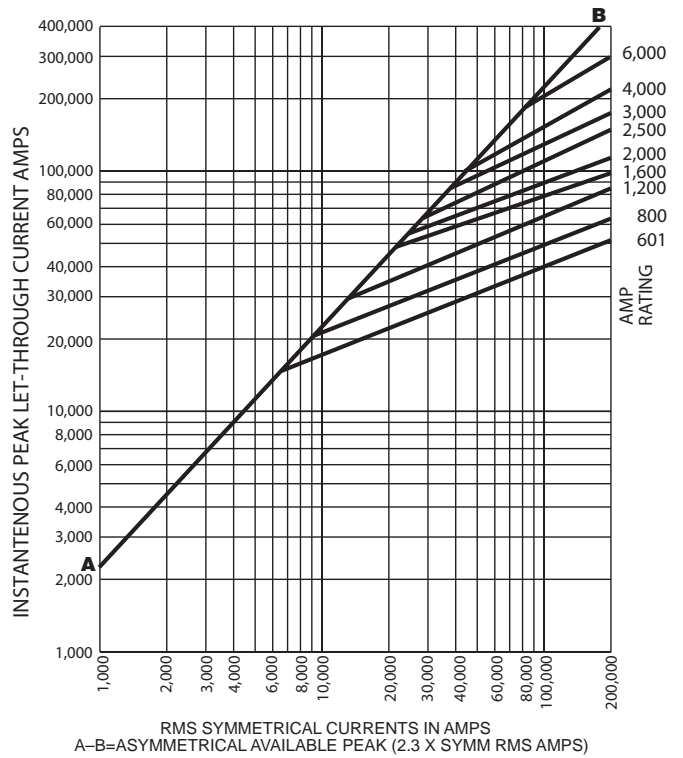

* Curves test data obtained at 15% short-circuit power factor when possible.

Current limitation tables**

LCL

*Prosp. S.C.C.	Let-through current (apparent RMS Sym.) versus fuse rating					
	800 A	1200 A	1600 A	2000 A	3000 A	4000 A
5,000	5,000	5,000	5,000	5,000	5,000	5,000
10,000	10,000	10,000	10,000	10,000	10,000	10,000
15,000	13,000	15,000	15,000	15,000	15,000	15,000
20,000	14,000	18,000	20,000	20,000	20,000	20,000
25,000	16,000	21,000	25,000	25,000	25,000	25,000
30,000	16,500	22,500	26,000	30,000	30,000	30,000
40,000	18,000	25,500	29,000	34,000	40,000	40,000
50,000	19,000	27,000	32,000	37,000	42,000	45,000
60,000	21,000	29,000	35,000	41,000	45,000	50,000
80,000	24,000	32,000	39,000	45,000	51,000	57,000
100,000	26,000	36,000	41,000	51,000	55,000	64,000
150,000	30,000	40,000	48,000	58,000	66,000	78,000
200,000	34,000	45,000	52,000	65,000	76,000	92,000

* RMS Symmetrical amps short-circuit current.
NOTE: Data derived from current limiting curves.

LCU

*Prosp. S.C.C.	Let-through current (apparent RMS Sym.) versus fuse rating						
	800 A	1200 A	1600 A	2000 A	3000 A	4000 A	6000 A
5,000	5,000	5,000	5,000	5,000	5,000	5,000	5,000
10,000	9,700	10,000	10,000	10,000	10,000	10,000	10,000
15,000	11,500	13,000	15,000	15,000	15,000	15,000	15,000
20,000	12,500	15,400	18,000	20,000	20,000	20,000	20,000
25,000	14,000	16,000	21,000	25,000	25,000	25,000	25,000
30,000	14,500	17,500	22,000	27,000	30,000	30,000	30,000
35,000	15,000	18,000	24,000	28,000	35,000	35,000	35,000
40,000	15,500	19,000	25,000	29,000	40,000	40,000	40,000
50,000	16,000	21,000	26,000	32,000	44,000	48,000	50,000
60,000	19,000	24,000	28,000	34,000	48,000	51,000	60,000
80,000	20,000	26,000	31,000	36,000	52,000	60,000	80,000
100,000	23,000	29,000	39,000	40,000	57,000	68,000	95,000
150,000	27,000	34,000	40,000	47,000	70,000	79,000	115,000
200,000	29,000	39,000	43,000	50,000	78,000	93,000	141,000

* RMS Symmetrical amps short-circuit current.
NOTE: Data derived from current limiting curves.

** "Apparent Let-Through Amps" values are read from "Peak Let-Through Current Curves" and the peak current value divided by 2.3 Asymmetry Factor.

General application

Edison Class L fuses, Catalog Numbers LCL time-delay or LCU fast acting are recommended for high capacity main, feeder or branch circuits in power distribution systems and for special applications such as system upgrading, install ahead of network protectors, etc. The choice of LCL or LCU depends on the extent of mixed inductive and non-inductive loads diversity. Apply LCL fuses for protection of large individual motor circuits. Size LCL fuses at 150% or more of the motor nameplate current rating by checking starting characteristics against minimum melt Time-Current Curve.

Class L fuses specification

Install Class L Fuses in switches rated 601-6000 amps and in "time-delay" or "fast-acting" types as shown on the plans. Installed and spare "time-delay" fuses shall be Catalog Number LCL and "fast-acting" fuses shall have silver links and be Catalog Number LCU. Fuses shall be Edison fuses or equivalent submitted to the design engineer for approval 10 days prior to the project bid date.

Mounting of "Bolt-On" fuses shall be made by installing stainless steel bolts of correct number, diameter and length*, stainless steel spring washers on each side of the bolt and stainless steel nuts. The nuts shall be tightened to the torque recommended by ASTM Standards for the bolt size used.

* Bolts shall have the largest diameter to fit fuse bolt holes and length to allow full nut thread engagement. Bolts shall be installed in each fuse mounting hole.

Dimensions — in

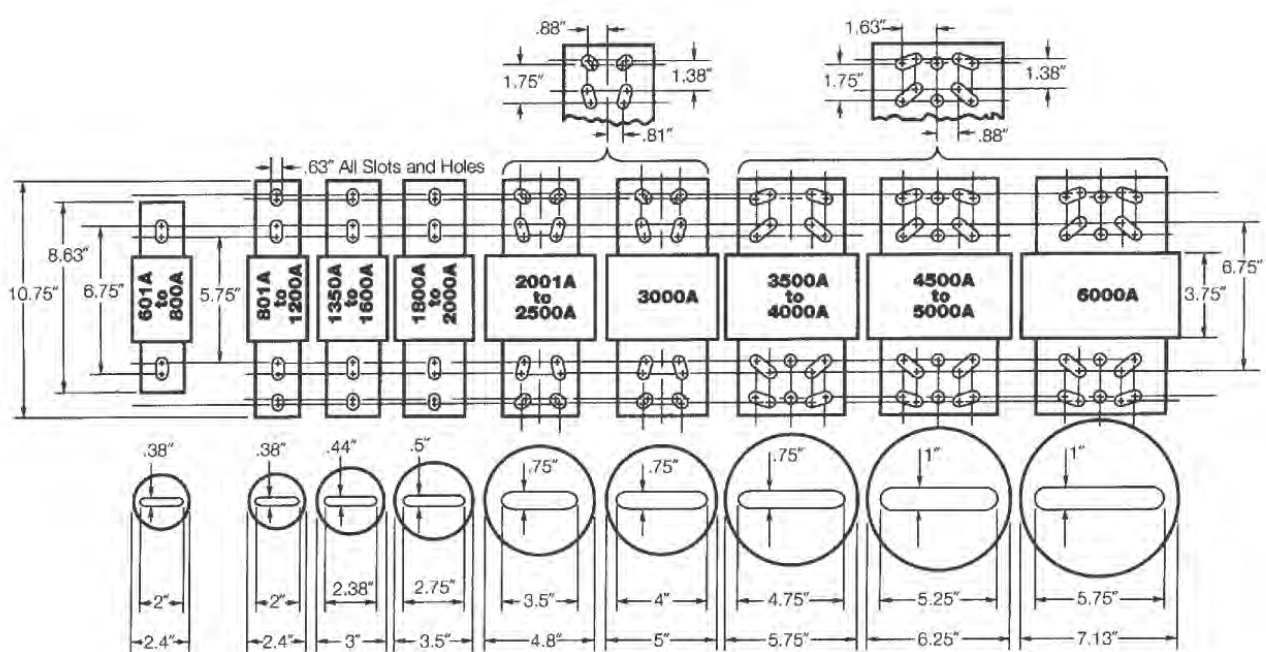



Catalog symbols

LENRK 0.2-600 A, 250 Vac or Less

LESRK 0.25-600 A, 600 Vac or Less

Specifications

RK1 current limiting, dual-element, time-delay fuses

Ratings

- Volts
 - LENRK - 250 Vac
 - LESRK - 600 Vac
 - 125 Vdc (0-60 A), 250 Vdc (70-600 A) (LENRK*)
 - 300 Vdc (0.25-600 A) (LESRK*)

* Self certified.

- Amps
 - 0.2-600 A (LENRK)
 - 0.5-600 A (LESRK)
- Interrupting rating
 - 200 kA RMS Sym.
 - 20 kA DC

Agency Information

- UL Listed, Class RK1, Guide JDDZ, File E162363
- CSA Certified, HRCI-R per C22.2, No. 248.12

Amp Ratings				
LENRK				
0.2	2	6.25	40	175
0.3	2.25	8	45	200
0.4	2.5	9	50	225
0.5	3	10	60	250
0.6	3.2	12	70	300
0.8	3.5	15	80	350
1	4	17.5	90	400
1.125	4.5	20	100	450
1.4	5	25	110	500
1.6	5.6	30	125	600
1.8	6	35	150	

LESRK				
0.5	2.5	7	40	175
0.6	2.8	8	45	200
1	3	9	50	225
1.125	3.2	10	60	250
1.25	3.5	12	70	300
1.4	4	15	80	350
1.5	4.5	17.5	90	400
1.6	5	20	100	450
1.8	5.6	25	110	500
2	6	30	125	600
2.25	6.25	35	150	

Benefits

- True dual-element spring-trigger construction allows sizing of 125% FLA for motor backup protection.
- Superior overload and cycling capabilities.
- Extremely current limiting provides superior short-circuit component protection.

Applications

- Recommended for AC power distribution system mains, feeders, and branch circuits.
- Protection of motors and motor branch circuits.
- Type 2 “No Damage” protection for IEC components.
- All general-purpose applications including lighting, heating and other non-inductive loads.

Cross reference			
Volts	Edison	Mersen	Littelfuse
250	LENRK	A2DR	LLNRK
600	LESRK	A6DR*	LLSRK

* Not dual element 110-600 Amp

LENRK/LESRK current limiting, dual-element, time-delay fuses

The application recommended for these fuses is exactly the same as for the Edison ECNR/ECSR fuses except for the advantages of greater current limitation. The Edison LENRK/LESRK fuses have up to 40% more current limitation and up to 350% more Amps-Squared-Second (I^2t) limitation under fault conditions than Edison ECNR/ECSR fuses to reduce potential for damage. In addition, LENRK/LESRK fuses allow better selectivity for electrical power system designers and better short-circuit protection for breakers having inadequate interrupting ratings. ECNR/ECSR and LENRK/LESRK fuse lines are physically interchangeable (and electrically interchangeable per UL equipment listing conditions) and are recommended as a practical, economical way to upgrade systems for many situations.

- Class R fuses will fit Class H, K and R fuse clips.
- Class R fuse clips will only accept Class R fuses.
- Fuses rated 600 Vac or less may be applied at any lower voltage.

True dual-element construction

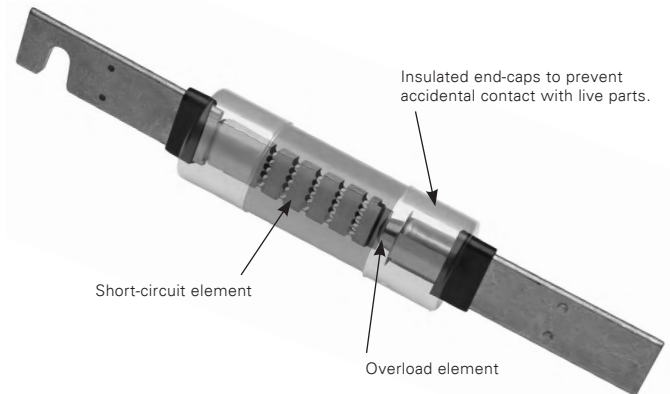

Dimensions — in

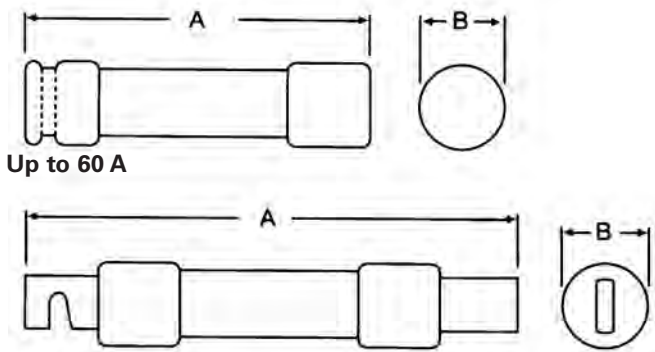

70-600 A

Catalog symbol	Amps	A	B
LENRK	Up to 30	2	0.56
	35-60	3	0.81
	70-100	5.88	1.10
	110-200	7.13	1.61
	225-400	8.63	2.38
	450-600	10.38	2.88
LESRK	Up to 30	5	0.81
	35-60	5.5	1.06
	70-100	7.88	1.11
	110-200	9.63	1.61
	225-400	11.63	2.36
	450-600	13.38	2.88

LENRK time-current curves — average melt

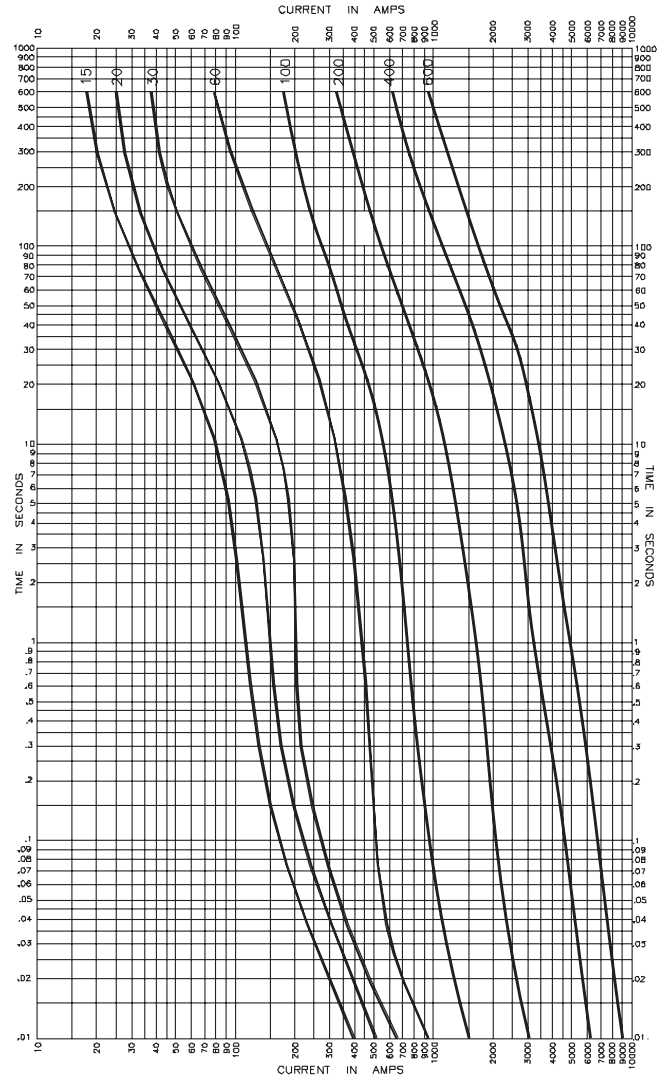
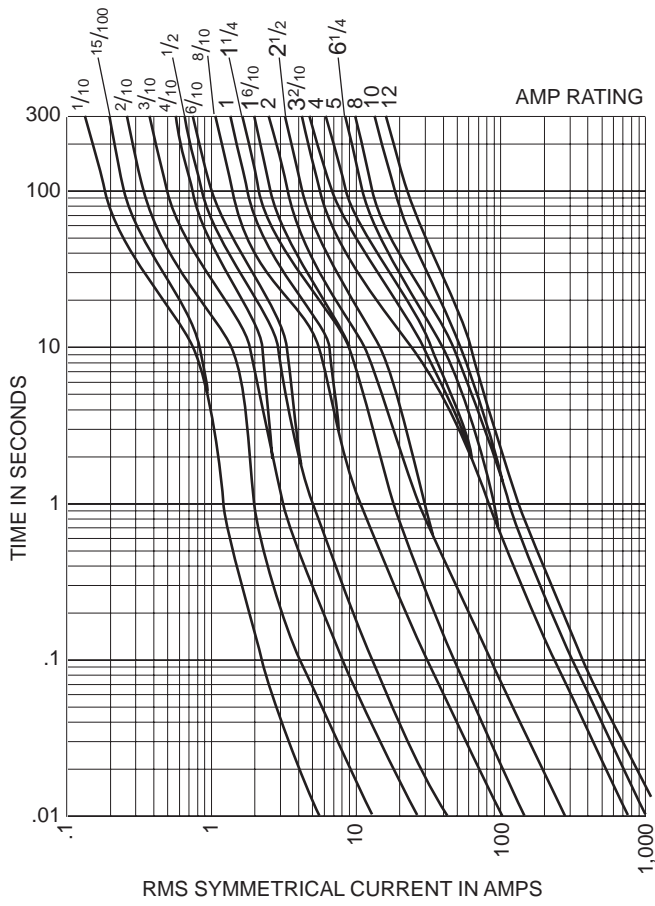

LESRK time-current curves — average melt

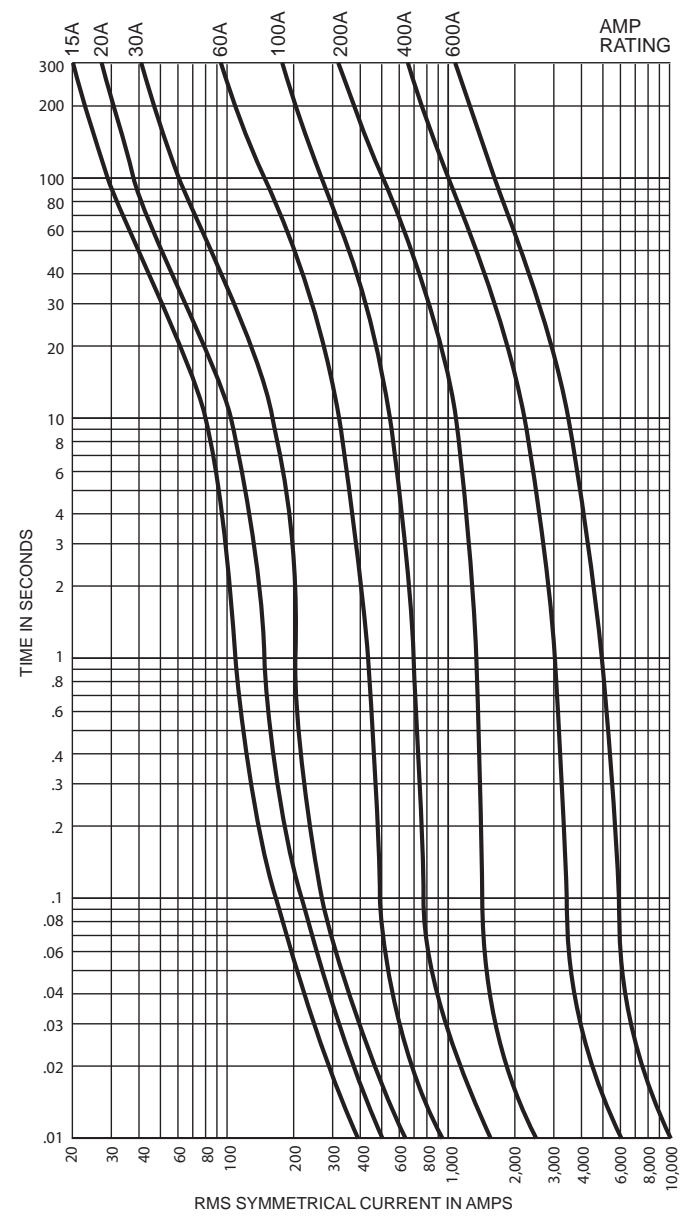
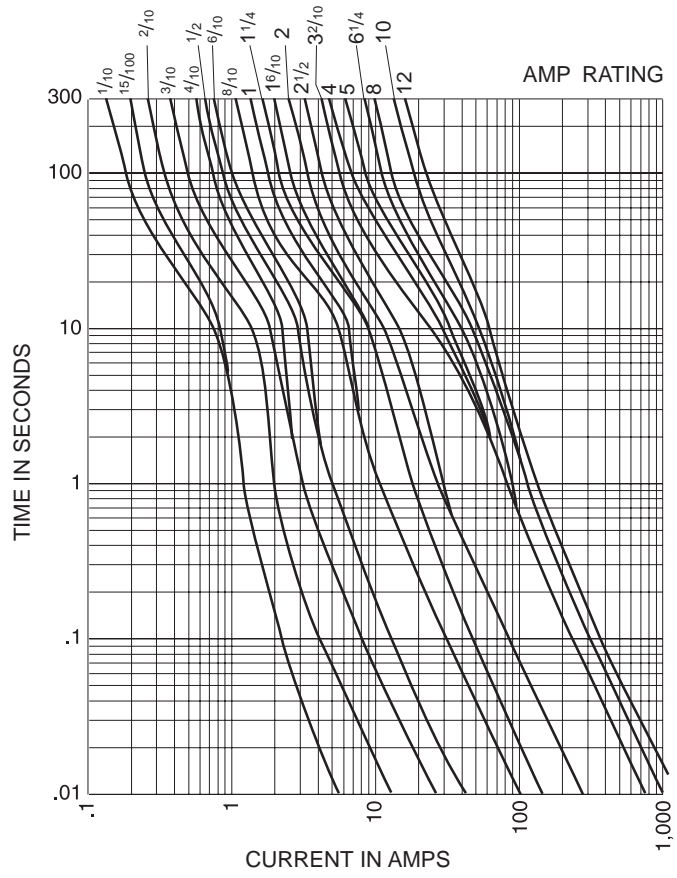

Peak let-through current curves

LENRK

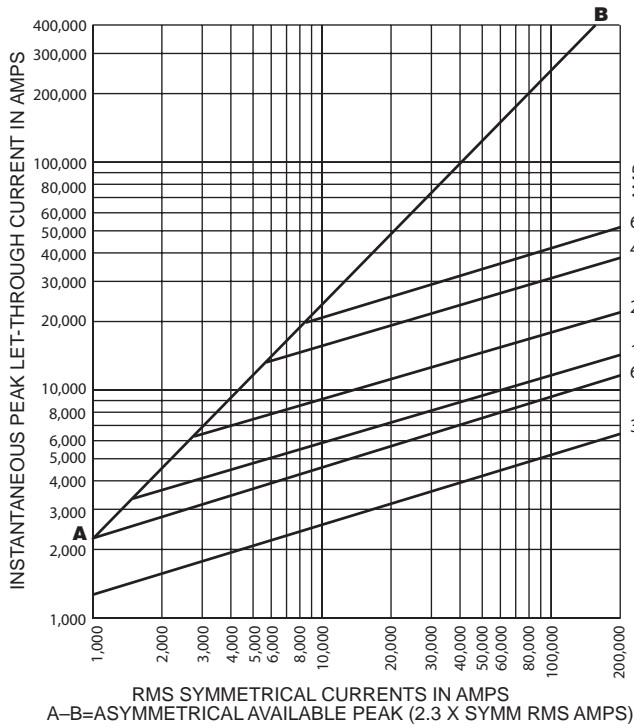

LESRK

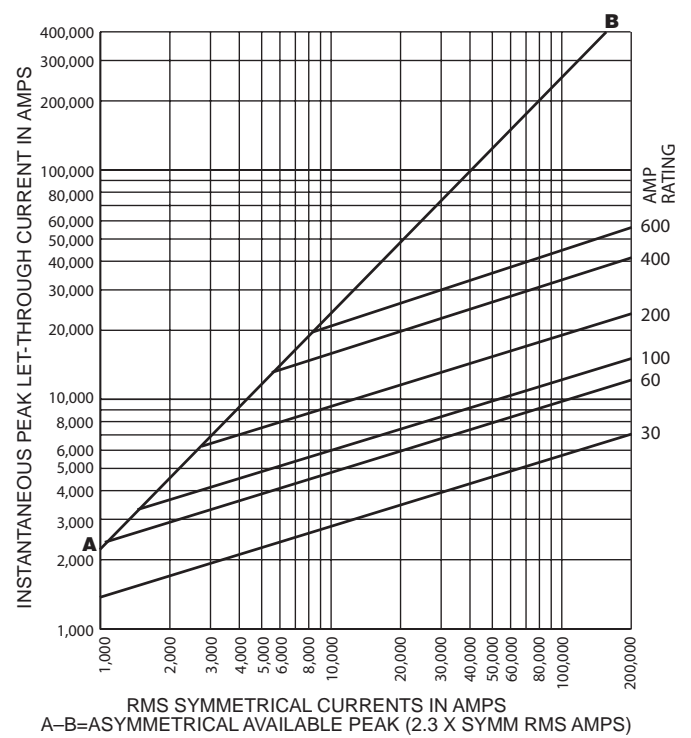

Current Limitation Tables*

LENRK RMS and peak let-through currents (kA)

Available fault current RMS amps	30		60		100		200		400		600	
	IRMS	Ip	IRMS	Ip	IRMS	Ip	IRMS	Ip	IRMS	Ip	IRMS	Ip
1,000	1	1	1	2	1	2	1	2	1	2	1	2
2,000	1	2	1	3	2	4	2	5	2	5	2	5
3,000	1	2	1	3	2	4	3	6	3	7	3	7
5,000	1	2	2	4	2	5	3	7	5	12	5	12
10,000	1	3	2	4	2	6	4	9	7	15	9	21
15,000	1	3	2	5	3	6	4	10	7	17	10	23
20,000	1	3	2	6	3	7	5	11	8	19	11	25
25,000	1	3	3	6	3	7	5	12	9	20	12	27
30,000	2	3	3	6	3	8	5	12	9	21	13	29
35,000	2	4	3	7	4	8	6	13	10	22	13	30
40,000	2	4	3	7	4	9	6	13	10	23	13	31
50,000	2	4	3	7	4	9	6	14	10	24	14	33
60,000	2	4	3	8	4	10	7	15	11	26	15	35
70,000	2	4	3	8	4	10	7	16	12	27	16	36
80,000	2	5	4	8	5	11	7	16	12	28	17	38
90,000	2	5	4	9	5	11	7	17	13	29	17	39
100,000	2	5	4	9	5	11	8	18	13	30	17	40
150,000	2	6	4	10	5	13	8	19	16	36	20	46
200,000	3	6	5	11	6	14	9	21	18	42	22	50

LESRK RMS and peak let-through currents (kA)

Available fault current RMS amps	Apparent effective let-through amps (kA)											
	30		60		100		200		400		600	
	IRMS	Ip	IRMS	Ip	IRMS	Ip	IRMS	Ip	IRMS	Ip	IRMS	Ip
1,000	1	1	1	2	1	2	1	2	1	2	1	2
2,000	1	2	1	3	2	4	2	4	2	4	2	4
3,000	1	2	1	3	2	4	3	6	3	7	3	7
5,000	1	2	2	4	2	5	3	7	5	12	5	12
10,000	1	3	2	5	3	6	4	9	7	16	9	21
15,000	1	3	2	5	3	7	5	11	8	18	10	24
20,000	1	3	3	6	3	7	5	12	8	19	11	26
25,000	2	4	3	6	3	8	5	12	9	21	12	28
30,000	2	4	3	6	4	8	6	13	10	22	13	30
35,000	2	4	3	7	4	9	6	14	10	23	13	31
40,000	2	4	3	7	4	9	6	14	10	24	14	32
50,000	2	5	3	8	4	10	7	15	11	26	15	35
60,000	2	5	3	8	4	10	7	16	12	28	16	37
70,000	2	5	4	8	5	11	7	17	13	29	17	39
80,000	2	5	4	9	5	11	8	18	13	30	17	40
90,000	2	5	4	9	5	12	8	18	13	31	18	42
100,000	2	6	4	9	5	12	8	19	14	32	19	44
150,000	3	6	5	11	6	14	9	21	16	36	22	50
200,000	3	7	5	12	7	15	10	23	17	40	23	54

* "Apparent Let-Through Amps" values are read from "Peak Let-Through Current Curves" and the peak current value divided by 2.3 Asymmetry Factor.



Catalog symbols

NCLR 1- 600 A, 250 Vac or Less

SCLR 1- 600 A, 600 Vac or Less

Specifications

- RK1 current limiting, fast-acting fuses

Ratings

- Volts
- 250 Vac (NCLR)
- 600 Vac (SCLR)
 - 250 Vdc (NCLR*)
 - 300 Vdc (SCLR*)

* Self certified

- Amps 1-600 A
- Interrupting Rating
 - 200 kA RMS Sym.
 - 10 kA DC

Agency Information

- UL Listed, Class RK1, Guide JDDZ, File E162363
- CSA Certified per C22.2, No. 248.12

Amp ratings					
NCLR					
1	10	35	80	175	400
3	12	40	90	200	450
4	15	45	100	225	500
5	20	50	110	250	600
6	25	60	125	300	—
8	30	70	150	350	—
SCLR					
1	8	30	70	175	450
2	10	35	80	225	500
3	12	40	90	250	600
4	15	45	100	300	—
5	20	50	110	350	—
6	25	60	125	400	—

Benefits

- No intentional time-delay opens quickly on overload current.

Applications

- Recommended for protection on non-inductive loads such as lighting and resistance heating circuits.
- Use to protect lower interrupting rating circuit breakers in series rated applications.

Recommended upgrade

- LENRK (250 Vac)/LESRK (600 Vac).

Cross reference			
Volts	Edison	Mersen	Littelfuse
250	NCLR	A2KR	KLNR
600	SCLR	A6KR*	KLSR*

* Larger body size on blade type.

Dimensions — in

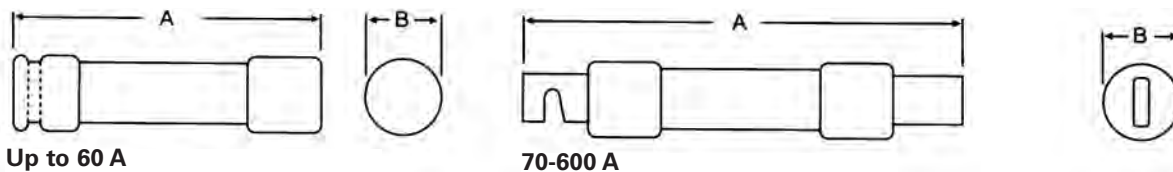

Catalog symbol	Amps	A	B
NCLR	Up to 30	2	0.56
	35-60	3	0.81
	70-100	5.88	1.10
	110-200	7.13	1.61
	225-400	8.63	2.38
	450-600	10.38	2.88
SCLR	Up to 30	5	0.81
	35-60	5.5	1.06
	70-100	7.88	1.11
	110-200	9.63	1.61
	225-400	11.63	2.36
	450-600	13.38	2.88

NCLR and SCLR time-current curves — average melt

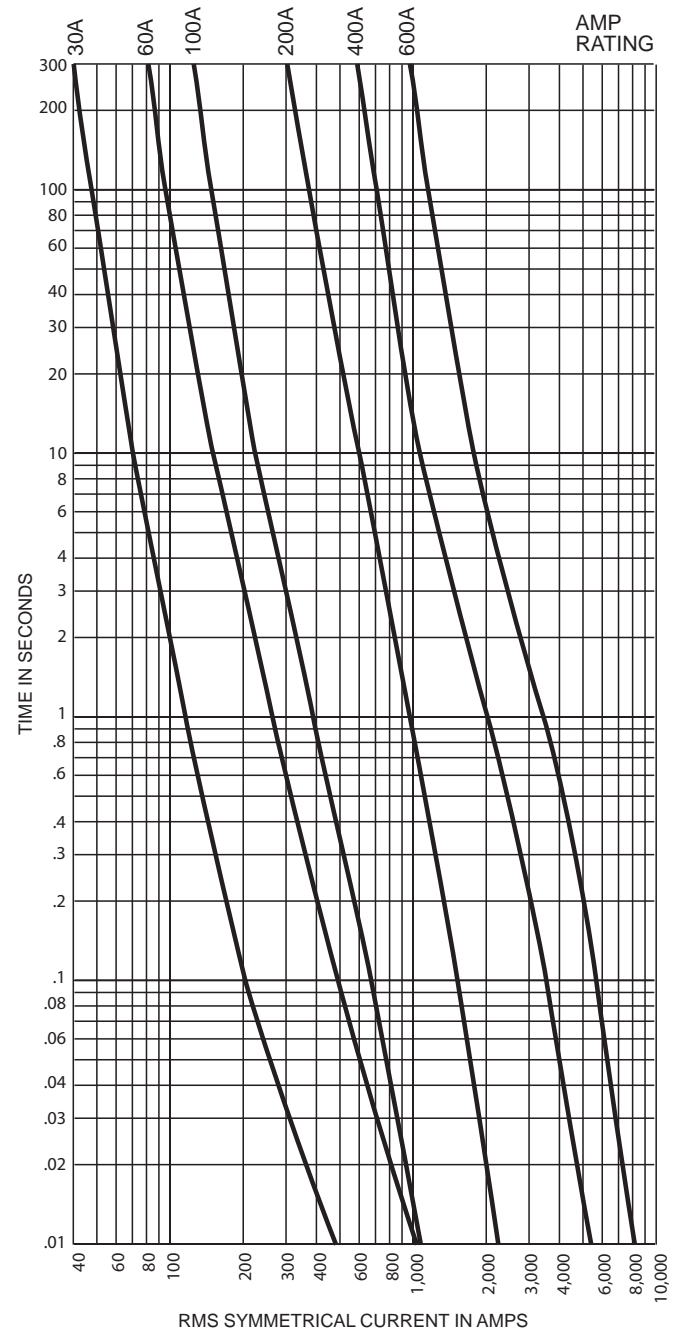

Application

Edison NCLR/SCLR Class RK1 fast-acting fuses are recommended for general power distribution system use for main, feeder and branch circuits having a high percentage of non-inductive loads such as heating and lighting. NCLR/SCLR fuses are suitable for circuit breaker protection. * When NCLR/SCLR fast-acting fuses are used for inductive loads, the fuses usually require oversizing to override normal transient current surges of motors and transformers. Oversizing fuses usually increases fuse and equipment cost and reduces overcurrent protection. (For inductive loads, LENRK/LESRK fuses are recommended). NCLR/SCLR Class RK1 fast-acting fuses are physically interchangeable with other Class R fuses. They will replace Class K or Class H fuses in standard fuse clips.

* When used as recommended by a specific circuit breaker manufacturer for a specific application.

Peak let-through current curves

NCLR

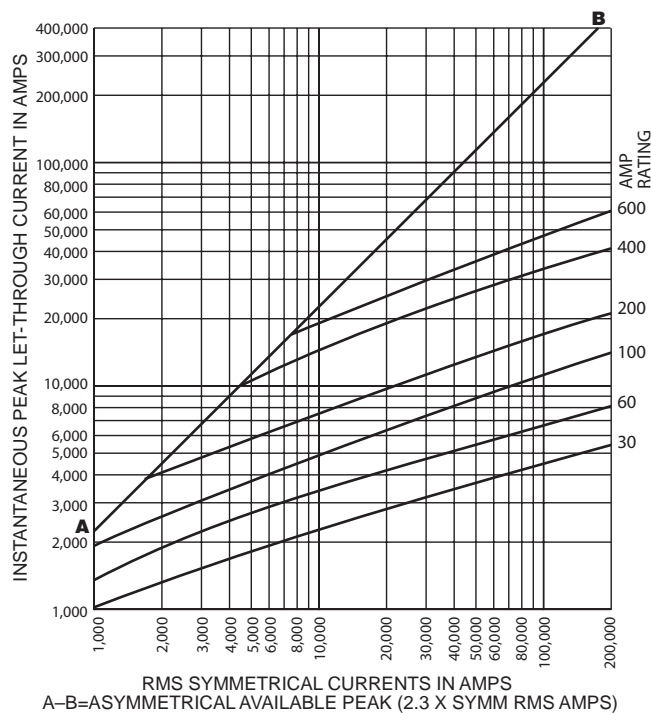

SCLR

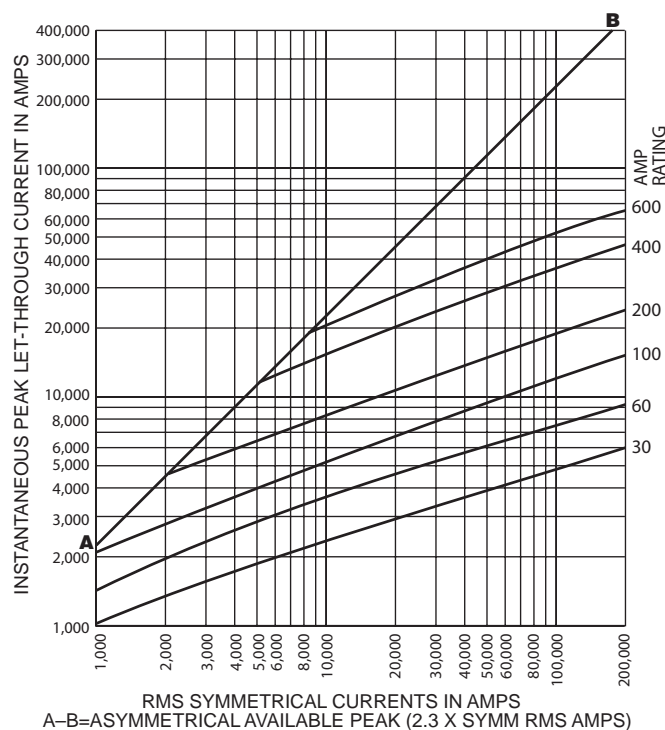

Current limitation tables*

NCLR – RMS and peak let-through currents (kA)

Prosp. S.C.C.	Fuse size											
	30		60		100		200		400		600	
	IRMS	I _p	IRMS	I _p	IRMS	I _p	IRMS	I _p	IRMS	I _p	IRMS	I _p
5,000	1	2	1	3	2	4	3	6	5	10	5	12
10,000	1	2	1	3	2	5	3	8	6	14	8	19
15,000	1	3	2	4	2	6	4	9	7	17	10	22
20,000	1	3	2	4	3	6	4	10	8	19	11	25
25,000	1	3	2	5	3	7	4	10	9	20	12	27
30,000	1	3	2	5	3	7	5	11	10	22	13	29
35,000	1	3	2	5	3	8	5	12	10	23	13	31
40,000	1	3	2	5	3	8	5	12	10	24	14	32
50,000	2	4	2	5	4	9	6	13	11	26	15	36
60,000	2	4	2	6	4	9	6	14	12	28	17	38
70,000	2	4	3	6	4	9	6	15	13	29	17	40
80,000	2	4	3	6	4	10	7	15	13	30	18	42
90,000	2	4	3	6	5	10	7	16	13	31	19	44
100,000	2	4	3	7	5	11	7	17	14	32	20	46
150,000	2	5	3	7	5	13	8	19	16	37	23	53
200,000	2	5	3	8	6	14	9	21	18	41	26	59

SCLR – RMS and peak let-through currents (kA)

Prosp. S.C.C.	Fuse size											
	30		60		100		200		400		600	
	IRMS	I _p	IRMS	I _p	IRMS	I _p	IRMS	I _p	IRMS	I _p	IRMS	I _p
5,000	1	2	1	3	2	4	3	6	5	12	5	12
10,000	1	2	2	4	2	5	4	8	7	15	9	20
15,000	1	3	2	4	3	6	4	10	8	18	11	24
20,000	1	3	2	5	3	7	5	11	9	20	12	28
25,000	1	3	2	5	3	7	5	12	10	22	13	31
30,000	1	3	2	5	3	8	5	13	10	24	14	33
35,000	2	4	2	5	4	8	6	13	11	25	15	35
40,000	2	4	2	6	4	9	6	14	11	26	16	37
50,000	2	4	3	6	4	9	6	14	12	28	17	40
60,000	2	4	3	6	4	10	7	15	13	30	19	43
70,000	2	4	3	7	5	10	7	16	14	32	20	45
80,000	2	4	3	7	5	11	7	17	14	33	21	48
90,000	2	5	3	7	5	12	8	18	15	35	22	50
100,000	2	5	3	7	5	12	8	19	16	36	23	52
150,000	2	5	4	8	6	14	9	21	18	41	26	60
200,000	3	6	4	9	7	15	10	23	20	46	29	66

* "Apparent Let-Through Amps" values are read from "Peak Let-Through Current Curves" and the peak current value divided by 2.3 Asymmetry Factor.



Catalog symbols

ECNR 1-600 A, 250 Vac or Less

ECSR 1-600 A, 600 Vac or Less

Specifications

- RK5 current limiting, dual-element, time-delay fuses

Ratings

- Volts
 - ECNR - 250 Vac
 - ECNR - 125 Vdc (1-60 A, 110-200 A), 250 Vdc (225-600 A)
 - ECSR - 600 Vac
 - ECSR - 300 Vdc (1-30 A, 70-600 A), 250 Vdc (35-60 A)
- Amps 1-600 A
- Interrupting Rating
 - 200 kA RMS Sym.
 - 20 kA DC

Agency Information

- UL Listed for US and Canada, Class RK5, File E162363, Guide JDDZ

Amp Ratings					
ECNR					
1	8	25	70	150	400
2	9	30	75	175	450
3	10	35	80	200	500
4	12	40	90	225	600
5	15	45	100	250	—
6	17.5	50	110	300	—
7	20	60	125	350	—
ECSR					
1	8	25	70	150	400
2	9	30	75	175	450
3	10	35	80	200	500
4	12	40	90	225	600
5	15	45	100	250	—
6	17.5	50	110	300	—
7	20	60	125	350	—

Benefits

- True dual-element construction allows sizing of 125% FLA for motor backup protection.
- Superior overload and cycling capabilities.
- Current limitation provides component short-circuit protection.

Applications

- Recommended for AC power distribution system mains, feeders, and branch circuits.
- Protection of motors and motor branch circuits.
- Protection of transformers and other inductive loads.
- All general-purpose applications including lighting, heating and other non-inductive loads.

Recommended fuse upgrade

- Class RK1 (LENRK/LESRK) for greater degree of short-circuit protection.

Cross reference			
Volts	Edison	Mersen	Littelfuse
250	ECNR	TR	FLNR
600	ECSR	TRS	FLSR

ECNR/ECSR dual element, time-delay fuses

These fuses are recommended for AC power distribution system mains, feeders and branch circuits having inductive loads (motors, transformers) or non-inductive loads (lighting, heating) where the available short-circuit current does not exceed 200 kA RMS Sym. These “dual-element, time-delay” fuses have minimum industry standard time-delay of 10 seconds at 5 times the fuse rating (8 sec. minimum for 250 V, 30 A and less). The time-delay characteristics of these fuses typically allows them to be sized closer to the running amps of inductive loads to reduce cost and provide improved overcurrent protection. These fuses will override normal equipment current surges to reduce unnecessary fuse openings. They are the most popular fuses used in the industry and the most economical for most applications, especially motors and transformers. They have moderate current limitation.

- Class R fuses will fit Class H, K and R fuse clips.
- Class R fuse clips will only accept Class R fuses.
- Fuses rated 600 Vac or less may be applied at any lower voltage.

Dimensions – in

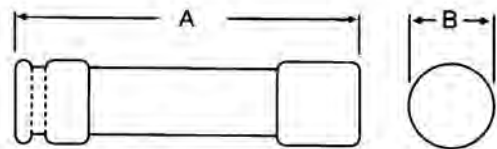

Up to 60 A

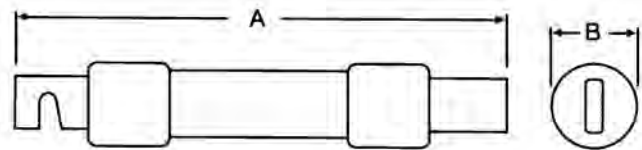

70-600 A

Catalog symbol	Amps	A	B
ECNR	Up to 30	2	0.56
	35-60	3	0.81
	70-100	5.88	1.06
	110-200	7.13	1.56
	225-400	8.63	2.38
	450-600	10.38	2.88
ECSR	Up to 30	5	0.81
	35-60	5.5	1.06
	70-100	7.88	1.11
	110-200	9.63	1.61
	225-400	11.63	2.34
	450-600	13.38	2.88

ECNR time-current curves — average melt

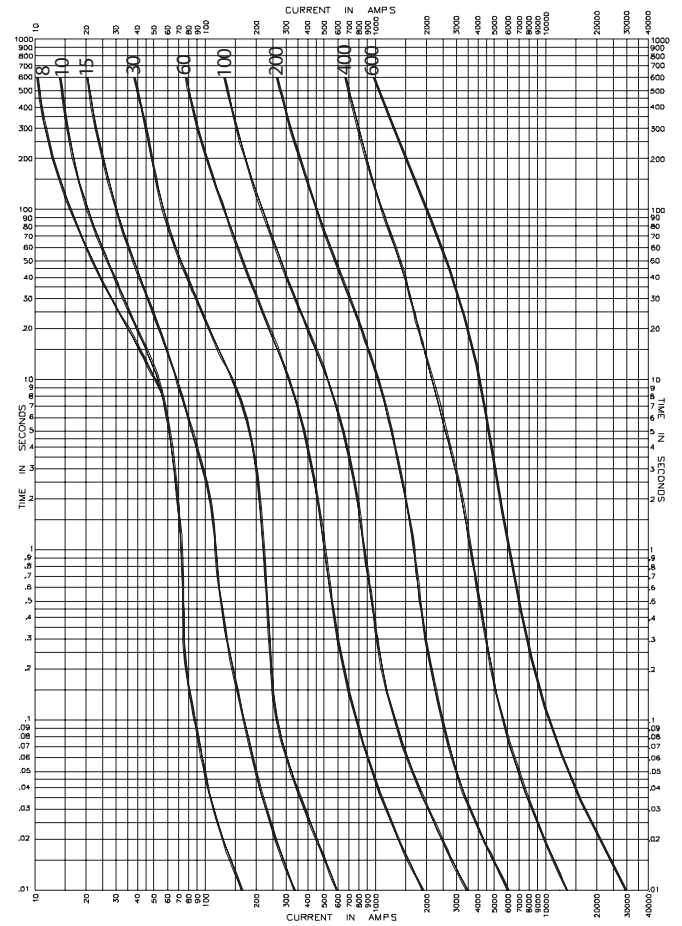
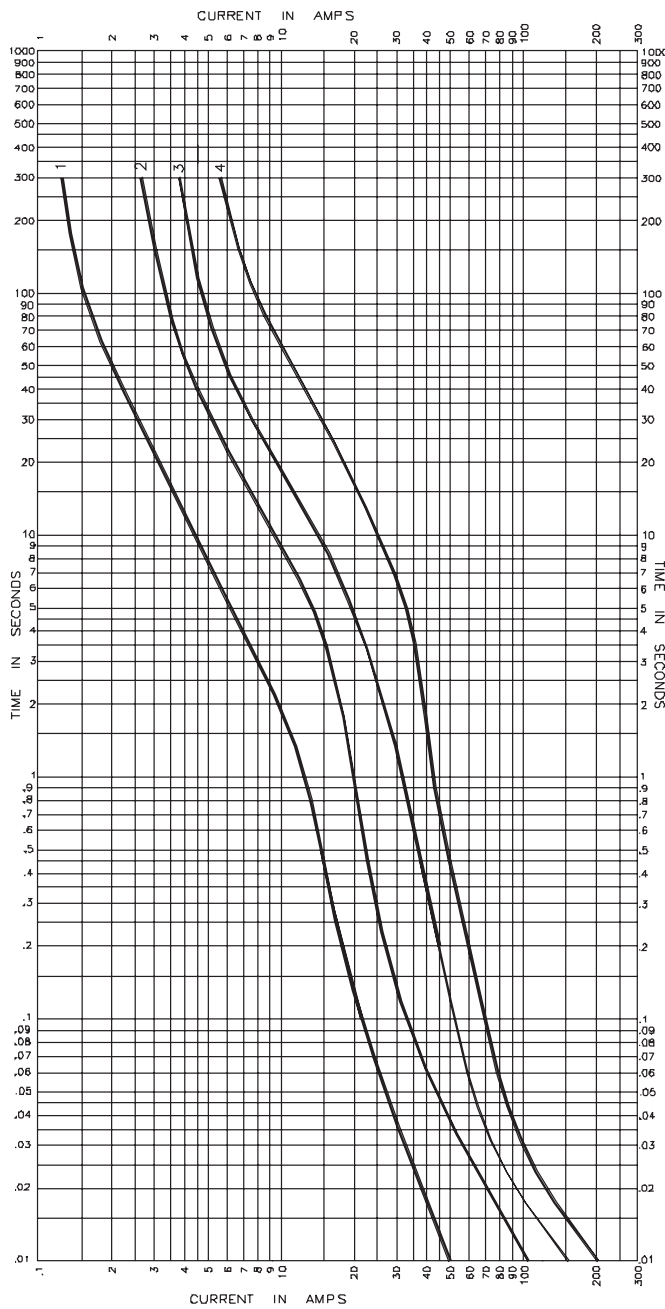

ECSR time-current curves – average melt

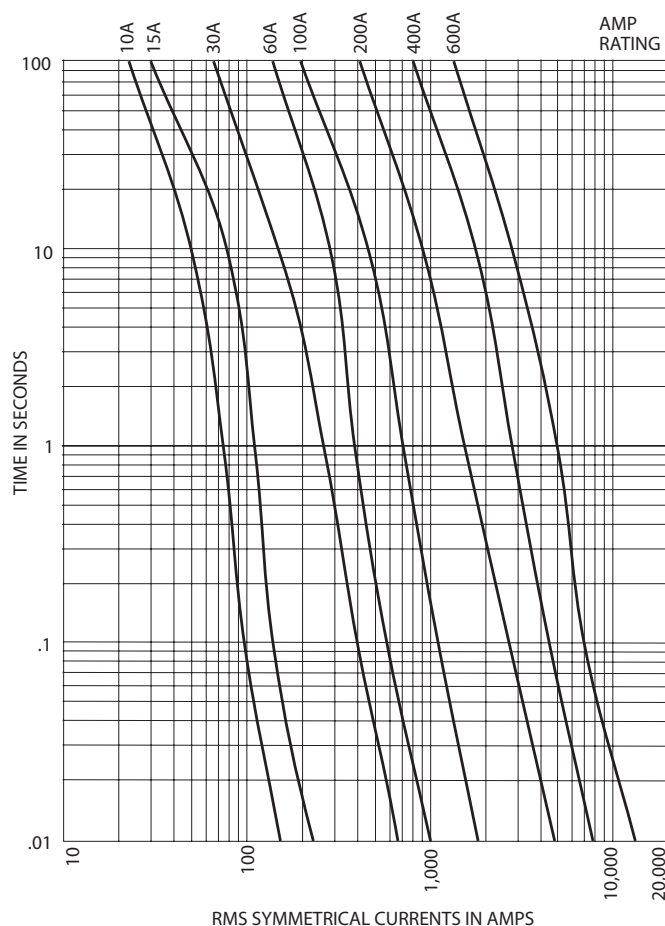
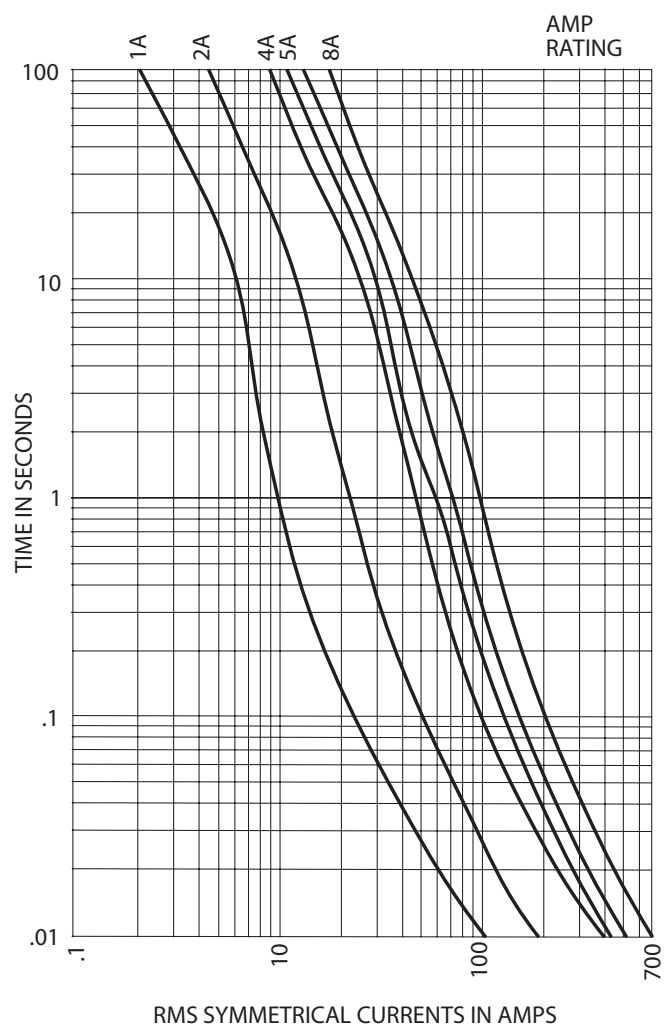

Peak let-through current curves

ECNR

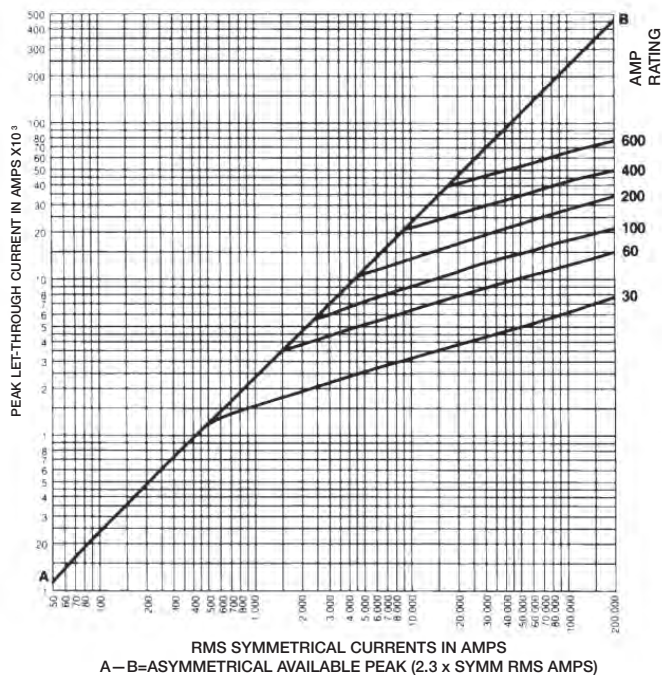

ECSR

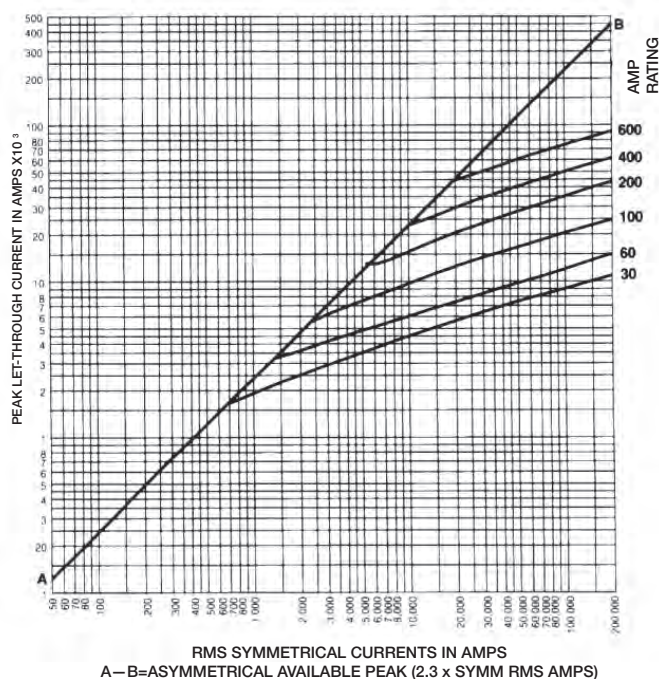

Current limitation tables

ECNR*

Available Fault Current RMS Amps	Apparent Effective Let-Through Amps Fuse Amp Ratings					
	30 A	60 A	100 A	200 A	400 A	600 A
5,000	1,050	2,070	2,820	4,300	5,000	5,000
10,000	1,310	2,570	3,630	5,400	8,700	10,000
15,000	1,490	2,920	4,140	6,200	9,900	15,000
20,000	1,630	3,200	4,500	6,800	10,700	16,100
25,000	1,720	3,420	4,800	7,200	11,400	17,200
30,000	1,840	3,630	5,100	7,700	12,100	18,300
35,000	1,920	3,810	5,400	8,100	12,600	19,200
40,000	2,000	3,980	5,600	8,500	13,100	19,900
50,000	2,140	4,200	6,000	9,100	14,000	21,400
60,000	2,260	4,500	6,400	9,600	14,900	22,600
80,000	2,450	4,900	7,000	10,600	16,000	24,600
100,000	2,620	5,200	7,500	11,400	17,100	26,200
150,000	2,920	5,800	8,300	13,000	19,200	29,200
200,000	3,140	6,200	8,900	14,300	20,800	31,700

ECSR*

Available Fault Current RMS Amps	Apparent Effective Let-through Amps Fuse Amp Ratings					
	30 A	60 A	100 A	200 A	400 A	600 A
5,000	1,290	2,070	2,980	5,000	5,000	5,000
10,000	1,640	2,590	3,810	6,500	8,800	10,000
15,000	1,890	2,940	4,400	7,500	10,200	15,000
20,000	2,110	3,250	4,800	8,300	11,400	18,200
25,000	2,260	3,470	5,200	8,900	12,400	19,600
30,000	2,420	3,660	5,500	9,600	13,200	21,100
35,000	2,570	3,850	5,800	10,100	14,100	22,400
40,000	2,670	4,030	6,000	10,500	14,700	23,400
50,000	2,890	4,300	6,500	11,400	16,000	25,300
60,000	3,060	4,500	6,900	12,100	17,200	27,000
80,000	3,360	4,900	7,600	13,400	19,100	29,500
100,000	3,630	5,200	8,200	14,400	20,700	31,700
150,000	4,100	5,800	9,300	16,500	23,900	36,300
200,000	4,400	6,100	10,400	18,300	26,700	39,500

* "Apparent Let-Through Amps" values are read from "Peak Let-Through Current Curves" and the peak current value divided by 2.3 Asymmetry Factor.

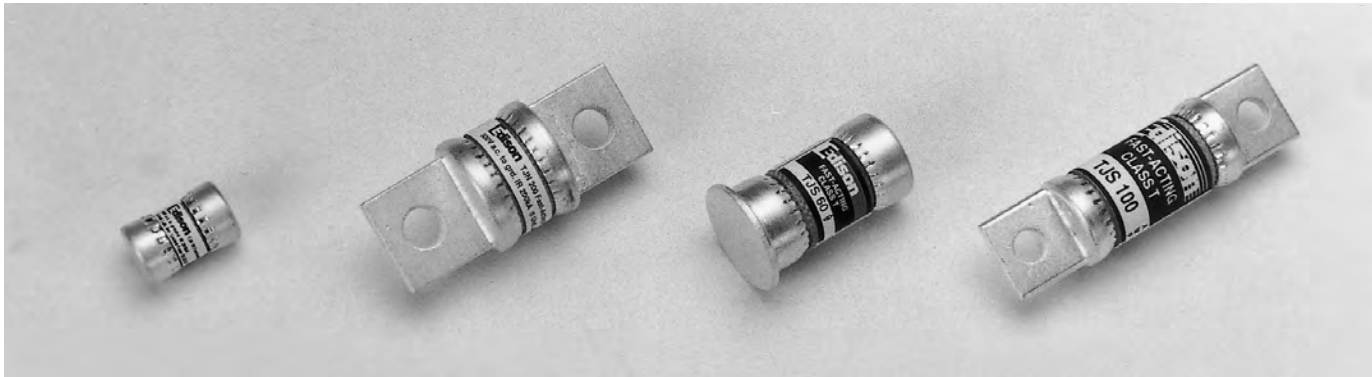

Catalog symbols

TJN 1-1200 A, 300 Vac or Less

TJS 1-800 A, 600 Vac or Less

Specifications

- Class T current limiting, extremely fast-acting fuses

Ratings

- Volts
 - 300 Vac (TJN)
 - 600 Vac (TJS)
 - 160 Vdc (TJN (15-600 A*))
 - 170 Vdc (TJN (601-1200 A*))
- * Self-certified DC Ratings.
- Amps
 - 1-1200 A (TJN)
 - 1-800 A (TJS)
- Interrupting Rating
 - 200 kA RMS Sym.
 - 20 kA DC (TJN (15-600 A))
 - 20 kA DC (TJN (15-600))
 - 100 kA DC (TJN (601-1200))

Agency Information

- UL Listed, Class T, File E162363, Guide JDDZ
- CSA Certified per C22.2, No. 248.15, LR700489

Amp ratings						
TJN						
1	30	70	150	350	800	
3	35	80	175	400	1000	
6	40	90	200	450	1200	
10	45	100	225	500	—	
15	50	110	250	600	—	
20	60	125	300	700	—	

TJS						
1	25	60	125	300	800	
3	30	70	150	350	—	
6	35	80	175	400	—	
10	40	90	200	450	—	
15	45	100	225	500	—	
20	50	110	250	600	—	

Edison Class T fuses are extremely fast-acting fuses in a compact, space saving size. These fuses are ideal as the main fuse protection for panelboards, load centers and meter stacks.

Benefits

- No intentional time-delay; opens quickly on overload.
- Extremely current-limiting silver link construction; provides superior short-circuit component protection.

Applications

- Recommended for protection of non-inductive loads, such as lighting and resistance heating circuits.
- Use to protect lower interrupting rating circuit breakers when series rated with Class T fuses.

Cross reference			
Volts	Edison	Mersen	Littelfuse
300	TJN	A3T	JLLN
600	TJS	A6T	JLLS

TJN time-current curves — average melt

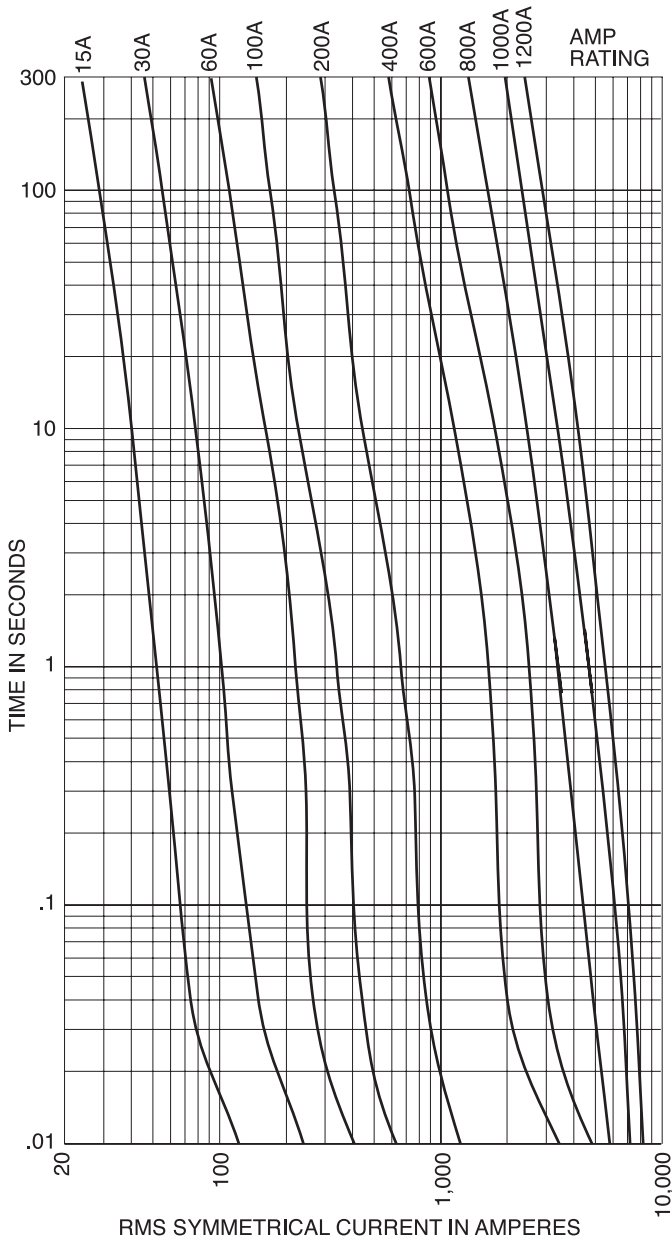

TJN peak let-through current curves

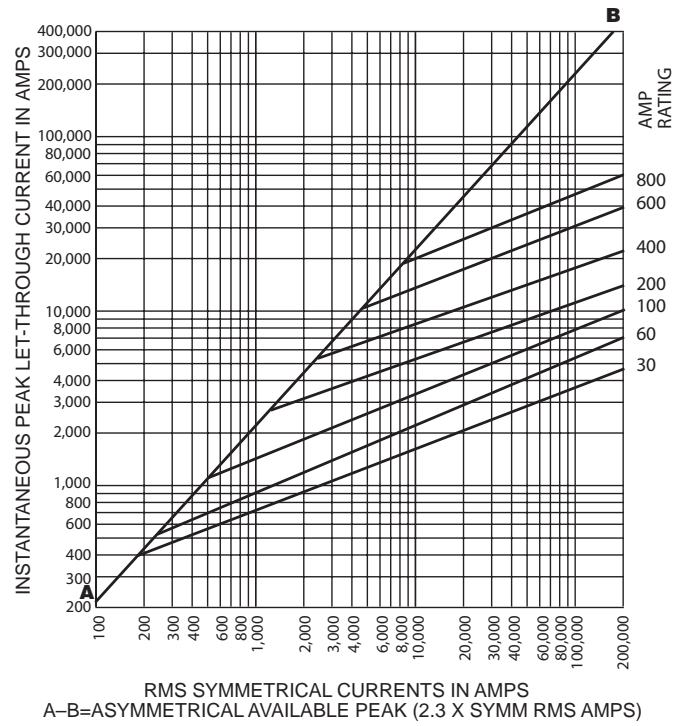

TJN Dimensions — in

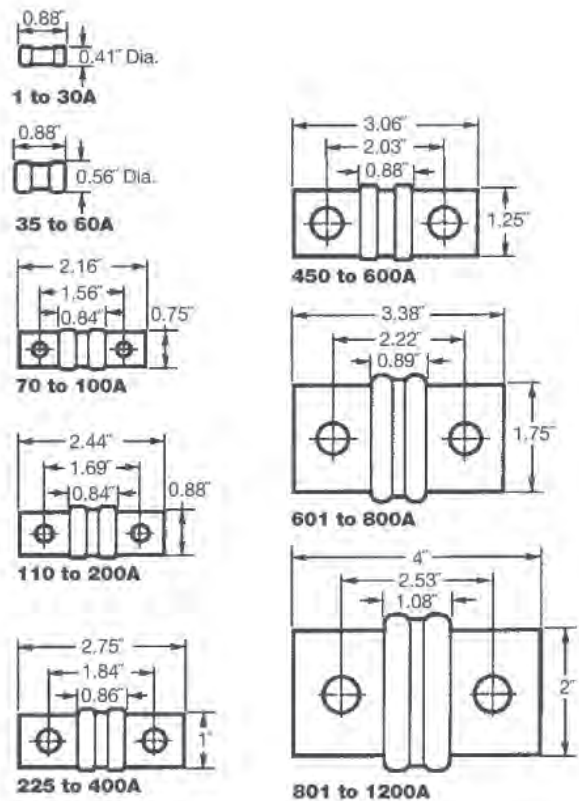

TJS time-current curves — average melt

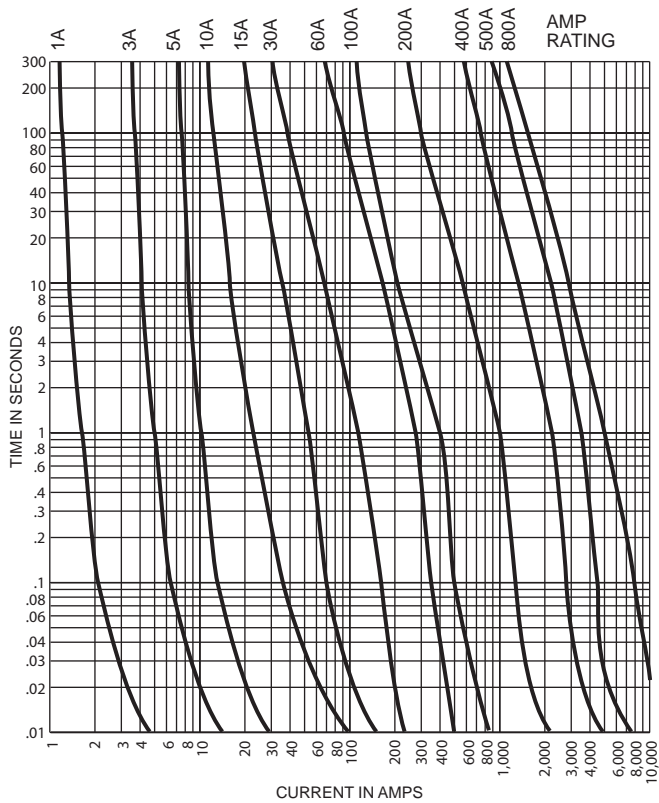

TJS peak let-through current curves

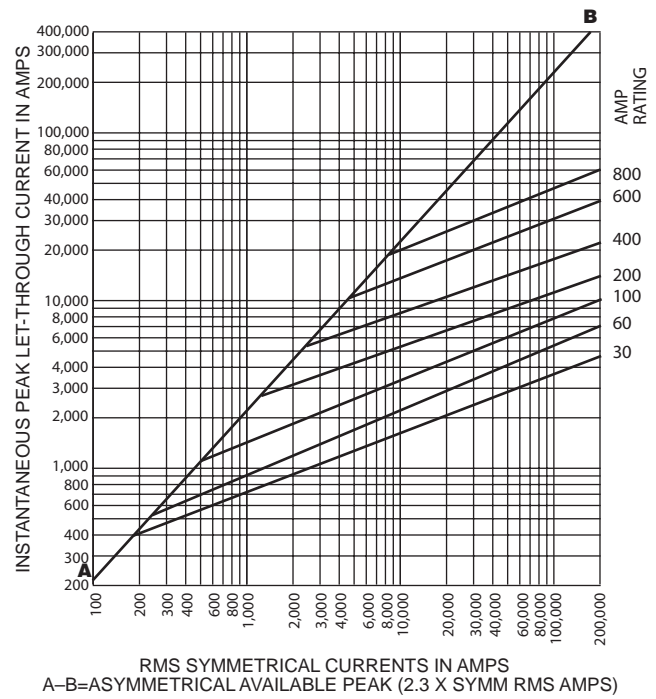

TJS Dimensions — in

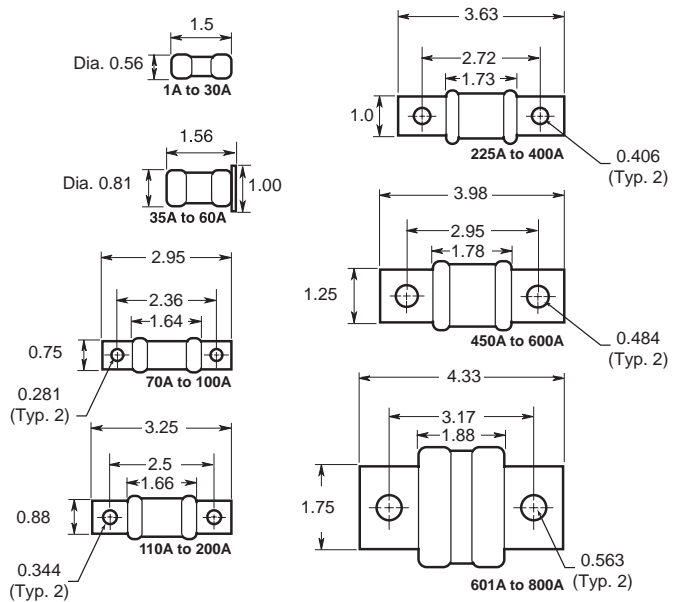

S rejection base dual element, time-delay plug fuses



Catalog symbol S 1/4-30 A, 125 Vac or less

Amp ratings					
1/4	1	2	3-1/2	6-1/4	14
3/10	1-1/8	2-1/4	4	7	15
4/10	1-1/4	2-1/2	4-1/2	8	20
1/2	1-4/10	2-8/10	5	9	25
6/10	1-6/10	3	5-6/10	10	30
8/10	1-8/10	3-2/10	6	12	—

Specifications

- Rejection base, dual-element, time-delay plug fuse

Ratings

- Volts 125 Vac
- Amps 1/4-30 A
- Interrupting rating 10 kA RMS Sym.

Agency information

- UL Listed
 - File E56412, Guide JFHR (0-6-1/4 A)
 - File E12112, Guide JEFV (1-30 A)
- CSA Certified per C22.2, No. 248.4

Benefits

- Size rejection feature helps to prevent overfusing.
- Heavy duty dual-element construction.
- Superior overload and short-circuit protection.

Cross reference		
Edison	Mersen	Littelfuse
S	—	SOO

SL rejection base time-delay plug fuses



Catalog symbol SL 15-30 A, 125 Vac or less

Amp ratings			
15	20	25	30

Specifications

- Rejection base, time-delay plug fuse

Ratings

- Volts 125 Vac
- Amps 15-30 A
- Interrupting rating 10 kA RMS Sym.

Agency information

UL Listed, File 12112, Guide JEFV

Benefits

- Size rejection feature helps to prevent overfusing.
- Time-delay construction withstands light motor loads.

Recommended upgrade

- “S” dual element, time-delay fuse.

Cross reference		
Edison	Mersen	Littelfuse
SL	GSL	SLO

SA rejection base plug fuse adapters



Catalog symbol SA

Rejection base Type S and SL fuses can be retrofitted into standard Edison base sockets using Fustat™ adapters. Once installed, rejection base adapters accept only rejection base fuses for the adapter’s specified amp range. This helps prevent installing the wrong fuse size. When correctly specified, SA adapters can provide both motor running and short-circuit protection.

Agency information

UL Listed, File E12853 and CSA Certified File #6225-01, File #47235.

SA adapter catalog no.	Accepts fuses amp range	Accepts fuse type
SA-1	1 A or less	S
SA-1-1/4	1-1/4 A or less	S
SA-1-6/10	1-6/10 A or less	S
SA-2	1-8/10 to 2 A	S
SA-2-1/2	1-8/10 to 2-1/2 A	S
SA-3-2/10	1-8/10 to 3-2/10 A	S
SA-4	3-1/2 to 4 A	S
SA-5	3-1/2 to 5 A	S
SA-6-1/4	3-1/2 to 6-1/4 A	S
SA-8	7 to 8 A	S
SA-10	7 to 10 A	S
SA-15	7 to 15 A	S, SL
SA-20	20 A	S, SL
SA-30	20 to 30 A	S, SL

Cross reference		
Edison	Mersen	Littelfuse
SA	SAG	SAO

W Edison base fast-acting plug fuses



Catalog symbol W 1/2-12 A, 125 Vac or less

Amp ratings				
1/2	2	4	6-1/2	10
1	2-1/2	5	7	12
1-8/10	3	6	8	Dummy

Specifications

- Fast-acting Edison base plug fuse

Ratings

- Volts 125 Vac
- Amps 1/2-12 A
- Interrupting rating 10 kA RMS Sym.

Agency information

- UL Listed, File E 12112, Guide JEFV

Benefits

- General purpose for non-inductive lighting and heating loads.
- Economical.
- Edison base threads into non-rejection fuse receptacles.

Recommended upgrade

- Time-delay T or dual element, time-delay T fuses.
- Replace obsoleted 15 to 30 A W plug fuses with T and TL plug fuses.

Recommended box cover units

- Refer to page 53 in this catalog.

Cross reference		
Edison	Mersen	Littelfuse
W	GW	WOO

T Edison base dual element, time-delay plug fuses



Catalog symbol T 3/10-30 A, 125 Vac or less

Amp ratings					
3/10	1-1/8	2-1/4	4	7	15
4/10	1-1/4	2-1/2	4-1/2	8	20
1/2	1-4/10	2-8/10	5	9	25
6/10	1-6/10	3	5-6/10	10	30
8/10	1-8/10	3-2/10	6	12	—
1	2	3-1/2	6-1/4	14	—

Specifications

- Dual-element, time-delay Edison base plug fuse

Ratings

- Volts 125 Vac
- Amps 3/10-30 A
- Interrupting rating 10 kA RMS Sym.

Agency information

- UL Listed, File E 12112, Guide JEFV

Benefits

- Heavy duty dual-element construction for motor circuits.
- Edison base threads into non-rejection fuse receptacles.
- Superior overload and short-circuit protection.

Recommended box cover units

- Refer to page 53 in this catalog.

Cross reference		
Edison	Mersen	Littelfuse
T	GT	TOO

TL Edison base time-delay plug fuses



Catalog symbol TL 15-30 A, 125 Vac or less

Amp ratings			
15	20	25	30

Specifications

- Time-delay Edison base plug fuse

Ratings

- Volts 125 Vac
- Amps 15-30 A
- Interrupting rating 10 kA RMS Sym.

Agency information

- UL Listed, File 12112, Guide JEFV

Benefits

- Time-delay construction withstands light motor loads.
- Edison base threads into non-rejection fuse receptacles.

Recommended upgrade

- Dual element, time-delay T fuses.

Recommended box cover units

- Refer to page 53 in this catalog.

Cross reference		
Edison	Mersen	Littelfuse
TL	GTL	TLO

CSA Edison plug fuses and fuse reducers

TC time-delay CSA Edison base plug fuses



Catalog symbol TC 15-30 A, 125 Vac or less

Amp ratings			
TC-15PK4	TC-20PK4	TC-25PK4	TC-30PK4

Specifications

- Dual element, time-delay CSA Edison base plug fuse

Ratings

- Volts 125 Vac
- Amps 15-30 A
- Interrupting rating 10 kA RMS Sym.

Agency information

- CSA Certified, Class 1423-01, File #53787.

Benefits

- “D” rating for Canadian applications.
- Heavy Duty TC fuses are industrial strength products, featuring a exclusive Dual-Element construction.
- This spring loaded design provides superior short-circuit and overload protection.
- The TC fuses have more time-delay than the medium duty fuses in order to better protect industrial motors and optical residential circuits.

Cross reference		
Edison	Mersen	Littelfuse
T	GT	TOO

P one-time CSA Edison base plug fuses



Catalog symbol P 15-30 A, 125 Vac or less

Amp ratings			
P-15PK4	P-20PK4	P-25PK4	P-30PK4

Specifications

- Dual-element, one-time CSA Edison base plug fuse

Ratings

- Volts 125 Vac
- Amps 15-30 A
- Interrupting rating 10 kA RMS Sym.

Agency information

- CSA Certified

Benefits

- For non-inductive loads.
- Edison base threads into non-rejection fuse receptacles.

Reducers for Class J fuses (JDL, JFL)



Catalog no.	Fuse amp range	Equipment/ block amps
J-63	1-30	60
J-13	1-30	100
J-16	35-60	100
J-26	35-60	200 [†]
J-21	70-100	200 [†]
J-41	70-100	400 [†]
J-42 ^{††}	110-200	400 [†]
J-62	110-200	600 [†]
J-64	225-400	600 [†]

[†] Not for bolt-on applications.
^{††} Not compatible with JFL fuses.

Reducers for Class H(K) and R fuses

Agency information

- UL Listed, Guide IZZR, File E12853
- CSA Certified, Class 6225-01, File 47235

Catalog no.			
250 V	600 V	Fuse amp range	Equip./ block amps
Class R reducers (ECNR, ECSR, LENRK, LESRK, NCLR, SCLR)			
NO.263-R	NO.663-R	Up to 30	60
NO.213-R	NO.216-R	Up to 30	100
NO.216-R	NO.616-R	35-60	100
NO.226-R	NO.626-R	35-60	200
NO.2621-R [†]	NO.2621-R [†]	70-100	200
NO.2641-R [†]	NO.2641-R [†]	70-100	400
NO.242-R [†]	NO.642-R [†]	110-200	400
NO.2661-R [†]	NO.2661-R [†]	70-100	600
NO.2662-R [†]	NO.2662-R [†]	110-200	600
NO.2664-R* [†]	NO.2664-R* [†]	225-400	600
Class H(K) reducers (KON, KOS, REN, RES)			
NO.263	NO.663	Up to 30	60
NO.213	NO.216	Up to 30	100
NO.216	NO.616	35-60	100
NO.226	NO.626	35-60	200
NO.2621	NO.2621	70-100	200
NO.2641 [†]	NO.2641 [†]	70-100	400
NO.2642	NO.2642	110-200	400
NO.2661 [†]	NO.2661 [†]	70-100	600
NO.2662 [†]	NO.2662 [†]	110-200	600
NO.2664 [†]	NO.2664 [†]	225-400	600

* Single reducer only, pair not required.
[†] Not CSA Certified.



Catalog symbol MCL 0.1-30 A, 600 Vac or less

Amp ratings				
0.1	0.75	3.5	9	30
0.125	1	4	10	—
0.2	1.5	5	12	—
0.25	2	6	15	—
0.3	2.5	7	20	—
0.5	3	8	25	—

Specifications

- Fast-acting 13/32" x 1-1/2" fuse

Ratings

- Volts 600 Vac
- Amps 0.1-30 A
- Interrupting rating 100 kA RMS Sym.

Agency information

- UL Listed, File E162443, Guide JDYX
- CSA Certified LR700489

Benefits

- Compact dimensions.
- High interrupting rating.
- Fast-acting design responds quickly to both overloads and short-circuit current.

Applications

- Street lighting holders, HID lighting, control circuits, electronic equipment protection.

Cross reference		
Edison	Mersen	Littelfuse
MCL	ATM	—



Catalog symbol MOL 0.5-30 A, 250 Vac or less

Amp ratings				
0.5	2.5	6	12	30
1	3	8	15	—
1.5	4	9	20	—
2	5	10	25	—

Specifications

- Fast-acting 13/32" x 1-1/2" fuse

Ratings

- Volts
 - 250 Vac (0.5-15 A)
 - 125 Vac (20-30 A)
- Amps 0.5-30 A
- Interrupting ratings
 - 10 kA @ 125 Vac 2/10-30 A
 - 35 A @ 250 Vac 0.5-1 A
 - 100 A @ 250 Vac 1.5-6 A
 - 200 A @ 250 Vac 6.5-10 A
 - 750 A @ 250 Vac 12-15 A
 - 200 A @ 250 Vac 20-30 A

Agency information

- UL Listed, File E162443, Guide JDYX
- CSA Certified LR700489

Benefits

- Compact dimensions.
- Economical laminated paper tube design.

Applications

- Supplemental protection for non-inductive control and lighting circuits.

Cross reference		
Edison	Mersen	Littelfuse
MOL	OTM	BLF



Catalog symbol EBS 0.2-5 A (600 Vac), 6-10 A (250 Vac)

Amp ratings				
0.2	0.8	1.8	5	10
0.4	1	2	6	—
0.5	1.5	3	7	—
0.75	1.6	4	8	—

Specifications

- Fast-acting 13/32" x 1-3/8" fuse

Ratings

- Volts
 - 600 Vac (0.2-5 A)
 - 250 Vac (6-10 A)
- Amps 0.2-10 A
- Interrupting rating 10 kA RMS Sym.

Agency information

- UL Listed, File E162443, Guide JDYX
- CSA Certified LR700489

Benefits

- Compact dimensions.
- Shorter than standard midget dimensions.
- Economical design.

Applications

- Supplemental protection for non-inductive control and lighting circuits.

Cross reference		
Edison	Mersen	Littelfuse
EBS	None	BLS

Time-current curves — average melt

MCL

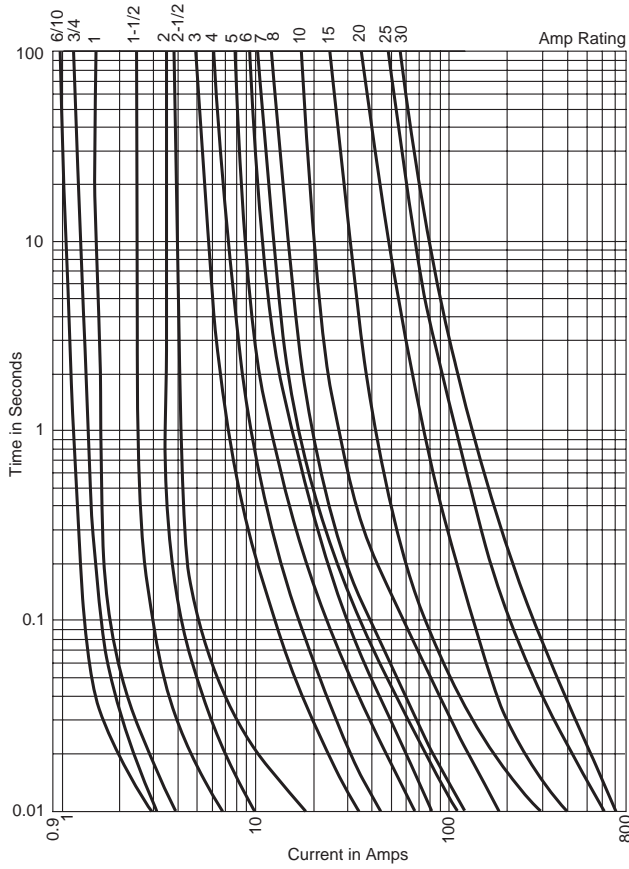

MOL

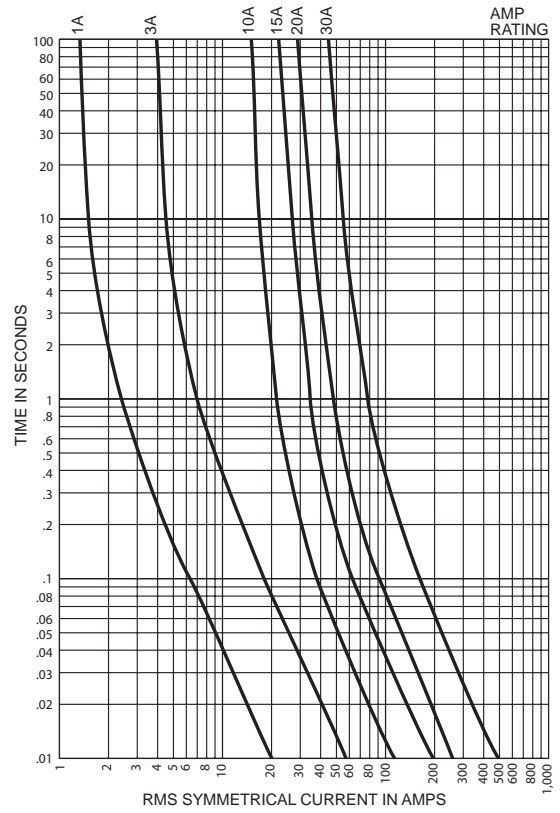

EBS

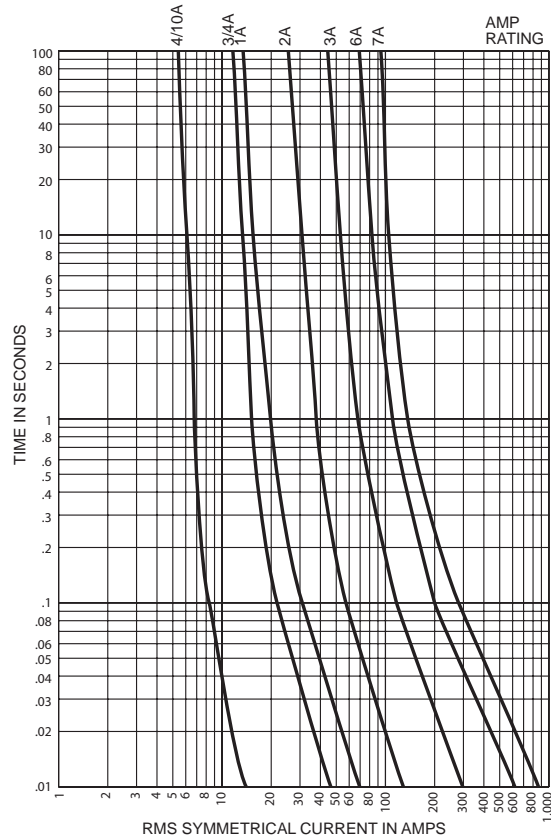



Catalog symbol MEQ 0.1-30 A, 500 Vac or less

Amp ratings					
0.1	0.6	2.25	5.6	15	
0.125	0.8	2.5	6	20	
0.15	1	3	6.25	25	
0.2	1.125	3.2	7	30	
0.25	1.25	3.5	8	—	
0.3	1.5	4	9	—	
0.4	1.6	4.5	10	—	
0.5	2	5	12	—	

Specifications

- Time-delay 13/32" x 1-1/2" fuse

Ratings

- Volts 500 Vac
- Amps 0.1-30 A
- Interrupting rating 10 kA RMS Sym.

Agency information

- UL Listed, File E162443, Guide File JDYX
- CSA Certified, LR700489

Benefits

- Compact dimensions.
- Fiber tube construction.
- Time-delay allows harmless inductive surges to pass without needless fuse opening.

Applications

- Supplemental protection of transformers, solenoids, and other high inrush circuits.
- For motor applications, refer to EDCC.

Cross reference		
Edison	Mersen	Littelfuse
MEQ	ATQ	FLQ



Catalog symbol MEN 0.1-30 A, 250 Vac or less

Amp ratings					
0.1	0.8	2	4.5	10	
0.15	1	2.25	5	12	
0.2	1.125	2.5	5.6	15	
0.25	1.25	2.8	6	20	
0.3	1.4	3	6.25	25	
0.4	1.5	3.2	7	30	
0.5	1.6	3.5	8	—	
0.6	1.8	4	9	—	

Specifications

- Time-delay 13/32" x 1-1/2" fuse

Ratings

- Volts 250 Vac
- Amps 0.5-30 A
- Interrupting rating 10 kA RMS Sym. @ 125 Vac

Agency information

- UL Listed, File E162443 ,Guide JDYX (12-30 A)
- CSA Certified, LR700489

Benefits

- Compact dimensions.
- Fiber tube construction.
- Dual-element construction allows harmless inductive surges to pass without opening.

Applications

- Supplemental protection of small motors, transformers, solenoids, and other high inrush power electronic circuits.

Cross reference		
Edison	Mersen	Littelfuse
MEN	TRM	FLM



Catalog symbol MID 0.1-6 A (250 Vac), 6.25-15 A (125 Vac), 20-30 A (32 Vac)

Amp ratings					
0.1	1	2.25	5.6	15	
0.15	1.125	2.5	6	20	
0.2	1.25	2.8	6.25	25	
0.3	1.4	3	7	30	
0.4	1.5	3.2	8	—	
0.5	1.6	3.5	9	—	
0.6	1.8	4	10	—	
0.8	2	5	12	—	

Specifications

- Pin indicating, time-delay 13/32" x 1-1/2" fuse, 12-30 A are dual-tube constructions

Ratings

- Volts
 - 250 Vac (0.1-0.8 A)
 - 125 Vac (1-15 A)
 - 32 Vac (20-30 A)
- Amps 0.1-30 A
- Interrupting ratings
 - 10 kA @ 125 Vac (1/10-15 A)
 - 1000 A @ 32 Vac (20-30 A)
 - 35 A @ 250 Vac (1/10-8/10 A)

Agency information

- UL Listed, File E162443, Guide JDYX (1-15 A)
- CSA Certified, LR700489

Benefits

- Compact dimensions.
- Silver-plated pin indicates when fuse is opened. Provides positive electrical signal activation.

Applications

- Supplemental protection for high inrush power electronic circuits.

Cross reference		
Edison	Mersen	Littelfuse
MID	GFN	FLA

Time-current curves — average melt

MEQ

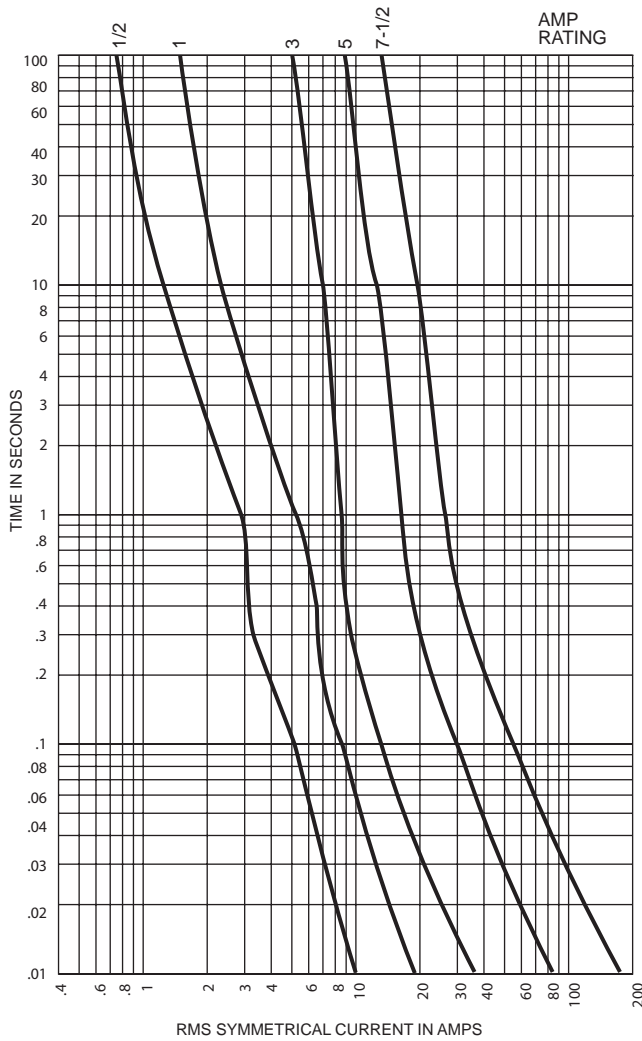

MEN

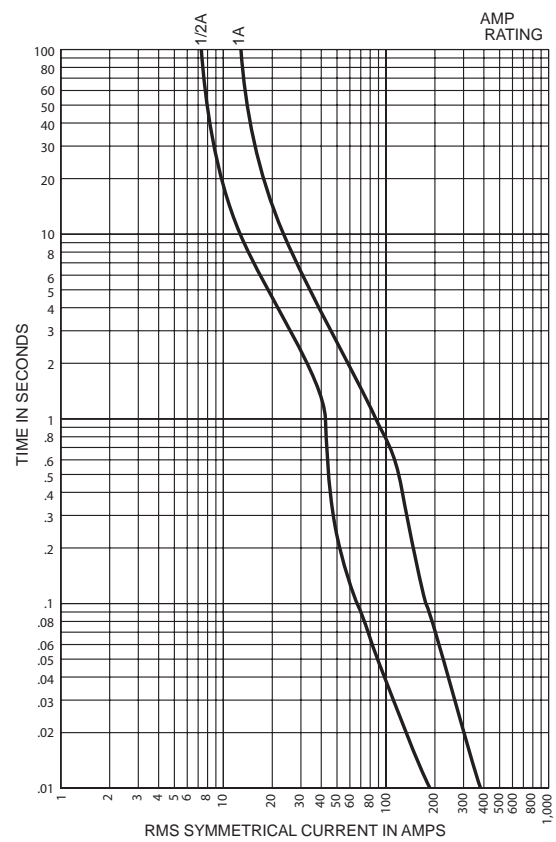

MID

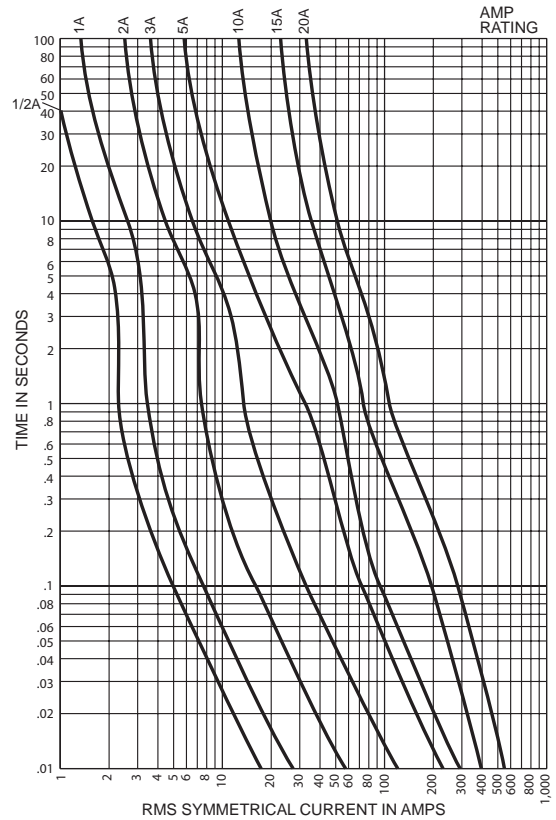

Glass tube fuses



Catalog symbol SFE, 4-30 A, 32 Vdc

Catalog no.	Amps	Length (in.)
SFE-4	4	5/8
SFE-6	6	3/4
SFE-7-1/2	7-1/2	7/8
SFE-9	9	7/8
SFE-14	14	1-1/16
SFE-20	20	1-1/4
SFE-30	30	1-7/16

Specifications

- 1/4" diameter, fast-acting, size-rejecting glass tube fuse.

Ratings

- Volts 32 V
- Amps 4-30 A

Agency information

- UL Listed, File AU169, Guide FHXT

Cross reference		
Edison	Mersen	Littelfuse
SFE	—	307

Blade fuses



Catalog symbols ATM, ATC and MAX

Specifications

Fast-acting automotive-style blade fuses.

Ratings

- Volts 32 Vdc
- Amps
 - 2-30 A (ATM)
 - 1-40 A (ATC)
 - 20-80 A (MAX)
- IR 1 kA

Agency information

- ATM — UL Listed, File AU169, Guide FHXT
- ATC — UL Recognized, File E56412, Guide JFHR2, SAE Standard J1284.

Features and benefits

- Color coded for easy fuse rating identification.

Typical applications

- Automotive
- Low voltage control circuits

ATM Catalog no. (amps)	Color code
ATM-1	Black
ATM-2	Gray
ATM-3	Violet
ATM-4	Pink
ATM-5	Tan
ATM-7-1/2	Brown
ATM-10	Red
ATM-15	Blue
ATM-20	Yellow
ATM-25	Clear
ATM-30	Green

ATC catalog no. (amps)	Color code
ATC-1	Black
ATC-2	Gray
ATC-3	Violet
ATC-4	Pink
ATC-5	Tan
ATC-7-1/2	Brown
ATC-10	Red
ATC-15	Blue
ATC-20	Yellow
ATC-25	Clear
ATC-30	Green
ATC-35	Blue-Green
ATC-40	Orange
MAX Catalog no. (amps)	Color code
MAX-20	Yellow
MAX-25	Grey
MAX-30	Green
MAX-35	Brown
MAX-40	Orange
MAX-50	Red
MAX-60	Blue
MAX-70	Tan
MAX-80	Clear

Cross reference			
Edison	Old Edison	Ferraz	Littelfuse
ATM	—	AF2	MIN
ATC	BTC	AF	ATO
MAX	—	AF3	MAX

Small dimension (electronic) fuses

5 x 20 mm — IEC Standards

S501 ferrule (GDA[†]) and S501-V
Axial lead fast-acting high breaking capacity 5x20 mm ceramic tube fuses



Ratings

- Volts
 - 250 Vac (or less)
 - 32 Vdc (self certified)
- Amps 50mA-10 A**
- IR 1500 A @ 250 Vac

Agency information

- cURus, SEMKO, VDE, IMQ, CCC, CSA, BSI, MITI/JET, RoHS compliant, CE
- Agency information not applicable to all ratings, see data sheet for details.

Features

- Fast-acting for maximum protection
- High break capacity for use in higher fault energy electronic circuitry
- Conforms to IEC standards

Typical applications

- Electronic circuits

Catalog no. (amps)*		
S501-50-R	S501-315-R	S501-2-R
S501-63-R	S501-400-R	S501-2.5-R
S501-80-R	S501-500-R	S501-3.15-R
S501-100-R	S501-630-R	S501-4-R
S501-125-R	S501-800-R	S501-5-R
S501-160-R	S501-1-R	S501-6.3-R
S501-200-R	S501-1.25-R	S501-8-R
S501-250-R	S501-1.6-R	S501-10-R

* GDA is not available with axial leads. To order axial leads, place "V" in the S501 catalog number. E.g., S501-V-125-R.

† When ordering GDA version, do not add "-R" suffix to catalog number, GDA is not available above 6.3 A.

S500 ferrule (GDB[†]) and S500-V
axial lead fast-acting, low breaking capacity 5x20 mm glass tube fuses



Ratings

- Volts
 - 250 Vac (or less)
 - 32 Vdc (self certified)
- Amps 32mA-10 A
- IR
 - 35 A (32mA-3.15 A)
 - 40 A (4 A)
 - 63 A (6.3 A)
 - 80 A (8 A)
 - 100 A (10 A)

Agency information

- cURus, SEMKO, VDE, BSI, IMQ, CCC, RoHS compliant, CE
- Agency information not applicable to all ratings; see data sheet for details.

Features

- Fast-acting for maximum protection, conforms to IEC 60127-2 (160mA-10 A)

Typical applications

- Electronic circuits

Catalog no. (amps)*		
S500-32-R	S500-250-R	S500-2-R
S500-40-R	S500-315-R	S500-2.5-R
S500-50-R	S500-400-R	S500-3.15-R
S500-63-R	S500-500-R	S500-4-R
S500-80-R	S500-630-R	S500-5-R
S500-100-R	S500-800-R	S500-6.3-R
S500-125-R	S500-1-R	S500-8-R
S500-160-R	S500-1.25-R	S500-10-R
S500-200-R	S500-1.6-R	

* GDB is not available with axial leads. To order axial leads, place "V" in the S500 catalog number. E.g., S500-V-32-R.

† When ordering GDB versions, do not add "-R" suffix to catalog number.

S506 ferrule (GDC[†]) and S506-V
axial lead time-delay low breaking capacity 5x20 mm glass tube fuses



Ratings

- Volts
 - 250 Vac (or less)
 - 32 Vdc (self certified)
- Amps 32mA-15 A**
- IR 35 A @ 250 Vac

Agency information

- UR, CSA, cURus, SEMKO, VDE, BSI, IMQ, VDE, PSE/JET, CCC, RoHS compliant
- Agency information not applicable to all ratings; see data sheet for details.

Features

- Time-delay for inductive circuits
- Conforms to IEC standards

Typical applications

- Electronic circuits

Catalog no. (amps)*		
S506-32-R	S506-315-R	S506-3.15-R
S506-40-R	S506-400-R	S506-4-R
S506-50-R	S506-500-R	S506-5-R
S506-63-R	S506-630-R	S506-6.3-R
S506-80-R	S506-800-R	S506-8-R
S506-100-R	S506-1-R	S506-10-R
S506-125-R	S506-1.25-R	S506-12.5-R
S506-160-R	S506-1.6-R	S506-15-R
S506-200-R	S506-2-R	
S506-250-R	S506-2.5-R	

* GDC is not available with axial leads. To order axial leads, place "V" in the S506 catalog number. E.g., S506-V-15-R.

† When ordering GDC version, do not add "-R" suffix to catalog number., GDC fuses are not available above 6.3 A.

Small dimension (electronic) fuses

5 x 20 mm — N. American Standards

GMA ferrule and GMA-V axial lead fast-acting 5x20 mm glass tube fuses



Ratings

- Volts
 - 250 Vac (63mA-3 A)
 - 125 Vac (3.15-15 A)
 - 32 Vdc (self certified)
- Amps 63mA-15 A
- IR
 - 35 A (63mA-1 A @ 250 Vac, p.f. = 0.7-0.8)
 - 10 kA (63mA-6 A @ 125 Vac, p.f. = 0.7-0.8)
 - 100 A (1.25-2.5 A @ 250 Vac, p.f. = 0.7-0.8)
 - 200 A (7-8 A @ 125 Vac, p.f. = 1.0)
 - 150 A (10-15 A @ 125 Vac, p.f. = 1.0)

Agency information

- UL Listed, Std. 248-14 Guide JDYX, File E19180 up to 6 A, UL Recognized, Guide JDYX2, File E19180, 7-15 A, CSA Certified, Class 1422-01, File 53787 up to 6 A, PSE Approval 1-15 A, RoHS compliant, CE

Features

- Fast-acting for maximum protection

Typical applications

- Electronic circuits

Catalog no. (amps)*		
GMA-63-R	GMA-800-R	GMA-4-R
GMA-100-R	GMA-1-R	GMA-5-R
GMA-125-R	GMA-1.25-R	GMA-6-R
GMA-200-R	GMA-1.5-R	GMA-7-R
GMA-250-R	GMA-1.6-R	GMA-8-R
GMA-300-R	GMA-2-R	GMA-10-R
GMA-500-R	GMA-2.5-R	GMA-15-R
GMA-600-R	GMA-3.15-R	

* To order axial leads, place "V" in catalog number. E.g., GMA-V-8-R.

GMC ferrule and GMC-V axial lead medium time-delay 5x20 mm glass tube fuses



Ratings

- Volts
 - 250 Vac (63mA-3.15 A)
 - 125 Vac (3.5-10 A)
 - 32 Vdc (self certified)
- Amps 63mA-10 A
- IR
 - 35 A (63mA-1 A @ 250 Vac, p.f. = 0.7-0.8)
 - 10 kA (63mA-6 A @ 125 Vac, p.f. = 0.7-0.8)
 - 100 A (1.25-3.15 A @ 250 Vac, p.f. = 0.7-0.8)
 - 200 A (6.3-10 A @ 125 Vac, p.f. = 1.0)

Agency information

- UL Listed, Std. 248-14, Guide JDYX, File E19180 up to 6.3 A, UL Recognized, Guide JDYX2, File E19180 7-10 A, CSA Certified, Class 1422-01, File 53787 up to 6.3 A, MITI Approval, 1-10 A, KC, RoHS compliant, CE
- KC not applicable to all ratings; see data sheet for details

Features

- Conforms to UL standards

Typical applications

- Electronic circuits

Catalog no. (amps)*		
GMC-63-R	GMC-500-R	GMC-2.5-R
GMC-80-R	GMC-600-R	GMC-3.15-R
GMC-100-R	GMC-630-R	GMC-3.5-R
GMC-125-R	GMC-750-R	GMC-4-R
GMC-150-R	GMC-800-R	GMC-5-R
GMC-200-R	GMC-1-R	GMC-6-R
GMC-250-R	GMC-1.25-R	GMC-6.3-R
GMC-300-R	GMC-1.5-R	GMC-7-R
GMC-315-R	GMC-1.6-R	GMC-8-R
GMC-400-R	GMC-2-R	GMC-10-R

* To order axial leads, place "V" in catalog number. E.g., GMC-V-5-R.

GMD ferrule and GMD-V axial leads time-delay 5x20 mm glass tube fuses



Ratings

- Volts
 - 250 Vac
 - 32 Vdc (self certified)
- Amps 125mA-4 A
- IR
 - 10 kA (125mA-3 A @ 125 Vac, p.f. = 0.7-0.8)
 - 10 kA (4 A @ 125 Vac, p.f. = 1.0)
 - 35 A (125mA-1 A @ 250 Vac, p.f. = 0.7-0.8)
 - 100 A (1.2-3. A @ 250 Vac, p.f. = 0.7-0.8)
 - 200 A (4 A @ 250 Vac, p.f. = 1.0)

Agency information

- UL Listed Guide JDYX, File E19180, UL Recognized Card (4 A), Guide JDYX2, File E19180, 4 A, CSA Certified, Class 1422-01, File 53787, PSE/JET, File 1641-31003-1001, RoHS complaint, CE
- Agency information not applicable to all ratings; see data sheet for details

Features

- Time-delay for inductive circuits
- Conforms to UL standards

Typical applications

- Electronic circuits

Catalog no. (amps)*		
GMD-125-R	GMD-500-R	GMD-1.5-R
GMD-150-R	GMD-600-R	GMD-1.6-R
GMD-200-R	GMD-630-R	GMD-2-R
GMD-250-R	GMD-750-R	GMD-2.5-R
GMD-300-R	GMD-800-R	GMD-3-R
GMD-315-R	GMD-1-R	GMD-4-R
GMD-375-R	GMD-1.2-R	
GMD-400-R	GMD-1.25-R	

* To order axial leads, place "V" in catalog number. E.g., GMD-V-2.5-R.

Small dimension (electronic) fuses

1/4" x 1-1/4" fast-acting fuses

AGC ferrule and AGC-V axial lead fast-acting 1/4" x 1-1/4" glass tube fuses



Ratings

- Volts
 - 250 Vac (1/20-10 A)
 - 32 Vac (12-40 A)
 - 32 Vdc (self certified)
- Amps 1/20-40 A
- IR
 - 35 A (1/20-1 A @ 250 Vac)
 - 100 A (11/4-3 A @ 250 Vac)
 - 200 A (4-10 A @ 250 Vac)
 - 10 kA (1/20-10 A @ 125 Vac)
 - 1000 A (12-40 A @ 32 Vac)

Agency information

- UL Listed, Guide JDYX, File E19180, up to 10 A, UL Recognized, Guide JDYX2, File E19180, 12-30 A, CSA Certified, Class 1422-01, CSA Component Acceptance Card, Class No. 1422-30, RoHS compliant, CE

Features

- Original electronic glass tube fuse
- Fast-acting for maximum protection
- Wide amp/volt ratings allow versatility of protecting electronic circuits

Typical applications

- Electronic circuits

Catalog no. (amps)*		
AGC-1/20-R	AGC-1-1/4-R	AGC-8-R
AGC-1/10-R	AGC-1-1/2-R	AGC-9-R
AGC-1/8-R	AGC-2-R	AGC-10-R
AGC-3/16-R	AGC-2-1/4-R	AGC-12-R
AGC-2/10-R	AGC-2-1/2-R	AGC-14-R
AGC-1/4-R	AGC-3-R	AGC-15-R
AGC-3/10-R	AGC-4-R	AGC-20-R
AGC-3/8-R	AGC-5-R	AGC-25-R
AGC-1/2-R	AGC-6-R	AGC-30-R
AGC-3/4-R	AGC-7-R	AGC-35-R
AGC-1-R	AGC-7-1/2-R	AGC-40-R

* To order axial leads, place "V" in catalog number. E.g., AGC-V-1/10-R.

ABC ferrule and ABC-V axial leads fast-acting 1/4" x 1-1/4" ceramic tube fuse



Ratings

- Volts
 - 250 Vac/125 Vdc (1/4-15 A, 20-30 A)*
 - 250 Vac (18 A)
 - 32 Vdc (self certified)
- Amps 1/4-30 A
- IR**
 - 35 A (1/4-1 A @ 250 Vac)
 - 100 A (11/2-3 A @ 250 Vac)
 - 200 A (4-10 A @ 250 Vac)
 - 750 A (12-15 A @ 250 Vac)
 - 400 A (18-20 A @ 250 Vac)
 - 10 kA (1/4-15 A @ 125 Vac)
 - 1 kA (18-30 A @ 125 Vac)
 - 10 kA (1/4-15, 20 A @ 125 Vdc)
 - 400 A (25-30 A @ 125 Vdc)
 - 200 A (25-30 A @ 250 Vac)

* CSA approvals for 25 A and 30 A are at 125 Vac – IR 1000 A and Vdc – IR 400 A (IR 1 kA at 75 Vdc)

** Interrupting ratings measured at 70% – 80% power factor on AC. The interrupting ratings for 18 A and 20 A were measured at 85%-95% power factor on AC. The interrupting ratings for 25 A and 30 A were measured at 89% power factor on AC.

Agency information

- UL Listed, Std. 248-14, Guide JDYX File E19180 up to 15 A; UL Recognized, Guide JDYX2, File E19180, 18-30 A; CSA Certified, Class 1422-01 and 1422-30, File 53787, RoHS compliant, CE

Features

- Ceramic body allows for higher amp/volt rating combinations

Typical applications

- Electronic circuits

Catalog no. (amps)		
ABC-1/4-R	ABC-3-R	ABC-15-R
ABC-1/2-R	ABC-4-R	ABC-18-R
ABC-3/4-R	ABC-5-R	ABC-20-R
ABC-1-R	ABC-6-R	ABC-25-R
ABC-1-1/2-R	ABC-7-R	ABC-12-R
ABC-2-R	ABC-8-R	ABC-30-R
ABC-2-1/2-R	ABC-10-R	

* To order axial leads, place "V" in catalog number. E.g., ABC-V-7-R.

GBB ferrule and GBB-V axial lead very-fast-acting 1/4" x 1-1/4" ceramic tube fuses



Ratings

- Volts 250 Vac/125 Vdc
- Amps 1-30 A
- IR
 - 200 A @ 250 Vac
 - 200 A (20-30 A @ 125 Vac/dc)
 - 10 kA (1-15 A @ 125 Vac/dc)

Agency information

- UL Recognized, Std. 248-14, Guide JFHR2, File E56412, CSA Component Acceptance Class 1422-30, File 53787, RoHS compliant, CE

Features

- Very fast-acting performance allows protection of highly sensitive electronic circuitry

Typical applications

- Electronic circuits

Catalog no. (amps)*		
GBB-1-R	GBB-6-R	GBB-15-R
GBB-1-1/4-R	GBB-7-R	GBB-20-R
GBB-2-R	GBB-8-R	GBB-25-R
GBB-3-R	GBB-9-R	GBB-30-R
GBB-4-R	GBB-10-R	
GBB-5-R	GBB-12-R	

* To order axial leads, place "V" in catalog number. E.g., GBB-V-10-R.

Small dimension (electronic) fuses

1/4" x 1-1/4" Time-Delay Fuses

MDL ferrule and MDL-V axial lead time-delay 1/4" x 1-1/4" glass tube fuses



Ratings

- Volts
 - 250 Vac (1/16-8 A)
 - 32 Vac (9-30 A)
 - 32 Vdc (self certified)
- Amps 1/16-30 A
- IR*
 - 35 A (1/16-1 A @ 250 Vac)
 - 100 A (1/4-3 A @ 250 Vac)
 - 200 A (4-8 A @ 250 Vac)
 - 10000 A (1/16-8 A @ 125 Vac)
 - 1000 A (9-30 A @ 32 Vac)

* Interrupting ratings were measured at 70% – 80% power factor on AC, and at a time constant described in UL 198L.

Agency information

- UL Listed, Guide JDYX, File E19180 up to 8 A; CSA Certified Class 1422-01 up to 8 A; UL Recognized, Guide JDYX2, File E19180, 9-30 A; CSA Component Acceptance, Class 1422-30, 9-30 A, RoHS compliant, CE

Features

- Time-delay allows close sizing on inductive circuits

Typical applications

- Electronic circuits

Catalog no. (amps)*		
MDL-1/16-R	MDL-1-R	MDL-6-R
MDL-1/10-R	MDL-1-1/4-R	MDL-7-R
MDL-1/8-R	MDL-1-1/2-R	MDL-8-R
MDL-3/16-R	MDL-2-R	MDL-9-R
MDL-2/10-R	MDL-2-1/4-R	MDL-10-R
MDL-1/4-R	MDL-2-1/2-R	MDL-12-R
MDL-3/10-R	MDL-3-R	MDL-15-R
MDL-3/8-R	MDL-3-2/10-R	MDL-20-R
MDL-1/2-R	MDL-4-R	MDL-25**
MDL-3/4-R	MDL-5-R	MDL-30**

* To order axial leads, place "V" in catalog number. E.g., MDL-V-3-R.

**RoHS compliant construction not available.

MDA ferrule and MDA-V axial lead time-delay 1/4" x 1-1/4" ceramic tube fuses



Ratings

- Volts
 - 250 Vac (or less)
 - 125 Vdc (20-30 A)
 - 32 Vdc (self certified)
- Amps 1/4-30 A
- IR**
 - 35 A (1/4 to 1 A @ 250 Vac)
 - 100 A (1-1/2 to 2 A @ 250 Vac)
 - 200 A (2-1/2 to 10 A @ 250 Vac)
 - 750 A (12-15 A @ 250 Vac)
 - 1500 A (20-30 A @ 250 Vac)
 - 10 kA (1/4-30 A @ 125 Vac)
 - 10 kA (20-30 A @ 125 Vdc)

**Interrupting ratings were measured at 70% – 80% power factor on AC, and at a time constant described in UL 248.

Agency information

- UL Listed, Std. 248-14, Guide JDYX, File E19180 up to 20 A, CSA Certified, Class 1422-01, File 53787 up to 20 A. UL Recognized, Guide JDYX2, File E19180, 25-30 A, CSA Component Acceptance, Class 1422-30, 25-30 A, RoHS compliant, CE

Features

- Ceramic body for higher amp/volt ratings
- Inventory consolidation by replacing MDL fuses allows for reduced SKU investment and minimizing potential for misapplying fuse

Typical applications

- Electronic circuits

Catalog no. (amps)*		
MDA-1/4-R	MDA-3-R	MDA-12-R
MDA-1/2-R	MDA-4-R	MDA-15-R
MDA-3/4-R	MDA-5-R	MDA-20-R
MDA-1-R	MDA-6-R	MDA-25 A-R
MDA-1-1/2-R	MDA-7-R	MDA-30 A-R
MDA-2-R	MDA-8-R	
MDA-2-1/2-R	MDA-10-R	

* To order axial leads, place "V" in catalog number. E.g., MDA-V-1-1/2-R.

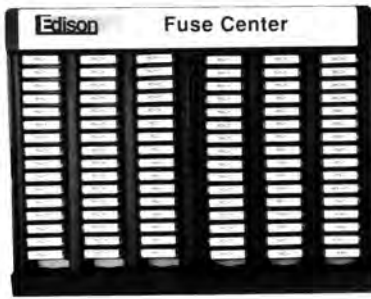

480 fuse ERFL counter display



200 fuse ERFS counter display

Catalog symbols

ERFL display (480 fuses)

ERFS display (200 fuses)

Features

- Edison display and fuse assortments are compact. They don't waste space with minimal display and storage area.
- Each display rack slot is labeled for easy inventory and reorder status.
- Solidly constructed display racks are durable.
- Each assortment has the right fuse mix per actual usage. No dead inventory.
- Fuse assortment consists of these "5-in tins" fuse packs and no-cost display stand.

ERFL (large assortment)			
(2) AGC-1	(2) AGX-20	(1) MDL-35	(1) GMA-3A
(2) AGC-2	(1) AGX-30	(1) ABC-1	(1) GMA-5A
(2) AGC-3	(2) MDL-1	(1) ABC-2	(1) GDC-1A
(1) AGC-4	(2) MDL-2	(2) ABC-3	(1) GDC-2A
(2) AGC-5	(2) MDL-3	(2) ABC-5	(1) GDC-3.15 A
(1) AGC-7	(1) MDL-4	(1) ABC-7	(1) GDC-5A
(4) AGC-10	(2) MDL-5	(2) ABC-10	(1) GDB-1A
(2) AGC-15	(1) MDL-7	(2) ABC-15	(1) GDB-2A
(6) AGC-20	(2) MDL-10	(2) ABC-20	(1) GDB-3.15 A
(2) AGC-25	(2) MDL-15	(2) ABC-25	(1) GDB-5A
(7) AGC-30	(6) MDL-20	(2) ABC-30	—
(1) AGC-35	(2) MDL-25	(1) GMA-1A	—
(2) AGX-15	(7) MDL-30	(1) GMA-2A	—
ERFS (small assortment)			
(2) AGC-1	(1) AGC-30	(1) MDL-25	(1) ABC-25
(1) AGC-2	(2) MDL-1	(1) MDL-30	(1) ABC-30
(1) AGC-3	(1) MDL-2	(1) ABC-1	(1) GMA-1A
(2) AGC-5	(1) MDL-3	(2) ABC-2	(1) GMA-2A
(1) AGC-7	(2) MDL-5	(2) ABC-3	(1) GMA-3A
(3) AGC-10	(1) MDL-7	(1) ABC-5	(1) GMA-5A
(1) AGC-15	(2) MDL-10	(2) ABC-10	—
(1) AGC-20	(1) MDL-15	(2) ABC-15	—
(1) AGC-25	(1) MDL-20	(2) ABC-20	—



CCFSK-45 Class CC fuse service kit



MFSK-45 UL supplemental (midget) fuse kit



RK5FSK-39 Class RK5 fuse service kit



MKE-C display rack, empty rack also available

MKE display racks and merchandising kits

Purchase the MKE unit as an empty display.

Features

- Shelves adjust to handle just about any product.
- Heavy-duty casters.
- Product part number bin labels available online.
- A fuse cross-reference guide.
- Flexible header card.

Dimensions

- 24" wide x 65" tall x 21-1/2" deep.

Weight

- 48 lbs. when empty.

Class CC and UL supplemental (midget/10x38) fuse holders

Fuse type	Catalog no.		Volts/amps	Agency information	Poles	Terminal ratings	SCCR Rating	Edison fuses
	W/ indicator	W/o indicator						
UL supplemental (midget/10x38)	EHM1DIU	EHM1DU	UL 600 V/30 A; IEC 690 V/32 A	UR, IEC 60269-2, CSA	1	Solid, stranded, fine stranded, fork lug, comb busbar, single and dual wire; 75°C and 90°C Cu	Up to 200, kA RMS Sym. — dependent on fuse IR	MCL, MOL, MEQ, MEN
	EHM2DIU	EHM2DU			2			
	EHM3DIU	EHM3DU			3			
Class CC	EHCC1DIU	EHCC1DU	UL 600 V/30 A	UL, CSA	1	200 kA RMS Sym.	EDCC, HCLR, HCTR	
	EHCC2DIU	EHCC2DU			2			
	EHCC3DIU	EHCC3DU			3			

Class CC and UL supplemental (midget/10x38) modular fuse blocks

Catalog no. /terminal type						
10-32 Phil-slot screw	Screw with quick-connect*	Pressure plate	Pressure plate with quick-connect*	Box lug	Poles	Fuse class/type
BCM603-1S	BCM603-1SQ	BCM603-1P	BCM603-1PQ	BCM603-1C	1	CC
BCM603-2S	BCM603-2SQ	BCM603-2P	BCM603-2PQ	BCM603-2C	2	
BCM603-3S	BCM603-3SQ	BCM603-3P	BCM603-3PQ	BCM603-3C	3	
—	BMM603-1SQ	—	BMM603-1PQ	BMM603-1C	1	UL supplemental (midget/10x38)
—	BMM603-2SQ	—	BMM603-2PQ	BMM603-2C	2	
—	BMM603-3SQ	—	BMM603-3PQ	BMM603-3C	3	
—	BCCMM603-3SQ	—	BCCMM603-3PQ	—	3	3-Pole control circuit transformer block 2-pole CC with 1-pole 10x38mm (13/32" x 1-1/2")

* 1/4" quick-connect terminal maximum amps dependent on female spade connector and wire ratings.

Class G fuse blocks for SEC fuses

Amp range	Poles	Catalog no. terminal type			
		Screw with quick-connect	Pressure plate with quick connect	Box lug	Box Lug w/ clip
Up to 15	1	BG3011SQ	BG3011PQ	BG3011B	—
	2	BG3012SQ	BG3012PQ	BG3012B	—
	3	BG3013SQ	BG3013PQ	BG3013B	—
20	1	BG3021SQ	BG3021PQ	BG3021B	—
	2	BG3022SQ	BG3022PQ	BG3022B	—
	3	BG3023SQ	BG3023PQ	BG3023B	—
25 to 30	1	BG3031S	BG3031P	BG3031B	—
	2	BG3032S	BG3032P	BG3032B	—
	3	BG3033S	BG3033P	BG3033B	—
35 to 60	1	—	—	—	G30060-1CR
	2	—	—	—	G30060-2CR
	3	—	—	—	G30060-3CR

Class K 30 and 60 amp blocks and covers

Fuse amp range	Poles	Catalog no./terminal type					Optional covers*	
		Box lug/slot screw	Box lug/hex screw	10-32 Phil-slot screw	Screw with quick-connect	Pressure plate	Indicating**	Non-indicating
250 volt blocks								
Up to 30	1	HM25030-1CR	HM25030-1CHR	HM25030-1SR	HM25030-1QR	HM25030-1PR	CVRI-RH-25030	CVR-RH-25030
	2	HM25030-2CR	HM25030-2CHR	HM25030-2SR	HM25030-2QR	HM25030-2PR		
	3	HM25030-3CR	HM25030-3CHR	HM25030-3SR	HM25030-3QR	HM25030-3PR		
35 to 60	1	HM25060-1CR	HM25060-1CHR				CVRI-RH-25060	CVR-RH-25060
	2	HM25060-2CR	HM25060-2CHR	—	—	—		
	3	HM25060-3CR	HM25060-3CHR					
600 volt blocks								
Up to 30	1	HM60030-1CR	HM60030-1CHR	HM60030-1SR		HM60030-1PR	CVRI-RH-60030	CVR-RH-60030
	2	HM60030-2CR	HM60030-2CHR	HM60030-2SR		HM60030-2PR		
	3	HM60030-3CR	HM60030-3CHR	HM60030-3SR		HM60030-3PR		
35 to 60	1	HM60060-1CR	HM60060-1CHR				CVRI-RH-60060	CVR-RH-60060
	2	HM60060-2CR	HM60060-2CHR	—		—		
	3	HM60060-3CR	HM60060-3CHR					

* Covers sold separately, one cover per pole.
 ** Open fuse indication requires 90 volts minimum and closed circuit to operate.

Class H 100 to 600 amp blocks and covers

Amp range	Poles	Catalog no.	Optional covers*		Conductors***		
			W/o indication	W/ indication**	Solid and stranded	Fine stranded	
250 volt blocks							
70-100	1	HM25100-1CR			—	Cu 1-3 AWG	
	2	HM25100-2CR	CVR-RH-25100	CVRI-RH-25100	1/0-3 AWG; (2) Cu 4-6 AWG 2 4-6 AWG; (2) Cu 8 AWG	Cu 4-6 AWG	
	3	HM25100-3CR			8 AWG; (2) Cu 10-14 AWG Cu 10-14 AWG; Al 10-12 AWG	Cu 8 AWG	
110-200	1	HM25200-1CR				—	
	2	HM25200-2CR	CVR-RH-25200	CVRI-RH-25200	250 kcmil-1 AWG 2-6 AWG; (2) Cu 2-6 AWG	Cu 3/0-1 AWG	
	3	HM25200-3CR				Cu 2-6 AWG	
225-400	1	HM25400-1CR				—	
	2	HM25400-2CR	CVR-RH-25400	CVRI-RH-25400	600 kcmil 500 kcmil-4 AWG	N/A	
	3	HM25400-3CR			(2) Cu 3/0 - 4 AWG (2) Al 3/0 - 4 AWG		
450-600	1	HM25600-1CR				—	
	2	HM25600-2CR	CVR-RH-25600	CVRI-RH-25600	2 (2) 500 kcmil-4 AWG	N/A	
	3	HM25600-3CR					
600 volt blocks							
70-100	1	HM60100-1CR			—	Cu 1-3 AWG	
	2	HM60100-2CR	CVR-RH-60100	CVRI-RH-60100	1/0-3 AWG; (2) Cu 4-6 AWG 2 4-6 AWG; (2) Cu 8 AWG	Cu 4-6 AWG	
	3	HM60100-3CR			8 AWG; (2) Cu 10-14 AWG Cu 10-14 AWG; Al 10-12 AWG	Cu 8 AWG	
110-200	1	HM60200-1CR				—	
	2	HM60200-2CR	CVR-RH-60200	CVRI-RH-60200	250 kcmil-1 AWG 2-6 AWG; (2) Cu 2-6 AWG	Cu 3/0-1 AWG	
	3	HM60200-3CR				Cu 2-6 AWG	
225-400	1	HM60400-1CR				—	
	2	HM60400-2CR	CVR-RH-60400	CVRI-RH-60400	600 kcmil 500 kcmil-4 AWG	N/A	
	3	HM60400-3CR			(2) Cu 3/0 - 4 AWG (2) Al 3/0 - 4 AWG		
450-600	1	HM60600-1CR				—	
	2	HM60600-2CR	CVR-RH-60600	CVRI-RH-60600	2 (2) 500 kcmil-4 AWG	N/A	
	3	HM60600-3CR					

* Covers sold separately.
 ** Open fuse indication requires 90 volts minimum and closed circuit to operate.
 *** Ratings for copper and aluminum conductors except where otherwise noted.

Class J 30 and 60 amp and covers for JDL and JDF fuses

Amp range	Poles	Catalog no./terminal type				Optional covers*	
		Box lug/slot screw	Box lug/hex screw	10-32 Phil-slot screw	Pressure plate	Indicating**	Non-indicating
Up to 30	1	JM60030-1CR	JM60030-1CHR	JM60030-1SR	JM60030-1PR	CVRI-J-60030	CVR-J-60030
	2	JM60030-2CR	JM60030-2CHR	JM60030-2SR	JM60030-2PR		
	3	JM60030-3CR	JM60030-3CHR	JM60030-3SR	JM60030-3PR		
35 to 60	1	JM60060-1CR	JM60060-1CHR	—	—	CVRI-J-60060	CVR-J-60060
	2	JM60060-2CR	JM60060-2CHR				
	3	JM60060-3CR	JM60060-3CHR				

* Covers sold separately, one cover per pole.
 ** Open fuse indication requires 90 volts minimum and closed circuit to operate.

Class J 100 to 600 amp blocks and covers for JDL and JDF fuses

Catalog no.	Optional covers*		Amp range	Poles	Wire range	
	W/o indication	W/ indication			Solid and stranded**	Fine stranded
JM60100-1CR	CVR-J-60100-M	CVRI-J-60100-M	70-100	1	—	1-3 AWG
JM60100-2CR				2	1/0-3 AWG; (2) Cu 4-6 AWG 4-6 AWG; (2) Cu 8 AWG	4-6 AWG 8 AWG
JM60100-3CR				3	8 AWG; (2) Cu 10-14 AWG Cu 10-14 AWG; Al 10-12 AWG	— —
JM60200-1CR	CVR-J-60200-M	CVRI-J-60200-M	110-200	1	250 kcmil-1 AWG 2-6 AWG; (2) Cu 2-6 AWG	3/0-1 AWG 2-6 AWG
JM60200-2CR				2		
JM60200-3CR				3		
JM60400-1CR	CVR-J-60400-M	CVRI-J-60400-M	225-400	1	600 kcmil 500 kcmil-4 AWG (2) Cu 3/0 - 4 AWG (2) Al 3/0 - 4 AWG	N/A
JM60400-2CR				2		
JM60400-3CR				3		
JM60400-1MW22†	CVR-J-60600	CVRI-J-60600	450-600	1	(2) 350 kcmil-1 AWG (2) 2 AWG - 6 AWG	N/A
JM60400-2MW22†				2		
JM60400-3MW22†				3		
JM60600-1CR	CVR-J-60600	CVRI-J-60600	450-600	1	(2) 500 kcmil-4 AWG	N/A
JM60600-2CR				2		
JM60600-3CR				3		

* Covers sold separately. Blown fuse indication requires 90 volts minimum and closed circuit to operate.
 ** Ratings for copper and aluminum wire except where otherwise noted.
 † 400 A Class J double box lug rated for 75°C/90°C Cu/Al.

Class J power distribution fuse blocks and covers for JDL and JDF fuses

Catalog no.	Optional covers*	Amp range	Poles	Lineside (conductors per port)		Loadside (conductors per port)	
				Conductors	Ports/pole	Conductors	Ports/pole
JM60030-1MW14	N/A	Up to 30	1			Cu (1) 8-14	
JM60030-2MW14			2	Cu 2-14 Al 2-8	1	Cu (2) 12-14*** Al (1) 8 Str	4
JM60030-3MW14			3			Al (1) 10 Sol	
JM60060-1MW12†			1				
JM60060-2MW12†			2	Cu 2-14 Al 2-8	2	Cu 2-14 Al 2-8	1
JM60060-3MW12†			3				
JM60060-1MW14†	CVR-J-60060 CVRI-J-60060**	35 - 60	1			Cu (1) 8-14	
JM60060-2MW14†			2	Cu 2-14 Al 2-8	1	Cu (2) 12-14*** Al (1) 8 Str	4
JM60060-3MW14†			3			Al (1) 10 Sol	
JM60060-1MW24			1			Cu (1) 8-14	
JM60060-2MW24			2	Cu 2-14 Al 2-8	2	Cu (2) 12-14*** Al (1) 8 Str	4
JM60060-3MW24			3			Al (1) 10 Sol	
JM60100-1MW14	CVR-J-60100-M CVRI-J-60100-M**	70 - 100	1			Cu (1) 4-14	
JM60100-2MW14			2	Cu 1/0-14 Al 1/0-12	1	Al (1) 4-8 Cu (2) 10-14***	4
JM60100-3MW14			3				
JM60200-1MW16	CVR-J-60200-M CVRI-J-60200-M**	110-200	1			Cu (1) 4-14	
JM60200-2MW16			2	Cu/Al (1) 250 kcmil-6 Cu (2) 2-6	1	Al (1) 4-8 Cu (2) 10-14***	6
JM60200-3MW16			3				
JM60400-1MW16	CVR-J-60400-M CVRI-J-60400-M**	225-400	1			Cu (1) 2-14	
JM60400-2MW16			2	Cu/Al (1) 600 kcmil-4 Cu/Al (2) 3/0-4	1	Al (1) 2-8 Cu (2) 8-14***	6
JM60400-3MW16			3				
JM60400-1MW26			1			Cu (1) 2-14	
JM60400-2MW26			2	Cu/Al 350 kcmil-6	2	Al (1) 2-8 Cu (2) 8-14***	6
JM60400-3MW26			3				

* Order one cover per pole.
 ** With open fuse indication. 90 V minimum and closed circuit required for illumination.
 *** Dual wire rated lugs with same wire size and stranding.
 † Rated for 75°C Cu/Al conductors. Conductors with higher ratings may be used with appropriate derating.

Class R 30 and 60 amp blocks and covers for LENRK, LESRK, NCLR, SCLR, ECNR, ECSR fuses

Amp range	Poles	Catalog no./terminal type					Optional covers*	
		Box lug/ slot screw	Box lug/ hex screw	10-32 Phil-slot screw	Screw with quick-connect	Pressure plate	Indicating**	Non-indicating
250 volt blocks								
Up to 30	1	RM25030-1CR	RM25030-1CHR	RM25030-1SR	RM25030-1QR	RM25030-1PR	CVRI-RH-25030	CVR-RH-25030
	2	RM25030-2CR	RM25030-2CHR	RM25030-2SR	RM25030-2QR	RM25030-2PR		
	3	RM25030-3CR	RM25030-3CHR	RM25030-3SR	RM25030-3QR	RM25030-3PR		
35 to 60	1	RM25060-1CR	RM25060-1CHR				CVRI-RH-25060	CVR-RH-25060
	2	RM25060-2CR	RM25060-2CHR	—	—	—		
	3	RM25060-3CR	RM25060-3CHR					
600 volt blocks								
Up to 30	1	RM60030-1CR	RM60030-1CHR	RM60030-1SR		RM60030-1PR	CVRI-RH-60030	CVR-RH-60030
	2	RM60030-2CR	RM60030-2CHR	RM60030-2SR		RM60030-2PR		
	3	RM60030-3CR	RM60030-3CHR	RM60030-3SR		RM60030-3PR		
35 to 60	1	RM60060-1CR	RM60060-1CHR		—		CVRI-RH-60060	CVR-RH-60060
	2	RM60060-2CR	RM60060-2CHR	—		—		
	3	RM60060-3CR	RM60060-3CHR					

* Covers sold separately, order one cover per pole.

** Open fuse indication requires 90 volts minimum and closed circuit to operate.

Class R 100 to 600 amp blocks and covers for LENRK, LESRK, NCLR, SCLR, ECNR, ECSR fuses

Amp range	Poles	Catalog no.	Optional covers*		Wire range***	
			W/o indication	W/ indication**	Solid and stranded	Fine stranded
250 volt blocks						
70-100	1	RM25100-1CR	CVR-RH-25100	CVRI-RH-25100	1/0-3 AWG; (2) Cu 4-6 AWG 2 4-6 AWG; (2) Cu 8 AWG 8 AWG; (2) Cu 10-14 AWG Cu 10-14 AWG; Al 10-12 AWG	Cu 1-3 AWG Cu 4-6 AWG Cu 8 AWG — —
	2	RM25100-2CR				
	3	RM25100-3CR				
110-200	1	RM25200-1CR	CVR-RH-25200	CVRI-RH-25200	250 kcmil-1 AWG 2-6 AWG; (2) Cu 2-6 AWG	Cu 3/0-1 AWG Cu 2-6 AWG
	2	RM25200-2CR				
	3	RM25200-3CR				
225-400	1	RM25400-1CR	CVR-RH-25400	CVRI-RH-25400	600 kcmil 500 kcmil-4 AWG (2) Cu 3/0 - 4 AWG (2) Al 3/0 - 4 AWG	N/A
	2	RM25400-2CR				
	3	RM25400-3CR				
450-600	1	RM25600-1CR	CVR-RH-25600	CVRI-RH-25600	2 (2) 500 kcmil-4 AWG	N/A
	2	RM25600-2CR				
	3	RM25600-3CR				
600 volt blocks						
70-100	1	RM60100-1CR	CVR-RH-60100	CVRI-RH-60100	1/0-3 AWG; (2) Cu 4-6 AWG 2 4-6 AWG; (2) Cu 8 AWG 8 AWG; (2) Cu 10-14 AWG Cu 10-14 AWG; Al 10-12 AWG	Cu 1-3 AWG Cu 4-6 AWG Cu 8 AWG — —
	2	RM60100-2CR				
	3	RM60100-3CR				
110-200	1	RM60200-1CR	CVR-RH-60200	CVRI-RH-60200	250 kcmil-1 AWG 2-6 AWG; (2) Cu 2-6 AWG	Cu 3/0-1 AWG Cu 2-6 AWG
	2	RM60200-2CR				
	3	RM60200-3CR				
225-400	1	RM60400-1CR	CVR-RH-60400	CVRI-RH-60400	600 kcmil 500 kcmil-4 AWG (2) Cu 3/0 - 4 AWG (2) Al 3/0 - 4 AWG	N/A
	2	RM60400-2CR				
	3	RM60400-3CR				
450-600	1	RM60600-1CR	CVR-RH-60600	CVRI-RH-60600	2 (2) 500 kcmil-4 AWG	N/A
	2	RM60600-2CR				
	3	RM60600-3CR				

* Covers sold separately, order one cover per pole.

** Open fuse indication requires 90 volts minimum and closed circuit to operate.

*** Ratings for copper and aluminum conductors except where otherwise noted.

Class T 300 V and 600 V fuse blocks for TJN (300 V) and TJS (600 V) fuses

Amp range	Poles	Catalog no. / terminal		Max. wire size
		Screw	Box lug	
300 volt blocks				
Up to 30	2	T30030-2SR	T30030-2CR	SR #10 Cu
	3	T30030-3SR	T30030-3CR	CR #6 Cu-Al
31-60	2	T30060-2SR*	T30060-2CR	SR #10 Cu CR #2 Cu-Al
	3	T30060-3SR*	T30060-3CR	
61-100	4	T30060-4SR*	T30060-4CR	1/0 Cu-Al
	1	—	T30100-1C	
	2	—	T30100-2C	
101-200	3	—	T30100-3C	250 kcmil Cu-Al
	1	—	T30200-1C	
201-400	3	—	T30200-3C	600 kcmil Cu-Al
	1	—	T30400-1C	
401-600	1	—	T30600-1C	(2) 600 kcmil Cu-Al

Amp range	Poles	Catalog no. / terminal		Max. wire size
		Screw	Box lug	
600 volt blocks				
Up to 30	1	T60030-1SR	T60030-1CR	SR #10 Cu CR #2 Cu-Al
	2	T60030-2SR	T60030-2CR	
	3	T60030-3SR	T60030-3CR	
31-60	1	T60060-1SR*	T60060-1CR	CR#2 Cu Al SR #10 Cu
	2	T60060-2SR	T60060-2CR	
	3	T60060-3SR*	T60060-3CR	
61-100	1	—	T60100-1C	2/0 Cu-Al
	2	—	T60100-2C	
	3	—	T60100-3C	
101-200	1	—	T60200-1C	250 kcmil Cu-Al
201-400	1	—	T60400-1C	600 kcmil Cu-Al
401-600	1	—	T60600-1C	(2) 600 kcmil Cu-Al

* UL Recognized

In-line fuse holders

UL fuse class/type	Catalog symbol	Description	Volts/amps	SCCR	Edison fuse
Class G	HEC	Single-pole non-breakaway holders	480 V/25-30 A	200 kA	SEC
	HEG		600 V/up to 15 A		
	HEH		600 V/20 A		
	HEJ		480 V/35-60 A		
N/A	HEC-RW-RLB-R	Single-pole breakaway holder	480 V/25-30 A	10 kA	—
	HET	Single-pole with permanent neutral, breakaway and non-breakaway versions	600 V/up to 60 A		
UL supplemental (midget/10x38)	HEB	Single-pole breakaway and non-breakaway in-line holders	600 V/30 A	200 kA*	MCL, MOL, MEQ, MEN
	HEX	Dual-pole breakaway and non-breakaway in-line holders	600 V/30 A		
	HEY	Dual-pole breakaway and non-breakaway in-line holders	600 V/30 A		
Class CC	HEZ	Single-pole waterproof breakaway and non-breakaway holders	600 V/30 A	200 kA	EDCC, HCLR, HCTR

* SCCR limited to fuse interrupting rating.

Plug fuse box cover units for Edison base W, T, TL, TC and P fuses

Catalog no.	Box type	Fuse sockets	Switch control ¹	Pilot light ²	Max motor size (Hp)	Description	Agency information
SOU	2-1/4" Handy	1			3/4	Fuse receptacle only (no switch or outlet)	UL, CSA
SRU		1			1/2	Fused outlet	UL
SSU		1	X		1/2	Fused switch	UL, CSA
SOW	2-3/4" Switch	1			3/4	Fuse receptacle only (no switch or outlet)	UL, CSA
SRW		1			1/2	Fused outlet	UL
SSW		1	X		1/2	Fused switch	UL, CSA
SOX	4" Octagon	1			3/4	Fuse receptacle only (no switch or outlet)	UL, CSA
SRX		1			1/2	Fused outlet	UL
SOY		1			3/4	Fuse receptacle only (no switch or outlet)	UL, CSA
SRY	4" Square	1			1/2	Fused outlet	UL
SSY		1	X		1/2	Fused switch	UL, CSA
SSY-RL		1	X	X	1/2	Fused switch/outlet with pilot light	—
STY ³		2	X		1/2	Fused double pole switch, dual fuse receptacles	UL
SCY ⁴		2			1/2	Dual fused switches	UL
SOY-B		2			3/4	Dual fuse receptacles only (no switch or outlet)	UL
SSN	Single gang	1	X		1/2	Weatherproof fused switch	UL

1 Switch turns power to fused load OFF or ON.

2 Pilot light indicates power to load (dark when switch OFF or fuse open).

3 Double pole switch opens both sides of circuit.

4 Can be used for two separate motors with common switch or a single motor (3/4 Hp, 250 Vac max).

Fuse sizing for 600 V building electrical systems

General guidelines are given for selecting fuse amp ratings for most circuits. For specific applications warranting other fuse sizing, the load characteristics and appropriate NEC sections should be considered. The selections shown here are not, in all cases, the maximum or minimum amp ratings permitted by the NEC. Demand factors as permitted by the NEC are not included. Study the pertinent NEC sections noted by “()” and reference pertinent footnotes.

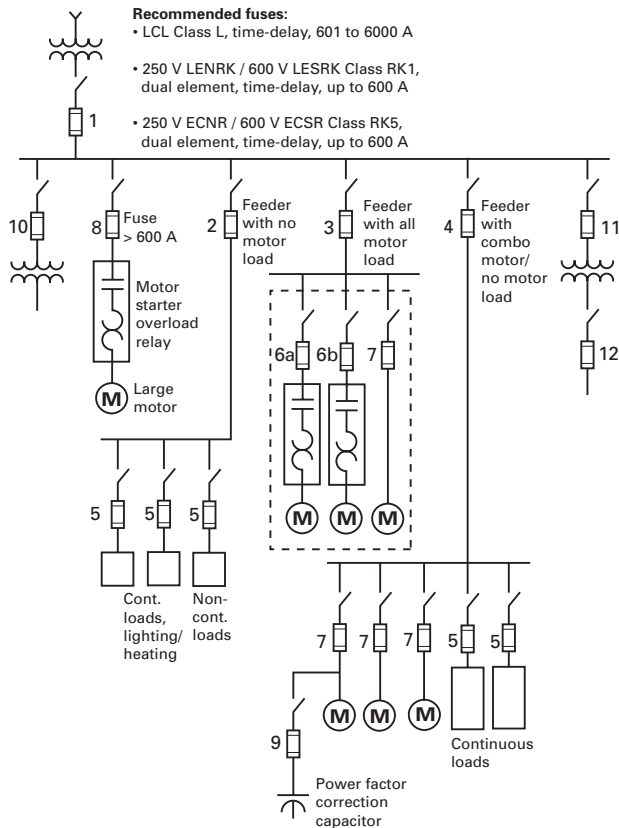

Dual-element, time-delay fuses

Class J, RK1 and RK5 (up to 600 A)

For fuses above 600 A, use Class L time-delay fuses with ratings from 601-6000 A. While these fuses are not dual-element construction, the Edison LCL is a time-delay fuse.

- 1. Main service.** Size fuse according to method in 4 below.
- 2. Feeder circuit with no motor loads.** (215.3) The fuse size must be at least 125% of the continuous load^T plus 100% of the non-continuous load. Do not size larger than the conductor's ampacity*.
- 3. Feeder circuit with all motor loads.** (430.62) Size the fuse at 150% to 175% of the largest motor's full load current** plus the full-load current** of all other motor'sΔ.
- 4. Feeder circuit with mixed loadsΔ.** (430.63) Size fuse at sum of:
 - 150% to 175%^{††} of the largest motor's full-load current**, plus
 - 100% of all other motors' full-load current**, plus
 - 125% of the continuous, non-motor load[†], plus
 - 100% of the non-continuous, non-motor load

- 5. Branch circuit with no motor load.** (210.20) The fuse size must be at least 125% of the continuous load^T plus 100% of the non-continuous load. Do not size larger than the conductor's ampacity*.
- 6. Motor branch circuit with overload relays.** Where overload relays are sized per 430.32 for motor running overload protection, there are various alternatives:
 - 6a. Motor branch circuit short-circuit and ground fault protection. (430.52) (most common).** Size the fuse between 150 to 175%^{††} of the full load current.** Provides branch circuit short-circuit and ground fault protection only.
 - 6b. Motor branch circuit short-circuit and ground fault protection (430.52) as well as backup overload protection.** Size ECNR and ECSR Class RK5 dual-element, time-delay fuses at 125% and LENRK and LESRK Class RK1 dual-element, time-delay fuses at 130% of motor full-load current or next higher size. This results in closer fuse sizing and provides some backup running overload protection. In addition, it provides motor branch circuit short-circuit and ground fault protection. Sizing in this manner may result in better motor protection if the overload relays are not properly sized or calibrated.
- 7. Motor branch circuit with only fuse protection.** Where the fuse is the only motor protection, the following ECNR and ECSR, Class RK5, fuses provide motor running overload protection (430.32) and short-circuit protection (430.52):
 - Motor 1.15 service factor or 40°C rise. Size the fuse at 110% to 125% of the motor full-load current on the name plate [430.6(a)(2)].
 - Motor less than 1.15 service factor or over 40°C rise. Size fuse at 100% to 115% of motor full-load current on the name plate [430.6(a)(2)].
- 8. Large motor branch circuit.** Fuse larger than 600 A. [436.52(c) and 430.52(c)(1) Exceptions 2(d)]. For large motors, size LCL time-delay fuse at 175% to 300% of the motor full-load current**, depending on the starting method; i.e., part-winding starting, reduced voltage starting, etc.
- 9. Power factor correction capacitors.** [460.8(b)]. Size dual-element fuses as low as practical, typically 150% to 175% of capacitor rated current.
- 10. Transformer primary fuse (without secondary fuse protection).** [450.3(b)] When transformer primary current is equal to or greater than 9 amps, the dual-element, time-delay fuse should be sized at 125% of transformer primary current or the next size larger if 125% does not correspond to a standard fuse size. Note: Secondary conductors must be protected from overcurrent damage per Article 240.
- 11. Transformer primary fuse (with secondary fuse protection).** [450.3(b)] May be sized at 250% of transformer primary current if the secondary is fused per 12 below.
- 12. The secondary fuse is sized at no more than 125% of secondary full-load current.** [450.3(b)] Note: Secondary conductors must be protected at their ampacities per Article 240.

Non-time delay and all Class CC fuses

(JFL, NCLR, SCLR, TJN, TJS, EDCC, HCLR and HCTR)

1. **Main service.** Size fuse according to method in 4.
2. **Feeder circuit with no motor loads.** (215.3) The fuse size must be at least 125% of the continuous load† plus 100% of the non-continuous load. Do not size larger than the conductor's ampacity.*
3. **Feeder circuit with all motor loads.** (430.62) Size the fuse at 300% of the largest motor's full-load current** plus the full-load current** of all other motors.
4. **Feeder circuit with mixed loads.** (430.62) Size fuse at sum of:
 - a. 300% of the full-load current** of the largest motor, plus
 - b. 100% of the full-load current** of all other motors, plus
 - c. 125% of the continuous, non-motor load†, plus
 - d. 100% of the non-continuous, non-motor load
5. **Branch circuit with no motor loads.** (210.20) The fuse size must be at least 125% of the continuous load† plus 100% of the non-continuous load. Do not size larger than the conductor's ampacity.*
- 6a. **Motor branch circuit with overload relays.** (430.52) Size the fuse at 300% of the full load current**. Provides branch circuit short-circuit and ground fault protection only. Other means must be utilized to provide motor overload protection (see 430.32). (If 300% is not a standard fuse amp rating, 430.52(C)(1) Exception 1 permits the next standard fuse amp rating. If the motor cannot start with this size fuse, 430.52(C)(1) Exception 2 permits increasing the fuse size up to 400% provided the fuse rating does not exceed 600 A.)
- 6b. **Motor branch circuit short-circuit and ground fault protection (430.52) as well as backup overload protection.** Not applicable for non-time-delay fuses; use ECNR and ECSR, Class RK5, dual-element time-delay fuses or LENRK and LESRK Class RK1, dual-element, time-delay fuses (see 6b under dual-element time-delay fuse selection). Non-time-delay fuses cannot be sized close enough to provide motor running backup overload protection. If sized for motor overload backup protection, non-time-delay fuses would open due to motor starting current.
7. **Motor branch circuit with only fuse protection.** Not applicable for non-time-delay fuses; use ECNR and ECSR, Class RK5, dual-element time-delay fuses (see 7 under dual-element time-delay fuse selection). Non-time-delay fuses cannot be sized close enough to provide motor running overload protection. If sized for motor overload protection, non-time-delay fuses would open due to motor starting current.
8. **Power factor correction capacitors.** [460.8(B)] Size non-time-delay fuses as low as practical, typically 250% to 300% of capacitor rated current.

Conductor ampacity selection

1. **Feeder circuit and main circuit with mixed loads.** (430.24) conductor ampacity at least sum of:
 - a. 100%†† of the full-load current** of the largest motor, plus
 - a. 100% of the full-load current** of all other motors, plus
 - c. 125% of the continuous, non-motor load†, plus
 - d. 100% of the non-continuous, non-motor load

2. **Feeder circuit with no motor load.** [215.2(a)(1)] Conductor ampacity at least 125% of the continuous load plus 100% of the non-continuous load.
3. **Feeder circuit with all motor loads.** (430.24) Conductor ampacity at least 125% of the largest motor full-load amps plus 100% of all other motors' full-load amps.
4. **Feeder circuit with mixed loads.** (430.24) Size according to method 1 above.
5. **Branch circuit with no motor load.** [210.19(a)(10)] Conductor ampacity at least 125% of the continuous load plus 100% of the non-continuous load.
- 6, 7 and 8. **Motor branch circuits.** (430.22) Conductor ampacity at least 125% of the motor full-load current.
9. **Capacitor connected to motor branch circuit.** (460.8) Conductor ampacity at least 135% of capacitor rated current, and at least 1/3 the motor circuit conductors' ampacity.
- 10, 11. **Conductor ampacity minimum 125% of transformer full-load current.**
12. **Conductor ampacity per 1 above.**

† 100% of the continuous load can be used rather than 125% when the switch and fuse are listed for 100% continuous operation as an assembly (e.g., 215.3 Exc 1). Some bolted pressure switches and high pressure contact switches 400 A to 6000 A with Class J and L fuses in specified assemblies are listed for 100% continuous operation.

* Where conductor ampacity does not correspond to a standard fuse amp rating, the next higher amp rating fuse is permitted when 800 A or less [(240.4(B)). Above 800 A the conductor ampacity must be equal or greater than the fuse amp rating [(240.4(C)). However, per 240.91(B), when above 800 A for supervised industrial installations, the conductor ampacity is permitted to be 95% of the fuse amp rating as long as the equipment is listed for that size conductor and the conductor is protected within its time vs. current limits [240.4 Informational Note].

Δ In many motor feeder applications dual-element fuses can be sized at ampacity of feeder conductors.

• Available short-circuit current and the clearing time of the overcurrent device must be considered so that the conductor's ICEA (P32.382) withstand rating is not exceeded.

** On general motor applications, motor full load amps for calculating conductor ampacity and for calculating fuse amp ratings for motor branch circuit short-circuit and ground fault protection (430.52) are selected from NEC Tables 430.247 through 430.250 per 430.6(A)(1). However, the motor nameplate current rating is used for sizing motor overload protection (430.32) per 430.6(A)(2).

†† 430.52(C)(1) allows a maximum of 175% for time-delay fuses, for all but wound rotor and DC motors. A range of 150% to 175% was used for these guidelines, even though 430.52(C)(1) allows a maximum of 175% for time-delay fuses as stated above. The reason for showing this range is to highlight the possibility for application selection. In some situations, there may be a difference in the switch amp rating or fuse block amp rating in selecting 150% versus 175%. Using 175% is permitted and is suggested for heavy starting current or longer starting time applications.

Further note: the NEC permits larger sizing via two exceptions. 430.52(C)(1) Exception 1 permits the next standard size if 175% does not correspond with a standard fuse amp rating. If the motor cannot start with this size fuse, 430.52(C)(1) Exception 2 permits increasing a time-delay fuse size up to 225%.

(Note that while a time-delay fuse may not exceed 225% when using Exception 2, using a time-delay fuse could exceed 225% when applying Exception 1. For example, assume a motor with a FLA of 1.0 amp. 430.52(C)(1) would allow a 1.75 amp fuse. Exception 1 would allow a 3 amp time-delay fuse per 240.6(A). Exception 2 limits the time-delay fuse to 2.25 amps as a maximum, but Exception 2 is not utilized or needed if Exception 1 is adequate.)

*** The conductor ampacity may have to be greater due to using adjustment or correction factors per 210.19(A)(1) and 215.2(A)(1).

Cross reference by manufacturer's catalog symbol

Fuse class/type	Description	Volts	Edison	See cat. page	Brush/Dorman	GEC/CEFCO	Mersen	Littelfuse	Fusetek	Siemens	Noram	Aeroflex
UL Class fuses (CSA Class)												
RK1 (HRCI-R)	Fast-acting	250	NCLR	24	NCLR	C-HG	A2KR, HNR	KLNR	RHN	—	—	HB
		600	SCLR		SCLR	C-HR	A6KR, HSR	KLSR	RHS	—	—	HA
	Time-delay	250	LENRK	19	LENRK	LON-RK	A2D-R	LLNRK	—	—	2R-D	—
		600	LESRK		LESRK	LOS-RK	A6D-R	LLSRK	—	—	6R-D	—
RK5 (HRCI-R)	Time-delay	250	ECNR	27	ECNR	CRNR	TRNR, TR	FLN-R	RDN	—	—	—
		600	ECSR		ECSR	NRSR	TRSR, TRS	FLS-R IDSR	RDS	—	—	—
	600	LCU	LCU		CL, CLU	A4BQ	—	LFA	—	—	6L-F	L8, L12
L (HRCI-L)	Fast-acting	600	LCU	15	LCL	CLL	A4BY, A4BT	KLPC, KLLU	—	—	6L-D	L16, L20
	Time-delay	600	LCL		LCL	CLL	A4BY, A4BT	KLPC, KLLU	—	—	6L-D	L16, L20
J (HRCI-J)	Fast-acting	600	JFL	9	JCL, CJ	C-J	A4J, CJ	JLS	JFC	3NW2-71-	6J-F	JA
	Time-delay	600	JDL	7	—	—	AJT	JTD	—	—	J-D	—
	High speed	600	JHL	11	—	—	—	LDFJ	—	—	—	—
T (HRCI-T)	Fast-acting	300	TJN	32	TJN	—	A3T	JLLN	—	—	—	—
		600	TJS		TJS	—	A6T	JLLS	—	—	—	—
G	Time-delay	480	SEC	5	—	—	AG5	SLC	—	—	—	—
	Time-delay	600	EDCC	1	—	—	ATDR	CCMR	—	—	6M-S	—
CC (HRCI-CC)	Time-delay	600	HCTR	3	—	—	ATQR	KLDR	—	—	6CC-S	—
	Time-delay	600	HCTR		—	—	ATQR	KLDR	—	—	6CC-S	—
	Fast-acting	600	HCLR		HCLR	CTK-R	ATMR	KLKR	FLKR	—	—	6CC-F
H and K5	Fast-acting	250	KON	13	KON	50KOTN	OTN	NLN	OFN	—	—	—
		600	KOS		KOS	50KOTS	OTS	NLS	OFS	—	—	—
UL 13/32" x 1-1/2" supplemental fuses												
Midget	Fast-acting	600	MCL	38	MCL	CTK	ATM	KLK	FLK	—	6M-S	—
		600	EBS*		EBS*	—	SBS*	BLS*	—	—	6N-F*	—
		250	MOL		MOL	—	OTM	BLF	FLF	—	—	—
Midget	Time-delay	500	MEQ	40	MEQ	—	ATQ	FLQ	—	—	—	—
		250	MEN		MEN	—	TRM	FLM	FRM	—	—	—
		125/250	MID		MID	—	GFN	FLA	—	—	—	—
Canadian fuses												
Code/standard 10 kA	One Time	250	KON/PONC	—	KON/PON	50KOTN	NRN OTN	NLN	OFN	—	—	—
		600	KOS	—	KOS	50KOTS	NRS OTS	NLS	OFS	—	—	—
	Time-delay	250	CDNC	—	CDN	—	CRN	FLN	ODN	—	—	—
TYPE K Class C	Offset	600	CIH07	—	CIH07	C-K	ESK	—	—	—	—	—
			CIK07	—	CIK07	C-K	ESK	—	—	—	—	—
	Blade	600	CIL14	—	CIL14	C-K	ESK	—	—	—	—	—
HRCI-CA	Fast-acting	600	CIF21	—	CIF21	C-N	MS	—	—	3NWOMFS2	6CA-F	—
HRCI-CB	Fast-acting	600	CIF06	—	CIF06/NK	CNS	GNS	—	NIC	3NWOMFS1	6CB-F	—
			EK	—	EK	CES	—	—	—	—	—	—
HRC-II Fuses												
HRC-II-C	Offset blade	600	H07C	—	H07C, AAO	CIA	FES, GIA	—	2CO	3NW2-11	6C-F	932
			K07C	—	K07C, BAO	CIS	FES, GIS	—	2CO	3NW2-12	6C-F	933
			L14C	—	L14C, CEO	CCP	FES, GCP	—	2CO	3NW2-13	6C-F	944
	Center blade		M09C	—	M09C, DD	CF	FESC, GF	—	2CC	3NW2-23	6C-F	965
			P11C	—	P11C, EF	CM	FESC, GM	—	2CC	3NW2-31	6C-F	976
HRC-II MISC	Offset center	R11C	—	R11C, FF	CLM	FESC, GLM	—	2CC	3NW2-34	6C-R	977	
		K07CR	—	K07CR, OSD	—	—	—	—	—	—	—	
		L09C	—	L09C, CD	CC	FESC, GC	—	2CM	3NW2-22	—	964	
		M14C	—	M14C, DEO	CFP	FES, GFP	—	2CM	3NW2-14	—	945	
		P09C	—	P09C, ED	CMF	FESF, GMF	—	2CM	3NW2-25	—	966	
Miniature blade	Offset	CIF21	—	F21, NITD	NIT	GIT	—	N2B	—	—	—	
		CIF06	—	F06, NSD, NSC	NS	NSG	—	N2C	—	—	—	
Small dimension fuses												
Size	Description	Edison		See cat. page	Brush	GEC/CEFCO	Mersen	Littelfuse	Fustek	Noram		
		New	Old									
5x20 mm	Time-delay, gls.	S506	GDC	43	BDC	CMB	GDG	218	SD6	SE-S		
	Fast-acting, gls.	GMA	BMA	44	BMA	CMA	GGM	235	MQ4	SE-F		
	Fast-acting, gls.	S500	GDB	43	BDB	—	GSB	217	—	—		
	Fast-acting, gls.	S501	GDA		—	—	—	216	—	—		
	Time-delay, gls.	GMC	—	44	—	—	GSC	—	—	—		
	Time-delay, gls.	GMD	—		—	—	GSC	239	—	—		
1/4 x 1-1/4"	Fast-acting, gls.	AGC	BGC	45	BGC	3AG	GGC	312	SS2/SS6	SU-F		
	Fast-acting, cer.	ABC	BBC		BBC	3AB	GAB	314	CES14	—		
	V fast-acting, cer.	GBB	—	46	—	—	—	322	—	—		
	Time-delay, gls.	MDL	BDL		BDL	3AG-SB	GDL	313	SD4	SU-S		
	Time-delay, cer.	MDA	BDA		—	—	GSA	326	—	—		

* 13/32" x 1-3/8"

Index

Catalog symbol . . Page

ABC / ABC-V45
AGC / AGC-V45
ATC42
ATM42
BCM_48
BG30_48
CCFSK-4547
EBS38
ECNR27
ECSR27
EDCC	1
EMH_48
ERFL / ERFS47
G30060_48
GBB / GBB-V45
GMA / GMA-V44
GMC / GMC-V44
GMD / GMD-V44
HCLR	3
HCTR	3
HEB_53
HEC_53
HEG_53
HEH_53
HEJ_53
HET_53
HEX_53
HEY_53
HEZ_53
HM250_49
HM600_49
J_35
JDL	7
JFL	9
JHL13
JM600_50, 51
KON13
KOS13
LCL15
LCU15
LENRK19
LESRK19
MAX42
MCL38
MDA / MDA-V46

Catalog symbol . . Page

MDL / MDL-V46
MEN40
MEQ40
MFSK-4547
MID40
MKE47
MOL38
NCLR24
NO_37
P37
RK5FSK-3947
RM250_52
RM600_52
S35
S500 / S500-V43
S501 / S501-V43
S506 / S506-V43
SA35
SCLR24
SCY53
SEC	5
SFE42
SL35
SOU53
SOW53
SOX53
SOY53
SOY-B53
SRU53
SRW53
SRX53
SRY53
SSN53
SSU53
SSW53
SSY53
SSY-RL53
STY53
T36
TC37
TJN32
TJS32
TL36
W36

Fuse type Page

UL Class

CC	1, 3
G	5
J	7, 9, 11
K5(H)13
L15
RK119, 24
RK527
T32

Plug fuses

Rejection base35
UL Edison base36
CSA Edison base37

UL supplemental

Midget38, 40
------------------	---------

Automotive

Glass tube/blade42
----------------------------	-----

Glass/ceramic tube

5x20 mm43, 44
1/4"x1-1/4"45, 46

Additional Eaton circuit protection products

Below are other Eaton products that can help you complete your application with Edison branded fuses, or solve other application needs. Visit Eaton.com/Edison for more information.

- High speed fuses
- IEC and British Standard fuses
- Photovoltaic fuses, holders and blocks
- Medium voltage fuses
- Fuse blocks and holders
- Power distribution and terminal blocks
- Connector products
- Disconnect switches
- Surge protective devices
- Telecom protection products (fuses, blocks and disconnects)
- Accessories (fuse pullers, dummy neutrals, etc.)

Customer assistance

Customer Satisfaction Team - US and Canada

Available to answer questions regarding Edison products Monday-Friday, 8:00 a.m. – 4:30 p.m. Central Time. Contact:

- Toll-free phone: 855-4EDISON (855-433-4766)
- Toll-free fax: 800-862-5178
- E-mail: edisonorders@eaton.com

Online resources

Visit Eaton.com/Edison for additional product information.

Your authorized distributor is:

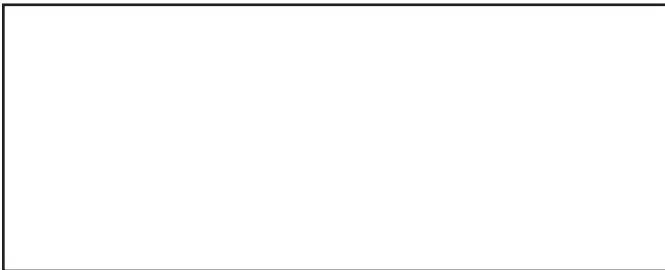

Eaton
1000 Eaton Boulevard
Cleveland, OH 44122
United States
Eaton.com

Edison Fuse, Inc.
114 Old State Road
Ellisville, MO 63021 USA
Eaton.com/Edison

© 2019 Eaton
All Rights Reserved
Printed in USA
Publication No.1005
February 2019



Eaton and Edison are valuable trademarks of Eaton in the U.S. and other countries. You are not permitted to use the Eaton trademarks without prior written consent of Eaton.