

4 in. Square Boxes

Conduit Knockouts



BC52151-K

Concentric knockouts.



CI52151-KSB

Concentric knockouts.

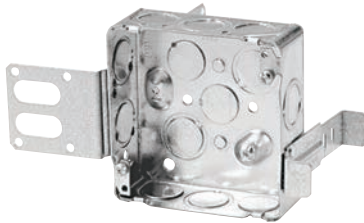

BC52151-KSSX

Concentric knockouts. "Wraparound" bracket for 2-1/2 in. and 3-5/8 in. steel studs. With integral support bracket.



BC53151-K







Concentric knockouts.

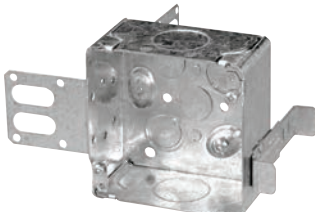

Cat. No.	Volume (Cu. in.)	Features		Knockouts			
		Bracket	Raised Ground Screw	1/2 in. sides	1/2 in. bottom	3/4 in. sides	3/4 in. bottom
1-1/2 in. Deep							
BC52151-K	21.0	-	yes	10	4	6	2
CI52151-KSB	21.0	"SB"	yes	8	4	4	2
BC52151-KSSX	21.0	"SSX"	yes	7	4	3	2
BC53151-K	21.0	-	-	10	-	6	-

4 in. Square Boxes

Conduit Knockouts

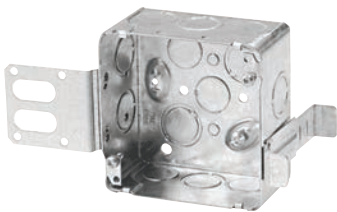
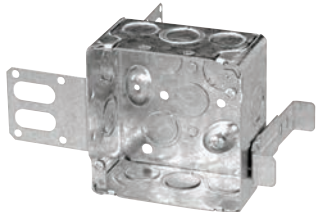
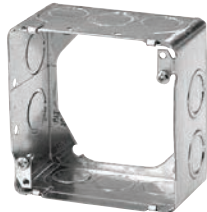
			
BC52171-HV-KIT		BC52171-KSSXHVKIT	
			
CI52171-1-SSX-1	CI52171-1	BC52171-K	
<p>"Wraparound" bracket for 2-1/2 in. and 3-5/8 in. steel studs. With integral support bracket. Present for 2 x 1/2 in. drywall thickness.</p>		<p>Concentric knockouts.</p>	
			
CI52171-KSB	BC52171-KSSX	CI52171-KSSX-1	BC53171-K
<p>Concentric knockouts.</p>	<p>Concentric knockouts. "Wraparound" bracket for 2-1/2 in. and 3-5/8 in. steel studs. With integral support bracket. Present for 1 x 1/2 in. drywall thickness.</p>	<p>Concentric knockouts. "Wraparound" bracket for 2-1/2 in. and 3-5/8 in. steel studs. With integral support bracket. Present for 2 x 1/2 in. drywall thickness.</p>	<p>Concentric knockouts.</p>



Cat. No.	Volume (Cu. in.)	Features		Knockouts				
		Bracket	Raised Ground Screw	1/2 in. sides	1/2 in. bottom	3/4 in. sides	3/4 in. bottom	1 in. sides
2-1/8 in. Deep								
BC52171-HV-KIT	33.6	-	yes	6	-	2	-	-
BC52171-KSSXHVKIT	33.6	"SSX"	yes	6	-	2	-	-
CI52171-1	30.0	-	yes	-	4	-	2	4
CI52171-1-SSX	21.0	"SSX"	yes	-	4	-	2	2
CI52171-1-SSX-1	21.0	"SSX"	yes	-	4	-	2	2
BC52171-K	30.0	-	yes	10	4	6	2	-
CI52171-KSB	30.0	"SB"	yes	8	4	4	2	-
BC52171-KSSX	30.0	"SSX"	yes	7	4	3	2	-
CI52171-KSSX-1	30.0	"SSX"	yes	7	4	3	2	-
BC53171-K	30.0	-	-	10	-	6	-	-

4 in. Square Boxes

Covers



Cat. No.	Description
Flat Covers	
BC52-C-1	Blank
BC52-C-6	1/2 in. conduit knockout
Plaster Ring Cover	
52C31/2-25*	Raised 1/2 in. (3.5 cu. in.) Tapped ears on 2-3/4 in. centers
Single Device Covers	
BC52-C-0	Flat
BC52-C-0-B	Flat blank cover
CI52-C-10	Raised 1/8 in. (1.0 cu. in.)
BC52-C-13	Raised 1/2 in. (3.6 cu. in.)
CI52-C-14	Raised 3/4 in. (5.7 cu. in.)
CI52-C-14-5/8	Raised 5/8 in. (4.3 cu. in.)
CI52-C-15	Raised 7/8 in. (6.8 cu. in.)
CI52-C-16	Raised 1-1/4 in. (9.5 cu. in.)
CI52-C-62	Raised 1/4 in. (1.8 cu. in.)
Two Device Covers	
BC52-C-00	Flat
BC52-C-17	Raised 1/2 in. (6.2 cu. in.)
52 C 18*	Raised 3/4 in. (9.0 cu. in.)
52C185/8-25*	Raised 5/8 in. (7.3 cu. in.)

* UL Listed

4 in. Square Boxes

Covers

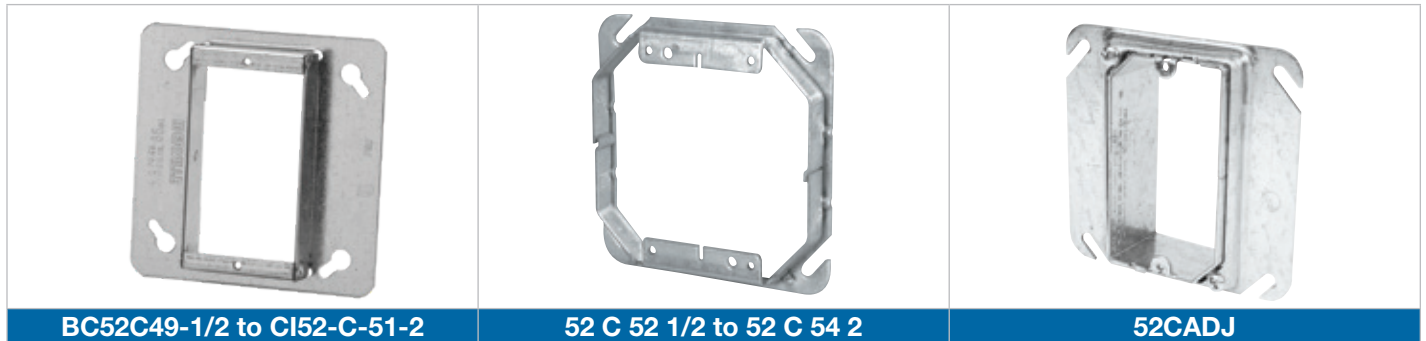

BC52C49-1/2 to CI52-C-51-2

52 C 52 1/2 to 52 C 54 2

52CADJ



Cat. No.	Description
One Device Square Cornered Tile Covers	
BC52C49-1/2	Raised 1/2 in. (3.4 cu. in.)
BC52C49-3/4	Raised 3/4 in. (5.3 cu. in.)
BC52-C-49-5/8	Raised 5/8 in. (4.3 cu. in.)
BC52-C-49-1	Raised 1 in. (6.8 cu. in.)
CI52-C-49-1 1/4	Raised 1-1/4 in. (8.6 cu. in.)
CI52-C-50-1 1/2	Raised 1-1/2 in. (10.0 cu. in.)
CI52-C-51-2	Raised 2 in. (14.0 cu. in.)
One Device Square Cornered Tile Covers - Adjustable	
52CADJ	Adjustable from 1/2 in. to 1-1/2 in. raise (from 3.4 to 10.0 cu. in.)
Two Device Square Cornered Tile Covers	
52 C 52 1/2	Raised 1/2 in. (6.0 cu. in.)
52 C 52 5/8	Raised 5/8 in. (8.3 cu. in.)
52 C 52 3/4	Raised 3/4 in. (9.0 cu. in.)
52 C 52 1	Raised 1 in. (12.5 cu. in.)
52 C 52 1 1/4	Raised 1-1/4 in. (15.5 cu. in.)
52 C 53 1 1/2	Raised 1-1/2 in. (19.0 cu. in.)
52 C 54 2	Raised 2 in. (25.5 cu. in.)

4 in. Square Boxes

Covers

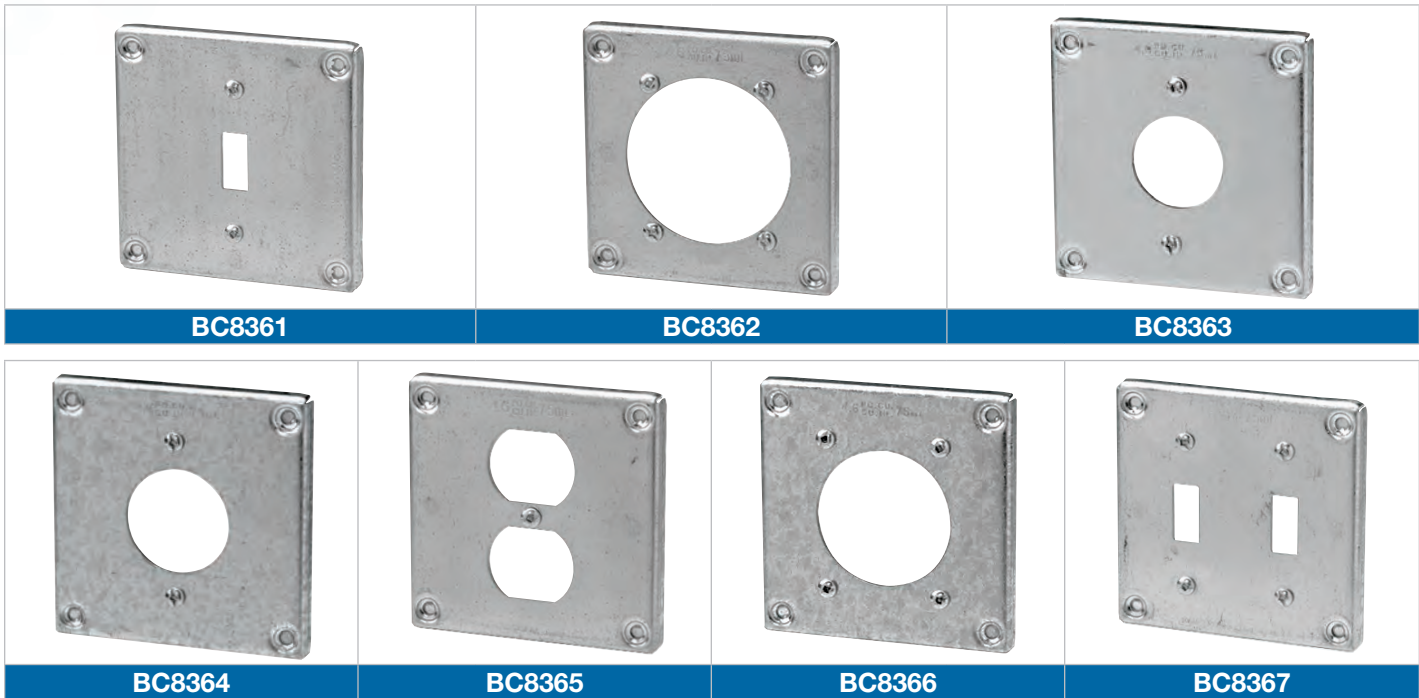

Cat. No.	Description
3/8 in. Raised Surface Covers (4.6 cu. in.) Device Mount	
BC8361	One toggle switch
BC8362	For 2-5/8 in. diameter 30 / 50 A single receptacle
BC8363	For 1-13/32 in. diameter 15 A single receptacle
BC8364	For 1-19/32 in. diameter 20 / 30 A single locking receptacle
BC8365	One duplex receptacle
BC8366	For 2-9/64 in. diameter 30 A single receptacle
BC8367	Two toggle switches

Complete with device mounting screws

Cover	NEMA Configuration						
	A	V	Pole	Wire	Phase	Rec. Dia	NEMA
BC8363	15	125	2	3	1	1.406	5-15R
BC8364	20	125	2	3	1	1.562	L5-20R
BC8364	20	250	2	3	1	1.562	L6-20-R
BC8364	20	347	2	3	1	1.562	L24-20R
BC8364	20	600	2	3	1	1.562	L9-20R
BC8364	20	125/250	3	3	1	1.562	L10-20R
BC8364	20	250	3	3	3	1.562	L11-20R
BC8364	20	125/250	3	4	3	1.562	L14-20R
BC8366	30	125	2	3	1	2.109	5-30R
BC8364	30	125	2	3	1	1.562	L5-30R
BC8366	30	250	2	3	1	2.109	6-30R
BC8364	30	250	2	3	1	1.562	L6-30R
BC8362	30	125/250	3	4	3	2.647	14-30R
BC8362	50	125/250	3	4	1	2.647	14-50R

4 in. Square Boxes

Covers

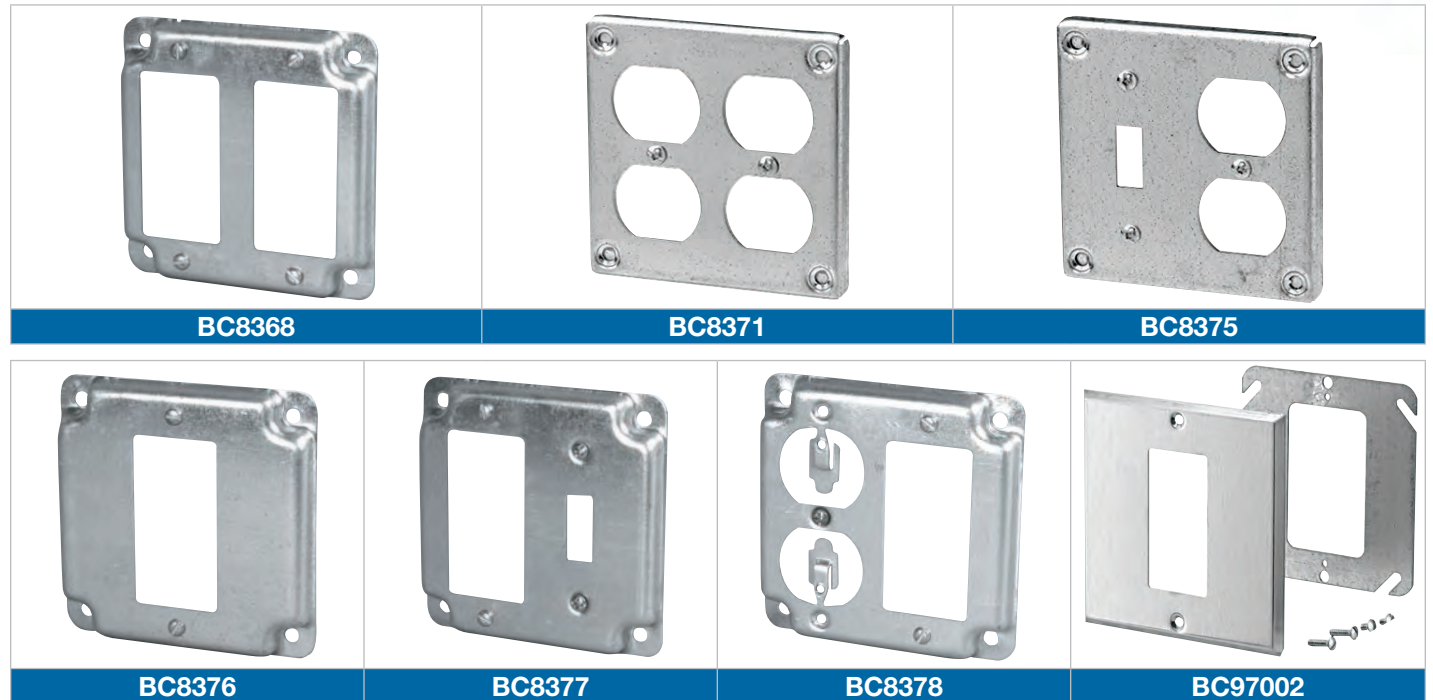

Cat. No.	Description
3/8 in. Raised Surface Covers (4.6 cu. in.)	
BC8368	2 Decora/GFCI
BC8371	Two duplex receptacles
BC8375	One toggle switch, one duplex receptacle
BC8376	One Decora/GFCI
BC8377	One toggle switch, one Decora/GFCI
BC8378	One duplex receptacle, one Decora/GFCI
GFCI Conversion Kits (Stainless Steel / Steel)	
BC97002	To install GFCI on 4 in. square boxes. Complete with mounting screws

Complete with device mounting screws

When extra capacity is required, the 8300 Series of 4 in. square covers can be mounted on a 72 Series of 4-11/16 in. square boxes using a CI72-A-52 adaptor. (see page A41)