



www.flitetest.com

# FT Mini Mustang

Designed By: Josh Bixler  
 Drawing By: Dan Sponholz



## SPECIFICATIONS

DESCRIPTION		IMPERIAL	METRIC
LENGTH		19 in	482 mm
CENTER OF GRAVITY	CG	1.00 in	25 mm
WING SPAN		24 in	622 mm
WING AREA		115 in <sup>2</sup>	7.4 dm <sup>2</sup>
DRY WEIGHT		5.5 oz	156 g
ALL UP WEIGHT	AUW	7.8 oz	222 g
WING LOADING	WL	9.8 oz/ft <sup>2</sup>	29.9 g/dm <sup>2</sup>
WING CUBIC LOADING	WCL	10.9	

## RECOMMENDED SETTINGS

	THROW	EXPO
AILERON	12°	30%
ELEVATOR	12°	30%
RUDDER	12°	30%



## SHEET & TILE KEY

1	2	3	4
5	6	7	8

9	10	11	12
13	14	15	16



# DRAWING KEY

## FOLD TYPES



A - FOLD (ABOVE)



B - FOLD (BESIDE)



C



C - FOLD (COVER)



## LINE TYPE/COLOR

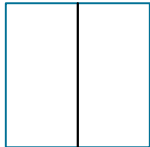

CUT



50% SCORE

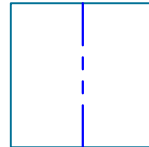

CREASE

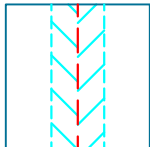

45° DOUBLE BEVEL

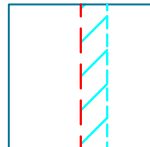

45° SINGLE BEVEL

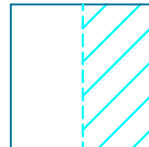

EDGE BEVEL

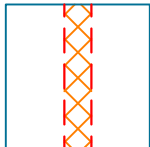

CAVITY

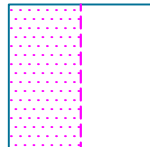

REMOVE PAPER

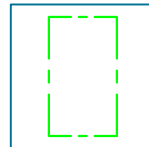

REFERENCE/  
OPTIONAL



## SYMBOLS

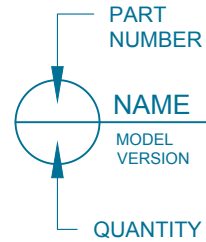

MIRRORED PART

# FT Mini Mustang

Designed By: Josh Bixler  
Drawing By: Dan Sponholz

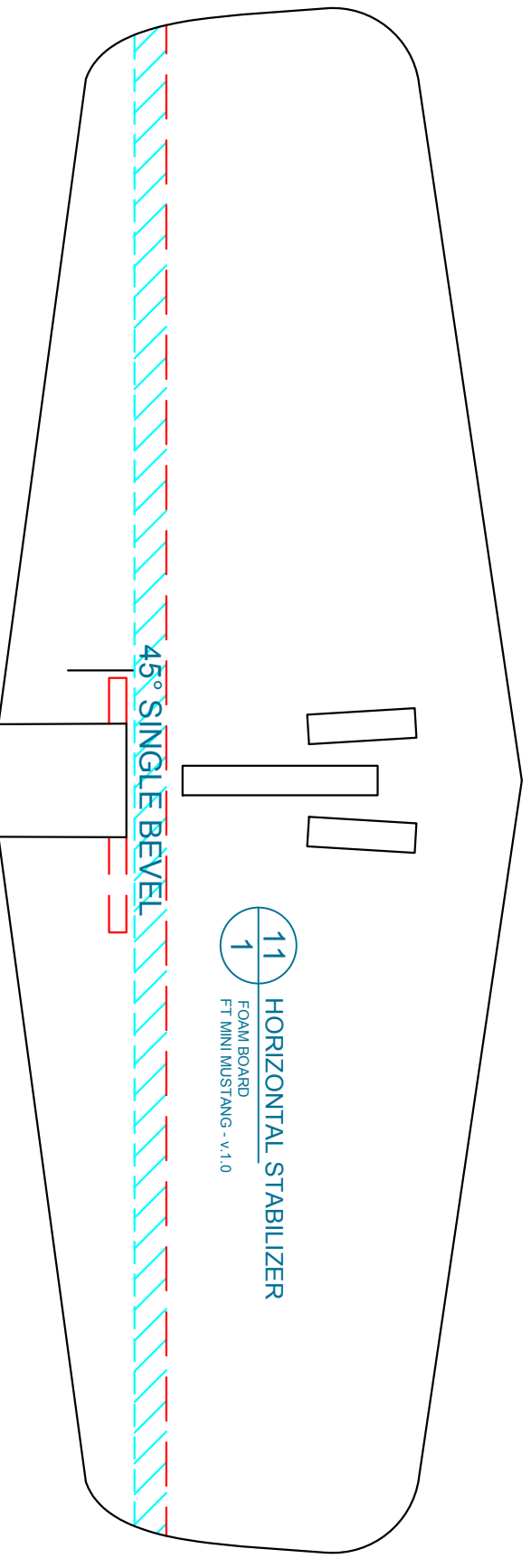
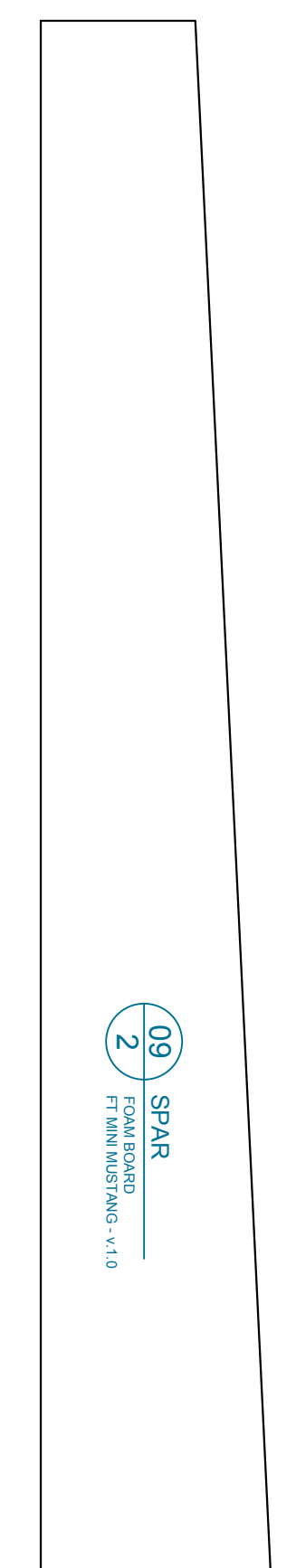
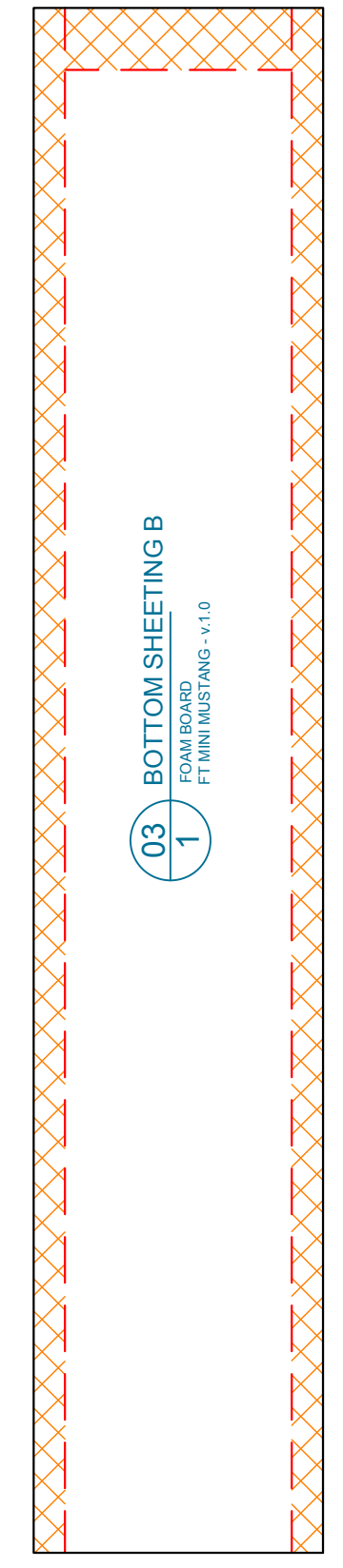
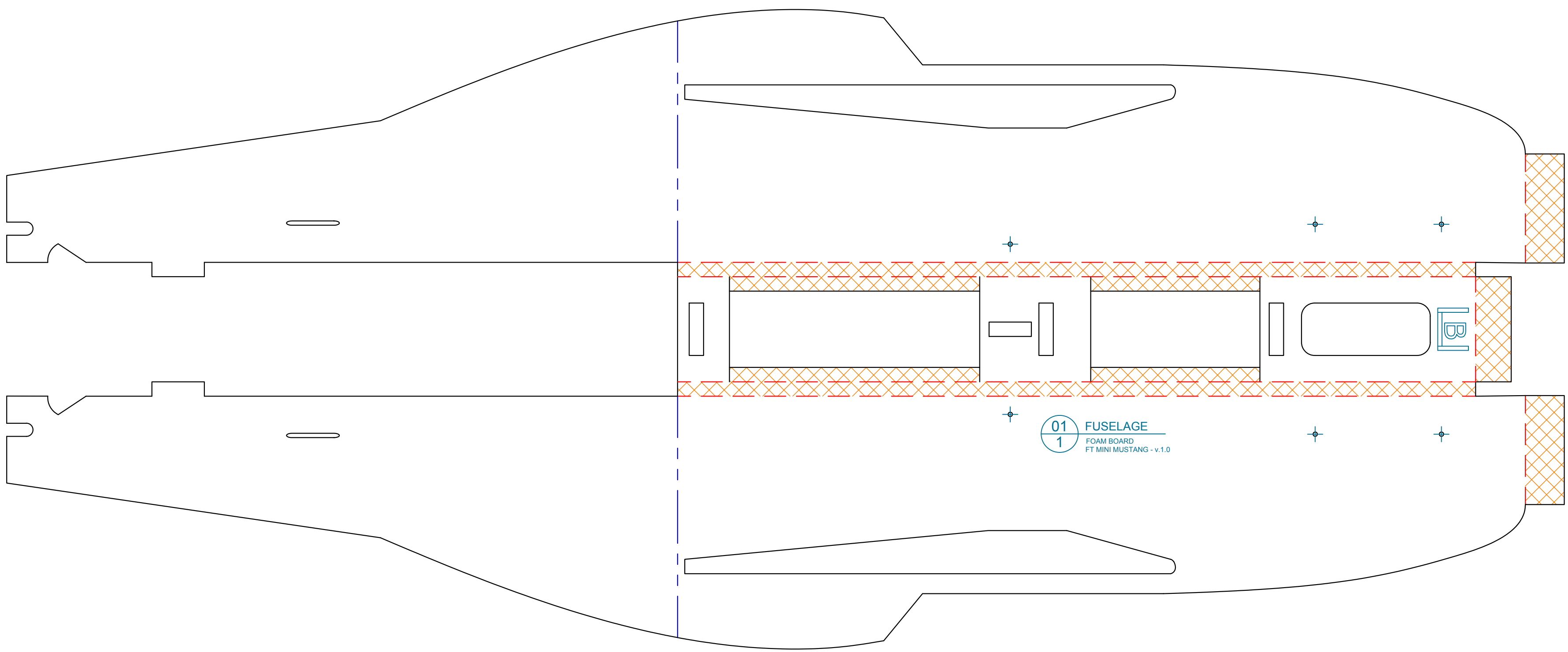
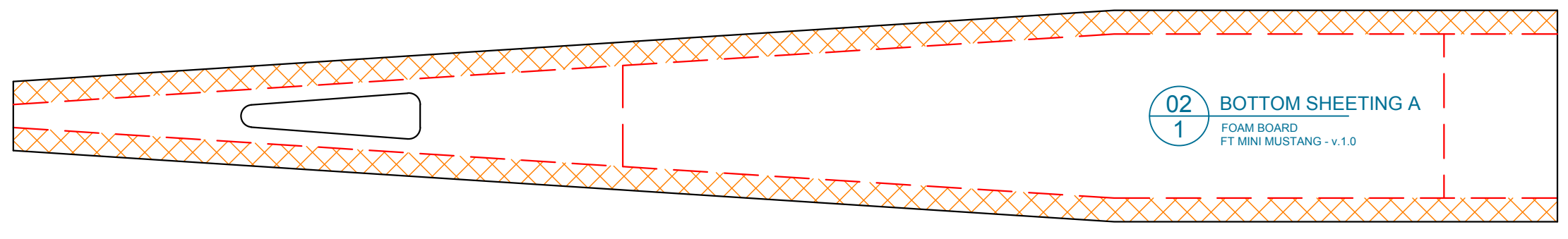
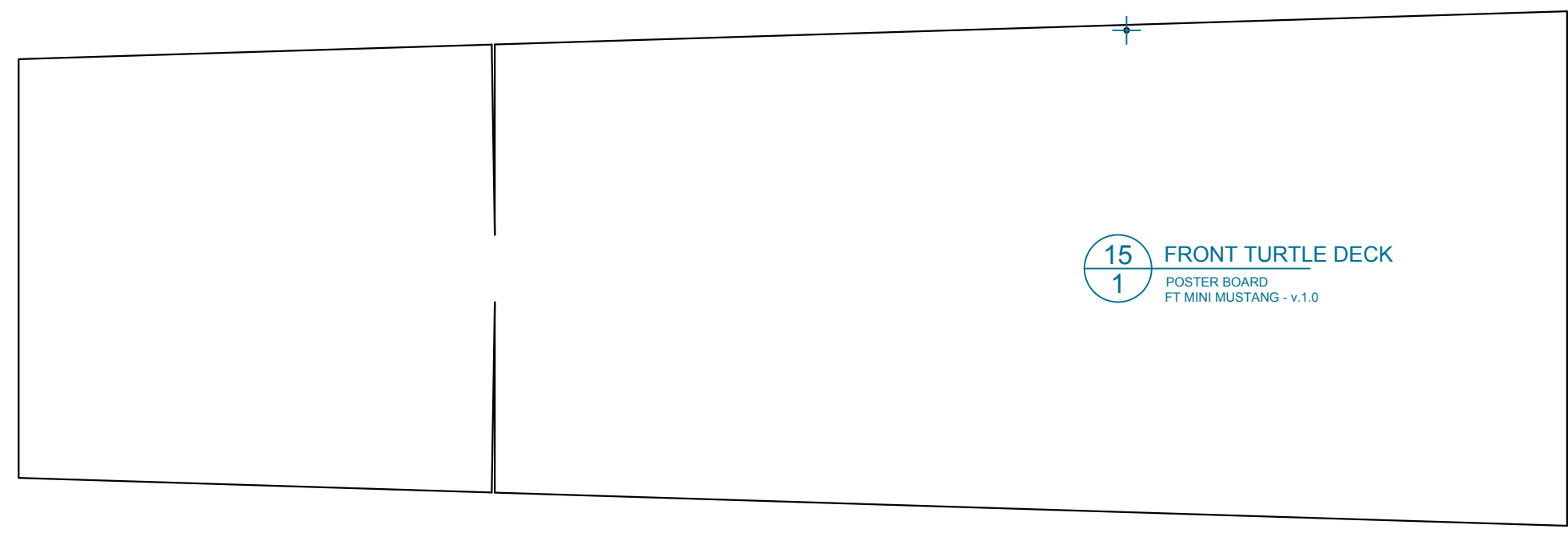
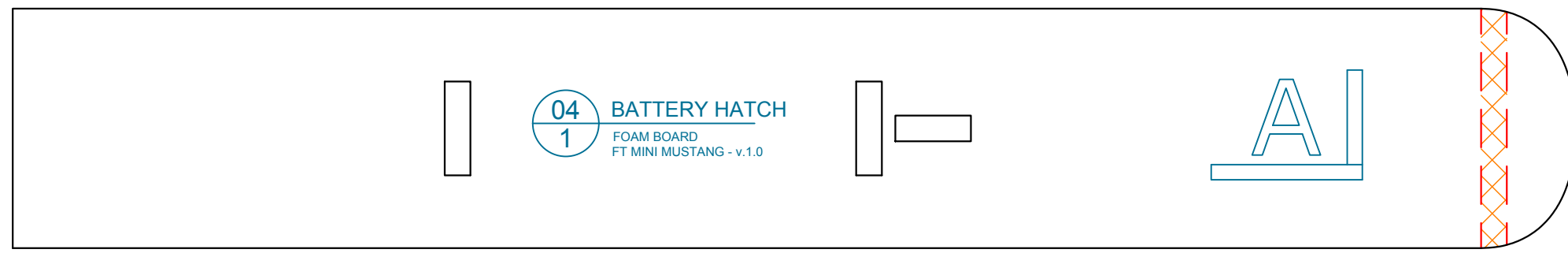
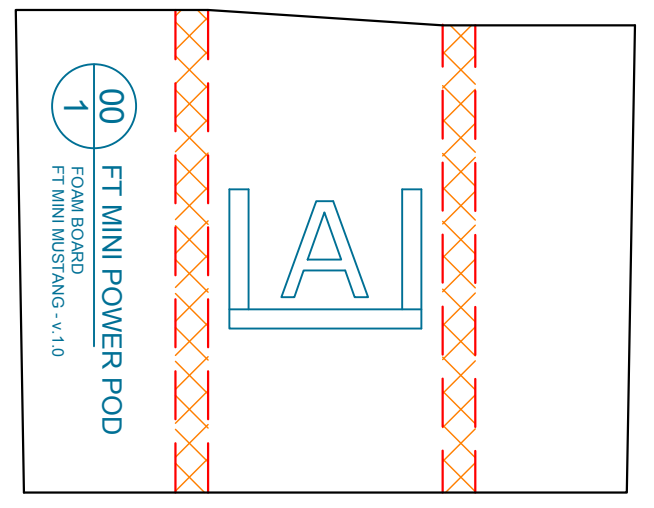
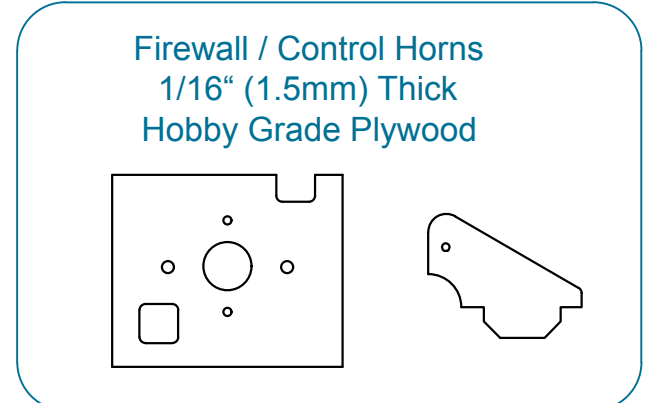
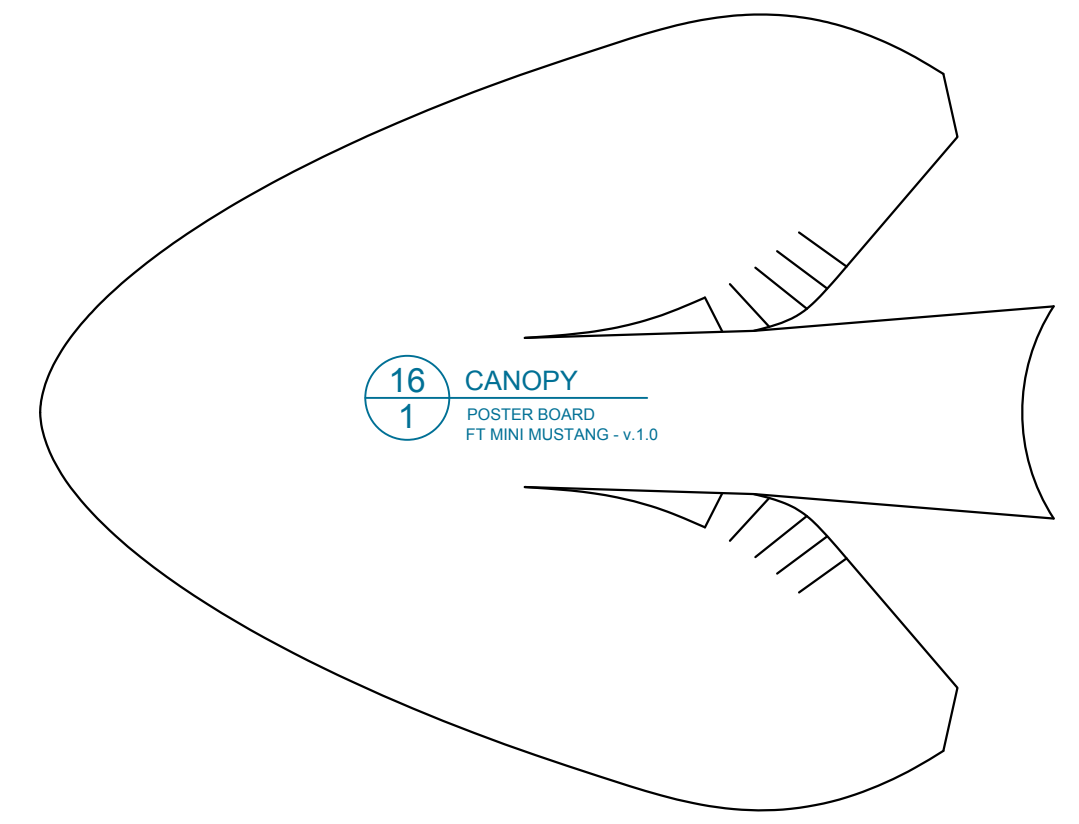
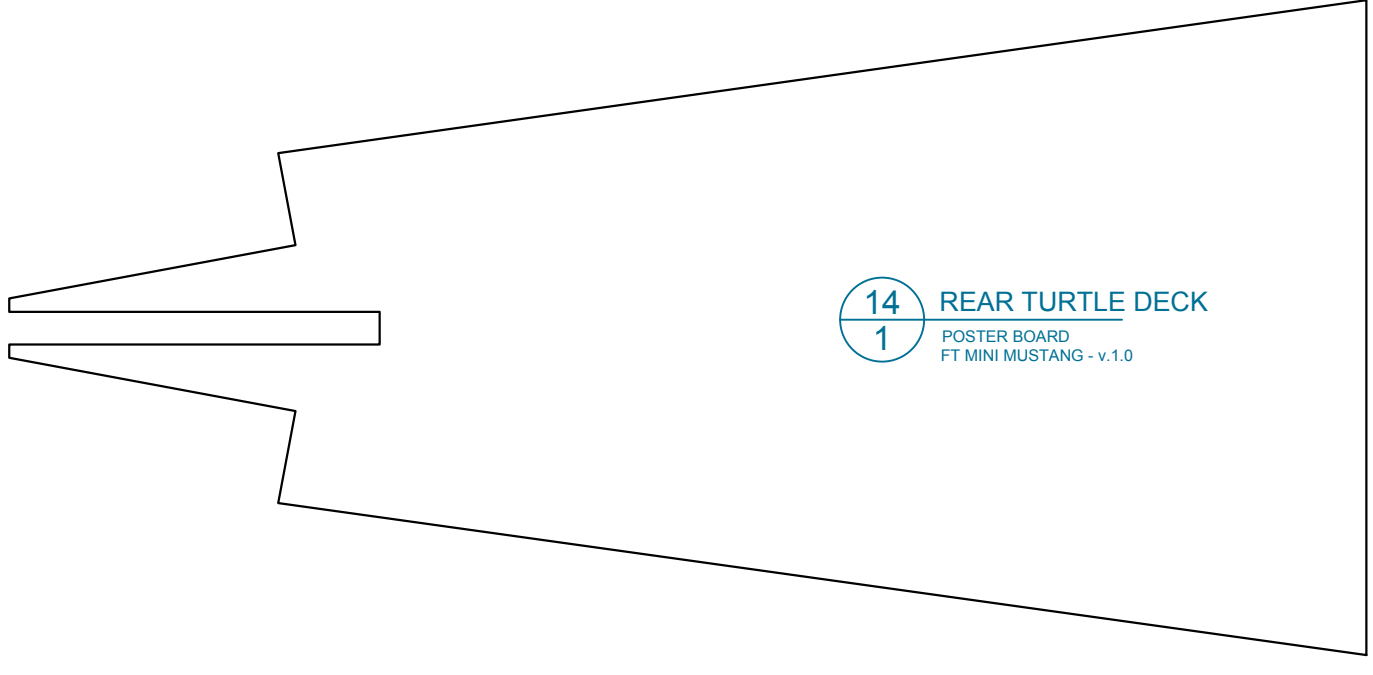
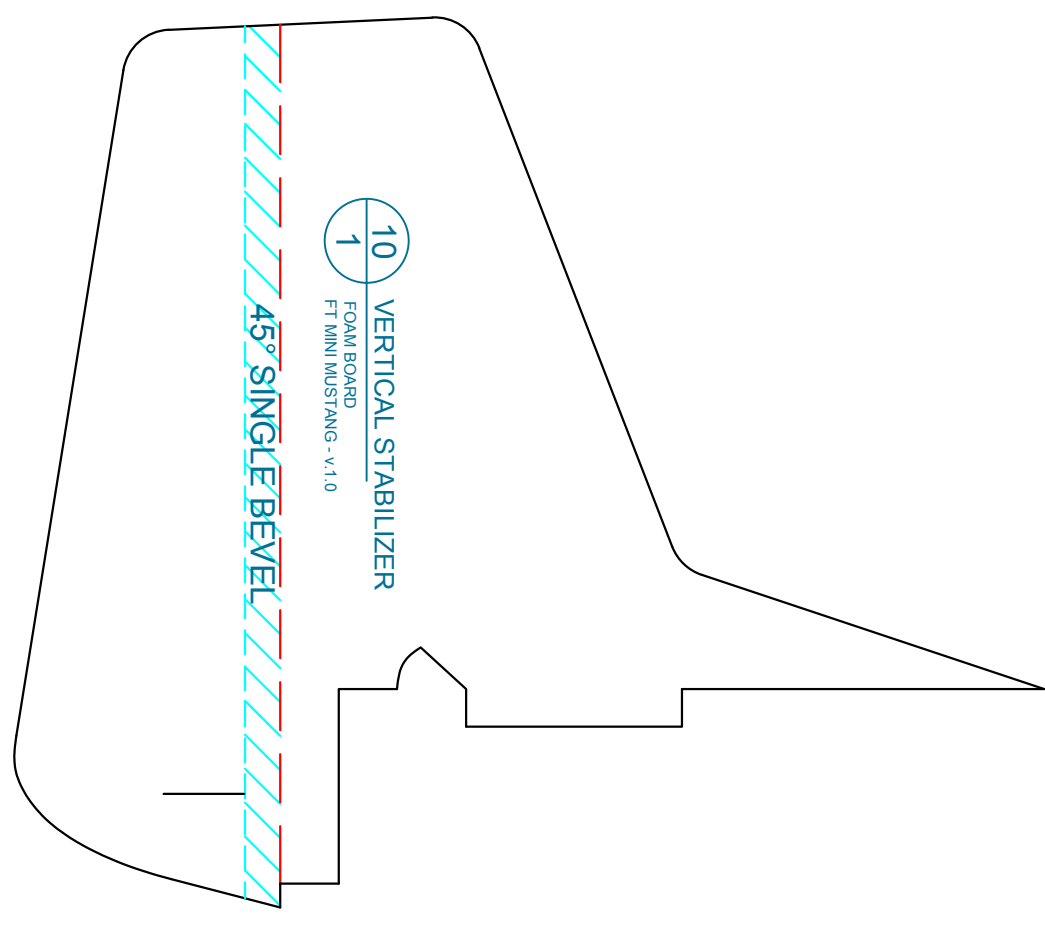
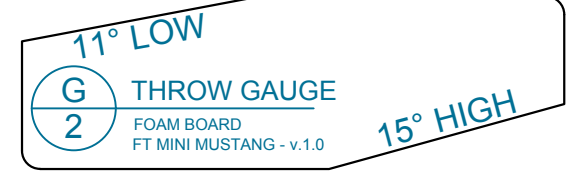
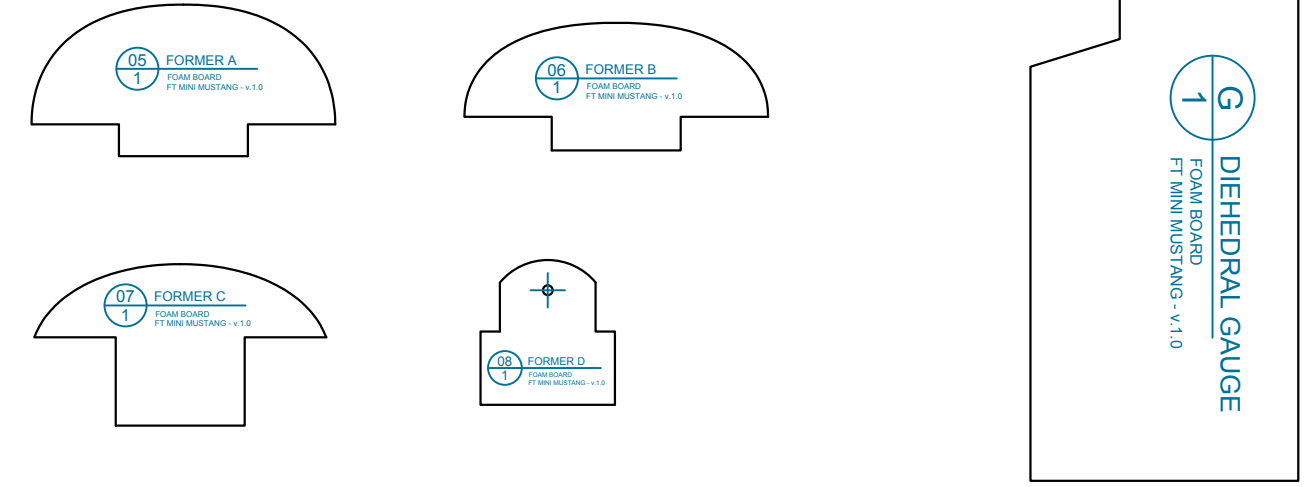

# FT Mini Mustang

Designed By: Josh Bixler  
Drawing By: Dan Sponholz

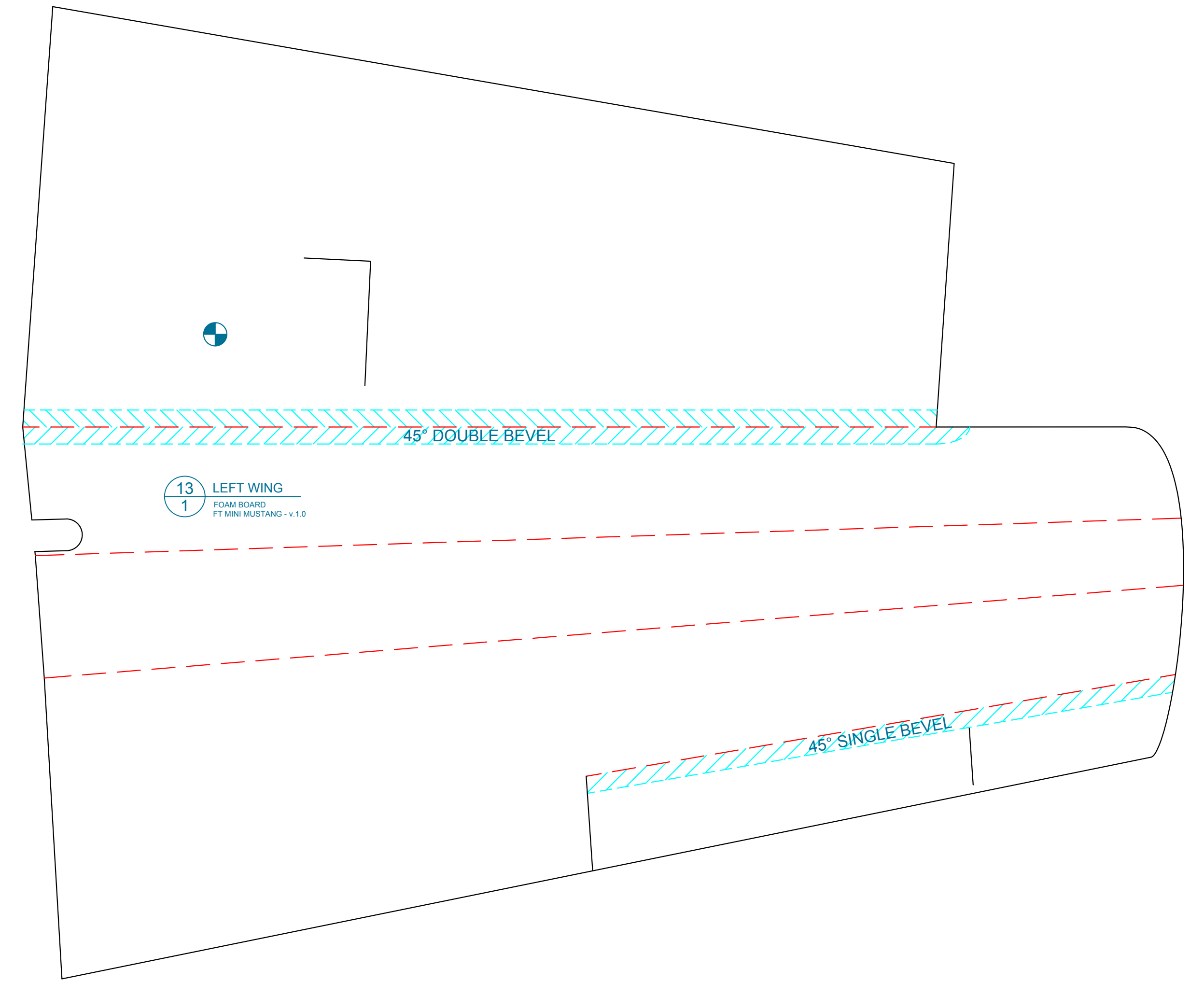
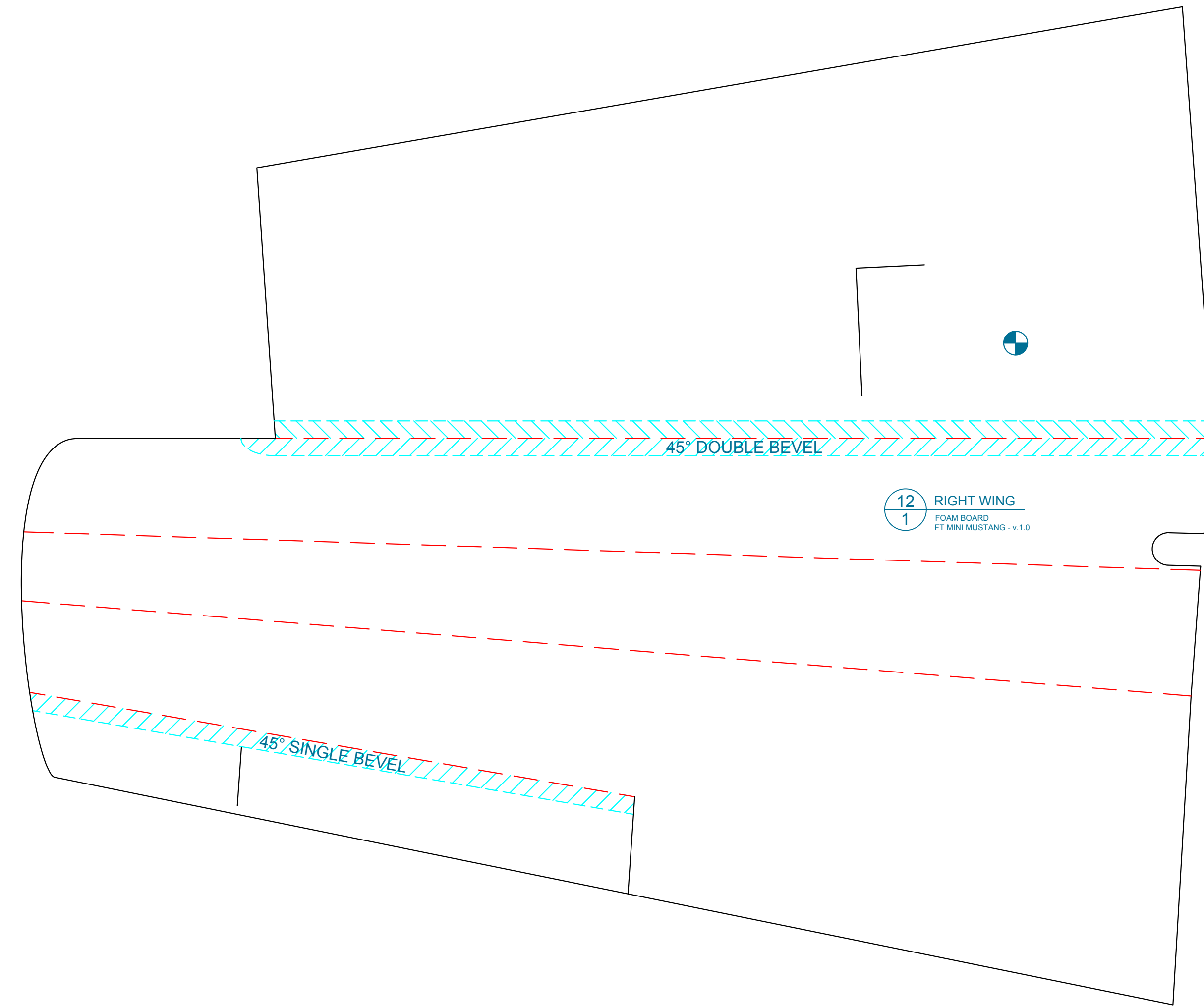

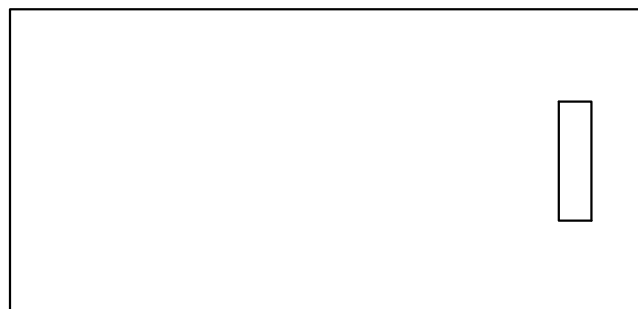
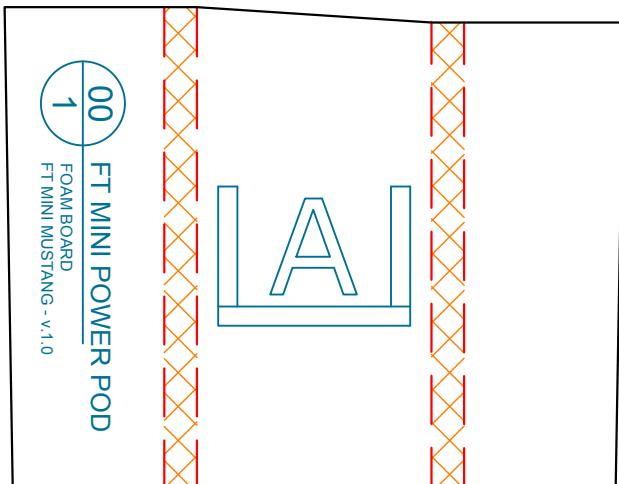
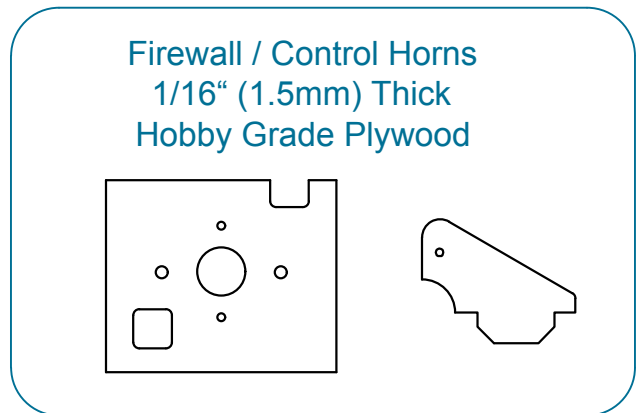
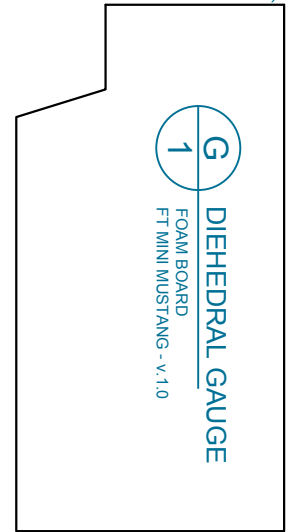
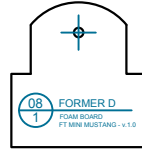
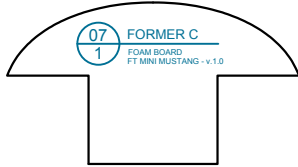
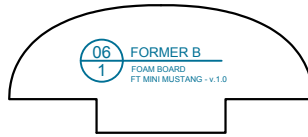
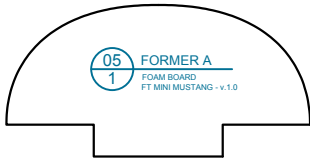

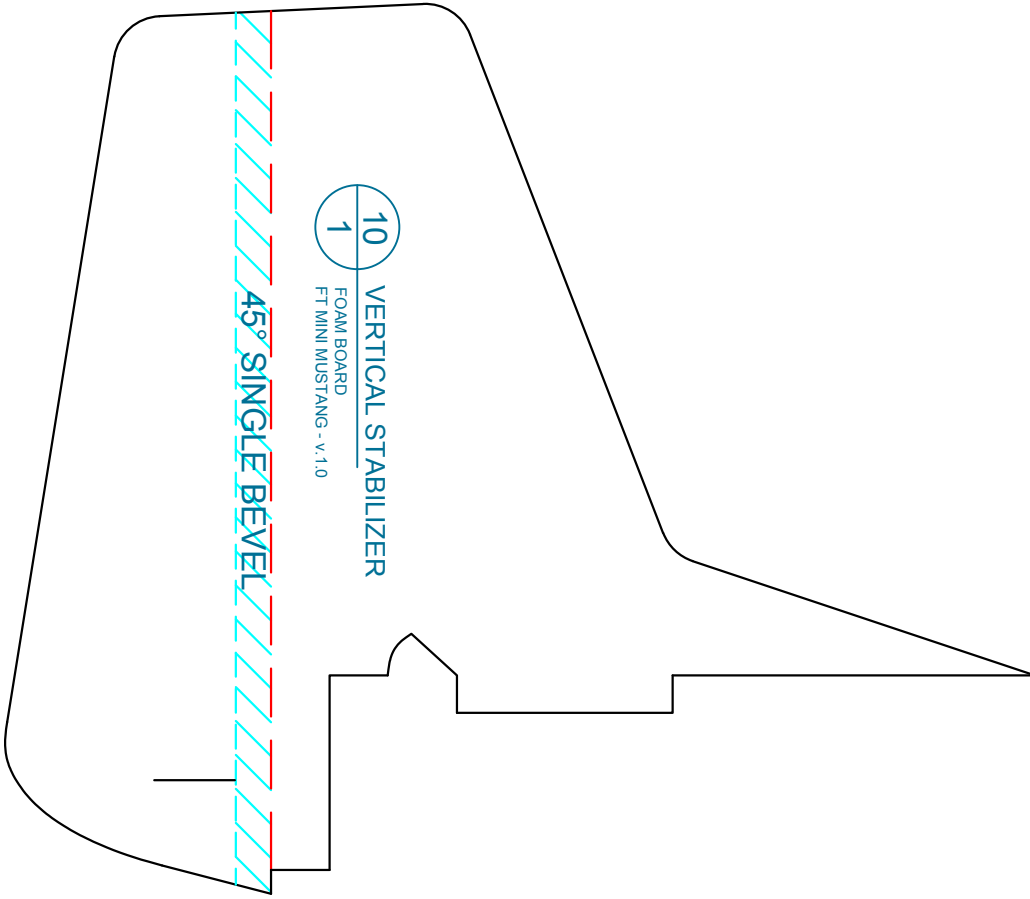

04  
1  
BATTERY HATCH  
FOAM BOARD  
FT MINI MUSTANG - v.1.0

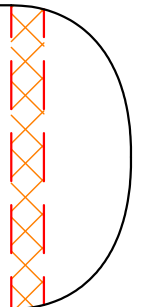
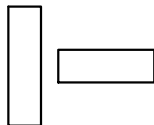

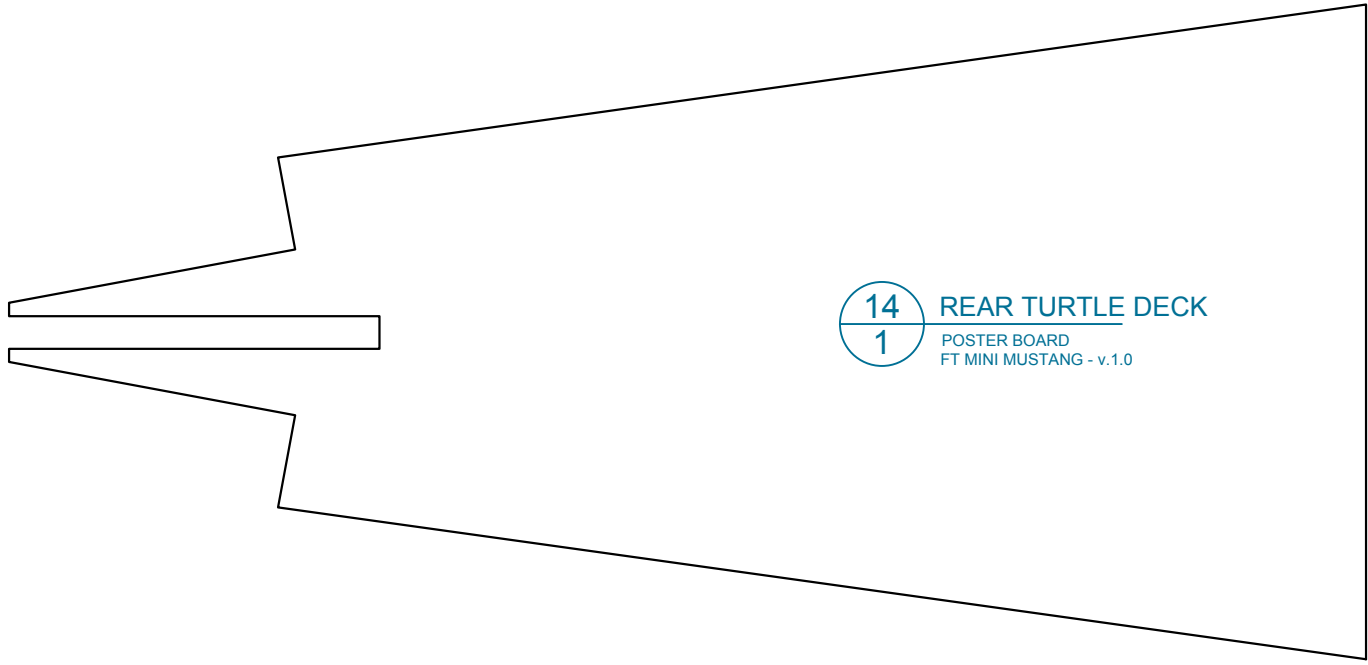

14  
1

**REAR TURTLE DECK**

POSTER BOARD  
FT MINI MUSTANG - v.1.0

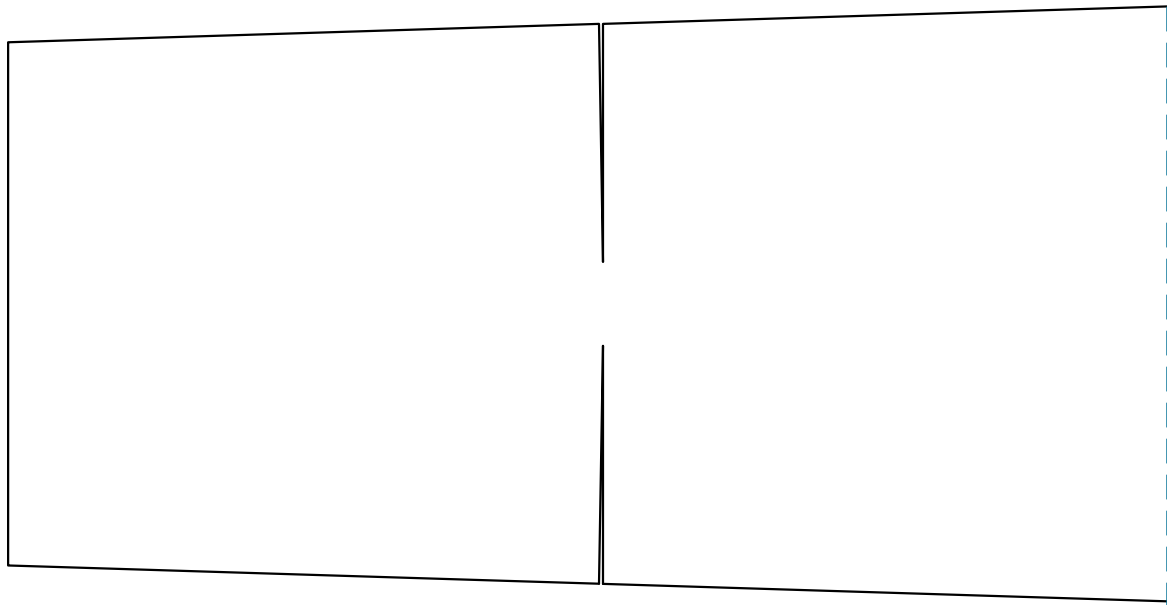

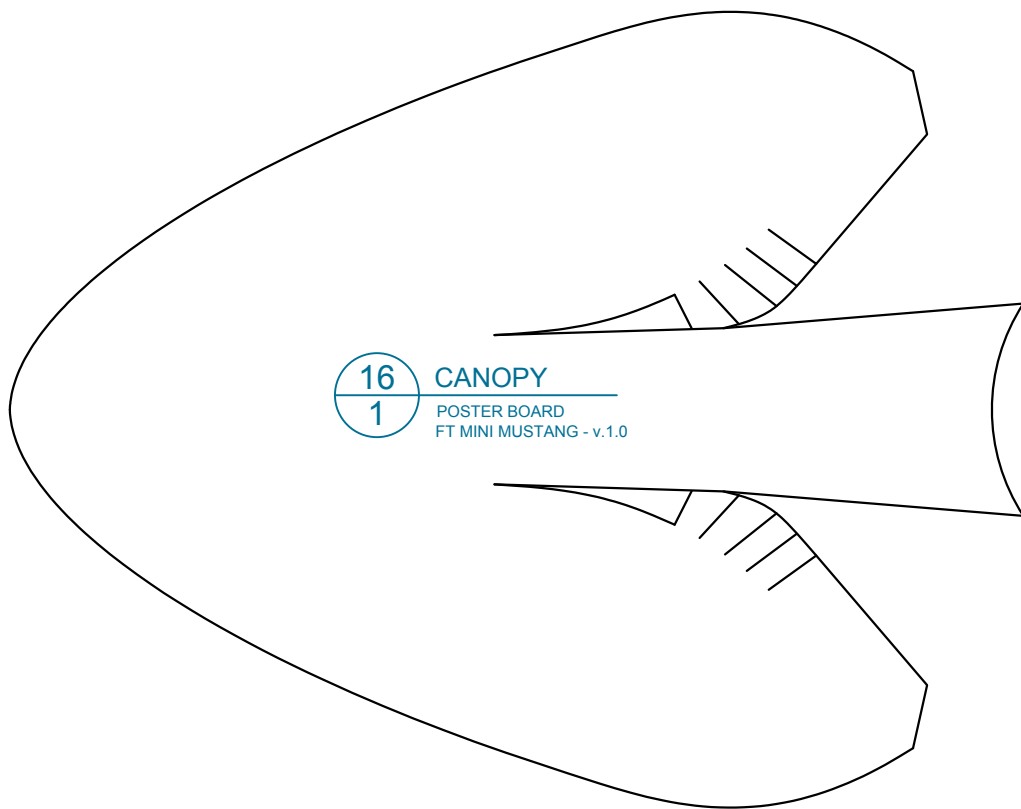

**16**  
1 CANOPY  
POSTER BOARD  
FT MINI MUSTANG - v.1.0

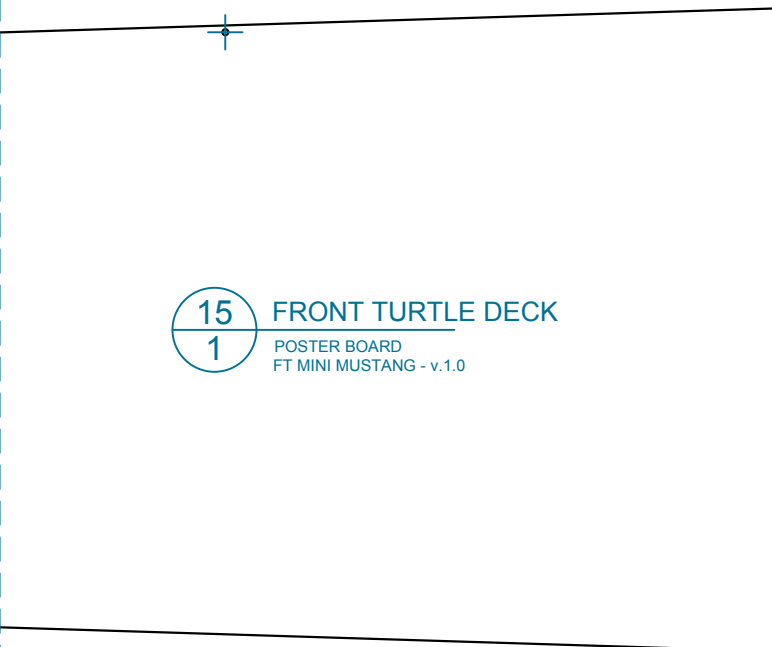

**15**  
1 FRONT TURTLE DECK  
POSTER BOARD  
FT MINI MUSTANG - v.1.0



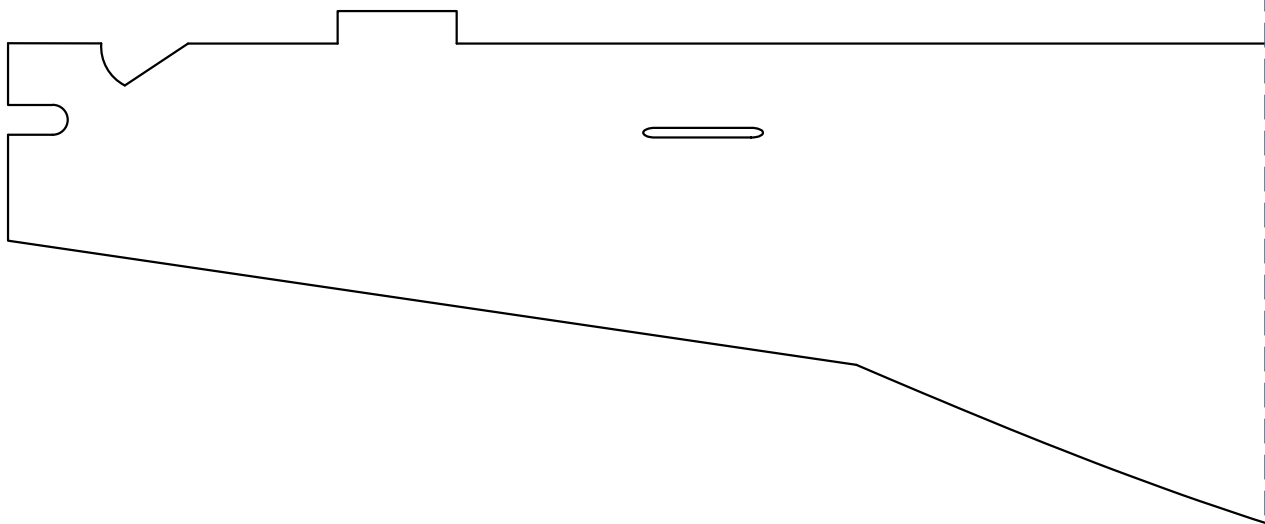
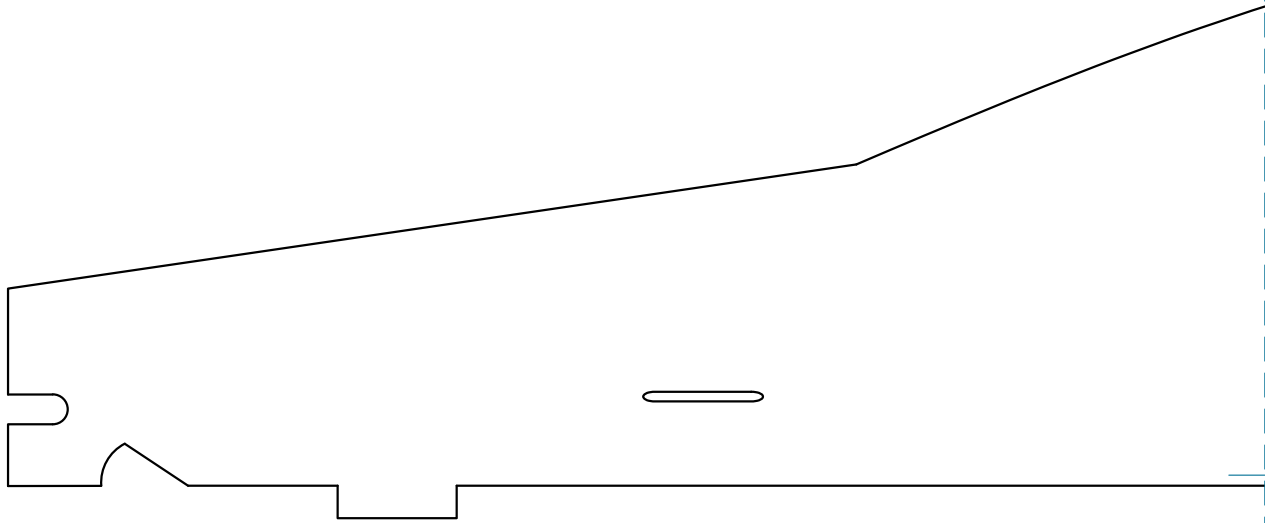
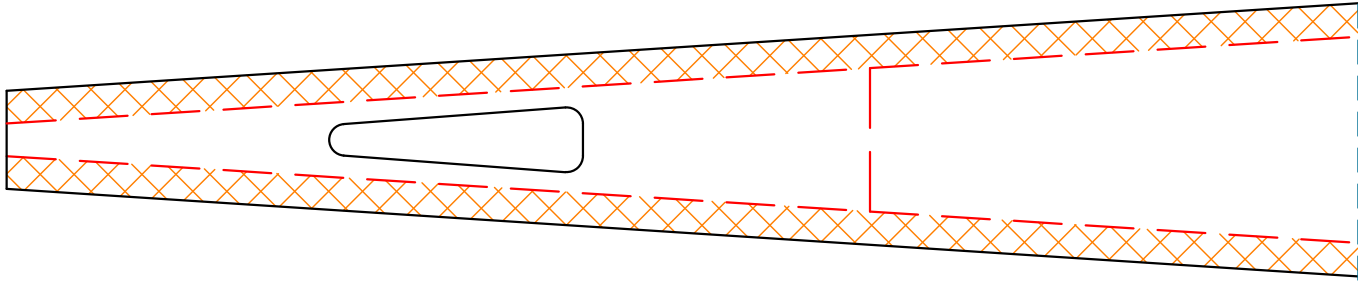

02  
1

**BOTTOM SHEETING A**

FOAM BOARD  
FT MINI MUSTANG - v.1.0

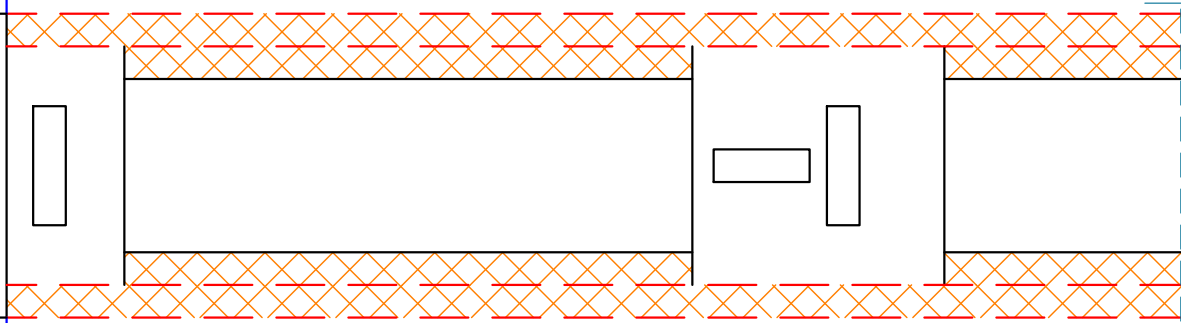
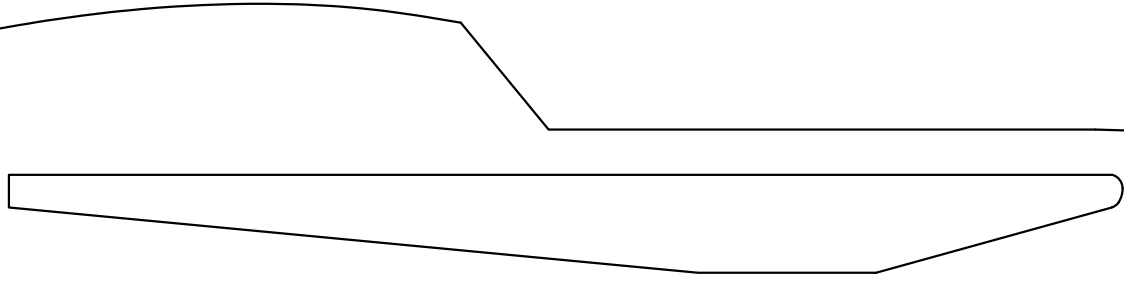
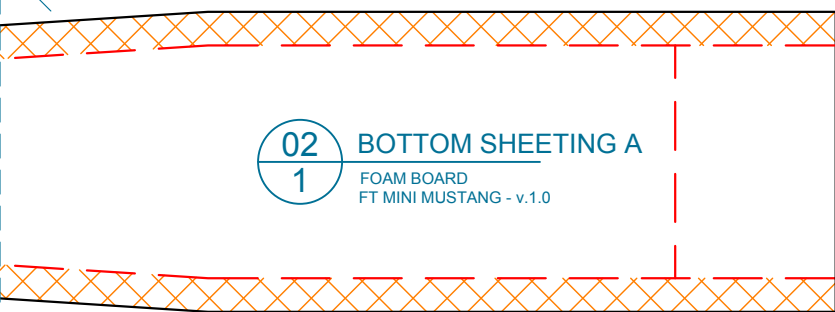

01  
1

**FUSELAGE**

FOAM BOARD  
FT MINI MUSTANG - v.1.0

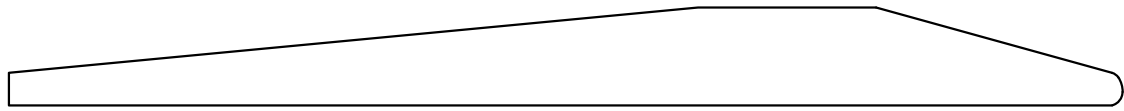

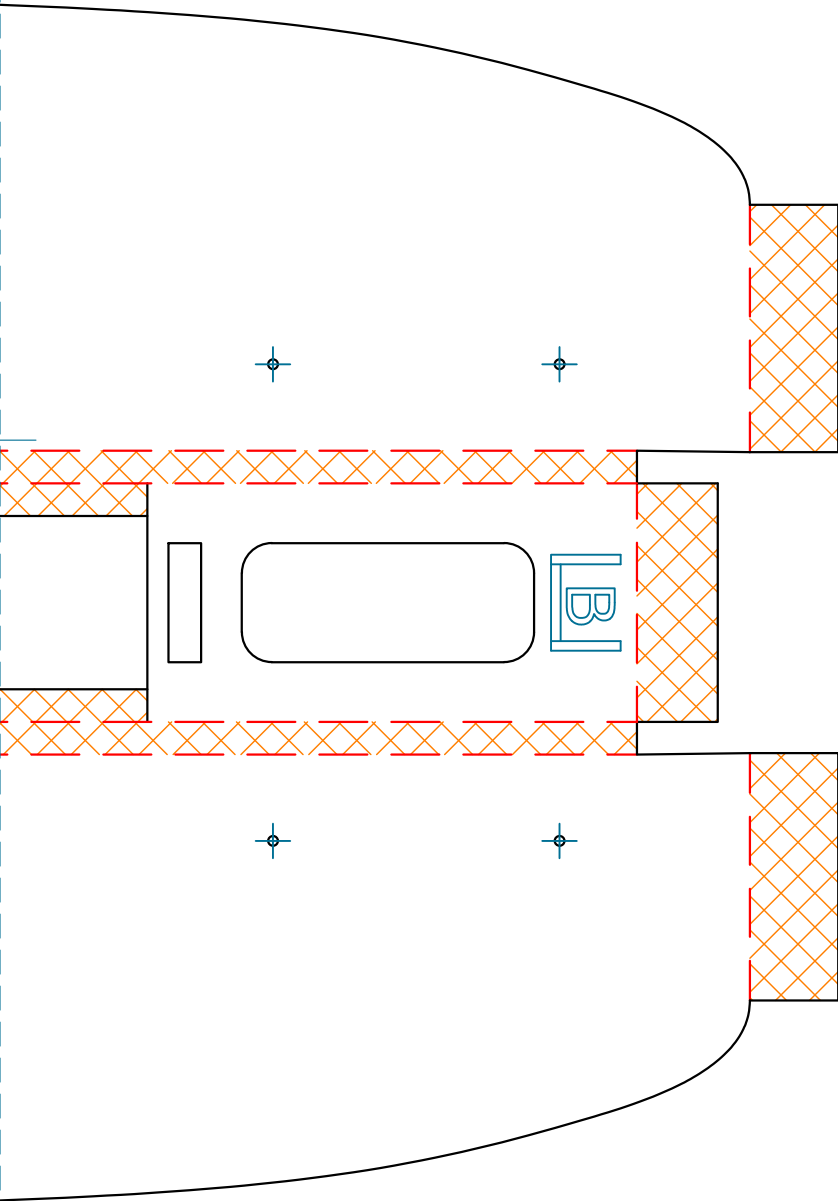

03 BOTTOM SHEETING B  
 1 FOAM BOARD  
 FT MINI MUSTANG - v.1.0

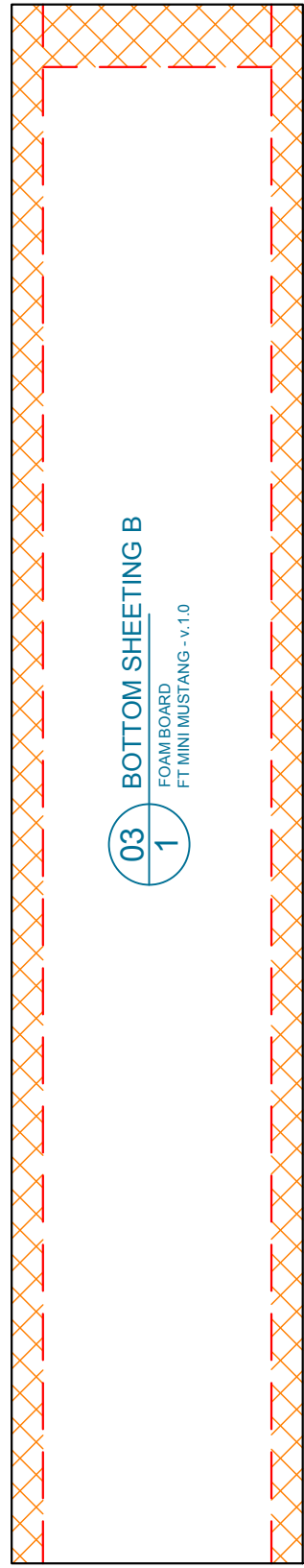

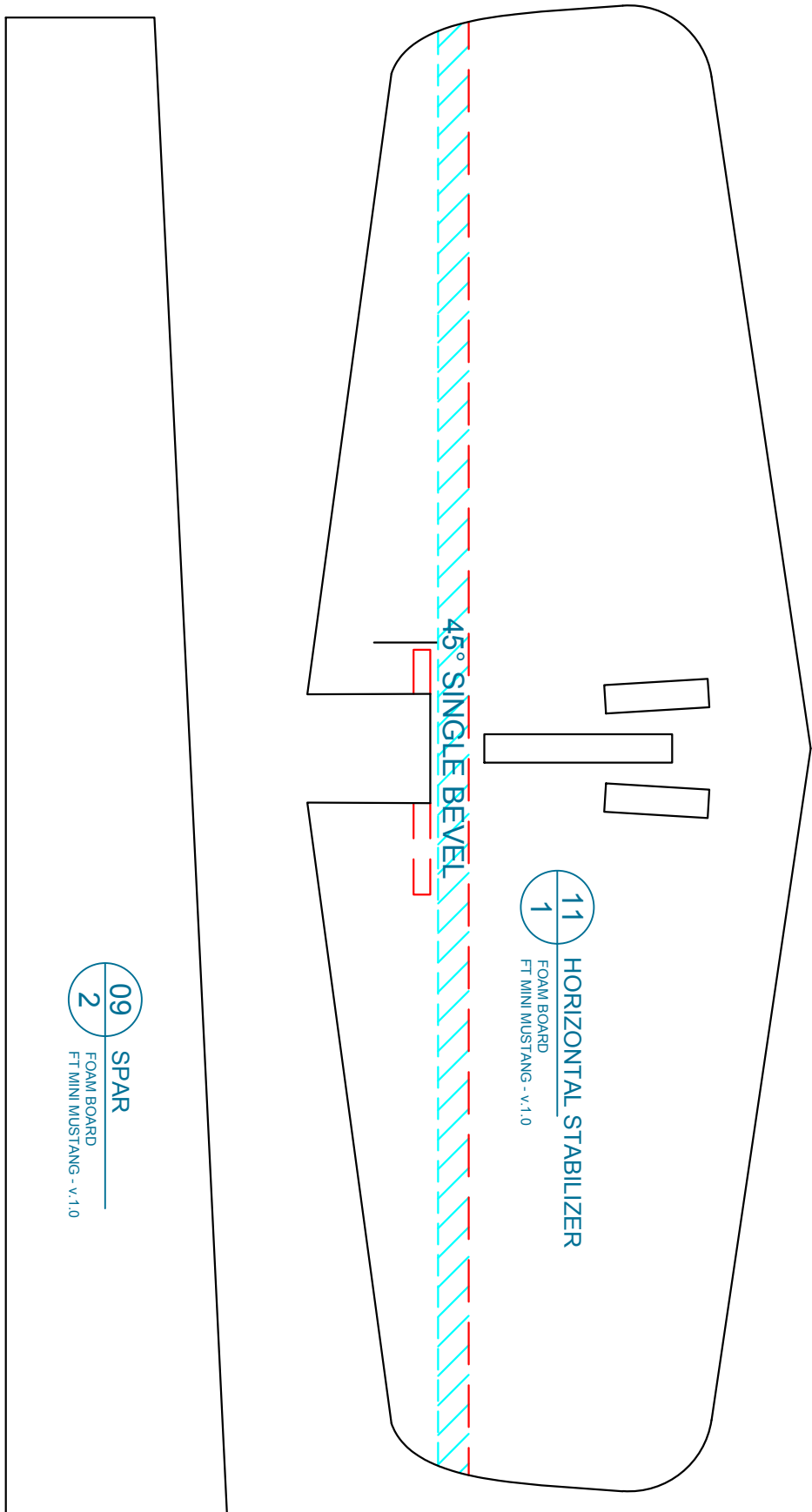

IN  
CM

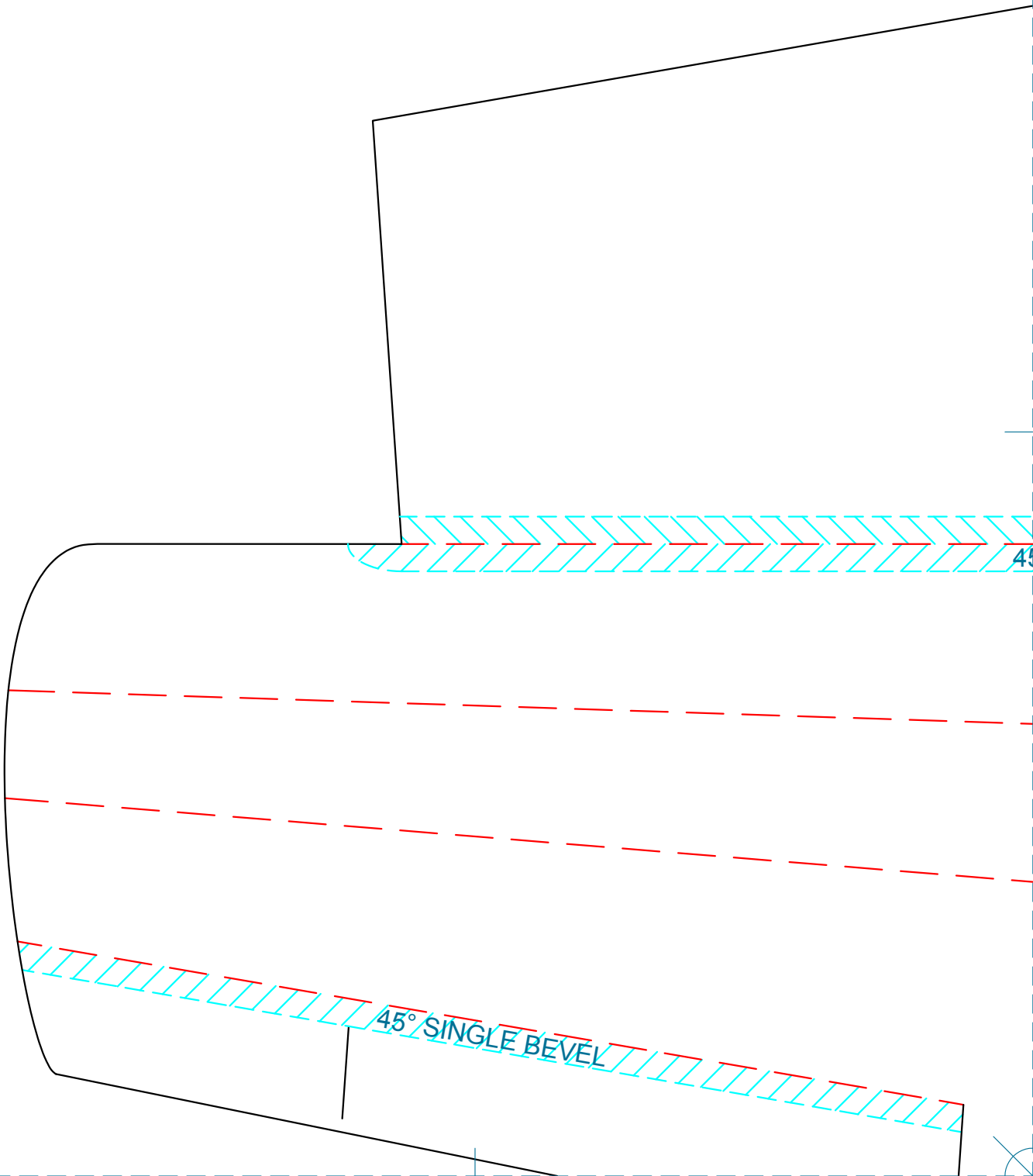

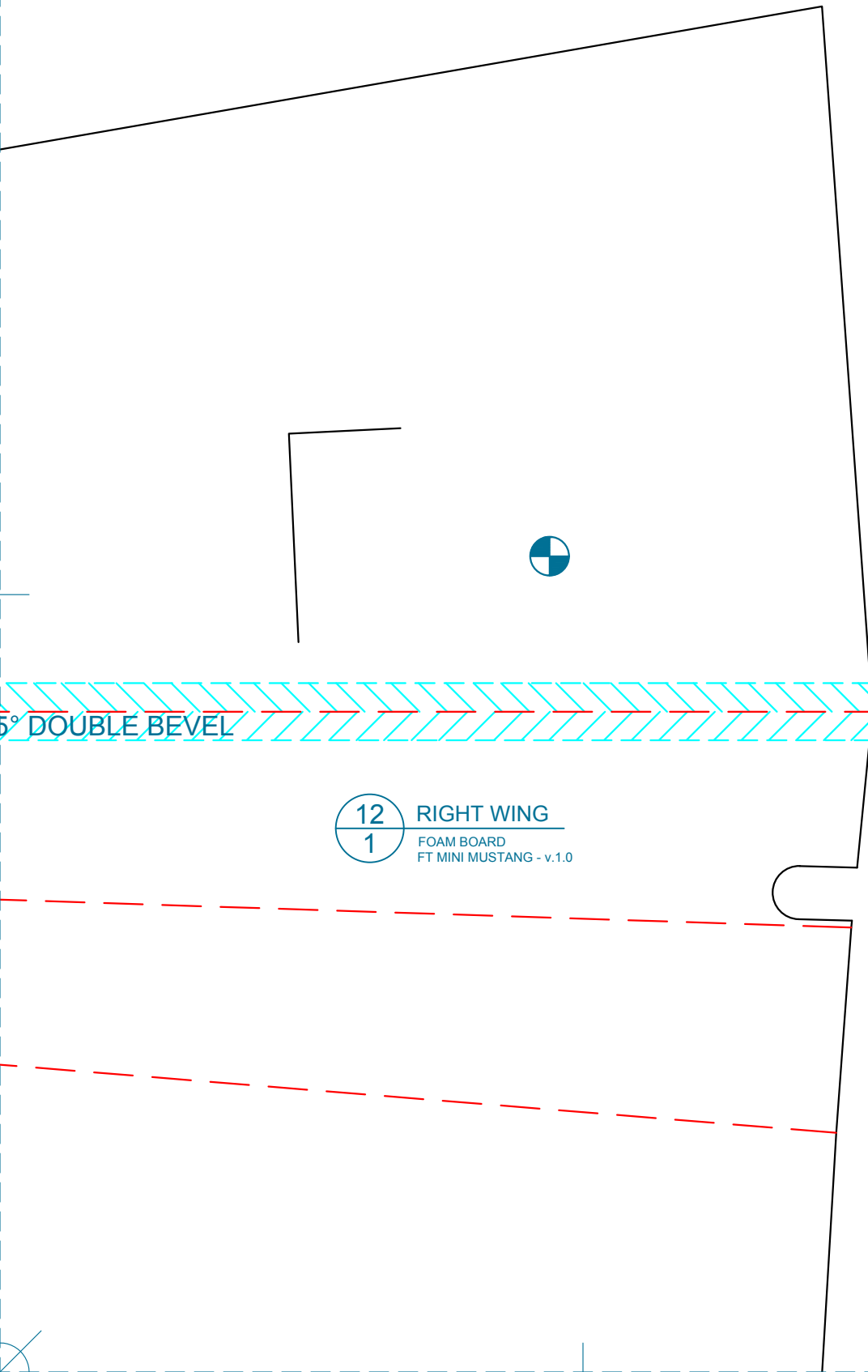

5° DOUBLE BEVEL

12  
1

RIGHT WING  
FOAM BOARD  
FT MINI MUSTANG - v.1.0

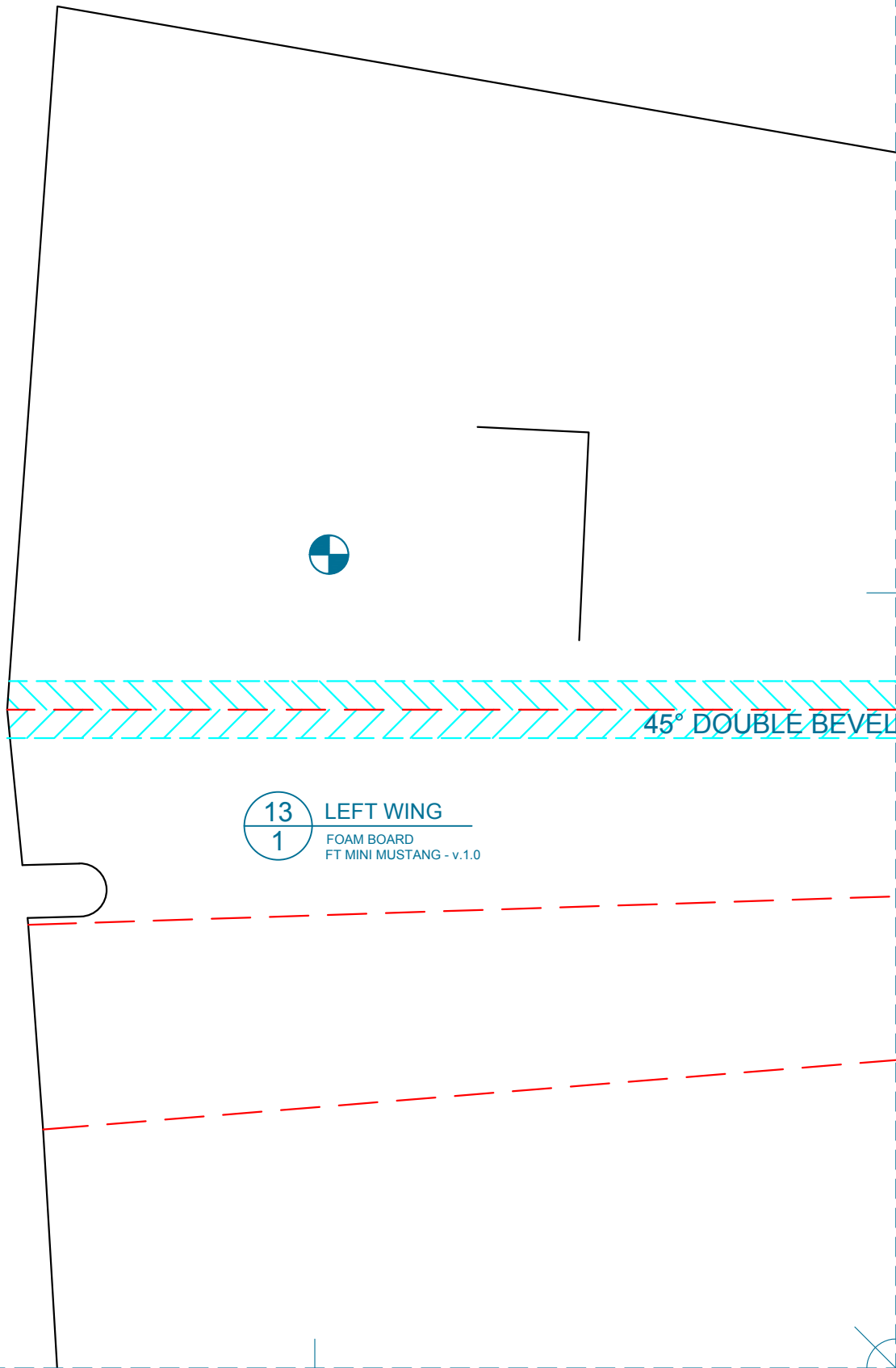

**13** LEFT WING  
**1** FOAM BOARD  
FT MINI MUSTANG - v.1.0

45° DOUBLE BEVEL

