

LOCK RODS & MORE

CREATE AN AIRTIGHT SEAL & SECURELY LOCK
YOUR TRAILER SWING DOOR

LOCK ROD SETS

Commonly Used in Trailer Swing Doors, and Easily Installed with
Locally Available 3/4" Pipe

P/N	DESCRIPTION
021-00312	Lock Rod Hardware Set: 2 Keepers, 2 Cams, 4 Half Bearing Guide Plates, 2 Half Bearing Rod Guides, 2 Guide Plates, Rod Guide, Handle, Handle Mount, Seal Plate, Seal Pin, Rivet
021-00313	Narrow Lock Rod Hardware Set: 2 Keepers, 2 Cams, 4 Half Bearing Guide Plates, 2 Half Bearing Rod Guides, 2 Guide Plates, Rod Guide, Handle, Handle Mount, Seal Plate, Seal Pin, Rivet
023-00968	Lock Rod Pipe, .105" wall

INDIVIDUAL LOCK ROD COMPONENTS

#	P/N	DESCRIPTION
1	023-00956	Standard Top or Bottom Keeper, Single
1	023-00973	Narrow Top or Bottom Keeper, Single
2	023-00958	Standard Top or Bottom Cam, Left-Hand (for roadside bottom or curbside top)
2	023-00957	Standard Top or Bottom Cam, Right-Hand (for curbside bottom or roadside top)
2	023-00972	Narrow Top or Bottom Cam, Left-Hand (for roadside bottom or curbside top)
2	023-00971	Narrow Top or Bottom Cam, Right-Hand (for curbside bottom or roadside top)
3	023-00960	Top or Bottom Guide Plate, Single
4	023-00959	Top or Bottom Half Bearing Guide Plate, Single
5	023-00966	Half Bearing Rod Guide
6	023-00961	Seal Pin
7	023-00962	Handle
8	023-00963	Handle Mount
9	023-00964	Lock Handle Rivet
10	023-00965	Seal Plate
11	023-00967	Lock Rod Guide

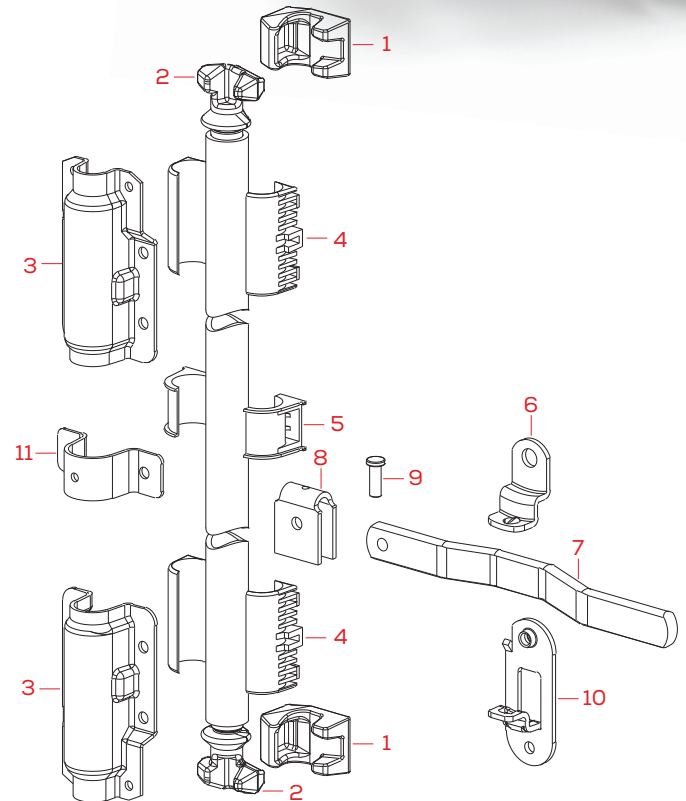

SWING DOOR REPLACEMENT PARTS

DUAL-DUROMETER DOOR SEALS

Door seals are 168" long and light gray in color

P/N	DESCRIPTION
022-01300	.75" Door Width/Thickness
022-01301	1" Door Width/Thickness
022-01305	.5" Door Width/Thickness
022-01306	Corner Tab, 24 Piece Package Set

LOUVERED VENTS

Non-adjustable to always allow air flow or adjustable to open and close as needed



P/N	DESCRIPTION
024-03000	Plain Aluminum, Adjustable
024-03001	Plain Aluminum, Non-Adjustable

See online or catalog for Freight Vent Doors options

DOOR BUMPERS

Rubber door bumpers protects swing doors and trailer walls from getting scratched or dented



P/N	DESCRIPTION
022-01084	Great Dane Door Bumper, Cross: 45064
022-01085	Utility Dane Door Bumper, Cross: 3-1250-25

TRAILER DOCK BUMPER

Protect docks from impact damage



P/N	DESCRIPTION
022-01409	Molded durable rubber compound with two .53" Mounting Holes

CHAIN & SNAP HOLD-BACK

Chain style hold-back features a steel construction and a zinc plated finish



P/N	DESCRIPTION
021-00051	Chain, snap assembly and anchor hold back



We're YOUR #1 Source for Swing Door Hinges - OVER 45 HINGES IN STOCK!

Check out our jumbo 24 x 36 Door Poster for our large selection of **SWING DOOR HINGES**. A great reference for part numbers, cross reference information & more.

