



PROJETO DE INTERIORES EXECUTIVO
DE MARCENARIA

NVE

NORTE VERDADEIRO ENGENHARIA

Juliana Silva
Arquitetura e Interiores

BOX 15

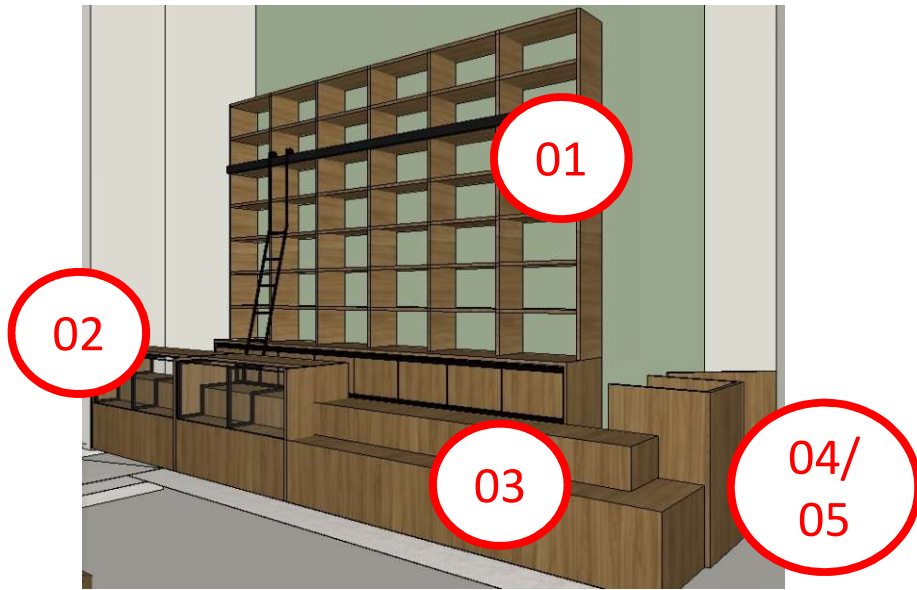

Trilho com escada

01

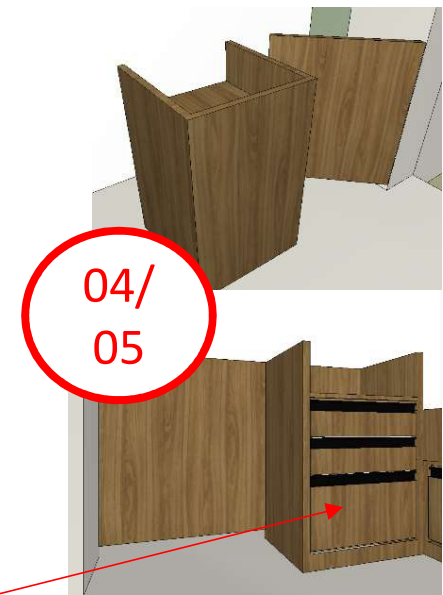
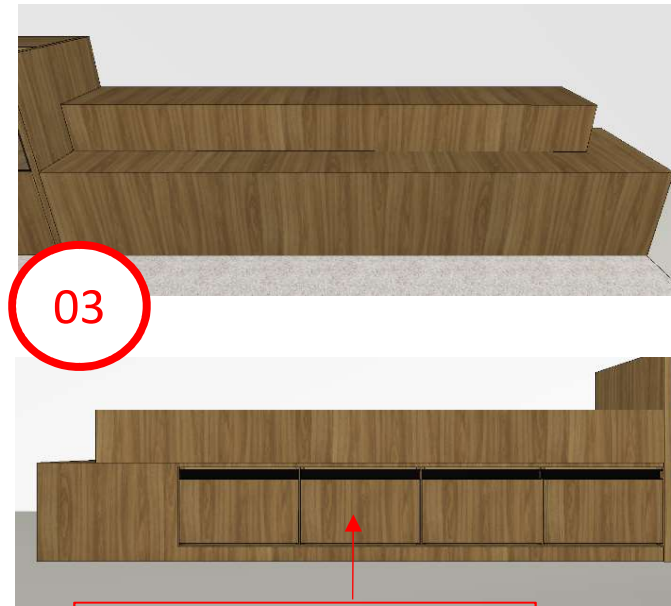
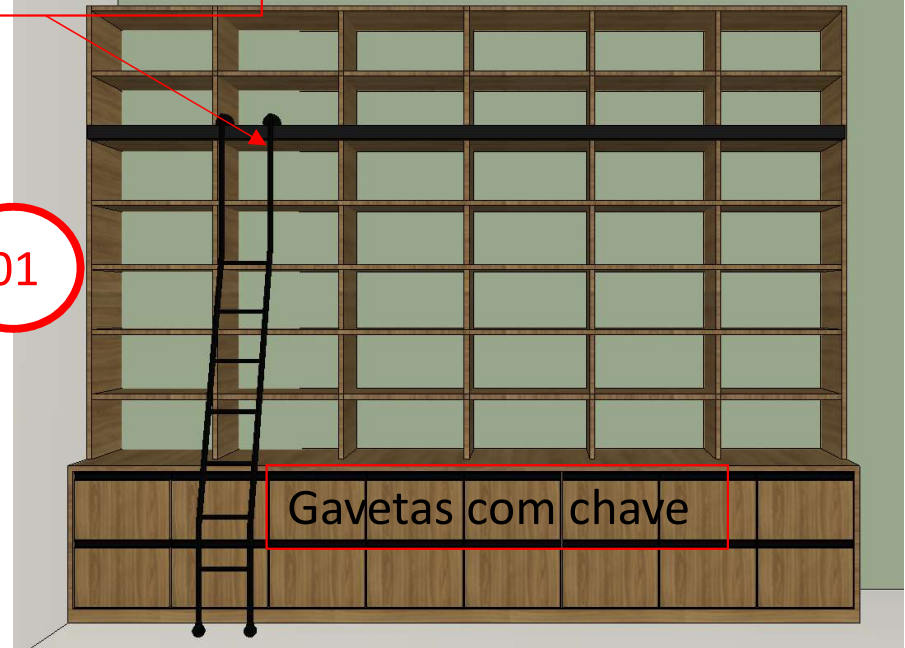

BOX 13

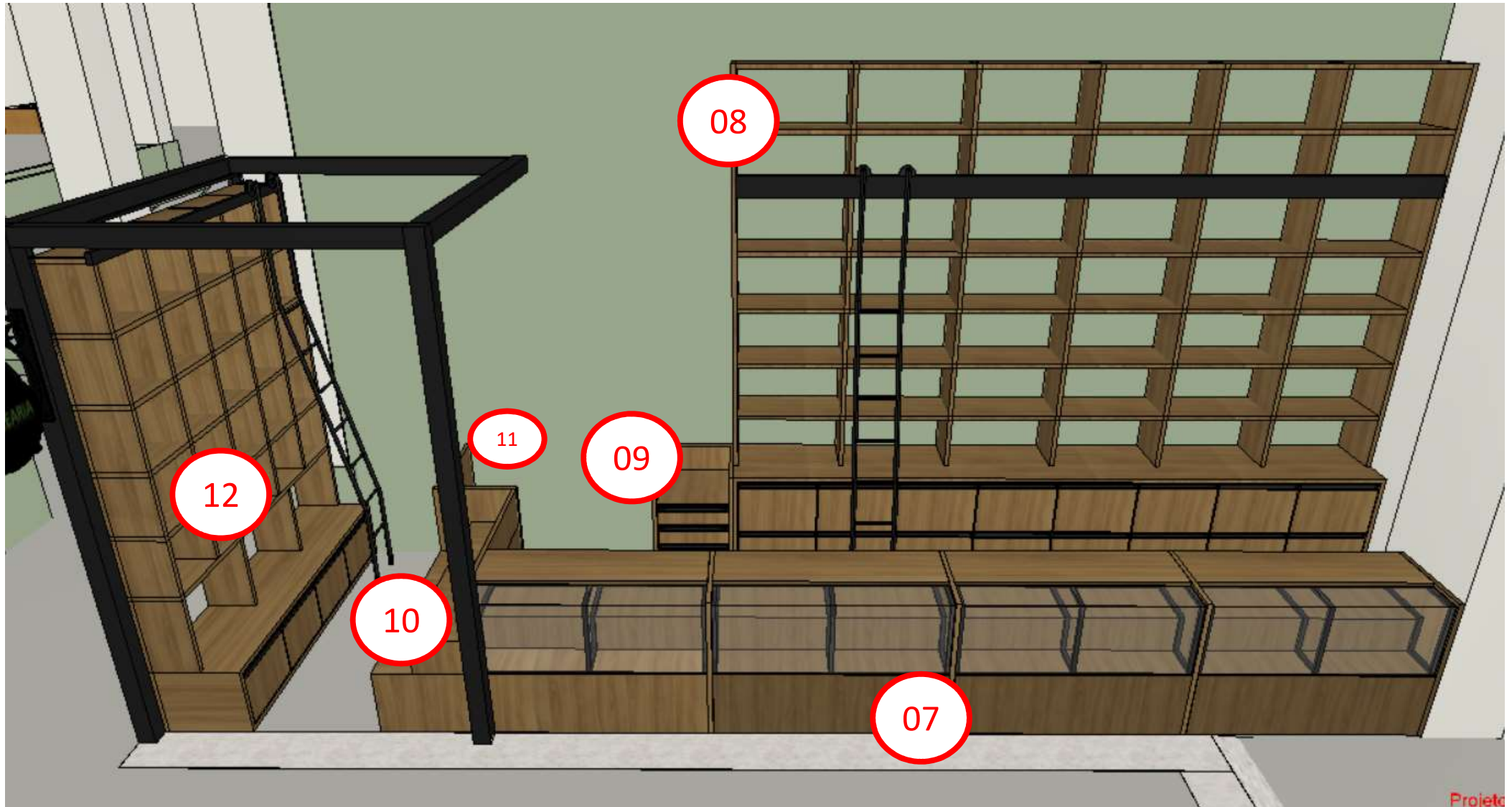

Projeto

NVE

NORTE VERDADEIRO ENGENHARIA

Juliana Silva
Arquitetura e Interiores

BOX 13

Trilho com escada

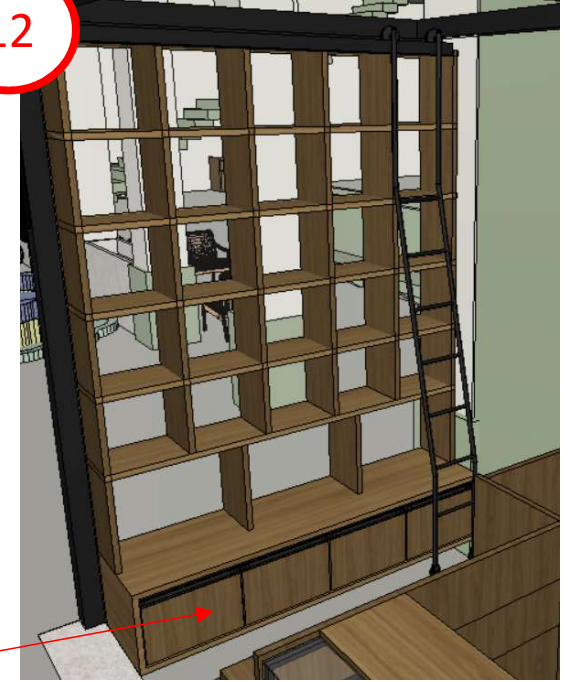
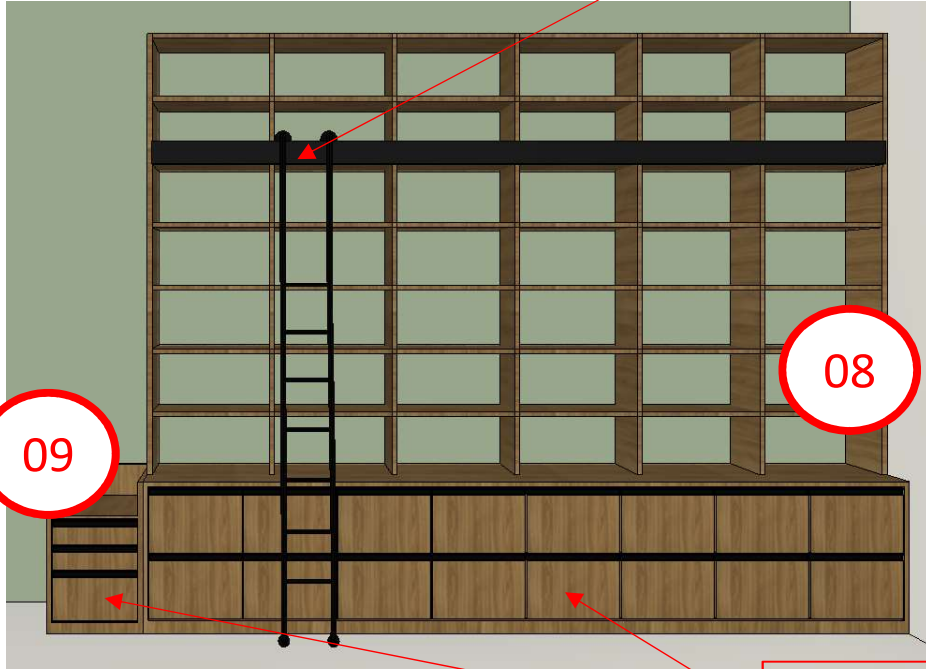

Gavetas com chave

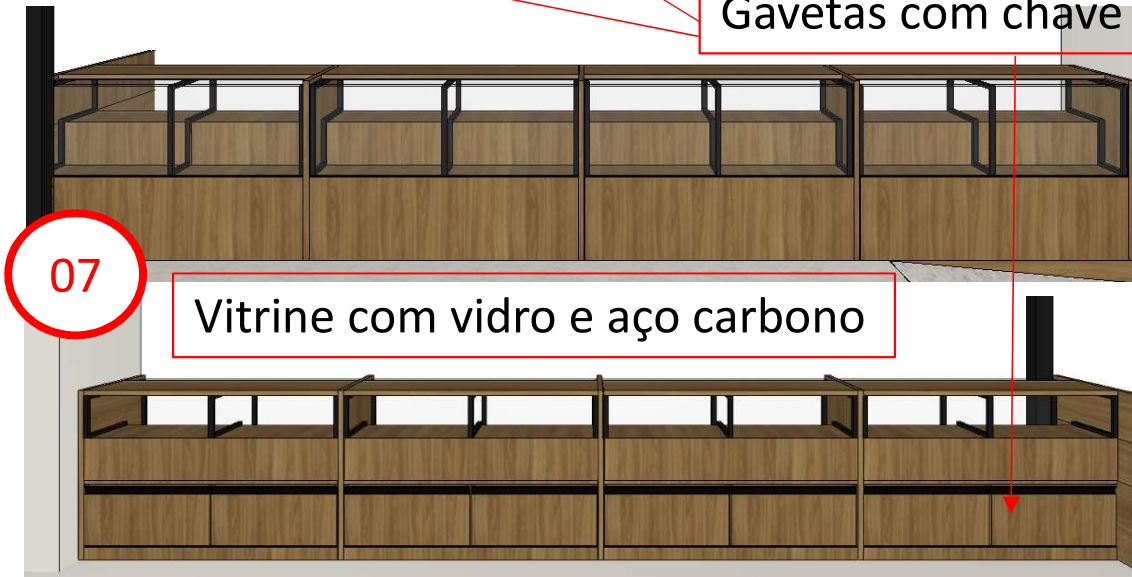

Vitrine com vidro e aço carbono

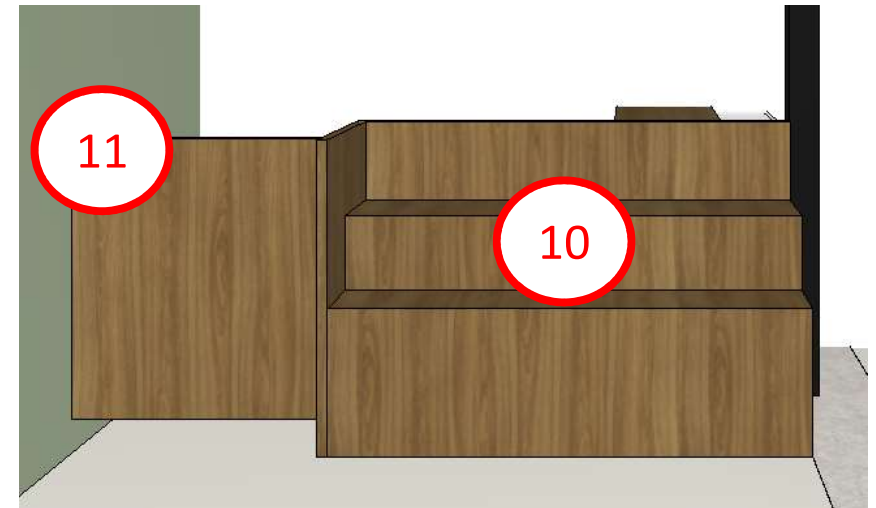

NVE

NORTE VERDADEIRO ENGENHARIA

Juliana Silva
Arquitetura e Interiores

06



Estrutura em aço carbono preto para sustentação do totem

14

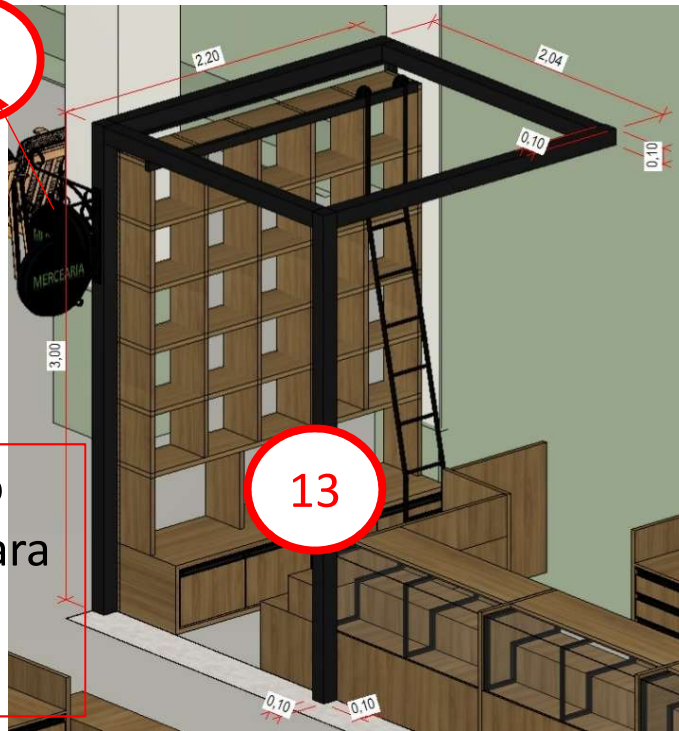

13

Estrutura em aço carbono.

13



14



14

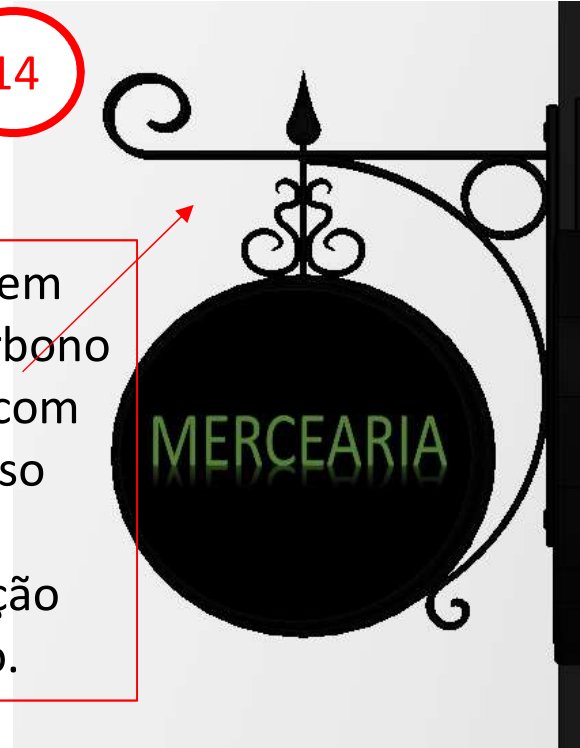

Totem em aço carbono preto, com luminoso para colocação de logo.

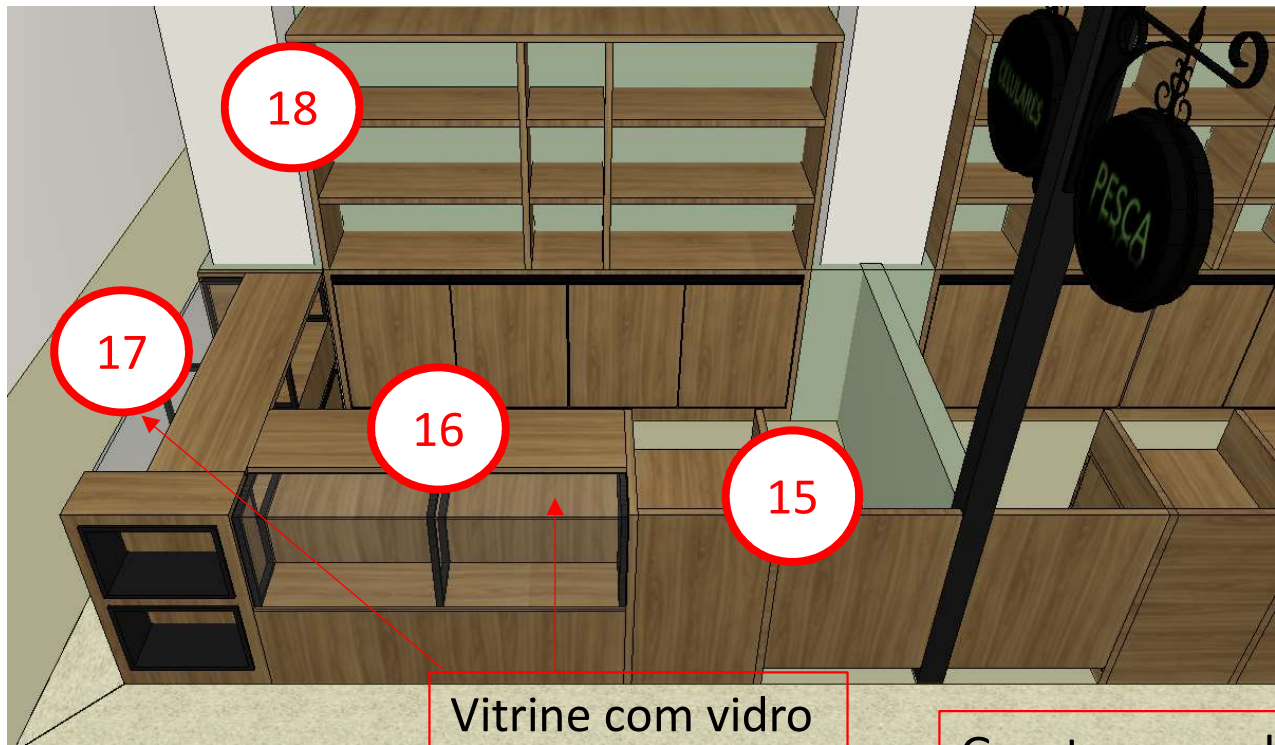

Vitrine com vidro e aço carbono

Gavetas com chave



17

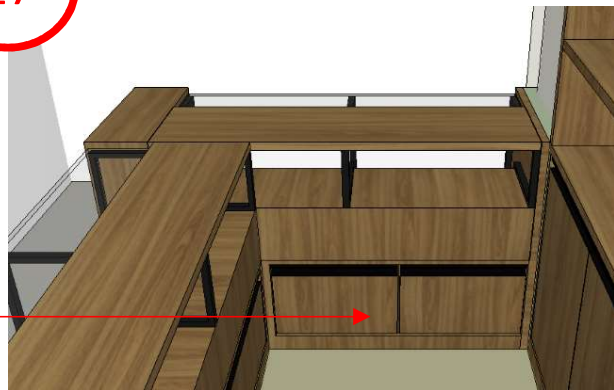

18



Portas com chave

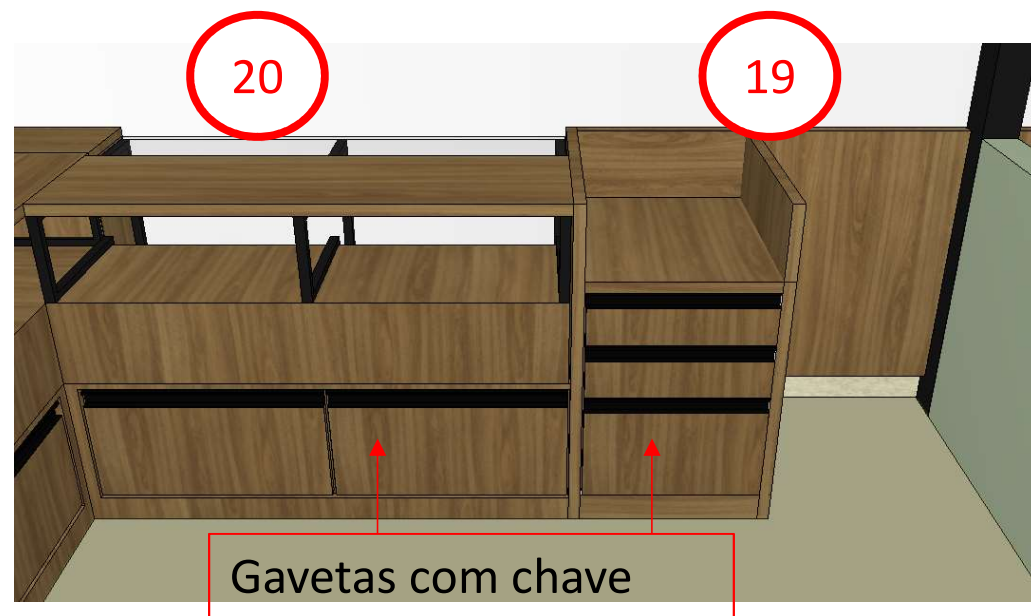
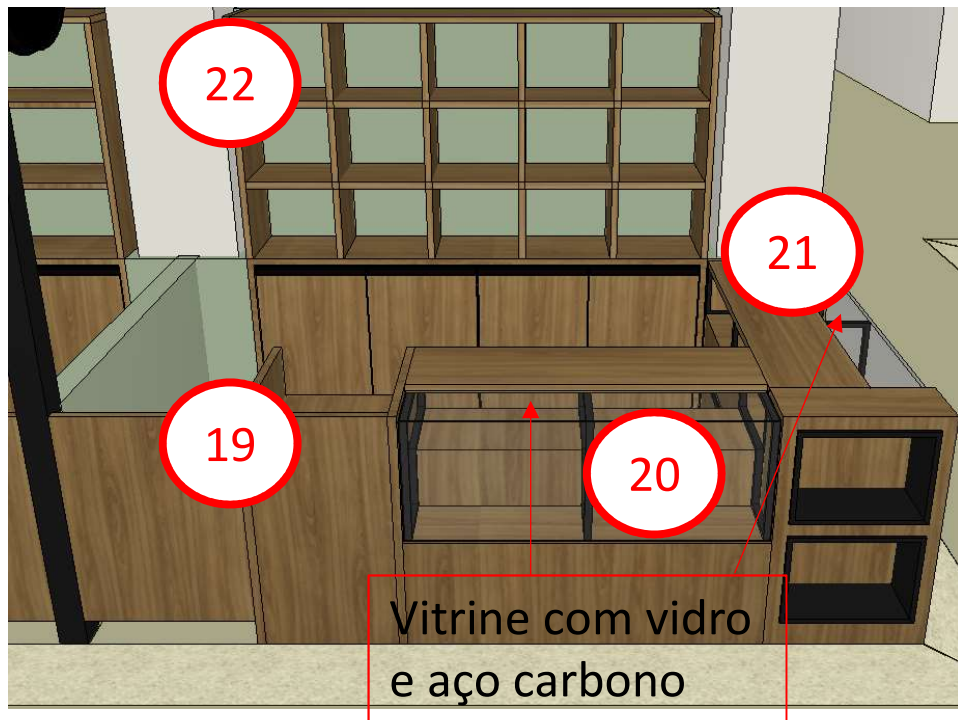

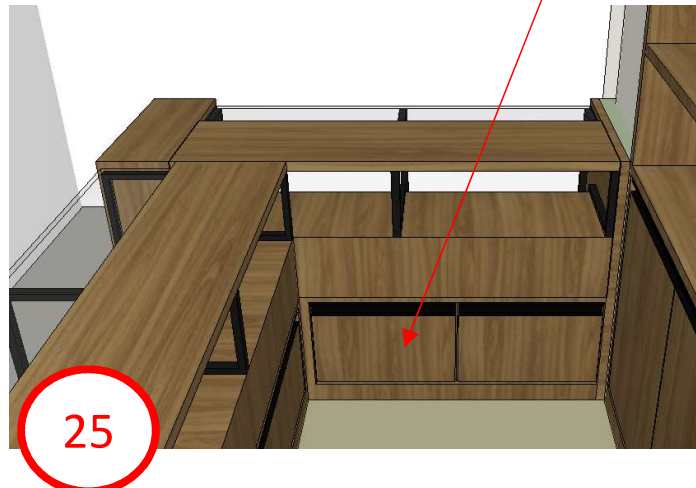
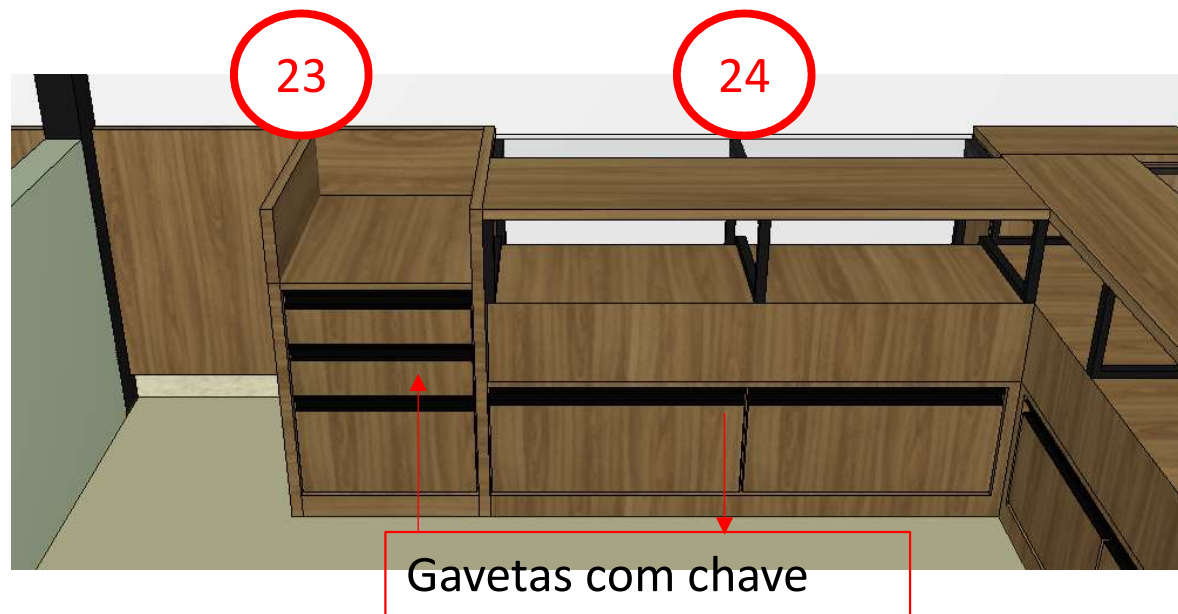
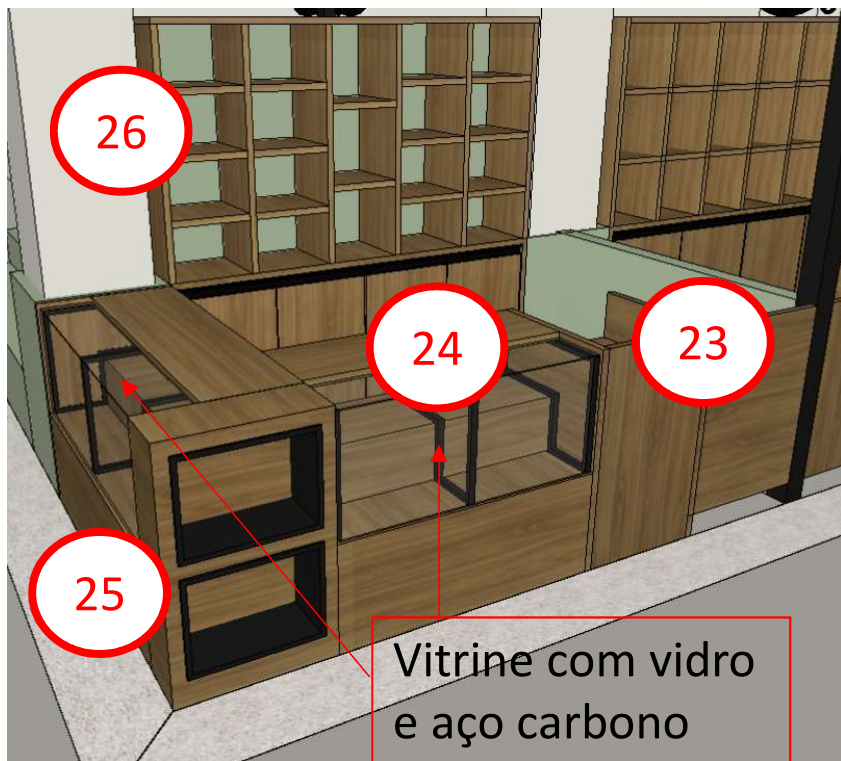

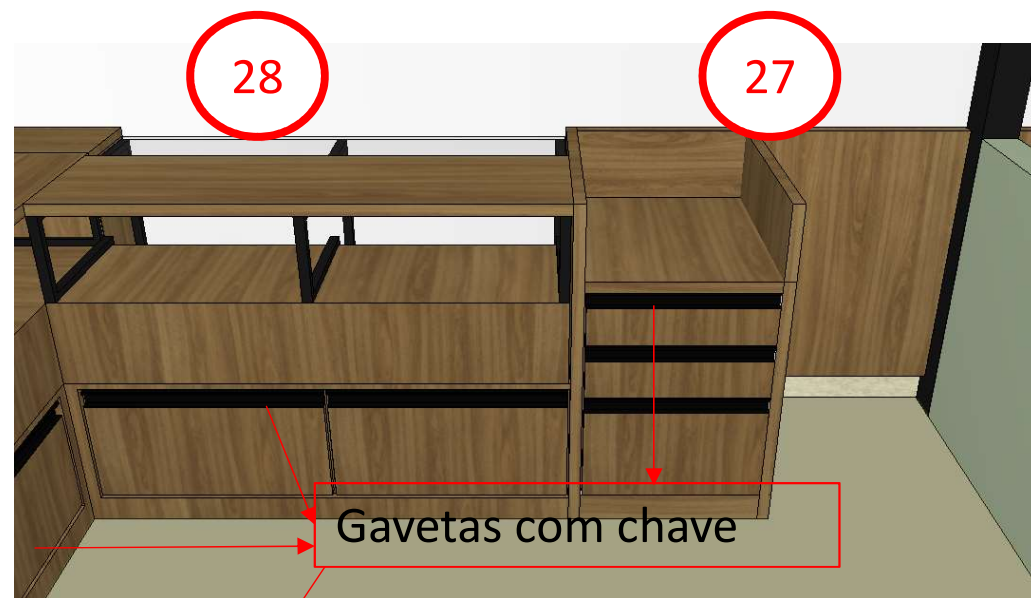
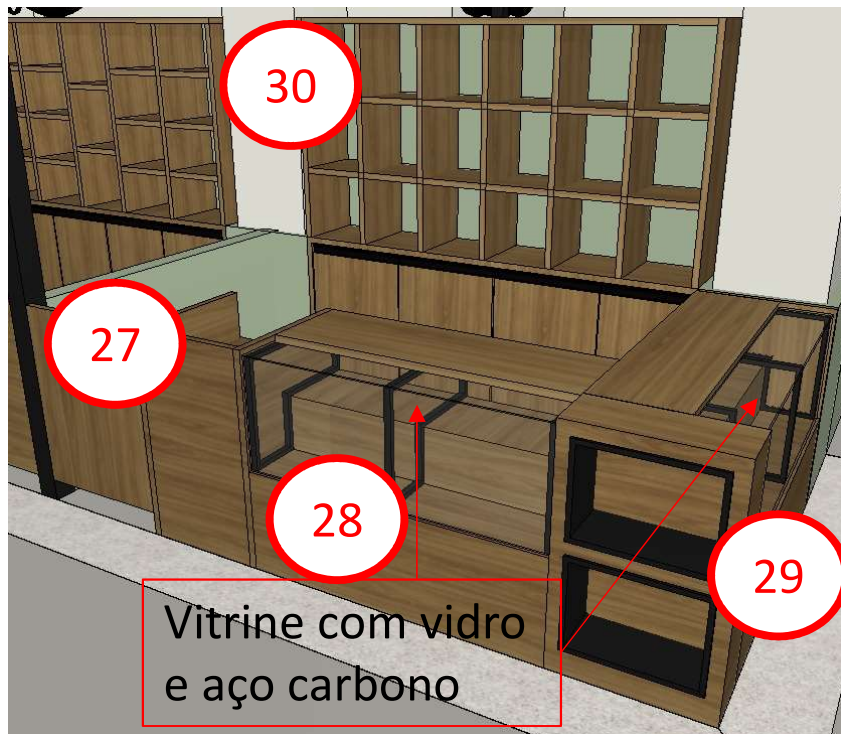

BOX 20

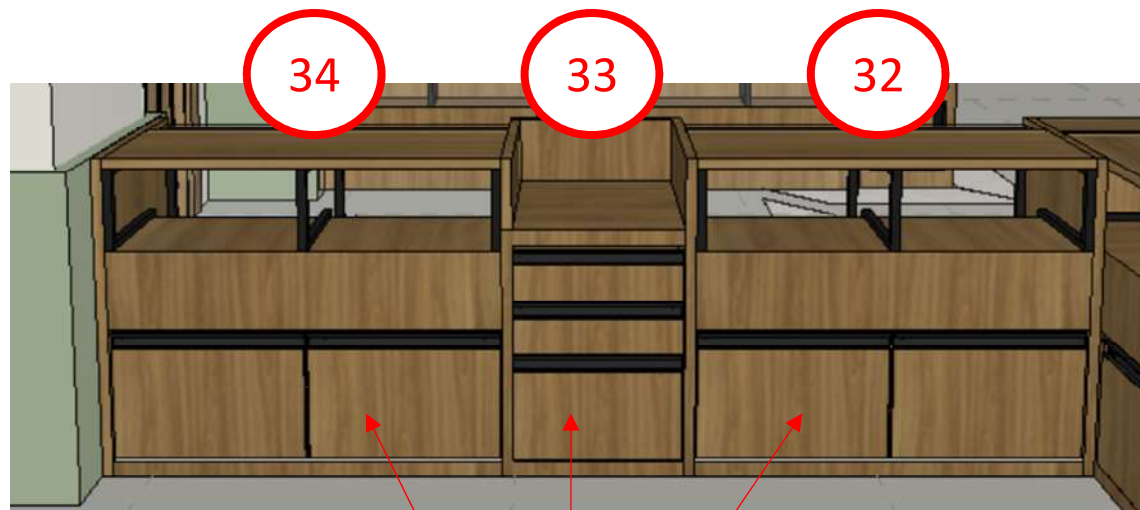
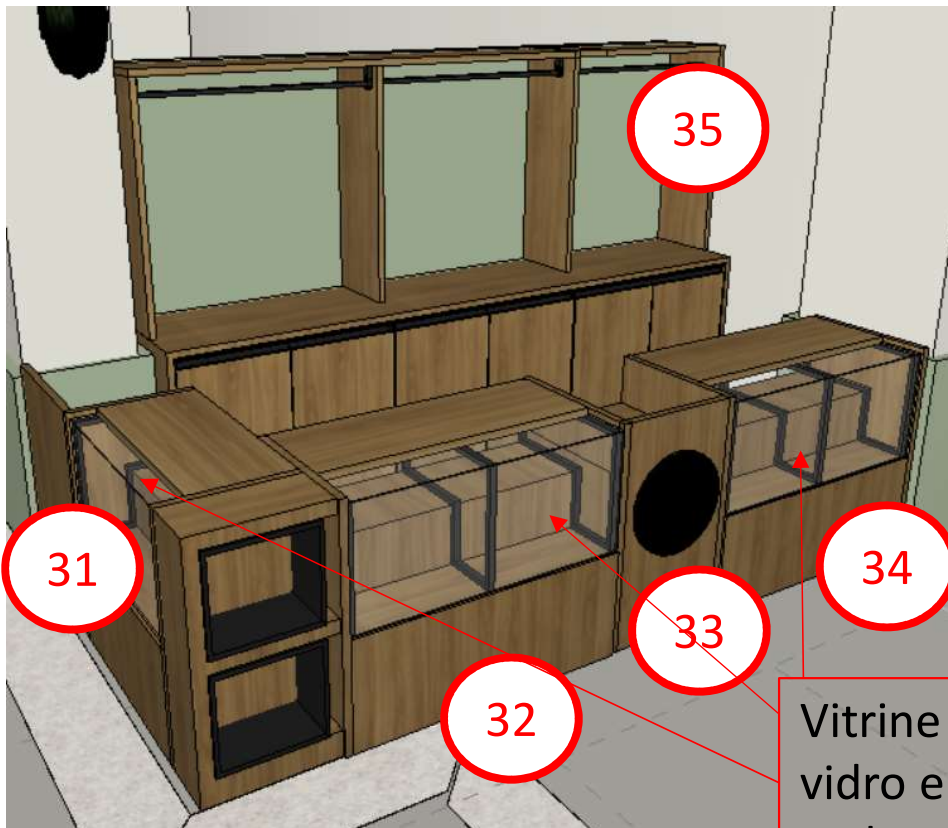

Gavetas com chave

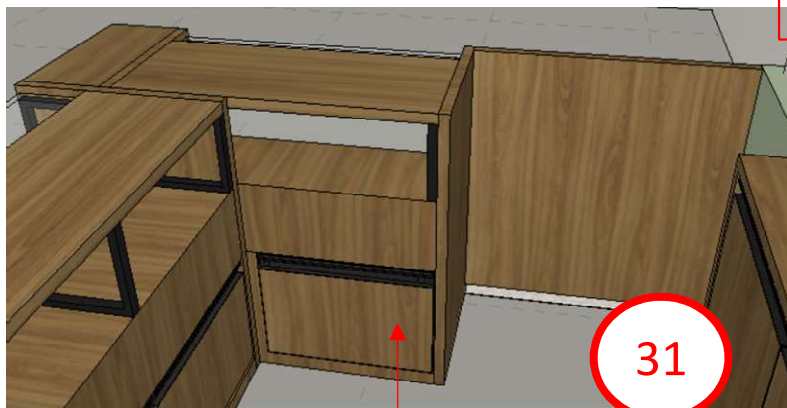

Gavetas com chave

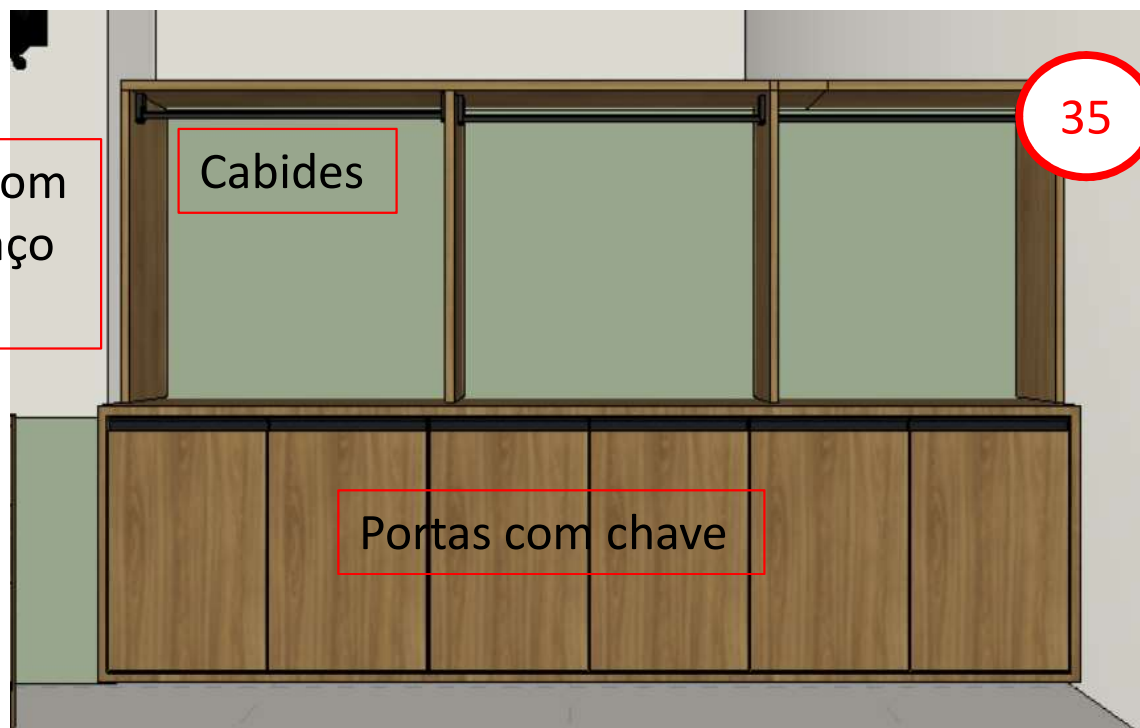

BOX 14

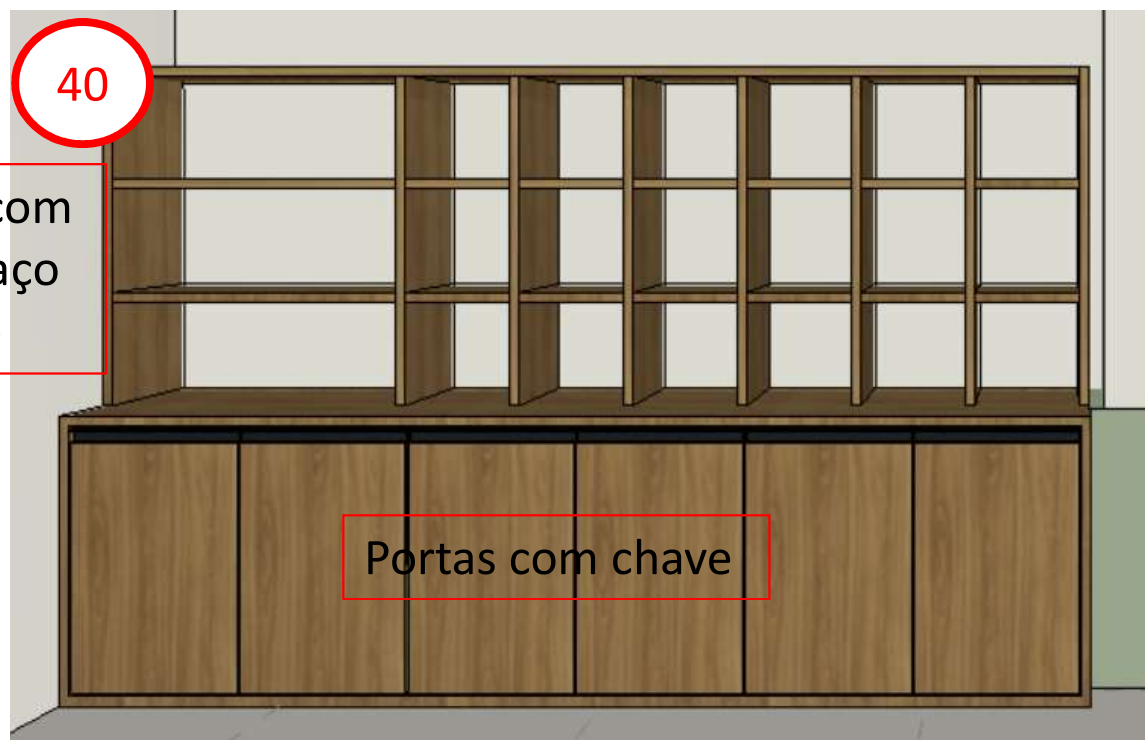
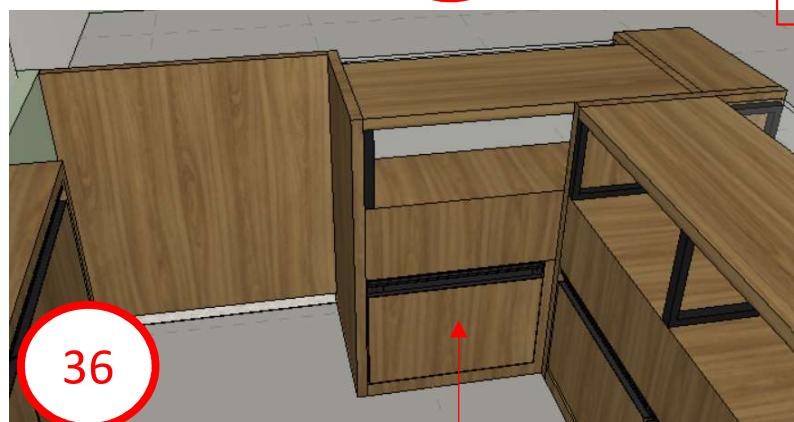
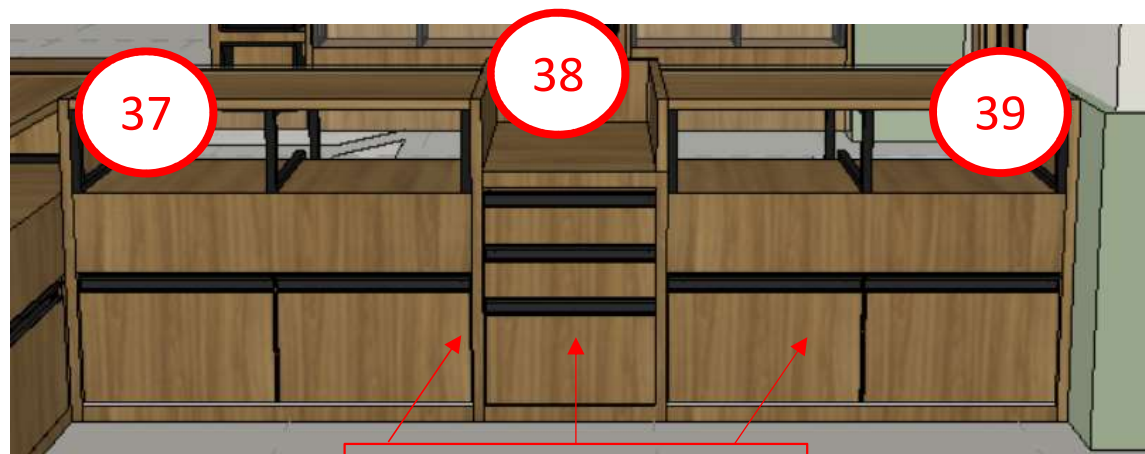
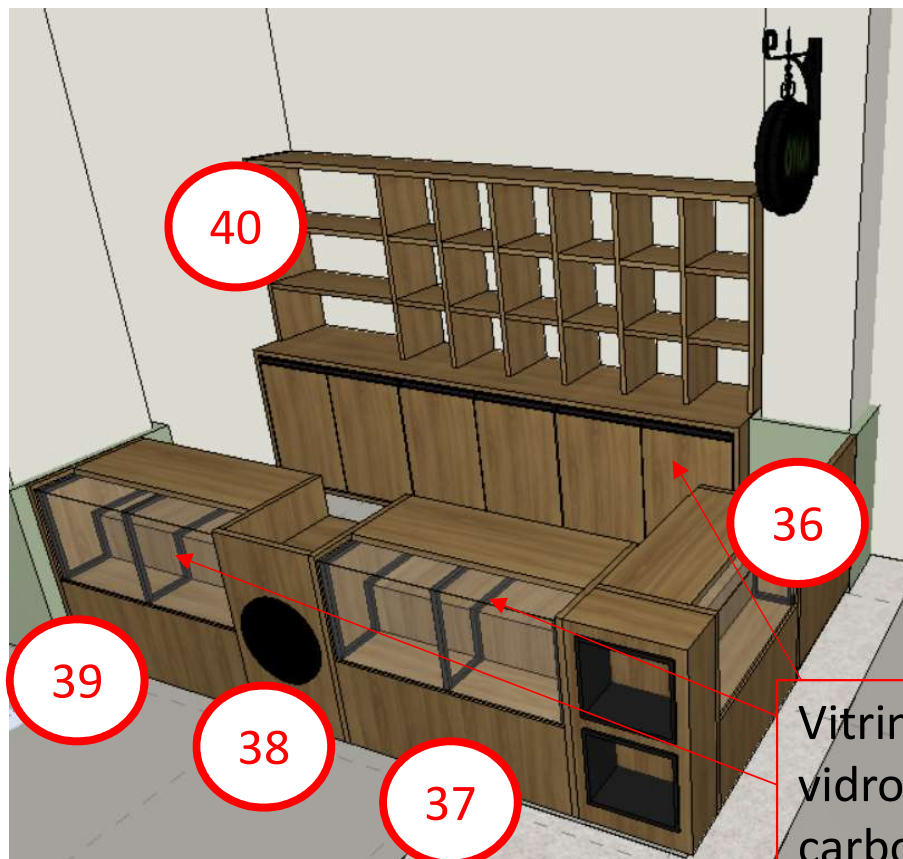

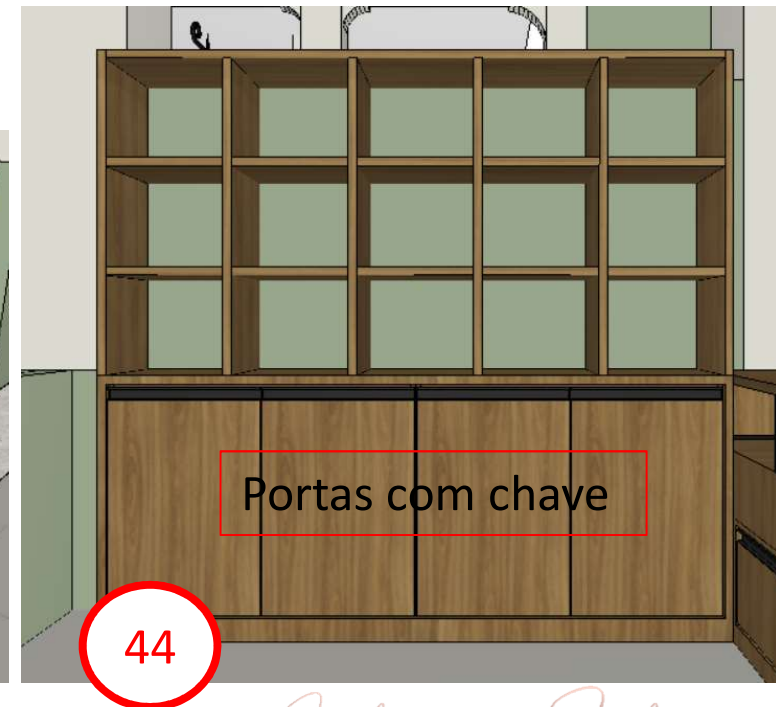
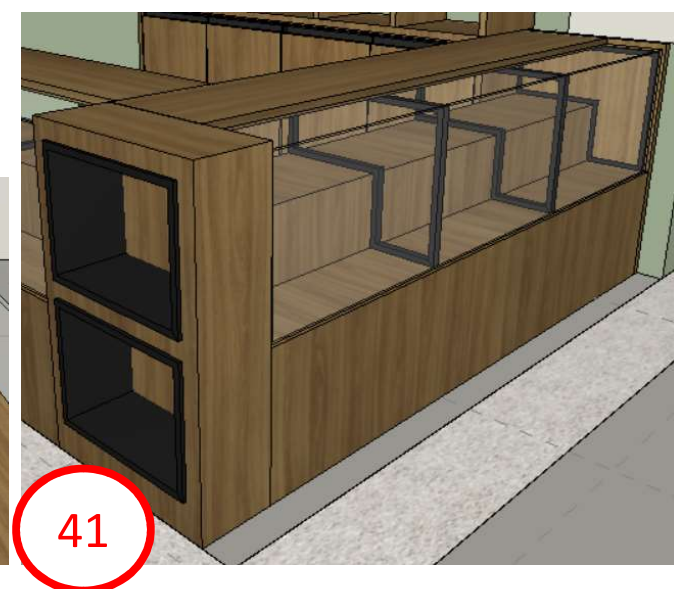
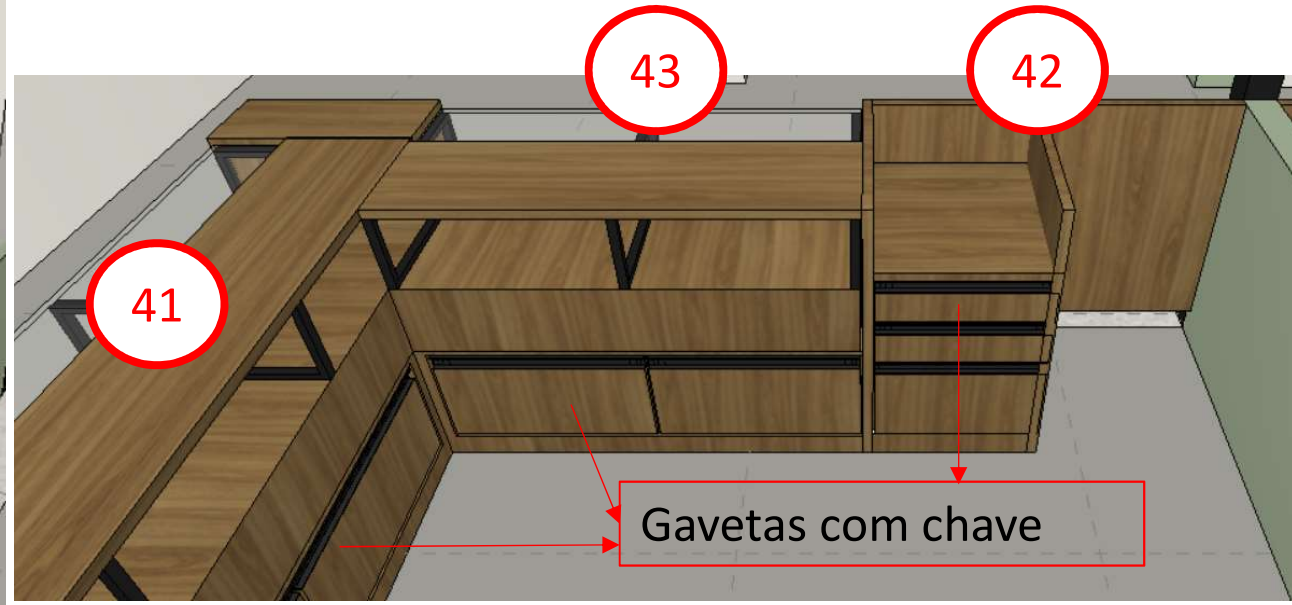
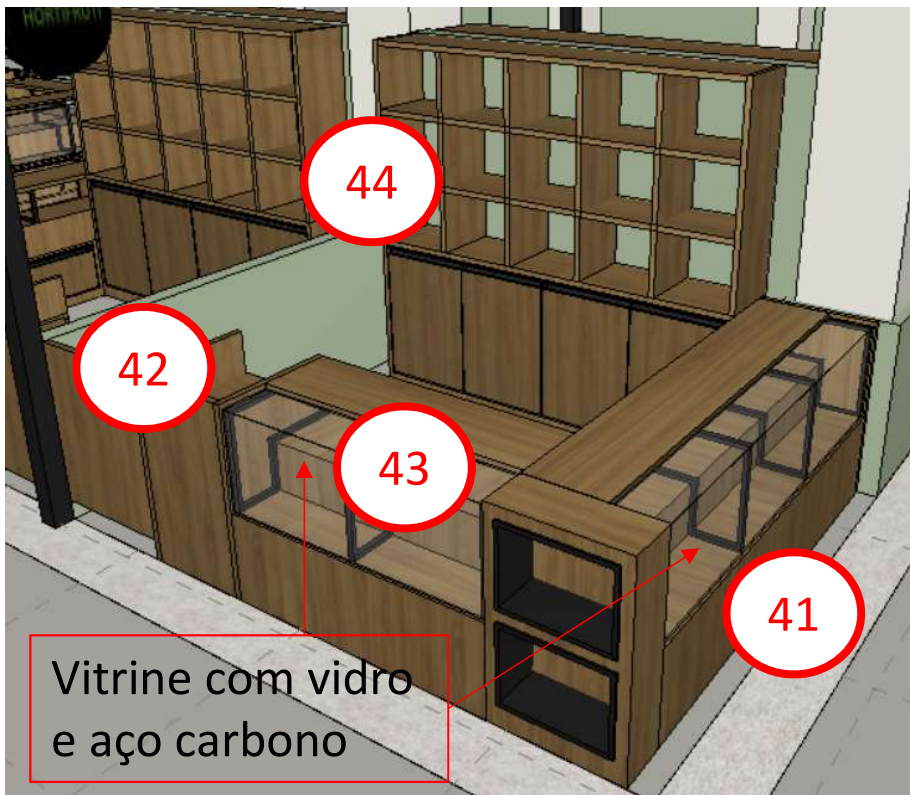

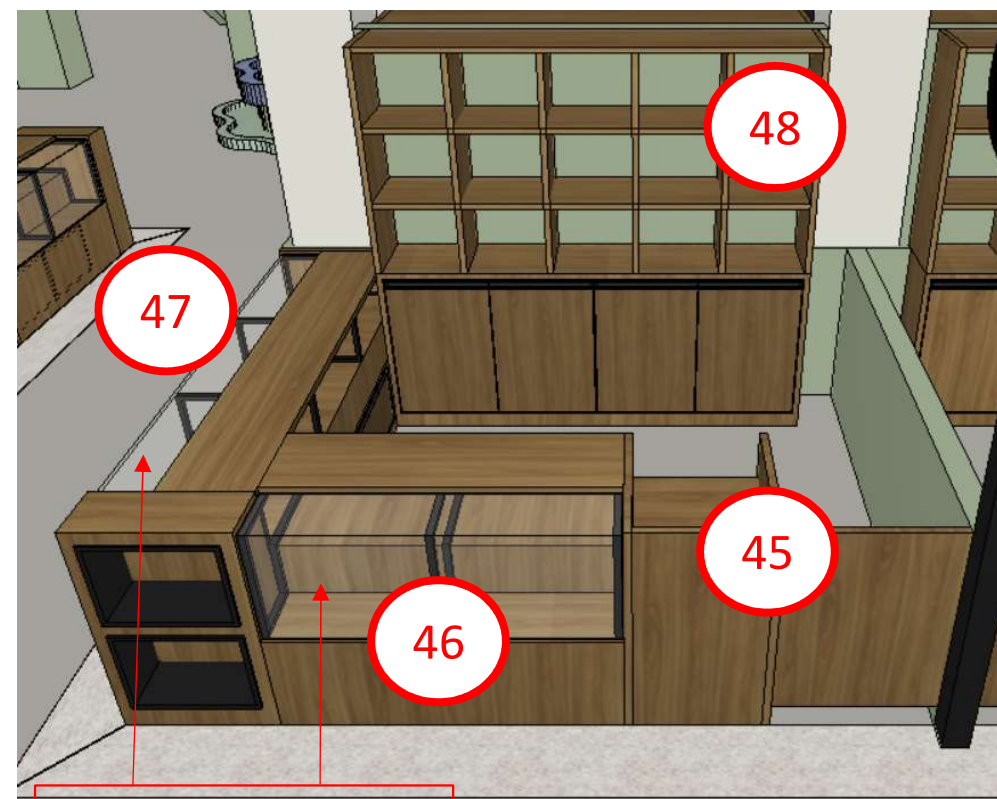

Vitrine com vidro e aço carbono

Gavetas com chave

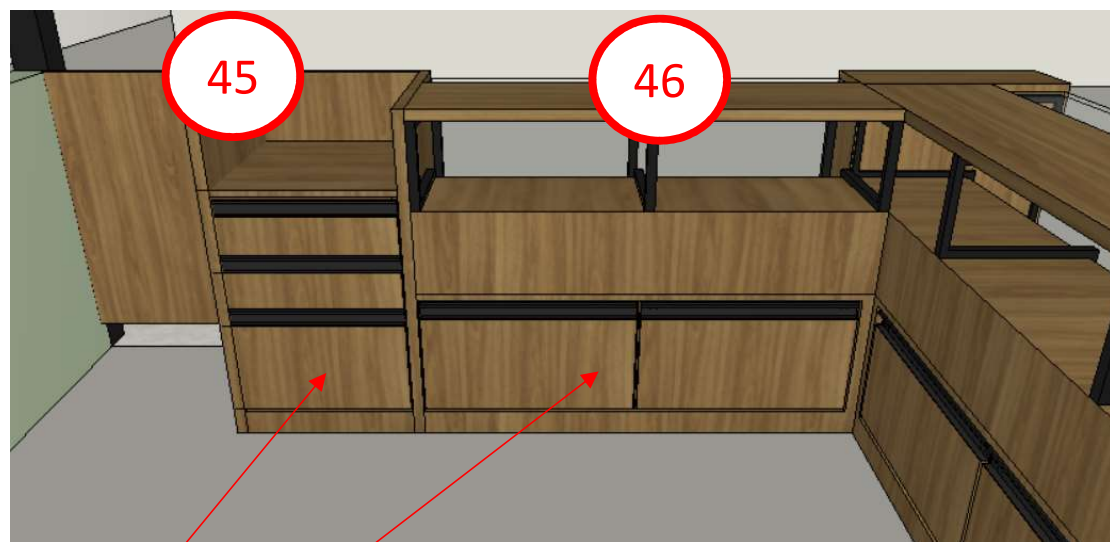

Portas com chave



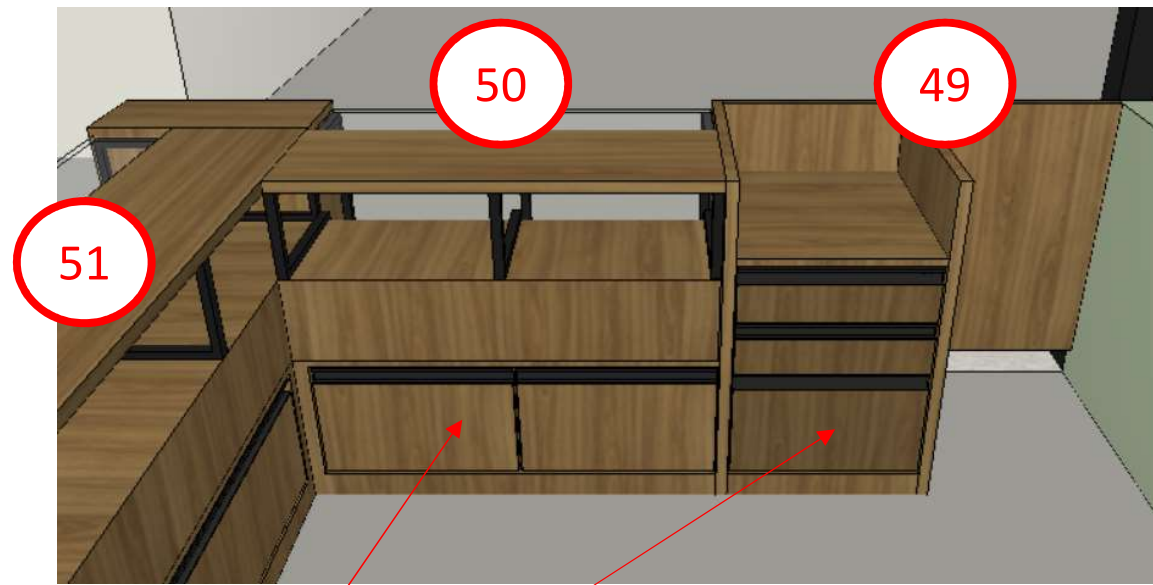
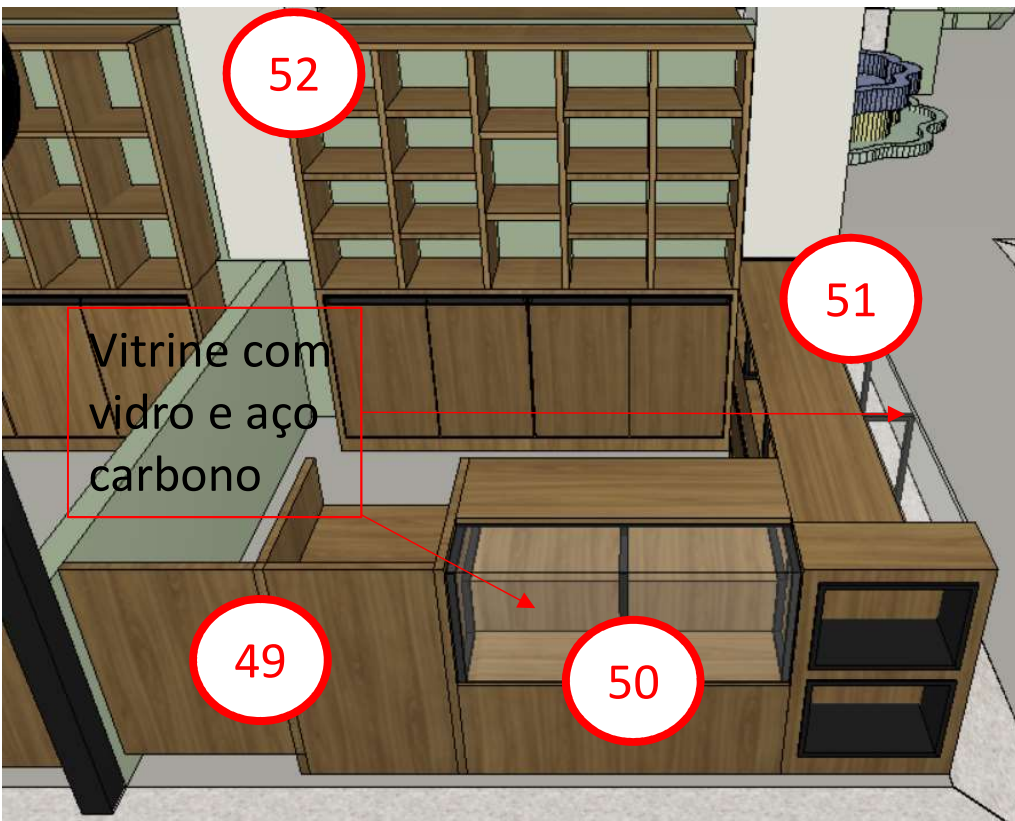

Gavetas com chave

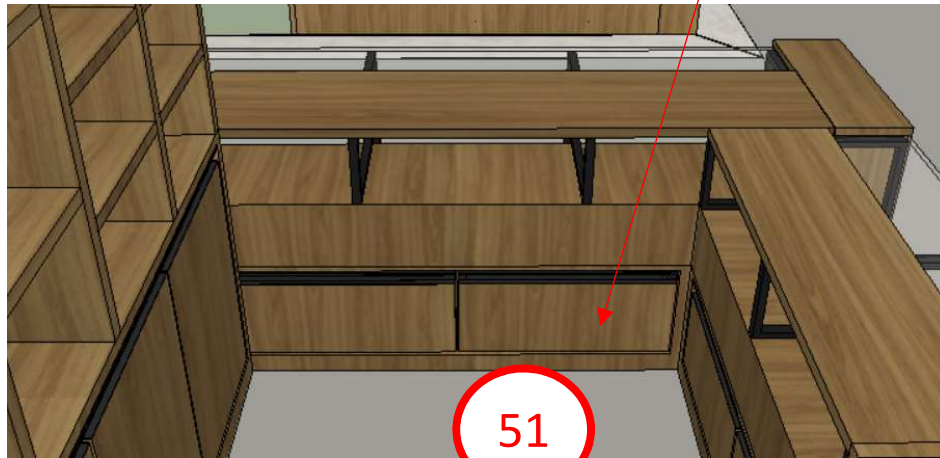

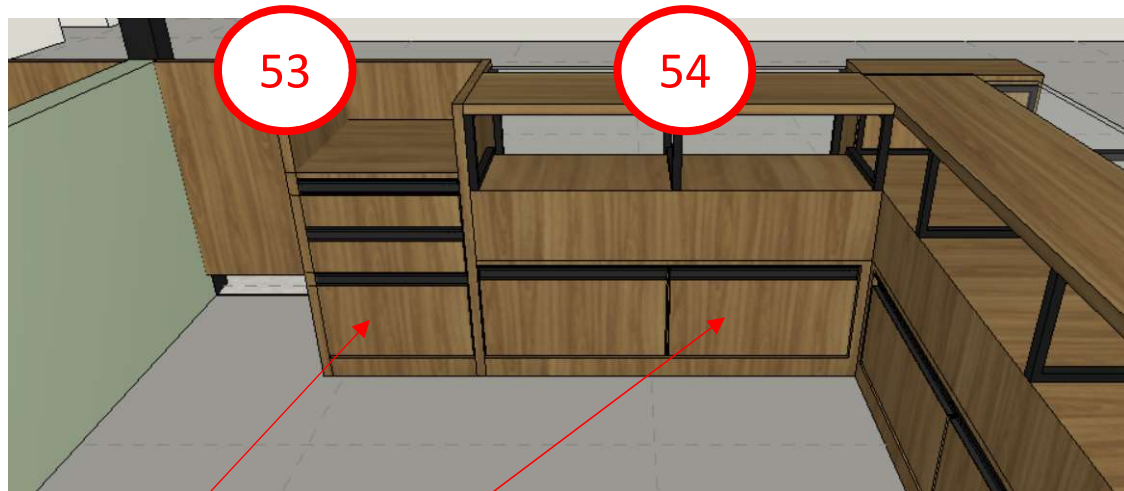
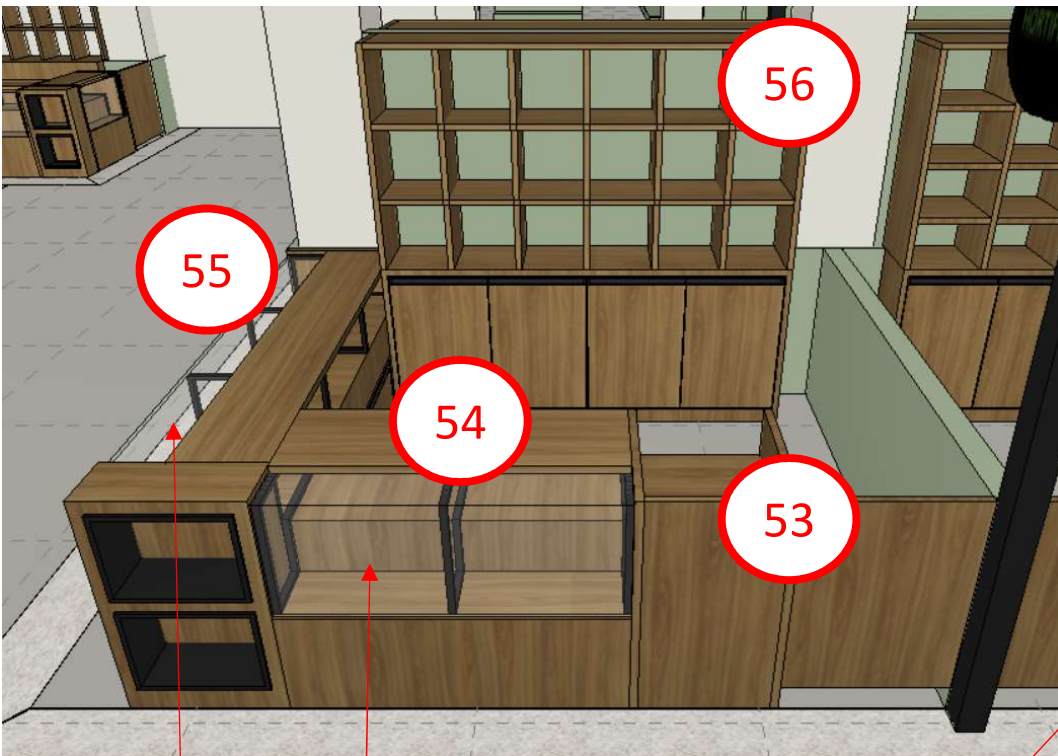

Vitrine com vidro e aço carbono

Gavetas com chave



Portas com chave



55



55

56

57



M3



Especificações

Diâmetro: 1,00m



57

QTD:

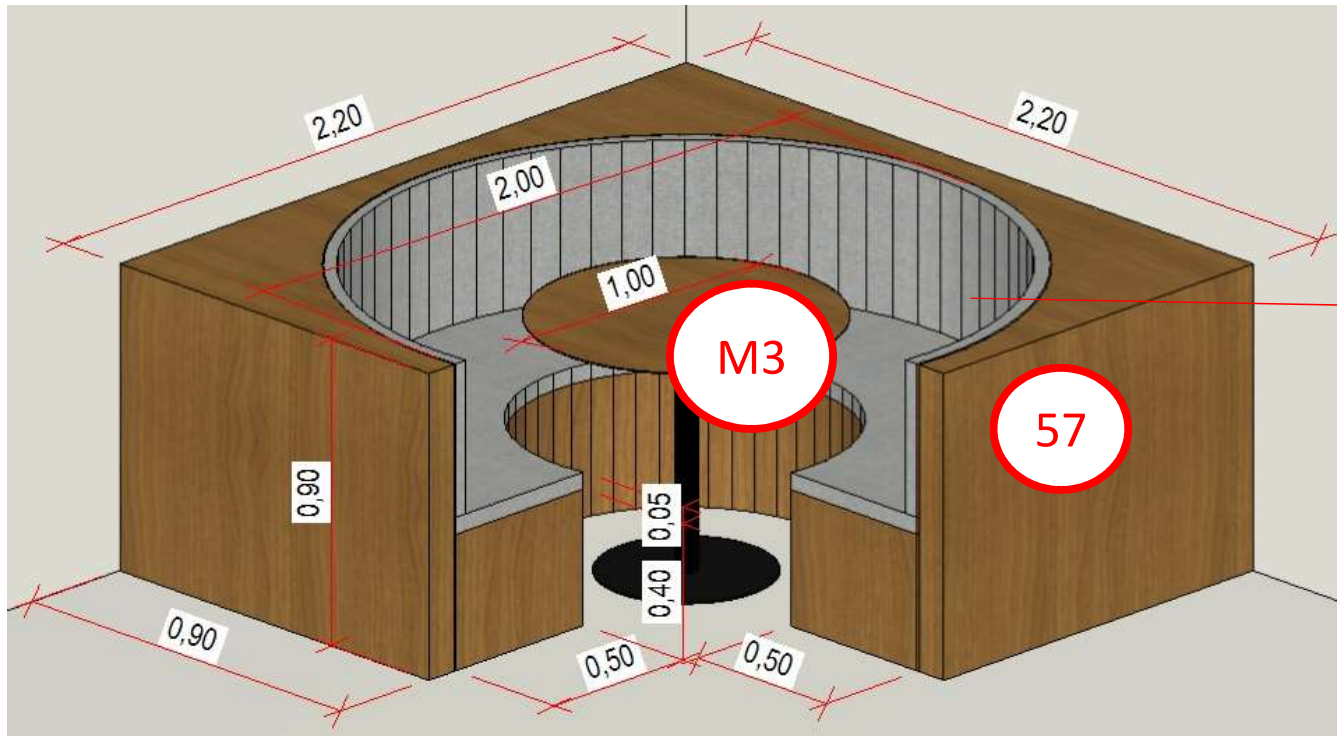

ESTOFAMENTO
COM TECIDO
IMPERMEÁVEL
CINZA

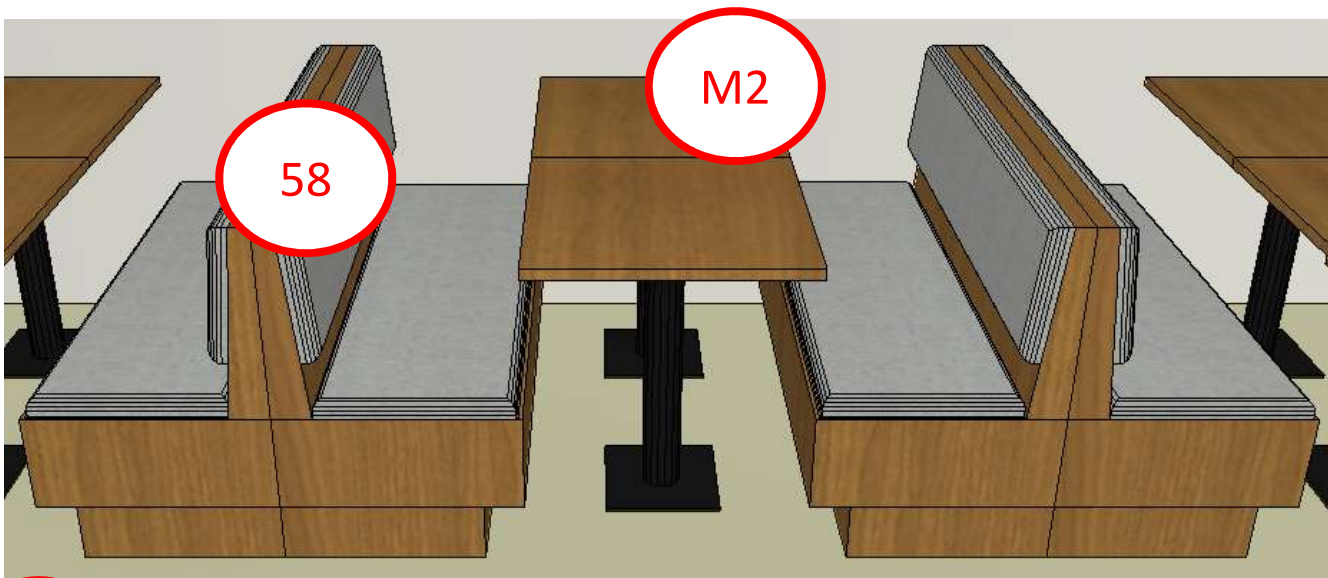

57 QTD:

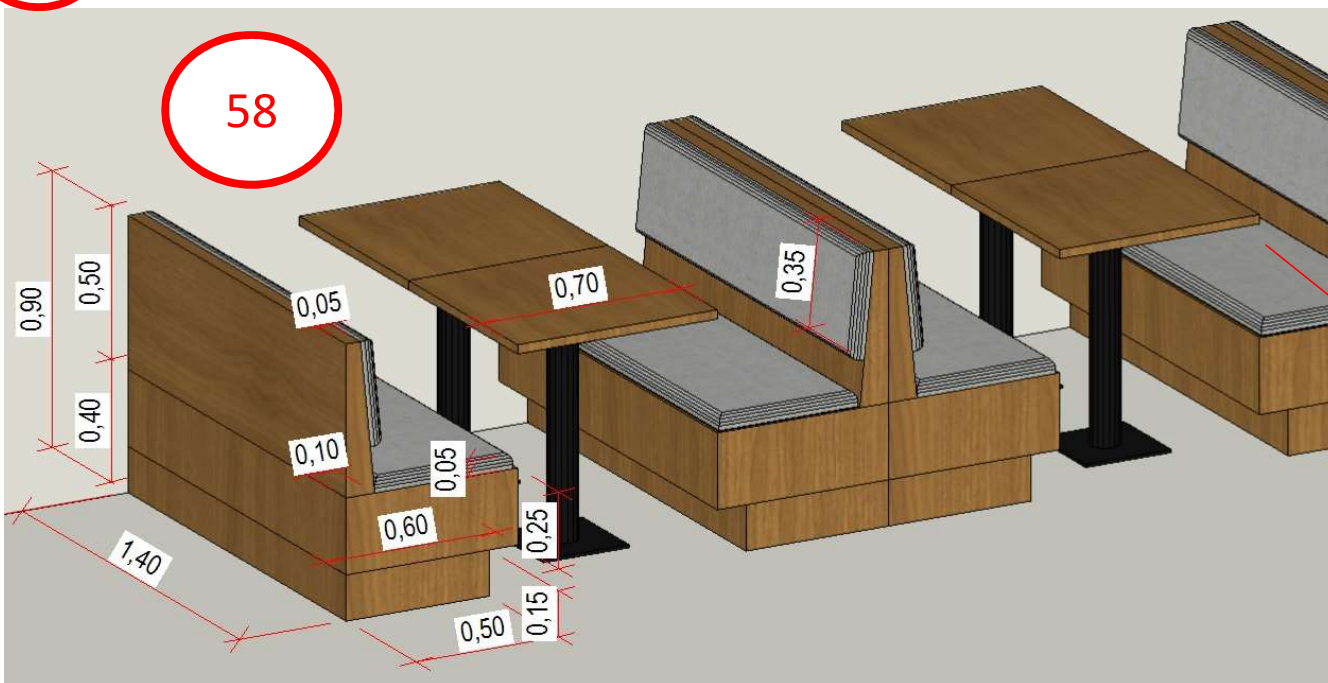

Especificações
1,40m



ESTOFAMENTO EM TECIDO
IMPERMEÁVEL

59 /
M2

M2



59

ESTOFAMENTO EM TECIDO
IMPERMEÁVEL



Especificações
1,40m

60



61

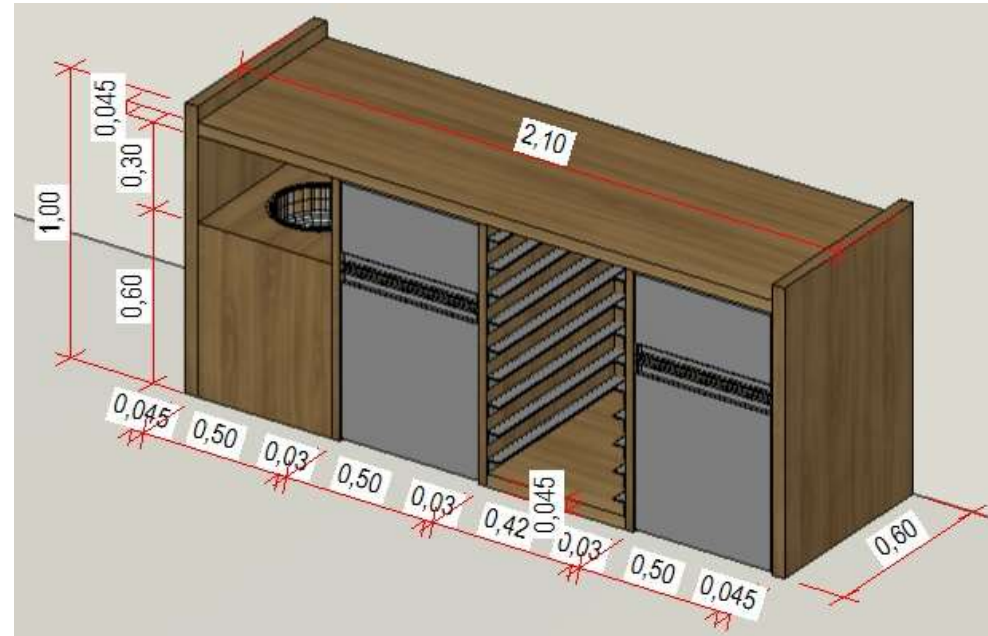
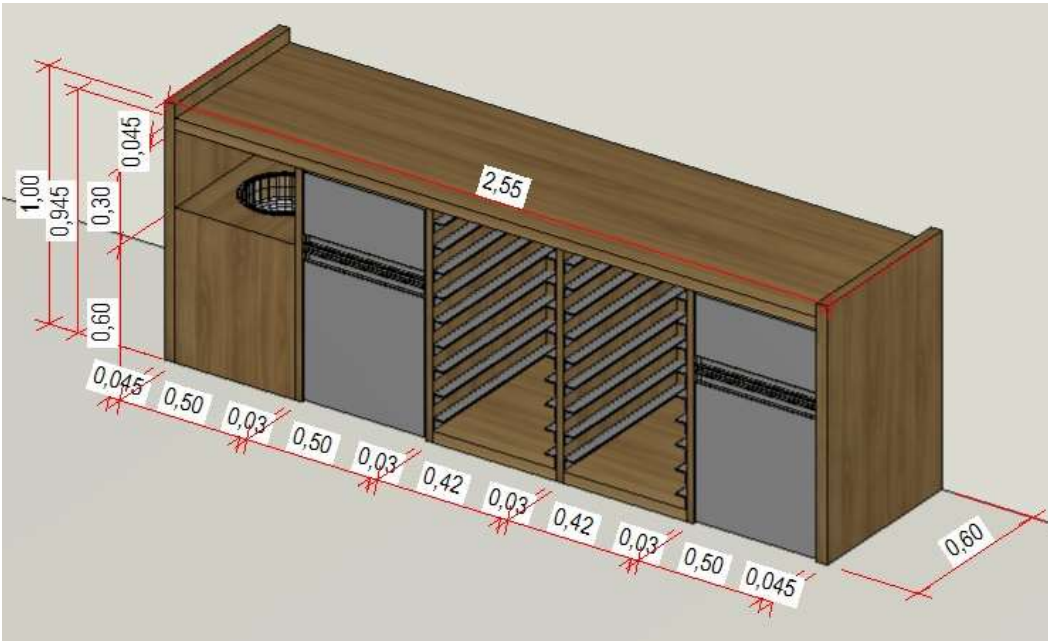

C1

QTD:



Dimensões

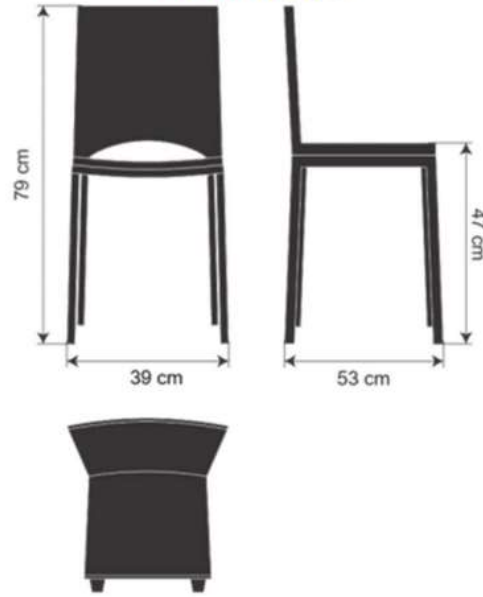

C2

QTD:



Especificações

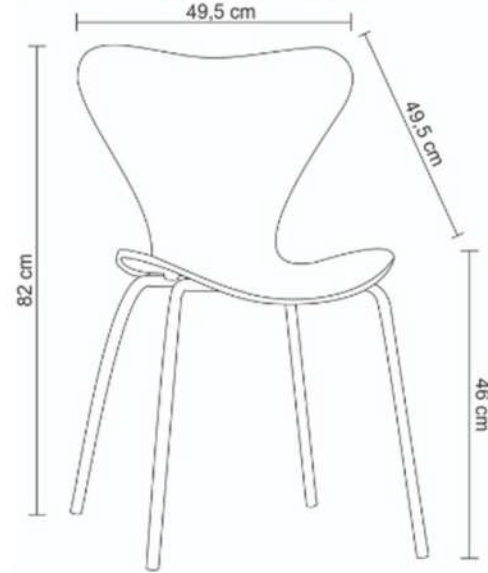

QTD:

C3



Dimensões

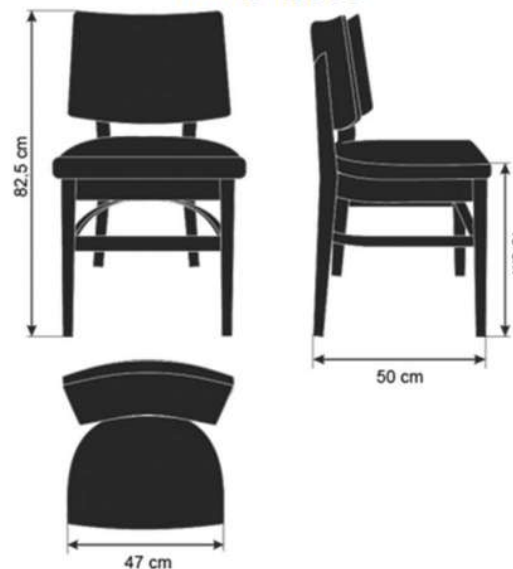

ESTOFAMENTO EM TECIDO
IMPERMEÁVEL

QTD:

C4



Dimensões

Assento: D40
Encosto: D28
Largura: 54cm
Profundidade: 69cm
Altura: 90cm
Medida do assento ao chão: 47cm

QTD:

B1



Especificações

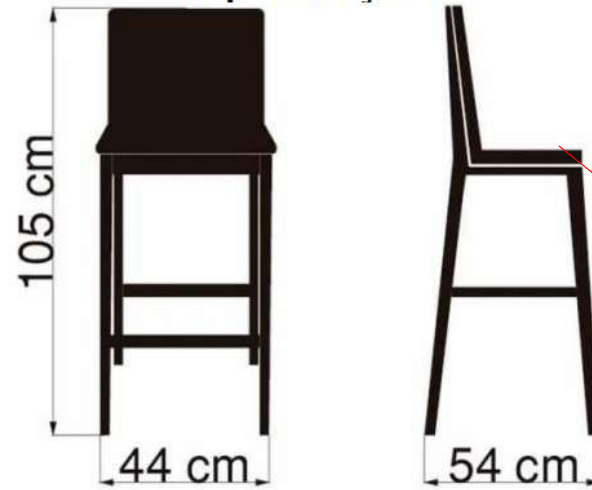

ESTOFAMENTO EM TECIDO IMPERMEÁVEL

QTD:

B2



Especificações

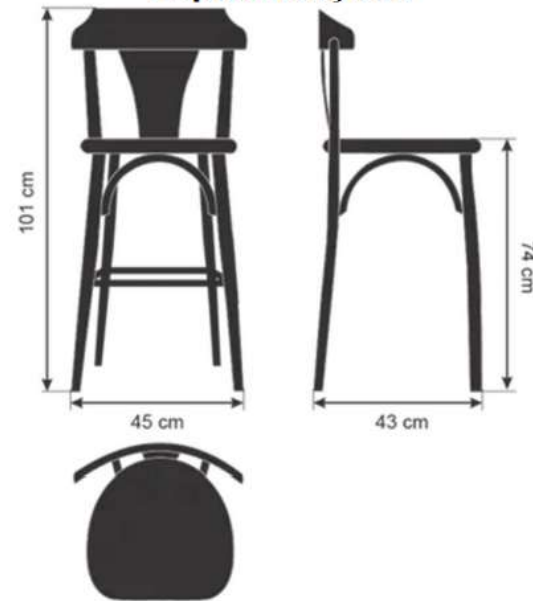

QTD:

B3

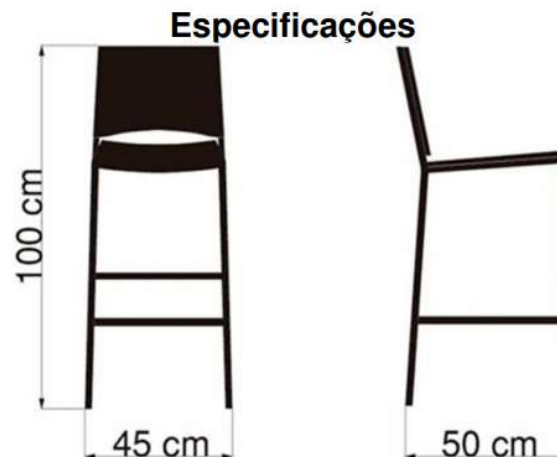

QTD:

B4



Especificações

Encosto: Tela Sextavada
Largura: 44cm
Profundidade: 57cm
Altura: 104cm
Medida do Assento ao Chão:
Alta 74,5cm

ESTOFAMENTO EM TECIDO
IMPERMEÁVEL

P1

QTD:



Especificações

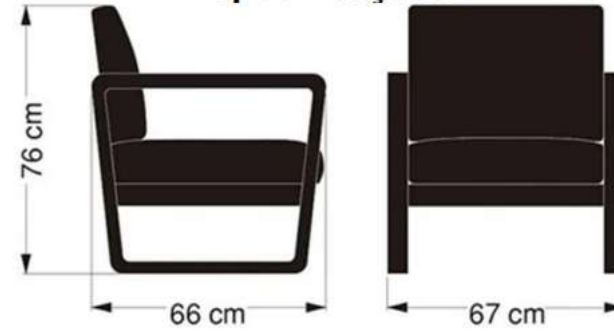

ESTOFAMENTO EM TECIDO
IMPERMEÁVEL

P2

QTD:



Especificações

Assento: D30
Encosto: D23
Largura: 75cm
Profundidade: 81cm
Altura: 82cm
Medida do assento ao chão: 48cm

P3

QTD:



Especificações

Assento: D30 com Molas

Encosto: D23

Largura: 66cm

Profundidade: 74cm

Altura: 80cm

Medida do assento ao chão: 45,5cm

ESTOFAMENTO EM TECIDO
IMPERMEÁVEL



M1

QTD:

Especificações



M2

QTD:

Especificações



M3

QTD:

Especificações

Diâmetro: 70cm



AP

QTD:



Especificações

Largura:1,60
Profundidade: 0,45m
Altura 0,95m

MC

QTD:



Especificações

Largura: 1,20m
Profundidade: 0,60m
Altura:0,32m

Memorial descritivo dos móveis planejados

Móveis em MDF Louro freijó linha Trend – ARAUCO

Puxadores em perfil de alumínio cava cor preta

Dobradiças com amortecimento

Corrediças telescópicas

Fechadura em todas as portas e gavetas

Estruturas dos totens em aço carbono preto.

Totens com luminoso na parte do logo.

Os estofados para os bancos, confeccionar em tecido impermeável, nas cores a serem aprovadas pela arquiteta.

Qualquer alteração de modelos, acabamentos e escolha de tecidos, fica à aprovação da Arquiteta responsável pelo projeto.

Os modelos de móveis para os Box, podem sofrer alteração de acordo com o seguimento que será utilizado, sendo assim, não será permitido modificar metragem quadrada, apenas distribuição e modelo, o qual, deverá passar para a arquiteta responsável pelo projeto, para que a mesma faça as alterações necessárias.

Juliana Aparecida da Silva
Arquiteta e Urbanista – CAU A218823-6

NORTE VERDADEIRO ENGENHARIA - PROJETOS, SERVIÇOS TOPOGRÁFICOS E CONSTRUÇÕES LTDA

Rua Xingú, nº637 – I.A.P.I. – Osasco/SP – Cep 06236-050

Telefone (11) 3656 1480 / Cel. (11) 98301 2100 / (12) 982586924 / E-mail: andersonpsilva@terra.com.br / julianaarq.nve@terra.com.br



NVE

NORTE VERDADEIRO ENGENHARIA

Juliana Silva
Arquitetura e Interiores

NORTE VERDADEIRO ENGENHARIA – PROJETOS, SERVIÇOS TOPOGRÁFICOS E CONSTRUÇÕES LTDA

Rua Rio Xingú, nº637 - I.A.P.I. - Osasco/SP - Cep 06236-050

Telefone (11) 3656 1480 / Cel. (11) 98301 2100 / e-mail: andersonpsilva@terra.com.br

(12) 98258-6924 / e-mail: julianaarq.nve@terra.com.br