



mirage

Think smart. Think cool. Think Mirage.

hvacmirage.us

Job name: _____

Location: _____

Engineer: _____

Submitted to: _____

Submitted by: _____

Reference: _____

Approval: _____

Date: _____

Construction: _____

Unit #: _____

Drawing #: _____

Submittal Page
 Model: Ventus 19 18k-220V
 IVXH181B - OVXH181B

Rated Voltage		V,Hz,Ph	208/230V, 60Hz, 1 Ph
Cooling	Capacity	Btu/h	18000
	Input	W	1645
	Rated current	A	7.35
	SEER	Btu/w	19
Heating	Capacity	Btu/h	18000
	Input	W	1700
	Rated current	A	7.4
	HSPF4	Btu/w	10
	HSPF5	Btu/w	8
Compressor	Type		ROTARY
	Brand		GMCC
Fan motor	Indoor Speed (H/M/L)	r/min	1100/800/750
	Outdoor Speed	r/min	850/--/650
Air flow	Indoor (H/M/L)	CFM	405/262.59/222.71
	Outdoor	CFM	1176.47
Noise level	Indoor (H/M/L)	dB(A)	43/35/30.5
	Outdoor	dB(A)	57.5
Dimensions	Indoor Dimension (W*D*H)	inch	37.99x8.46x12.56
	Indoor Packing (W*D*H)	inch	41.14x12x16.14
	Outdoor Dimension (W*D*H)	inch	31.50x13.11x21.81
	Outdoor Packing (W*D*H)	inch	36.22x15.35x24.21
Net/Gross weight	Indoor Outdoor	lbs.	23.98/32.12 78.8/85.76
Design Pressure		PSIG	550/220
Refrigerant Piping	Liquid Side / Gas Side	inch	1/4" 1/2"
Refrigerant Type / Charge		oz	R410A/44.1
Additional charge for each ft.		oz	--
Operation temperature	Indoor (cooling/heating)	°F	62~89/32~86
	Outdoor (cooling/heating)	°F	5~109/13~86



mirage

Think smart. Think cool. Think Mirage.

Submittal Page

Model: Ventus 19 18k-220V
IVXH181B - OVXH181B

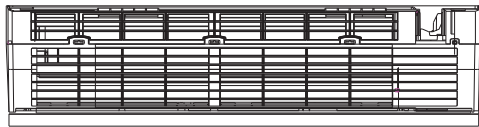
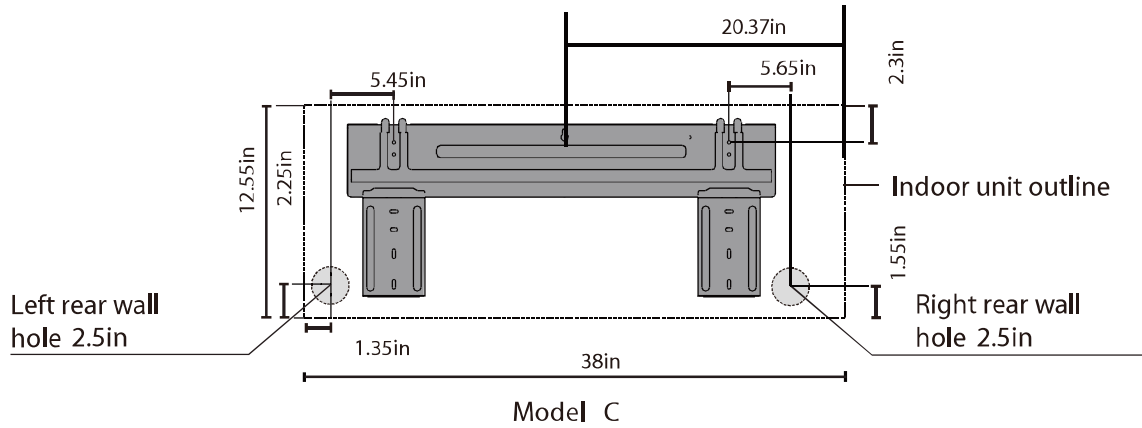

W

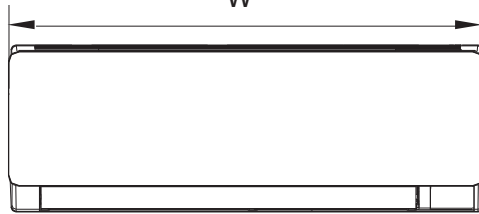

D

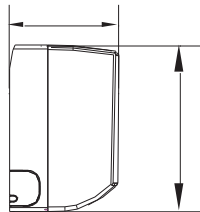

H

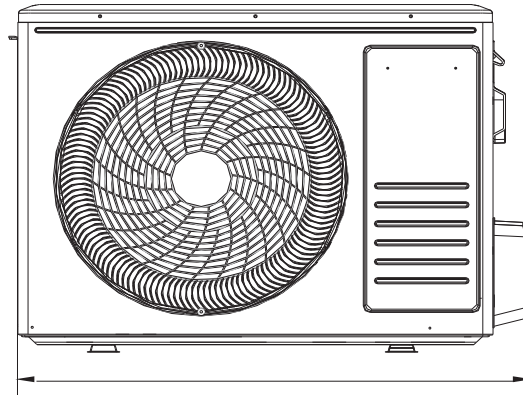
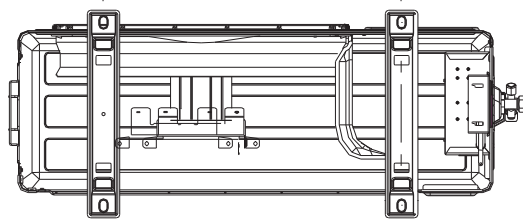

W

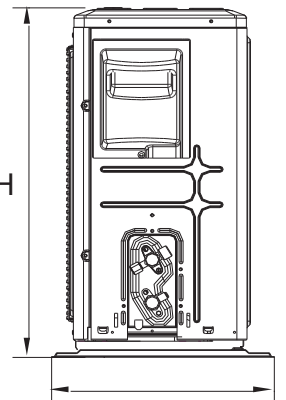

H

D