



INSTRUCTION MANUAL

Negative Pressure Oil System

2150 Elmwood Avenue - Buffalo, New York 14207 USA
Telephone # 716-876-9951 Facsimile #716-874-8048 www.mokon.com

Table of Contents

Section 1 – Warnings and Cautions	1
1.1 Electrical Warning.....	1
1.2 Hot Fluid Warning	1
1.3 Cold Weather Caution.....	1
1.4 Pump Cavitation Warning.....	1
1.5 Overhead Piping Warning.....	1
1.6 Short Circuit Current Rating Caution.....	1
1.7 No Flow Warning.....	2
1.8 PPE.....	2
1.9 Ergonomic Conformance Warning	2
1.10 Non-Potable Water System	2
Section 2 – Installation	3
2.1 Unpacking	3
2.2 Location.....	3
2.3 Warnings	4
2.4 Electrical Connections.....	4
2.5 Filling Reservoir.....	5
2.7 Fluid Connections	6
2.8 Ambient Operating Conditions	6
2.10 Dismantling/Decommissioning.....	6
Section 3 – Operation	7
3.1 Initial Starting Procedure	7
3.2 Changing Temperature Setting.....	7
3.3 Adjusting the Vacuum.....	7
3.4 Shut Down Procedure.....	8
3.5 Restarting Procedure	8
Section 4 – Maintenance and Service.....	9
4.1 Preventative Maintenance	9
Electrical Preventative Maintenance	10
Pump/Motor and Mechanical Connections Preventative Maintenance.....	11
Miscellaneous Preventative Maintenance	12
4.2 High Temperature Pump - Zone Pump	13
4.3 Heater Element.....	14
Wiring.....	14
Installation and Maintenance.....	15
4.4 Low Pressure Safety Switch.....	20
4.5 High Temperature Limit Control	21
4.6 Recommended Heat Transfer Fluids.....	21
4.8 Recommended System Cleaning Fluids.....	23
Section 5 – Eurotherm Controller	24

5.1	Operation	24
	Home List Navigation	24
	Keys	25
5.2	Automatic Tuning	26
	How to Tune:	27
5.3	Troubleshooting	27
	Diagnostic Alarms	27
5.4	Alarm Indicators	27
	To Acknowledge an Alarm	28
	Non-Latched Alarms	28
Section 6 – Troubleshooting Guide		29
Section 7 – Condensed Parts List		32
Section 8 – Model Codes		33
Section 9 – Warranty		34

Oil Systems

Quick Start-Up Checklist

Please verify that the product received matches the product ordered and that the equipment is designed for the intended application. The following quick checklist is an abridged version - always refer to the Mokon Manual provided for additional data and requirements prior to the commissioning of the unit.

✓ **Electrical Inspection**

- Verify amp draws and voltage on serial tag match electrical service being supplied.
- All electrical termination points checked for tightness.
- Electrical wiring completed and disconnect sized and installed per code and compliance.
- Motor rotation verified, motor(s) bumped.
- Verify any remote control wiring is complete.

✓ **Mechanical Inspection**

- Mechanical fittings tight.
- Unions tight.
- Compression fittings tight.
- Insure Supply, Drain and Process connections are connected properly and operating pressure does not exceed ratings.

✓ **Location and Good Standard Installation Practices**

- Confirm safe access to equipment for maintenance, removal and lockout-tag out.
- Insure equipment is designed for the installed environment.
- Allow a minimum of 4 feet (1.2 meters) on all four (4) sides to allow for proper ventilation and operation.
- Allow a minimum clearance of 4 feet, (1.2 meters) or more above unit. Please use extreme caution when dealing with hot surfaces.



2150 Elmwood Avenue, Buffalo, NY 14207

Ph. 716-876-9951; Fax 716-874-8048

www.mokon.com

MOKCLST7001 2/15

General Machinery Description and Intended Use

The Mokon temperature control system is a portable temperature control system circulating fluid to control the temperature of a process. A typical machine consists of a pump, heating/cooling elements, sensors and a microprocessor controller.

Example processes controlled by a Mokon system may include jacketed vessels, heat exchangers and injection molding tools.

Refer to the flow schematic included with the instruction manual to better understand the operation of the system.

Section 1 – Warnings and Cautions

Please read and understand this section before operating the system!

1.1 Electrical Warning



The Mokon temperature control system, as with all high voltage electrical equipment, should be connected according to all local and national codes. All installation, maintenance, service, repair, adjustment, and operation should be done only by qualified trained electrical personnel who have read and completely understood this instruction manual. To the upper right is a symbol for **ELECTRICAL DANGER**. When it is seen on the following pages of this manual as well as on the system, care should be taken to avoid possible electric shock. All maintenance and service should be performed with the power isolated and locked out except where noted.

1.2 Hot Fluid Warning



Exercise **EXTREME CAUTION** while working on or in the area of the Mokon temperature control system. The high temperature of the fluid will cause the process lines, the system components, and the metal cabinetry to become **VERY HOT** and therefore should **NOT** be touched. To the upper right is a symbol for **SURFACE MAY BE HOT, HIGH TEMPERATURE**. When it is seen on the following pages of this manual, care should be taken to avoid possible burns. All maintenance and service must be performed with the system completely cooled. It is advisable to plug the process ports of any unused zones so that if a wrong button is pressed, fluid will not be pumped through them.

1.3 Cold Weather Caution



If the Mokon temperature control system will be moved from your plant and will be subjected to freezing temperatures, the water in the system must be completely drained and/or sufficient antifreeze added to prevent serious water damage from freezing.

1.4 Pump Cavitation Warning

The process utilizing a Mokon temperature control system should be tested PRIOR to use. It is essential that all water to be removed from the process prior to charging with oil. Water concentration as low as 500 PPM in the oil will result in pump cavitations at about 220°F (104°C) operating temperature.

1.5 Overhead Piping Warning

When overhead piping is connected to a Mokon temperature control system equipped with an open reservoir or non-pressurized expansion tank there is risk of overflow of the system's reservoir tank upon shutdown, this is due to the back flow of fluid volume from the overhead piping system.

To prevent reservoir tank overflow an overhead piping kit should be installed. This kit is available from Mokon as an option.

1.6 Short Circuit Current Rating Caution

Equipment supplied with a safety door disconnect or power cord is design rated for a short circuit current rating (SCCR) of 10,000 amperes RMS if protected with a class "J" fuse.

1.7 No Flow Warning

It should be noted that if any external valves are installed in the process flow path, they must be opened before starting the Mokon temperature control system or risk causing serious damage to the system and the process.

Fluid must be established (flowing) through the Mokon temperature control system in order for the safety features to work properly and adequately protect the Mokon temperature control system.

The use of valves downstream of the Mokon temperature control system are not recommended as they could potentially render the system safeties inoperative if closed. This could cause serious system damage and would void the warranty. To avoid disabling the standard safety features, please contact Mokon to discuss optional safety features that may be required to adequately protect the assembly.

1.8 PPE

Personal Protective Equipment (PPE) should be worn when operating or performing maintenance on machine. The minimal recommended PPE to be worn should be safety glasses, gloves and hearing protection (where required)

1.9 Ergonomic Conformance Warning

Depending on the configuration of your machine, the Human Machine Interface (HMI) may be lower than ergonomic standards.

1.10 Non-Potable Water System

This system has been designed for use in non-potable water applications only. For applications requiring potable water use please contact Mokon directly to discuss a product offering.

Section 2 – Installation

2.1 Unpacking

Upon arrival inspection should be done to assure there was no damage during shipping. In addition, all electrical and mechanical connections should be inspected to ensure that they are secure and tight. This includes all electrical terminations, mechanical fitting union bulbs, compression fittings, etc.

Note: Refer to Section 4.1 Maintenance and Service.

The **maximum** weights of the Mokon oil systems when drained of fluid are:

Series	# Of Zones	Heating KW Per Zone	LBS	KG
HF	1	12	590	268
		24	660	300
		36	730	332
		48	830	377
		60	920	418
		72	1275	580
		96	1475	670
		108	1545	702
		120	1640	745
		132	1895	861
	144	2250	1023	
	2	12 (24)	1180	536
		24 (48)	1320	600
		36 (72)	1460	664
		48 (96)	1660	755
		60 (120)	1840	836
		72 (144)	2550	1159

Properly rated equipment should be used to move this machinery.

When removing system from pallet, lift from bottom only. Care should be taken to ensure that the system will not tip. After removing from pallet, the system should only be placed on a level surface.

2.2 Location

Mokon systems should be located in an area that provides adequate space for pedestrian and vehicle traffic. If this is not feasible, owner should provide additional safeguards including safety signs.

For optimum system performance, allow adequate space and ventilation around entire system, as well as a means to direct vapors away from work area.

There should be a minimum of 4 feet (1.2 meters) of clearance around the entire Mokon system (all sides) for adequate ventilation and operation of the system.

If braking casters are included, they must be in the locked position when system is in the operating position. Prior to moving, unlock the casters.

Customer supplied and installed air vents (mechanical or electrical) should be placed at the highest point in the process for application where the process height is greater than 8 feet (2.4 meters) above Mokon system.

2.3 Warnings

Owner should ensure by adequate supervision that correct safety, installation, maintenance and operating procedures described in this manual, as well as recognized industry practice, are followed by all personnel.

All panels must be in place during normal operation.

The top of the machinery should not be used for storage.

Power sources or energy types referred to in this manual are water, oil and electricity.

This machinery is not for use in hazardous or explosion proof environments.

Under normal operating conditions, the decibel level of the machinery is 85 db or lower. When operating the machine, hearing protection is recommended.

Any alteration, additions or modifications to any part of the system must receive prior written approval from Mokon's Engineering or Customer Service Departments.

Refer to serial tag for motor and heater electrical information and schematic drawing number.

Note: If your unit was purchased with a process purge option, review Section 6.3 for operating instructions.

2.4 Electrical Connections



Warning: The Mokon temperature control system, as with all high voltage electrical equipment, should be connected according to all applicable state and local codes. All installation, maintenance, service, repair, adjustment, and operation should be done only by qualified trained electrical personnel who have read and completely understood this instruction manual.

Before operating the Mokon temperature control system, the grounding wire must be connected. The grounding wire is the green or green and yellow wire connected to the frame of the system.

Connect ground wire to the ground screw (labeled GND or PE) located in the electrical box. Connect power lines L1, L2, L3, to disconnect switch or terminal blocks marked L1, L2, and L3 respectively, inside the electrical box. Overcurrent protection of the supply conductors should be sized according to The National Electrical Code (NEC) and any other applicable state and local codes.

2.5 Filling Reservoir

Fill the reservoir with heat transfer fluid (See Section 4.7 for Recommended Fluids) through the fill port. The fill port is located on the side of the reservoir. Fill to the highest level on the sight glass. See chart below for the total fluid capacity of your system.

# Of Zones	Heating Capacity KW Per Zone	Reservoir Tank Volume (Gallons)	Reservoir Tank Volume (Liters)
1	12	18	70
	24	38	144
	36	38	144
	48	38	144
	60	38	144
	72	38	144
	96	58	220
	108	58	220
	120	78	296
	132	78	296
	144	78	296
2	12 (24)	38	144
	24 (48)	78	296
	36 (72)	78	296
	48 (96)	78	296
	60 (120)	78	296
	72 (144)	78	296

Note: On initial start-up, while purging the air from the system, it may be necessary to add additional heat transfer fluid to the reservoir to compensate for the volume of fluid consumed by this process.

Warning: On a standard system, a minimum operating fluid level of 1/2 full is recommended (optimum fluid level is 3/4 full). It must be maintained at all times. If the proper fluid level is not maintained, serious damage may occur to the Mokon system. It is mandatory to periodically inspect the fluid level sight glass and add heat transfer fluid if required.

2.7 Fluid Connections

Exercise extreme caution while working on or in the area of the Mokon temperature control system. The high temperature of the fluid will cause the process lines, the system components, and the metal cabinetry to become very hot and therefore, they should not be touched.

There are four (4) convenient and clearly marked connections, "To Process" (one for each zone), "From Process" (one for each zone), "Supply Water" and "Drain Water." They are located on the rear of the HF system.

Note: Quick disconnects should not be used on any of the connections, they will restrict the flow. **Use full size unrestricted high temperature, insulated hose or pipe for each connection.**

To Process: Connect the port(s) to the process inlet(s), through which heat transfer fluid will enter the process.

From Process: Connect the port(s) to the process outlet(s), from which heat transfer fluid will leave the process.*

Supply Water: Connect the port to an adequate source of cold, clean supply water.

Drain Water: Connect the port to drain (or return line in an in plant closed recirculation system).

Caution: If you are using brass, bronze or copper (yellow) metals in process plumbing that will come in contact with the heat transfer oil, contact Mokon. Yellow metal promotes oxidation of the oil, drastically shortening its life. DELF fluid greatly reduces the possibility of fluid degradation due to metal deactivators in the fluid.

* A "Y" type strainer is provided to be installed in the "From Process" line. Make sure the direction indicating arrow, on the body of the strainer, corresponds to the flow direction of the fluid. It is recommended that the strainer be installed in the horizontal position, with the "Y" pointed downward.

If the strainer must be mounted in the vertical position, below the process connection on the Mokon system, a drip leg should be installed to trap debris that will dislodge from the screen upon shutdown. Consult the factory if the strainer must be installed in this fashion.

2.8 Ambient Operating Conditions

Temperature: -15°F to 4°F (5°C to 40°C)

Humidity: 0 – 95%

Altitude: 328 Feet (1000 Meters) Above Mean Sea Level

2.9 Storage/Transportation Conditions

Temperature: -13°F to 131°F (-25°C to 55°C)

Humidity: 0 – 95%

(See Section 1.3)

2.10 Dismantling/Decommissioning

Reference local codes for disposal

Section 3 – Operation

Prior to starting the Mokon system it may be necessary to tighten the mechanical fittings on the piping. Vibration cause during transport can loosen the fittings. Before proceeding, check and tighten all of the mechanical fittings.

3.1 Initial Starting Procedure

- Fill the Mokon temperature control system with heat transfer fluid. (See Section 2.5 for Filling Reservoir)
- Turn on the water supply connected to the Mokon temperature control system. (See Section 2.6 for Fluid Connections)
- Turn on the electrical main disconnect switch. (See Section 2.4 for Electrical Connections)
NOTE: The covers of the system must be removed for the next two (2) procedures.
- For each zone, check the pump alignment. (See Section 4.2 for Pump Alignment)
- For each zone, check the motor rotation by turning on the system momentarily (press the "Start" button then the "Stop" button). As the pump slows down, check the motor rotation. If the motor is not rotating in the direction of the arrow label located on the motor housing (clockwise from the lead end), reverse any two power cord leads (See Section 2.4) to change the direction of the motor rotation.
- Restart the system and set the controller to the minimum temperature. (See Section 5 for Specific Controller Operation Instructions)
NOTE: The start button may have to be held in for up to 30 seconds in order to build adequate pressure to start the system.
- Allow the system to run for approximately 5 to 10 minutes at the minimum temperature to purge the air from the system. The air is purged from the system when the pressure gauge reading is steady (typically between 40 to 80 PSI / 276 to 552 kPa depending on restrictions in your process) and when the pump runs smooth and steady.
If the above procedure does not eliminate air in the system, turn the unit off then on once or twice to break up the air pockets.
NOTE: The air purge button may be pressed to eliminate air in the system at any time during operation.
- Set the controller to the desired temperature. The system will reach the setpoint temperature. (See Section 5 for Controller Instructions)

3.2 Changing Temperature Setting

If a new temperature setting is required while the system is in operation, adjust the controller to the new desired setpoint temperature. (See Section 5 for Controller Instructions)

3.3 Adjusting the Vacuum

Adjust the positive/negative flow through the mold by using the vacuum adjusting valve (3-way ball valve) on the back of the unit. Start by full closing the valve so that the injector makes a vacuum in the return line from process. At the leak, air is drawn into the circuit. The adjusting valve should be opened slowly to allow water to flow to the mold and pressurize the supply line. The leak will reappear as the pressure increases. At this point, the adjusting valve must be closed until the leak is eliminated.

3.4 Shut Down Procedure

Cool the Mokon temperature control system down by reducing the setpoint temperature to 150°F (66°C) or lower. When the system is cooled, push the "Stop" button to shut off the system. **DO NOT SHUT THE SYSTEM OFF AT ELEVATED TEMPERATURES; THIS CAN BE DETRIMENTAL TO SYSTEM LIFE.** The water and main electrical power to the Mokon temperature control system may be turned off if desired but is not necessary unless the system is being relocated or for prolonged shut down.

3.5 Restarting Procedure

- If the water lines and main electrical power have not been disconnected, refer to Section 3.1.
- If the water lines and/or the main electrical power have been disconnected, refer to Section 2.4 for Electrical Connections, Section 2.6 for Fluid Connections, and Section 3.1 for Initial Starting Procedure.

Section 4 – Maintenance and Service

Warning: The maintenance and service procedures included in Sections 4.1 – 4.6 require that all energy sources need to be de-energized and locked out/tagged out (exceptions noted) prior to opening or removing any panels, covers or doors to perform maintenance. The system should also be completely cooled. Energy sources on this machine include electrical and water. Follow all local and national codes and procedures for working on electrical equipment. Failure to do so could result in injury or death. Only qualified electrical personnel should install, maintain, repair, adjust and operate Mokon temperature control systems. The instruction manual furnished with the system should be completely read and understood before system maintenance is performed.

The following hazard warning symbols will be used to denote a specific hazard associated with a procedure.

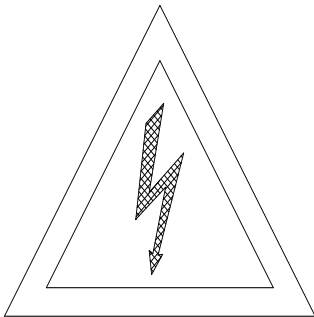

Electrical Danger

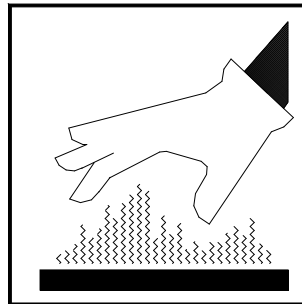

High Temperature
Surface May Be Hot

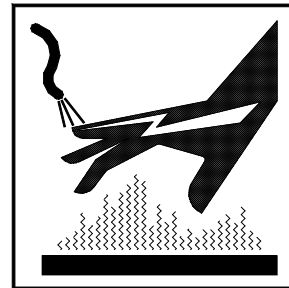

High Voltage &
Hot Surface

4.1 Preventative Maintenance



Mokon temperature control systems are designed for a long, trouble free service life under a variety of conditions, with a minimum of maintenance. Performing the following preventative procedures will extend the life of your system. Refer to Section 4.1 - 4.6 in the instruction manual for specific adjustment or service procedures. Refer to the condensed parts list included in Section 8 of the instruction manual for proper replacement parts if required.

The preventative maintenance section is broken into weekly, monthly, and every three months checks. Associated with each check is a series of corrective procedures that may solve a problem detected in the check. If the corrective procedures do not resolve a problem detected in the check, see the trouble shooting guide in Section 7 for a complete list of corrective measures.



Electrical Preventative Maintenance

Weekly Checks	Corrective Procedures
Check electrical box interior components for any discoloration, or any burn marks	Correct component wiring
	Verify voltage and frequency stamped on system matches customer supply voltage and frequency
	Correct excessive system load (current draw)
	Verify customer supply voltage is balanced and fluctuations are within 15% of nominal
	Verify wire gauge for main power hookup is properly sized
	Replace components if needed
Slightly tug on each conductor to make sure it makes solid contact to its attached component. Pay close attention to the ground wires.	Tighten with proper tooling (Torque to component specs)
For units with solid state contactors, inspect the screen covering the fan inside the electrical enclosure	If clogged with debris, clean or replace the screen. If not cleaned or replaced excessive heat build-up can occur in the electrical enclosure reducing component life and wiring. System warranty will be void.
Monthly Checks	Corrective Procedures
Check that a N.C. contact exists across the temperature switch	Replace the switch if necessary
Check that the low pressure switch (PS) has a set of N.O. and N.C. contacts, and it is properly wired	Correct wiring if necessary
	Replace the switch if necessary
Tighten all high voltage terminal connections	Tighten with proper tooling (Torque to component specs)
Every 3 Months Checks	Corrective Procedures
Check that the interior electrical and mechanical components are securely fastened to the panel	Tighten with proper tooling
Check that the ratings of overload protection (such as fuses and circuit breakers) adequately protect the line's maximum current carrying capacity	Inspect/replace fuses
	Inspect/replace motor starter overloads

Pump/Motor and Mechanical Connections Preventative Maintenance

Weekly Checks	Corrective Procedures
Check for foreign materials obstructing airflow in the motor and pump area	Remove all dust, lint, grease or oil with a cloth and/or brush
Check the heat transfer fluid level through the reservoir sight glass	Fill to at least ½ full, if low
Monthly Checks	Corrective Procedures
Check that all bolts and screws are securely tightened	Tighten with proper tooling
Visually check all threaded fittings for signs of leakage	Tighten with proper tooling
	Replace necessary parts if leaks persist
Check that the motor current draw matches the serial tag rating	Correct motor wiring
	Verify supply voltage is balanced and fluctuations are within 15% of nominal
 Check gauge readings on the suction and discharge side of the pump, and/or on the cabinet (Power On)	Verify suction or discharged line not partially clogged
	Verify no restrictions in process or supply lines
	Replace gauge(s) if needed
 Check that all applicable lights, gauges, and optional indicators are functioning properly (Power On)	Inspect/replace components
Check Y-type strainer, located on the from and/or to process line(s) for debris	Remove and clean
Semi Annual Checks	Corrective Procedures
Check that all threaded fittings within the fluid loop are securely tightened	Tighten with proper tooling
	Replace necessary parts if leaks persist

Miscellaneous Preventative Maintenance

Monthly Checks	Corrective Procedures
 <p>Check the cooling solenoid operation by elevating setpoint temperature manually. While in the heating mode, push the manual air purge button. Listen for the cooling solenoid's audible energizing and de-energizing "clicking sound." Observe process temperature decreasing. (Power On)</p>	Using a Voltmeter, determine if solenoid coil is energizing
	Replace a solenoid valve, if necessary
 <p>Check the controller calibration by setting the controller for three random setpoints within the operating range of the system. Observe that the process temperature output is within the accuracy of the controller. (Power On)</p>	Calibrate controller using Section 5 in the instruction manual (Power On)
	Verify the thermocouple wires at controller are secure
	If controller does not respond to any of the above steps, consult the Mokon factory Do not attempt repairs as the warranty could become void.
 <p>Check the system for leaks at operating temperatures. As the system reaches the setpoint temperature, visually check for leaks. Pay close attention to the heater elements. (Power On)</p>	Repair leaks and/or tighten fittings
	Replace necessary parts
<p>Check that the heater current draw matches the serial tag rating</p>	Verify heater wiring stake-on is secured
	Correct heater wiring
	Verify customer supply voltage is balanced and fluctuations are within 15% of nominal
	Resistance reading is approximately 100 ohms across each element
<p>Check that the "Warning," "High Voltage" and "Caution" labeling are adhering to the correct locations</p>	Replace elements if necessary
	Replace torn, damaged or missing labels

4.2 High Temperature Pump - Zone Pump

DANGER!

- **DO NOT** perform service or maintenance when the pumping system is pressurized or hot-serious injury or death from burn caused by hot oil may occur.
- **DO NOT** operate the pump in a manner that it was not intended to be used.
- **DO NOT** operate the Mokon system without oil in the unit.
- **DO NOT** continue to operate the pump when an unusual noise or vibration occurs.
- **DO NOT** operate beyond the pressure or temperature limits stated on front cover of this manual.
- **DO NOT** allow severe temperature changes to occur in a short period within the Mokon system.
- **DO NOT** mix different types or grades of oil with the Mokon system.
- **DO NOT** use an oil that is not a recommended heat transfer oil by the manufacturer.
- **DO NOT** exceed the maximum oil temperature rated by the oil manufacturer at the hottest point in the Mokon system.

**FAILURE TO FOLLOW THE ABOVE LISTED PRECAUTIONARY MEASURES
MAY RESULT IN SERIOUS INJURY OR DEATH.**

4.3 Heater Element

Wiring

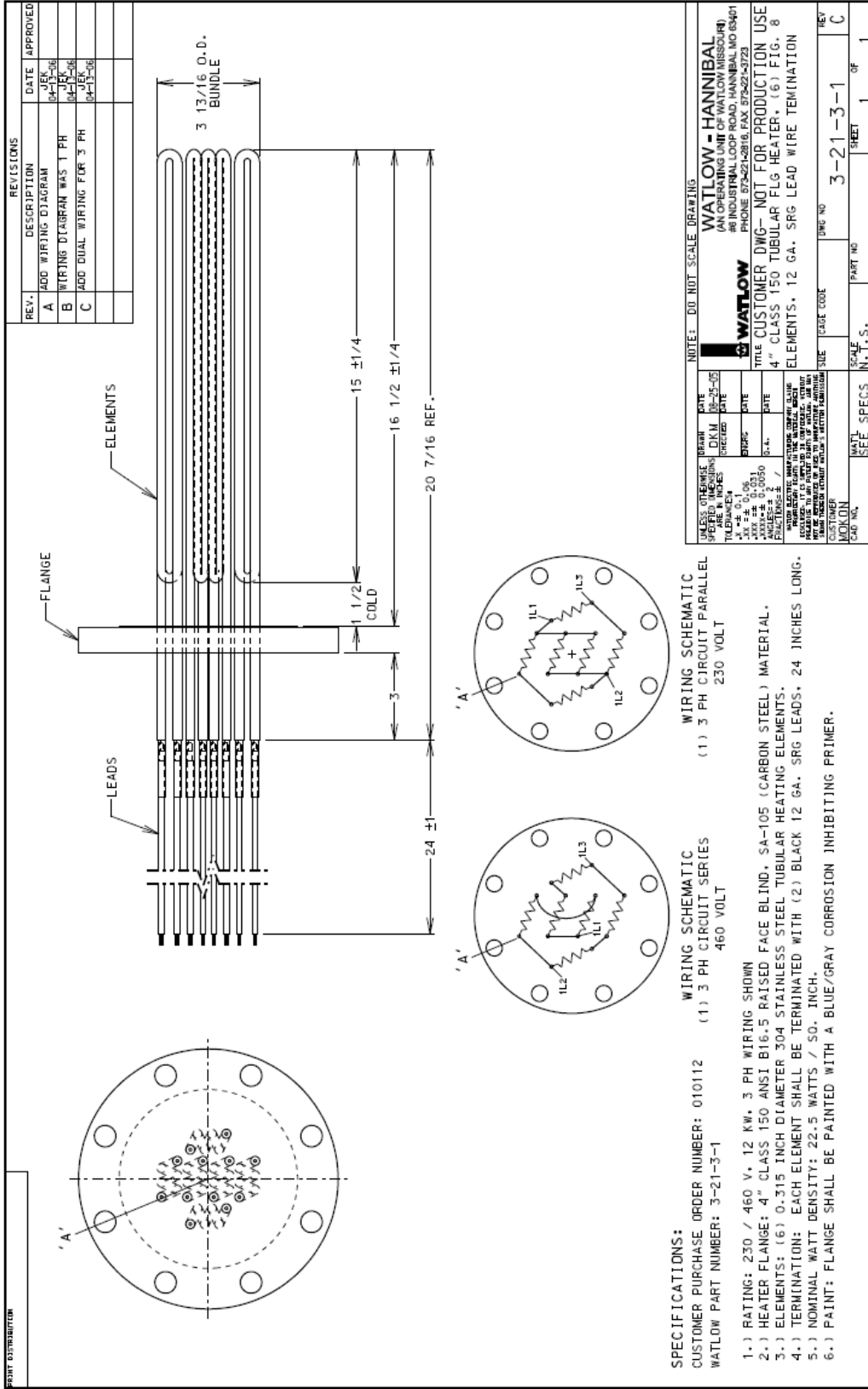

Installation and Maintenance

WATLOW IND. WATROD Flange Heater Installation & Maintenance Manual

I&M NUMBER: 316-42-8-1

Date: 4/25/2006

Page:1

Rev:1.00

Pre Installation

- Check to make sure that heater received is the same as that ordered.
- Elements may come in contact with each other during shipment. Minor adjustments to elements may be required prior to installation to separate them. Extensive bending of elements should be avoided since dielectric strength between coil and sheath may be compromised.
- Watlow heaters are built to comply with UL and CSA dielectric requirements, it may be necessary due to atmospheric conditions / humidity, to perform a dielectric test prior to startup. (Refer to **megohm test** under **Installation** section)

Safety

Electric heaters are inherently dangerous!! Care should be taken to read and completely understand the Installation and Maintenance manual before installing and wiring the heater. Any installation and maintenance performed on the heater shall be done by a qualified electrician, in accordance with the "National Electric Code" and other electrical codes as they apply. It is the users responsibility to ensure that the heater being used is properly selected and installed in the application.



The Caution Symbol (exclamation point) alerts you to a "CAUTION", a safety or functional hazard which could affect your equipment or its performance.



The warning symbol (lightning bolt) alerts you to a "WARNING", a safety hazard which could affect you and the equipment

Installation

Proper heater selection and installation will result in efficient heat transfer, safe operation, and long heater life.

1. Megohm precheck

During shipping and/or storage, the possibility of moisture absorption by the insulation material within the element is possible. To ensure proper megohm values a minimum 500 VDC megohm meter (Megger) should be used to ensure that the megohm reading between the heater terminal and the heater sheath is more than 10 megohms when the unit is at room temperature.

If several units are interconnected, the megohm of the heater is obtained by taking the reading and dividing by the number of interconnected elements. This reading should be greater than 10 megohms.

If a low megohm value exists, two alternative methods can be used to remedy the situation. The best method is to remove all terminal hardware including thermostat if provided, and bake out the heater at no higher than 250°F (120°C) overnight or until an acceptable reading is reached. The second method is to energize the unit at low voltage in air until the megohm is at an acceptable reading. Care should be taken to prevent the heater sheath from exceeding 750°F (398°C) for Incoloy® and steel elements and 400°F (204°C) for copper elements.

2. Protection of heater elements from over temperature

The use of temperature controls to regulate heating process and prevent heater over temperature is highly recommended to ensure safe heater operation. It is the users responsibility to ensure safety of the installation.



WARNING: *Install high temperature control protection in systems where an over temperature fault condition could present a fire hazard or other hazard. Failure to install temperature control*

WATLOW IND. ■ # 6 INDUSTRIAL LOOP RD. ■ HANNIBAL MO, 63401 ■ PHONE 573-221-2816 ■ FAX 573-221-3723

protection where a potential hazard exists could result in damage to equipment and property, and injury to personnel.

Failure of components in a temperature control loop, such as the sensor, heater control relay or main temperature control, can result in damage to a product in process, a melt down of a heater, and / or damaging fire.

To protect against this possibility, over temperature protection must be provided to interrupt or remove power from the heater circuit. **A bulb and capillary thermostat is not recommended for this function since it may not respond quickly enough to adequately protect the heater. In cases where the thermostat bulb gets too hot before the system is turned off, the thermostat bulb could rupture. This could result in the thermostat remaining in the "ON" condition since there is insufficient fluid to move contacts apart.** We recommend the temperature protection have appropriate third party approval, and be applied in the classification for which it was tested and approved.

In order to help prevent premature failure and a potentially hazardous condition in cases where consequences of failure may be severe, use an appropriate third party approved liquid level protection device. The liquid level should be such that the entire heater is fully submerged with enough liquid above the heater to adequately dissipate heat from itself as under normal operating conditions. Consult your local authorized sales representative for specific recommendations for your application.

3. Terminal Enclosures

Terminal enclosures should be selected to be compatible with the environment in which the heater will be located. It is the users responsibility to determine the need for correct rating of the electrical housing. This should be based on appropriate national and local electrical codes. Failure to use a compatible enclosure could result in heater damage and personnel danger.

Standard terminal enclosures are designed for general purpose use and are rated NEMA 1. These enclosures should be applied where there will be no danger of spilled liquids, dampness, dirt, and gaseous conditions. Enclosures for wet or hazardous locations are also available, but must be installed at the factory.

Although enclosures are supplied over the terminals, units should be located in an area that will minimize the chance of being hit by falling or moving objects. The terminals must be protected at all times from moisture or vapor.

In hazardous locations, (as defined in NFPA 70 NEC, Article 501) explosion resistant housings must be used.

In order to maintain termination integrity, the terminal enclosure should be kept below 400°F (204°C).

4. Orientation / Mounting

Watlow flange immersion heaters incorporate a standard ANSI flange for universal mounting in tanks equipped with the same size mounting flange. A suitable gasket and mounting bolts are required for installation but are not provided with the heater. The correct gasket material should be based on the material being heated and the process temperature.

Heater orientation is important in order to ensure efficient heat transfer and safe operation. Care should be taken to allow enough room for heater expansion without compromising heat transfer. When installing the heater through the header on the tank, care should be taken to avoid bending the elements. If possible elements should be inspected to ensure that they are not touching. Failure to do so could result in shorter heater life due to higher heater temperatures.

The location of an immersion heater in a process is of prime importance. To take advantage of natural convection, the unit should be located as low as possible; similar to the position in Figure 1. Consideration should also be given to sludge build-up in the bottom of the tank and the need for heater removal (replacement or maintenance). Location of the heater in the sludge area will cause premature failure and lower heat transfer efficiency.

If heater is being installed in customer supplied circulation tank, a Tubular Circulation I&M manual should be obtained from the factory to ensure safe installation of heater in tank. Failure to do this could result in premature heater failure due to improper fluid flow over elements

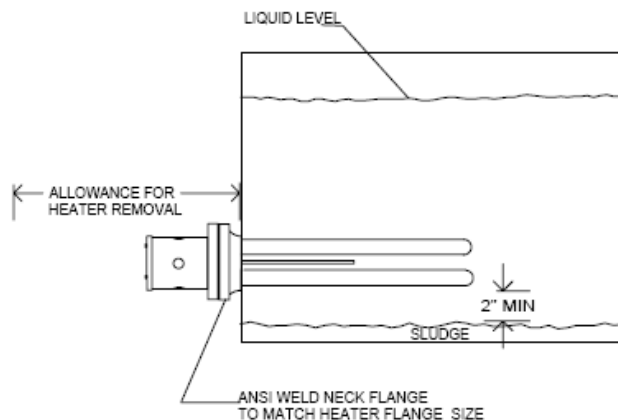

Figure # 1

DANGER: HAZARD OF FIRE. Electric heaters are capable of developing high temperatures so extreme care should be taken to locate heaters in safe environments. Mounting heaters in atmospheres containing combustible gases and vapors should be avoided. According to article 501 of the NEC, the maximum surface temperature of the heater shall not exceed 80 % of the auto-ignition of the surrounding atmosphere when the heater is continuously energized. Care should also be taken to keep combustible materials far enough away to be free of the effects of high temperatures.

5. Wiring

> **WARNING; HAZARD OF ELECTRIC SHOCK.** Any installation involving electric heaters must be grounded to earth to eliminate shock hazard.

Electrical wiring to the heaters must be installed in accordance with the National Electric Code and any state and local electrical code by qualified personnel.

Consult wiring diagram supplied with the unit for correct feeder wires connections. If one is not supplied, the factory should be consulted for the appropriate wiring diagram. Feeder wire should be properly selected based on amperage, electrical power rating, ambient temperature, and type of environment. Feeder wire should also be housed in either rigid or flexible conduit which carries the same classification as the heater enclosure. It is the users responsibility to properly size and install feeder wire.

Feeder wire line connections may be made directly to stud terminals or box type compression fittings. Box type compression fittings will accept a #4 AWG maximum wire while stud terminals will accept a #10 ring connector(T&B, Amp, etc.). It is essential that these connections be tight. Stud terminals should be tightened to a maximum torque of 20 in-lbs while the bottom nut is supported. Ground connection (color coded "green") is supplied inside the housing for ground wire.

WATLOW IND. ■ # 6 INDUSTRIAL LOOP RD. ■ HANNIBAL MO, 63401 ■ PHONE 573-221-2816 ■ FAX 573-221-3723

Line voltage must be equal to or less than rating stamped on the heater assembly. Some units are supplied as dual voltage . Example: 240V / 480V, check wiring diagram supplied with the unit to make sure which scheme was used. In most cases (unless specified by customer) units are wired for the higher voltage.

Thermostats can be supplied with flange heaters. Consult the wiring diagram supplied with the heater for the suggested wiring of thermostats. For safe operation of thermostats, consult Installation and Maintenance manual for thermostats that is attached.

Thermostats should not be used as an "OFF" device; the use of a disconnect switch or circuit breaker is recommended. The disconnect switch will allow isolation of the heater when maintenance of the heater is required.

Start Up

Before energizing the heater the following items should have been checked with the heater power disconnected:

1. Immersed section of heater is completely covered by liquid
2. Electrical termination is tight and wiring is per wiring diagram supplied with heater
3. Proper disconnecting means and fusing have been installed
4. The voltage rating of the heater is the same as that being applied
5. Megohm is within acceptable limits
6. Proper temperature controls and safety limiting devices are in place
7. Heater is securely installed in tank header and no leaks are visible

After applying power to the heater make sure that the system is being controlled properly before leaving it to run unattended. Failure to do this could result in overheating resulting in personnel danger and fire.

Troubleshooting

PROBLEM	Cause / Correction
No power available to heater	Check disconnect switch to ensure it is in the "ON" position and that fuses are not blown. Replace fuses if they are blown
Fuses blowing	Check heater electrical rating. Applied voltage may be wrong Check fuse rating. Fuses should be at least 25% more than full load amperage. Disconnect heater power source. Check the heater resistance to ground. This should be no less than 1 Megohm. Refer to Megohm checking.
Not enough power	Check line voltage to ensure it is within specification Check full line current if voltage is correct. If line current is lower, the heater may be wired wrong or has open elements
Fluid not heating to desired temperature	Not enough Kw Too much heat loss
High limit tripping / alarm	Not enough fluid flow Too much Kw

Line voltage higher than designed / allowable



Preventative Maintenance

CAUTION: HAZARD OF ELECTRIC SHOCK. TURN ALL POWER TO HEATER OFF, USE APPROPRIATE DISCONNECT LOCKOUTS AND ALLOW SYSTEM/HEATER TO COOL BEFORE PERFORMING ANY MAINTENANCE

Check line connections to make sure they are tight, free of oxide build-up, and that no dust or dirt build-up is present. Retighten to 20 in-lbs as necessary.

Check enclosure (inside) for rust, dirt or dust. Remove rust if present, with steel wool (or equal) and thoroughly blow clean with dry, oil-free air.

If enclosure is moisture resistant, check condition of cover gasket. A replacement can be obtained from the factory.

Liquid immersed units should be removed from tank and checked periodically for scale build-up. Clean as required. Scale can cause high sheath temperature and result in inefficiency and shortened life.

Thermal cycling may cause sealed joints to relax causing a leak. Tightening of heater plug should stop leak.

Inspect flange gasket and replace if necessary

Replacement Parts

Reference the flange heater part number on the nameplate when ordering replacement parts. Recommended spare parts would be : a Flange Heater and thermostat (if supplied).

Contact your local Watlow distributor for ordering replacement parts. Check the Yellow Pages under "Electrical Heating Elements" in the largest industrial area nearest you.

Warranty

Watlow warrants its products against defects in material and workmanship for 12 months from the date of delivery for custom products and 18 months for stock products providing such products are properly applied, used and maintained. Watlow does not warrant any product against damage from corrosion, contamination, misapplication, improper specification or operating conditions beyond our control. The terms of this warranty are the exclusive terms available to any person. No person has authority to bind the Company to representation or warranty other than this warranty. Watlow is not liable for incidental or consequential damages resulting from use of the product whether a claim for such damages is based upon warranty, contract, negligence or other fault. Should any product fail under these warranty conditions it will be repaired or replaced at no charge. Advanced authorization must be obtained within 30 days of failure.

Return Policy

1. Call Watlow Industries at 573-221-2816, for a Return Material Authorization (RMA) number before returning any item for repair or replacement. The following information is needed to process a returned heater expeditiously:

- Customer name
- Contact Name
- Part number
- Quantity
- Customer account number
- Phone Number
- P.O. number

WATLOW IND. ■ # 6 INDUSTRIAL LOOP RD. ■ HANNIBAL MO, 63401 ■ PHONE 573-221-2816 ■ FAX 573-221-3723

- Reason for return
 - Application information
 - MSDS sheet of material(s) that came in contact with heater, if used.
2. Prior approval and an RMA number is needed when returning any unused product for credit. Make sure the RMA number is on the outside of the carton, and on all paperwork. Return all material Freight Prepaid basis.
 3. Stock heaters and accessories which have not been used or modified can be returned to the plant for a 20% restocking charge. Modified stock units can only be returned, if they are not permanently modified, for a minimum 30% restocking charge.
 4. All stock and modified stock must have a date code no later than 2 years from the date of shipment.

WATLOW IND. n # 6 INDUSTRIAL LOOP RD. n HANNIBAL MO, 63401n PHONE 573-221-2816 n FAX 573-221-3723

4.4 Low Pressure Safety Switch

Mokon HF series systems are equipped with two low pressure safety shut down switch.

The low pressure switches are located on the discharge side of the zone pump and on the process return line. This switch incorporates an interlock to prevent the operation of the system should the heat transfer fluid be insufficient. The switch is factory set at 5 PSI (34 kPa) and should not be adjusted without **WRITTEN CONSENT FROM THE MOKON FACTORY.**

4.5 High Temperature Limit Control

Mokon HF series systems are equipped with one or more high temperature limit controllers.

Each controller is factory set to shut the Mokon system off at 610°F (321°C). This controller should not be adjusted without **WRITTEN CONSENT FROM THE MOKON FACTORY.**

NOTE: Refer to Section 1.7 for the No Flow Warning.

4.6 Recommended Heat Transfer Fluids

Heat transfer systems manufactured by Mokon are thoroughly tested prior to shipment for leaks, component operation, and accuracy (calibration).

All Mokon heat transfer systems are tested using Mokon's DELF600 heat transfer fluid.

NOTE: The use of any heat transfer fluid other than the ones listed below may void your warranty. Consult the Mokon service department with questions on fluid selection.

When operating the Mokon system, routine fluid samples should be taken and analyzed regularly. These samples can help determine your unique change point. A fluid sample should be taken from a flowing line and cooled below 100°F (38°C) before placing in a clean sample container and sent to the heat transfer manufacturer for analysis. The information gathered from the sample can then be useful in developing a heat transfer fluid maintenance program.

Mokon recommends the following heat transfer fluids for use in Mokon systems. A short description of each fluid offered including the recommended applications for the fluids.

Mokon's Heat Transfer Fluids:

Mokon's heat transfer fluids last longer and help keep your system cleaner...which means longer life for parts like pumps and rotary seals!

Mokon's Heat Transfer Fluids Are:

- ❖ Extremely stable
- ❖ Highly refined using naturally resilient base stocks like, severely hydro treated paraffinic oils
- ❖ Enhanced with a proprietary blend of additives.

DELF450 - engineered for applications between 30°F and 450°F (-1°C to 232°C) offering an excellent alternative to costly synthetics and aromatic fluids. The fluid delivers superior resistance to sludging, a problem plaguing most other fluids, and defends against extreme oxidation.

DELF600 - rated to 600°F (316°C), it contains the industry's most aggressive blend of additives specifically engineered to withstand the extreme oxidation environments in open systems and give unsurpassed levels of protection and service life. All Mokon HTF systems are tested using this fluid!

DELF450FG and DELF600FG - are engineered to comply with the demands of food grade applications and meet USDA requirements for incidental food contact (H1) and 21CFR1783570, and are NSF registered.

DELF 450 & 600 and DELF 450FG & 600FG may be used safely in the Mokon HTF 350, 500, 600, and HF Series systems.

DELF LT - heat transfer fluid is engineered for applications requiring process temperatures ranging from 0°F to 600°F (-17°C to 316°C). Ideal for batch processing requiring heating and cooling cycles.

Other Heat Transfer Fluids Suitable for Use with Mokon's Systems:

Multitherm

PG-1 is a food grade heat transfer fluid for use up to 600°F (316°C). PG-1 meets specifications of 21CFR72.878, which covers the use of white mineral oils in food applications according to the limits and conditions of the regulations. PG-1 is Kosher certified and rated HT-1 for incidental contact by NSF.

IG-4 for use in systems up to 600°F (316°C).

Paratherm

NF is formulated for service up to 600°F (316°C). NF fluid provides excellent heat transfer and is low in viscosity.

HE is a high flash and fire point heat transfer fluid is rated for an optimal service range of 150°F - 600°F (66°C - 316°C).

Petro-Canada Products

Calflo FG for use in closed loop, non-pressurized, indirectly heated, liquid phase heat transfer systems with operating temperatures up to 620°F (326°C). It is accepted by the Canadian Department of Agriculture and approved USDA H1 for incidental food contact.

Calflo HTF is recommended for use in heat transfer systems with operating temperatures up to 620°F (326°C) and film temperatures up to 650°F (343°C). Calflo HTF is a unique heat transfer fluid that combines the thermal efficiency and cleanliness of paraffinic hydrocarbon with the high temperature stability of a chemical synthetic.

Solutia Inc.

Therminol 66 heat transfer fluid is designed for use in non-pressurized/low pressure, indirect heating systems with maximum bulk temperatures up to 650°F (343°C) and film temperatures up to 705°F (374°C).

Duratherm

Duratherm 450 – Heat transfer fluid rated to 450°F (232°C).

Duratherm 600 – Heat transfer fluid rated to 600°F (316°C), used in a variety of applications.

Duratherm Lite - Heat transfer fluid with the same physical properties as Duratherm 600 but formulated with a lighter dose of additives. Duratherm Lite is economically ideal for applications that are prone to fluid loss or attrition due to equipment change.

Duratherm FG is rated for use up to 620°F (326°C) and is engineered and manufactured to comply with the demands of food grade applications. Duratherm FG meets USDA requirements for incidental food contact (H1) and meets the requirements of 21CFR1783570 and is NSF registered.

4.8 Recommended System Cleaning Fluids

NOTE: The use of any system cleaning fluid other than the ones shown below may void your warranty. Consult the Mokon service department with questions on fluid selection.

The use of these fluids is done at the owners own risk. Mokon assumes no responsibility for the effectiveness or the liability for damages that may occur while using these fluids. Please consult the manufacturer's instructions for safe and proper use prior to using any of the cleaning fluids listed in this manual.

*When operating the Mokon HTF system, routine fluid samples should be analyzed. Fluid samples for analysis should be taken regularly. These samples can help determine your unique change point. A fluid sample should be taken from a flowing line and cooled below 100°F (38°C) before placing in a clean sample container and sent to the heat transfer manufacturer for analysis. The information gathered from the sample can then be useful in developing a heat transfer fluid maintenance program.

Mokon's Heat Transfer System Cleaner:

The industry's first heat transfer system cleaner that provides full production while cleaning!

Mokon's DELFClean - a long life, preventative maintenance and light duty system cleaner that is capable of functioning as a long-term heat transfer fluid up to 550°F (288°C). This fluid is odorless and easily handles long term operation while seamlessly allowing production to continue uninterrupted for a complete oil cycle.

Other Cleaners Suitable for Use with Mokon's Systems:

Multitherm

Multitherm PSC cleaning fluid is designed for use in general maintenance of larger heat transfer fluid systems. PSC is formulated to be compatible with all MultiTherm heat transfer fluids as well as most others so that small residual amounts left in the system will not cause a problem.

Paratherm

Paratherm SC® system cleaning liquid is formulated to dissolve and suspend sludge and carbon lumps frequently produced in hot oil temperature control units where petroleum or glycol-based heat transfer fluids have been used.

Duratherm

Duratherm Duraclean is a preventative maintenance and light duty system fluid up to 550°F (288°C).

Duratherm's Duraclean Ultra is a high performance, fast acting and High flash point terpene solvent. A unique combination of terpene, alcohols, penetrants, and surfactants designed to remove grease, oil, and carbon deposits. This fluid can be run to 150°F (66°C) max. Duraclean Ultra is environmentally safe, low toxicity, biodegradable, and comes from a renewable natural resource.

Section 5 – Eurotherm Controller

Refer to the 4th character in the model code on the serial tag and then the model code in Section 9 to determine your controller type.

5.1 Operation

This section of the manual contains all essential information needed to operate the controller. Contact Mokon Customer Service with controller problems as well as warranty and repair issues.

The controller is configured by model number. Inputs, outputs and alarm types are preset. Final setup and configuration are done from the keypad. The controller has four basic modes: Operator 1, Operator 2, Operator 3 and the configuration level.

The controller's default level is Operator 1, and is used for day to day operation.

Note: Operator 2, 3 and configuration are password protected.

Home List Navigation

To step through list levels press and hold the Page button until level 1 is obtained. Press the up button or the down button to change levels.

To step through parameters within a particular list, press the Scroll button until the required parameter is obtained.

To change the value (or state) of a parameter, press the Up button or the Down button.

***Refer to Section 5.1 Keys for button locations and descriptions.**





Levels	Operator 1	Scroll	Function
	WRK.OP	WORKING OUPUT The active output value	Output %
	SP1	SETPOINT 1	-----
	SP2	SETPOINT 2	-----
	DWELL	SET TIME DURATION	Auto air purge time setting
	T-REMIN	TIME REMAINING	Time remaining for Auto Air Purge
*	A1.xxx	ALARM 1 SETPOINT	Only shown if the alarm is configured. Where: xxx = alarm type. HI = High alarm; LO = Low alarm d.HI – Deviation high: d.LO = Deviation Low: D.HI = Deviation high
*	A2.xxx	ALARM 2 SETPOINT	
*	A3.xxx	ALARM 3 SETPOINT	
*	A4.xxx	ALARM 4 SETPOINT	
	A.TUNE	Auto Tune Enable	
	ID	Customer ID	Controller Revision #

*Optional

Keys

NOTE: Pictured is the 3216 Eurotherm controller - this also applies to 3116, 3204 and 3208 series controllers.



Button or Indicator	Name	Explanation
OP1	Output 1	When lit, it indicates that heating output is on. "HEATING" will scroll.
OP2	Output 2	When lit, it indicates that cooling output is on. "COOLING" will scroll.
	Page button	Press to select a new list of parameters.
	Scroll button	Press to select a new parameter in a list.
	Down button	Press to decrease a value in the setpoint.
	Up button	Press to increase a value in the setpoint.
*ALM	Alarm	Flashes when in alarm condition. "ALARM MESSAGE" will scroll.
OP4	Output 4	When lit indicates that the air purge output is on. "AUTO AIR PURGE" will scroll.
RUN	Timer Running	When lit indicates that the air purge output is on. "AUTO AIR PURGE" will scroll.

*Optional

5.2 Automatic Tuning

In tuning, you match the characteristics (PID parameters) of the controller to those of the process being controlled in order to obtain good control. Good control means:

- Stable, 'straight-line' control of the PV as setpoint without fluctuation.
- No overshoot or undershoot, of the PV setpoint.
- Quick response to deviations from the setpoint caused by external disturbances, thereby rapidly restoring the PV to the setpoint value.
- Tuning involves calculating and setting the value of the parameters listed in the table below.

The PID Controller Consists of the Following Parameters:

Parameter	Meaning or Function
Proportional Band	The proportional term, in display unit or %, delivers and output which is proportional to the size of the error signal.
Integral Time	Removes steady state control offsets by ramping the output up or down in proportion to the amplitude and duration of the error.
Derivative Time	Determines how strongly the controller will react to the rate of change in the measured value. It is used to prevent overshoot and undershoot and to restore the PV rapidly if there is a sudden change in demand.
High Cutback	The numbers of display units, above setpoint, at which the controller will increase the output power, in order to prevent undershoot on cool down.
Low Cutback	The number display units, below setpoint, at which the controller will cut back the output power, in order to prevent overshoot on heat up.
Relative Cool Gain	Only present if cooling has been configured. Sets the cooling proportional band, which equals the heat proportional band value divided by the cool gain value.

The controller uses a one shot tuner which automatically sets up the initial values of the parameters listed in the table.

The 'one-shot' tuner works by switching the output on and off to induce an oscillation in the measure value. From the amplitude and period of the oscillation, it calculates the tuning parameter values.

If the process cannot tolerate full heating or cooling being applied, then the levels can be restricted by setting the high power limit ('O P .HI') and low power limit ('O P .LO'). However, the measured value *must* oscillate to some degree for the tuner to be able to calculate values.

A One-Shot tune can be performed at any time, but normally it is performed only once during the initial commissioning of the process. However, if the process under control subsequently becomes unstable (because its characteristics have changed), you can re-tune again for the new conditions.

It is best to start tuning with the process at ambient conditions and with the SP close to the normal operating level. This allows the tuner to calculate more accurately the low cutback and high cutback values that restrict the amount of overshoot or undershoot.

How to Tune:

- Set the setpoint to the value at which you will normally operate the process.
- Operator level 1 list, press,  until A.Tune appears. Set to ON.
- Press the Page and Scroll buttons together to return to the Home display. The display will flash [tunE] to indicate that tuning is in progress.
- After one (1) minute to determine steady state conditions the controller will induce an oscillation in the temperature by turning the output on and then off. The first cycle will not complete until the measured value has reached the required setpoint.

5.3 Troubleshooting

Diagnostic Alarms

Display Shows	What it means	What to do about it
E.ConF	A change made to a parameter takes a finite time to be entered. If the power to the controller is turned off before the change has been entered then this alarm will occur. Do not turn the power off to the controller while ConF is flashing.	Enter configuration level then return to the required operating level. It may be necessary to re-enter the parameter change since it will not have been entered in the previous configuration.
E.CAL	Calibration error	Re-instate Factory calibration
E2.Er	EEPROM error	Return to factory for repair
EEEr	Non-vol memory error	Note the error and contact your supplier
E.Lin	Invalid input type. This refers to custom linearization which may not have been applied corrector or may have been corrupted.	Go to the INPUT list in configuration level and set a valid thermocouple or input type.

Note: Some error messages may not appear, depending on the controller options.

5.4 Alarm Indicators

- ALM beacon flashing red = a new alarm (unacknowledged).
- This is accompanied by a scrolling alarm message. A typical default message will show the source of the alarm followed by the type of alarm. For example, "ALARM 1 FULL SCALE HIGH".
- If more than one alarm is present further messages are flashed in turn in the main display. The alarm indication will continue while the alarm condition is present and is not acknowledged.
- ALM beacon on continuously = alarm has been acknowledged.

To Acknowledge an Alarm

Press  and  together.

Non-Latched Alarms

Alarm condition present when the alarm is acknowledged.

- ALM beacon on continuously.
- The alarm message(s) will continue to scroll.

This state will continue for as long as the alarm condition remains. When the alarm condition disappears all indication also disappears.

If the alarm condition disappears before it is acknowledged the alarm reset immediately.

Consult customer service at Mokon factory (716) 876-9951, regarding system's minimum and maximum temperatures if there are any questions.

Section 6 – Troubleshooting Guide

Problem	Possible Cause	Corrective Measure
System will not start	System unplugged / power off	Plug system in / turn power on
	Improper power source wiring	Check wiring (electrical schematics) and correct
	Blown fuse at power supply	Isolate open fuse and replace
	Blown control circuit fuse	Replace and check for ground condition
	Low voltage	Measure incoming voltage, if too low correct
	High temperature limit control	Consult factory
	Process purge switch (if supplied) in neutral position	Switch to "Forward" or "Reverse"
Running pilot does not go on	System unplugged / power off	Plug system in / turn power on
	Blown fuse at power supply	Isolate open fuse and replace
	Blown control circuit fuse	Replace and check for ground condition
	Bulb burn out	Replace bulb
System runs momentarily	High temperature limit control	Consult factory
	Motor starter thermal overloads tripped due to motor overload	Consult factory
Pressure will no build up	Incorrect pump location	See Section 3.1 to check and correct motor rotation
	Entrapped air	See Section 3.1
	Pump relief valve stuck open	Consult factory
	Inadequate fluid level	Check that sight glass reads at least ½ full, if not add fluid
	Pump needs adjusting	See Section 4.2
	No fluid in the pump	Prime the pump
	Reservoir tank valve closed	Open valve
Pressure surges erratically and system will not hold temperature	Entrapped air	See Section 3.1
	Inadequate fluid level	Check that sight glass reads at least ½ full, if not add fluid
	Suction line leak	Repair leak
	Contaminated fluid	Drain and replace fluid

Problem	Possible Cause	Corrective Measure
Extreme pressure build up	Plugged flow paths, inadequate circulation through process and connecting lines	Inspect; if plugged, dislodge
		Clean strainers
High pressure and erratic temperature	Plugged flow paths, inadequate circulation through process and connecting lines	Inspect; if plugged, dislodge
		Clean strainers
Loss of pressure and volume output	Entrapped air	See Section 3.1
	Zone pump needs adjusting	See Section 4.2
	Pressure gauges	Inspect/replace component
	Inadequate fluid level	Check that sight glass reads at least ½ full, if not add fluid
	Cooling valve	Inspect/replace component
Temperature climbs beyond setpoint	Pump relief valve stuck open	Consult factory
	Heater contactor	Inspect/replace component
	Temperature controller	Inspect/replace component
	Thermocouple or RTD	Inspect/replace component
System does not reach and/or hold temperature or slow response after changing temperature setting	Controller calibration	See Controller Section 5
	Contaminated fluid	Drain/replace fluid
	Heater burn out	Inspect/replace component
	Temperature controller	Inspect/replace component
	Kilowatt capacity inadequate	Consult Mokon engineering
	Loose electrical connections	Tighten connection or replace broken wires
	Thermocouple or RTD	Inspect/replace component
	Controller calibration	See Section 5
	Cooling valve stuck open	Consult factory
Variance in temperature readings	Plugged flow paths, inadequate circulation through process and connecting lines	Inspect; if plugged, dislodge
		Clean strainers
	Contaminated fluid	Drain and replace fluid
	Kilowatt capacity inadequate	Consult Mokon engineering
Reservoir tank overheating	Inadequate fluid level	Check that sight glass reads at least ½ full, if not add fluid
	Water not flowing through heat exchanger	Consult factory
	Cooling valve stuck open	Consult factory
	Relief valve stuck open	Inspect/replace component

Problem	Possible Cause	Corrective Measure
Noisy pump	Entrapped air	See Section 3.1
	Pump needs adjusting	See Section 4.2
	Pump needs alignment	See Section 4.2
	Worn coupling and/or grommet between pump and motor	Inspect/replace component
	Worn bearing on pump	Inspect/replace component
	Leak on suction side of pump	Repair leak

Section 7 – Condensed Parts List

Part No.	Description
006256	24 Amp Motor Contactor 110V Coil
006257	40 Amp Heater Contactor 110V Coil
006366	1.0 – 5.0 Amp Overload (Refer to Motor Name Plate Information for
006367	3.2 – 16 Amp Overload Proper Overload)
008056	0 – 160 PSI Pressure Gauge
011070	12 KW Heater
022038	Start/Stop Button
022142	Low Pressure Safety Switch
025107	Cooling Solenoid Valve
Zone Pump/Motor Replacement Parts – Consult the Mokon Factory	
040011	Thermocouple

For additional part numbers refer to the specific section in the instruction manual or consult the Mokon factory (716) 876-9951.

Section 8 – Model Codes

HF Oil Model Codes			
		Model #	
		HF441200	
Pump Style			See Option Code
HF	HF Series Oil Systems (1998)		
Voltage			Kilowatt Capacity
2	230 Volts / 3 Phase / 60 Hertz		12 12 kW
3	380 Volts / 3 Phase / 50 Hertz		24 24 kW
4	460 Volts / 3 Phase / 60 Hertz		36 36 kW
5	575 Volts / 3 Phase / 60 Hertz		48 48 kW
6	415 Volts / 3 Phase / 50 Hertz		60 60 kW
7	208 Volts / 3 Phase / 60 Hertz		72 72 kW
9	Special Voltage, <i>see option code</i>		84 84 kW
Controller & GPM			96 96 kW
2	Eurotherm One zone, 90 GPM		108 108 kW
3	Eurotherm Two zone, 90 GPM		120 120 kW
4	*Eurotherm One zone, 40 GPM		132 132 kW
5	*Eurotherm Two zones, 40 GPM		144 144 kW
6	*Eurotherm One zone, 60 GPM		
7	*Eurotherm Two zones, 60 GPM		
8	Eurotherm One zone, 120 GPM		
9	Eurotherm Two zone, 120 GPM		
A	Special One zone, 40 GPM		
B	Special Two zones, 40 GPM		
C	Special One zone, 60 GPM		
D	Special Two zones, 60 GPM		
E	Special One zone, 90 GPM		
F	Special Two zones, 90 GPM		
G	Special One zone, 120 GPM		
H	Special Two zone, 120 GPM		
I	Eurotherm Three zones, 40 GPM		
J	Special Three zones, 40 GPM		
*Prior to 6/4/01, was Barber-Colman			
Effective 8/21/06-UL labeled Electrical subpanel			

Section 9 – Warranty

OIL SYSTEMS WARRANTY

All new temperature control systems manufactured by MOKON are guaranteed to be free from defective material or workmanship for a period of one (1) year from the date of purchase. All Standard Microprocessor controllers are covered by a five (5) year warranty, Microprocessors with special features are covered by a three (3) year warranty and Solid State controllers are covered by a one (1) year warranty. MOKON'S obligation under the WARRANTY SHALL BE LIMITED, TO THE ORIGINAL CUSTOMER, TO REPAIR OR REPLACE DEFECTIVE PART(S) OF THE TEMPERATURE CONTROL SYSTEM, UPON CUSTOMERS COMPLIANCE WITH THE INSTRUCTIONS CONTAINED HEREIN. Upon discovery of any alleged defect, it is the responsibility of the customer to contact the MOKON Service Department with the complete model number, serial number and the date of purchase. MOKON'S obligation under this warranty is limited to make good, from or at its factory, any parts that are returned to the company (prepaid) and deemed to defective, within the time frame of the warranty. The customer also has the option of forwarding the system to MOKON (Buffalo, NY), prepaid by the customer and with a return authorization from MOKON for inspection and component replacement or repair. Repair or replacement in any manner provided above shall constitute a fulfillment of all liabilities of MOKON concerning the quality of the temperature control system.

No allowances, credits or reimbursements will be made for any replacement or repair made or provided for by the customer unless authorized in advance, in writing, by MOKON.

NOTE: The use of any heat transfer fluid other than the ones recommended in the instruction manual or approved by Mokon in writing, may void your warranty. Consult the Mokon service department with questions on fluid selection.

The warranty set forth above is in lieu of any and all other warranties expressed or implied including warranties of merchantability and fitness for a particular purpose. Mokon shall in no event be liable for any consequential damages or for any breach of warranty in an amount exceeding the original price of the unit.

Mokon's products are not guaranteed against damage caused by corrosion.



2150 Elmwood Avenue - Buffalo, NY 14207
P# 716-876-9951 - F#716-874-8048 - www.mokon.com