



INSTRUCTION MANUAL

Compact HTF Oil System

Models Covered H2 & H3

2150 Elmwood Avenue - Buffalo, New York 14207 USA
Telephone # 716-876-9951 Facsimile #716-874-8048 www.mokon.com

MOK2000F 03/20

Table of Contents

Section 1 – Warnings and Cautions	1
1.1 Electrical Warning	1
1.2 Hot Fluid Warning	1
1.3 Cold Weather Caution	1
1.4 Pump Cavitation Warning	1
1.5 Overhead Piping Warning	1
1.6 Short Circuit Current Rating Caution	1
1.7 No Flow Warning	2
1.8 PPE.....	2
1.9 Ergonomic Conformance Warning.....	2
Section 2 – Installation	3
2.1 Unpacking.....	3
2.2 Location	3
2.3 Warnings.....	3
2.4 Electrical Connections	4
2.5 Filling Reservoir	4
2.6 Fluid Connections	4
2.7 Ambient Operating Conditions.....	5
2.9 Dismantling/Decommissioning	5
Section 3 – Operation	6
3.1 Initial Starting Procedure	6
3.2 Changing Temperature Setting	6
3.3 Shut Down Procedure	7
3.4 Restarting Procedure.....	7
Section 4 – Maintenance and Service.....	8
4.1 Preventative Maintenance.....	8
Electrical Preventative Maintenance.....	9
Pump/Motor and Mechanical Connections Preventative Maintenance	10
Miscellaneous Preventative Maintenance.....	11
4.2 High Temperature Pump - Zone Pump.....	12
Exploded View Drawing.....	13
4.3 Pump Relief Valve.....	13
4.4 Heater Assembly.....	14
4.5 Low Pressure Safety Switch	14
4.6 High Temperature Safety Switch.....	14
4.7 Recommended Heat Transfer Fluids	15
4.8 Recommended System Cleaning Fluids	17
Section 5 – Eurotherm Controller (3000 Series)	18

5.1	Operation	18
	Home List Navigation.....	18
	Keys	19
5.2	Automatic Tuning.....	20
	How to Tune	21
5.3	Troubleshooting	21
	Diagnostic Alarms	21
5.4	Alarm Indicators	21
	To Acknowledge an Alarm.....	22
	Non-Latched Alarms.....	22
5.5	Automatic Air Purge Operation (Start-Up)	22
	Adjusting Auto Air Purge Timer	22
5.6	Restarting the Automatic Air Purge Timer (After Start-Up).....	23
5.7	Manual Air Purge Operation (After Start-Up).....	23
5.8	Remote Setpoint and Retransmission “Scaling”	23
Section 6 – Options		24
6.1	Process Purge Option (Reverse Flow Switch).....	24
6.2	Process Purge Option (Air Connections).....	24
6.3	In-Line Heat Exchanger for Additional Cooling	25
6.4	Cool Down and Automatic Shut Off	25
	Adjusting Auto Cool Down/Shutdown Timer	25
6.5	Emergency Stop.....	26
6.6	Valved Process Bypass	26
6.7	Low Fluid Level Shut Off.....	26
6.8	Heating Only.....	26
Section 7 – Troubleshooting Guide		27
Section 8 – Condensed Parts List		30
Section 9 – Warranty		31
End of Life Industrial Waste - Saving our Environment		31

Oil Systems

Quick Start-Up Checklist

Please verify that the product received matches the product ordered and that the equipment is designed for the intended application. The following quick checklist is an abridged version - always refer to the Mokon Manual provided for additional data and requirements prior to the commissioning of the unit.

✓ **Electrical Inspection**

- Verify amp draws and voltage on serial tag match electrical service being supplied.
- All electrical termination points checked for tightness.
- Electrical wiring completed and disconnect sized and installed per code and compliance.
- Motor rotation verified, motor(s) bumped.
- Verify any remote control wiring is complete.

✓ **Mechanical Inspection**

- Mechanical fittings tight.
- Unions tight.
- Compression fittings tight.
- Insure Supply, Drain and Process connections are connected properly and operating pressure does not exceed ratings.

✓ **Location and Good Standard Installation Practices**

- Confirm safe access to equipment for maintenance, removal and lockout-tag out.
- Insure equipment is designed for the installed environment.
- Allow a minimum of 4 feet (1.2 meters) on all four (4) sides to allow for proper ventilation and operation.
- Allow a minimum clearance of 4 feet, (1.2 meters) or more above unit. Please use extreme caution when dealing with hot surfaces.



2150 Elmwood Avenue, Buffalo, NY 14207

Ph. 716-876-9951; Fax 716-874-8048

www.mokon.com

MOKCLST7001 2/15

General Machinery Description and Intended Use

The Mokon temperature control system is a portable temperature control system circulating fluid to control the temperature of a process. A typical machine consists of a pump, heating/cooling elements, sensors and a microprocessor controller.

Example processes controlled by a Mokon system may include jacketed vessels, heat exchangers and injection molding tools.

Refer to the flow schematic included with the instruction manual to better understand the operation of the system.

Section 1 – Warnings and Cautions

Please read and understand this section before operating the system!

1.1 Electrical Warning



The Mokon temperature control system, as with all high voltage electrical equipment, should be connected according to all local and national codes. All installation, maintenance, service, repair, adjustment, and operation should be done only by qualified trained electrical personnel who have read and completely understood this instruction manual. To the upper right is a symbol for Electrical Danger. When it is seen on the following pages of this manual as well as on the system, care should be taken to avoid possible electric shock. All maintenance and service should be performed with the power isolated and locked out except where noted.

1.2 Hot Fluid Warning



Exercise Extreme Caution while working on or in the area of the Mokon Temperature Control System. The high temperature of the fluid will cause the process lines, the system components, and the metal cabinetry to become very hot and therefore should not be touched. To the upper right is a symbol for surface may be hot, high temperature. When it is seen on the following pages of this manual, care should be taken to avoid possible burns. All maintenance and service must be performed with the system completely cooled. It is advisable to plug the process ports of any unused zones so that if a wrong button is pressed, fluid will not be pumped through them.

1.3 Cold Weather Caution



If the Mokon temperature control system will be moved from your plant and will be subjected to freezing temperatures, the water in the system must be completely drained and/or sufficient antifreeze added to prevent serious water damage from freezing.

1.4 Pump Cavitation Warning

The process utilizing a Mokon temperature control system should be tested PRIOR to use. It is essential that all water to be removed from the process prior to charging with oil. Water concentration as low as 500 PPM in the oil will result in pump cavitations at about 220°F (104°C) operating temperature.

1.5 Overhead Piping Warning

When overhead piping is connected to a Mokon temperature control system equipped with an open reservoir or non-pressurized expansion tank there is risk of overflow of the system's reservoir tank upon shutdown, this is due to the back flow of fluid volume from the overhead piping system.

To prevent reservoir tank overflow an overhead piping kit should be installed. This kit is available from Mokon as an option.

1.6 Short Circuit Current Rating Caution

Equipment supplied with a safety door disconnect or power cord is design rated for a short circuit current rating (SCCR) of 10,000 amperes RMS if protected with a class "J" fuse.

1.7 No Flow Warning

It should be noted that if any external valves are installed in the process flow path, they must be opened before starting the Mokon temperature control system or risk causing serious damage to the system and the process.

Fluid must be established (flowing) through the Mokon temperature control system in order for the safety features to work properly and adequately protect the Mokon temperature control system.

The use of valves downstream of the Mokon temperature control system are not recommended as they could potentially render the system safeties inoperative if closed. This could cause serious system damage and would void the warranty. To avoid disabling the standard safety features, please contact Mokon to discuss optional safety features that may be required to adequately protect the assembly.

1.8 PPE

Personal Protective Equipment (PPE) should be worn when operating or performing maintenance on machine. The minimal recommended PPE to be worn should be safety glasses, gloves and hearing protection (where required)

1.9 Ergonomic Conformance Warning

Depending on the configuration of your machine, the Human Machine Interface (HMI) may be lower than ergonomic standards.

Section 2 – Installation

2.1 Unpacking

Upon arrival inspection should be done to assure there was no damage during shipping. In addition, all electrical and mechanical connections should be inspected to ensure that they are secure and tight. This includes all electrical terminations, mechanical fitting union bulbs, compression fittings, etc.

Note: Refer to Section 4.1 Maintenance and Service.

Properly rated equipment should be used to move this machinery.

When removing system from pallet, lift from bottom only. Care should be taken to ensure that the system will not tip. After removing from pallet, the system should only be placed on a level surface.

2.2 Location

Mokon systems should be located in an area that provides adequate space for pedestrian and vehicle traffic. If this is not feasible, owner should provide additional safeguards including safety signs.

For optimum system performance, allow adequate space and ventilation around entire system, as well as a means to direct vapors away from work area.

If braking casters are included, they must be in the locked position when system is in the operating position. Prior to moving, unlock the casters.

Customer supplied and installed air vents (mechanical or electrical) should be placed at the highest point in the process for application where the process height is greater than 8 feet (2.4 meters) above Mokon system.

2.3 Warnings

Owner should ensure by adequate supervision that correct safety, installation, maintenance and operating procedures described in this manual, as well as recognized industry practice, are followed by all personnel.

All panels must be in place during normal operation.

The top of the machinery should not be used for storage.

Power sources or energy types referred to in this manual are water, oil and electricity.

This machinery is not for use in hazardous or explosion proof environments.

Under normal operating conditions, the decibel level of the machinery is 85 dB or lower. When operating the machine, hearing protection is recommended.

Any alteration, additions or modifications to any part of the system must receive prior written approval from Mokon's Engineering or Customer Service Departments.

Refer to serial tag for motor and heater electrical information and schematic drawing number.

Note: If your unit was purchased with a process purge option, review Section 6.3 or 6.4 for operating instructions.

2.4 Electrical Connections



Warning: The Mokon temperature control system, as with all high voltage electrical equipment, should be connected according to all applicable state and local codes. All installation, maintenance, service, repair, adjustment, and operation should be done only by qualified trained electrical personnel who have read and completely understood this instruction manual.

Before operating the Mokon temperature control system, the grounding wire must be connected. The grounding wire is the green or green and yellow wire connected to the frame of the system.

Connect ground wire to the ground screw (labeled GND or PE) located in the electrical box. Connect power lines L1, L2, L3, to disconnect switch or terminal blocks marked L1, L2, and L3 respectively, inside the electrical box. Overcurrent protection of the supply conductors should be sized according to The National Electrical Code (NEC) and any other applicable state and local codes.

2.5 Filling Reservoir

Fill the reservoir with heat transfer fluid (See Section 4.7 for Recommended Fluids) through the fill port. The fill port is located on the top of the system. Fill to the highest level on the sight glass. The capacity for the Mokon temperature control system is approximately 5 gallons.

Note: On initial start-up, while purging the air from the system, it may be necessary to add additional heat transfer fluid to the reservoir to compensate for the volume of fluid consumed by this process.

Warning: On a standard system, a minimum operating fluid level of $\frac{1}{2}$ full is recommended (optimum fluid level is $\frac{3}{4}$ full). It must be maintained at all times. If the proper fluid level is not maintained, serious damage may occur to the Mokon system. It is mandatory to periodically inspect the fluid level sight glass and add heat transfer fluid if required

2.6 Fluid Connections

Exercise extreme caution while working on or in the area of the Mokon temperature control system. The high temperature of the fluid will cause the process lines, the system components, and the metal cabinetry to become very hot and therefore, they should not be touched.

There are four (4) convenient and clearly marked connections, "To Process", "From Process", "Supply Water" and "Drain Water." (Note: Quick disconnects should not be used on any of the connections, they will restrict the flow.)

Use full size unrestricted high temperature, insulated hose or pipe for each connection.

To Process: Connect the port to the process inlet, through which heat transfer fluid will enter the process.

From Process: Connect the port to the process outlet, from which heat transfer fluid will leave the process.*

Supply Water: Connect the port to an adequate source of cold, clean supply water.

Drain Water: Connect the port to drain (or return line in an in plant closed recirculation system).

Caution: If you are using brass, bronze or copper (yellow) metals in process plumbing that will come in contact with the heat transfer oil, contact Mokon. Yellow metal promotes oxidation of the oil, drastically shortening its life. DELF fluid greatly reduces the possibility of fluid degradation due to metal deactivators in the fluid.

2.7 Ambient Operating Conditions

Temperature: 41°F to 104°F (5°C to 40°C)

Humidity: 0 – 95%

Altitude: 328 Feet (1000 Meters) Above Mean Sea Level

2.8 Storage/Transportation Conditions

Temperature: -13°F to 131°F (-25°C to 55°C)

Humidity: 0 – 95%

(See Section 1.3)

2.9 Dismantling/Decommissioning

Reference local codes for disposal

Section 3 – Operation

Prior to starting the Mokon system it may be necessary to tighten the mechanical fittings on the piping. Vibration cause during transport can loosen the fittings. Before proceeding, check and tighten all of the mechanical fittings.

3.1 Initial Starting Procedure

- Fill the Mokon temperature control system with heat transfer fluid. (See Section 2.5 for Filling Reservoir)
- Turn on the water supply connected to the Mokon temperature control system. (See Section 2.6 for Fluid Connections)
- Turn on the electrical main disconnect switch. (See Section 2.4 for Electrical Connections)
- If your system is supplied with the process fluid purge via switch option, make sure the three position, "Forward / Reverse" selector switch is in the forward position.

Note: The cover of the system must be removed for the next two (2) procedures.

- Check the motor rotation by turning on the system momentarily (press the "Start" button then the "Stop" button). As the pump slows down, check the motor rotation. If the motor is not rotating in the direction of the arrow label located on the motor housing (clockwise from the lead end), reverse any two power cord leads (See Section 2.4) to change the direction of the motor rotation.
- Restart the system and set the controller to the minimum temperature. (See Section 5 for Specific Controller Operation Instructions)

Note: The start button may have to be held in for up to 30 seconds in order to build adequate pressure to start the system.

- Allow the system to run for several minutes with the controller set to the minimum temperature to remove air from the system. All systems have as standard an auto-air purge, factory default set for 5 minutes. After 5 minutes of operation at the minimum temperature the system should automatically purge itself of air. The air is purged from the system when the pressure gauge reading is steady (typically between 20 to 30 depending on restrictions in your process) and when the pump runs smooth and steady.

If the above procedure does not eliminate air in the system, turn the system off then on once or twice to break up the air pockets.

Note: The air purge button may be pressed to eliminate air in the system at any time during operation.

Note: Some processes require a different air purge timed cycle other than the factory default set value. Adjustments can be made to either lengthen or shorten this timed cycle. Please refer to Sections 5.5 and 5.6 for additional information on the automatic air purge feature.

- Set the controller to the desired temperature. The system will reach the setpoint temperature. (See Section 5 for Controller Instructions)

3.2 Changing Temperature Setting

If a new temperature setting is required while the system is in operation, adjust the controller to the new desired setpoint temperature. (See Section 5 for Controller Instructions)

3.3 Shut Down Procedure

Cool the Mokon temperature control system down by reducing the setpoint temperature to 150°F (66°C) or lower. When the system is cooled, push the "Stop" button to shut off the system. *Do not shut the system off at elevated temperatures; this can be detrimental to system life.* The water and main electrical power to the Mokon temperature control system may be turned off if desired but is not necessary unless the system is being relocated or for prolonged shut down.

3.4 Restarting Procedure

- If the water lines and main electrical power have not been disconnected, refer to Section 3.1.
- If the water lines and/or the main electrical power have been disconnected, refer to Section 2.4 for Electrical Connections, Section 2.6 for Fluid Connections, and Section 3.1 for Initial Starting Procedure.

Section 4 – Maintenance and Service

Warning: The maintenance and service procedures included in Sections 4.1 – 4.6 require that all energy sources need to be de-energized and locked out/tagged out (exceptions noted) prior to opening or removing any panels, covers or doors to perform maintenance. The system should also be completely cooled. Energy sources on this machine include electrical and water. Follow all local and national codes and procedures for working on electrical equipment. Failure to do so could result in injury or death. Only qualified electrical personnel should install, maintain, repair, adjust and operate Mokon temperature control systems. The instruction manual furnished with the system should be completely read and understood before system maintenance is performed.

The following hazard warning symbols will be used to denote a specific hazard associated with a procedure.

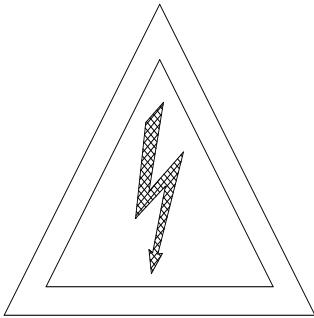

Electrical Danger

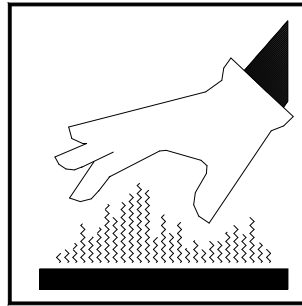

High Temperature
Surface May Be Hot

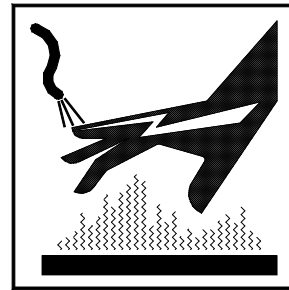

High Voltage &
Hot Surface

4.1 Preventative Maintenance

Mokon temperature control systems are designed for a long, trouble free service life under a variety of conditions, with a minimum of maintenance. Performing the following preventative procedures will extend the life of your system. Refer to Section 4.1 - 4.6 in the instruction manual for specific adjustment or service procedures. Refer to the condensed parts list included in Section 8 of the instruction manual for proper replacement parts if required.

The preventative maintenance section is broken into weekly, monthly, and every three months checks. Associated with each check is a series of corrective procedures that may solve a problem detected in the check. If the corrective procedures do not resolve a problem detected in the check, see the trouble shooting guide in Section 7 for a complete list of corrective measures.



Electrical Preventative Maintenance

Weekly Checks	Corrective Procedures
Check electrical box interior components for any discoloration, or any burn marks	Correct component wiring
	Verify voltage and frequency stamped on system matches customer supply voltage and frequency
	Correct excessive system load (current draw)
	Verify customer supply voltage is balanced and fluctuations are within 15% of nominal
	Verify wire gauge for main power hookup is properly sized
	Replace components if needed
Slightly tug on each conductor to make sure it makes solid contact to its attached component. Pay close attention to the ground wires.	Tighten with proper tooling (torque to component specs)
For units with solid state contactors, inspect the screen covering the fan inside the electrical enclosure	If clogged with debris, clean or replace the screen. If not cleaned or replaced excessive heat build-up can occur in the electrical enclosure reducing component life and wiring. System warranty will be void.
Monthly Checks	Corrective Procedures
Check that a N.C. contact exists across the temperature switch	Replace the switch if necessary
Check that the low pressure switch (PS) has a set of N.O. and N.C. contacts, and it is properly wired	Correct wiring if necessary
	Replace the switch if necessary
Tighten all high voltage terminal connections	Tighten with proper tooling (Torque to component specs)
Every 3 Months Checks	Corrective Procedures
Check that the interior electrical and mechanical components are securely fastened to the panel	Tighten with proper tooling
Check that the ratings of overload protection (such as fuses and circuit breakers) adequately protect the line's maximum current carrying capacity	Inspect/replace fuses
	Inspect/replace motor starter overloads

Pump/Motor and Mechanical Connections Preventative Maintenance

Weekly Checks	Corrective Procedures
Check for foreign materials obstructing airflow in the motor and pump area	Remove all dust, lint, grease or oil with a cloth and/or brush
Monthly Checks	Corrective Procedures
<p>Check that all bolts and screws are securely tightened</p> <p>Bolts are Grade 5 Motor bolts – 5/16” Pump bolts – 3/8”</p> <p>Coupling set screw</p>	<p>Tighten with proper tooling</p> <p>Torque: 13 lb-ft Torque: 23 lb-ft</p> <p>Torque: 80-90 lb-in</p>
<p>Visually check all threaded fittings for signs of leakage</p>	<p>Tighten with proper tooling</p> <p>Replace necessary parts if leaks persist</p>
<p>Check the electrical conduit fittings are securely tightened, and there is no evidence of cracked, burned, or discolored conduits</p>	<p>Tighten with proper tooling</p> <p>Replace cracked or burned conduit</p>
<p>Check that the motor current draw matches the serial tag rating</p>	<p>Correct motor wiring</p> <p>Verify supply voltage is balanced and fluctuations are within 15% of nominal</p>
<div data-bbox="228 1062 378 1213" data-label="Image"> </div> <p>Check gauge readings on the suction and discharge side of the pump, and/or on the cabinet (Power On)</p>	<p>Verify suction or discharged line not partially clogged</p> <p>Verify no restrictions in process or supply lines</p> <p>Replace gauge(s) if needed</p>
Semi Annual Checks	Corrective Procedures
<p>Check that all threaded fittings within the fluid loop are securely tightened</p>	<p>Replace necessary parts if leaks persist</p> <p>Tighten with proper tooling</p>
<p>Visually check the coupling to see if the spider’s leg volume or thickness is at 75% of the original volume or thickness of 5/16”.</p>	<p>Disassemble the coupling and replace.</p>

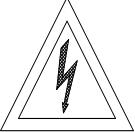
Miscellaneous Preventative Maintenance

Monthly Checks	Corrective Procedures
 <p>Check that all applicable lights, gauges, and optional indicators are functioning properly (Power On)</p>	<p>Replace necessary components</p>
 <p>Check the cooling solenoid operation by elevating setpoint temperature manually. While in the heating mode, push the manual air purge button. Listen for the cooling solenoids audible energizing and de-energizing "clicking sound." Observe process temperature decreasing. (Power On)</p>	<p>Using a Voltmeter, determine if solenoid coil is energizing</p>
	<p>Replace a solenoid valve, if necessary</p>
 <p>Check the controller calibration by setting the controller for three random setpoints within the operating range of the system. Observe that the process temperature output is within the accuracy of the controller. (Power On)</p>	<p>Calibrate controller using Section 5 in the instruction manual (Power On)</p>
	<p>Verify the thermocouple wires at controller are secure</p>
	<p>If controller does not respond to any of the above steps, consult the Mokon factory <u><i>Do not attempt repairs as the warranty could become void</i></u></p>
 <p>Check the system for leaks at operating temperatures. As the system reaches the setpoint temperature, visually check for leaks. Pay close attention to the heater elements. (Power On)</p>	<p>Repair leaks and/or tighten fittings</p>
	<p>Replace necessary parts</p>

Miscellaneous Preventative Maintenance

Monthly Checks	Corrective Procedures
Check that the heater current draw matches the serial tag rating	Verify heater wiring stake-on is secured
	Correct heater wiring
	Verify customer supply voltage is balanced and fluctuations are within 15% of nominal
	Resistance reading is approximately 100 ohms across each element
	Replace elements if necessary
Check that the "Warning," "High Voltage" and "Caution" labeling are adhering to the correct locations	Replace torn, damaged or missing labels
Clean drain line from Packing area of Viking Pump	Disconnect the 90-degree compression fitting from the pipe nipple connected to the packing drain area. Clean out the inside of the steel tubing leading to the reservoir and the nipple leading to pump.
Check heat transfer fluid level through the reservoir sight glass	Fill to at least ½ full, if low

4.2 High Temperature Pump - Zone Pump

Warning: Disassembling the Viking pump will void the pump manufacturer’s warranty as well as the Mokon warranty.

Danger: Before opening any Viking pump or liquid chamber (pumping chamber, reservoir, jacket, etc.) Be sure:

- That any pressure in chamber has been completely vented through suction or discharge lines or other appropriate openings or connections.
- That the driving means (motor) has been “locked out” or made non-operational so that it cannot be started while work is being done on the pump.

Failure to follow the above listed precautionary measures may result in serious injury.

The Viking pumps are designed for long, trouble-free service life under a wide variety of application conditions with a minimum of maintenance. The following points will help provide long service life.

Cleaning Pump: Keep pump as clean as possible. This makes inspection, adjustment, and repair work easier and helps prevent overlooking a dirt covered grease fitting when lubricating.

Pump Rotation: The pump is designed got CLOCKWISE rotation as standard (viewed from shaft end).

Storage: If the pump is to be stored, or not to be used for six months or so, the pump must be drained and a light coat of non-detergent SAE 30 weight oil must be applied to all internal pump parts. Lubricate fittings and apply grease to the pump shaft extension. Viking suggests rotating the pump shaft, by hand, one complete revolution every 30 days to circulate the oil.

Exploded View Drawing

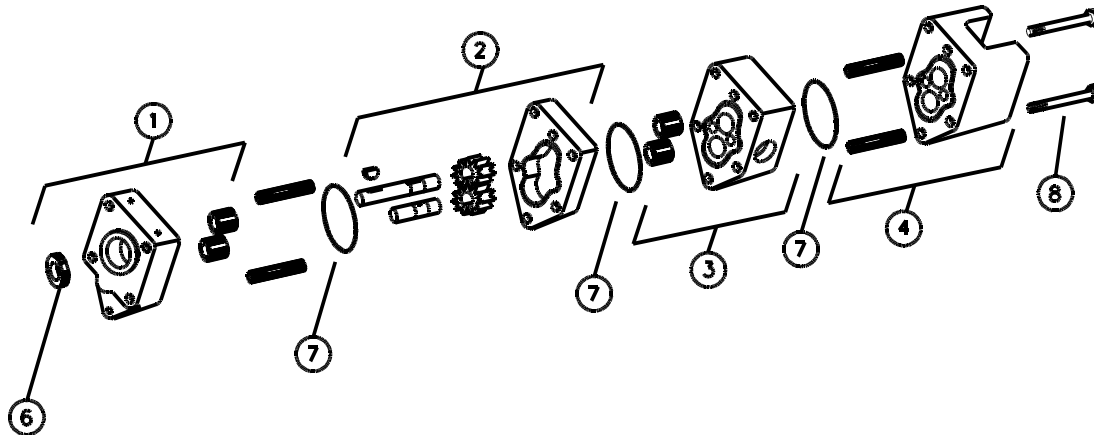

REF #	DESCRIPTION	REF #	DESCRIPTION
1	Bracket, lipseal & bearing section	5	Not depicted, not applicable
2	Match ground casing & (2) gears, driver & driven shafts	6	Model H2 Lipseal 032115 Model H3 Lipseal 032091
3	Separation plate & bearing assembly	7	O-Ring
4	Head and alignment sleeve assembly	8	Assembly capscrews

4.3 Pump Relief Valve

Note: The pump relief valve is not to be used as a process bypass!

There is a pump relief valve on each pumping circuit. The pump relief valve is set at 50 PSI (345 kPa). When restrictions in the process are such that it will not accept the full pump output at less than the set pressure, this valve opens and maintains full oil flow over heaters regardless of the flow to the process.

The valve has been factory set and should not require further adjustments. If it is necessary to recalibrate, CONSULT THE MOKON FACTORY.

4.4 Heater Assembly

- Disconnect the electric power and the water supply to the system.
- Remove the back access panel to the system.
- Remove the heater bundle access plate.
- Disconnect the heater bundle wires.
- Remove the canister bolts.
- Pull the heater bundle away from the canister. The S.S. diverter is inserted between the heater elements.
Note: the position of the diverter relative to the elements; it must be inserted in the same position for the new heater bundle.
- Clean the canister. Pay particular attention to the flanged area where the gasket sits.
- Insert the diverter between the heater elements of the new heater bundle as follows
 - Locate the "N" stamped on the lead end of the heater bundle.
 - Set the heater bundle upright on the lead end with the "N" facing right (3 o'clock position).
 - Hold the diverter upright over the heater bundle with the gap on the top and the lower right (3 o'clock position).
 - Slip the diverter straight down between the heater elements so that each section has an equal number of heater elements.
- Insert the new heater bundle into the canister with a new gasket so that the "N" stamped on the lead end is in the 2 o'clock position.
- Replace the canister bolts.
- Reconnect the heater bundle wires as diagramed on the back of the access plate.
- Replace the access plate.

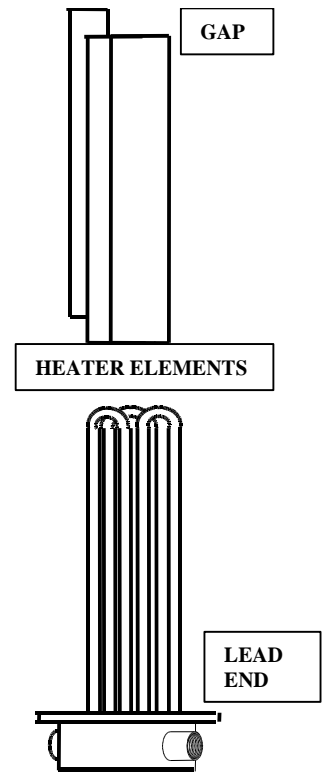

4.5 Low Pressure Safety Switch

Mokon systems are equipped with a low pressure safety shut down switch. This switch incorporates an interlock to prevent the operation of the system should the heat transfer fluid be insufficient. The switch is factory set at 5 PSI (34 kPa) and should not be adjusted without WRITTEN CONSENT FROM THE MOKON FACTORY.

4.6 High Temperature Safety Switch

The high temperature safety cut off is located in the heater manifold. This switch is factory set to shut the Mokon system off at 360°F (182°C). The switch should not be adjusted without WRITTEN CONSENT FROM THE MOKON FACTORY.

Note: Refer to Section 1.7 for the No Flow Warning.

4.7 Recommended Heat Transfer Fluids

Heat transfer systems manufactured by Mokon are thoroughly tested prior to shipment for leaks, component operation, and accuracy (calibration).

All Mokon heat transfer systems are tested using Mokon's DELF600 heat transfer fluid.

Note: The use of any heat transfer fluid other than the ones listed below may void your warranty. Consult the Mokon service department with questions on fluid selection.

When operating the Mokon system, routine fluid samples should be taken and analyzed regularly. These samples can help determine your unique change point. A fluid sample should be taken from a flowing line and cooled below 100°F (38°C) before placing in a clean sample container and sent to the heat transfer manufacturer for analysis. The information gathered from the sample can then be useful in developing a heat transfer fluid maintenance program.

Mokon recommends the following heat transfer fluids for use in Mokon systems. A short description of each fluid offered including the recommended applications for the fluids.

Mokon's Heat Transfer Fluids:

Mokon's heat transfer fluids last longer and help keep your system cleaner...which means longer life for parts like pumps and rotary seals!

Mokon's Heat Transfer Fluids Are:

- ❖ Extremely stable
- ❖ Highly refined using naturally resilient base stocks like, severely hydro treated paraffinic oils
- ❖ Enhanced with a proprietary blend of additives.

DELF450 - engineered for applications between 30°F and 450°F (-1°C to 232°C) offering an excellent alternative to costly synthetics and aromatic fluids. The fluid delivers superior resistance to sludging, a problem plaguing most other fluids, and defends against extreme oxidation.

DELF600 - rated to 600°F (315°C), it contains the industry's most aggressive blend of additives specifically engineered to withstand the extreme oxidation environments in open systems and give unsurpassed levels of protection and service life. All Mokon HTF systems are tested using this fluid!

DELF450FG and DELF600FG - are engineered to comply with the demands of food grade applications and meet USDA requirements for incidental food contact (H1) and 21CFR1783570, and are NSF registered.

DELF 450 & 600 and DELF 450FG & 600FG - may be used safely in the Mokon HTF 350, 500, 600, and HF Series systems.

DELF LT - heat transfer fluid is engineered for applications requiring process temperatures ranging from 0°F to 600°F (-17°C to 316°C). Ideal for batch processing requiring heating and cooling cycles.

Other Heat Transfer Fluids Suitable for Use with Mokon's Systems:

Multitherm

PG-1 - is a food grade heat transfer fluid for use up to 600°F (316°C). PG-1 meets specifications of 21CFR72.878, which covers the use of white mineral oils in food applications according to the limits and conditions of the regulations. PG-1 is Kosher certified and rated HT-1 for incidental contact by NSF.

IG-4 - for use in systems up to 600°F (316°C).

Paratherm

NF - is formulated for service up to 600°F (316°C). NF fluid provides excellent heat transfer and is low in viscosity.

HE - is a high flash and fire point heat transfer fluid is rated for an optimal service range of 150°F - 600°F (66°C - 316°C).

Petro-Canada Products

Calflo FG - for use in closed loop, non-pressurized, indirectly heated, liquid phase heat transfer systems with operating temperatures up to 620°F (326°C). It is accepted by the Canadian Department of Agriculture and approved USDA H1 for incidental food contact.

Calflo HTF - is recommended for use in heat transfer systems with operating temperatures up to 620°F (326°C) and film temperatures up to 650°F (343°C). Calflo HTF is a unique heat transfer fluid that combines the thermal efficiency and cleanliness of paraffinic hydrocarbon with the high temperature stability of a chemical synthetic.

Solutia Inc.

Therminol 66 - heat transfer fluid is designed for use in non-pressurized/low pressure, indirect heating systems with maximum bulk temperatures up to 650°F (343°C) and film temperatures up to 705°F (374°C).

Duratherm

Duratherm 450 - heat transfer fluid rated to 450°F (232°C).

Duratherm 600 - heat transfer fluid rated to 600°F (316°C), used in a variety of applications.

Duratherm Lite - heat transfer fluid with the same physical properties as Duratherm 600 but formulated with a lighter dose of additives. Duratherm Lite is economically ideal for applications that are prone to fluid loss or attrition due to equipment change.

Duratherm FG - is rated for use up to 620°F (327°C) and is engineered and manufactured to comply with the demands of food grade applications. Duratherm FG meets USDA requirements for incidental food contact (H1) and meets the requirements of 21CFR1783570 and is NSF registered.

4.8 Recommended System Cleaning Fluids

Note: The use of any system cleaning fluid other than the ones shown below may void your warranty. Consult the Mokon service department with questions on fluid selection.

The use of these fluids is done at the owners own risk. Mokon assumes no responsibility for the effectiveness or the liability for damages that may occur while using these fluids. Please consult the manufacturer's instructions for safe and proper use prior to using any of the cleaning fluids listed in this manual.

*When operating the Mokon HTF system, routine fluid samples should be analyzed. Fluid samples for analysis should be taken regularly. These samples can help determine your unique change point. A fluid sample should be taken from a flowing line and cooled below 100°F (38°C) before placing in a clean sample container and sent to the heat transfer manufacturer for analysis. The information gathered from the sample can then be useful in developing a heat transfer fluid maintenance program.

Mokon's Heat Transfer System Cleaner:

The industry's first heat transfer system cleaner that provides full production while cleaning!

Mokon's DELFClean - a long life, preventative maintenance and light duty system cleaner that is capable of functioning as a long-term heat transfer fluid up to 550°F (288°C). This fluid is odorless and easily handles long term operation while seamlessly allowing production to continue uninterrupted for a complete oil cycle.

Other Cleaners Suitable for Use with Mokon's Systems:

Multitherm

Multitherm PSC - cleaning fluid is designed for use in general maintenance of larger heat transfer fluid systems. PSC is formulated to be compatible with all Multitherm heat transfer fluids as well as most others so that small residual amounts left in the system will not cause a problem.

Paratherm

Paratherm SC® - system cleaning liquid is formulated to dissolve and suspend sludge and carbon lumps frequently produced in hot oil temperature control units where petroleum or glycol-based heat transfer fluids have been used.

Duratherm

Duratherm Duraclean - is a preventative maintenance and light duty system fluid up to 550°F (288°C).

Duratherm's Duraclean Ultra - is a high performance, fast acting and High flash point terpene solvent. A unique combination of terpene, alcohols, penetrants, and surfactants designed to remove grease, oil, and carbon deposits. This fluid can be run to 150°F (66°C) max. Duraclean Ultra is environmentally safe, low toxicity, biodegradable, and comes from a renewable natural resource.

Section 5 – Eurotherm Controller (3000 Series)

5.1 Operation

This section of the manual contains all essential information needed to operate the controller. Contact Mokon Customer Service with controller problems as well as warranty and repair issues.

The controller is configured by model number. Inputs, outputs and alarm types are preset. Final setup and configuration are done from the keypad. The controller has four basic modes: Operator 1, Operator 2, Operator 3 and the configuration mode.

The controller's default level is Operator 1, and is used for day to day operation.

Note: Operator 2, 3 and configuration are password protected.

Home List Navigation

To step through list levels press and hold the Page button until level 1 is obtained. Press the up button or the down button to change levels.

To step through parameters within a particular list, press the Scroll button until the required parameter is obtained.

To change the value (or state) of a parameter, press the Up button or the Down button.

***Refer to Section 5.1 Keys for button locations and descriptions.**





Levels	Operator 1	Scroll	Function
	WRK.OP	WORKING OUPUT The active output value	Output %
	SP1	SETPOINT 1	-----
	SP2	SETPOINT 2	-----
	DWELL	SET TIME DURATION	Auto air purge time setting
	T-REMIN	TIME REMAINING	Time remaining for Auto Air Purge
	* A1.xxx	ALARM 1 SETPOINT	Only shown if the alarm is configured. Where: xxx = alarm type. HI = High alarm; LO = Low alarm d.HI – Deviation high: d.LO = Deviation Low: D.HI = Deviation high
	* A2.xxx	ALARM 2 SETPOINT	
	* A3.xxx	ALARM 3 SETPOINT	
	* A4.xxx	ALARM 4 SETPOINT	
	A.TUNE	Auto Tune Enable	
	ID	Customer ID	Controller Revision #

*Optional

Keys

Note: Pictured is the 3216 Eurotherm controller - this also applies to 3116, 3204 and 3208 series controllers.



Button or Indicator	Name	Explanation
OP1	Output 1	When lit, it indicates that heating output is on. "HEATING" will scroll.
OP2	Output 2	When lit, it indicates that cooling output is on. "COOLING" will scroll.
	Page button	Press to select a new list of parameters.
	Scroll button	Press to select a new parameter in a list.
	Down button	Press to decrease a value in the setpoint.
	Up button	Press to increase a value in the setpoint.
*ALM	Alarm	Flashes when in alarm condition. "ALARM MESSAGE" will scroll.
OP4	Output 4	When lit indicates that the air purge output is on. "AUTO AIR PURGE" will scroll.
RUN	Timer Running	When lit indicates that the air purge output is on. "AUTO AIR PURGE" will scroll.

*Optional

5.2 Automatic Tuning

In tuning, you match the characteristics (PID parameters) of the controller to those of the process being controlled in order to obtain good control. Good control means:

- Stable, 'straight-line' control of the PV as setpoint without fluctuation.
- No overshoot or undershoot, of the PV setpoint.
- Quick response to deviations from the setpoint caused by external disturbances, thereby rapidly restoring the PV to the setpoint value.
- Tuning involves calculating and setting the value of the parameters listed in the table below.

The PID Controller Consists of the Following Parameters:

Parameter	Meaning or Function
Proportional Band	The proportional term, in display unit or %, delivers and output which is proportional to the size of the error signal.
Integral Time	Removes steady state control offsets by ramping the output up or down in proportion to the amplitude and duration of the error.
Derivative Time	Determines how strongly the controller will react to the rate of change in the measured value. It is used to prevent overshoot and undershoot and to restore the PV rapidly if there is a sudden change in demand.
High Cutback	The numbers of display units, above setpoint, at which the controller will increase the output power, in order to prevent undershoot on cool down.
Low Cutback	The number display units, below setpoint, at which the controller will cut back the output power, in order to prevent overshoot on heat up.
Relative Cool Gain	Only present if cooling has been configured. Sets the cooling proportional band, which equals the heat proportional band value divided by the cool gain value.

The controller uses a one shot tuner which automatically sets up the initial values of the parameters listed in the table.

The 'one-shot' tuner works by switching the output on and off to induce an oscillation in the measure value. From the amplitude and period of the oscillation, it calculates the tuning parameter values.

If the process cannot tolerate full heating or cooling being applied, then the levels can be restricted by setting the high power limit ('O P .HI') and low power limit ('O P .LO'). However, the measured value *must* oscillate to some degree for the tuner to be able to calculate values.

A One-Shot tune can be performed at any time, but normally it is performed only once during the initial commissioning of the process. However, if the process under control subsequently becomes unstable (because its characteristics have changed), you can re-tune again for the new conditions.

It is best to start tuning with the process at ambient conditions and with the SP close to the normal operating level. This allows the tuner to calculate more accurately the low cutback and high cutback values that restrict the amount of overshoot or undershoot.

How to Tune

- Set the setpoint to the value at which you will normally operate the process.
- Operator level 1 list, press,  until A.Tune appears. Set to ON.
- Press the Page and Scroll buttons together to return to the Home display. The display will flash [tunE] to indicate that tuning is in progress.
- After one (1) minute to determine steady state conditions the controller will induce an oscillation in the temperature by turning the output on and then off. The first cycle will not complete until the measured value has reached the required setpoint.

5.3 Troubleshooting

Diagnostic Alarms

Display Shows	What It Means	What To Do About It
E.ConF	A change made to a parameter takes a finite time to be entered. If the power to the controller is turned off before the change has been entered then this alarm will occur. Do not turn the power off to the controller while ConF is flashing.	Enter configuration Level then return to the required operating level. It may be necessary to re-enter the parameter change since it will not have been entered in the previous configuration.
E.CAL	Calibration error	Re-instate Factory calibration
E2.Er	EEPROM error	Return to factory for repair
EEEr	Non-vol memory error	Note the error and contact your supplier
E.Lin	Invalid input type. This refers to custom linearization which may not have been applied corrector or may have been corrupted.	Go to the INPUT list in configuration level and set a valid thermocouple or input type.

Note: Some error messages may not appear, depending on the controller options.

5.4 Alarm Indicators

- ALM beacon flashing red = a new alarm (unacknowledged).
- This is accompanied by a scrolling alarm message. A typical default message will show the source of the alarm followed by the type of alarm. For example, "ALARM 1 FULL SCALE HIGH".
- If more than one alarm is present further messages are flashed in turn in the main display. The alarm indication will continue while the alarm condition is present and is not acknowledged.
- ALM beacon on continuously = alarm has been acknowledged.

To Acknowledge an Alarm

Press  and  together.

Non-Latched Alarms

Alarm condition present when the alarm is acknowledged.

- ALM beacon on continuously.
- The alarm message(s) will continue to scroll.

This state will continue for as long as the alarm condition remains. When the alarm condition disappears all indication also disappears.

If the alarm condition disappears before it is acknowledged the alarm reset immediately.

5.5 Automatic Air Purge Operation (Start-Up)

All systems with this controller are equipped with our auto-air purge function, it is factory set for five (5) minutes. When the system is started, the controller will operate a timer for five (5) minutes. The controller should be set at the minimum temperature, and the scrolling text will read "Auto Air Purge." OP4 and Run will illuminate on the controller. The system should automatically be purged of air at the end of the five (5) minute timer. If pressure gauges are still erratic or air appears to still be present, refer to Section 5.6 for restarting the automatic air purge timer.

Adjusting Auto Air Purge Timer (Factory Default Set for 5 Minutes)







- Press scroll button, toggling until you see the parameter DWELL.
- Using the arrow keys, change to desired setting
- The DWELL parameter relates to time in minutes. (The amount of time it will take to purge your process loop will be affected by the size of the loop and the backpressure on your drain.)
- Wait for the display to flash.
- Press Page button.
- Unit will return back to the normal user screen.

Symbols:

	Page button
	Scroll button
	Down button
	Up button

5.6 Restarting the Automatic Air Purge Timer (After Start-Up)

After the original start-up of the system (Section 5.5), you can Run, Hold, or End the automatic air purge timer.

Operation	Action	Indication
To Run the timer	Press and quickly release  + 	Beacon - RUN = On OP4 = On Scrolling test display: "AUTO AIR PURGE"
To Hold the timer	Press and quickly release  + 	Beacon - RUN = Flashing OP4 = On Scrolling test display: "TIMER HOLD"
To End the timer	Press and hold  +  for more than 1 second	Beacon - RUN = Off OP4 = Off
	Timer has timed out (END state)	Beacon - RUN = Off OP4 = Off

5.7 Manual Air Purge Operation (After Start-Up)

There is a manual purge button that can be used after the Automatic Air Purge time has expired. This is a momentary push button.

5.8 Remote Setpoint and Retransmission "Scaling"

Scaling of the 4-20mA and 0-10V signals for this option are as follows:

- 4mA or 0V = minimum system operating temperature.
- 20mA or 5V, 10V = maximum system operating temperature.

Note: Maximum system operating temperature value is reflective of the series system purchased, (refer to serial tag for maximum operating temperature located on Mokon system).

Consult customer service at Mokon factory (716) 876-9951, regarding system's minimum and maximum temperatures if there are any questions.

Section 6 – Options

6.1 Process Purge Option (Reverse Flow Switch)

To facilitate mold changes with a minimum amount of oil loss from the hoses and the process, a reverse flow purge system is provided as an option. There will be a switch labeled "Process Purge" on the control plate if you have this option.

Note: If additional fluid has been added to the Mokon system after initial start-up, it will be necessary to drain the excess fluid prior to using the process purge as to avoid overflowing the reservoir tank.

The following is the procedure to utilize this process purge option:

- Turn the controller to the minimum setting and wait until the process temperature is below 130°F (54°C). (See Section 5 for Controller Instructions)
- Shut off the zone by pressing the "Stop" button.
- Turn the three position selector switch labeled "Process Purge" to the "Rev" position.
- Start the pump by pressing and holding in the "Start" button. The "Start" button must be pressed and held during the entire reverse purge sequence. The fluid in the process loop will be returned to the reservoir.
- Turn the pump off by releasing the "Start" button.
- Turn the three position selector switch to the forward position.
- Refer to Section 3.1 to restart the system.

Note: The time required to purge the system is based on the hold-up volume of the process.

6.2 Process Purge Option (Air Connections)

To facilitate mold changes with a minimum amount of oil loss from the hoses and the process, a process purge system via air is provided as an option.

Note: If additional fluid has been added to the Mokon system after initial start-up, it will be necessary to drain the excess fluid prior to using the process purge as to avoid overflowing the reservoir tank.

The following is the procedure to utilize this process purge option:

- Turn the controller to the minimum setting and wait until the process temperature is below 130°F (54°C). (See Section 5 for Controller Instructions)
- Shut off the zone by pressing the "Stop" button.
- Connect the Air Supply to the Air Inlet on the system.

Warning: Air supply pressure should not exceed 15 PSIG (103 kPa).

- Slowly open the steel gate valve located on the "To Process" connection on the system. The fluid in the process loop will be returned to the reservoir.
- Repeat steps 1 – 4 for each system.
- Refer to Section 3.1 to restart the system.

Note: The time required to purge the system is based on the hold-up volume of the process and the air supply to the system.

6.3 In-Line Heat Exchanger for Additional Cooling

- To achieve a lower “to process” fluid temperature. Mokon provides an option of installing a shell-and-tube heat exchanger directly in the “to process” line. This is to supplement the indirect cooling already provided by the cool-oil reservoir.
- The heat transfer fluid is allowed to flow through the exchanger constantly. A solenoid valve, cycled by the temperature controller, based on an “event”, controls the flow of cooling water.
- To prevent thermal shock, the cooling water is not allowed to flow through the heat exchanger until the oil temperature reaches 150°F (54°C) from a higher set point.
- The controller is programmed so that the “event” is not triggered on the ramp to set point. When the controller set point is lowered to 150°F (54°C) or lower, the cool-oil reservoir will be adequate to cool the fluid to 150°F (54°C). Once the 150°F (54°C) temperature is achieved, the controller will open the cooling water solenoid and control the process accordingly.

6.4 Cool Down and Automatic Shut Off

This option consists of an activation button labeled Auto Cool/Shutdown, a relay, and a timed relay.

To Enable This Feature:

While the unit is currently in operation, push the black button labeled Auto Cool/Shutdown. The machine will disable heating and start cooling for the preset amount of time. When the time runs out the machine will shut down.

If needed the machine can still be shut down by pressing the stop button.

A Timed Relay (TDR) mounted inside the machine’s electrical enclosure controls the amount of time the machine cools before shutting down. Rotating the dial on the front of the TDR can change the amount of time. The factory-preset time limit is 5 minutes; the adjustable range of the TDR is from zero to ten minutes.

Adjusting Auto Cool Down/Shutdown Timer

(Factory Default Set for 5 Minutes, Adjustable From 0 to 10 Minutes)

- Turn off machine.
- Locate the timer on the electrical subpanel.
- Refer to panel layout drawing for the particular machine, located in the door pocket. The Timer will be designated as auto cool/shutdown time delay relay.
- Turn adjustment dial on timer clockwise to increase time and counter-clockwise to decrease time.
- To determine the proper setting. Heat the machine up to operating temperature. Once you reach operating temperature, turn the set point down to the lowest setting. Start timing the cool down period; as soon as the unit reaches a temperature below 150°F (54°C) you can stop timing. The time you have recorded is where you want to set the auto cool timer to.

6.5 Emergency Stop

The emergency stop device will shut the machine down regardless of the operating mode. Once the emergency stop device has been activated, it must be disengaged by turning the button clockwise. Disengaging the emergency stop will not restart the machinery but only permit restarting.

- Per the risk assessment of the machine, the emergency stop is not wired to a safety rated relay.
- Do not wire additional safety components to the Mokon stop relay **or** modification of the emergency stop circuit is prohibited.

6.6 Valved Process Bypass

This option is simply a direct fluid path between the "TO" process line and the "FROM" process line that will allow you to bypass your process partially or completely via a metered globe valve on the outside back of the unit. This provides a means of controlling the amount of flow out to the process should you wish to reduce it from the normally full flow condition.

6.7 Low Fluid Level Shut Off

Per Section 2-5, on a standard system, a minimum operating fluid level of $\frac{1}{2}$ full is recommended (optimum fluid level is $\frac{3}{4}$ full). If this is not maintained, serious damage to the unit can occur. Every unit contains a sight glass for the user to visually monitor this level requirement however, the low fluid level shut off option provides, via a level switch within the reservoir, an extra means of ensuring that damage to the unit does not occur if the fluid level falls below the required amount. In this instance, the unit will shut off until the reservoir has been filled to the correct level. Upon this re-filling, the unit must again, be manually re-started.

6.8 Heating Only

This option removes the cooling circuit (heat exchanger, cooling solenoid, and associated plumbing) from the design of the system. There will be no water connections.

Section 7 – Troubleshooting Guide

Problem	Possible Cause	Corrective Measure
System will not start	System unplugged / power off	Plug system in / turn power on
	Improper power source wiring	Check wiring (electrical schematics) and correct
	Blown fuse at power supply	Isolate open fuse and replace
	Blown control circuit fuse	Replace and check for ground condition
	Low voltage	Measure incoming voltage, if too low correct
	High temperature safety switch	Consult factory
	Process purge switch (if supplied) in neutral position	Switch to "Forward" or "Reverse"
Running pilot does not go on	System unplugged / power off	Plug system in / turn power on
	Blown fuse at power supply	Isolate open fuse and replace
	Blown control circuit fuse	Replace and check for ground condition
	Bulb burn out	Replace bulb
System runs momentarily	High temperature safety switch	Consult factory
	Motor starter thermal overloads tripped due to motor overload	Consult factory
Pressure will no build up	Incorrect pump location	See Section 3.1 to check and correct motor rotation
	Entrapped air	See Section 3.1
	Pump relief valve stuck open	Consult factory
	Inadequate fluid level	Check that sight glass reads at least ½ full, if not add fluid
	No fluid in the pump	Prime the pump
Pressure surges erratically and system will not hold temperature	Entrapped air	See Section 3.1
	Inadequate fluid level	Check that sight glass reads at least ½ full, if not add fluid
	Suction line leak	Repair leak
	Contaminated fluid	Drain and replace fluid

Problem	Possible Cause	Corrective Measure
Extreme pressure build up	Plugged flow paths, inadequate circulation through process and connecting lines	Inspect; if plugged, dislodge
		Clean strainers
High pressure and erratic temperature	Plugged flow paths, inadequate circulation through process and connecting lines	Inspect; if plugged, dislodge
		Clean strainers
Loss of pressure and volume output	Entrapped air	See Section 3.1
	Pressure gauges	Inspect/replace component
	Inadequate fluid level	Check that sight glass reads at least ½ full, if not add fluid
	Cooling valve	Inspect/replace component
Temperature climbs beyond setpoint	Pump relief valve stuck open	Consult factory
	Heater contactor	Inspect/replace component
	Temperature controller	Inspect/replace component
	Thermocouple or RTD	Inspect/replace component
System does not reach and/or hold temperature or slow response after changing temperature setting	Controller calibration	See Controller Section 5
	Contaminated fluid	Drain/replace fluid
	Heater burn out	Inspect/replace component
	Temperature controller	Inspect/replace component
	Kilowatt capacity inadequate	Consult Mokon engineering
	Loose electrical connections	Tighten connection or replace broken wires
	Thermocouple or RTD	Inspect/replace component
	Controller calibration	See Section 5
	Cooling valve stuck open	Consult factory
Variance in temperature readings	Plugged flow paths, inadequate circulation through process and connecting lines	Inspect; if plugged, dislodge
		Clean strainers
	Contaminated fluid	Drain and replace fluid
	Kilowatt capacity inadequate	Consult Mokon engineering
Reservoir tank overheating	Inadequate fluid level	Check that sight glass reads at least ½ full, if not add fluid
	Water not flowing through heat exchanger	Consult factory
	Cooling valve stuck open	Consult factory
	Relief valve stuck open	Inspect/replace component

Problem	Possible Cause	Corrective Measure
Noisy pump	Entrapped air	See Section 3.1
	Pump needs alignment	See Section 4.2
	Worn coupling and/or grommet between pump and motor	Inspect/replace component
	Worn bearing on pump	Inspect/replace component
	Leak on suction side of pump	Repair leak

Section 8 – Condensed Parts List

Part No.	Description
006396	Motor Starter 5 Amp Contactor 110V Coil
006257	40 Amp Heater Contactor 110V Coil
006400	0.9 – 1.3 Amp Overload (Refer to Motor Name Plate Information for
006402	1.4 – 2.0 Amp Overload Proper Overload)
008056	0 – 160 PSI Pressure Gauge (Glycerin)
011002	1 KW Steel Immersion Heater (For Systems 230 and 460 Volt)
011011	1 KW Steel Immersion Heater (For Systems 208 and 380 Volt)
011013	1 KW Steel Immersion Heater (For Systems 575 Volt)
022038	Start/Stop Button
022142	Low Pressure Safety Switch
023070	High Temperature Safety Switch (N.C.)
025432	Cooling Solenoid Valve
032091	Lipseal for H3 Model
032115	Lipseal for H2 Model
040002	Thermocouple

For additional part numbers refer to the specific section in the instruction manual or consult the Mokon factory (716) 876-9951.

Section 9 – Warranty

OIL SYSTEMS WARRANTY

All new temperature control systems manufactured by MOKON are guaranteed to be free from defective material or workmanship for a period of one (1) year from the date of purchase. All Standard Microprocessor controllers are covered by a five (5) year warranty, Microprocessors with special features are covered by a three (3) year warranty and Solid State controllers are covered by a one (1) year warranty. MOKON'S obligation under the WARRANTY SHALL BE LIMITED, TO THE ORIGINAL CUSTOMER, TO REPAIR OR REPLACE DEFECTIVE PART(S) OF THE TEMPERATURE CONTROL SYSTEM, UPON CUSTOMERS COMPLIANCE WITH THE INSTRUCTIONS CONTAINED HEREIN. Upon discovery of any alleged defect, it is the responsibility of the customer to contact the MOKON Service Department with the complete model number, serial number and the date of purchase. MOKON'S obligation under this warranty is limited to make good, from or at its factory, any parts that are returned to the company (prepaid) and deemed to defective, within the time frame of the warranty. The customer also has the option of forwarding the system to MOKON (Buffalo, NY), prepaid by the customer and with a return authorization from MOKON for inspection and component replacement or repair. Repair or replacement in any manner provided above shall constitute a fulfillment of all liabilities of MOKON concerning the quality of the temperature control system.

No allowances, credits or reimbursements will be made for any replacement or repair made or provided for by the customer unless authorized in advance, in writing, by MOKON.

Note: The use of any heat transfer fluid other than the ones recommended in the instruction manual or approved by Mokon in writing, may void your warranty. Consult the Mokon service department with questions on fluid selection.

The warranty set forth above is in lieu of any and all other warranties expressed or implied including warranties of merchantability and fitness for a particular purpose. Mokon shall in no event be liable for any consequential damages or for any breach of warranty in an amount exceeding the original price of the unit.

Mokon's products are not guaranteed against damage caused by corrosion.

End of Life Industrial Waste - Saving our Environment

In the interest of preserving our environment, please reclaim, reuse or dispose of any refrigerant, refrigerant oils, heat transfer fluid, glycol and/or water glycol mixtures contained in these systems in accordance with federal, state and local codes, prior to any equipment disposal. All metal and other materials should be repurposed and recycled where possible.



2150 Elmwood Avenue - Buffalo, NY 14207
P# 716-876-9951 - F#716-874-8048 - www.mokon.com