

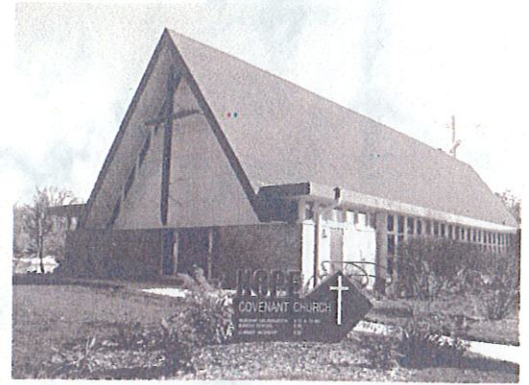

*This year*



## *Hope Covenant*

*Celebrates our 125th Anniversary*

*You are cordially invited to join us for these special events.*

*April 6-7 Sunday at 8:15am and 10:45am*

*Former Pastor Rick Mylander will be sharing with us at both worship services and Sunday School Hour. He will also share on Sunday evening from 4-9pm at Habits of the Heart Seminar. Monday evening 6:30-9:30pm continues with Habits of the Heart.*

*July 20 Sunday at 9:30am*

*Our 125th Celebration Worship Service and Picnic in the Park at Wilson Park with former pastors sharing.*

*October 25 Saturday at 6 pm*

*Swedish Smorgasborg and Celebration Program*

*Please mark your calendar and invite others the Lord brings to mind.*

*If you can't attend please drop us a note.*

*We'd love to hear what the Lord is doing in your life.*

*Hope Covenant Church 336 4th Avenue South, St. Cloud, MN 56301*

*Church Phone # 320-257-HOPE (4675)*

125 Year Celebration of Hope Covenant Church  
1883-2008



Swedish Church of God

In 1883 the “first” church building for us was located on top of “Swedish Hill” at 204 5<sup>th</sup> Avenue South in Sauk Rapids. The building was 26 x 36. The lot next door was also purchased.

Many people were generous in making donations.



Present Facility of Hope Covenant Church.  
This building on the south side of St. Cloud at 336 4<sup>th</sup> Avenue South was purchased in 1995. Today many young families call Hope their church home.

# 125<sup>th</sup> Anniversary Celebration Begins

Saturday evening  
October 25 at 6 pm

Come, hear sharing by Wes Olson, Rick Mylander,  
Priscilla Mohrenweiser, and Jim Fretheim.  
We'll also hear more of August B. Anderson's story.

Swedish Smorgasbord will follow



The celebration continues on  
**Sunday, October 26**  
with one worship service at  
**10:45 am.**

Immediately following worship,  
stay and enjoy some samples  
from our cookbook at the

**“Taste of Hope” Gathering**

Cookbooks will be available.  
Invite family & friends to the “Taste”

# 125th Worship in the Park July 20, 2009



H. H. H. H.

Have He/Had Helped  
Theodore W. Anderson  
Theodore W. Anderson  
Theodore W. Anderson





Years of God's Faithfulness at

Hope

Guests this weekend

Name	Address
Barb Kaasa	7413 Lane Aven Brooklyn Park, MN 55443
Lori Kluball @ Ella	
Bev + Ralph Kluball	
Jae + Peggy Guzzardo	
Ashley + Isaac	2911 Maple Prairie Rd #110 St. Cloud, MN 56301
Diane DeLemson	128 IV 33rd Ave SC MN 56303
Pat + Lila Donlin	C.S.
Jack Forsell	St Joseph
Audrey Kambhankal	St. Cloud
Dan Kappel	St. Cloud,
Bernie Wagon	St. Cloud,
Jusadhuweke	Sauk Rapids

125th Anniversary Celebration

October 25, 2008

125

Years of God's Faithfulness at

Hope

Guests this weekend

Name	Address
John + Joanne Reinhart	Hank Rapids
Priscilla Mohrweiser	Golden Valley
Kerry + Joey Klarich	St. Cloud
Dale + Shirley Hubert	St. Cloud
David <sup>AND</sup> Quinn Johnson	Clearwater
Rich + Heidi Mylander	Castle Rock Colorado
Linda Jensen	St. Cloud
Beverly + Ralph Klubaal	St. Cloud
Harriet and Wes Olson	Dassel, MN
Tom and Jan Borger-NEMEN	Anna + Krios St. Cloud
DONT EUNICE Sankay	St. Cloud
Jan "Andy" Anderson	Clearwater

125th Anniversary Celebration

October 25, 2008

125

Years of God's Faithfulness at

Hope

Guests this weekend

Name	Address
Rich & Nancy Sundheim	St. Cloud
Jenni & Ben Schemelin	Mound, MN
Debra Johnson	St. Cloud
Debbie + Phil Godding	St. Cloud
Mich Godding	St. Cloud
Mark Abramson	Sartell
David & Cynthia Mehores	St. Cloud
Anne Nord	St. Cloud
Matt & Sandy	St. Cloud
Yvonne Lueser	Shelburne
Bill Delaney	Sank Rapids
Marty & Julie Toole	Sartell

125th Anniversary Celebration

October 25, 2008



Years of God's Faithfulness at

Hope

Guests this weekend

Name

Address

Sandy Hopkins  
New Hope

Sauk Rapids

Todd & Lisa Miron

Nathan: Amanda Bruno

St. Cloud

Luigi + Steve Sands

Sartell

Steve & Bev Setlow

St Cloud

Kristen Wagenius (Reuben & Henry)

since 2004

125th Anniversary Celebration

October 25, 2008



Years of God's Faithfulness at

Hope

Guests this weekend

Name

Address

Keith & Jan Olson

St. Cloud

Jeff & Ben Loewen

& Erik Stromberg

Poley, MN

Rose & Jerry Hornel

St. Joe

Gabe A.

Matthew H.

Jason R. + Abbey M.

Mound / Maplewood

Paul & Steve Schirmer

Jessica August Stella Althea Kerwin

St. Cloud

125th Anniversary Celebration

October 25, 2008



Years of God's Faithfulness at

Hope

Guests this weekend

Name	Address
Leon Reinig	Sartell, MN
Mavis Fast	St Cloud Mn
Roxie Fast	St. Cloud, MN
Jim Fontaine	St Cloud Mn
Jill Ness	Sault Rapids, Minn.
Karen & Sunny Witzgma	St Cloud, MN
Janelle Larson	Baxter, MN
Carrie & Isabelle Owens	Breezy Point, MN
Maria Beckman	Dassel, MN
Ryan, Annie, Logan & Kira Salper	St Cloud, MN
Lowell & Cheryl Larson	Clearwater, MN
Steve & Sherry Sorsvold	St Cloud

125th Anniversary Celebration

October 25, 2008

125

years of God's Faithfulness at

Hope

Guests this weekend

Name

Address

Elaine Abendroth

Clearwater

Jim & Jeanette DeRose

Richmond, MN

Tracy & Roger Erickson

St. Cloud

Keith & Beth Kneeger

St. Cloud

Arlen & Ruth Johnson

Waits Park

Cindy and Bob Koubsky

St. Cloud

Ken and Jan Panger

St. Cloud

Bob & Tammy Springer (Andrew & Aaron)

South Rapids

Harold & Elizabeth Keith

St. Cloud

Marshall & Lois Engerich

Marit Isaac

ST Cloud

Jan & Bill Stille

De Lindy

South Rapids

Martha & Ray Roth

St. Cloud, MN

125th Anniversary Celebration

October 25, 2008



Sharing ~

Priscilla Mohrenweiser

MC & Song Leader  
Lowell Larson

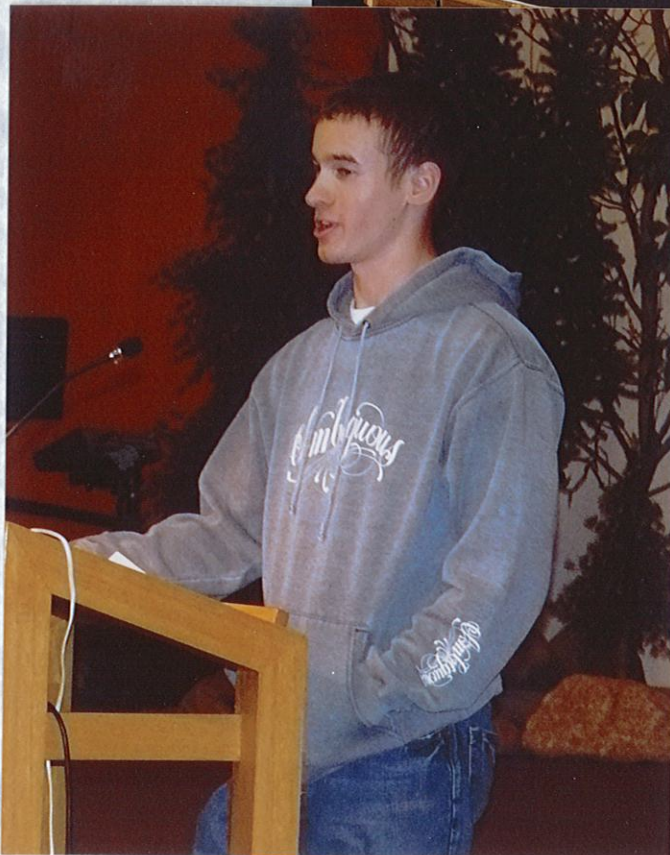
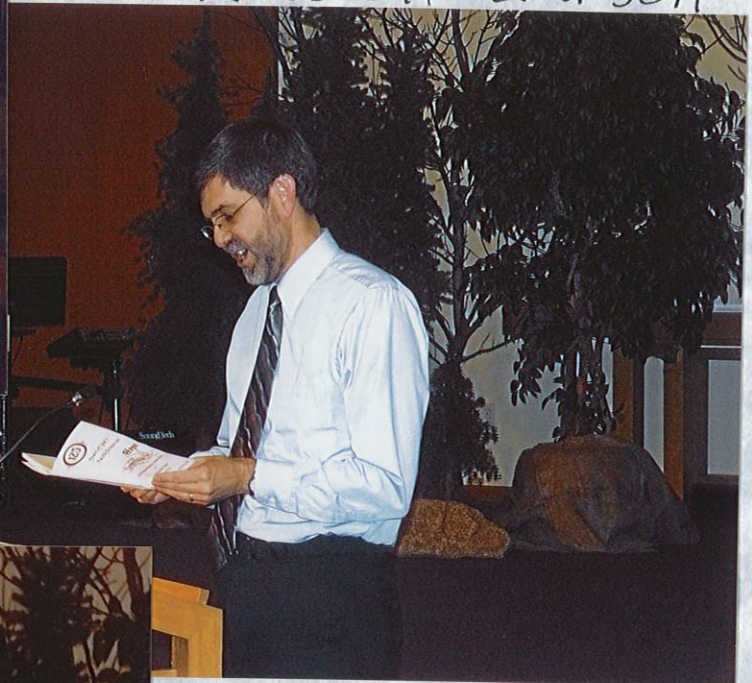

Jason Reinhart



Karen Witzman  
read a letter  
from Pastor  
Dave Erickson

Men's Quartet



Lowell Larson  
Steve Schirmers  
Roger Eriksson  
Dale Hubert



"I Remember..."

Joey Klarich

Steve Sands read a letter from Bob Anderson

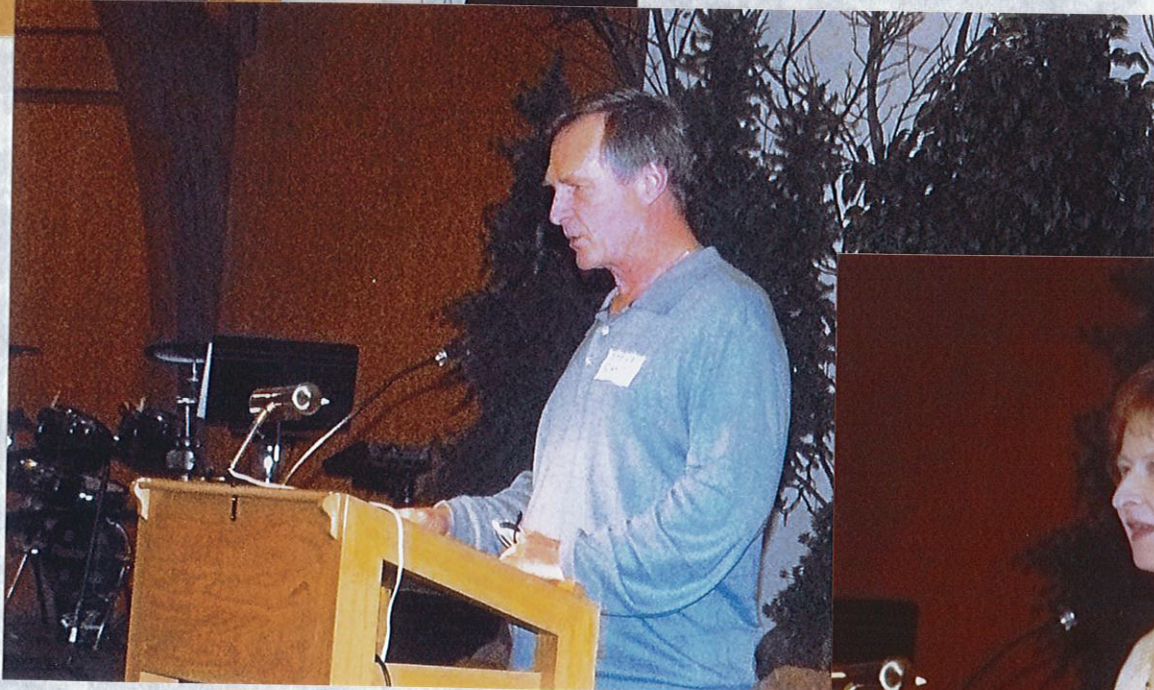

Jeanette DeRose

# PASTOR'S Sharing

Wes Olson

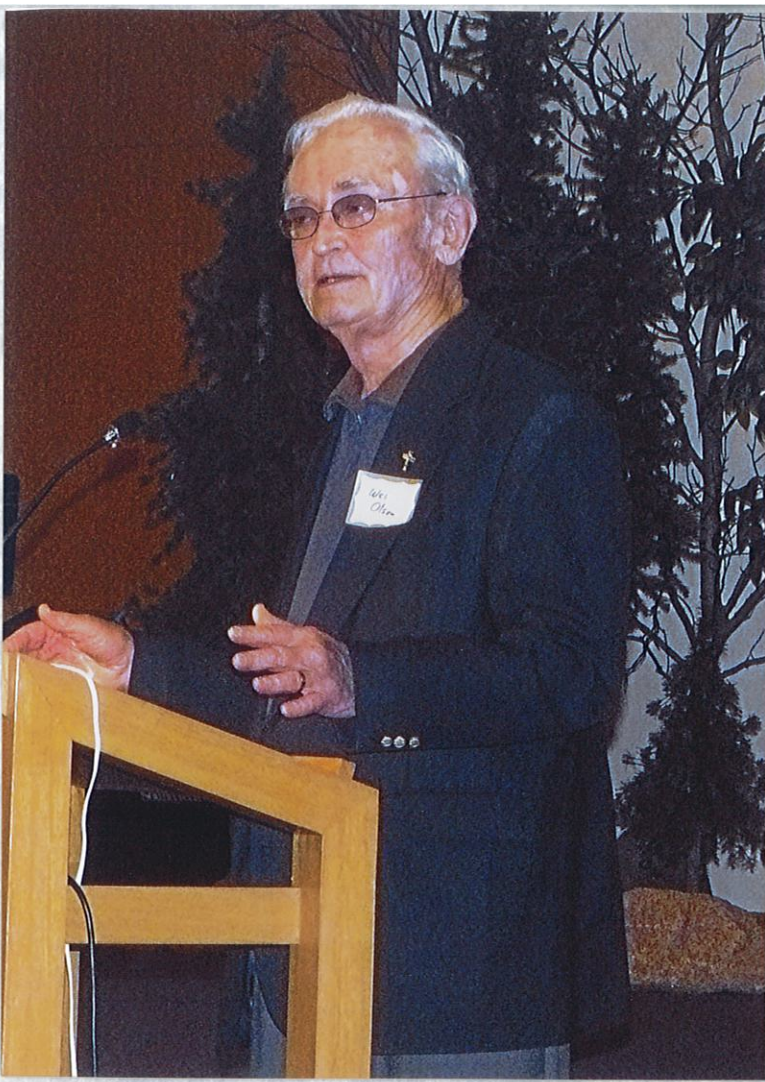

Rick Mylander

Jim  
Fretheim



*Sandy Dopkins recaps with us  
details of the August B. Anderson  
Memoirs that we heard at our  
Wilson Park worship on July 20<sup>th</sup>.*

*His story continues...*



# August B. Anderson Story. . . A drama



. . . at  
the  
train  
station.





**Amanda & Nathan Bruno**

**Bob Springer**

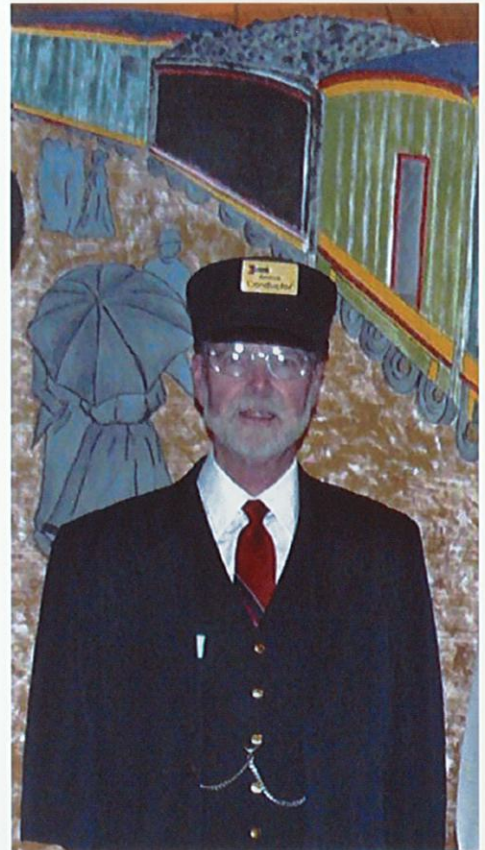

**Jacob Borgenheimer & Maja Noble**



**Sandy, Anna & Jen**



**Bob & Sandy Dopkins**  
**Set designers, script writers,**  
**actors, directors**





**Jacob, Jen & Anna Borgenheimer**

**The Drama Team of August B. Anderson Story**





Lowell & Cheryl  
Larson  
lead us in song.



The past  
&  
the present  
sing  
to  
God



Jacob, Jen, Anna  
Borgenheimer  
Bob Springer  
Nathan & Amanda  
Bruno  
Maja Noble  
Bob & Sandy  
Dopkins



Thank you  
Pam



# Swedish Smorgasbord Menu



Swedish Meatballs  
Swedish Potato Sausage  
Bruna Bonor Brown Beans  
Split Pea Soup  
Swedish Knackebrod (Hardtack)  
Bond Ost (Cheeses)  
Deviled Eggs  
Pickled Herring  
Pickled Beets  
Cardamom Bread  
Swedish Limpa Bread  
Lefse  
Rice Pudding  
Lingenberries  
Almond Cake  
Cookies





The  
Kitchen  
Crew

Yvonne Lunser  
Jill Nessa  
Linda Dunne



Wes & Harriet Olson



Loves of Picnic  
 Summer  
 Fun +  
 Fellowship

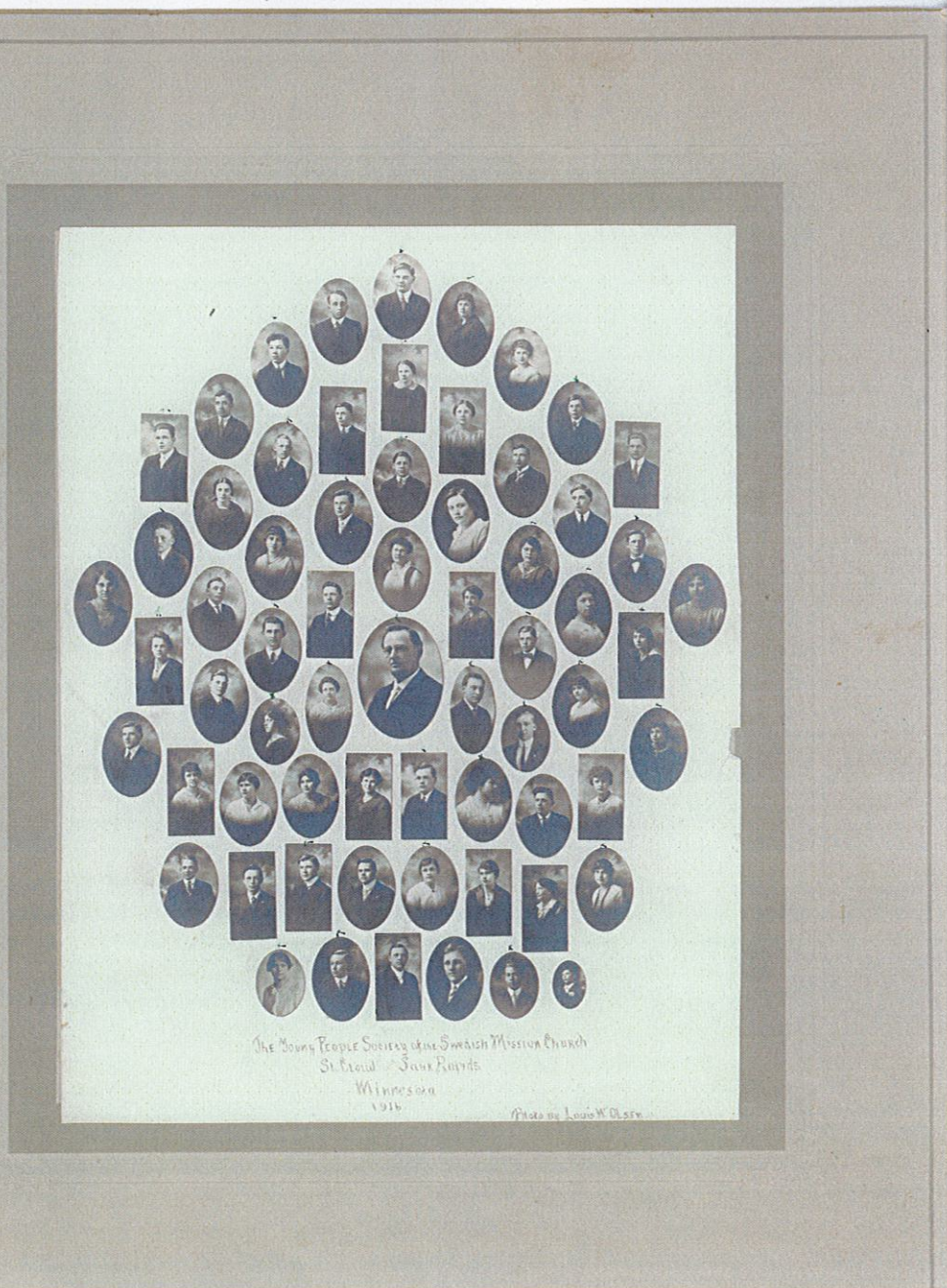

# **OPEN LETTER TO MY CHURCH FAMILY AT HOPE COVENANT CHURCH**

Nancy N. Fitch  
ABOUT 1984

It was thirteen years ago, when we decided to move to St. Cloud, Minnesota. At that time we prayed that we would find a church where we would be accepted as a family. For some that might sound like an unusual prayer, but we were not the ordinary family.

We brought three normal healthy children who were ours by birth with us. A tiny baby who was blind, developmentally delayed, cerebrally palsied, and breathed with a tracheotomy, was also part of our family. Her breathing was so noisy that she often sounded like each breath might be the last. We brought a little Jewish girl with dark sparkly eyes and beautiful dark curly hair. She was autistic and lived in her own world where no one else was allowed to enter. Her hyperactivity made a whirlwind seem like a gentle summer breeze. Rounding out our family was Tom, a nine-year-old Down's Syndrome boy, who had very little speech, but a great desire to communicate, he needed lots of love and attention. These children were our long term Foster Children.

The first Sunday in town we attended your church, The Evangelical Covenant Church, on the East side of Saint Cloud. We were immediately welcomed and loved by your congregation. You not only accepted us, you took us in, loved us and made each of us feel like part of you. During that thirteen years we have been in and out of the Church three times for various reasons. Each time we were accepted back with open arms and a great love, with no questions asked. Each time we have learned to love you more.

We have been through many things together. Your people helped us move both our business and our home, and then you helped us move again, when we had to relocate our business to larger quarters. I have had major surgery and a heart problem, and someone was always there, with prayer, food and help. We have had more than twenty Foster Children come and go and you laughed with us when they came and cried with us when they left. You saw us through the tragic deaths of two of our Foster Children. We felt your prayers when we were tried for negligence because of the drowning death of one of the children, and you and the community rejoiced with us as the verdict of innocent was returned.

Our marriage has grown more stable, our children have grown and love us, we have four Foster Children who desperately need us, our needs have always been met and also many of our wants. We have had many honors bestowed on us. I have had the chance to give my testimony in places that Pastor Rick would never be asked to speak. Life has been good and we have been part of the family of God worshipping with you.

This past week has again been a rough one for us. On Monday I found that in spite of surgery and much prayer, our foster daughter, Kim's vision has worsened to the point that the doctor

feels she is totally blind, probably not even seeing light from dark. It was just two years ago when a needed surgery took her mobility from her. It is dreadfully hard to see her deteriorate in health and abilities. Our business has struggled from the beginning and a buyer has appeared, and we feel that it is time for us to be relieved of that stress, and as of the first of March it looks like we will be looking for new horizons in the job area.

A little over a week ago our daughter was overcome with loneliness and depression and made a serious attempt to take her own life. I stand here today in need of your support and your prayers. We know you have always stood with us, and will not fail us now. Ray and I have both grown in spiritual maturity, until the problems even though overwhelming at times, shrink to nothing in perspective to God's love and caring for us.

During the last week many of the verses from the eighteenth chapter of Psalms have been meaningful to me. In these verses God is referred to as "My Fort where I can enter and be safe." They tell me he will hold me steady and that he delights in me. He watches every step, He is perfect, His promises are true, His salvation is my shield, His right hand supports me and His gentleness has made me great.

During our times of struggle God has always been there showing us His goodness, through the love of Christian Friends. This week when things were very bleak and the load was especially heavy for us, I received a phone call from Pastor Rick. He had good news for us. Someone had donated a hydraulic wheel chair lift for our van, anonymously, in response to the Christmas article in the paper about our family. As of next week bringing our three wheelchair bound young adults into God's house to worship will not be nearly as difficult and you will not see us lifting them and their chairs anymore.

I strongly suspect that the giver was one or more of you, our Christian family. I would like to thank you for that. This was no small gift. The cost will be close to two-thousand, five hundred dollars. The thoughtfulness of the gift is overwhelming, and I pray that we are worthy of that thoughtfulness.

The lift will be much appreciated and I can hardly wait to use it. Every time I use it, I will be reminded of the love of God that comes strong and clear through the unselfish giving of each of you. Thank you for being here in good times as well as bad.

Thank you for letting us see Christ through your love for Ray and I, and our family.

Psalms 18:46 says "God is alive! Praise Him who is the Rock of Protection!" I praise Him today for a church family who show us so vividly that God is alive today. We are proud and happy to be a part of this sharing caring church. We are indeed a part of the Family of God.

With much love and appreciation, for each one of you. Nancy and Ray Fitch and family

# HILDA, FRIEND OF THE NEEDY

WRITTEN BY

NANCY N. FITCH

PUBLISHED IN THE 1980s' IN THE IN-SPRIT MAGAZINE

A PUBLICATION OF THE COVENANT WOMEN'S ORGANIZATION

In the city of St. Cloud, Minnesota, there was a woman named Hilda, a believer, who was always doing kind things for others, especially the poor. It has come to pass that today Hilda is ill and no longer able to sit for long hours at her sewing machine, sewing for the needy. Her friends and family gather around her and care for her, trying to make her comfortable, as she has comforted many of them, with her prayers, a cheery note or a phone call, in the past. And forasmuch as the church is nearby, they asked for prayer over the prayer chain, and the congregation prayed with all their might, Christ heard and came to Hilda with his mighty comforting power. When Christ came, he saw children from Africa, and the Tennessee Mountains, the Minnesota Indian Reservations and St. Cloud all wearing garments that Hilda had sewed for them. There were dresses and pants and mittens and shirts, some had their wounds wrapped in bandages, she had rolled, and there were Doctors, using surgical towels and other medical supplies that Hilda had provided for them. Christ gave her his hand and lifted her up, and it was known throughout all St. Cloud, Minnesota and the world, and many believed in the Lord. [Paraphrased from the story of Dorcas, Acts 9: 36-42.]



Hilda is not a lady of means. She just uses every talent and gift that God has given her, to bring honor and glory to Him. She truly believes "whatever ye do, do with all your might, as unto the Lord."

Hilda was born to Swedish parents January fourth, nineteen hundred-five. She was raised in the plains of North Dakota. Her family was poor by today's financial standards, but had wealth untold, because of the love that abounded in their home. She tells story after story of her father, carrying the children on his shoulders, or holding them close and dancing in circles, as he sang, in Swedish, the hymns he loved so much. Her mother was not as demonstrative in her affection for her children, but was always there with many words of quiet wisdom as they grew to adulthood.

Hilda was about seven years old when her little sister died. The child was buried on the hill, by their farm. Hilda was very concerned that her sister would not have anything to play with in heaven. She found a few scraps of fabric, and made a small doll for her sister. She carefully placed it in a match-box, and joyfully carried it up the hill to the burial place of her sister. She dug a small grave and lovingly placed the doll in the grave, and asked Jesus to take it to her sister. The next day she wanted to go back, to see if Jesus had taken it, but her mother told her she must have faith and not go back. She never went back. She has often spoken of this event,

as the beginning of the strong faith she still has. She has faith Jesus will accept our gifts to Himself and to others, when given in simple child like trusting and with a humble heart.

Another story Hilda loves to tell about herself, and I love to hear is about the day she consecrated her life to Jesus. She had taken the train from her home into St. Cloud, for confirmation classes at the Covenant Church. This day the lesson was "Thou shalt have no other gods before Me." They talked about how other things, beside statues and idols could become gods, and sometimes money or good times or people could come before God, and then become gods. When Hilda left the church that day, she took the train back to Avon, When leaving the train she had a seven mile walk to her home. As she plodded along through the fields, and along the creek, the lesson about "other gods" was still strong in her mind. She was gripped with her desire to serve the one and only true God, Jesus Christ. It was on that walk home, she prayed and told God of her desire to follow Him and Him alone for her entire life. She prayed that she would never dishonor him by putting anything or any one before Him. Hilda was a runner, when young and I just have a feeling her heart was so light that she just skimmed the fields with her long slim legs, for the rest of the journey home. Anyone who has known Hilda for any length of time knows, she has kept her pledge, to serve God alone, until this very day.

Hilda had plans to become a nurse. She went off to school, but was soon called home to care for her ailing mother. Many years of her life were spent caring for her mother. Later she used her desire to care for people, as she worked as an aid in private homes and then as a nurses aid in a nursing home.

Hilda did not marry and have a family of her own, but has a larger family than anyone, as one by one she added nieces and nephews to her list of people adopted into her life and her family. She talks freely about her love for each of them, and she is as well acquainted with their joys and troubles as any mother would be, with the lives of their children. She also adopted the children in her trailer park as Grandchildren. They have come to her home daily for just one piece of candy, a hug, and a chance to visit, and hear of Hilda's love for Jesus. Whenever a group of mothers or grandmothers get together to swap stories of their children, and grandchildren, she never feels left out. Hilda has the largest family of anyone to talk about.

I first met Hilda fourteen years ago when I moved to St. Cloud. At that time she was retired from her secular job, but in no way retired from her work for the Lord. She now has more time than she ever had, to spend helping others. One of the first functions I attended at the Covenant Church was a Covenant Women's work day. Hilda was the organizer. She had quilts made and ready for others to tie, baby jackets and children's clothing sewed for others to hem or sew buttons, sheets were washed and torn into strips for the bandage rollers in the group. She has sewn hundreds of garments each year, and every month been ready for "work day." I have helped her for the last two years by mailing the boxes, she has filled with her love and caring. Every couple of weeks she would call, saying there was a box ready for the Tennessee Mountain Missions, or the Covenant Hospital in Zaire, of things ready to be taken to the Indian Reservation in northern Minnesota. Hilda's home became a collection place, and sorting center for used clothing and fabric. There was never an article that was given away without first being washed and pressed. She never had a car, so this involved carrying everything to the Laundromat, a block

from her home. After washing, each item was carefully checked over and seams were mended, broken zippers replaced, and missing buttons matched and then sewed on. Hilda would then decide, if the article could be best used locally, or should be sent to some other mission requesting that type of clothing. Everything was pressed and folded neatly, and packed into boxes, as she had loving visions of the family or group who might be using it. She liked to make bright colored baby jackets, because she could just “see” those little black faces peeking out of them. She never gave away anything she would have been ashamed to use herself. Even though she lives on a small pension, she always sacrifices enough to buy buttons, elastic, or filler, or fabric for the back of a quilt, so others would have the necessities of life. While watching television her hands are still busy knitting mittens. Many of the mittens are sold, to pay the postage on the other items she had made for distribution. She also beautifully canes chair bottoms and other pieces of furniture, and the proceeds will go to a local church project.

She arises early in the morning and spends time alone with God, reading scripture and praying. While she is still fresh, she goes about her ministry of encouraging others. She writes to anyone who is ill, or having problems. There are no age barriers on her friendships. She encourages the young with broken lives and dreams, as easily as she communicates with the elderly. She never condemns, even when life styles don’t match her own high standards. Like Jesus, she binds up wounds, and encourages people with the promise of God’s love for them. This love is so visible in Hilda, that is easy to come to a new and better understanding of Jesus, just by knowing her.

One night she awoke to the sounds of someone prowling outside of her window. She became very frightened, and then realized she had a very heavy vase by her bedside. She comforted herself, with the knowledge she could use the vase as a weapon. As she lay there she wondered where she was putting her trust. Was her trust in Jesus or the vase? In her heart she knew it was Jesus who would care for her. With the Bible promises as her refuge, she dozed off to sleep, with no further fears for her safety. Several month later, very early in the morning a young girl came knocking on her door, looking for a place to rest and a meal. She had been hitch-hiking and was very tired. Hilda quickly consulted with her Jesus, and the girl was invited to come into her home. As she lay on Hilda’s couch asleep, Hilda read her Bible nearby. When the girl awoke Hilda prepared breakfast for her. She sat down across from the girl and took both of her young hands in her own gnarled old hands. “Can I pray for you?” Hilda asked. The girl looked at her with a slight grin and responded “there is no way I could stop you, is there?” She knew that even if Hilda did not pray out loud, that she would be praying silently for her. Hilda did pray with her, and the girl left her home that day with much more than a little rest and a full stomach. She had seen real Christian love in action.

Hilda has been ill now for several months, and is living in a nursing home. She is not longer able to sew for the needy, or to write her letters of encouragement to others. However, her faith in God’s loving care is even stronger today, than it was the day she place the doll on the hillside for Jesus to take to her sister in heaven.

## **Addendum**

Hilda, never wanted to be dependant on anyone but the Lord. She passed away quietly in the nursing home, April 25, 1986 at the age of eighty-one years, three months and twenty-one days.

She had just used the last of her money to pay that months nursing home bill. She lived her life on earth frugally, but had sent her treasures ahead to her Heavenly home, where she now lives a life of luxury, walking the streets of gold, beside the crystal sea, where her mansion was prepared for her. I know that those things meant little to her on earth, and even less in heaven. Her life's purpose was to spend eternity with her Lord and Savior, Jesus Christ, who she met, as a young girl, in a field, somewhere near Avon, Minnesota.

My life has been richly blessed, by the great compassion, faith and wisdom, of Hilda. She is truly one of the "Saints I've known."



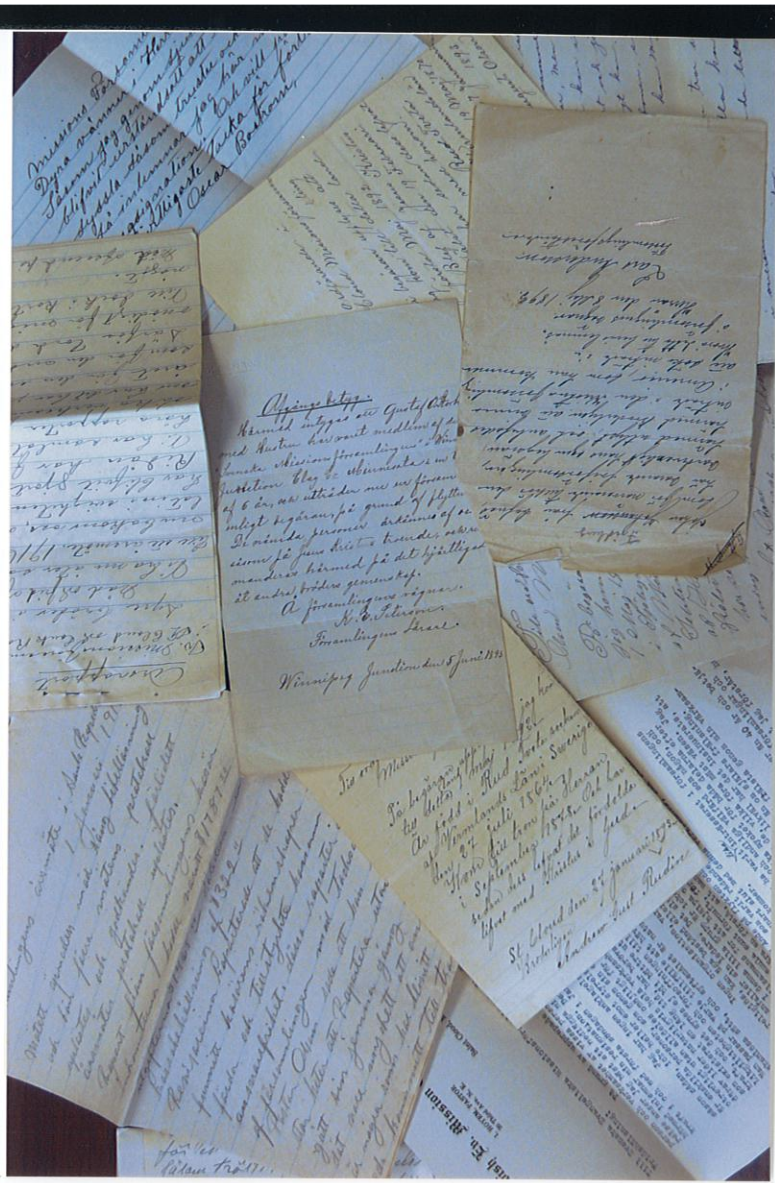



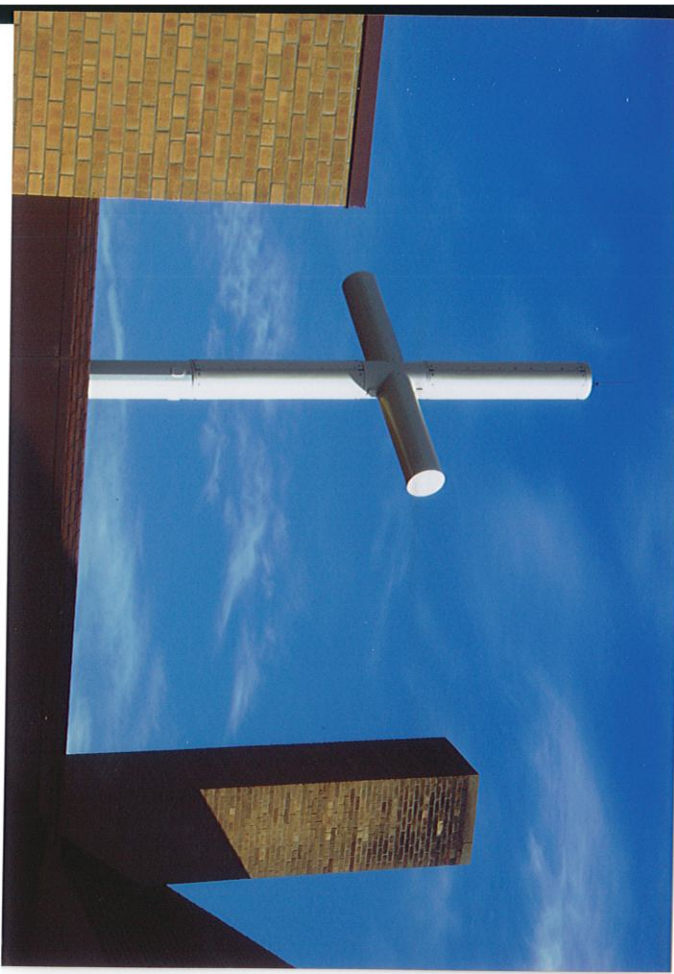







# The Archive Room



# The Archive Room



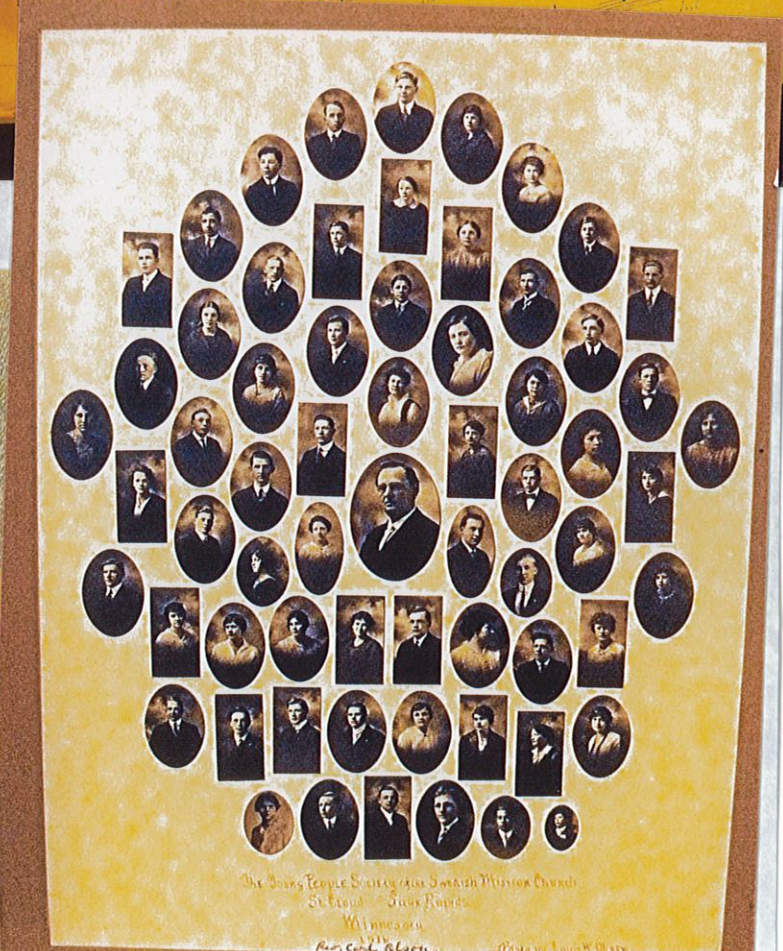
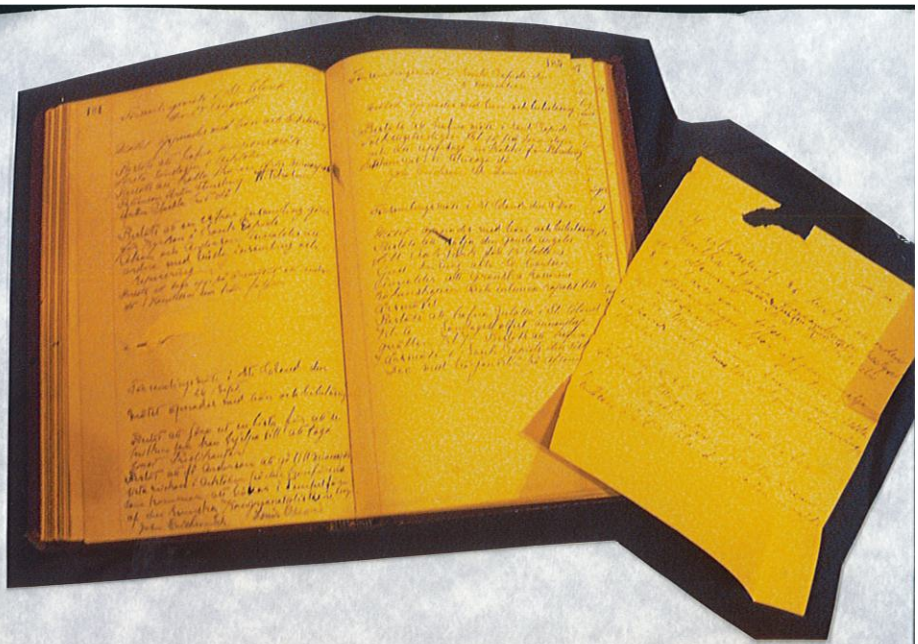

4/7/35

Församlingens affärs Möte den 27de  
 November 1935.  
 Sekulerarens protokoll för Mötet den 30de  
 oktober var uppläst och godkändas.  
 Det beslutades att hafva Julotta klubb  
 till på Juledags Morgonen.  
 Det beslutades att en kallad uppläsning på  
 Juledags Morgonen och öppnalamus till  
 läsningarna för behandling.  
 Det beslutades att hafva Hvar Nyårs Vaka,  
 börjande på kl 11:00 på Nyårs aftonen och  
 vaka in det Nyårs året med med bonemöte.  
 Det beslutades att församlingens arliga  
 affärs möte hållas den för Juledags kvällen  
 den 22 Jan. 1936. börjande klubb 7:0.  
 Det beslutades att församlingen godkänna  
 Långs-kallells beslut att hafva Jul program  
 på Långs kvällen den 22de Dec.  
 Lva revideras vora tillrättas att gränka  
 karens tankeskapen. Bealy treckig och  
 Ernst Sodergren vora tillrättas.  
 Pastar Storgren fögade huru mycket  
 församlingen skall begära för två veckans renter  
 för pastor bostället. Det beslutades att gifva  
 honom en Minnad för hvar renter.  
 Mötet avslutades med bön  
 E. J. Sodergren

1/3/36

The annual business meeting was held in  
 the church at 7:30 p.m. Jan. 2nd 1936.  
 The meeting was opened with song, scripture  
 reading and prayer.  
 The minutes of the last meeting were read and  
 approved.  
 The auditors reported that the treasurer's records  
 have been audited and correctly kept.  
 The treasurer Carl Johnson reported that the  
 receipts during 1935 were \$570.48 and  
 disbursed \$1462.37. Balance in the treasury  
 \$108.06. Since the audit \$5.00 has been received  
 making a treasury balance of \$113.06.  
 The auditor's report and the treasurer's report  
 were accepted.  
 Moved that no financial statements be printed  
 as in previous years.  
 A report was made by Mrs. John Frueberg  
 for the Deaconsess that the money turned  
 over to them at the beginning of the year has  
 been spent for various things taken to the  
 sick and needy; that all who have participated  
 of these things were thankful.  
 This report was accepted.  
 A report of Mrs. Carl Johnson the treasurer  
 of the Ladies Aid was given. Total receipts  
 \$401.13, disbursed \$338.10 during the year 1935. Balance

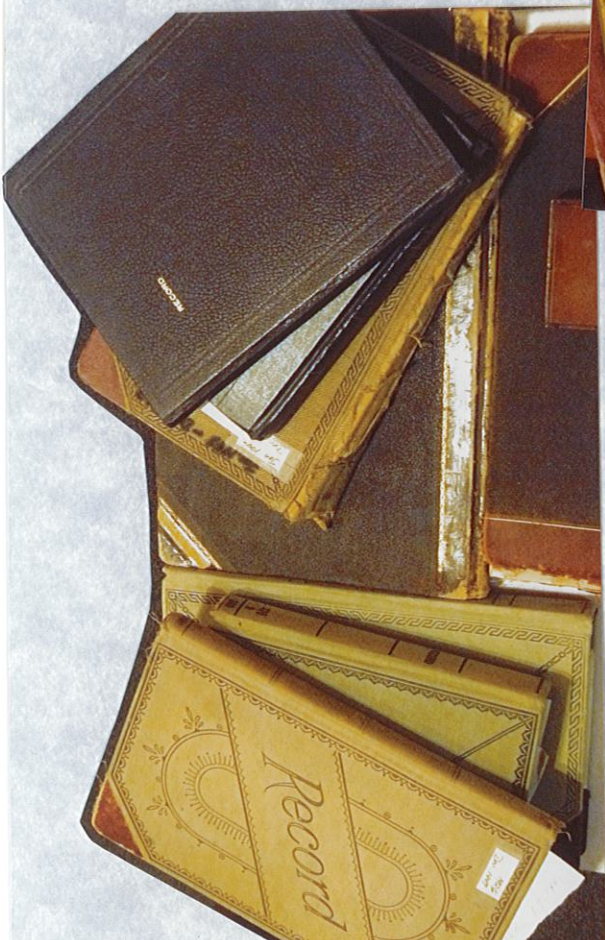

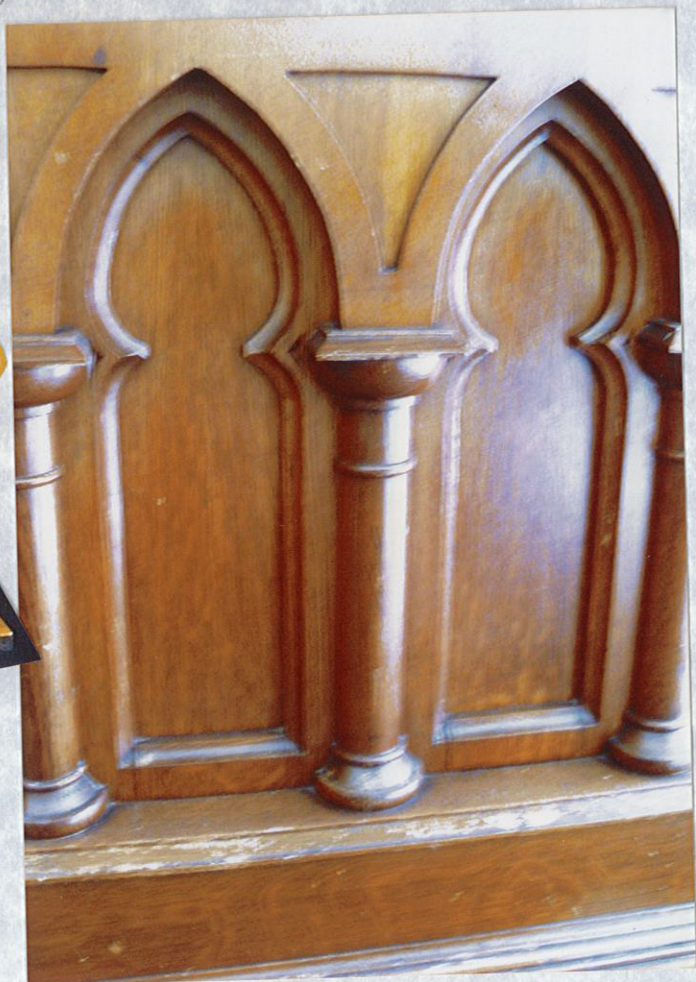
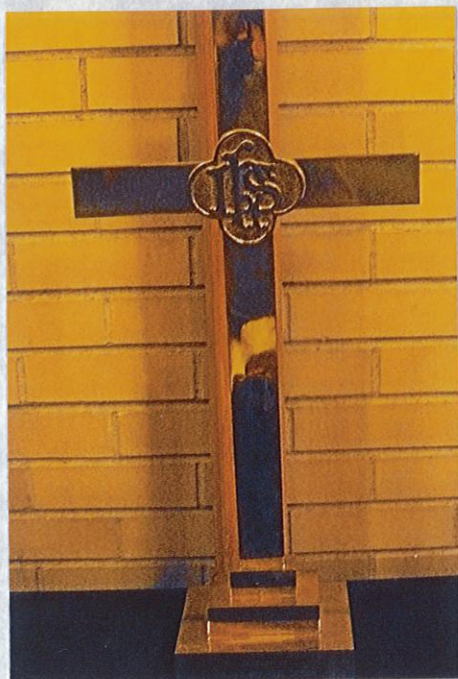
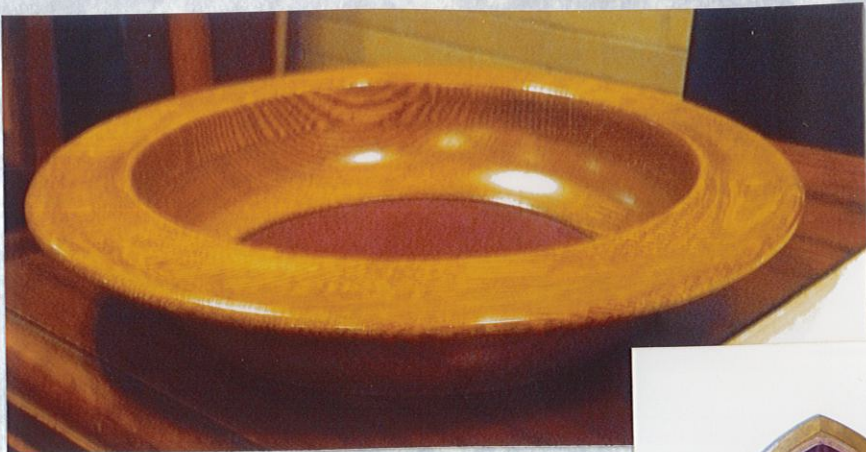





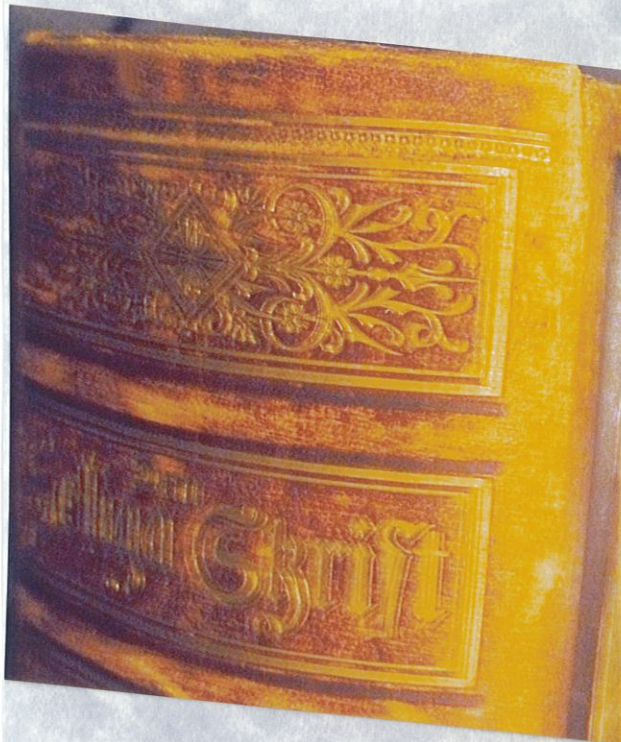

Lois Olson Pass Bok för  
 utbetalning till församlingen  
 1888

Jan 15	Lois Olson Månadsavgift	2 00
Feb 29	Lois Olson	2 00
March 14	Lois Olson	2 00
April 2	Lois Olson	6 00
" 23	" " Sopskiftepen	20 00
Nov 16	Lois Olson	5 00
" "	Lois Olson Månadsavgift	5 00
Dec 1889	Lois Olson	5 00
Jan 12	Lois Olson	2 00

for 1888

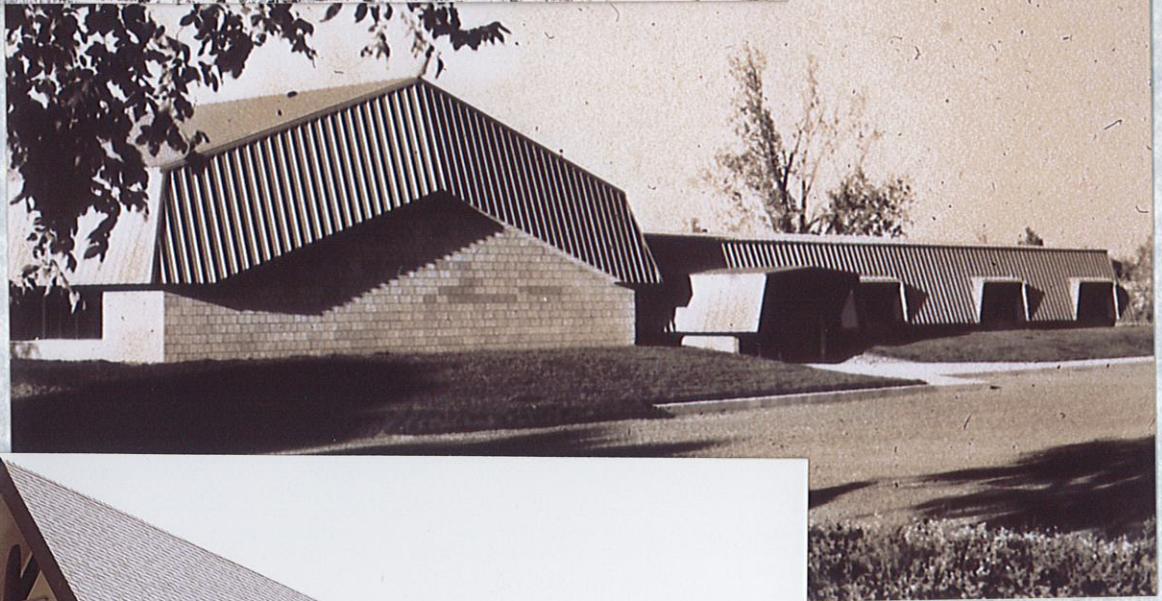

# Open Door Jail Retreat

Benton County Jail  
October 25-26, 2008



## Open Door Retreat Staff

Colin Akehurst

Darrell Armbrust

Kathy Armbrust

Pastor Tom Ervasti

Dave Fimrite

Ken Johnson

Eric Kerwin

Dan Kjorllen

Gloria Kuschel

Brad Martin

LuAnn Martin

Mike Noble

Dave Otto

Sheila Martin-Otto

Andy Ronnei

Paul Schmidtbauer

Mary Jo Wager

### Please be in prayer for:

the team members participating in this weekend retreat as we seek to share the Good News of Jesus.

the inmates who participate –  
that they will listen with open hearts  
and be willing to share as the Holy Spirit leads them.

wisdom for table leaders

strength and endurance

the binding of Satan

### God's Will to be glorified!

# from Pastor Bill

---

## Come Party with God at Hope's 125<sup>th</sup>

you are to **commemorate (remember)**; for the generations to come you **e (party)** it as a festival to the Lord--a lasting ordinance". **Exodus 12:14**

ests that God likes a party. Jesus attended a wedding party in Cana of ghout scripture God calls people to remember and celebrate. God gave the nds of reasons to party. He commanded them to celebrate: *the Feast of read, Feast of Tabernacles, the Feast of Harvest, and more.*

celebrate Christmas, Easter, Thanksgiving, Labor day, Memorial day. ate wedding anniversaries, birthdays, spiritual birthdays, etc. Celebrations good thing. It's God's idea; He wants us to commemorate (remember) and t He has done, what He is doing, and what He will do.

a special month in the life and history of Hope Covenant Church. We are a party and *commemorate* our last 125 years of existence as a church, and anniversary on **Saturday, October 25<sup>th</sup>**. We will look back and give thanks fulness, and we will, by faith, look forward to the generations to come, od will continue His good work in us that began in 1883.

emorate a man named August B. Anderson who knelt in prayer, struggling 'ding a vision of a church being planted on 'Swede Hill' in Sauk Rapids. We the many that have stood by that vision over the years to this present day ed Hope Covenant Church, at 336 4<sup>th</sup> Ave. So., St. Cloud, Minnesota. We arty!

wo mini-celebrations so far this year, but this month will be the grand ur superintendent of the Northwest Conference, *Jim Fretheim*, will be s at the Saturday evening celebration, along with Wes Olson, Rick Priscilla Mohrenweiser.

o party by *commemorating* and *celebrating* God's faithfulness to us over ars, with the hope that it will continue until the Lord comes. Please mark now so that you can be a part of this party with God and us at Hope, **ober 25, 2008.**

**Men's Muskie Retreat**  
coming up **October 9-11**  
For more details,  
Bob Koubsky 252-3842

### **Becky's Butterfly Brunch**

Saturday, Oct. 11

9:30 - 11:30 am

RSVP Becky at: 203-9288



# Notes from Kathy



## eb (dvd)

Classic tale gets a *Babe*-like  
*Charlotte's Web*, a delightful and well-  
 cota Fanning plays Fern, the young  
 rescues a runt, Wilbur, from death  
 every day at her Uncle Homer's  
 Wilbur's friendship with Charlotte (the  
 by Julia Roberts) that ultimately  
 the "smoke house" (a kid-friendly  
 to the slaughterhouse), for  
 nt for weaving praiseworthy words  
 to her web turns the Zuckerman  
 ist attraction. The more tragic  
 book are handled sensitively.

## h the King (dvd)

Biblical tale of Esther--a humble  
 saved her people from annihilation  
 part of the handsome Persian king  
 subject of *One Night with the King*.  
 with spark and confidence by  
 could perhaps be said to be the  
 nan to "have it all"--while also  
 ple, and God. The film, shot on  
 a, has the feel of the great epics of  
 sation underscored by the  
 small but pivotal roles, of both  
 d Peter O'Toole. But the film  
 willful Esther, who navigates among  
 persecution, and terror with the  
 wing she's serving the Lord, and

## being called?

hat 20 people of Hope Covenant  
 ed in the three Guatemala Stove  
 ome have gone more than once.  
 : Ken Johnson, Dave and Audrey  
 laquel Reep, Laurie Summerland,  
 Johnson, Jim and Lois Weeks,  
 ast, Gary Noble, Chris Monroe,  
 ott Bjorklund, Steve and Suzie  
 arstad, Cindy Koubsky, Keith and  
 We still have some space for the  
 p. Act soon!

# MISSIONS CORNER

*In focus this month:*



**Campus Crusade** for Christ

**Founders: Bill & Vonette Bright**

**Origins: 1951 UCLA Campus**

Called by God to "Reach the campus today, reach the world tomorrow".

Campus Crusade is a worldwide ministry of evangelism and discipleship. Some of the hallmarks of Campus Crusade include taking the initiative in evangelism to all who will listen, discipling men and women to be laborers for Christ, easy transference of Biblical concepts to help facilitate this discipleship, and challenging everyone to go to the world with the message of Christ.

Crusade works with others in the body of Christ in order to "build spiritual movements everywhere, so that everyone knows someone who truly follows Jesus."

Here at SCSU, Crusade has existed for more than 30 years, and has sent hundreds to reach the world with the gospel message.

Other Crusade ministries you may have heard of include: FamilyLife, Josh McDowell Ministries, the JesusFilm project, and Athletes In Action.

Current Director @ SCSU:  
**Patrick Schleper**

Mid-MN Campus Crusade for Christ

[www.EveryStCloudStudent.com](http://www.EveryStCloudStudent.com)

[www.scsucru.com](http://www.scsucru.com)



**Prizes for all**



**s Pederson (former Youth Pastor**



**125th Planning Team**



**Karen Witzman sharing**



**Chris Pederson (former Youth Pastor**



**Prizes for all**



**Chris Pederson (former Youth Pastor)**



**Prizes for all**



**Karen Witzman sharing**



**25th Planning Team**

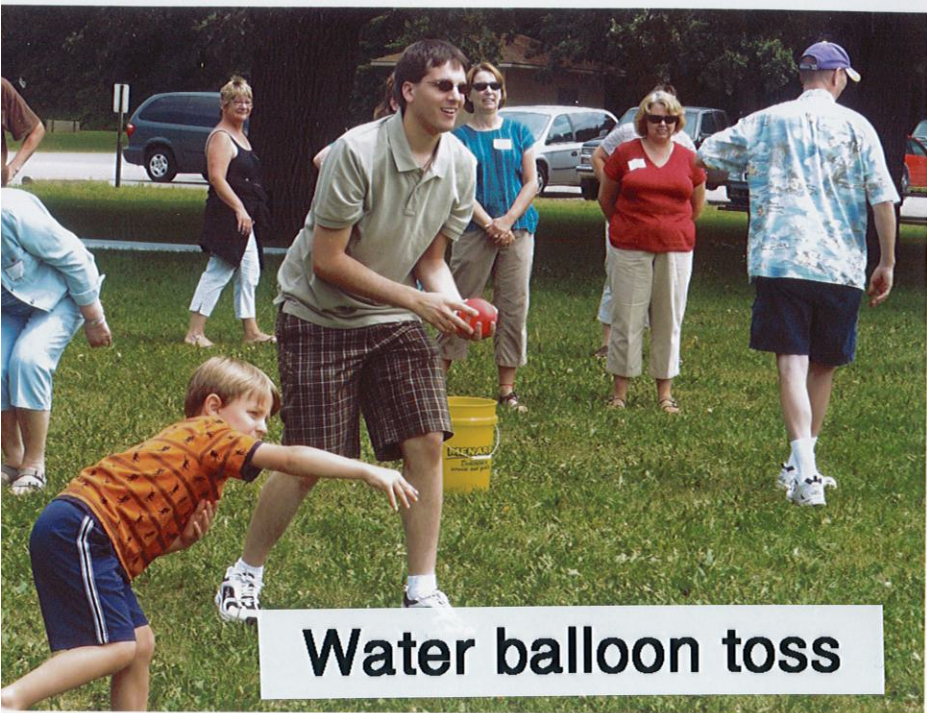

**Water balloon toss**



**.H.H. presentation**



**lecting seed**

**Hunter & August**



**Bob & Sandy shared**



**h Rieke, winner of seed spitting**

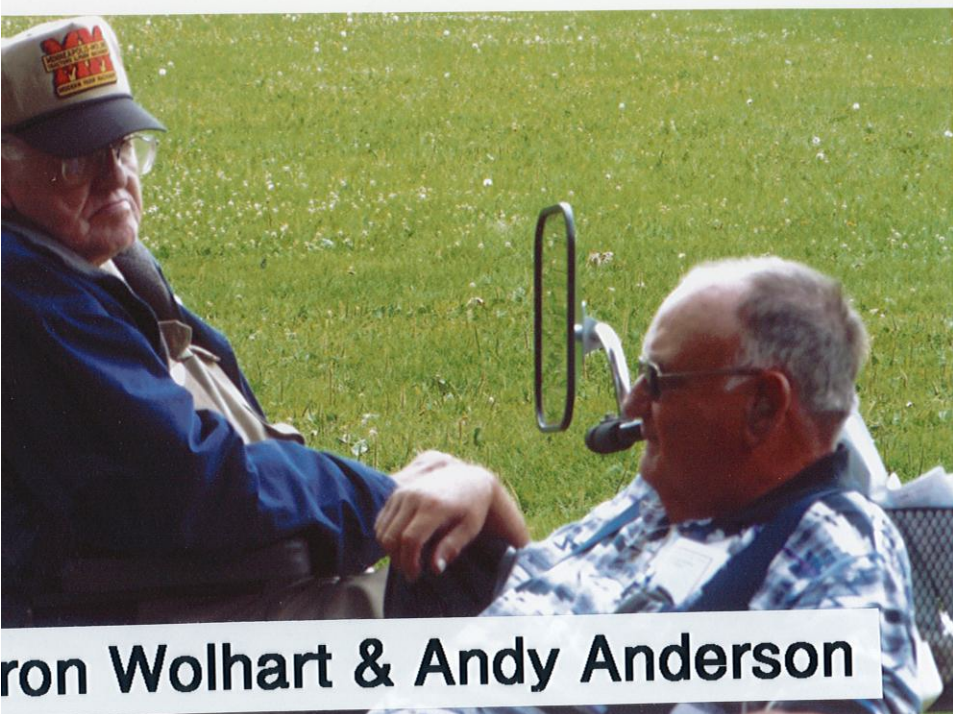

**ron Wolhart & Andy Anderson**



**Julie Johnson at the egg toss**



**Wheel barrel race.**



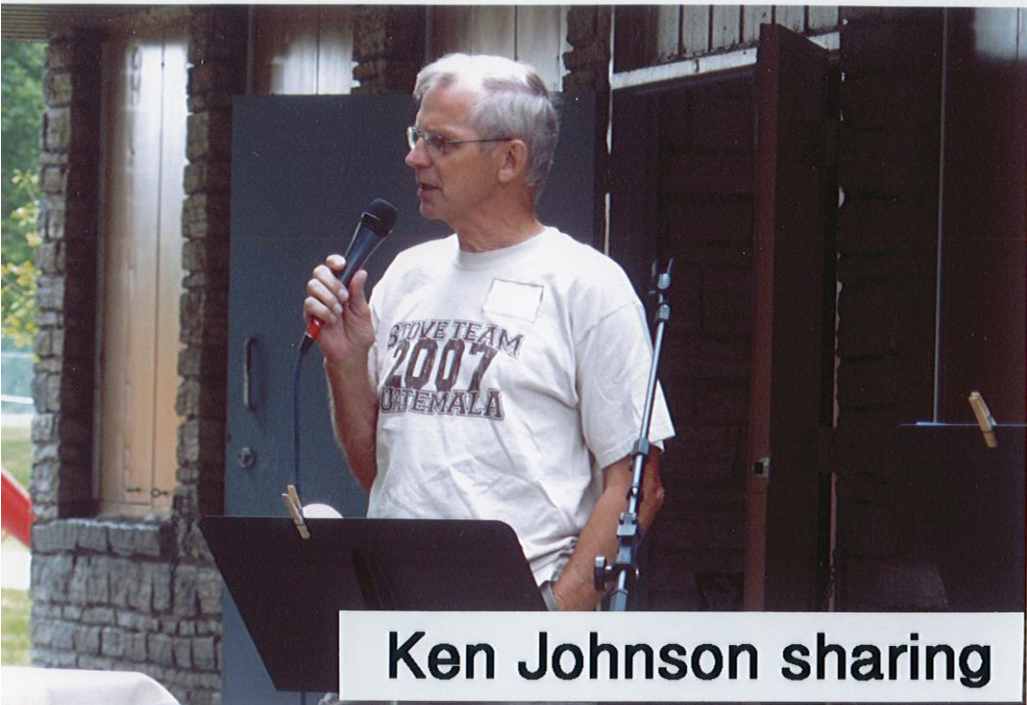

**Ken Johnson sharing**

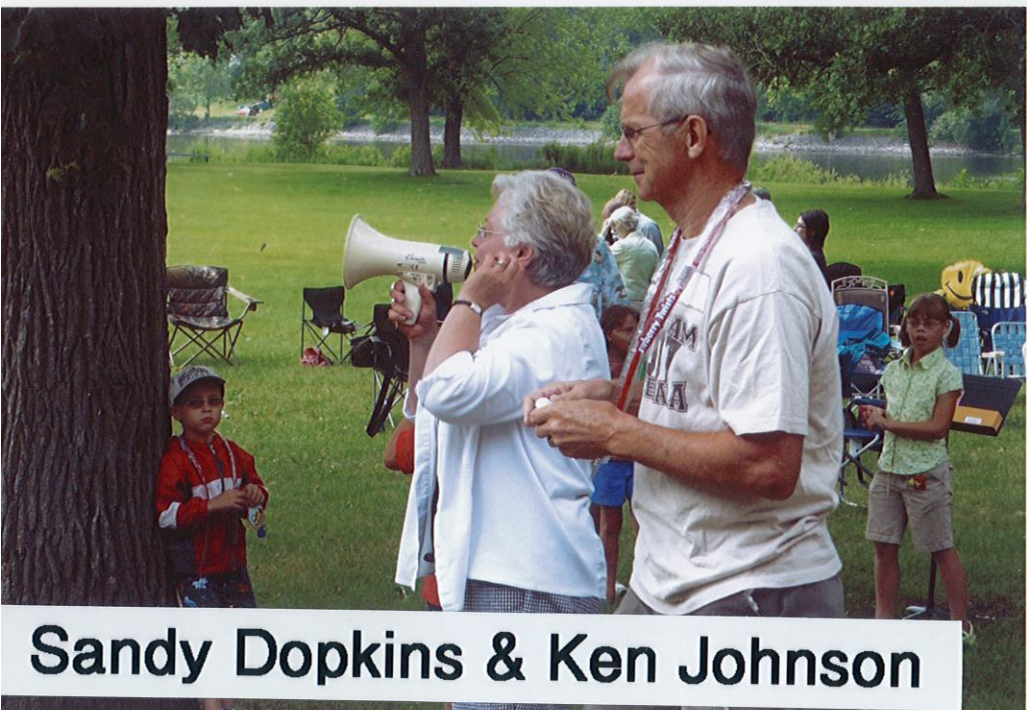

**Sandy Dopkins & Ken Johnson**



**Kami & Cindy– wheel barrel race**



# MARCY BRINGS US TO THE 10<sup>th</sup> YEAR

OF BEING IN OUR PRESENT FACILITY HERE AT 4<sup>th</sup> AVENUE SOUTH.

They say "Time flies when you're having fun." During the last few months our vision and long-standing dream of having an updated, safe and functional kitchen to use for different events has now become a reality.

With donated funds along with using the money from the garage sale kitchen account from a few years ago, our dream is complete.

Ovens, ranges, microwaves, a refrigerator, and freezer are now installed and working. Tons of hours of work and effort went into this project with many hands helping out. Now we can sit back and enjoy cleaning our updated appliances!

**A "BIG" "THANK YOU" needs to be given out for the help we received in the following ways:**

Gary Ziebarth, Ellis Scheevel, Bill DeLovely, Scott Toole, Marty Toole  
for removing the old appliances

Julie Toole, Beth Krueger, Jessie Kerwin, Susie Sands, Yvonne Lunser,  
and Maggie Bjorklund -- the cleaning and organizing crew

Marty Toole-- shelving and cupboard repair

Steve Schirmers-- completed vinyl backsplash and cleaned grates

Darrell Armbrust-- stripping and finishing the floors

Chris Monroe-- moving gas lines and connectors

Julie Toole-- for the accent wall idea & painting

Deb Johnson--for the art in process

Gary Ralston-- making and installing cabinets

Steve of Erickson Electric-- electrical updates

Neil Olmscheid & John Reep-- installing water line, microwaves

I'm grateful to everyone else I've forgotten to mention (please forgive me).

Next time you see any of these helpers extend your appreciation to them.

It couldn't have happened without their gift of time and energy.

I trust we'll all take satisfaction in keeping the kitchen clean, spotless, immaculate, neat as a pin and in tidy order (hint, hint)

so that all of us can use and benefit from its use in the upcoming days, weeks and years of ministry to come here at Hope.



In Christ's service,  
Pam Schirmers



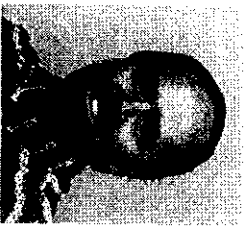

**Coming:**  
**'Habits of the Heart Retreat'**  
*April 6-7, 2008*  
**Hope Covenant Church**

**Richard G. (Rick) Mylander** grew up in inner-city Chicago, an active participant and member of the Grace Covenant Church. Graduating with a B.A. in Music from North Park College, and then an M. Div. from North Park Theological Seminary, he has been a Covenant pastor for over 25 years. His ministry experience has included youth ministry at his home church in Chicago, and a year as youth pastor on Covenant Care-van in Simi Valley, California, pastoral ministry in Attleboro, Massachusetts, and sixteen years as senior pastor of Hope Covenant in St. Cloud, Minnesota, helping lead these congregations in growth, development and relocation. During this time, he has also served as elected chair of the Northwest Covenant Conference Ministerial Association, member and chair of the Covenant's Board of Publication (now Board of Communication), has co-developed our denomination's Inquirer's Class materials, and has ministered in numerous other regional and national board, Bible camp and committee settings.

In 1996, Mylander accepted the call as Associate Superintendent for Church Development in the Covenant's Midwest Conference, where he serves also as Director of Church Planting. In this capacity he enjoys working with pastors and churches, oversees new church development in the Midwest Conference's six-state region (CO, IA, KS, MO, NE, WY), and coaches churches in transition and revitalization. He and his family make their home in Colorado where he serves the conference's western churches more carefully.

His full partner in life and ministry is wife Gail. Married in 1976, they together enjoy four children ranging from college through post-college -- Katrin, Sarah, Maren and Jarrett. An amateur naturalist in zoology, astronomy, meteorology and botany, Rick's personal interests also include writing, reading, playing guitar, hiking, camping and photography.

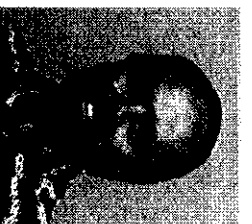

**Coming:**  
**'Habits of the Heart Retreat'**  
*April 6-7, 2008*  
**Hope Covenant Church**

**Richard G. (Rick) Mylander** grew up in inner-city Chicago, an active participant and member of the Grace Covenant Church. Graduating with a B.A. in Music from North Park College, and then an M. Div. from North Park Theological Seminary, he has been a Covenant pastor for over 25 years. His ministry experience has included youth ministry at his home church in Chicago, and a year as youth pastor on Covenant Care-van in Simi Valley, California, pastoral ministry in Attleboro, Massachusetts, and sixteen years as senior pastor of Hope Covenant in St. Cloud, Minnesota, helping lead these congregations in growth, development and relocation. During this time, he has also served as elected chair of the Northwest Covenant Conference Ministerial Association, member and chair of the Covenant's Board of Publication (now Board of Communication), has co-developed our denomination's Inquirer's Class materials, and has ministered in numerous other regional and national board, Bible camp and committee settings.

In 1996, Mylander accepted the call as Associate Superintendent for Church Development in the Covenant's Midwest Conference, where he serves also as Director of Church Planting. In this capacity he enjoys working with pastors and churches, oversees new church development in the Midwest Conference's six-state region (CO, IA, KS, MO, NE, WY), and coaches churches in transition and revitalization. He and his family make their home in Colorado where he serves the conference's western churches more carefully.

His full partner in life and ministry is wife Gail. Married in 1976, they together enjoy four children ranging from college through post-college -- Katrin, Sarah, Maren and Jarrett. An amateur naturalist in zoology, astronomy, meteorology and botany, Rick's personal interests also include writing, reading, playing guitar, hiking, camping and photography.

# 125<sup>th</sup> Anniversary Celebration of Hope Covenant Church

Minutes from committee get-together Jan. 15<sup>th</sup>, 5-10 pm  
Bob & Sandy Dopkins, Ken & Julie Johnson, Steve & Pam Schirmers  
Next planning meeting Jan. 29 at 6:30 at church. Please join us.

## ***“Call to remembrance the former days” Hebrews 10:32***

2008 is the 125<sup>th</sup> anniversary of our church. June 23<sup>rd</sup> in 1883.

We'd like to have our congregation celebrate this milestone in 2008.

The following ideas were discussed:

- ½ page of info in monthly newsletter (history, pictures, interesting facts or tid bits, 100, 50, 10 years ago and present )
- Use the front of our weekly bulletin (old pictures, or facts)
- Summer picnic/worship service at Wilson Park – July 20<sup>th</sup> 9:30-2:00 (incorporate old fashioned games, food, ice cream, etc.) could we rent a large tent from Geyer??
- Fall Event- “Celebrating 125 years of God’s Faithfulness” Smorgasbord and Program on Saturday, Oct. 25./ invitations to past pastors / members.  
Drama (history presentation of early church, in costume, maybe Melissa Diehl, written by???)  
Special music- Crow Wing River Strings (ask Keith Olson)  
Menu ideas- Soup, meatballs, rice pudding, different cheeses and hardtack plus a tasty dessert buffet.
- Music ideas- Commemorative song written by Lowell or Brad? -a Swedish song, -The song-“Thanksgiving”, “Thanks to God for my Redeemer”, -Adult Choir special music-“Sister Act’ style” -Kids bell choir (wearing the old white choir robes from 1937)
- Fall Commemorative 125 Years Directory – past pictures and history, -current member color pictures, addresses and phone, e-mail info, -also include current activities & candid shots from summer picnic/other events.
- Take a “new” all church group picture (outside, in front of the church)
- Banner located outside front of the church to share anniversary info with the verse “LORD, YOU HAVE BEEN OUR DWELLING PLACE THROUGHOUT ALL GENERATIONS” Celebrating 125 Years of God's Faithfulness. 1883-2008 (get price)
- 125 Plan~~ members commit to 125 minutes of service to community.
- Continue gathering info on church history, pictures, newspaper articles
- Cost estimate for the year-- \$2,000-\$5,000. Would cover advertising, postage, events, music, food, printing, etc.



Invoice

Invoice Date Aug 13, 2008	Page 1
Invoice Number IN000061926	

A Division of Morris Printing Group, Inc  
 Federal ID #47-0564855  
 3212 East Hwy 30  
 PO Box 2110  
 Kearney, NE 68848-2110  
 Phone: (800)445-6621 or Fax: (308)698-1100

Comments:

Customer # 91411

HOPE COVENANT CHURCH  
 LYDIA SCHIRMERS HOFFMAN  
 336 4TH AVE S  
 SAINT CLOUD, MN 56301-4453

REORDER QUOTES AVAILABLE UPON REQUEST

Order No.	Past Due Accounts Will Be Charged 1.5% Per Month (18% Per Annum).	Purchase Order #	14 Free Books to Defray Shipping Costs	Ship Via UPS
-----------	--	------------------	---	-----------------

Quantity	Qty. B/O	Item Number	Description	Unit Price	UOM	Extended Price
440	0	CB\F\30\HC\11000	3-RING HARD COVER COOKBOOKS	7.850000	EACH	3,454.00
440	0	CB\F\33170	RECIPE NOTES	0.25	EACH	110.00
440	0	CB\F\33200	PERSONAL PAGE PHOTOS	0.030000	EACH	13.20
440	0	CB\F\33070	TABBED DIVIDERS	0.45	EACH	198.00
1	0	CB\F\22040	SHIPPING BOXES	7.50	CASE	7.50
		DISC	COUPON DISCOUNT			-66.00
		TS	TYPE N SAVE DISCOUNT			-110.00
		SH	SHIPPING & HANDLING			227.00

<b>First Payment Due 9/19/2008 Amount \$1,916.85</b> <b>Last Payment Due 11/11/2008 Amount \$1,916.85</b> When we use information from your check to make an electronic funds transfer funds may be withdrawn from your account as soon as the same day you make your payment and you will not receive the check back from your financial institution For inquiries, please call the Accounting Department at 1-800-445-6621	<b>Subtotal</b> <b>Total sales tax</b> <i>Tax only on NE deliveries</i> <b>Amount due</b>	<b>3,833.70</b> <b>0.00</b> <b>3,833.70</b>
--	--	---

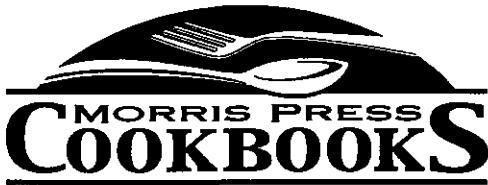

Return This Portion With Payment, Thank-you!

Customer Name & Number 91411 HOPE COVENANT CHURCH

Invoice Number IN000061926

Invoice Amount \$ 3,833.70

Amount Enclosed \$ \_\_\_\_\_

Remit To: **Morris Press Cookbooks**  
 PO Box 2110  
 Kearney, NE  
 68848-2110

# Hope Covenant Church



336 4th Avenue South St. Cloud, MN 56301 320-257-HOPE(4673)

Pastor-Bill Dornbush  
Worship-Brad Martin  
Youth Pastor-Gary Noble  
Small Groups-Kirsten Wagenius  
Christian Education-Kathy Armbrust

Dear Rick and Gail,

We extend warm greetings to you as we recall your time of ministry here at Hope. We are in the midst of preparing a year of celebrating God's 125 years of faithfulness to His people at Hope Covenant Church and our surrounding community.

We'd like to hear from our previous pastors. Could you attend the July 20th Sunday morning Worship and Picnic in the Park and or the October 25th Saturday evening Fall Celebration? Would you be willing to share along with other previous pastors? Hearing from you on how God brought you to your time of ministry here, lessons He taught you while you served Him here at Hope, even humorous situations you found yourself in would be great and uplifting for everyone to hear.

Please let us know if these times could possibly work in your calendar and schedule. Sharing by written word would also be most welcome.

May God richly bless you in the current area He has placed you,

Pastor Bill Dornbush  
and the 125th Anniversary Planning Group

Pam Schirmers  
Steve Schirmers  
Sandy Dopkins  
Bob Dopkins  
Julie Johnson  
Ken Johnson

I will be able to attend: July 20th event \_\_\_\_\_ October 25th event \_\_\_\_\_

I will not be able to attend: July 20th \_\_\_\_\_ October 25th \_\_\_\_\_

Name Rick + Gail Mylander Phone # 303 663 0560

*Hello Folks! Can't promise either of these due to ministry commitments, but will make every effort that we can to be there.*

Reaching the Hearts of People with the Heart of God!

July 9, 2008

Pastor Bill Dornbush  
Hope Covenant Church  
336 4<sup>th</sup> Ave. South  
St. Cloud MN 56301

Dear Pastor Bill and all our St. Cloud Friends,

*"Grace to you and peace from God our Father and our Lord Jesus Christ."*

Gail and I are very sorry our schedules do not allow us to be with you during this summer's installment of your 125<sup>th</sup> Anniversary celebration. It was wonderful to be with you in April, and we do look forward to joining you again in October, but ministry commitments are such here that I cannot find myself clear to be away right at this time.

It is a delight to know you are celebrating, however, and we are with you in the Holy Spirit. How well we remember the 100<sup>th</sup> and 110<sup>th</sup> anniversary years we celebrated with you. Can it be this long since that time? That is hard to believe.

Some of you are around who remember the church's centennial. We began our celebration that 1983 year with a weekend visit in March by Dr. Glenn Anderson, then Dean of North Park Theological Seminary, who spoke passionately and winsomely with us about our Covenant roots. One thing I will never forget about his visit was that I was hobbling around on crutches at the time, having had my own dear wife lead me into a tennis accident that destroyed all three ligaments in my right knee! Glenn was typically gracious.

Then as the year progressed, we celebrated nearly each month with a weekend visit by a former pastor. Each of them encouraged us, and challenged us to hold forth the Word of Life which is Jesus Christ. One of the visiting pastors was an elderly widower in his mid-80's. Shortly after his visit with us he wrote a thank you letter, in which he also informed us he was marrying again soon – he quoted the Scripture, *"I believe I will see the goodness of the Lord in the land of the living."* This was his hope and prayer for us as well!

Finally, as the celebration year came to a close the last weekend in October, we had a banquet in which both our oldest and youngest members spoke, Joe Larson and Tim Watkins. Many former members and friends joined us for that weekend as well, people who had grown up in the church but had left the area in the 40's, 50's and 60's. It was quite an incredible experience. I don't know who was more excited – our current attenders, or these wonderful folks who pored and pored over the old photographs and documents we had laid out all across the back of the sanctuary and the old Fireside Room. We ended that weekend with a group photograph taken outside on the lawn in front of the old sanctuary on Maine Prairie Road. I believe this photo is still on the hall wall there in the current building across from the church office, at least it was there in April. That same photo has graced our own refrigerator for 25 years since the time it was taken.

Now these many years later, you continue to stand on the cusp of God's better blessing and call to new ministry in new ways, new wineskins for new wine. Standing on the foundation which is Christ, blessed by the superstructure of the faith of those who have gone before you, you are still building a house fit for the presence of our Lord. May you do so as a place of grace, a house of prayer, and a center for outreach to those who do not yet know Him.

Lovingly in Christ,  
Rick Mylander



THE  
NORTHWEST  
CONFERENCE

A REGIONAL CONFERENCE OF THE EVANGELICAL COVENANT CHURCH

---

3106 47th Avenue South • Minneapolis, Minnesota 55406-2333 • Phone 612-721-4893 • Fax 612-721-4895  
1-800-756-6692 (within the conference) e-mail [nwc@isd.net](mailto:nwc@isd.net) [www.nwc-cov.org](http://www.nwc-cov.org)

15 April 08

Dear Members of Friends of Hope Covenant,

Congratulations to you on one hundred twenty-five years of faithful ministry! Think of what has transpired, the changes that have occurred and most importantly the lives that have been changed because of your faithful witness.

Your sister congregations throughout the Northwest Conference join with me in thanking God for your faithful ministry! For pastors, faithful leaders, visionaries who have given direction and guidance through the years we give thanks!

Thanks too for your support of missions in our conference and around the world. Your witness extends far beyond the borders of your community.

May this year of celebration be a time of preparation for your next chapter of ministry!

Sincerely,

James A, Frethem, Northwest Conference Superintendent

**RH Anderson**  
**9123 Harvest Hill Dr.**  
**Elk Grove, CA 95624**

July 10, 2008

Dear Hope Covenant Family,

We want to congratulate you on this significant milestone of 125 years of ministry in Saint Cloud. As you look back over the years and celebrate God's faithfulness demonstrated in so many ways, we pray that you will be blessed and encouraged even as you look to the future.

The years that separate our paths have not diminished our appreciation for many memories and friendships that have been a great joy in our lives. We even had the unexpected bonus of getting a great son-in-law out of the deal, and we are so blessed to have Luke Sands and his family as part of our own now. It was so good to see many from Hope at the wedding just over a year ago now, and we enjoyed our time together, though all too brief.

As we recall, moving together through a great deal of transition during our tenure was not always easy, but it provided occasions for stretching and learning in our lives, and we trust, in the life of the church. God is always working his purposes out in individuals and in congregations, and as we trust him for guidance and direction, we always find a firm foundation for what comes next.

We very much appreciate your invitation to join the celebration, but are sorry to say that it will not be possible for us to be with you at either the July or October events. Please know that our prayers and thoughts are with you, and that we sincerely trust that the best days in the life of Hope Covenant continue to lie out ahead.

God's peace to you all!

In Christ's love,

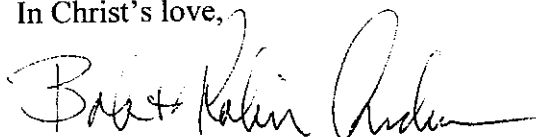
A handwritten signature in cursive script that reads "Bob & Robin Anderson". The signature is written in dark ink and is positioned above the printed name.

Pastor Bob and Robin Anderson

DAVID R. ERICKSON —  
4613 E 18th St Unit #1  
Vancouver, WA 98661

June 5, 2008

Pastor Bill Bornbush  
Hope Covenant Church  
336 - 4th Avenue South  
St. Cloud, MN 56301

Dear pastor and congregation,

Karen and I have a sense of profound joy that emerges out of our many fond memories as I write to express our congratulations to your church family on its 125th anniversary. We praise our great God for His faithfulness in the life of your congregation over these many years!

In many ways you and your fore bearers, many of whom are now at home with our Lord, were the ones who allowed us to really "get our feet wet" in Christian ministry. Karen, Todd and I spent an initial ten weeks with you dear folks during the summer of 1971. That fall we returned to Chicago to complete a final quarter at North Park Seminary and then we moved to St. Cloud to begin our "official" pastorate among you in December of 1971.

The former church building on Northeast Third Ave. was where we met Joe and Ken and Scotty and Bill, John, Ron, Alfred, Annie, Terry and Walt and Elmer and Dean. Nor have we forgotten Priscilla or Julie, Betty, Karen, Gini, Estelle, Pat, Minnie, and the list could go on and on: Elsie, Nancy, Lois, Hilda and Jeannie. And then, too, there were the many senior friends who resided in the Wilson Apartments across the street from the church building. It was PEOPLE... all kinds and from many walks of life, that brought so much variety and fulfillment to my pastorate among you dear people.

Some of you can still recall HEARING and seeing Hulda Johnson ease her big, dark green 1949 dynaflo Buick up to the curb in front of the old church. Were any of you women present at the Covenant Womens' meeting the day the bathroom stall door was accidentally locked and a "volunteer" had to be rounded up to do the unthinkable... get down on the floor, slither under the door and unlock it? It was non other than gracious, primp and proper Hulda who stepped up to the plate (or perhaps I should say knelt down!) and saved the day! Now *there* was a servant spirit!

Joe "the Candy man" faithfully attended the church well past his 90th birthday. Children always sought him out because they knew that his suit coat pockets always held a little wrapped sweet for them to enjoy. As the number of young families increased those bulges in Joe's suit coat pockets always kept pace!

Lots of "good-byes" were said during our four and a half years in St. Cloud. This was due in part to the fact that we were a college city and people often moved on when their college days were over. We said a somewhat heart wrenching farewell to a familiar, old place of worship as we moved out to Main Prairie Road and the next phase of ministry.

I was especially taken by Jim Anderson's comments the Sunday we said our "good-byes" to he and Lois as they headed off to Chicago and seminary. Jim likened the St. Cloud Covenant Church to an inn where many injured and wounded people had been able to come and experience love, gentle care and healing in their lives....he himself being one such person.

Our family moved to Eugene, Oregon in January of 1976 to help establish a new Covenant Congregation. In the fall of 1977 you invited us to return to St. Cloud to participate in the dedication of the new church facilities on Main Prairie Road. And again in 1988 you once more reached out with arms of love to us as we had the privilege of taking part in your 105th anniversary observance.

Today I wish to thank your church family once again for having allowed me to grow in my own spiritual life while working among you. May God abundantly bless you in the days ahead.

Sincerely,



David R. Erickson  
Vancouver, WA

## DID YOU KNOW...?

Hope Covenant celebrates its 125<sup>th</sup> birthday this year.

## DO YOU CARE...?

Our church family birthday is not unlike your grandma's or grandpa's birthday or their 65<sup>th</sup> wedding anniversary.

Our church heritage is not unlike our own great grandparents who emigrated from many European countries, or a few Asian countries,

or an African country. Both heritages played (perhaps still plays) a much greater role in our lives that we will ever realize. Our lives have likely been enriched because of those who have come and gone before us.

This year we'll be sharing bits of history and a few anecdotes that will help all of us better understand why, in part, we are who we are today.

Guds Forsamling i Sauk Rapids (The Swedish Mission Church) was organized on June 23, 1883 with seven charter members. Why were they all men?

Within a few months a lot on "Swedish Hill" was donated, the 26'x38' building was completed, and an adjoining lot was purchased. The indebtedness? Only \$150 (small amount for land today, huge amount for them back in that time).

More to come...

## Hope's 125 Year Celebration

## Did You Know?

The names our congregation has been identified by have changed through the years...

- 1883 Swedish Church of God
- 1927 Swedish Evangelical Mission Church
- 1945 Evangelical Mission Church
- 1969 Evangelical Covenant Church
- 1978 The Evangelical Covenant Church
- 1992 Hope Covenant Church

The progress of a church is not always judged by the number of members, or the number of organizations, but by what has been accomplished according to the will of God. (Quote taken from a 1970's church brochure)

More to come...

# Hope's 125 Year Celebration

March

## Did You Know...?

In our early beginnings the zeal for reaching children was evident from the very beginning in our church history. Sunday School was started in an old saloon in St. Cloud almost simultaneously. Soon another Sunday School class was started in a home north of Sauk Rapids. A chapel was built near Bring's stone quarry southeast of St. Cloud (perhaps near the Minnesota Correctional Facility) in 1886 (preaching services were also held there until 1909), and a branch Sunday School was started in Waite Park in 1898. There were four or five classes operating at one time.

A church building located in St. Cloud was built and dedicated in June, 1889. The indebtedness? \$106.95.

By 1912 there were only two buildings left (Sauk Rapids and St. Cloud) with a combined attendance of 125. The Sauk Rapids services were discontinued in 1921.

How many children and families were impacted during those thirty-eight years of ministry? How many children and families will be impacted in 2008 by our zeal to reach out to a needy community?

More to come...

# Hope's 125 Year Celebration

April

## Did you know...

From the time the church was organized in 1883, the Swedish language was used in all services and other activities as well as in recording the minutes of the business meetings. The Sunday School not only conducted its instruction in Swedish, but taught the children to read and write the language.

As time progressed, more and more of the young people were unfamiliar with the Swedish language. This presented a problem. The Sunday School and the Young People's Society discontinued the use of the Swedish language in their activities in the earlier years of the church. Worship services continued in the Swedish language. Attempts were made to combine the two languages at special meetings and to set aside certain Sundays for services in English. This presented difficulties because the older people failed to get the full benefit from the service in English while the younger couldn't understand Swedish.

At a meeting held January 14, 1936, the secretary was authorized to write the minutes in English. Gradually, it became the language most used and at a business meeting held March 27, 1940, the decision was made to have all Sunday services in the English language.

Today wouldn't be great if we could have Sunday services in Sudanese, Spanish, Chinese, Korean, etc.

More to come...

# Hope's 125 Year Celebration July-August

Did you know . . . Interesting little details of our past.

**A**nnual Meetings were held on January 1<sup>st</sup>. for many years. Can you picture members traveling by foot, horse, or buggy on a Minnesota New Year's Day? Brrrr

**N**o Time for meetings? From May to September 1921 the congregation was so busy tearing down the old building and putting up the new one that "all were busy with the building and had no time for meetings." This quote was recorded in the annual minutes.

**N**ovember 9, 1975 heralded the ground breaking of the Maine Prairie Road church building.

**I**nstallation of six hearing aids graced the East Side church building in 1946. Can you hear me now?

**V**otes to join the Covenant denomination prevailed at the June 8, 1953 meeting.

**E**xplosion of the furnace rocked the East Side church building at the conclusion of Sunday morning worship services on January 27, 1952. Many improvements and repairs followed!

**R**adio station WJON broadcasted our Sunday mornings to the St. Cloud area in 1955.

**S**aloon services?? Here's the scoop- In the late 1880's "preaching services" were conducted in an old saloon building as it was reported in the St. Cloud newspaper.

**A**ugust Anderson, one of our pioneers, bought several lots on Swedish Hill for \$8.00 so new families would have land to build upon when they arrived from Sweden. What a vision!!

**R**eading and writing the Swedish language was taught to children during Sunday School classes in our early church history.

**Y**oung People's Society was the probable predecessor of Youth Group and Young Adult and College Ministries. They were influential in switching from Swedish to English language because it was becoming increasingly difficult for them to understand traditional Swedish.

**GREAT IS HIS FAITHFULNESS!**

March 5, 1951

THE EVANGELICAL MISSION CHURCH  
St. Cloud, Minnesota

Vol. 1 No. 2

## HOME FROM THE REFORMATORY

The old pulpit in the basement of the church spent two weeks at the State Reformatory, while being made over like new by Bernard Fagerman.

This pulpit was originally made by Mr. John Fridlund, grandfather of Mrs. Bernard Fagerman, way back in the days of the Swedish Mission Church on top of "Swede Hill" in Sauk Rapids. When this church was sold the pulpit was moved to the lower auditorium of the present church. For a long time it was used at the "Youth for Christ" meetings held at the Central Junior High School.

We Appreciate the part Mr. Fagerman has taken in this work, and also for the repair work on the pews downstairs which he and Mr. Bracken recently did.

## LEFT FOR THE SERVICE

Another of our boys left for the service February 18. Mr. and Mrs. Skoog received a card from their son, Arnold, stating he was on his way to Fort Lewis, Washington. He left Minneapolis Tuesday morning and expected to arrive in Washington on Thursday. Please remember the boys with prayer and letters.

## HOME FOR THE WEEKEND

Doreen Larson was home for the weekend of the 18th. She is now training in surgery at the Swedish Hospital in Minneapolis.

In case you missed reading the article in the February Reader's Digest entitled, "When Surgeons Improvise" you may now relax. It tells of the new invention of a vanishing sponge. Until recently there was always the danger of a sponge being sewed up inside the patient.

The new "oxidized cellulose gauze" can be sewed up inside the wound and forgotten. It has been used successfully in hundreds of operations.

Incidentally, counting the sponges used and removed is one of the duties of the scrub nurse.

It was nice to see Carol Victor and

## SOMETHING NEW HAS BEEN ADDED--

Have you heard of the new musical organization in our church? It is a male quartet which is composed of Dan Bloomdahl, George A. Larson, Harry Palm, and Marv Stearns. The quartet made their debut at the Father and Son Banquet.

Some of the other men decided they would form a competing quartet. They are Ben Fagerman, Walt Larson, Armen Bracken, and Hub Payne. Come on, lets hear you-- we sure need your help!! (Or was it a male octet?)

## FATHER AND SON BANQUET

The Father and Son Banquet was quite a gala affair! The church parlors were decorated in red, white, and blue in commemoration of Washinton's birthday. Attractive invitations, name tags, and menus (with program) were distributed. Each cover had a marshmallow stump with an ax stuck into it.

The menu consisted of potato sausage, scalloped spuds, fruit jello salad, rolls, pickles, coffee or nectar, ice cream and strawberries with cookies. The ladies spent the day fixing the meal, but from the remarks heard, it was well worth their effort.

One of the high lights of the evening came with the presentation of the string trio, composed of Ernest Bostrom, John Freeberg, and Elmer Youngberg. They were applauded so hard and loud that they had to play and sing an encore. They played and sang guitar selections.

The Sons quartet sang "Beauty for Ashes", and "On the Jericho Road". This was the night that the boys initiated their quartet.

Other numbers on the program were-- "America", by all; the invocation, by Eugene Larson; remarks of welcome, by the toastmaster; the doxology, by all; the toast to the fathers, by Dale Kussman; "Who's Who?" by the toastmaster--Rev. Bloomdahl; "Food for the Soul"--the message by Rev. Irving Carlson of Maywood; compliments to the cooks, by all; the 4th stanza of America, by all; and the benediction by Ernest Sodergren.

Prairie Bible Institute  
Three Hills, Alta., Canada  
January 19, 1952

THE DEVIL IN CHURCH

Dear friends and supporters;

This comes as a request for prayer for your friend and fellow-missionary, Miss Linda Sveiven. Word has just been received that she was to undergo surgery either yesterday or today.

The doctor's decision was unplanned for. Miss Sveiven expected to have the surgery done, after getting her parents moved to Pennsylvania and settled there in her sister's home. The doctor was very emphatic that the condition in her throat that necessitated surgery, must be cared for immediately.

Miss Sveiven is most anxious for the prayers of her friends and supporters at this trying time. Besides her own ill health, she has the concern of her parents, who are not at all well. They too, will appreciate your remembrance before the Throne of Grace.

You may address Miss Sveiven at  
DEACONES' HOSPITAL, MPLS., Minn.

Sincerely yours in Christ,

Nancy Williamson

\*\*\*\*\*

Dear Gen and Carolyn,

You've no idea what enjoyment the Visual Rays brings to me. It might interest you to know that I used some of the quotations from the last page (second column) of the September 23 issue when I had charge of the monthly missionary prayer meeting at our church last month.

The paper is about the only contact I have with the dear folks from St. Cloud. This is mainly due to the fact that I am such a poor correspondent. It was so wonderful to have Irené Freeberg here not long ago. Much much nicer than the fabled "letter from home".

Cathy is still in Fairbanks, Alaska. She is also working as secretary to the dean of the college. She seems to like it there quite well, but she said it is not the place to spend the remainder of one's life.

I'm still teaching school 8th grade math at the Junior High. Sandra is in

Imagine how much my neighbor was surprised last Sunday morning when he encountered the devil on his way to church. "Where do you think you're going?" said he to the devil. "Why shouldn't I be allowed to go to church too?" was the reply. "They pray and preach against me. Who is going to defend me if I don't myself?"

"And how do you propose to do that?"

"Well," said the devil, "the first thing Sunday morning, I go into the houses where the people are getting ready to go to church. A little quarrel, an obstinate shirt collar, a missing button, a misplaced glove all these things please me. This is how I get folks in the right mood.

"Do you see that girl over there? All I have to do is direct her eyes to the new coat and hat of her neighbor, and her attention is captured. There are some young men. Do you think their eyes and their thoughts are not the whole time on some girl in the congregation?"

"During the whole service, those businessmen there will not get their minds off the news they have just been reading. And look over there—those two respectable citizens are the easiest of all for me. I make them think that the sins of which the pastor is preaching apply to some of their friends. Fred begins to think of James, and James begins to think of Fred, and both go home with deep satisfaction.

"And if I cannot get control of a person in any of these ways, I trip him up as he goes out of church. It is especially pleasing to me when people engage in visiting after the service, because as a rule the conversation is of such a nature that the things heard in the sermon are gradually forgotten."

THE SEASON BELL'S ECHO

The Christmas season has again come and gone. The window displays which were up before Thanksgiving have been taken down. Schools which were in session until the weekend prior to the last red date on your 1951 calendar, have resumed. Those of us who worked in stores during the Christmas season, wishing we had a little

## CHOIR

In January of 1967 much conversation centered around the possibility of beginning a church choir. Finally, after quite a few years without a church choir, realization of a choir took place in February.

Music, of course, is a Biblical idea. As we find many times in both the Old and New Testaments, music is a very important asset to the movement of Christendom. And we find that King David in his reign had much music around him; in the temple of his day a choir of 3,000 people sang unto the Lord. This brings us to the purpose of our church choir:

- 1) The most important and basic reason for the choir is to sing praises unto the Lord.
- 2) To supply the church with special music each Sunday is a second reason.
- 3) A third reason is to supply the church with an organization in which old and young might have fun and also praise our Lord.

The choir rendered an Easter cantata on April 9, 1967. The name of the cantata was "Hallelujah! What a Savior," by John W. Peterson. After the cantata our choir took a little rest for about four months as we found it hard to function. However, in September we decided to venture out and see if we couldn't become a true and lasting addition to the church services. This we have accomplished and are now very happy serving the Lord in this manner. In October we began working on our Christmas cantata, "Born A King," by John W. Peterson, which we rendered on December 3, 1967, along with the Foley choir.

It has been a great year working with everyone in the choir. We have had a lot of fun in choir and a lot of serious work also. We are not a professional choir, but we enjoy singing to our Lord; and our hearts are always uplifted in songs sung of our matchless Savior's love.

As choir director, I wish to express a sincere thank-you to all choir members and those involved with it.

In Christ,

Larry Oberg,  
Choir Director

Report of the pastor to the Annual Meeting of the Mission Covenant Church, St. Cloud, Minnesota, December 12, 1966

"As ye have therefore received Christ Jesus the Lord, so walk ye in him: rooted and built up in him, and stablished in the faith, as ye have been taught, abounding therein with thanksgiving." Colossians 2:6,7

I believe it can be honestly said that we have been drawn to each other from the first time we met, and as a result I accepted your unanimous call to become your pastor, and God has been very gracious to us as we have sought to work together in Christ.

A good spirit has prevailed in our meetings. There seems to be a hunger for the Word among God's people, which is always a good sign. The work has been run down and as a consequence needs to be built up again. This may take time. We will need patience, perseverance and courage. We have no easy task before us, so all must work together, give of ourselves, our time, abilities and means, all in dependence on the Holy Spirit to ignite a new fire in and through us.

We are also handicapped because we have so very few young people. As a result it is difficult to get other young people. Much prayer, wisdom and grace are needed. There are those who could be reached. We should try to find out where they are and go after them.

We just had our First Family Night. This is an endeavor to reach all the church family. Let us work together in this effort. I trust that this will be the beginning of building up an outreach for all ages.

We do have a Young Couples group which is active. They are enthused. They are working to get more out. As we get youth, enthusiasm will grow, contagion will set in, singing will be provided, services become more appealing, others will be attracted, and we trust that all will be accompanied with the working of the Holy Spirit in our midst. So let us believe God for better days ahead.

Your pastor desires prayer above all else. As we seek His face He will manifest Himself. We can only go forward "on our knees." God answers prayer, so let our petitions and thanks go up to our God through Jesus continually.

We are planning a series of meetings early in February with one of our former pastors, Rev. Donald G. Thomas, as speaker. These meetings can be very helpful in the work as we give ourselves to God and them. Oh, fellow believers, seek God for His blessing and power. Pray definitely, by name, for those who are not saved. As we humbly enter into this series God will be pleased to manifest Himself to us. We do not only want good services, we desire to have God bring us to a new place of decision and life in Christ. Have faith in God.

Our membership, as far as I can ascertain, is 58. There are a number who should be contacted for membership before our Annual Meeting, and will be. However, numbers alone is not an evidence of growth in the Lord, but helps to keep us together and gives new ones a church home and an opportunity to serve the Lord in "their" church. We want any and all who love the Lord and are willing to work together with us as members.

There is nothing to report on marriages, baptisms, deaths, etc., since I have become your pastor, for none of these, by the grace and providence of God, have taken place among our church membership. However, during the year our Lord Jesus did take to Himself a very devoted and faithful child of His, our sister, Mrs. Ernest (Esther) Sodergren. May our brother experience the comfort and grace of the Holy Spirit in abundance. May her memory be an encouragement to all of us to be faithful until the day of our summons.

The finances of the church are in a very good condition. I trust that we will continue to contribute well to the Lord and His work through our church. The amount and spirit in which we give reflects how deeply the Spirit of God is allowed to work in our hearts. So far the indications are very gratifying. When God's people present their tithes and offerings to Him, He promises an open heaven. Surely we want this.

People who have come to worship with us have expressed that we are friendly and we make them feel welcome. Let us continue to be such. Let us extend this friendliness to visiting in homes, not only among a special few whom we like the best, but toward others also who crave friends. Here is a great field for enlarging our borders. Young and old have contacts. Let us use them to serve others through visitation.

As a whole, the work has gone well these three months. However, this is only a beginning. We must ever move forward. Continue to pray, serve, love, trust God and look to Him for His blessing on our efforts in Him. Soon, perhaps sooner than we realize, Jesus will return for His own. What a glorious day! Until that day let us occupy ourselves in His service seeking the power of the Holy Spirit on our efforts in Him.

Only one life, 'twill soon be past,

Only what is done in Christ will last.

Sincerely, in Christ,

Clarence Satterblom, Pastor

# VISUAL RAYS

January 27, 1952

THE EVANGELICAL MISSION CHURCH  
St. Cloud, Minnesota

Vol. 2 No. 1

## WEDDING BELLS CONGRATULATIONS :

Vows were exchanged last night (Saturday- January 26th) uniting Ruth Bonin and David Lewis in the holy estate of matrimony. Ruth is the daughter of Mr. and Mrs. Bonin, formerly of St. Cloud. The wedding took place in the home of the bride in Spring Lake Park. Ruth is an office manager in Mpls. David is teaching mathematics at the University of Minnesota. Their residence is at 607 12th Ave. S.E. in Mpls. Minn. We sincerely wish you much happiness. "Sing unto the Lord, bless His Name; show forth his salvation from day to day." (Ps. 96; 2 )

## OUR LITTLE WHITE ROBES IN USE AGAIN

The minutes of the November 10th meeting of the Helping Hands organization are as follows;

The meeting was brought to order by Mrs. Bloomdahl. We sang our theme song, "How I Love To Sing." Then we sang "Away in a Manger", "O Little Town of Bethlehem", and a new song "Dear Little Stranger". Then Mrs. Bloomdahl read us the story, "In the Beginning."

We voted Patty Johnson as secretary Jim Stromvig for president, and Marion Victor was voted program chairman. Mrs. Bloomdahl led in prayer. The meeting was then closed.

P.S. We try to meet every Thursday evening. Sometimes we have the meeting on Tuesday instead. Before Christmas we all brought toys which we painted and fixed up. They were sent to missionaries. Our first appearance was at the Friendship society meeting in December. We also sang at the morning service on December 30. We enjoy working with Mrs. Bloomdahl.

Patty Johnson, Sec.

Our "Little Lucia Nov" enjoyed

## SERVICE MEN HOME

Arnold Skoog is now somewhere in Japan. He left the states January 4th. We wish to congratulate him for graduating with a superior rating from the Camp Gordon Signal Corp. Arnold was home on a 23 day leave which ended Dec. 16th. He then went to Fort Lawton, Wash. where he was stationed until he went overseas. While in Washington he spent Christmas and New Years Day with his cousin, Mrs. Palmer Peterson, and her husband in Enumclaw. Mrs. Peterson is sister to Don Johnson.

Bob East spent Christmas at home with his bride and his family. Bob married a St. Cloud girl, Jo Ann Canfield, last Sept. 29th. She is with him in Fort Benning where he is a radio mechanic at the Lawson Air Force Base. We wish them much joy and happiness in their wedded life.

Melbert Sodergren had 10 days off at Christmas. He spent them with Kay and Bill Rudin in Salina, Kansas. Mr. and Mrs. Sodergren also vacationed there over the Christmas holidays. Mel is still going to radio school. He has about 14 weeks left.

The service mens addresses can be found on the last page.

## SUNDAY SCHOOL SUNSHINE

"Even a child is known by his doings whether his work be pure and whether it be right." Proverbs 20;11

We want to wish every one prosperity and good health in this New Year, May God bless us as he has done in the past.

One day an old prosperous Indian went into a town. As he entered one of the shops, a beautiful sparkling chandelier caught his eye. Immediately he bought it upon reaching home, he called his

**MAP OF HOPE COVENANT CHURCH**

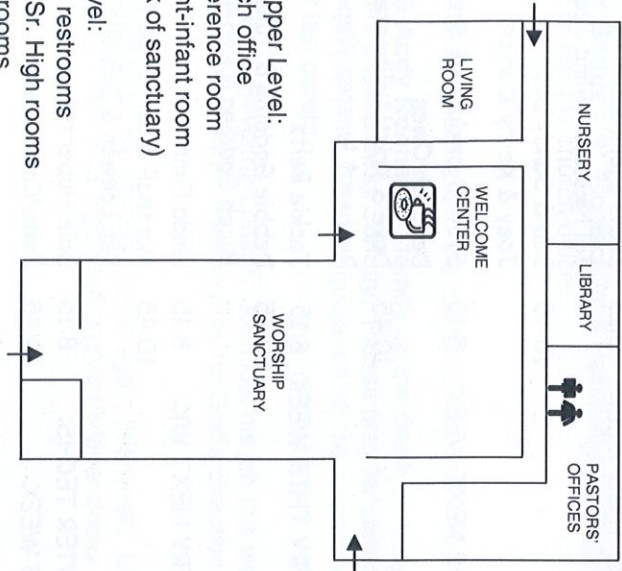

**Also on Upper Level:**

- church office
- conference room
- parent-infant room (back of sanctuary)

**Lower Level:**

- more restrooms
- Jr. & Sr. High rooms
- classrooms
- fellowship hall
- kitchen

*A recording of today's worship service is available upon request by calling the church office.*

**Hope Covenant Church**  
336 – 4<sup>th</sup> Ave. S.  
St. Cloud, MN 56301  
320-257-HOPE (4673)  
[hope@hopecovenant.org](mailto:hope@hopecovenant.org)  
Web: [www.hopecovenant.org](http://www.hopecovenant.org)

**Ministers: the congregation**  
**Equipper: Bill Dornbush, Pastor & Gary Noble, Youth Pastor**  
**Kathy Armbrust, Christian Discipleship Coordinator**  
**Brad Martin, Worship Arts Director**  
**Kirsten Wagenius, Small Group Director**

**HOPE COVENANT CHURCH**

**1883-2008**

**CELEBRATING 125 YEARS OF GOD'S FAITHFULNESS**

**OF GOD'S FAITHFULNESS**

**Celebration of Worship**

**January 27, 2008**

**8:15 & 10:45 am**

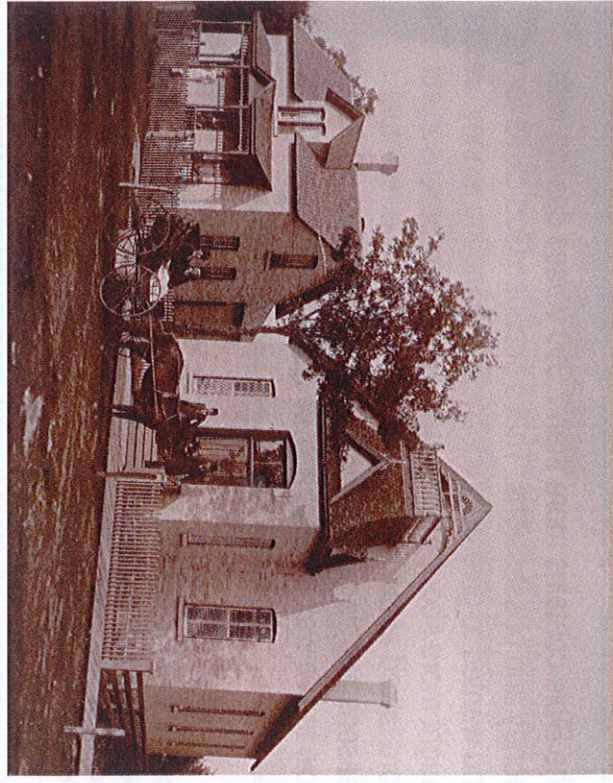

**1<sup>st</sup> Swedish Church of God**  
(our congregation's "new" building in 1888)

## Youth "Ground Zero"

**YOUTH & PARENTS of ground zero** (7<sup>th</sup>-12<sup>th</sup> Grades)

\*Monthly calendar and all Registration forms are available outside of Gary's office!

### 1 Blob 8 !

**At Good News -> 6:30 pm!**  
**By Tech (7<sup>th</sup> St. and 17<sup>th</sup> Ave. S)!**

7<sup>th</sup> - 12<sup>th</sup>      1 Youth 1      7<sup>th</sup> - 12<sup>th</sup>

**On a Normal Week (subject to being over-ridden by above)**

<b>Sun Morns below zero</b> 9:30 am - Youth Room Snack - Connect - Chat 7 <sup>th</sup> and 8 <sup>th</sup> graders Meet for DCI	<b>Wed Nights ground zero</b> 7:00 pm - See above for location It's not Thursday until you've spent Wednesday night with us!
--	--

### 1 Ski Day !

**Sat Feb 2<sup>nd</sup> at Wild Mountain**

**Grab some friends and get signed-up!**  
**Due by Wednesday, Jan. 30**

### 1 Lost and Found Concert !

**Wristbands (tickets) Now Available!**

**If you get one or more friends to go,  
YOUR wristband is free!**

**Looking Ahead!**

**Mattress Run -> Sat Mar 1 -> 10 am at Riverside Park**

Is YOUR contact info updated?  
get your new email, address etc... to Gary!  
\*Get your current schedule to me too!

## Hope Happenings

We would like to welcome **Martha and Jinach Machar** to Hope Covenant today. Martha is David Machar's wife and Jinach is his son. They arrived earlier this week. Join us for their **welcoming lunch** following the second service today in the Fellowship Hall downstairs.

The two white roses you see on the Communion Table represent two commitments to Christ that occurred this past week. Rejoice!

If you were unable to attend the Annual Meeting, copies of the Annual Report which includes the 2008 budget are available on the table in the Welcome Center. The Missions report is also available.

The **Gimme 5 Offering** envelope today is for "**Kids Against Hunger.**"

**"Kids Against Hunger"** We will be packaging food at Kids Against Hunger on Wednesday, **January 30<sup>th</sup>**. We need 30 people to sign up. Sign up in the Welcome Center. Questions? call Jan DeLovely at 230-2896.

**Hope Covenant** will celebrate their **125<sup>th</sup> Anniversary this fall**. We will be featuring various photos in our bulletins and newsletters until the celebration.

**Valentine Dinner:** Hope Covenant's Fall Marriage Class, taught by Cindy and Bob Koubsky, encourages you to come with your sweetheart to this fun annual event. Keith's Kettle in Clearwater is offering a delicious dinner special of Pork Prime Rib, or you can order off the regular menu. Special music throughout the evening by Jan DeLovely. Arrive at 6:00 pm. Dinner starts at 6:30 pm. Sign up in the Welcome Center. All are welcome.

**Ski Day at Taylors Falls:** An *All-Church* Event! Saturday, February 2. Reservations due Wed. Jan. 30. Slide reservation forms under Gary's office door as he is out today. Questions? Call Gary Noble 257-4673.

**Lake Beauty Bible Camp:** for registration call 1-800-732-1990.  
Couples Retreat: February 8-10  
Trailblazer Winter Retreat (grades 4-5-6): February 15-17  
Jr. High / Super High Winter Retreat: February 22-24

**Marriage Encounter/Engaged Encounter:** February 16 & 17 at Dakota Ridge Hotel (35E & Yankee Doodle; Eagan). Visit [www.marriages.org](http://www.marriages.org) or call 651-454-3238.

**St. Loat Choir Concert:** Sun., Jan. 27, at 3 pm at St. Mary's Cathedral  
**I am looking for a Roommate:** Bill Short; call at 224-0616.

### Looking Ahead:

**Teen Challenge:** Coming Sunday, March 9  
**Lost and Found Concert:** *Here!* Sunday, March 30; 6 pm; tickets \$10

## MAP OF HOPE COVENANT CHURCH

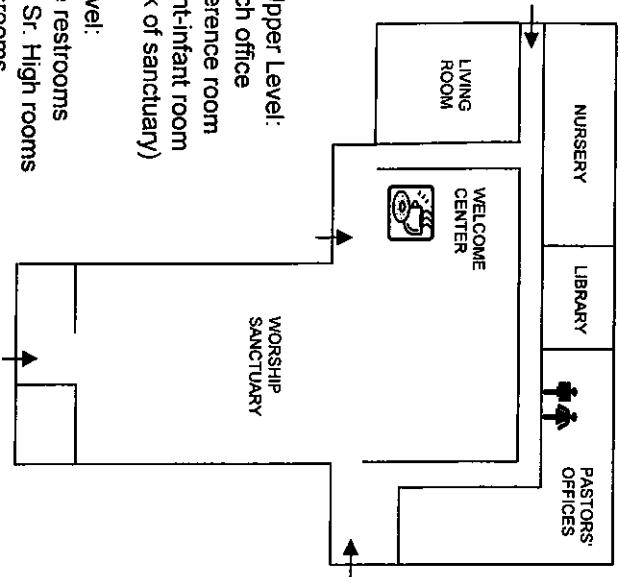

### Also on Upper Level:

- church office
- conference room
- parent-infant room (back of sanctuary)

### Lower Level:

- more restrooms
- Jr. & Sr. High rooms
- classrooms
- fellowship hall
- kitchen

*A recording of today's worship service is available  
by calling the church office.*

## Hope Covenant Church

336 – 4<sup>th</sup> Ave. S.

St. Cloud, MN 56301

320-257-HOPE (4673)

[hope@hopecovenant.org](mailto:hope@hopecovenant.org)

Web: [www.hopecovenant.org](http://www.hopecovenant.org)

### Ministers: the congregation

Equipper: Bill Dornbush, Pastor & Gary Noble, Youth Pastor

Kathy Armbrust, Christian Discipleship Coordinator

Brad Martin, Worship Arts Director

Kirsten Wagenius, Small Group Director

Janelle Ruddingen, Office

Pam Schimmers, Facilities

# HOPE COVENANT CHURCH

1883-2008

CELEBRATING 125 YEARS  
OF GOD'S FAITHFULNESS

Celebration of Worship

February 3, 2008

8:15 & 10:45 am



1<sup>st</sup> Swedish Church of God

(our congregation's "first" building in St. Cloud--1883)

Address was 18 3<sup>rd</sup> Ave. NE, St. Cloud

Parsonage is on the left & Church is on the right

## Welcome to Hope Covenant

February 3, 2008

Message:

Pastor Bill Dornbush

### "A Slave to the Lender"

*Living Debt Free*  
2 Kings 4:1-7

The wife of a man from the company of the prophets cried out to Elisha, "Your servant my husband is dead, and you know that he revered the Lord. **But now his creditor is coming to take my two boys as his slaves.**" Elisha replied to her, "How can I help you? **Tell me, what do you have in your house?**" "Your servant has nothing there at all," she said, "except a little oil." Elisha said, "Go around and ask all your neighbors for empty jars. Don't ask for just a few. Then go inside and shut the door behind you and your sons. Pour oil into all the jars, and as each is filled, put it to one side." She left him and afterward shut the door behind her and her sons. They brought the jars to her and she kept pouring. When all the jars were full, she said to her son, "Bring me another one. But he replied, "There is not a jar left." Then the oil stopped flowing. She went and told the man of God, and he said, "Go, sell the oil and pay your debts. **You and your sons can live on what is left.**" **2 Kings 4:1-7**

The Bible does not say that using debt is sin, but it does discourage it. Debt is money or possessions which one person is obligated to pay to another. Debt includes money owed to banks, friends, relatives, credit card companies, and finance companies. Today we'll look at some very practical guidelines that God gives us to live debt free.

### Welcome Newcomers

A special welcome is extended to newcomers this morning! Please take a "welcome bag" home with you. They are located in the back entrance of the church. Please tell us you are visiting by signing the black "friendship pad" as it is passed down the row. Join us for refreshments & fellowship following the service today in the Welcome Center.  
Infants and children under four may visit the nursery during the service. Activity bags are available at the sanctuary entrances for use during worship.

## CHURCH VOLUNTEERS

USHERS THIS WEEK:	8:15	Scott Bjorklund
	10:45	Steve Sands & Deborah Owen Reuben & Kirsten Wagenius Dave & Kristi Laliberte
USHERS NEXT WEEK:	8:15	Scott Bjorklund
	10:45	Keith & Jan Olson Dave & Toby Peterson Marty & Julie Toole
NURSERY THIS WEEK:	8:15	Linda Firmrite
	10:45	Marshall & Lori Engevik Ben Loewen & Danielle Goetz
NURSERY NEXT WK:	8:15	Deb Johnson
	10:45	Reuben & Kirsten Wagenius Alexis Nelson & Nyachieng Bilew
COMPUTER TECHS:	8:15	Kevin Heysse
THIS WEEK:	10:45	Marty / Jordan Toole
COMPUTER TECHS:	8:15	Dick / Bev Mowe
NEXT WEEK:	10:45	Gary Noble
SERVANT GROUP		
NEXT WEEK:	10:45	Wild Game Dinner

### DISCIPLESHIP Rooms, Grades, and Teachers

Room	Grade	Teacher(s)/Classes
206	0-2 yr olds	Jesse Kerwin, Elena Romnei, Beth Krueger
208	3-4 yr olds	Ruth Kaczor & Family
207	K-1 <sup>st</sup> gr	Susan Heysse & Jenny Hill
210	2 <sup>nd</sup> & 3 <sup>rd</sup> gr	Joy Anderson
110	4 <sup>th</sup> 5 <sup>th</sup> 6 <sup>th</sup> gr	John Theis
106	7 <sup>th</sup> & 8 <sup>th</sup> gr	Mark Nelson & Joanne Reinhart
105	9 <sup>th</sup> - 12 <sup>th</sup> gr	Gary & Jenna Noble
"		Keith Krueger & Melissa Diehl
204	Women	"Power of a Praying Woman"
103	Adult	"Old Testament Stories from the Backside"
209	Adult	"Life of Paul"
104	Adult	"Seeking Him"

## Youth "Ground Zero"

**YOUTH & PARENTS of ground zero** (7<sup>th</sup>-12<sup>th</sup> Grades)

\*Check out Facebook Page – *GroundZero Youth*

and become a fan!

Registration forms are available outside of Gary's office!

### ! Ground Zero !

Youth Room -> 7:00 pm!

James and *The Two Towers*

### ! Youth !

**On a Normal Week (subject to being over-ridden by above)**

Sun Morns below zero

9:30 am – Youth Room

Snack – Connect – Chat

7<sup>th</sup> and 8<sup>th</sup> graders

Meet for DCI

Wed Nights ground zero

7:00 pm – See above for location

**Godfather's or Youth Group**

It's not Thursday until you've spent Wednesday night with us!

### ! Mattress Run !

Sat March 1<sup>st</sup> at Riverside Park

10am to 1pm

Grab some friends and form a team!

### ! Lost and Found Concert !

**Wristbands (tickets) Now Available!**

If you get one or more friends to go,

**YOUR wristband is free!**

Is YOUR contact info updated?

get your new email, address etc... to Gary!

\*Get your current schedule to me too!

HOPE COVENANT CHURCH Gary@HopeCovenant.org

## Hope Happenings

Copies of the **Annual Report**, including the 2008 budget are available on the table in the Welcome Center. The Missions report is also available.

As of February 1, the Council is as follows: Church Chair-Lowell Larson; Vice Chair-open; Recording Secretary-Cynthia Mehoves; Treasurer-Don Sankey; Financial Secretary-Ellis Scheevel; Ministry Team Leaders are: Children's-Twila Mursu  
College-Joey & Kerry Klarich  
Early Childhood-Lori Engewik/Beth Krueger  
Evangelism-Jim & Jeanette DeRose  
Missions-John & Joanne Reinhart  
Properties-Co-chairs-Reuben Wagenius/open  
Small Groups-Cindy Koubsky  
Stewardship-Eunice Sankey  
Sunday School-Bev Mowe  
Women's-Julie Toole/Jill Nessa  
Worship-Steve Schirmers  
Youth-Melissa Diehl  
Elders are Keith Olson, Bryon Anderson, Scott Bjorklund, Dave Kamphenkel, and Karen Witzman. We want to extend a special thank you to all of our council members for their time and service. Council members ending their terms are: Audrey Kamphenkel, Cheryl Larson, Suzie Sands, and Marty Toole.

**Wild Game Dinner:** a Reminder to those bringing Game for the Dinner. Please make sure the meat is thawed and ready for preparation by 11:00 a.m. Saturday morning, February 9<sup>th</sup>. You can place game in one of the refrigerators at church ahead of time with a label, or just bring to the cook-fest, Saturday the 9<sup>th</sup>. Questions call Steve Sellnow @255-0462.

**Valentine Dinner:** Hope Covenant's Fall Marriage Class, taught by Cindy and Bob Koubsky, encourages you to come to this fun annual event. Keith's Kettle in Clearwater is offering a delicious dinner special of Pork Prime Rib, or you can order off the regular menu. Special music throughout the evening by Jan Delovey. Arrive at 6:00 pm. Dinner starts at 6:30 pm. Sign up in the Welcome Center. All are welcome. Please join us.

Thank you for the thinking of us and for the cards and flowers given in memory of Elaine Ronnel. It was appreciated. --Andy and Elena Ronnei

**Lake Beauty Bible Camp:** call 1-800-732-1990 for registration  
Couples Retreat: February 8-10 (*brochures are in the Welcome Center*)  
Trailblazer Winter Retreat (grades 4-5-6): February 15-17  
Jr. High / Super High Winter Retreat: February 22-24

**Looking Ahead: Teen Challenge:** Coming Sunday, March 9

**Lost and Found Concert:** Here! Sunday, March 30, 6 pm; tickets \$10

HOPE COVENANT CHURCH Hope@HopeCovenant.org

# Prayers of Hope

**For Prayer Requests:** Contact John Reinhart at [jo76idhn@charter.net](mailto:jo76idhn@charter.net) or at 253-0332 or call the church office.

- Prayers:** for those serving in the armed forces and their families.
- for the family of Martha Roth's Aunt Helen. Helen passed away last week from cancer. Thanks to everyone who prayed for her.
  - for Deloris Busche (from Ann Krueser Voss) for healing and recovery from intestinal surgery
  - for a friend (from Stephanie) for guidance and acceptance of Christ.
  - for Kelly Grubb (friend of Sankey's) has leukemia. She is 19 and is struggling with severe pain. Continue prayers for Kelly for comfort and peace.

**Prayer Updates:**

- for Elena & Andy Ronnei and family on the death of Andy's mother, Elaine Ronnei. Please pray for comfort and peace during this difficult time. Pray for guidance in the responsibilities that follow when parents pass away.
- for Josh (friend of Yvonne Lunser) who lost his job last week and is married with three children. Please pray for God's direction and for employment opportunities.
- for peace and comfort for the family of Don Sankey's Aunt Marie. Marie passed away Sunday, January 13.
- for Kim Koop. Continue prayers of healing.

**Praise and congratulations to Angie & Shawn Christenson!** They had a healthy baby boy born January 25. Preston Xavier weighed 8 lbs. 6 oz. Grandparents, Pam & Steve Schimmers, are blessed that all went well for grandbaby.

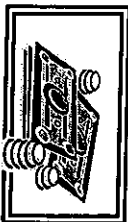

## Treasurer's Report

**OFFERINGS**

Budgeted Amount Each Week: \$ 8,075.00  
 Received 1/27 \$ 4,994.00

HOPE COVENANT CHURCH (320)257-HOPE

# Calendar of Hope

Today	Communion/Benevolent Fund
8:15 a.m.	Worship Service (Nursery Available)
9:30 a.m.	Sunday School
10:45 a.m.	Worship Service (Nursery Available)
10:30 a.m.	Laotian Worship Service
12:00 noon	College/Young Adult Lunch; Living Room
4:00 p.m.	Korean Worship
<b>Mon</b>	<b>Office Closed</b>
7:00 p.m.	Women's Bible Study; Living Rm.
7:00 p.m.	Granite City Group; Fellowship Hall
8:00 p.m.	AA; Big Book Study; Room 104
<b>Tues</b>	<b>Staff Meeting</b>
10:00 a.m.	Child Care; Nursery; Beth K. & Julie Toole
<b>Wed 9:30-12:30 p.m.</b>	<b>Odyssey</b>
6:30 p.m.	Men's Group
6:30 p.m.	Youth Group at Hope
7:00 p.m.	Choir
7:00 p.m.	Worship Team Practice (for 1 <sup>st</sup> Service)
<b>Thurs</b>	<b>Women's Bible Study</b>
9:00 a.m.	ARC; Living Rm/Nursery
5:30 p.m.	Home School Group
6:30 p.m.	Worship Team Practice (for 2 <sup>nd</sup> Service)
7:00 p.m.	
<b>Fri</b>	
<b>Sat</b>	
<b>Sun</b>	8:15 a.m. <b>Worship Service</b>
	9:30 a.m. <b>Sunday School</b>
	10:45 a.m. <b>Worship Service</b>
	10:30 a.m. Laotian Worship Service
	12:00 noon <b>Wild Game Dinner</b> ; Fellowship Hall
	4:00 p.m. Korean Worship Service

*(Hope Covenant activities are in bold)*

## Calendar Celebrations

**Birthdays this week:**

- 3 - Jordan Toole
- 6 - Alexis Nelson
- 6 - Keith Olson
- 7 - Jonathan Sellnow
- 7 - Parker Skajewski
- 9 - Tharen Johnson

**Anniversaries this week:**

- 4 - David & Tammy Best



HOPE COVENANT CHURCH (320)257-HOPE

## MAP OF HOPE COVENANT CHURCH

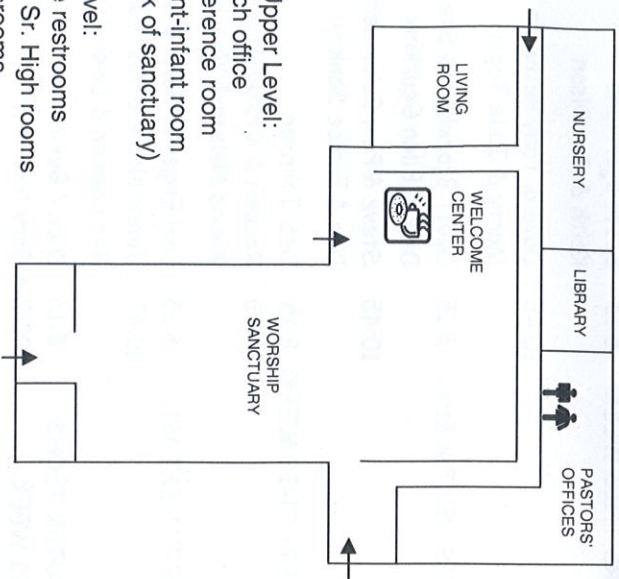

### Also on Upper Level:

- church office
- conference room
- parent-infant room (back of sanctuary)

### Lower Level:

- more restrooms
- Jr. & Sr. High rooms
- classrooms
- fellowship hall
- kitchen

*A recording of today's worship service is available upon request by calling the church office.*

## Hope Covenant Church

336 – 4<sup>th</sup> Ave. S.

St. Cloud, MN 56301

320-257-HOPE (4673)

[hope@hopecovenant.org](mailto:hope@hopecovenant.org)

Web: [www.hopecovenant.org](http://www.hopecovenant.org)

### Ministers: the congregation

Equippers: Bill Dornbush, Pastor & Gary Noble, Youth Pastor

Kathy Armbrust, Christian Discipleship Coordinator

Brad Martin, Worship Arts Director

Kirsten Wagenius, Small Group Director

Janelle Ruddingen-Office

Pam Schimmers-Facilities

# HOPE COVENANT CHURCH

## 1883-2008

### CELEBRATING 125 YEARS OF GOD'S FAITHFULNESS

#### Celebration of Worship

February 10, 2008

8:15 & 10:45 am



### Swedish Church of God

In 1883, our "first" church building was located on top of "Swedish Hill" at 204 5<sup>th</sup> Avenue South in Sauk Rapids.

The building was 26 x 36. The lot next door was also purchased. Many people were generous in making donations.

# CHURCH VOLUNTEERS

## Welcome to Hope Covenant

February 10, 2008

Message: Pastor Bill Dornbush

### "Giving Back"

Remember this: Whoever sows sparingly will also reap sparingly, and whoever sows generously will also reap generously. Each man should give what he has decided in his heart to give, not reluctantly or under compulsion, for God loves a cheerful giver. And God is able to make all grace abound to you, so that in all things at all times, having all that you need, you will abound in every good work. As it is written: "He has scattered abroad his gifts to the poor; his righteousness endures forever." Now he who supplies seed to the sower and bread for food will also supply and increase your store of seed and will enlarge the harvest of your righteousness. You will be made rich in every way so that you can be generous on every occasion, and through us your generosity will result in thanksgiving to God.

**2 Corinthians 9:6-11**

Giving is one of the most fulfilling parts of the Christian life. Throughout the Bible we are encouraged to be generous. But giving is far more than just putting money in the plate each week. It is actually **"an ongoing test of how seriously we take God's will for our lives and for whether we will ever be trusted with anything more significant than money."** Someone has said, **"Not until your pocket book is converted to the Lord, will you be fully converted."** Let's look at how we should give and invest in eternity.

### Welcome Newcomers

A special welcome is extended to newcomers this morning! Please take a "welcome bag" home with you. They are located in the back entrance of the church. Please tell us you are visiting by signing the black "friendship pad" as it is passed down the row.

Infants and children under four may visit the nursery during the service. Activity bags are available at the sanctuary entrances for use during worship.

USHERS THIS WEEK:	8:15	Scott Bjorklund Keith & Jan Olson
USHERS NEXT WEEK:	8:15	Dave & Toby Peterson Marty & Julie Toole
NURSERY THIS WEEK:	8:15	Deb Johnson
NURSERY NEXT WK:	8:15	Lori Engevik; Gene & Julie Granberg Jenna Noble & Ann Voss Ben Loewen & Danielle Goetz
COMPUTER TECHS:	8:15	Dick / Bev Mowe
COMPUTER TECHS:	10:45	Gary Noble
COMPUTER TECHS:	8:15	Dale Hubert
COMPUTER TECHS:	10:45	Nathan & Amanda Bruno
SERVANT GROUP	8:15	
THIS WEEK:	10:45	Wild Game Dinner
SERVANT GROUP	8:15	Keith & Jan Olson
NEXT WEEK:	10:45	
DISCIPLESHIP Rooms, Grades, and Teachers		
<u>Room</u>	<u>Grade</u>	<u>Teacher(s)/Classes</u>
206	0-2 yr olds	Jesse Kerwin, Elena Ronnei, Beth Krueger
208	3-4 yr olds	Ruth Kaczor & Family
207	K-1 <sup>st</sup> gr	Susan Heyesse & Jenny Hill
210	2 <sup>nd</sup> & 3 <sup>rd</sup> gr	Joy Anderson
110	4 <sup>th</sup> 5 <sup>th</sup> 6 <sup>th</sup> gr	John Theis
106	7 <sup>th</sup> & 8 <sup>th</sup> gr	Mark Nelson & Joanne Reinhart
105	9 <sup>th</sup> - 12 <sup>th</sup> gr	Gary & Jenna Noble Keith Krueger & Melissa Diehl
"	"	"
204	Women	"Power of a Praying Woman"
103	Adult	"Old Testament Stories from the Backside"
209	Adult	"Life of Paul"
104	Adult	"Seeking Him"

# Youth "Ground Zero"

**YOUTH & PARENTS of ground zero** (7<sup>th</sup>-12<sup>th</sup> Grades)

[www.facebook.com](http://www.facebook.com) search: **groundzeroyouth and become a fan!**

Registration forms are available outside of Gary's office!

This Wed --> Godfather's

Division Place Mall -> 7:00pm

No Money Needed and Friends Welcome!

! Youth !

**On a Normal week (subject to being over-ridden by above)**

Sun Morns below zero

9:30 am - Youth Room

Snack - Connect - Chat

7<sup>th</sup> and 8<sup>th</sup> graders

Meet for DCI

Wed Nights ground zero

7:00 pm - See above for location

Godfather's or Youth Group

It's not Thursday until you've

spent Wednesday night with us!

**! Mattress Run !**

Sat March 1<sup>st</sup> at Riverside Park

10am to 1pm

Grab some friends and form a team!

**! Lost and Found Concert !**

Sun March 30<sup>th</sup> - 6pm

Wristbands (tickets) Now Available!

If you get one or more friends to go, YOUR wristband is free!

Looking Ahead!

Matress Run -> Sat March 1<sup>st</sup> -> 10am at Riverside Park

Is YOUR contact info updated?

get your new email, address etc... to Gary!

\*Get your current schedule to me too!

HOPE COVENANT CHURCH Gary@HopeCovenant.org

# Hope Happenings

Please join us today and support "Every Kid is a Camper" for our **9<sup>th</sup> Annual Wild Game Dinner** starting at noon. The money raised is used to assist children financially so they can attend Lake Beauty Bible Camp. *Take-out is available.* (Suggested donation: Adults: \$8.50; Children: \$4.50)

**Valentine Dinner:** Join us at Keith's Kettle in Clearwater for a delicious dinner special of Pork Prime Rib, or you can order off the regular menu. Special music throughout the evening by Jan Delovey. Arrive at 6:00 pm. Dinner starts at 6:30 pm. Sign up in the Welcome Center. All are welcome.

**Missions Ministry Team Organizational Meeting:**  
Monday, Feb. 11; 6:30 p.m.

at John & Jo Reinhart's house; 1117 4 1/2 Ave. North; Sauk Rapids  
phone: 253-0332; email: [jo76john@charter.net](mailto:jo76john@charter.net)



**Security System:** A new security system is being installed. Exterior door keys will not be used after March 2. Please return old keys to Pam Schirmers. Thanks. Any questions, please call Pam 257-4673.

**Lake Beauty Bible Camp:** call 1-800-732-1990 for registration  
Brochures are in the Welcome Center. Check it out!

**Host Homes Needed:** Amicus is an international student exchange program sponsored by Young Life, a non-denominational outreach ministry to teens. We are looking for Christian families to host high school students for the 2008-09 school year. Student applications from a number of countries will be available February 10th. Hosting an international student is a great opportunity to share Christ's love and demonstrate hospitality as a family. It gives you a natural and comfortable setting to make an impact on someone's life through your lifestyle and everyday situations. The exchange student and host family will receive support from the local Amicus representative and Young Life program. If you are interested in learning more, contact Lisa Myra at (320) 240-2392 or [lismyra@gmail.com](mailto:lismyra@gmail.com).

**Weekend to Remember**—(Marriage Retreat): March 14-16; Mpls Marriott-City Center; 1-800-FL-TODAY or [familylife.com/weekend](http://familylife.com/weekend); \$129/ person

**Marriage Encounter/Engaged Encounter:** Feb 16-17; Dakota Ridge Hotel (35E & Yankee Doodle; Egan). [www.marriages.org](http://www.marriages.org) or call 651-454-3238

**Moms In Touch:** Pray weekly with other women for area students, schools, teachers, and administrators. Contact Martha for meeting locations and times, 259-8074 or visit [www.momstouch.org](http://www.momstouch.org). Sartell group meets at Joy Anderson's home on Mondays at 8:45 am. Call Joy for more info 203-1449.

**Looking Ahead: Teen Challenge:** Coming Sunday, March 9

**Lost and Found Concert:** Here! Sunday, March 30; 6 pm; tickets \$10

HOPE COVENANT CHURCH Hope@HopeCovenant.org

# Prayers of Hope

**For Prayer Requests:** Contact John Reinhart at [jo76john@charter.net](mailto:jo76john@charter.net) or at 253-03332 or call the church office.

**Prayers:** for those serving in the armed forces and their families.

- for **Bertie**, Lila and Pam's mom, hospitalized with heart complications during her chemo treatment. Pray for strength and doctor's wisdom.

- for the **family of Martha Roth's Aunt Helen**. Helen passed away from cancer. Thanks to everyone who prayed for her.

- for **Deloris Busche** (from Ann Krueser Voss) for healing and recovery from intestinal surgery

- for a friend (from Stephanie) for guidance and acceptance of Christ.

- for **Kelly Grubb** (friend of Sankey's) has leukemia. She is 19 and is struggling with severe pain. Continue prayers for Kelly for comfort and peace.

**Prayer Updates:**

- for **Elena & Andy Ronnei and family** on the death of Andy's mother, **Elaine Ronnei**. Please pray for comfort and peace during this difficult time. Pray for guidance in the responsibilities that follow when parents pass away.

- for **Josh** (friend of Yvonne Lunser), lost his job and is married with three children. Please pray for God's direction and for employment opportunities.

- for **Kim Koop**. Continue prayers of healing.

**Praise and Congratulations!** to Abby and Craig Schneider on the birth of their baby girl born February 7. Her name is **Bailey Rose**.

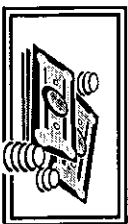

## Treasurer's Report

**OFFERINGS**

Budgeted Amount Each Week: \$ 8,163.00

Received 2/3 \$12,272.00

HOPE COVENANT CHURCH (320)257-HOPE

# Calendar of Hope

Today	8:15 a.m.	Worship Service (Nursery Available)
	9:30 a.m.	Sunday School
	10:45 a.m.	Worship Service (Nursery Available)
	10:30 a.m.	Laotian Worship Service
	12:00 noon	Wild Game Dinner, Fellowship Hall
	4:00 p.m.	Korean Worship
<b>Mon</b>		<b>Office Closed</b>
	6:30 p.m.	Mission Ministry Meeting at Reinhart's
	7:00 p.m.	Women's Bible Study; Living Rm.
	7:00 p.m.	Granite City Group; Fellowship Hall
	8:00 p.m.	AA; Big Book Study; Room 104
<b>Tues</b>	10:00 a.m.	Staff Meeting
<b>Wed</b>	6:30 p.m.	Odyssey
	6:30 p.m.	Men's Group
	7:00 p.m.	Youth Group at Godfather's
	7:00 p.m.	Choir
	8:00 p.m.	Worship Team Practice (for 1 <sup>st</sup> Service)
<b>Thurs</b>	9:00 a.m.	Women's Bible Study
	6:00 p.m.	Valentine's Dinner at Keith's Kettle
	6:30 p.m.	Home School Group
	7:00 p.m.	Worship Team Practice (for 2 <sup>nd</sup> Service)
<b>Fri</b>	9-12:00 noon	Upstream Ministry Meeting; Dopkins; Rm 204
<b>Sat</b>	8-5:00 p.m.	Home School Event
<b>Sun</b>	8:15 a.m.	Worship Service
	9:30 a.m.	Sunday School
	10:45 a.m.	Worship Service
	10:30 a.m.	Laotian Worship Service
	4:00 p.m.	Korean Worship Service

*(Hope Covenant activities are in bold)*

## Calendar Celebrations

**Birthdays this week:**

- 11 – Stephen Schneider
- 13 – Becky Dormbush
- 14 – Harold Keith
- 15 – Andrew Kaczor
- 16 – Barb Schewel

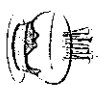

**Anniversaries this week:**

- 14 – Harold & Liz Keith
- 14 – Brad & LuAnn Martin



HOPE COVENANT CHURCH (320)257-HOPE

## MAP OF HOPE COVENANT CHURCH

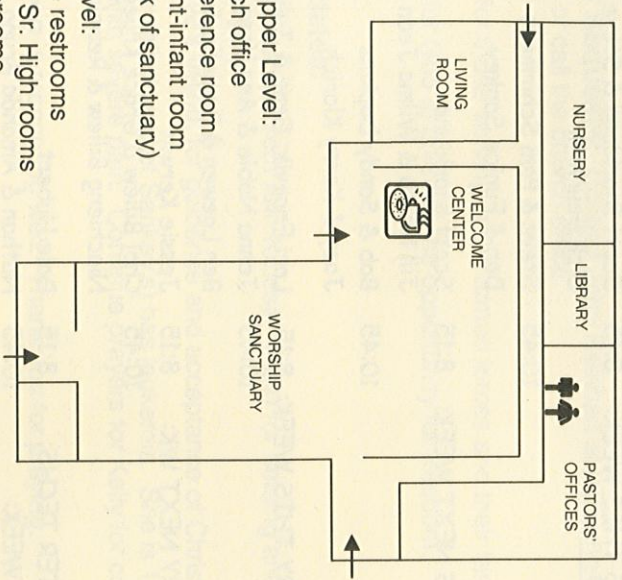

Also on Upper Level:

- church office
- conference room
- parent-infant room (back of sanctuary)

Lower Level:

- more restrooms
- Jr. & Sr. High rooms
- classrooms
- fellowship hall
- kitchen

*A recording of today's worship service is available by calling the church office.*

## Hope Covenant Church

336 – 4<sup>th</sup> Ave. S.  
St. Cloud, MN 56301  
320-257-HOPE (4673)  
[hope@hopecovenant.org](mailto:hope@hopecovenant.org)  
Web: [www.hopecovenant.org](http://www.hopecovenant.org)

Ministers: the congregation

Equippers: Bill Dornbush, Pastor; Gary Noble, Youth Pastor  
Kathy Armbrust, Christian Discipleship Coordinator  
Brad Martin, Worship Arts Director  
Kirsten Wagenius, Small Group Director  
Janelle Rudnigen-Office  
Pam Schimmers-Facilities

# HOPE COVENANT CHURCH

## 1883-2008

### CELEBRATING 125 YEARS OF GOD'S FAITHFULNESS

Celebration of Worship  
February 17, 2008  
8:15 & 10:45 am



Pastor John Rood  
and family  
1892



Pastor Bill Dornbush  
and family  
2008

## MAP OF HOPE COVENANT CHURCH

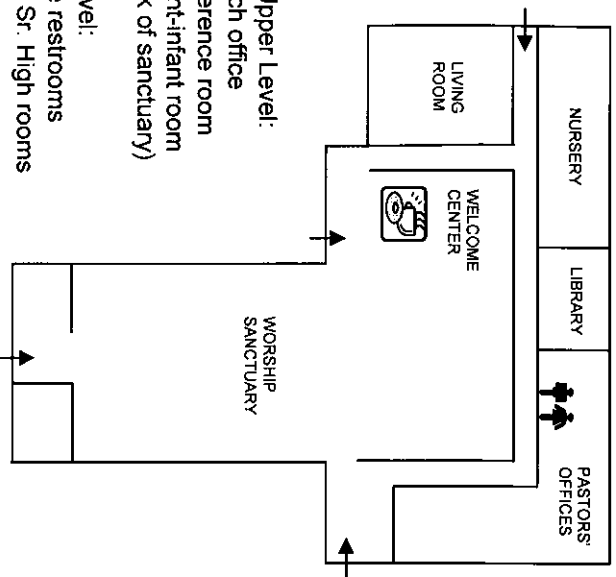

### Also on Upper Level:

- church office
- conference room
- parent-infant room (back of sanctuary)

### Lower Level:

- more restrooms
- Jr. & Sr. High rooms
- classrooms
- fellowship hall
- kitchen

*A recording of today's worship service is available upon request by calling the church office.*

## Hope Covenant Church

336 – 4<sup>th</sup> Ave. S.

St. Cloud, MN 56301

320-257-HOPE (4673)

[hope@hopecovenant.org](mailto:hope@hopecovenant.org)

Web: [www.hopecovenant.org](http://www.hopecovenant.org)

### Ministers: the congregation

Equippers: Bill Dornbush, Pastor & Gary Noble, Youth Pastor

Kathy Armbrust, Christian Discipleship Coordinator

Brad Martin, Worship Arts Director

Kirsten Wagenius, Small Group Director

Janelle Rudninggen-Office

Pam Schirmers-Facilities

# HOPE COVENANT CHURCH

## 1883-2008

## CELEBRATING 125 YEARS OF GOD'S FAITHFULNESS

Celebration of Worship

February 24, 2008

8:15 & 10:45 am



## SWEDISH CHURCH OF GOD

Rev. John Rood (middle of back row) and congregation at a Summer Sunday School Picnic in 1892. Rev. Rood came from Lake City and served for seven years, July 1892 to March 1899. The economic conditions were good in the early 1890's. Work was plentiful, and many Swedes moved into St. Cloud. The work of the Lord prospered.

## MAP OF HOPE COVENANT CHURCH

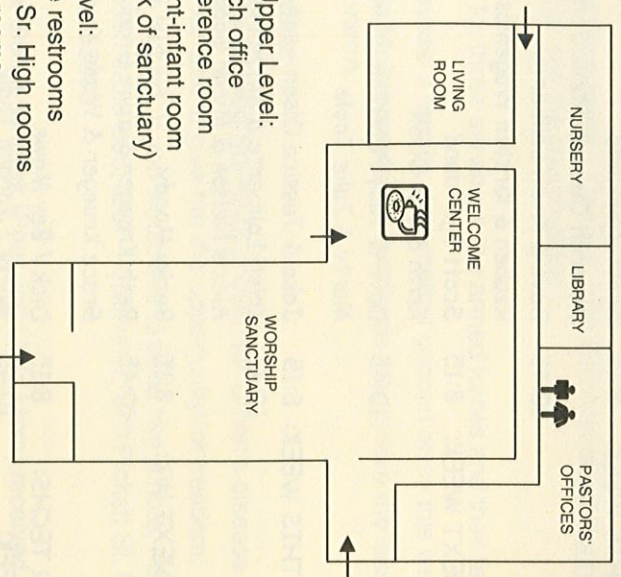

### Also on Upper Level:

- church office
- conference room
- parent-infant room (back of sanctuary)

### Lower Level:

- more restrooms
- Jr. & Sr. High rooms
- classrooms
- fellowship hall
- kitchen

*A recording of today's worship service is available upon request by calling the church office.*

## Hope Covenant Church

336 – 4<sup>th</sup> Ave. S.

St. Cloud, MN 56301

320-257-HOPE (4673)

[hope@hopecovenant.org](mailto:hope@hopecovenant.org)

Web: [www.hopecovenant.org](http://www.hopecovenant.org)

### Ministers: the congregation

Equippers: Bill Dornbush, Pastor & Gary Noble, Youth Pastor

Kathy Armbrust, Christian Discipleship Coordinator

Brad Martin, Worship Arts Director

Kirsten Wagenius, Small Group Director

Janelle Ruddingen-Office

Pam Schirmers-Facilities

# HOPE COVENANT CHURCH

## 1883-2008

### CELEBRATING 125 YEARS OF GOD'S FAITHFULNESS

Celebration of Worship

March 2, 2008

8:15 & 10:45 am

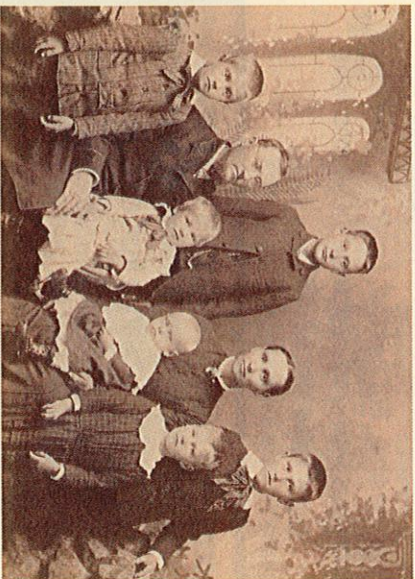

Pastor A. G. Nelson  
and family  
1889  
arrived from  
Anoka

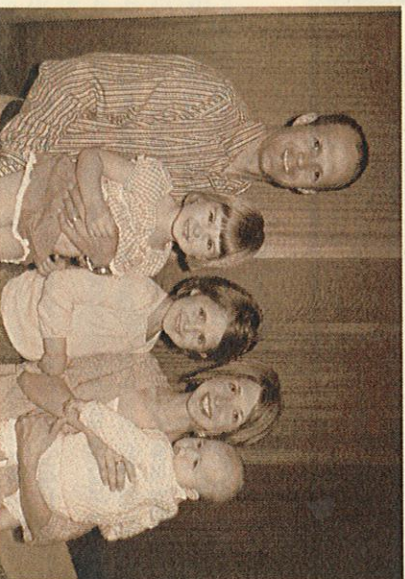

Pastor Gary Noble  
and family  
2008  
arrived from  
Dassel

**MAP OF HOPE COVENANT CHURCH**

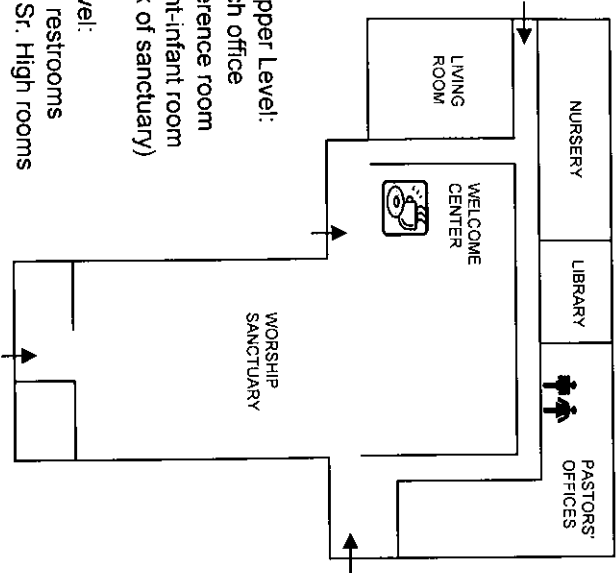

**Also on Upper Level:**

- church office
- conference room
- parent-infant room (back of sanctuary)

**Lower Level:**

- more restrooms
- Jr. & Sr. High rooms
- classrooms
- fellowship hall
- kitchen

*A recording of today's worship service is available upon request by calling the church office.*

**Hope Covenant Church**

336 - 4<sup>th</sup> Ave. S.

St. Cloud, MN 56301

320-257-HOPE (4673)

[hope@hopecovenant.org](mailto:hope@hopecovenant.org)

Web: [www.hopecovenant.org](http://www.hopecovenant.org)

**Ministers: the congregation**

Equipper: Bill Dornbush, Pastor & Gary Noble, Youth Pastor

Kathy Armbrust, Christian Discipleship Coordinator

Brad Martin, Worship Arts Director

Kirsten Wagenius, Small Group Director

Janelle Ruddingen-Office

Pam Schimmers-Facilities

**HOPE COVENANT CHURCH**

**1883-2008**

**CELEBRATING 125 YEARS  
OF GOD'S FAITHFULNESS**

*Celebration of Worship*

March 9, 2008

8:15 & 10:45 am



Mrs. Fanny Olson and the Children's Choir

~1937~

(we have 18 of these little robes that you will see on our Children's Bell Choir soon)

# HOPE COVENANT CHURCH

1883-2008

CELEBRATING 125 YEARS  
OF GOD'S FAITHFULNESS

Celebration of Worship  
March 30, 2008  
8:15 & 10:45 am

## MAP OF HOPE COVENANT CHURCH

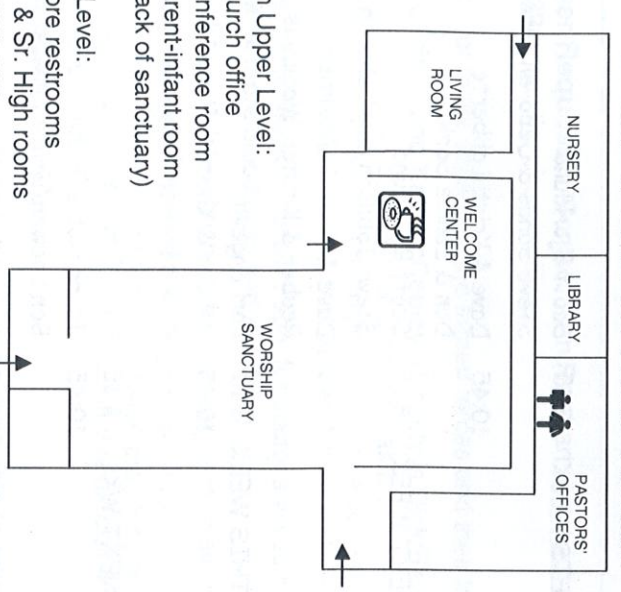

- Also on Upper Level:
- church office
  - conference room
  - parent-infant room (back of sanctuary)

- Lower Level:
- more restrooms
  - Jr. & Sr. High rooms
  - classrooms
  - fellowship hall
  - kitchen

A recording of today's worship service is available upon request by calling the church office.

## Hope Covenant Church

336 – 4<sup>th</sup> Ave. S.  
St. Cloud, MN 56301  
320-257-HOPE (4673)

[hope@hopecovenant.org](mailto:hope@hopecovenant.org)  
Web: [www.hopecovenant.org](http://www.hopecovenant.org)

- Ministers: the congregation  
Equippers: Bill Dornbush, Pastor  
Gary Noble, Youth Pastor  
Kathy Armbrust, Christian Discipleship Coordinator  
Brad Martin, Worship Arts Director  
Kirsten Wagenius, Small Group Director  
Janelle Rudningen-Office  
Pam Schirmers-Facilities

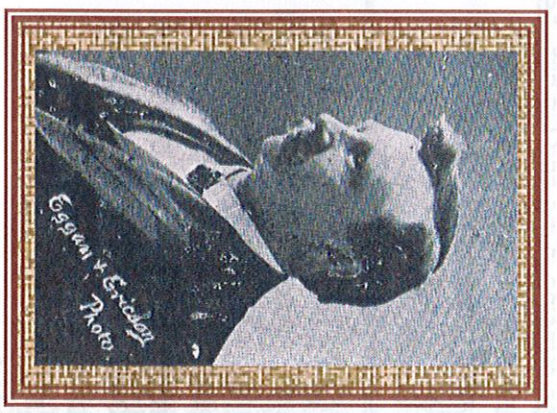

C.A. Soderman had the 1<sup>st</sup> choir in 1888 and is remembered for saving money on choir music by hand copying the parts for his choir.

Lowell Larson has been directing the choir here at Hope since the early 1980's and also is known for using choir music multiple times over to save costs.



# HOPE COVENANT CHURCH

1883-2008

CELEBRATING 125 YEARS  
OF GOD'S FAITHFULNESS

Celebration of Worship

April 6, 2008

8:15 & 10:45 am

Pastor Rick Mylander  
went to North Park Theological Seminary  
in Chicago and served here from  
1980 until 1996.



L. J. Hagquist  
A charter member  
in 1883  
(any resemblance?)



## MAP OF HOPE COVENANT CHURCH

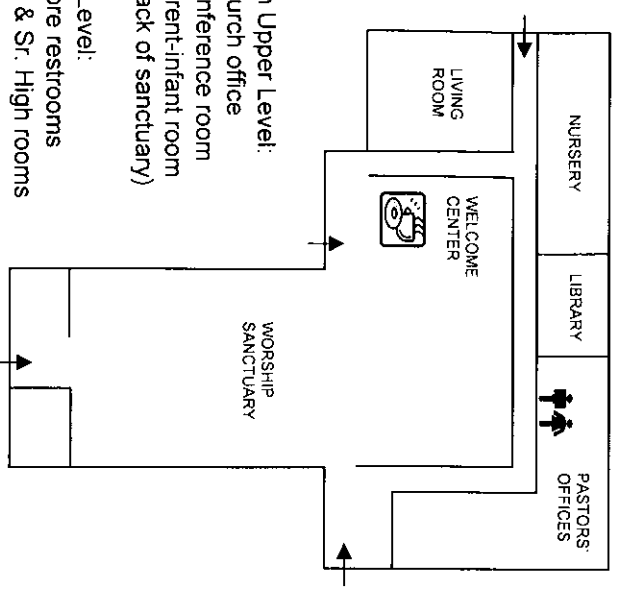

Also on Upper Level:

- church office
- conference room
- parent-infant room (back of sanctuary)

Lower Level:

- more restrooms
- Jr. & Sr. High rooms
- classrooms
- fellowship hall
- kitchen

A recording of today's worship service is available upon request by calling the church office.

## Hope Covenant Church

336 - 4<sup>th</sup> Ave. S.

St. Cloud, MN 56301

320-257-HOPE (4673)

[hope@hopecovenant.org](mailto:hope@hopecovenant.org)

Web: [www.hopecovenant.org](http://www.hopecovenant.org)

Ministers: the congregation

Equippers: Bill Dornbush, Pastor

Gary Noble, Youth Pastor

Kathy Arnbrust, Christian Discipleship Coordinator

Brad Martin, Worship Arts Director

Kirsten Wagenius, Small Group Director

Janelle Rudnigen-Office

Pam Schimmers-Facilities

**MAP OF HOPE COVENANT CHURCH**

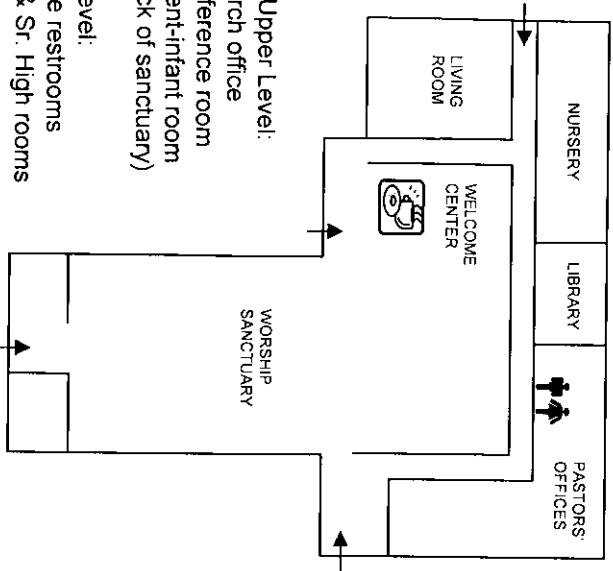

**Also on Upper Level:**

- church office
- conference room
- parent-infant room (back of sanctuary)

**Lower Level:**

- more restrooms
- Jr. & Sr. High rooms
- classrooms
- fellowship hall
- kitchen

*A recording of today's worship service is available upon request by calling the church office.*

**Hope Covenant Church**

336 – 4<sup>th</sup> Ave. S.  
 St. Cloud, MN 56301  
 320-257-HOPE (4673)  
[hope@hopecovenant.org](mailto:hope@hopecovenant.org)  
[Web: www.hopecovenant.org](http://www.hopecovenant.org)

**Ministers: the congregation**

- Equippers: Bill Dornbush, Pastor  
 Gary Noble, Youth Pastor  
 Kathy Armbrust, Christian Discipleship Coordinator  
 Brad Martin, Worship Arts Director  
 Kirsten Wagenius, Small Group Director  
 Janelle Rudningen-Office  
 Pam Schimmers-Facilities

**HOPE COVENANT CHURCH**

1883-2008

CELEBRATING 125 YEARS  
 OF GOD'S FAITHFULNESS

Celebration of Worship  
 April 13, 2008  
 8:15 & 10:45



**~The Young People's Society~**

(an early version of Youth Group that met on Sunday evenings for bible study and fellowship. They raised support for many mission projects and missionaries.)

**MAP OF HOPE COVENANT CHURCH**

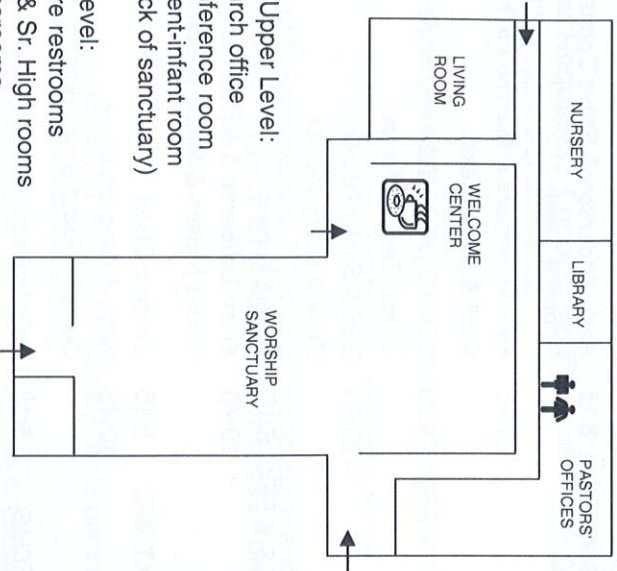

**Also on Upper Level:**

- church office
- conference room
- parent-infant room (back of sanctuary)

**Lower Level:**

- more restrooms
- Jr. & Sr. High rooms
- classrooms
- fellowship hall
- kitchen

*A recording of today's worship service is available upon request by calling the church office.*

**Hope Covenant Church**

**336 – 4<sup>th</sup> Ave. S.**

**St. Cloud, MN 56301**

**320-257-HOPE (4673)**

**[hope@hopecovenant.org](mailto:hope@hopecovenant.org)**

**[www.hopecovenant.org](http://www.hopecovenant.org)**

Ministers: the congregation

Equippers: Bill Dornbush, Pastor

Gary Noble, Youth Pastor

Kathy Armbrust, Christian Discipleship Coordinator

Brad Martin, Worship Arts Director

Kirsten Wagenius, Small Group Director

Janelle Rudningen-Office

Pam Schirmers-Facilities

**HOPE COVENANT CHURCH**

**1 888-2008**

**CELEBRATING 125 YEARS**

**OF GOD'S FAITHFULNESS**

**Celebration of Worship**

**April 20, 2008**

**8:15 & 10:45**

Rev. Carl Olson and family arrived from Winnipeg, Canada and served from 1915-1919

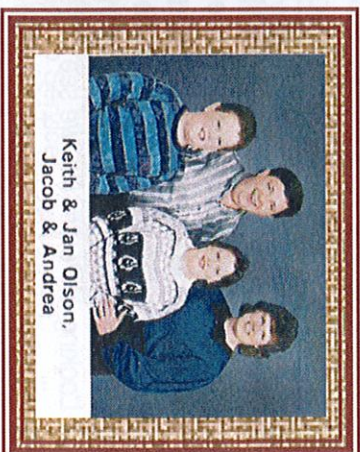
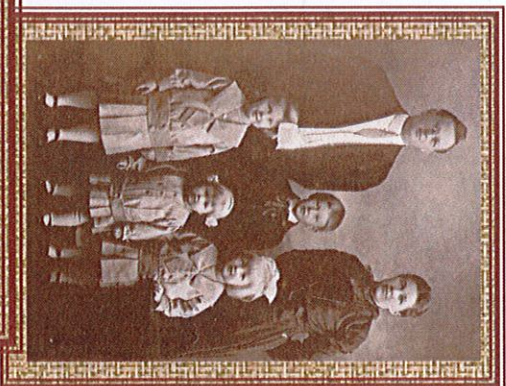

Keith Olson Family came in 1981

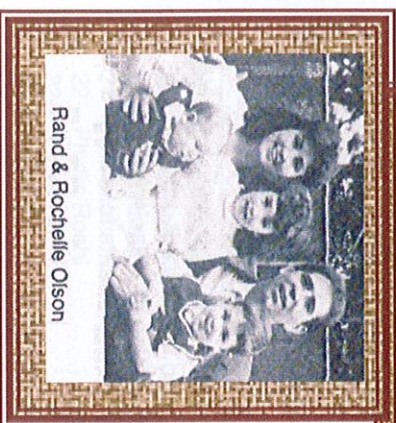

Rand & Rochelle Olson

Rand Olson Family. Rochelle & Rand, Lydia, Luke, & Aaron. Rand came as a teen in the 70's.



Jake & Jessica Olson, Evan, Haylee

Jake Olson Family. Jake is a 5<sup>th</sup> Generation Covenanter. Evan & Haylee are 6<sup>th</sup> Generation.

# HOPE COVENANT CHURCH

1883-2008

CELEBRATING 125 YEARS  
OF GOD'S FAITHFULNESS

Celebration of Worship

May 4, 2008  
8:15 & 10:45

## MAP OF HOPE COVENANT CHURCH

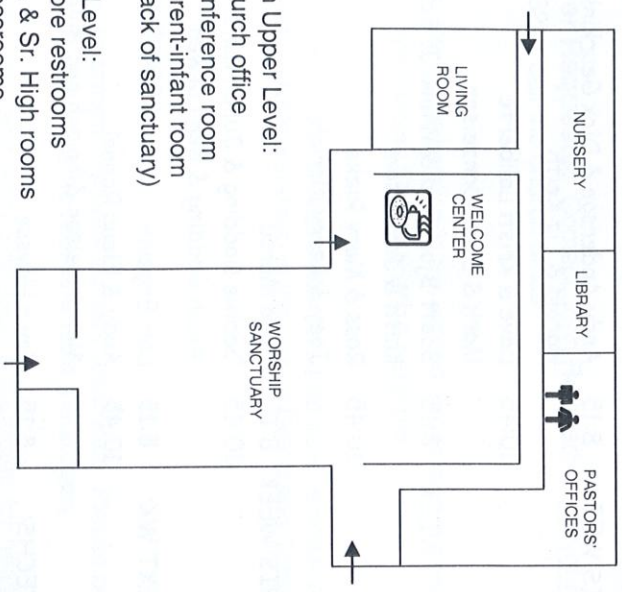

### Also on Upper Level:

- church office
- conference room
- parent-infant room (back of sanctuary)

### Lower Level:

- more restrooms
- Jr. & Sr. High rooms
- classrooms
- fellowship hall
- kitchen

*A recording of today's worship service is available upon request by calling the church office.*

## Hope Covenant Church

336 – 4<sup>th</sup> Ave. S.

St. Cloud, MN 56301

320-257-HOPE (4673)

[hope@hopecovenant.org](mailto:hope@hopecovenant.org)

Web: [www.hopecovenant.org](http://www.hopecovenant.org)

Ministers: the congregation

Equipppers: Bill Dornbush, Pastor

Gary Noble, Youth Pastor

Kathy Armbrust, Christian Discipleship Coordinator

Brad Martin, Worship Arts Director

Kirsten Wagenius, Small Group Director

Janelle Rudnigen-Office

Pam Schimmers-Facilities



Director in 1937 - Fanny Olson



Director in 2008 - Kathy Armbrust

The Children's Bell Choir  
Then (1937) and Now (2008)

**MAP OF HOPE COVENANT CHURCH**

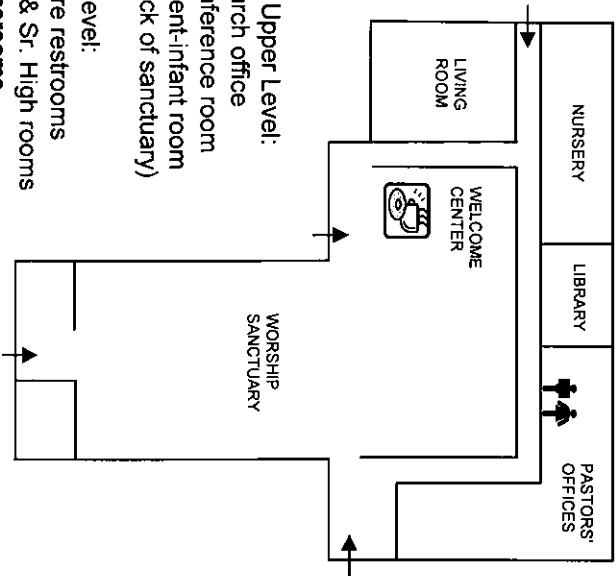

**Also on Upper Level:**

- church office
- conference room
- parent-infant room (back of sanctuary)

**Lower Level:**

- more restrooms
- Jr. & Sr. High rooms
- classrooms
- fellowship hall
- kitchen

*A recording of today's worship service is available upon request by calling the church office.*

**Hope Covenant Church**

336 – 4<sup>th</sup> Ave. S.

St. Cloud, MN 56301

320-257-HOPE (4673)

[hope@hopecovenant.org](mailto:hope@hopecovenant.org)

[Web: www.hopecovenant.org](http://www.hopecovenant.org)

Ministers: the congregation

Equippers: Bill Dombush, Pastor

Gary Noble, Youth Pastor

Kathy Armbrust, Christian Discipleship Coordinator

Brad Martin, Worship Arts Director

Kirsten W'agenius, Small Group Director

Janelle Rudningen-Office

Pam Schirmers-Facilities

**HOPE COVENANT CHURCH**

**1883-2008**

CELEBRATING 125 YEARS  
OF GOD'S FAITHFULNESS

Celebration of Worship

May 11, 2008

8:15 & 10:45



1905 Confirmation class with Pastor E. V. Bjorklund. Check out the pews in the photo above. Two of those pews remain in our building. They now reside in the balcony.

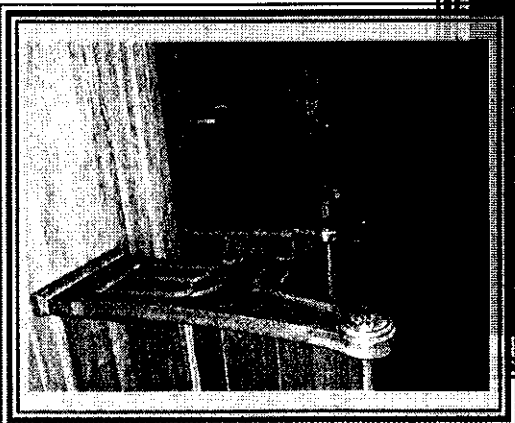

HOPE COVENANT CHURCH

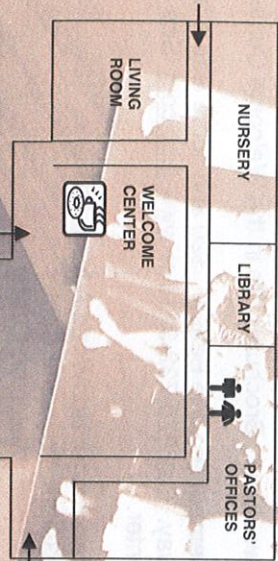

A recording of today's worship service is available upon request by calling the church office.

# HOPE COVENANT CHURCH

336 - 4<sup>TH</sup> AVE. S.  
ST. CLOUD, MN 56301

Web: [www.hopecovenant.org](http://www.hopecovenant.org)

- Bill Dornbush, Pastor
- Gary Noble, Youth Pastor
- Kathy Armbrust, Christian Discipleship Coordinator
- Brad Martin, Worship Arts Director
- Kirsten Wagenius, Small Group Director
- Janelle Ruddingen-Office
- Pam Schimmers-Facilities

# HOPE COVENANT CHURCH

1 888-3-2008

125 YEARS OF GOD'S FAITHFULNESS

## CONFIRMATION SUNDAY

MAY 18, 2008

9:30 AM



Confirmation Class through the years has been an important part of our young people's faith journey in our Covenant church history. Color photo is our current class. Leaders this year are Joanne Reinhart and Mark Nelson.

**MAP OF HOPE COVENANT CHURCH**

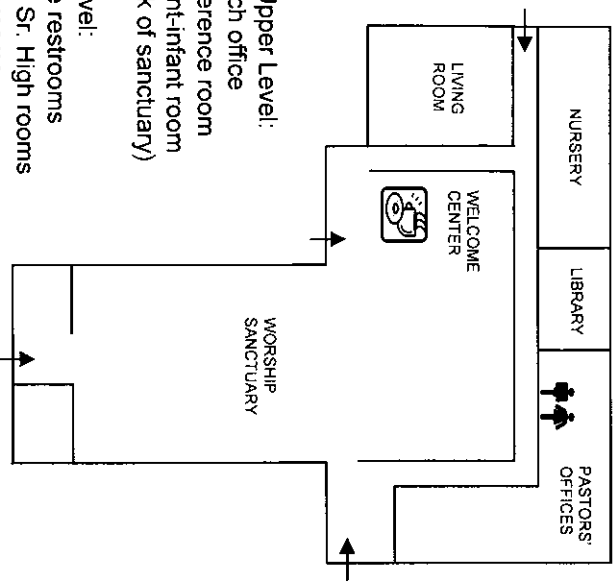

**Also on Upper Level:**

- church office
- conference room
- parent-infant room (back of sanctuary)

**Lower Level:**

- more restrooms
- Jr. & Sr. High rooms
- classrooms
- fellowship hall
- kitchen

*A recording of today's worship service is available upon request by calling the church office.*

**Hope Covenant Church**

336 – 4<sup>th</sup> Ave. S.

St. Cloud, MN 56301

320-257-HOPE (4673)

[hope@hopecovenant.org](mailto:hope@hopecovenant.org)

Web: [www.hopecovenant.org](http://www.hopecovenant.org)

**Ministers: the congregation**

Equipper: Bill Dornbush, Pastor & Gary Noble, Youth Pastor

Kathy Armbrust, Christian Discipleship Coordinator

Brad Martin, Worship Arts Director

Kirsten Wagenius, Small Group Director

Janelle Rudningen-Office

Pam Schrimers-Facilities

**HOPE COVENANT CHURCH**

1883-2008

125 YEARS OF GOD'S FAITHFULNESS

Celebration of Worship

May 25, 2008

9:30am

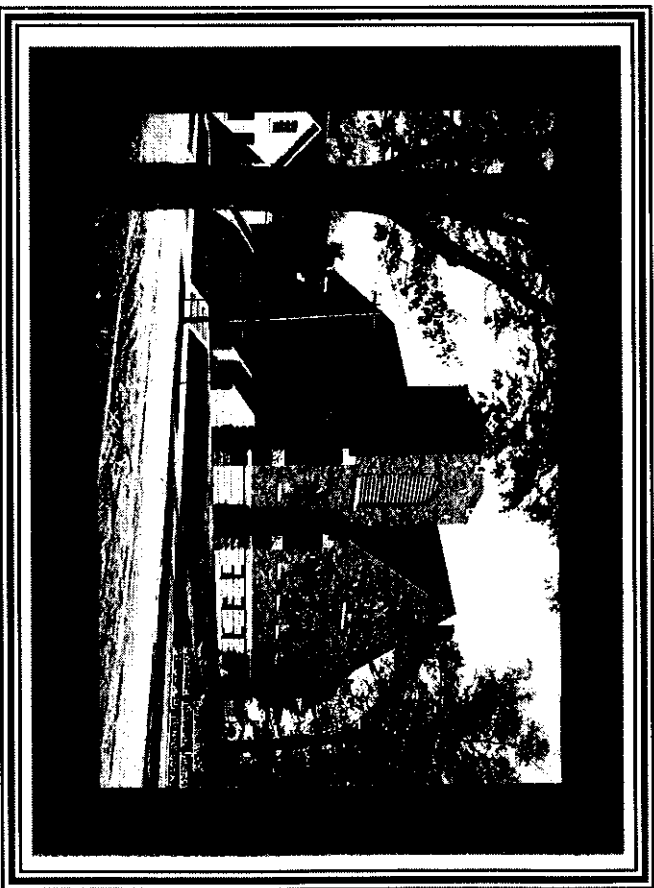

In May of 1916, it was decided to "build a new church as soon as we can venture the undertaking".

The "new" brown brick church was erected in 1921 at a cost of \$21,000 and was located on the East Side of St. Cloud.

This facility was used for over 50 years. We still have a stained glass window from it. More on that later.

**MAP OF HOPE COVENANT CHURCH**

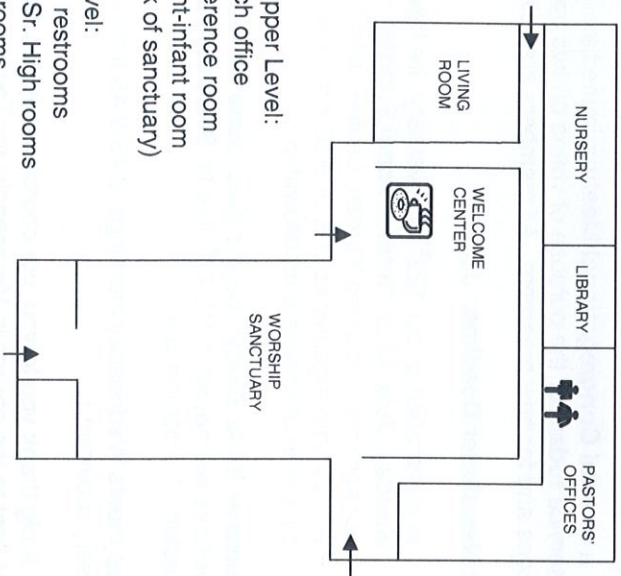

- Also on Upper Level:
- church office
  - conference room
  - parent-infant room (back of sanctuary)

- Lower Level:
- more restrooms
  - Jr. & Sr. High rooms
  - classrooms
  - fellowship hall
  - kitchen

*A recording of today's worship service is available upon request by calling the church office.*

**Hope Covenant Church**

336 – 4<sup>th</sup> Ave. S.  
 St. Cloud, MN 56301  
 320-257-HOPE (4673)  
[hope@hopecovenant.org](mailto:hope@hopecovenant.org)  
 Web: [www.hopecovenant.org](http://www.hopecovenant.org)

Ministers: the congregation  
 Equippers: Bill Dornbush, Pastor & Gary Noble, Youth Pastor  
 Kathy Armbrust, Christian Discipleship Coordinator  
 Brad Martin, Worship Arts Director  
 Kirsten Wagenius, Small Group Director  
 Janelle Rudningen-Office  
 Pam Schirmers-Facilities

**HOPE COVENANT CHURCH**

1883-2008

**125 YEARS OF GOD'S FAITHFULNESS**

**Celebration of Worship**

June 8, 2008  
 9:30am



*"The Trophy Case"*  
 Some of these trophies date back to 1928. Softball has been prominent through the years.



In the 1970's, collection plates were passed following games to help make the mortgage payment.

## I Remember

Pastor Dave & Karen & Todd Erickson, Joe (Candy man) & Estelle Larson  
 Hilda ~~Holmgren~~ <sup>Holmgren</sup>, Elmer & Ida Youngberg, Scotty & Jeanie Gustafson  
 Jim & Lois Anderson, Terry & Ginny Greener, Verona Wolcott  
 Ray & Nancy Fitch, Tim Johnson, Dan Johnson, Mr & Mrs Alfred ~~Johnson~~ <sup>Johnson</sup>  
 Gary & Deb Van Der Pol, Priscilla Mohren Veiser, Annie & Betty Anderson  
 George & Ina Anderson, Shirley Gazy, Leona Johnson Elsie Sand  
 Ron & Kathy Watkins, 1974 annual budget \$31,239,  
 John & Nancy Haarsstad, Dick & Betty Aust, George & Virginia Leih  
 Becky Leih, Chris & Patsy McCabe, Phil & Darlene Thompson  
 Harold & Belle Beeler, Mr & Mrs Bernice Fagerman, Dar ~~Johnson~~  
 Pastor & Mrs John Klopsch, Larry & Maggie Hanson, Ross & Judy Toerhof  
 George & Angie Paul, Pastor Paul & Shirley Mann, Cindee Anderson  
 Rob & Denise Babcock, Sandy Babick, Barry & Laura Back,  
 Doug & Pam Benson, Pusan & Jenny Bjorlins, Pastor Wayne & Mrs Hall,  
 Gordon & Danita Bye, Brad & Gail Currier, John & Carol Erickson  
 Greg & Stefanie Carlson, Mitch & Mary Groethe, Scot & Gretchen  
 Hatten, John & Nona Huxler, Linda Hart, David & Alvina Johnson,  
 Barb Kaasa, Ron Kaczor, Fran Korlath, Bill & Ann Krivanek,  
 Ginger Lentner, Tim & Joann McDunn, Steve ~~Denoman~~  
 Bill & Carole Miller, Chris & Jen Monroe, Joel & April Nelsons  
 Marty & Deb New, Keith & Terry Olson, Ken & Jan Panger,  
 Phil & Pam Rockensock, Marie Sand, Lloyd & Sylvia Sankey,  
 Jules & Sharon Schreitels, Ann Schroeder, Sharon Schulte,  
 Paul Schultz, Lee & Billie Severson, Gary & Joan Sohlstrom,  
 Ken Stob, Rich & Nancy Sandherrn, Rick & Cathay Wallace  
 Ben & Kelly Ward, Rick & Marla Beckman, Miff & Allison  
 Blomberg, Vickie Gleason, Rob & Dana Gotz, Clara Hanson  
 Bob & Pat Hinds, Dennis & Sue Johnson, Pastor Terry & Jane  
 Johnson, Joe & Dawn Kraayenbrink, Ken & Paula Lamphier,  
 John & Lanette Leigh, Lois Anne Louviere, Paul & Norma Morton,  
 Scott & Gail Mossman, Neil & Sherry Ohnsheid, Kevin & Joy Olson  
 Doug & Kristi Pearson, John & Jamie Pederson, Pastor Chris Peterson

Randy & Anna Rueter, Sheldon & Tammie Schmies, Jim & Lois Weeks, John & Connie Engberg, George & Elaine Hick, Gail Hodgson, Nick & Kelly Jo Paiksich, Dave & Janet Albrecht, Sue Thomas, Pastor Bob & Robin Anderson, Carl & Deb Brumbaugh, Clemente & Zenaida DeGuzman, Barry Moberg, ~~the~~ Pastor Wes & Harriet Olson, Tom Erlandson, Dick & Mardi Longsdorf, Pooh & Souk Vong Khamdy, Steve & Sharon Lund, Greg & Lori Molus, Steve & Julie Ringsmith, Paul & Laurie Vande Kamp, George Vigorner, Jon ~~Sey~~ Seykora, Greg & Julie Ellis, Dan & Deb Ploot, Kevin & Carolyn Quinlivan, Nate & Marlene Weeks, Joe & Peggy Guzzardo, Harry & Terry Wilson, Anita Bavarp, Eli & Kay Bukouch, Jack & Kathy Feia, Sandy Anderson, Don & Becky Hamlen, Rick, Hamlen's, Rony Lewandowski's, Tom & Diane Pederson, Peter Thorpe's,

I have the privilege of worshipping the ~~past~~ <sup>past</sup> 34 years with Ken & Julie Johnson, Ralph & Bev Kluball, Dennis & Karen Witzman, Rand Olson & Mary Jo - ~~Anderson~~ -Wager.

Here is a test to find whether your mission on earth is finished. If you're alive it isn't.  
Richard Bach

## "I REMEMBER . . ."

(People who influenced my faith at Hope; the best event at Hope; a challenging time at Hope; first person I met at Hope, what my children enjoy most at Hope . . . other recent or past memories?)

I remember worshipping with these people, most, if not all, have moved on <sup>and</sup> in some instances have passed on ~~to eternity~~.

Andy Anderson  
Name

We are looking for memorable moments from everyone regarding a special memory here at Hope. They will be compiled with the 125<sup>th</sup> Anniversary items. Please take a minute and fill out the form and mail it in or place in the basket in the Welcome Center by September 14. Hope to see you on October 25.

## "I REMEMBER . . ."

(People who influenced my faith at Hope; the best event at Hope; a challenging time at Hope; first person I met at Hope, what my children enjoy most at Hope . . . other recent or past memories?)

I remember when "Covenant Women" would have its yearly garage sale, and Hilda Holmgren was a faithful volunteer. One year when the garage sale was at the <sup>Haarstad's</sup> Haastad's, Hilda was taking a break from working at the sale, and went in the house! When she came back out, her coat had been sold! As gracious as Hilda was, she shrugged her shoulders and said, "At least we made some money!"

Name Cheryl Larson

I plan to attend the Anniversary celebration on October 25

Cheryl  
Larson

We are looking for memorable moments from everyone regarding a special memory here at Hope. They will be compiled with the 125<sup>th</sup> Anniversary items. Please fill out the form below and place in the basket in the Welcome Center by September 14.

## "I REMEMBER . . ."

Ken Johnson,  
John Reinhardt

(People who influenced my faith at Hope; the best event at Hope; a challenging time at Hope; first person I met at Hope, what my children enjoy most at Hope . . . other recent or past memories?)

I remember when Pastor Bill came out to my place & prayed and helped me write a letter to pastor Rick Mylander it helped me a lot. I remember Keith Olson praying for me and helping me, also Don Banker and the other Elders. I also remember many times Pam Schirmer's spending time and helping me and praying for me. I remember all the great times at Hope Covenant Church over the winter yrs  
Mike Batcheller

Name

We are looking for memorable moments from everyone regarding a special memory here at Hope. They will be compiled with the 125<sup>th</sup> Anniversary items. Please take a minute and fill out the form and mail it in or place in the basket in the Welcome Center by September 14. Hope to see you on October 25.

## “I REMEMBER . . .”

(People who influenced my faith at Hope; the best event at Hope; a challenging time at Hope; first person I met at Hope, what my children enjoy most at Hope . . . other recent or past memories?)

I remember the preaching of  
pastor Rich and his love and  
patience. I remember being proud  
for by Tom Ennasti and the  
elders of the church. I felt like  
I was inside a big power  
plant. I remember the times  
when Ken Johnson prayed  
with me and counseled me  
also many others in the  
church spending time  
with me. I also remember  
the John Riemann spent  
praying and counseling me

Name \_\_\_\_\_

I plan to attend the Anniversary celebration on October 25

We are looking for memorable moments from everyone regarding a special memory here at Hope. They will be compiled with the 125<sup>th</sup> Anniversary items. Please fill out the form below and place in the basket in the Welcome Center by September 14.

## “I REMEMBER . . .”

(People who influenced my faith at Hope; the best event at Hope; a challenging time at Hope; first person I met at Hope, what my children enjoy most at Hope . . . other recent or past memories?)

I really loved helping out with VBS! Being involved with such enthusiasm + energy is awesome, and I learned so much too! We are never too old to learn, even from children, if <sup>we keep</sup> our hearts open. Labor Day Family Camp 2008 was awesome too! Steve + Pam Schirmers have a little home there, (camper + everything you could possibly want or need), and they have such a gift of hospitality as many from Hope gather 'round the campfire.

Rebecca + Sandra Theirs challenged →

Name

me to go on the zipline @  
10:00 P.M. so we went. That  
was an awesome experience  
also. Kerry Klarich  
Klarich

We are looking for memorable moments from everyone regarding a special memory here at Hope. They will be compiled with the 125<sup>th</sup> Anniversary items. Please take a minute and fill out the form and mail it in or place in the basket in the Welcome Center by September 14. Hope to see you on October 25.

## "I REMEMBER . . ."

(People who influenced my faith at Hope; the best event at Hope; a challenging time at Hope; first person I met at Hope, what my children enjoy most at Hope . . . other recent or past memories?)

One of my favorite memories takes place in Barb Schaevel's <sup>vet's</sup> screen porch when she held this summer's Fruit of the Spirit Bible study. I'm not sure which "fruit" we were discussing, but Barb passed around <sup>an</sup> a music sheet with two <sup>songs</sup> songs on it, one of them titled something like "It is Well with My Soul." Right there, outside, with her neighbors nearby and without instrumental back up, Barb had us sing these <sup>poignant</sup> songs with her. Our ~~acappella~~ <sup>acappella</sup> believing voices filled the open air, God's sky, our church dome, and it made me feel as though ~~were~~ we were the disciples straight from the Book of Acts, boldly glorifying God without care of others' derision. Name Ashley Isaacson

I plan to attend the Anniversary celebration on October 25

derision →

Isaacson

8

We are looking for memorable moments from everyone regarding a special memory here at Hope. They will be compiled with the 125<sup>th</sup> Anniversary items. Please fill out the form below and place in the basket in the Welcome Center by September 14.

# "I REMEMBER . . ."

(People who influenced my faith at Hope; the best event at Hope; a challenging time at Hope; first person I met at Hope, what my children enjoy most at Hope . . . other recent or past memories?)

- Nancy Haarstad <sup>being</sup> ~~Nancy Haarstad~~ being one of the first persons we met <sup>we started</sup> when ~~started~~ coming to Hope in 1982. She acted as <sup>unofficial</sup> ~~unofficial~~ <sup>friendly</sup> ~~friendly~~ greeter each Sunday while we were church shopping.
- Andy Anderson, <sup>an usher</sup> always being ~~usher~~ - and another unofficial greeter to us.
- The 1994 <sup>excursion</sup> mens excursion to Promise Keepers in Colorado <sup>worship</sup> - as great time of fellowship & worship
- ~~The 1994~~ Hope Covenant <sup>hosting</sup> the Curiallo weekends (men/women) <sup>weekends</sup> ~~weekends~~ <sup>and serving on my first team</sup> ~~and serving on my first team~~ after attending a Curiallo weekend <sup>after</sup> in 1995, <sup>weekend</sup>

on an  
Don Sawyer  
Name

We are looking for memorable moments from everyone regarding a special memory here at Hope. They will be compiled with the 125<sup>th</sup> Anniversary items. Please fill out the form below and place in the basket in the Welcome Center by September 14.

## “I REMEMBER . . .”

(People who influenced my faith at Hope; the best event at Hope; a challenging time at Hope; first person I met at Hope, what my children enjoy most at Hope . . . other recent or past memories?)

I walked into Mission Covenant Church as an 18 year old looking for fellowship as a new Christian. I was greeted warmly by Pastor Dave Erikson who ~~took~~ warmly welcomed me to my new family. He took the time to disciple me and encouraged me in my faith. Priscilla ~~my~~ Ken + Julie Johnson also ~~my~~ reached out to me and invited me to their home cell group. That was 34 years ago and the rest is history. I am <sup>Name</sup> thankful.  
RANS OLSON

We are looking for memorable moments from everyone regarding a special memory here at Hope. They will be compiled with the 125<sup>th</sup> Anniversary items. Please fill out the form below and place in the basket in the Welcome Center by September 14.

## “I REMEMBER . . .”

(People who influenced my faith at Hope; the best event at Hope; a challenging time at Hope; first person I met at Hope, what my children enjoy most at Hope . . . other recent or past memories?)

Reuben & I attended a few weeks before we were married in September 2004. Although I was deeply connected to the Covenant churches through childhood & vocation, it was important that together we found a spiritual home. That Sunday we were welcomed in by several people — <sup>Pastor</sup> Gary & Jenna Noble (who later invited us and ~~several~~ other new couples to start a new small group), Bill & Jan Wilde-DeLovely (who was excited to play from the Covenant hymn<sup>al</sup> at our wedding two weeks later), ~~and~~ Janny & Bob Stoney (who invited us almost immediately to come to the women's bible study and talk more about the mission<sup>s</sup> team), and <sup>Pastor</sup> Bill Dornbush (who made a point of introducing himself after the service).

Kirsten (Nelson) Wagenius<sup>45</sup>  
Name  
Kirsten

We are looking for memorable moments from everyone regarding a special memory here at Hope. They will be compiled with the 125<sup>th</sup> Anniversary items. Please fill out the form below and place in the basket in the Welcome Center by September 14.

through

## "I REMEMBER . . ."

(People who influenced my faith at Hope; the best event at Hope; a challenging time at Hope; first person I met at Hope, what my children enjoy most at Hope . . . other recent or past memories?)

Jenna & I going thru 2 pregnancies while we've been  
~~being pregnant twice~~ @  
here at Hope and having the church  
and youth celebrate and  
enjoy that with us. ~~and~~  
having the youth guess our  
due dates was also a great  
memory for our family.

GARY Noble

Name

I Remember:

The people who influenced my Faith at Hope was Maggie & Scott Bjorklund. She many relationships in their lives they have. With the life my husband & I had in the military family, we had that. We needed new relationships in our lives. The Lord guided us right.

The best event at Hope was The 40 days of Community. Rick Warren's Studies are heart & mind opening.

When I first heard Bill speak ~~he~~ truly touched my heart. He spoke on a level that was simple to understand. I thank him for that.

All the gathering events  
were so warm & welcoming.  
Such sincere givers. Pam &  
Steve Schirmers ~~had~~ such <sup>an</sup> eye  
opening of a good sharing  
couple to their community  
church.

So far its been a new  
beginning in my life  
joining HOPE. I praise  
the Lord for the light  
he has shined on my  
path to be closer to Him.  
HOPE a Stepping  
Stone.

Thanks

Jean  
Witma Jean  
Schweigel Schweigel

P.S. Meeting with the  
ladies in my Small Group  
& Womens Ministries was an  
added touch of stepping stones.

We are looking for memorable moments from everyone regarding a special memory here at Hope. They will be compiled with the 125<sup>th</sup> Anniversary items. Please fill out the form below and place in the basket in the Welcome Center by September 14.

## “I REMEMBER . . .”

(People who influenced my faith at Hope; the best event at Hope; a challenging time at Hope; first person I met at Hope, what my children enjoy most at Hope . . . other recent or past memories?)

One of my <sup>memorable</sup> memorable experiences was when I was Church arganist in the late 60's. Dave Erickson was our pastor. We were both new to our jobs and our <sup>nerves were</sup> nerves were working <sup>overtime</sup> overtime. Every Sunday I meet Dave downstairs at the <sup>bathrooms</sup> bathrooms. The <sup>men's & women's</sup> men's & women's <sup>Bathroom</sup> B.R. were side by side. We'd laugh - "relieved" exchange a comment & then "relieved" and hurry <sup>hurry</sup> upstairs to start the Church service. service

Julie Johnson

Name

We are looking for memorable moments from everyone regarding a special memory here at Hope. They will be compiled with the 125<sup>th</sup> Anniversary items. Please fill out the form below and place in the basket in the Welcome Center by September 14.



## "I REMEMBER . . ."

(People who influenced my faith at Hope; the best event at Hope; a challenging time at Hope; first person I met at Hope, what my children enjoy most at Hope . . . other recent or past memories?)

Our little Brick Church on the Eastside was so inviting & everyone was so friendly. The only <sup>problem</sup> ~~problems~~ was that they seemed so old! They were at least in their 60's & we were 30. We had 3 small children & 2 of them (girls) were quite noisy. They had high, piercing screams - needless to say, I spent my time in <sup>the</sup> crying <sup>room</sup>. Estelle <sup>Larson</sup> came prepared every Sunday - <sup>wads of cotton</sup> wads of cotton! She'd put them in her <sup>ears</sup> & then enjoy the service. The problem is, how did she hear the sermon?

sermon Julie Johnson  
Name

We are looking for memorable moments from everyone regarding a special memory here at Hope. They will be compiled with the 125<sup>th</sup> Anniversary items. Please fill out the form below and place in the basket in the Welcome Center by September 14.

x

## “I REMEMBER . . .”

(People who influenced my faith at Hope; the best event at Hope; a challenging time at Hope; first person I met at Hope, what my children enjoy most at Hope . . . other recent or past memories?)

- Thanksgiving dinners at church with other families who chose not to travel to their family during the holiday;
- progressive dinners with other couples from the church
- a banquet put on by youth in our church, about 1992-1993 - ceilings were draped with black fabric transforming the church into an elegant dining parlor;
- living next door to church on Maine Prairie Rd for 5 years - hearing an early morning singing practice that drifted across the yard like the voice of an angel.

Name

Eunice Sankey

We are looking for memorable moments from everyone regarding a special memory here at Hope. They will be compiled with the 125<sup>th</sup> Anniversary items. Please fill out the form below and place in the basket in the Welcome Center by September 14.

✱

## “I REMEMBER . . .”

(People who influenced my faith at Hope; the best event at Hope; a challenging time at Hope; first person I met at Hope, what my children enjoy most at Hope . . . other recent or past memories?)

There have been many memorable times here for Kerry and myself ~~here~~ at Hope, ~~as~~ I write this I come to my <sup>mind</sup> and heart the times I've ~~shared~~ <sup>shared</sup> in food and ~~treat~~ <sup>treat</sup> times for the children and adults during VBS, another is when Kerry and I were asked to be a prayer team for our children here at Hope. Many lined up for prayer, this was <sup>special</sup> and heart-touching seeing Jesus touch these lives, also when I was very new here at church, and not even <sup>knowing</sup> knowing where to find my ~~address~~ ~~Sunday school~~ <sup>class</sup> Sunday school class ~~was~~ a very kind, caring, <sup>loving</sup> loving Jan DeLondy would <sup>lead</sup> take me to our Sunday school class, I'll always remember the ~~memories~~ <sup>way we</sup> were received and cared about here ~~and still today as well here at Hope Cov. Church~~

Name Joey Klorich

*Sept 17, 2008*

I remember.....Now that's a mouthful in two words!!

Wow...we've been with the church since June, 1985 when we moved here from Blaine, MN. I started to think about having to respond to this request for the 125<sup>th</sup> Anniversary items for the church and realized this is not easy to put into a few words.

People who influenced my faith at Hope, would of started with Pastor Rick Mylander and of course his wife Gail. He visited our home after our first visit to the church. He left a huge impact on our children Tara, Belinda, Shannon and Seth because he remembered their names when he visited that first time. The kids decided from that moment, this would be the church they would want to keep attending.

As I started thinking about others who played an importance in my faith journey, I went through my notebook that I keep of my sermon notes to refresh my memory. The following Pastors were listed next to the sermon titles...Rick Mylander, Dean Nelson, Jim Bruckner, Chris Peterson, Terry Johnson, Tom Ervasti, Wes Olson, Bob Anderson, Brad Martin, Gary Noble and currently Bill Dornbush. Each one of these people on a Sunday morning took the time to share Gods' Word and I am forever grateful to each one for their gift of teaching, which has impacted my journey of getting to know God. Our church has certainly had its ups and downs over the years, but I believe there is a lesson that God is teaching us in every situation. If we can learn from it, it was worth the lesson! I've always been astounded how people can leave a church when things get tough or uncomfortable. Scott and I have always felt church is Family, and families work through good times and bad. It is a joy to be a part of this church!

The best thing we ever did was join a fellowship group. We made great friendships over the years. I remember how uncomfortable I was in my first adult Sunday school class with Virginia Leigh as the teacher, when she would just call on someone at random. I recall not going back to the class because of fear. My biggest

regret is she is not with our church to teach one now. I realize now the gift she had in Bible knowledge!! I truly miss Nancy Fitch who did a fantastic job of teaching the women's class on Sunday mornings. We laughed a lot and cried at times, it was so healthy. Joining the church choir and having Lowell and Cheryl Larson direct it all these years has been so much fun, ( even though Lowell doesn't even remember my first year of attending). HA! Having my sister and husband attend our church has been meaningful.

Our children bonded with so many other kids during the Wednesday night programs and all the different activities. Hay rides, silent auctions, fancy dinners put on by the youth, their trip to Chicago with Angie Paul (who was in her 80's), confirmation retreats, and the list goes on and on for them.

The funniest thing I recall was the time Nancy and Ray Fitches' son Tom, who took the communion loaf of bread when it was being passed, picked it up and ate the whole thing and his parents were to far down the row to stop him. In fact Nancy wrote a poem about that day, so I will attach it to this note. We could hardly keep from laughing the moment it happened.

My most sad moment was losing our friend Tim McDunn to cancer. When Seth sang "I Can Only Imagine" for his funeral, and him commenting, he felt like Tim was standing next to him, to carry his voice through that song, it is a moment I will treasure forever. Tim knew what it was to have a servant heart for people in the church and had practiced it with genuine love and concern, through Stevens Ministry.

When I share that I come from a Catholic background, people always give a certain look. I haven't quite figured that out yet. All I know is that I'm proud of my Catholic background. The Catholic church gave me the foundation for my Faith in God. What the Covenant church has done for me, is extended my education in learning to pick up the Bible and read Gods' Word!!! It is a privilege to join in the celebration of the 125<sup>th</sup> Anniversary of this Covenant Church!!!

*Love,  
Maggie Bjorklund*