

In the Beginning

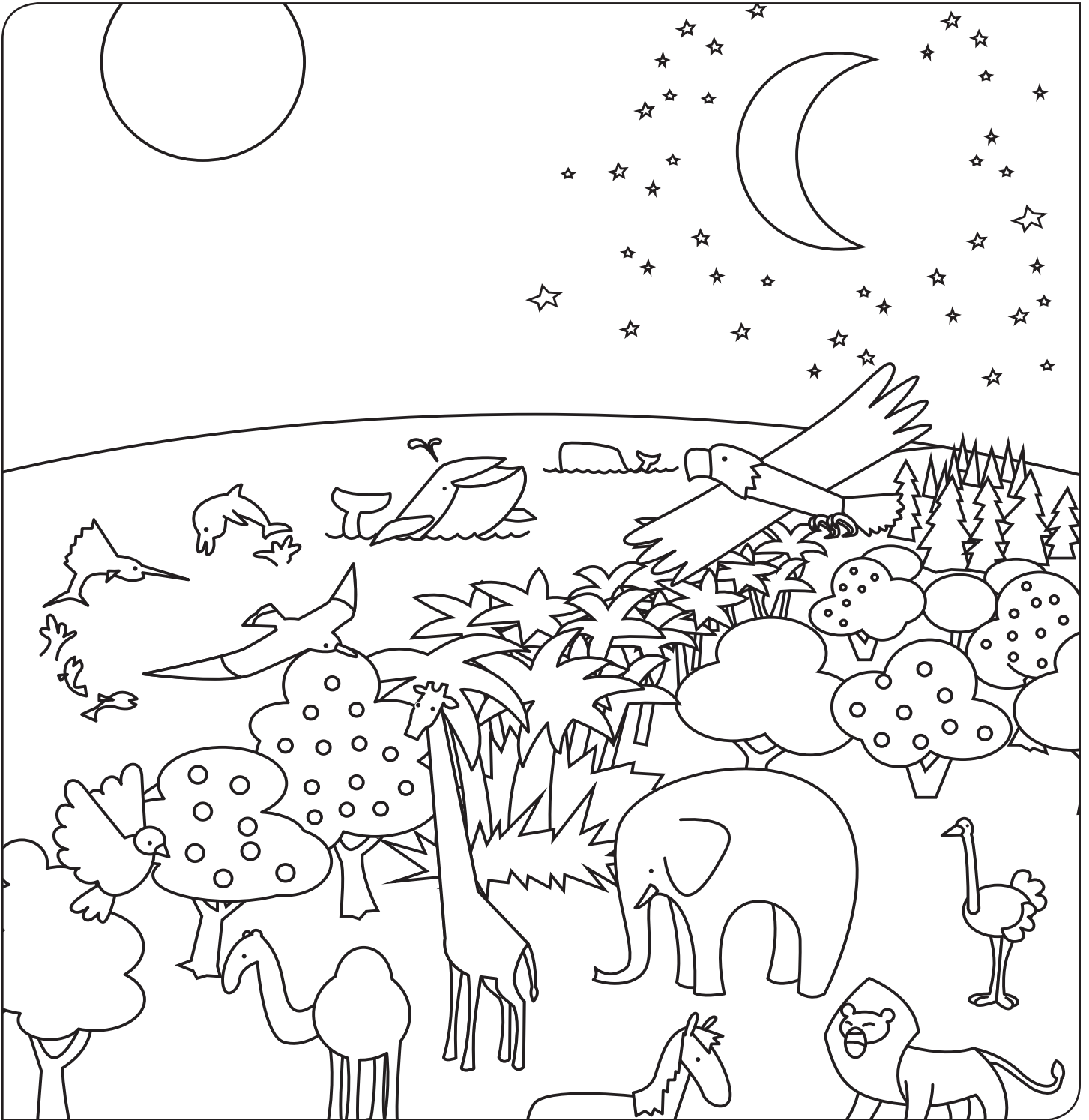

God created the heavens and the earth and it was GOOD. What do you think is GOOD in God's creation?

God CREATED everything. One way we remember creation in worship is with plants in church.

Are there any flowers or plants in your worship space? Draw them!

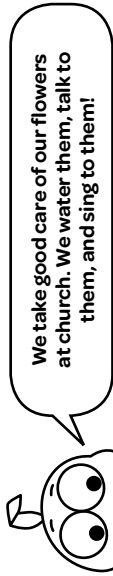

We take good care of our flowers at church. We water them, talk to them, and sing to them!

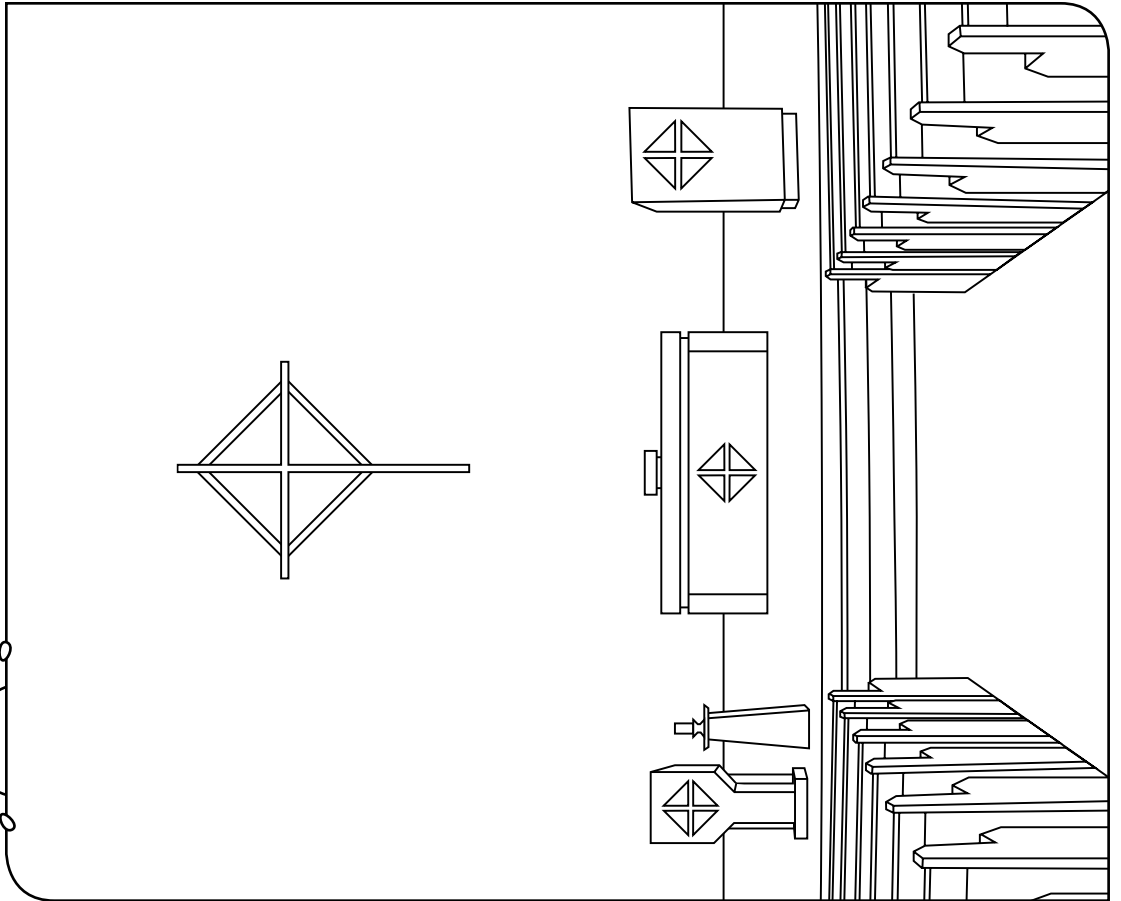

In the Beginning
TODAY'S THEME IS ORDER.



Pre-Reader



Order can come from the messiest places.

Help Tot put the numbers in order.

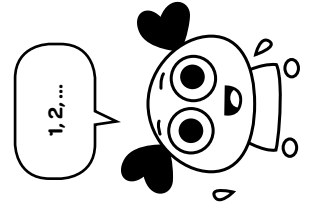
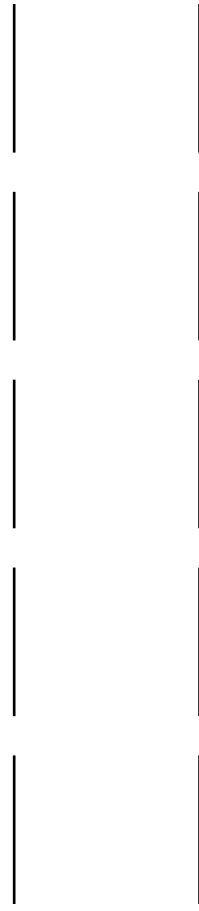
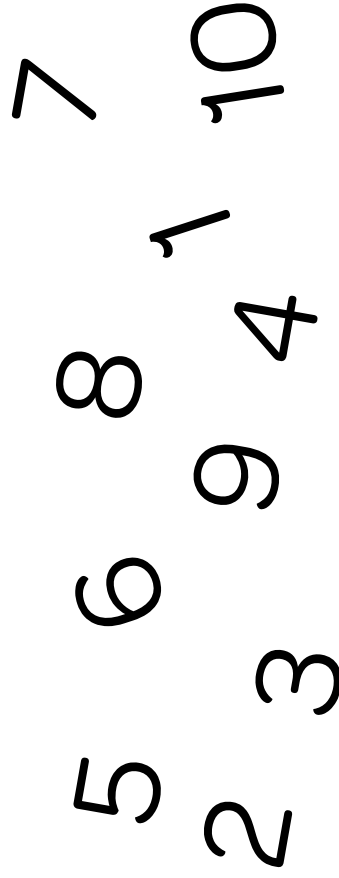

Fold here

Whirl! Year Gold Fall Director Guide. wearesparkhouse.org. © 2016 sparkhouse. All rights reserved. May be reproduced for local use only provided each copy carries this notice.

Fold here

IN THE BEGINNING . . . God created everything!

One of these lines leads all the way to the center. Follow it to the beginning!

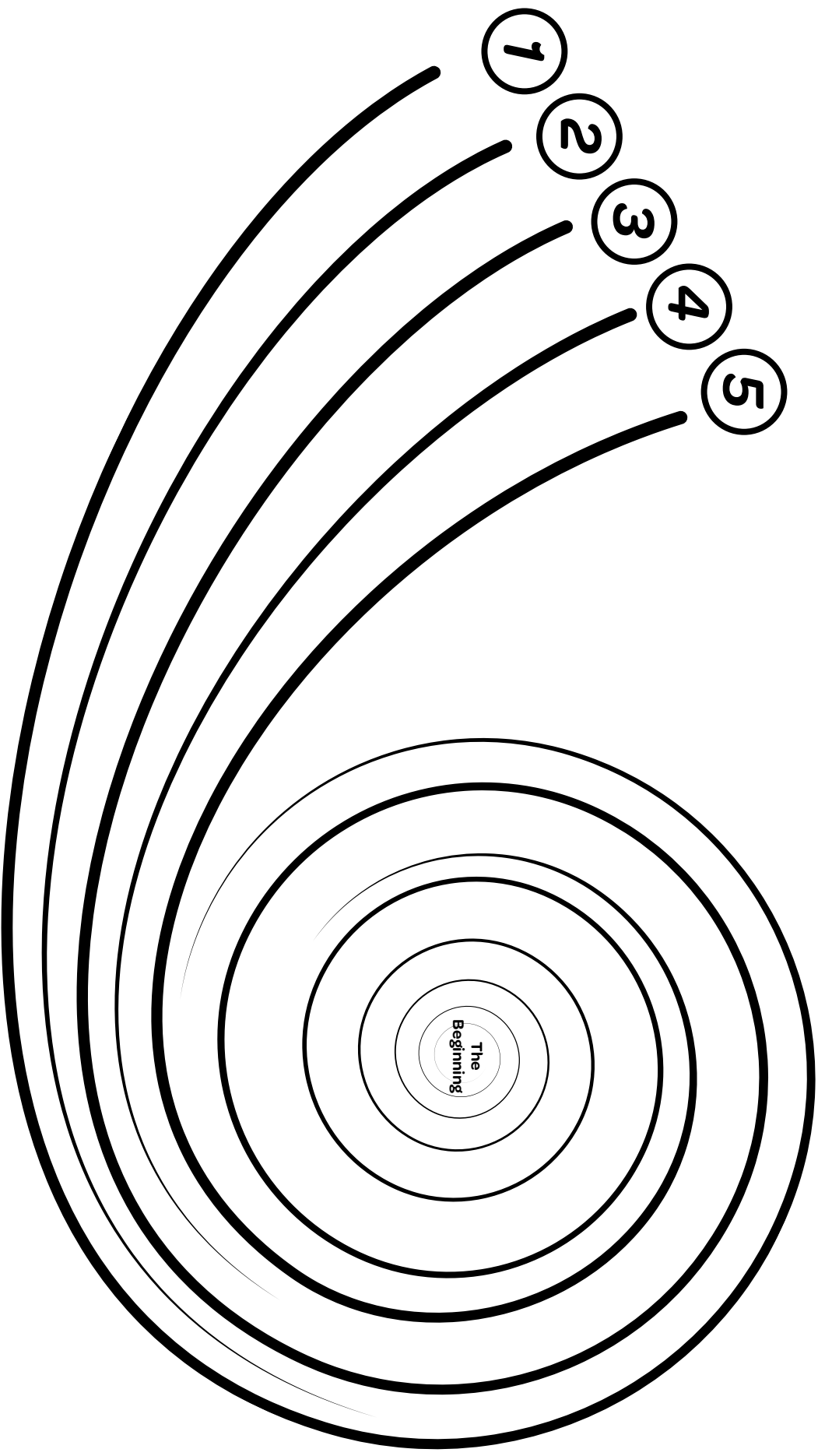

Today our church family prays for...

“And God said, ‘Let the waters under the sky be gathered together into one place, and let the dry land appear.’” Genesis 1:9

How many ways does your church use water? Write all of the ones you can think of on the water drops.

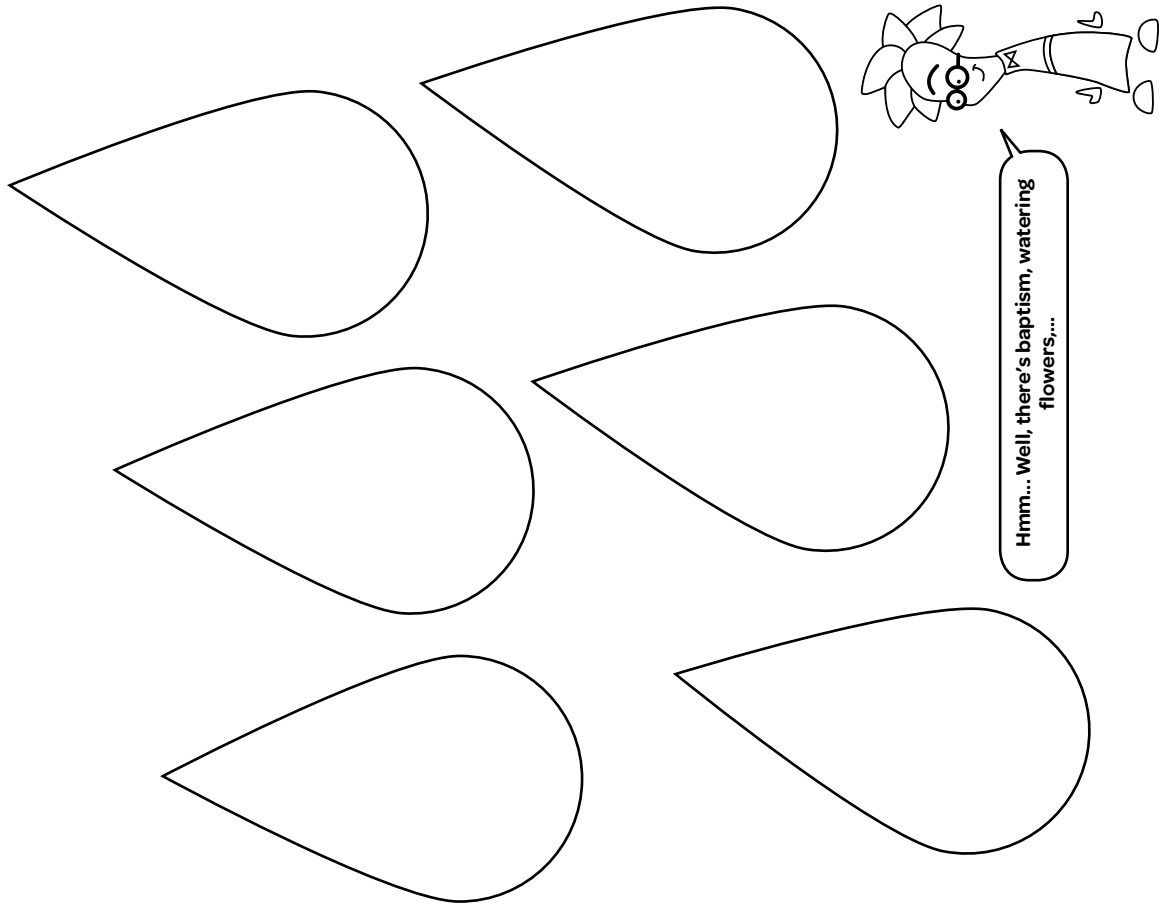

Fold here
Whit Year Gold Fall Director Guide, weareparkhouse.org. © 2016 sparkhouse. All rights reserved. May be reproduced for local use only provided each copy carries this notice.

In the Beginning

TODAY'S THEME IS ORDER.



Order can come from the messiest places.

Help Ruby clean her room! Draw a line to where each object should go.

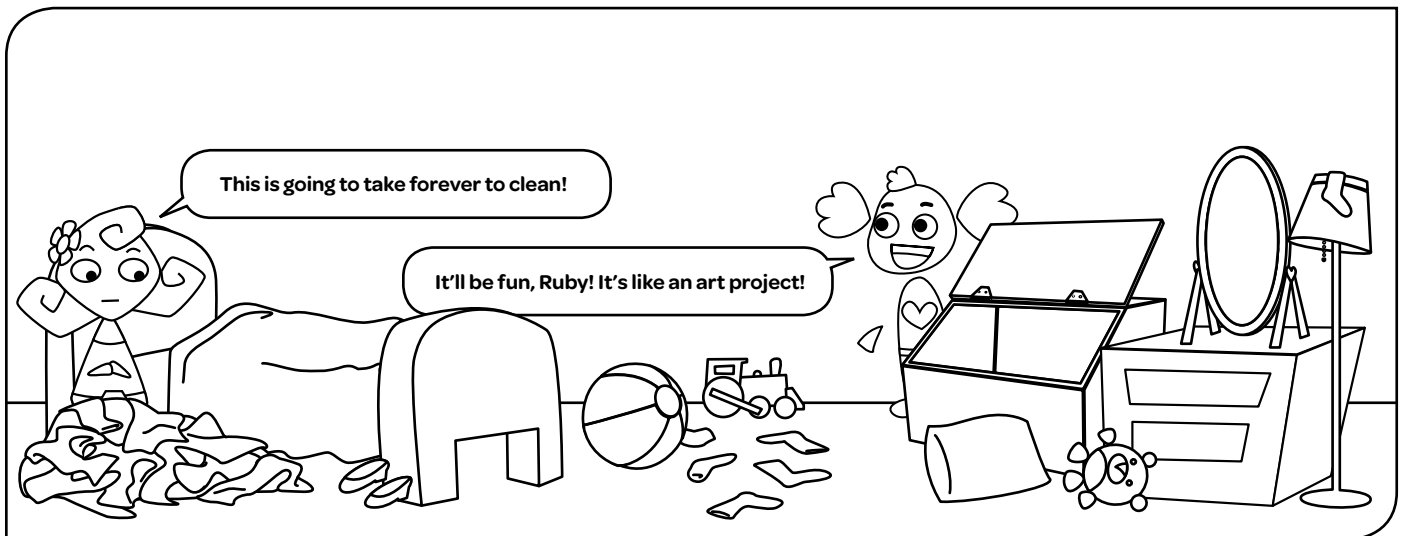

"A wind from God swept over the face of the waters." Genesis 1:2

Draw the wind from God sweeping over the water.



"So God created ... every living creature that moves, of every kind." Genesis 1:21

What's your favorite animal? Draw it doing something fun!

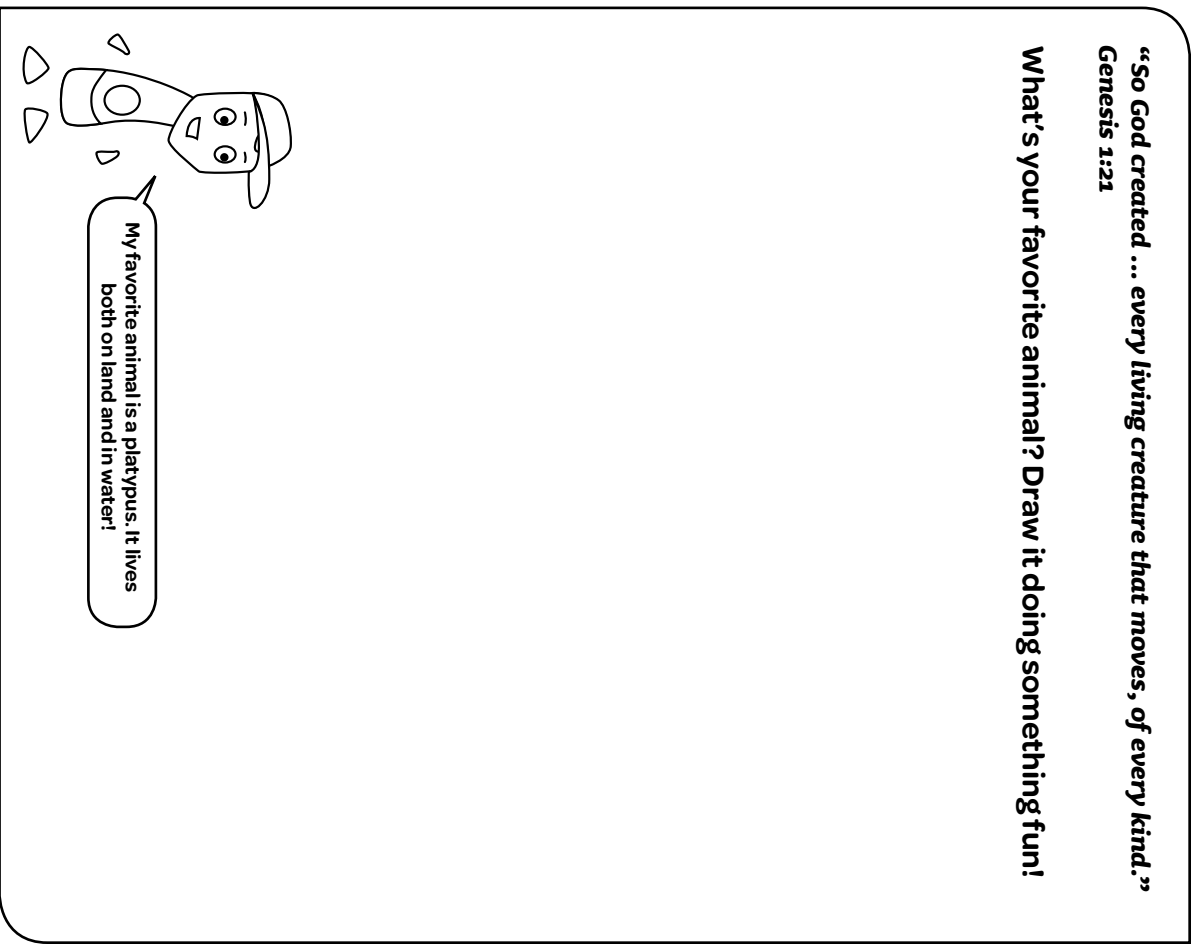

Today our church family prays for...