

DASH'S
COLORING
BOOK

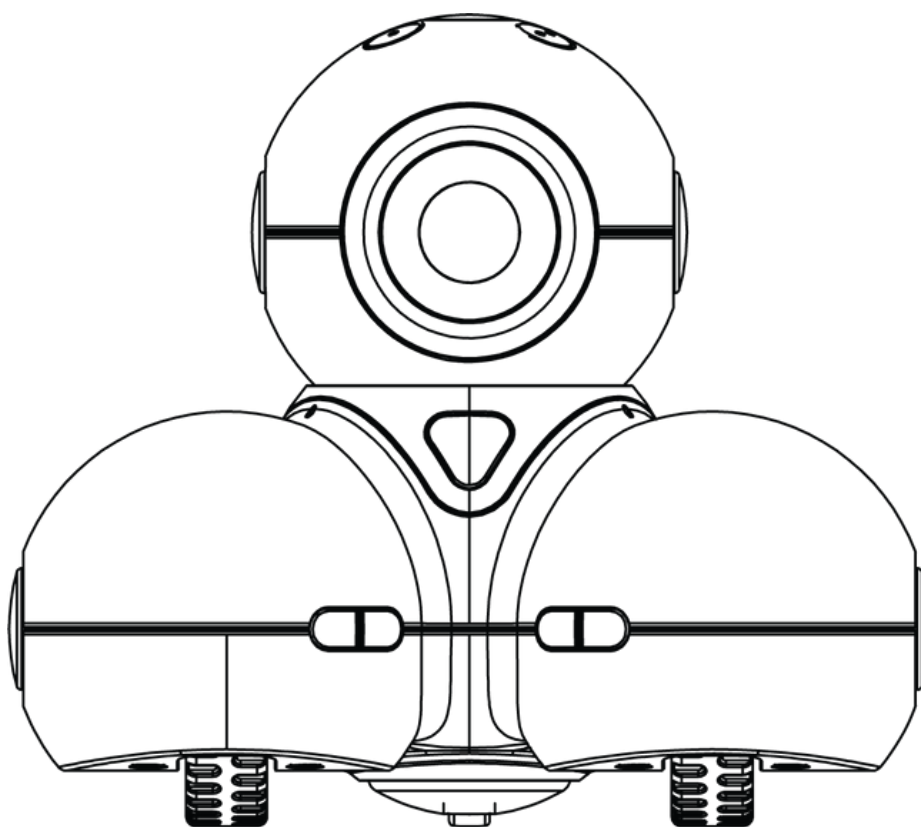

Dash the



w:onder
workshop

Learn more about our educational resources at:
www.makewonder.com

Copyright © 2020 Wonder Workshop, Inc. All Rights Reserved Wonder Workshop,
the Wonder Workshop logo, Dash, Dot, and Cue are trademarks of Wonder Workshop, Inc.

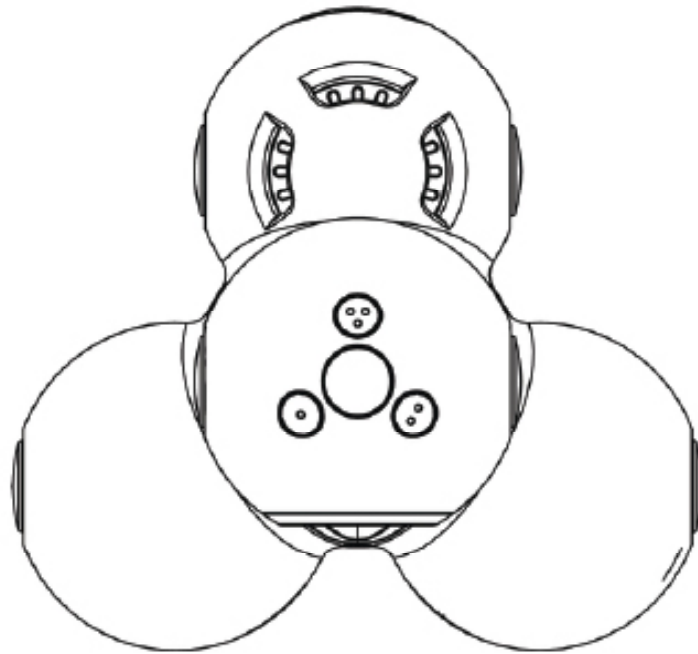
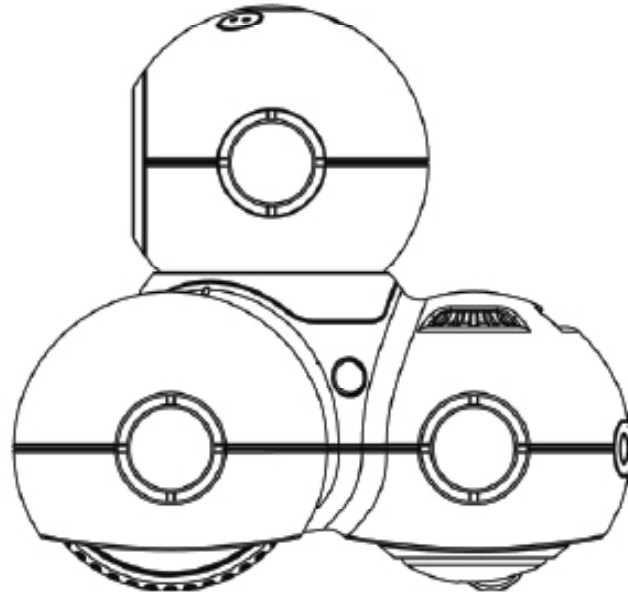

w:onder Learn more about our educational resources at:
workshop www.makewonder.com

Copyright © 2020 Wonder Workshop, Inc. All Rights Reserved Wonder Workshop,
the Wonder Workshop logo, Dash, Dot, and Cue are trademarks of Wonder Workshop, Inc.

Dot the

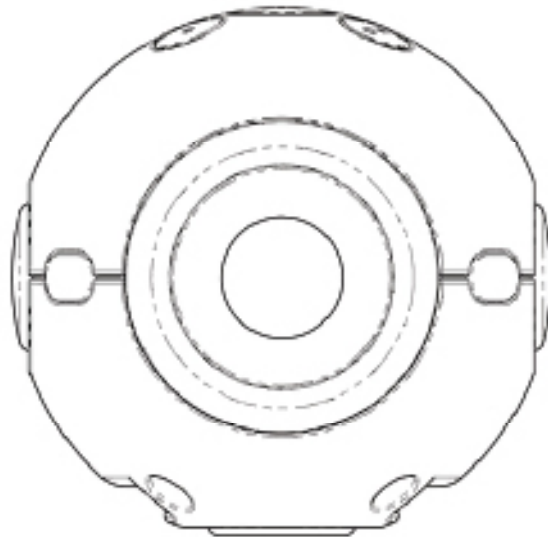

w:onder Learn more about our educational resources at:
workshop www.makewonder.com

Copyright © 2020 Wonder Workshop, Inc. All Rights Reserved Wonder Workshop,
the Wonder Workshop logo, Dash, Dot, and Cue are trademarks of Wonder Workshop, Inc.

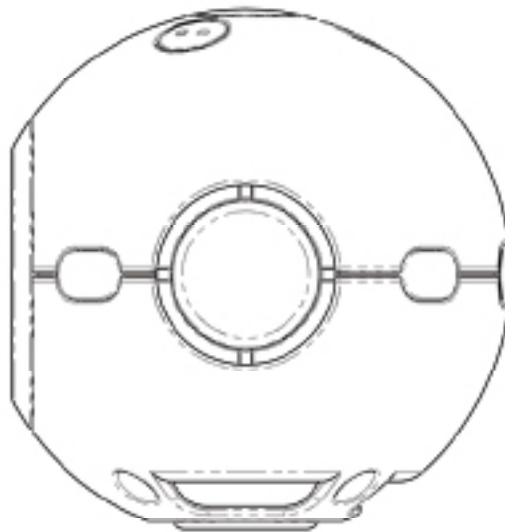
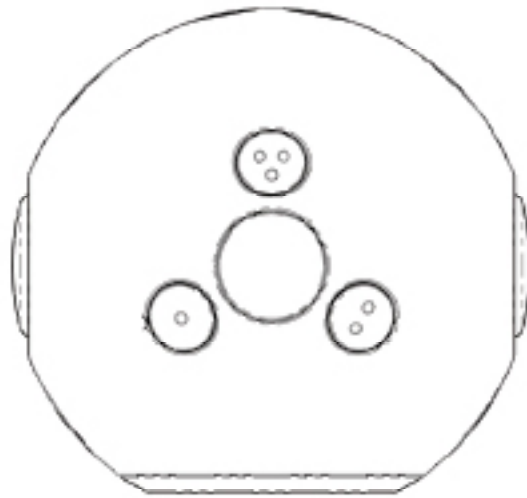

w:onder Learn more about our educational resources at:
workshop www.makewonder.com

Copyright © 2020 Wonder Workshop, Inc. All Rights Reserved Wonder Workshop,
the Wonder Workshop logo, Dash, Dot, and Cue are trademarks of Wonder Workshop, Inc.

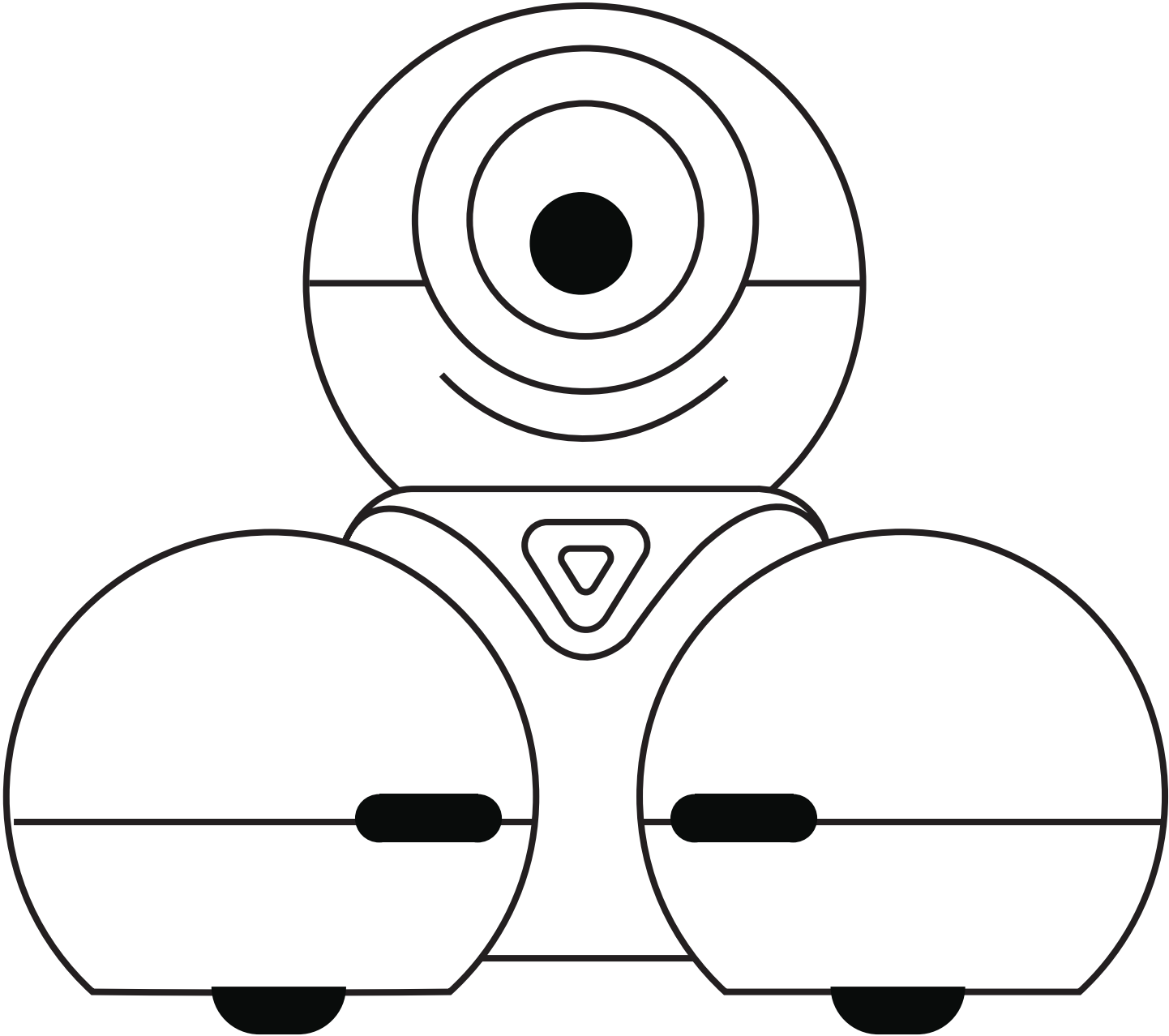

w:onder Learn more about our educational resources at:
workshop www.makewonder.com

Copyright © 2020 Wonder Workshop, Inc. All Rights Reserved Wonder Workshop,
the Wonder Workshop logo, Dash, Dot, and Cue are trademarks of Wonder Workshop, Inc.

Finish Dot

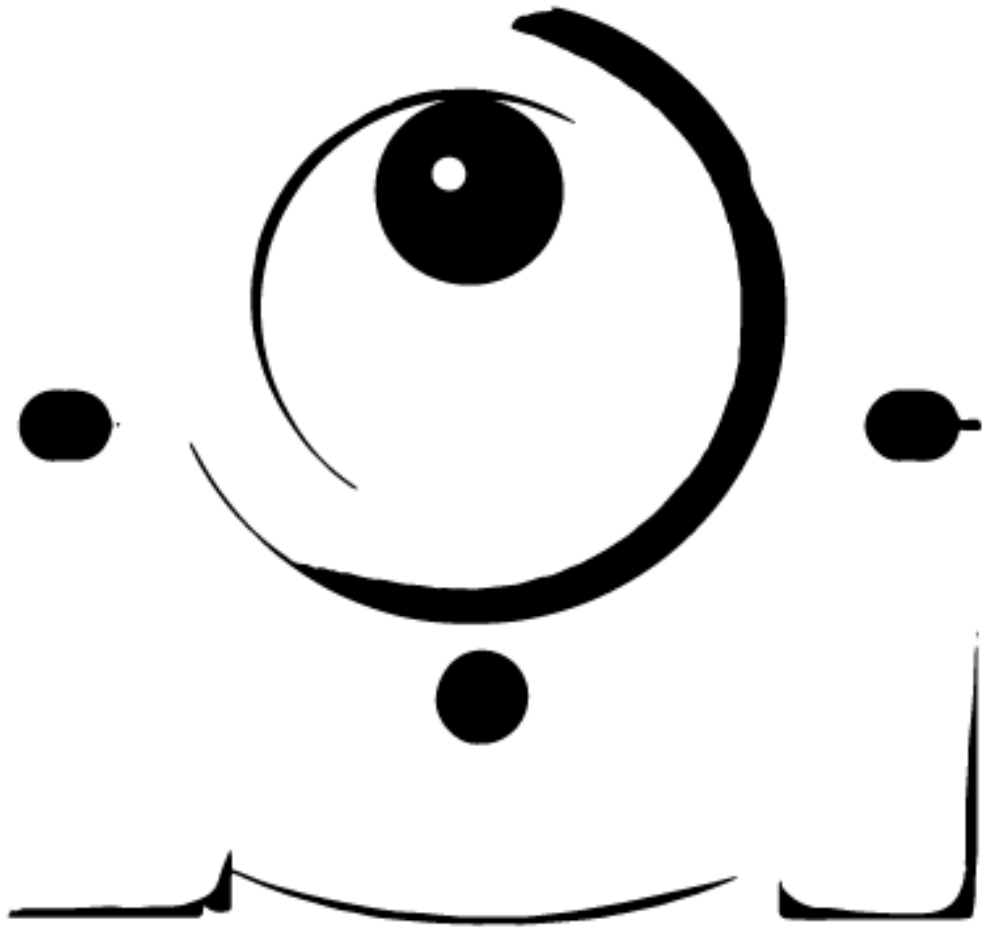

w:onder Learn more about our educational resources at:
workshop www.makewonder.com

Copyright © 2020 Wonder Workshop, Inc. All Rights Reserved Wonder Workshop,
the Wonder Workshop logo, Dash, Dot, and Cue are trademarks of Wonder Workshop, Inc.

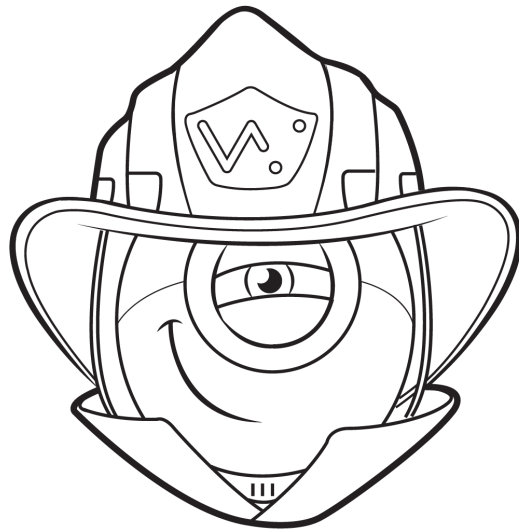
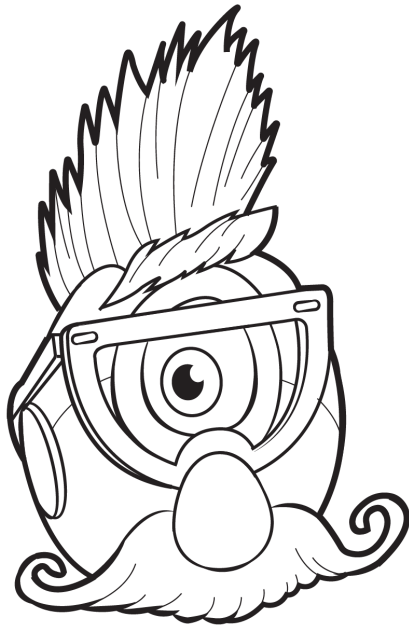
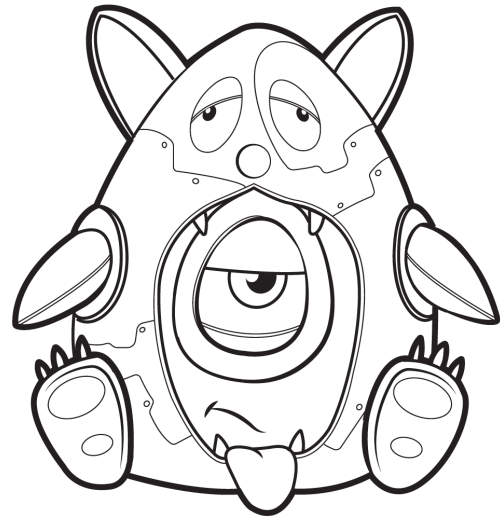

w:onder Learn more about our educational resources at:
workshop www.makewonder.com

Copyright © 2020 Wonder Workshop, Inc. All Rights Reserved Wonder Workshop,
the Wonder Workshop logo, Dash, Dot, and Cue are trademarks of Wonder Workshop, Inc.

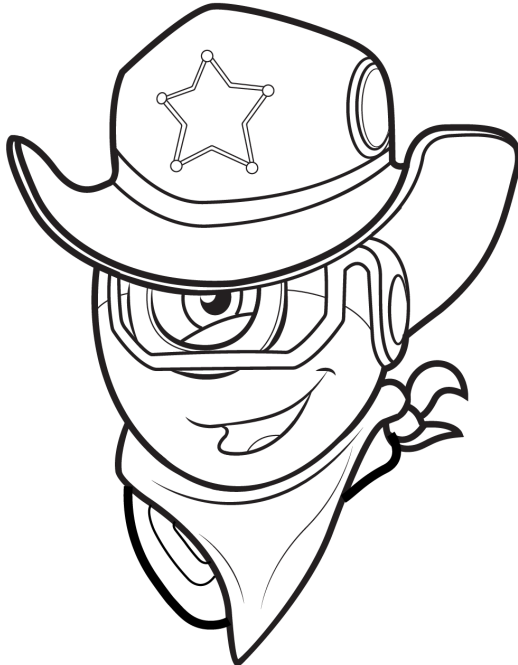
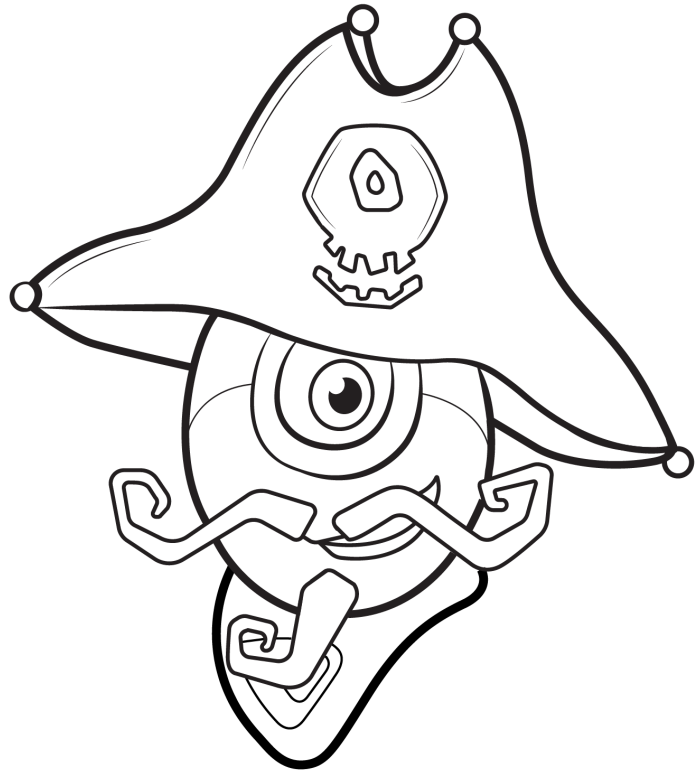
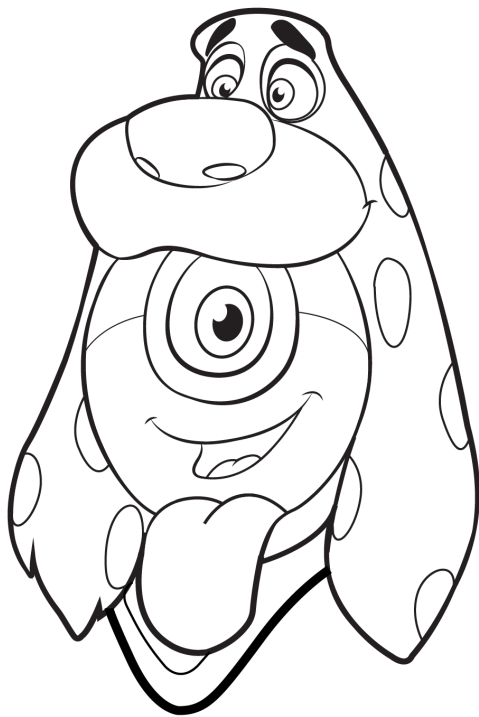

w:onder Learn more about our educational resources at:
workshop www.makewonder.com

Copyright © 2020 Wonder Workshop, Inc. All Rights Reserved Wonder Workshop,
the Wonder Workshop logo, Dash, Dot, and Cue are trademarks of Wonder Workshop, Inc.

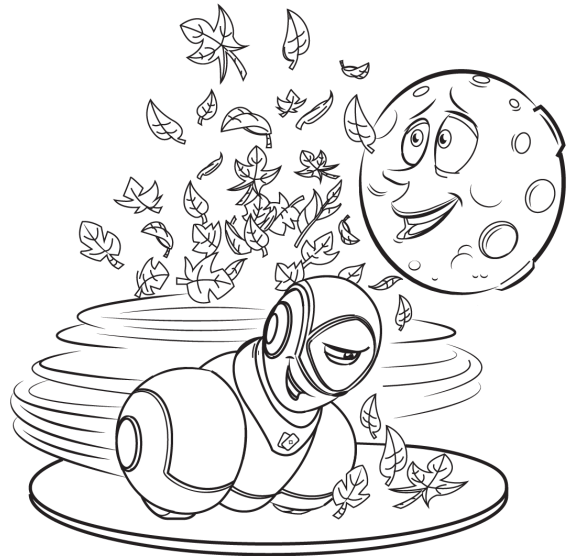
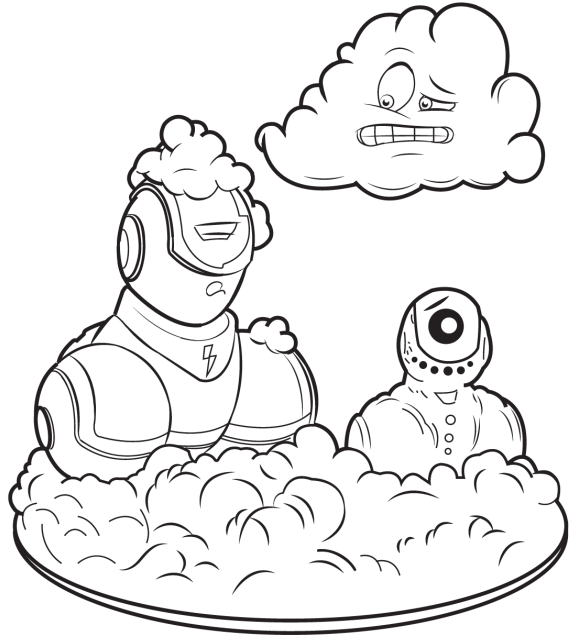
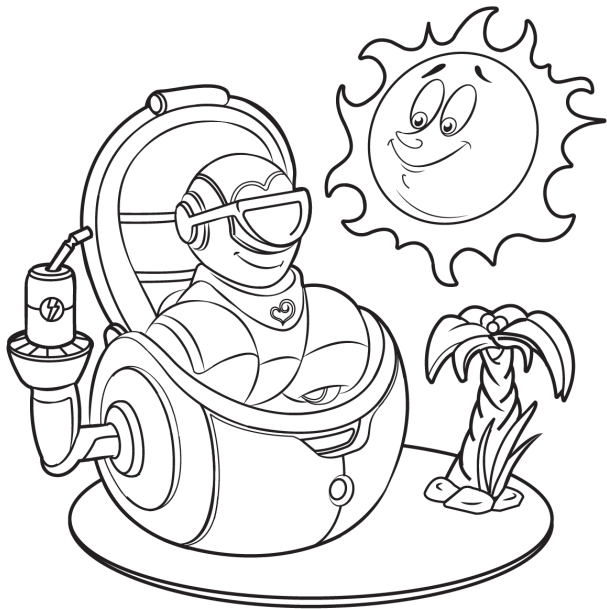

w:onder Learn more about our educational resources at:
workshop www.makewonder.com

Copyright © 2020 Wonder Workshop, Inc. All Rights Reserved Wonder Workshop,
the Wonder Workshop logo, Dash, Dot, and Cue are trademarks of Wonder Workshop, Inc.

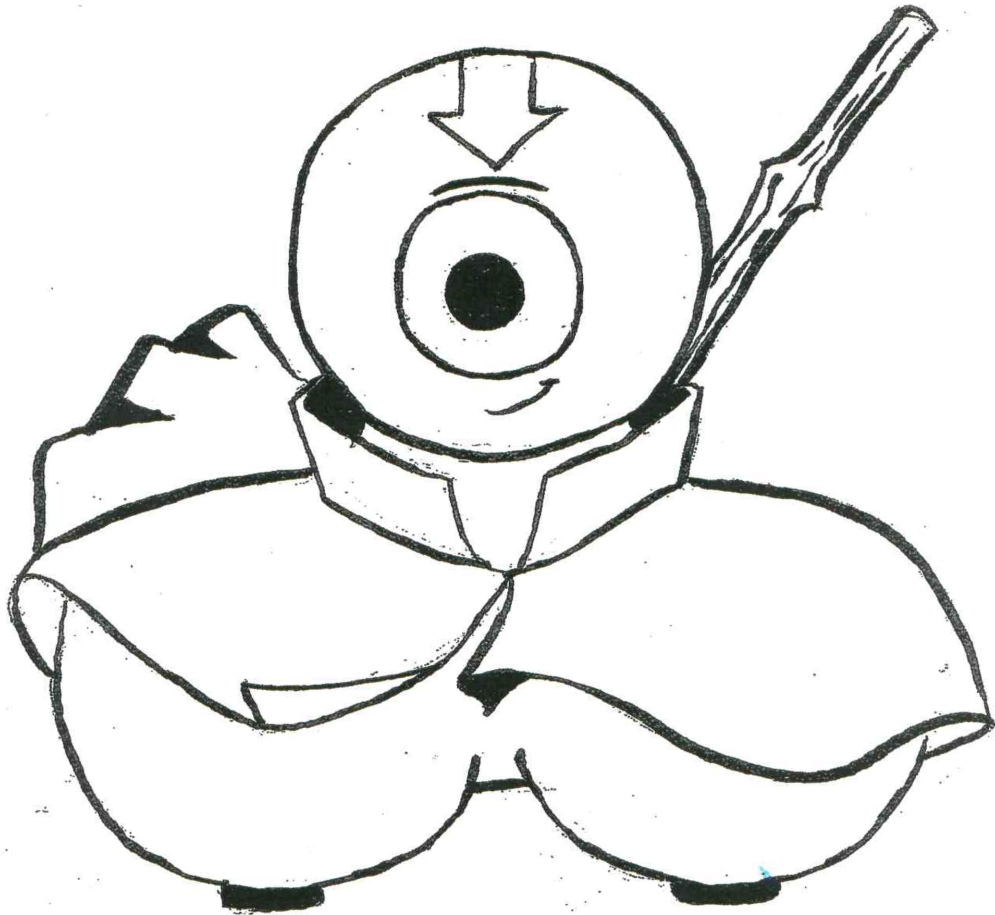

w:onder Learn more about our educational resources at:
workshop www.makewonder.com

Copyright © 2020 Wonder Workshop, Inc. All Rights Reserved Wonder Workshop,
the Wonder Workshop logo, Dash, Dot, and Cue are trademarks of Wonder Workshop, Inc.



w:onder Learn more about our educational resources at:
workshop www.makewonder.com

Copyright © 2020 Wonder Workshop, Inc. All Rights Reserved Wonder Workshop,
the Wonder Workshop logo, Dash, Dot, and Cue are trademarks of Wonder Workshop, Inc.

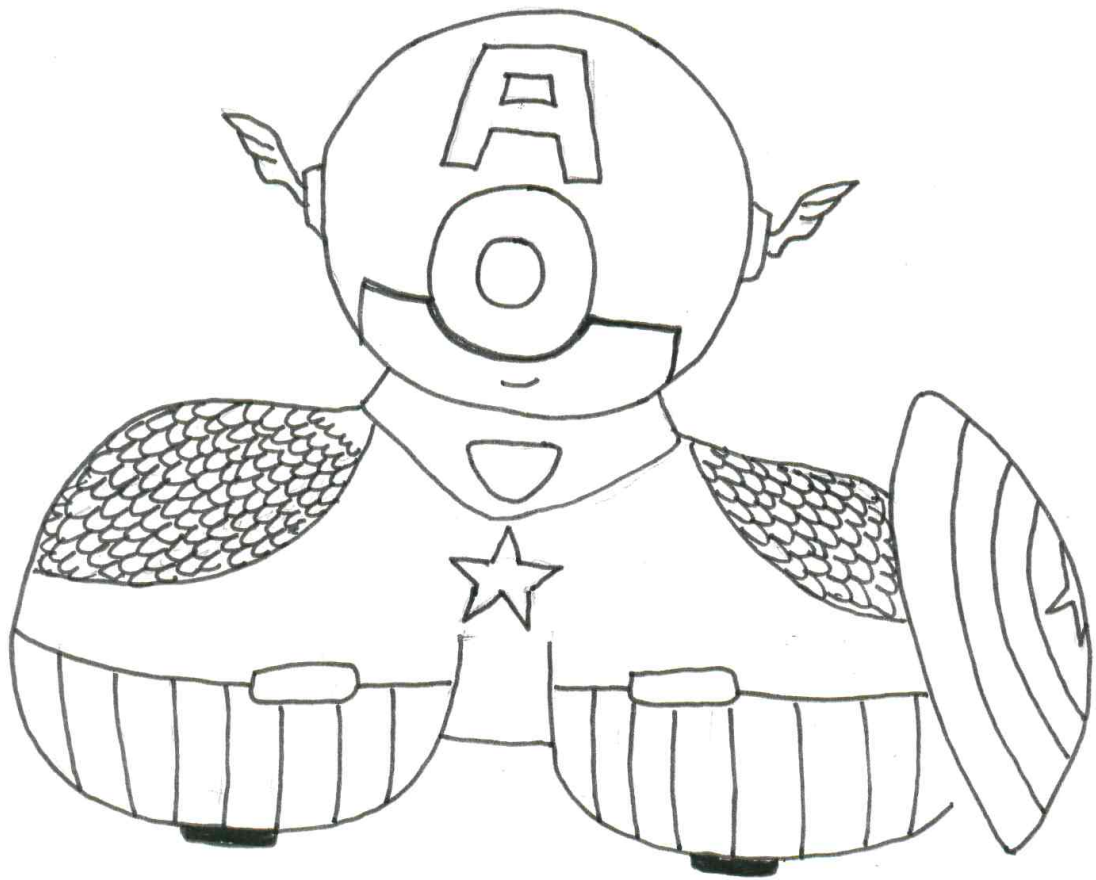

w:onder Learn more about our educational resources at:
workshop www.makewonder.com

Copyright © 2020 Wonder Workshop, Inc. All Rights Reserved Wonder Workshop,
the Wonder Workshop logo, Dash, Dot, and Cue are trademarks of Wonder Workshop, Inc.

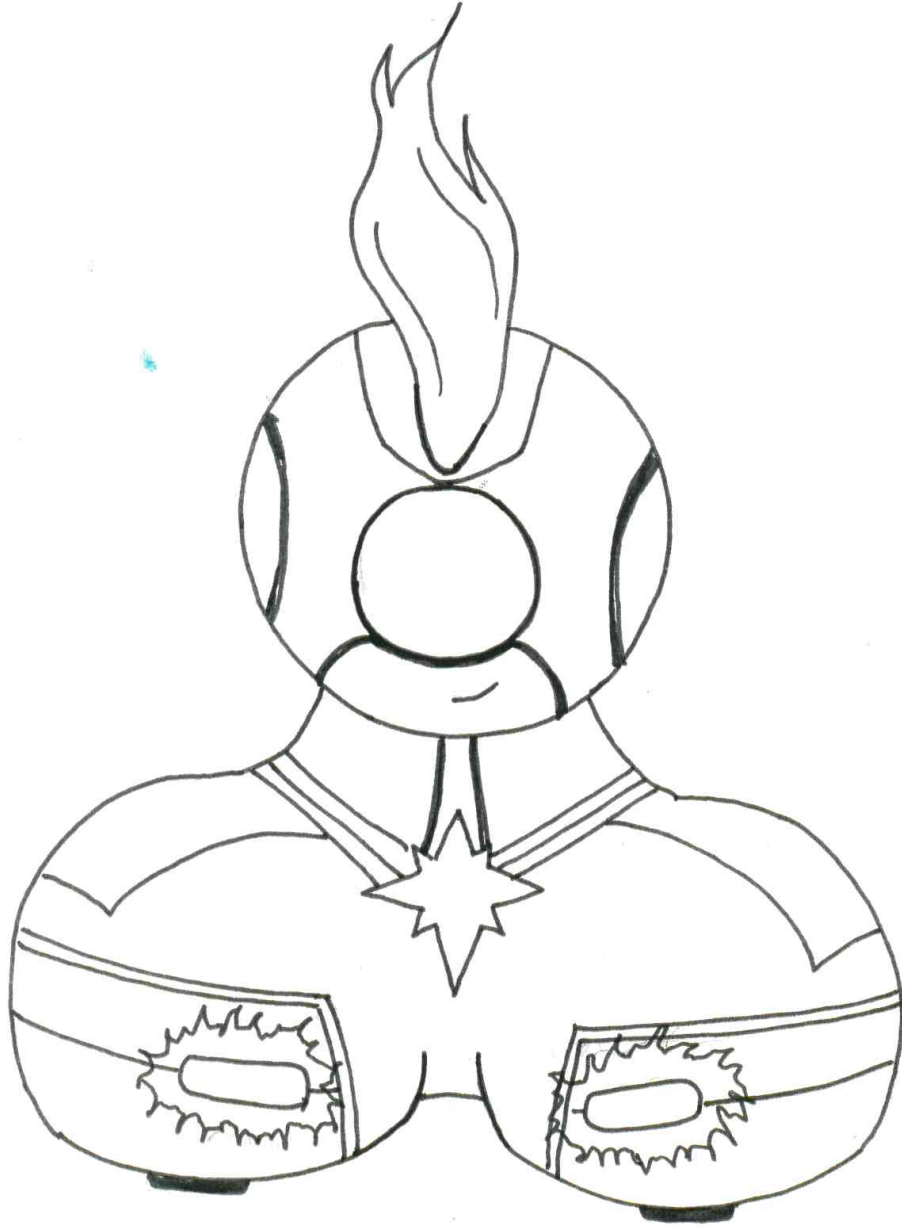

w:onder Learn more about our educational resources at:
workshop www.makewonder.com

Copyright © 2020 Wonder Workshop, Inc. All Rights Reserved Wonder Workshop,
the Wonder Workshop logo, Dash, Dot, and Cue are trademarks of Wonder Workshop, Inc.

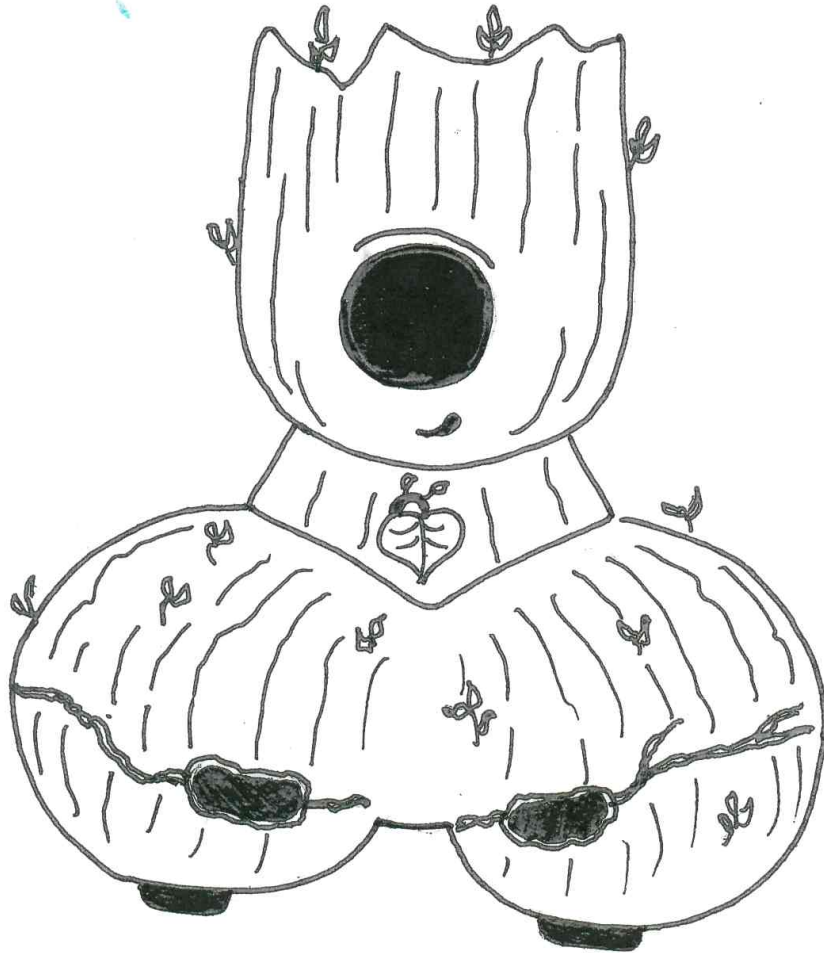

w:onder Learn more about our educational resources at:
workshop www.makewonder.com

Copyright © 2020 Wonder Workshop, Inc. All Rights Reserved Wonder Workshop,
the Wonder Workshop logo, Dash, Dot, and Cue are trademarks of Wonder Workshop, Inc.

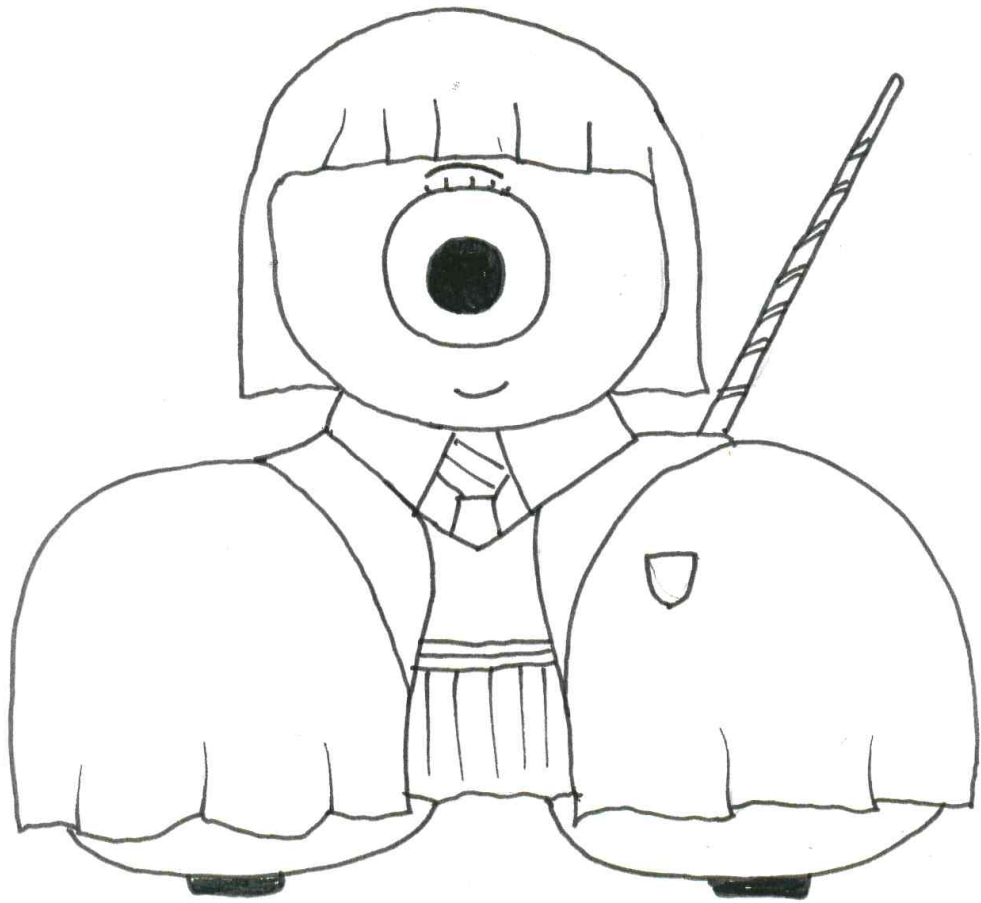

w:onder Learn more about our educational resources at:
workshop www.makewonder.com

Copyright © 2020 Wonder Workshop, Inc. All Rights Reserved Wonder Workshop,
the Wonder Workshop logo, Dash, Dot, and Cue are trademarks of Wonder Workshop, Inc.

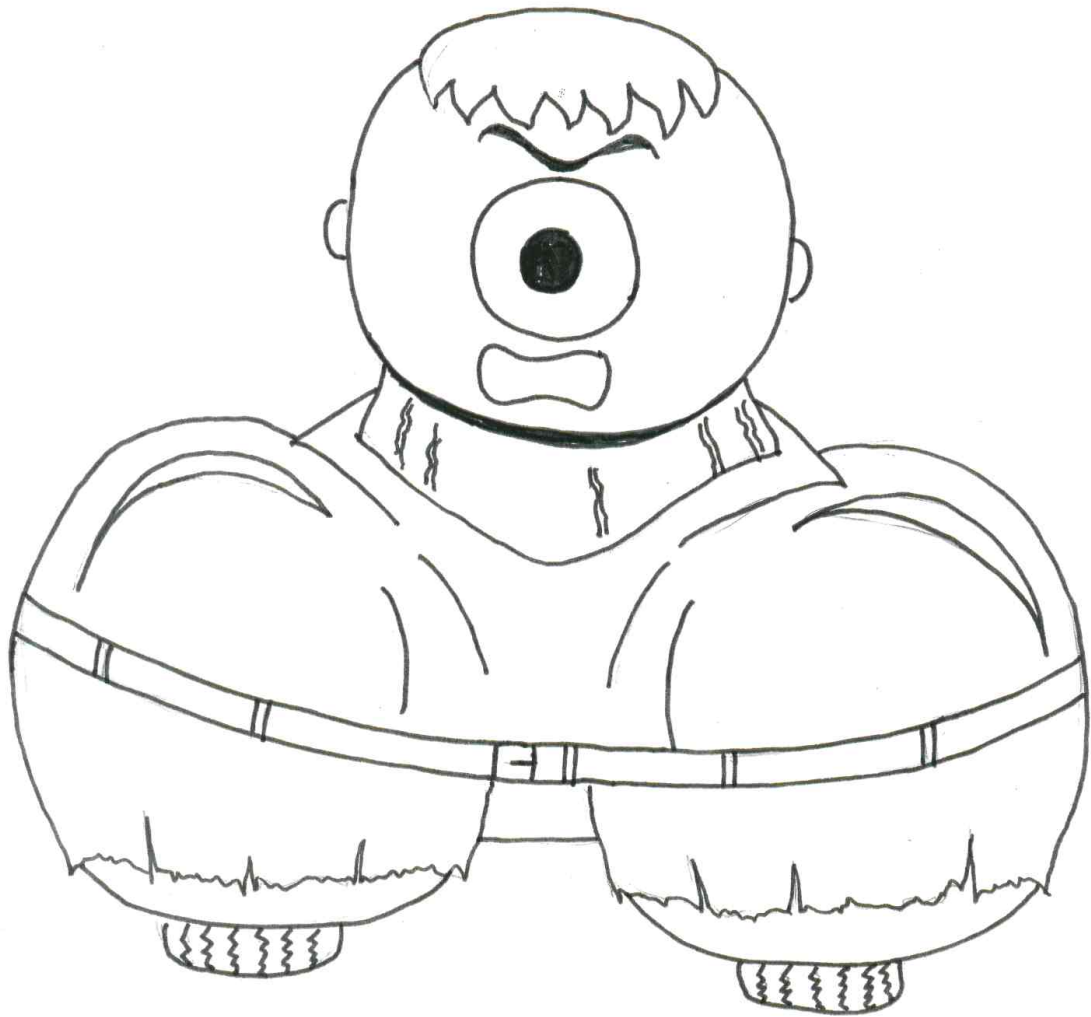

w:onder Learn more about our educational resources at:
workshop www.makewonder.com

Copyright © 2020 Wonder Workshop, Inc. All Rights Reserved Wonder Workshop,
the Wonder Workshop logo, Dash, Dot, and Cue are trademarks of Wonder Workshop, Inc.

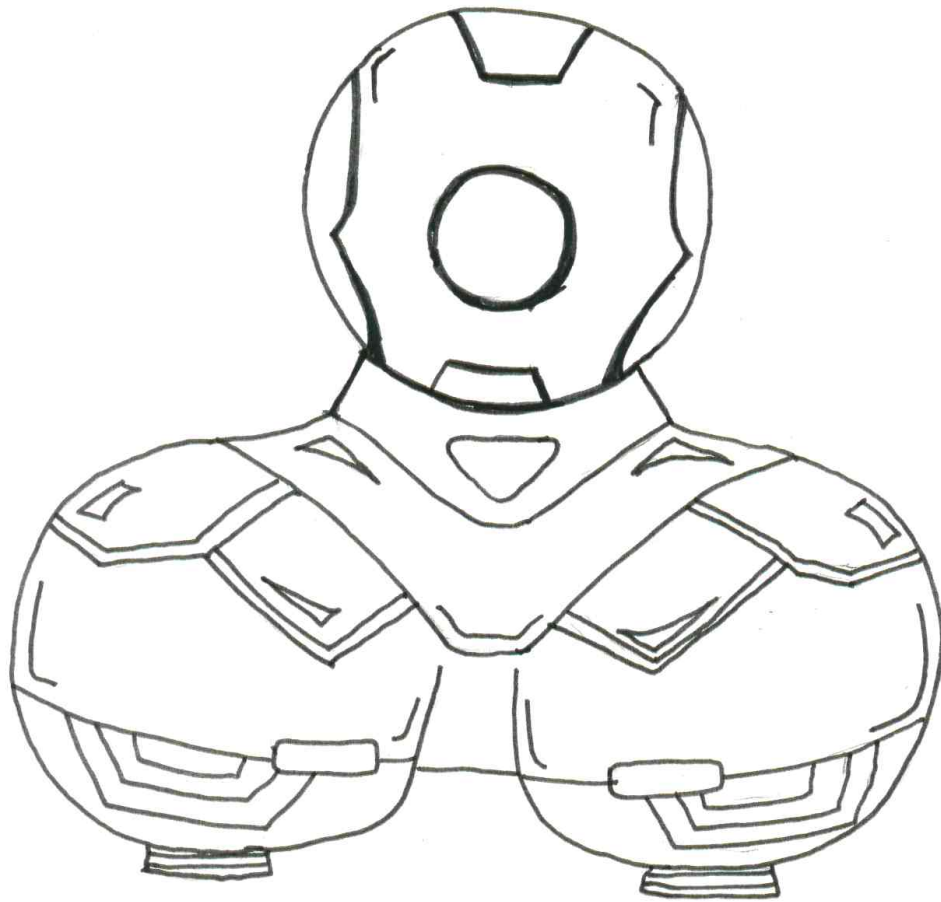

w:onder Learn more about our educational resources at:
workshop www.makewonder.com

Copyright © 2020 Wonder Workshop, Inc. All Rights Reserved Wonder Workshop,
the Wonder Workshop logo, Dash, Dot, and Cue are trademarks of Wonder Workshop, Inc.

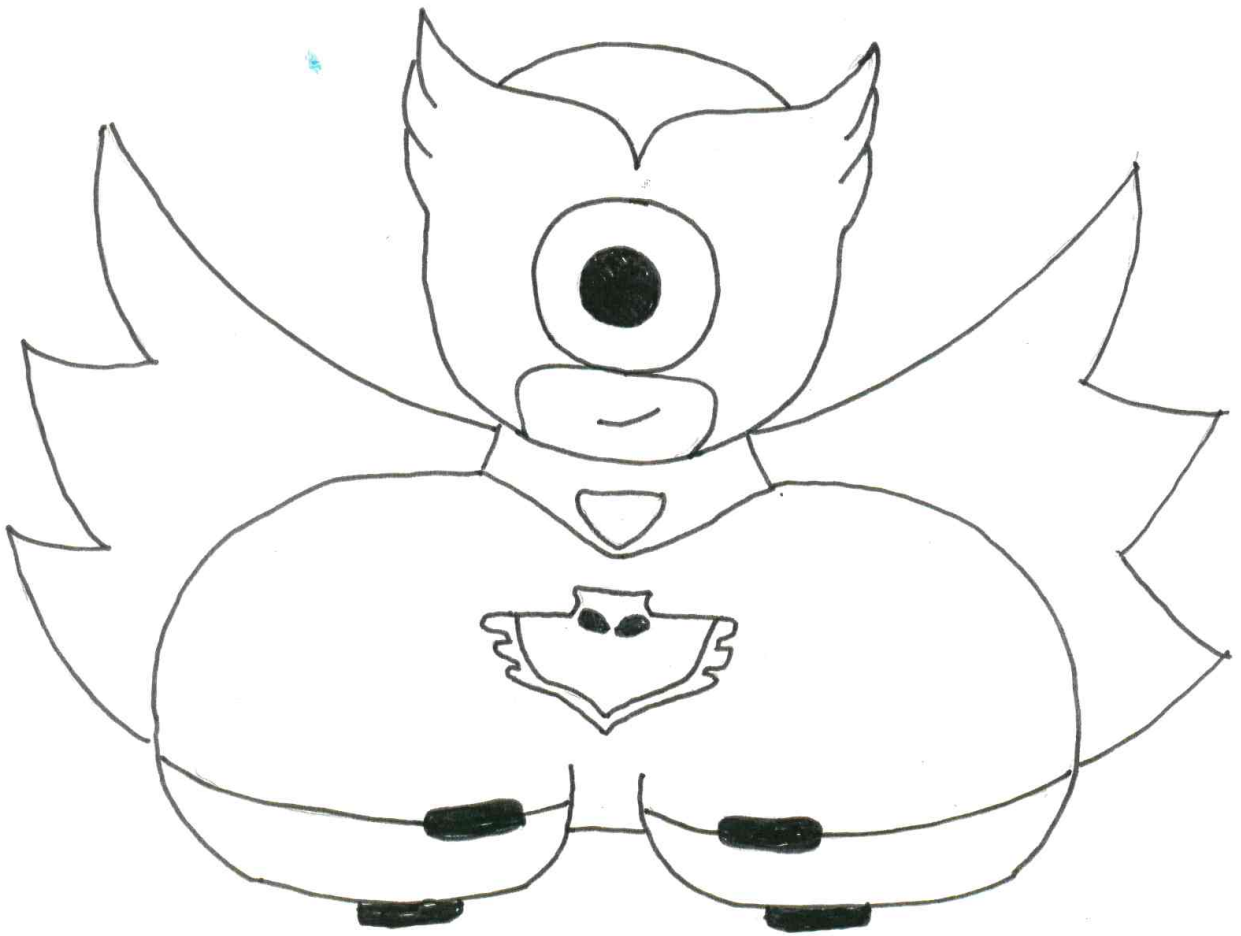

w:onder Learn more about our educational resources at:
workshop www.makewonder.com

Copyright © 2020 Wonder Workshop, Inc. All Rights Reserved Wonder Workshop,
the Wonder Workshop logo, Dash, Dot, and Cue are trademarks of Wonder Workshop, Inc.

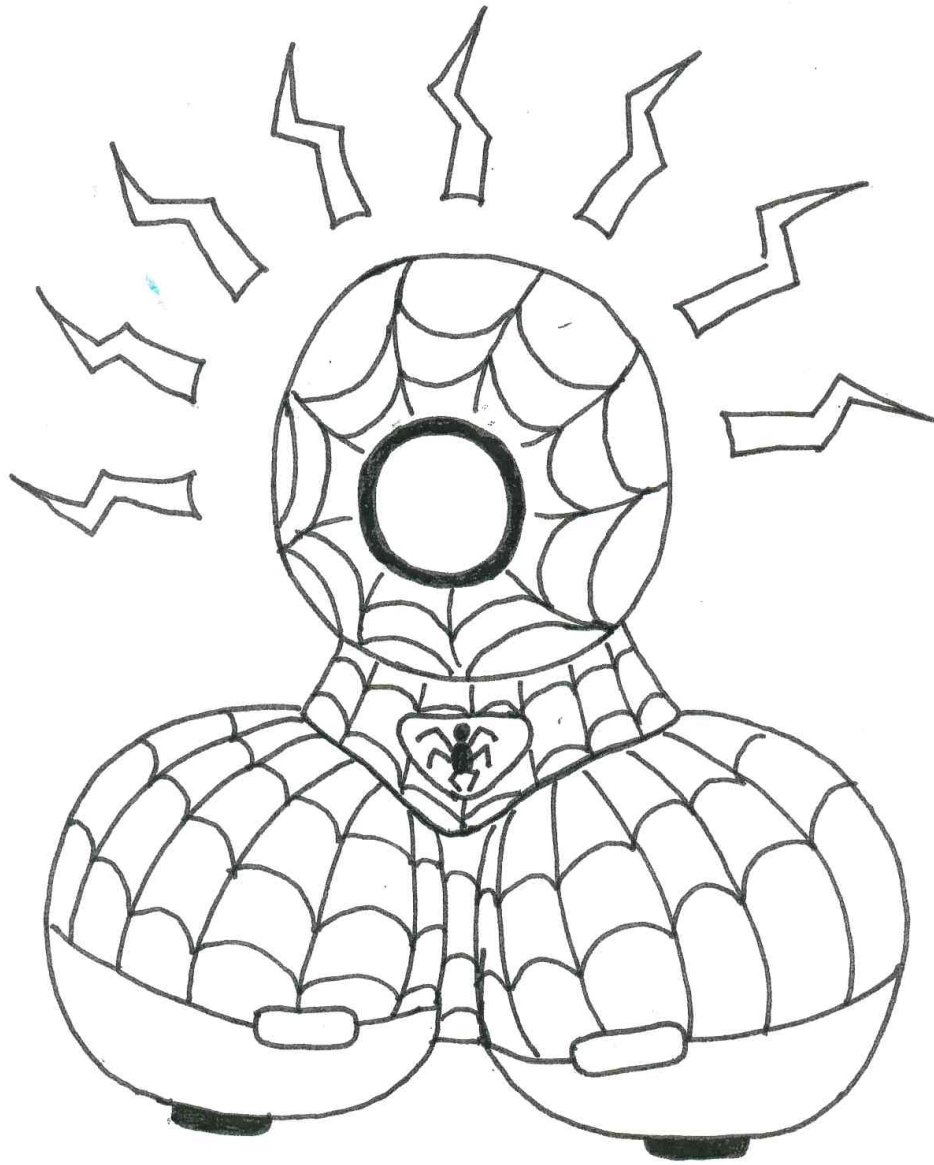

w:onder Learn more about our educational resources at:
workshop www.makewonder.com

Copyright © 2020 Wonder Workshop, Inc. All Rights Reserved Wonder Workshop,
the Wonder Workshop logo, Dash, Dot, and Cue are trademarks of Wonder Workshop, Inc.

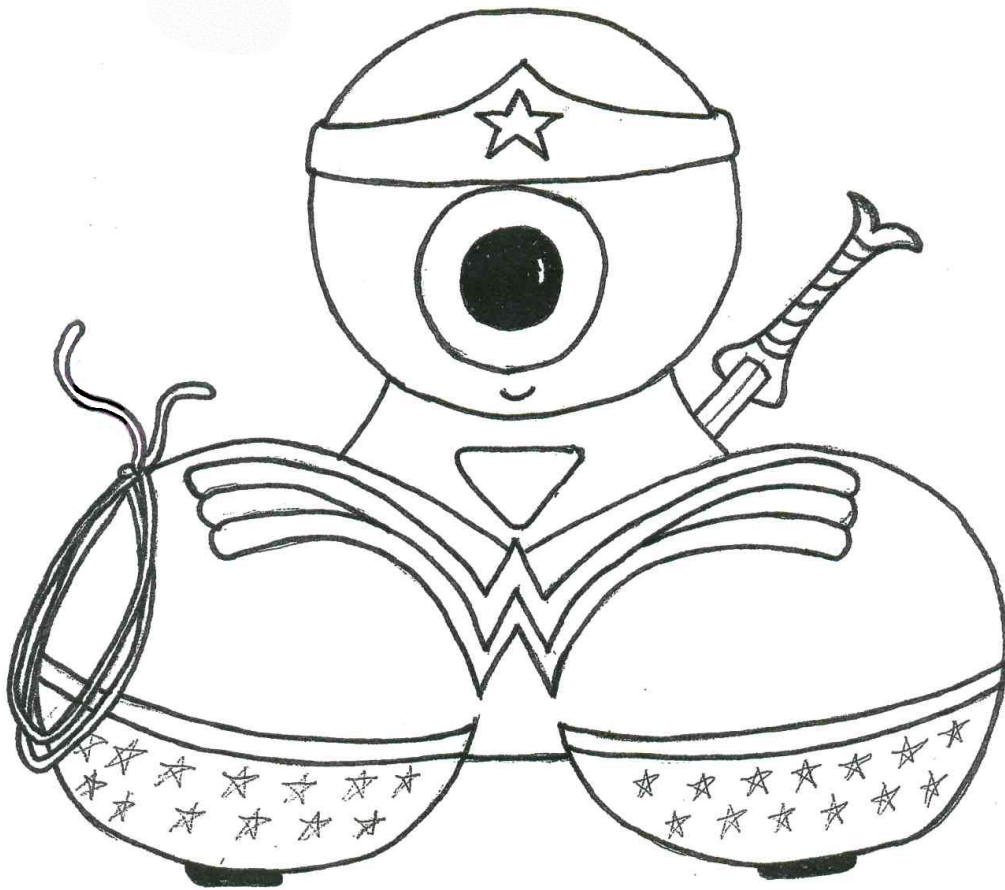

w:onder Learn more about our educational resources at:
workshop www.makewonder.com

Copyright © 2020 Wonder Workshop, Inc. All Rights Reserved Wonder Workshop,
the Wonder Workshop logo, Dash, Dot, and Cue are trademarks of Wonder Workshop, Inc.

w:onder
workshop

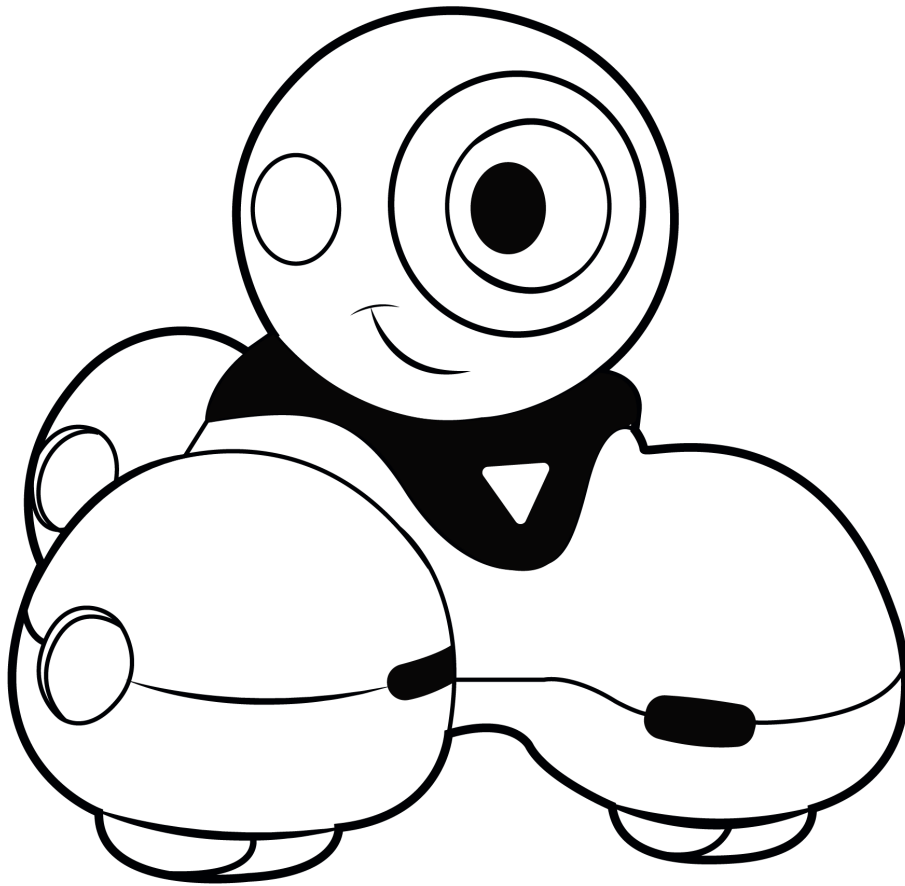

Wonder Workshop's 2019 Wonder League Robotics Competition. Copyright (C) 2019 Wonder Workshop, Inc. All Rights Reserved.

w:onder
workshop Learn more about our educational resources at:
www.makewonder.com

Copyright © 2020 Wonder Workshop, Inc. All Rights Reserved Wonder Workshop,
the Wonder Workshop logo, Dash, Dot, and Cue are trademarks of Wonder Workshop, Inc.

w:onder
workshop

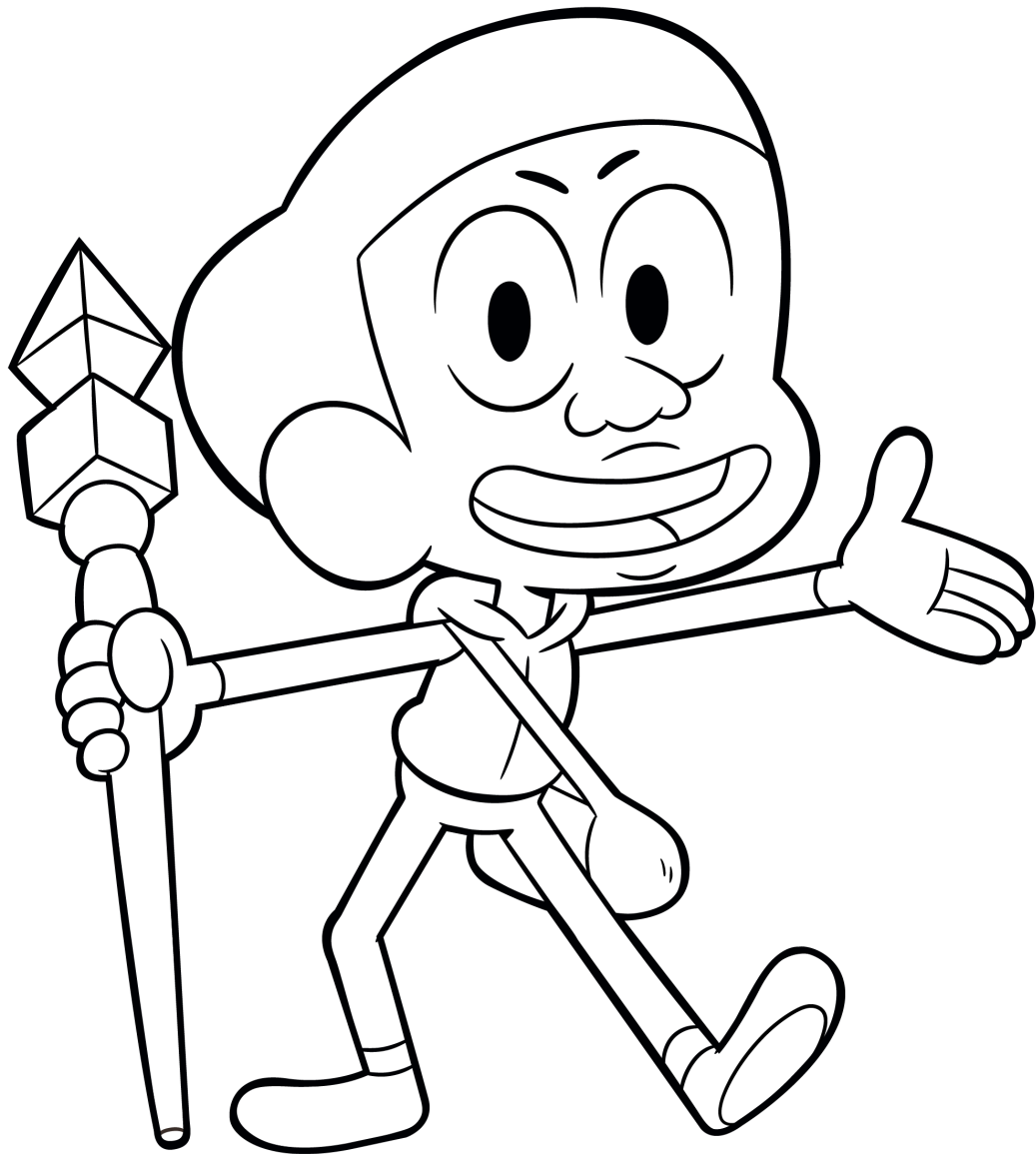

Wonder Workshop's 2019 Wonder League Robotics Competition. Copyright (C) 2019 Wonder Workshop, Inc. All Rights Reserved.

CRAIG

w:onder
workshop Learn more about our educational resources at:
www.makewonder.com

Copyright © 2020 Wonder Workshop, Inc. All Rights Reserved Wonder Workshop,
the Wonder Workshop logo, Dash, Dot, and Cue are trademarks of Wonder Workshop, Inc.

w:onder
workshop



Wonder Workshop's 2019 Wonder League Robotics Competition. Copyright (C) 2019 Wonder Workshop, Inc. All Rights Reserved.

JP

w:onder Learn more about our educational resources at:
workshop www.makewonder.com

Copyright © 2020 Wonder Workshop, Inc. All Rights Reserved Wonder Workshop,
the Wonder Workshop logo, Dash, Dot, and Cue are trademarks of Wonder Workshop, Inc.

w:onder
workshop



KELSEY

Wonder Workshop's 2019 Wonder League Robotics Competition. Copyright (C) 2019 Wonder Workshop, Inc. All Rights Reserved.

w:onder
workshop

Learn more about our educational resources at:
www.makewonder.com

Copyright © 2020 Wonder Workshop, Inc. All Rights Reserved Wonder Workshop,
the Wonder Workshop logo, Dash, Dot, and Cue are trademarks of Wonder Workshop, Inc.