

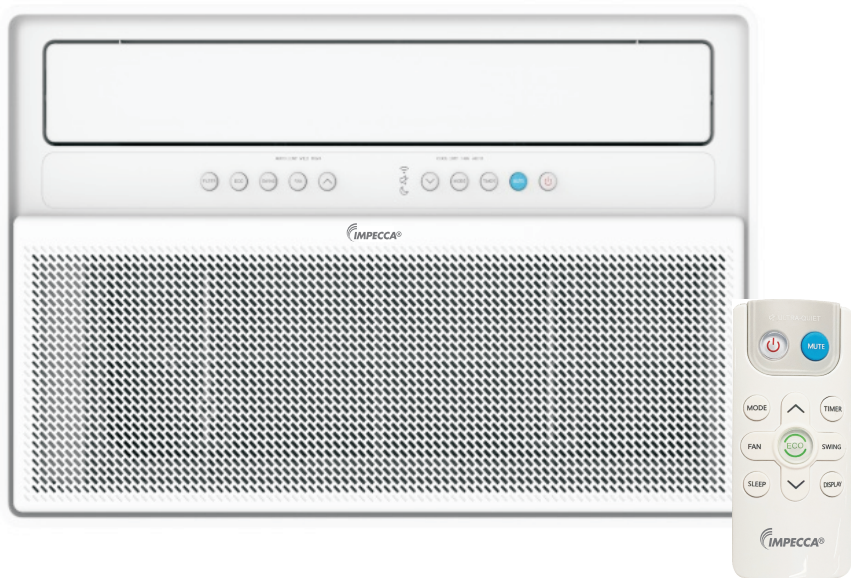

## Window Air Conditioner



## User's Guide

Models:

IWA15-VSA26

IWA18-VSB27

IWA24-VSB27

[www.impecca.com](http://www.impecca.com)



# Table of Contents

IMPORTANT SAFETY INSTRUCTIONS .....	1
What's in the Box .....	4
Introduction .....	5
Operating Instructions .....	6
Setup & Installation .....	8
Other Features .....	18
Maintenance .....	19
Trouble shooting .....	20

# IMPORTANT SAFETY INSTRUCTIONS

Before installing and using your air conditioner, please read this owner's manual carefully. Store this manual in a safe place for future reference.

Your safety and the safety of others is very important to us. Please pay attention to all safety messages outlined in this owner's manual.

**WARNING:** To reduce the risk of fire, electrical shock or injury when using your air conditioner, follow the following basic precautions:

## ELECTRICAL REQUIREMENTS

The electrical ratings for your air conditioner are listed on the model and serial number label located on the front right hand side of the unit (when facing the front).

## REGISTER YOUR APPLIANCE

You can register your appliance online by going to [register.tcl.com](http://register.tcl.com)

Be sure to retain your original sales receipt. A valid proof of purchase is required for all warranty claims.

## BATTERY WARNING STATEMENT

Do not mix old and new batteries and do not mix alkaline, standard (carbon-zinc) or rechargeable (ni-cad, ni-mh, etc.) batteries

Document your model and serial numbers here:	
Model # _____	Serial # _____
You can locate your 20 digit serial number underneath the bar code (On the right hand side of the AC).	

WARNING	Specific electrical requirements are shown in the diagram below. Follow these requirements below for the type of plug on the power supply cord.	
<b>Electrical Shock Hazard</b> Plug into a grounded 3 prong outlet. Do not remove the ground prong. Do not use an adapter Do not use an extension cord. Failure to follow these instructions can result in death, fire, or electrical shock	Wiring Requirements	Power Supply Cord
	<ul style="list-style-type: none"> <li>115V(103min-127max)</li> <li>(15K) (0-15 amps)</li> <li>(15K) (15 amp time-delay fuse or circuit breaker)</li> <li>208/230V(187min-253max)</li> <li>(18K) (0-13 amps)</li> <li>(24K) (0-20 amps)</li> <li>(18K) (15 amp time-delay fuse or circuit breaker)</li> <li>(24K) (20 amp time-delay fuse or circuit breaker)</li> <li>Use on single outlet circuit only</li> </ul>	

## RECOMMENDED GROUND METHOD

For your personal safety, this air conditioner must be grounded. This air conditioner is equipped with a 3 prong power supply cord with a grounded plug. To minimize the possibility of electrical shock, the cord must be plugged into a 3 prong outlet and grounded in accordance with all local codes and ordinances. If a 3 prong outlet is not available, it is the customer's responsibility to have a properly grounded 3 prong outlet installed by a qualified electrician.

WE ARE  
READY TO  
HELP

contact us first  
with any questions

# Introduction to Refrigerants R32

The refrigerants used for air conditioners are environmentally friendly hydrocarbons R32. This kind of erant is combustibile and odorless. Moreover, it can burn and explode under certain condition. However, there will be no risk of burning and explosion if you comply with the following table to install your air conditioner in a room with an appropriate area and use it correctly. Compared with ordinary refrigerants, Refrigerant R32 is environmentally friendly and do not destroy the ozone sphere and that itsvalue of greenhouse effect is also very low.



## Warning

- Please read the manual before installation,using,maintenance.
- Do not use means to accelerate the defrosting process or to clean, other than those recommended by the manufacturer;
- The appliance shall be stored in a room without continuously operating ignition sources (for example: open flames, an operating gas appliance or an operating electric heater.
- Do not pierce or burn.
  - Be aware that refrigerants may not contain an odour.
  - information for handling, installation, cleaning, servicing and disposal of refrigerant.
  - a warning to keep any required ventilation openings clear of obstruction.
  - a notice that servicing shall be performed only as recommended by the manufacturer.
  - Information for qualification of workers
  - Information on servicing
  - Repairs to sealed components
  - Repairs to Intrinsically safe components
  - Cabling
  - Detection of flammable refrigerants
  - Removal and evacuation
  - Charging procedures
  - Decommissioning, labelling and recovery
- Please contact the nearest after-sale service center when maintenance is necessary. At the time of maintenance, the maintenance personnel must strictly comply with the Operation Manual provided by the corresponding manufacturer and any non-professional is prohibited to maintain the air conditioner.
- The handling, installation, storage, servicing and disposal must comply with the ] provisions of gas-related national laws and regulations, and also national wiring regulation.
- It is necessary to clear away the refrigerant in the system when maintaining or scrapping an air conditioner. Be aware that refrigerants may not contain an odour.

This appliance is not intended for use by persons (including children) with reduced physical, sensory or mental capabilitiesor supervision or instruction concerning use of the appliance by a person responsible for their safety.

Children should be supervised to ensure that they do not play with the appliance.

Unit operation limits: Outdoor side 61~110, 80%RH, indoor side 61~90, 80%RH.



# Installation Safety Principles

## 1. Site Safety

Open Flames Prohibited



Ventilation Necessary



## 2. Operation Safety

Mind Static Electricity



Open Flames Prohibited  
Must wear protective clothing and  
anti-static gloves

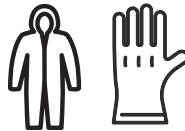

Don't use mobile phone



## 3. Installation Safety

- Refrigerant Leak Detector
- Appropriate Installation Location













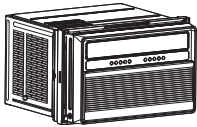



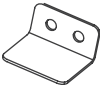

The left picture is the schematic diagram of a refrigerant leak detector.

Please note that:

1. The installation site should be in a well-ventilated area.
2. When installing an air conditioner, it is necessary to take appropriate anti-static measures such as wear anti-static clothing and/or gloves.
3. Installation or maintenance location should not be surrounded by obstacles or close to any heat source, flammable, and/or explosive areas or objects.
4. If the product suers refrigerant leak during the installation, all personnel should go out till the refrigerant leaks completely for 15 minutes.If the product is damaged, a professional must carry such damages product back to the maintenance station. It is prohibited to weld therefrigerant pipe or conduct other operations on the contaminated site.
5. The air conditioner unit needs to sit on a flat even surface.
6. It is necessary to avoid the places where there are other electrical products, power switch plugs and sockets, kitchen cabinet, bed, sofa and other valuables directly under the lines on two sides of the indoor unit.
7. Any ventilation openings of unit should be free from obstructions.

# What's in the Box

Open the carton and remove the below parts.

APPEARANCE	PART NAME	QUANTITY
	Window Air Conditioner	1
	Remote Control	1
	Long Foam Seal (Non-Adhesive)	1
	Long Foam Seal (Adhesive)	1
	$\frac{3}{4}$ " Screw	4
	Remote Control Battery	2
	Security Bracket	1
	$\frac{1}{2}$ " Screw	3
	Panel Seal (Adhesive)	2
	$\frac{5}{16}$ " Long Hex-head Screw	7
	$\frac{1}{2}$ " Long Hex-head Screw	2
	$\frac{1}{4}$ " Long Hex-head Screw	4
	$\frac{5}{8}$ " Long Flat head Bolt and Locknut	2
	Sill Angel Bracket	2
	$\frac{1}{2}$ " Long Flat head Bolt and Locknut	4
	Gasket	2
	Support Bracket (with Rand L remark)	2

Note: Illustrations in this manual are for explanatory purposes only. Product design and aesthetics may vary. Please search the entire package for the contents listed above as they may be packaged on top or underneath the main AC unit.

# Introduction

For remote control model

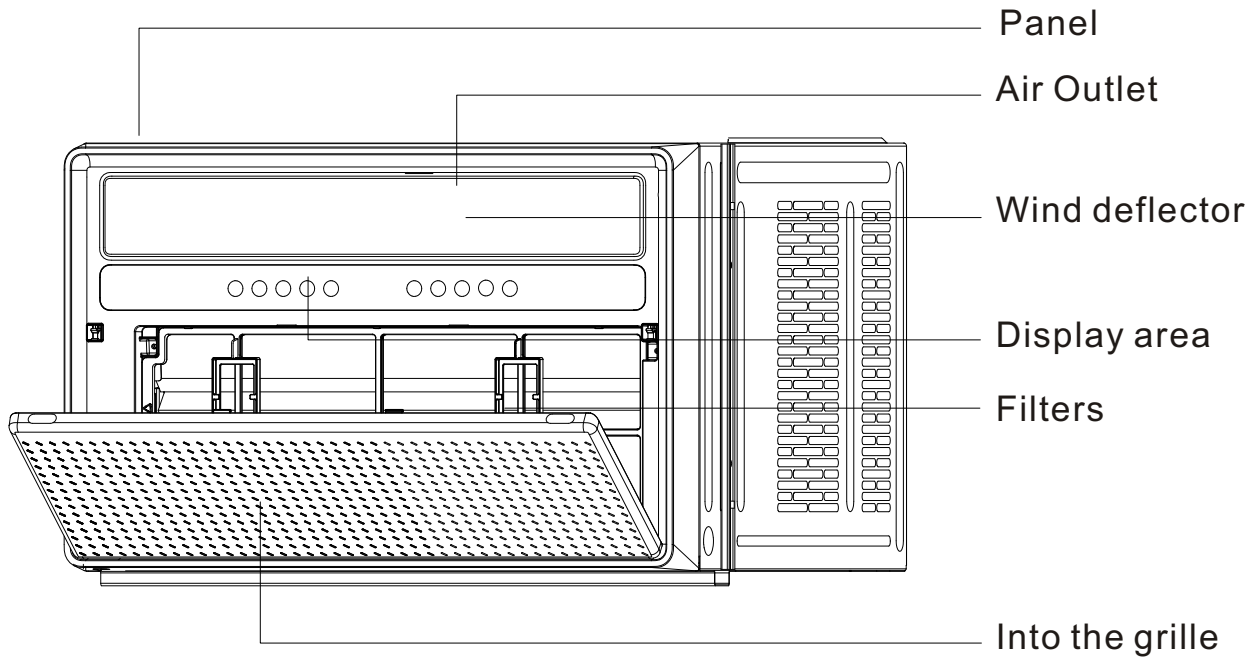

Control Panel

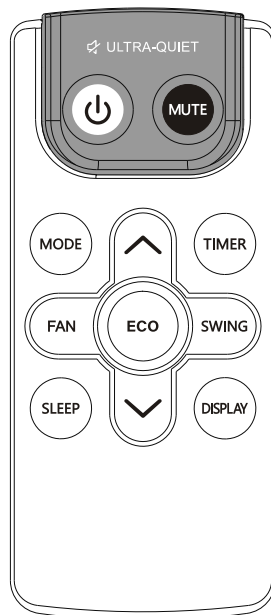

Remote Controller











## Attention

- 1) The outlook and some function of remote control may vary according to the model.
- 2) The shape and position of buttons and indicators may vary according to the model, but their function is the same.
- 3) The unit confirms the correct reception of each press button with a beep.



# Operating Instructions

## ► For remote control model

You can easily operate this air conditioner by press relevant button on the control panel as well as the remote controller.

	Clean the dust filter.
	Turn on/off the ECO mode, under Cool/Dry mode
	Select to adjust the airflow direction by swinging the louver vertically.
	Adjust fan speed (Auto,Low, Med, High) NOTE: Fan speed setting is available in Auto,Cool, and Fan modes only.
	Increase the air conditioning temperature.
	Decrease the air conditioning temperature.
	Switch between Cool/Dry/Fan/Auto mode.
	Timer on or Timer off the unit.
	Turn on/off the MUTE mode.
	Turn on the air conditioner or switch to standby.

## Indication symbols of LED on control panel

AUTO LOW MED HIGH	Indicates Automatic,Low,Medium and High fan speeds, respectively.
	Indicates that there is a WiFi connection.
	Indicates the unit is in MUTE mode.
	Indicates the unit is in Sleep mode.
COOL DRY FAN AUTO	Indicates Cool, Dry, Fan, and Auto mode, respectively.





### Description:

- 1) Above LED lights on when the relevant mode is in used.
- 2) In Eco mode, when the desired temperature is reached, the compressor will turn off and the fan will continue to run for 3 minutes before turning off. The fan will turn on for 1-minute at every 5-minute interval until the room temperature is above the set temperature, at which time the compressor turns back on and continues cooling.
- 3) When the running time reaches 500 hours, the filter reminder will light up to indicate the filter needs to be cleaned. Press the Filter button to reset the filter reminder. Please see the maintenance section of this manual for filter cleaning instructions.

# Operating Instructions

## Remote controller

*The remote controller transmits signals to the system.*

No.	Button	Function
1		Turn the device on/off
2		Select Mute to lower the operating volume to its quietest setting.
3	MODE	Cycle through Cool, Dry, Fan, and Auto modes.
4		Increased the temperature/Timer.
5	TIMER	Set a Timer to turn the air conditioner on/off
6	FAN	Adjust the fan speed (Low, Medium, High, Auto). Press and hold for 5s to switch between ° F/° C.
7	ECO	Designed to save energy while keeping your room at the set temperature.
8	SWING	Start and pause vent oscillation.
9	SLEEP	Designed to save energy while your sleep.
10		Decrease the temperature/Timer.
11	DISPLAY	Turn on/off the device's display.

### Timer:

When the air conditioner is on or in standby, press the Timer button and its icon will flash on the LED display.

During the flashing process, press + or - to select a timer from 0 to 24 hours, then press the Timer button again to confirm the setting.

After the timer ends, the air conditioner will start/stop running automatically.

Turning the air conditioner ON or OFF at any time or adjusting the timer setting to 0.0 hour will cancel the timer program.

# Setup & Installation

## Window Requirements

1. This air conditioner is designed to be installed in a standard single-hung or double-hung window with a window width between 29.5" and 41" (750mm - 1040mm).
2. The lower sash (the lower part of the window that moves up and down) must allow for 14.5" of vertical clearance when open.

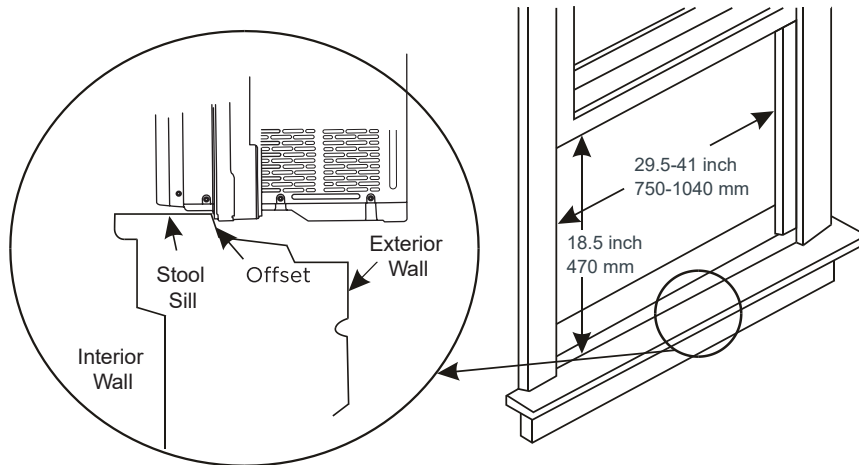

4. All supporting parts must be secured to firm wood, masonry, or metal.
5. The electrical outlet must be within reach of the power cord. (Electrical outlets only, no power strips or other outlets allowed.)

Note: Store the air conditioner in its product box while not in use.

## Suggested Tools for Installation (Not Included)

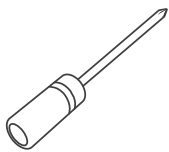

Phillips  
Screwdriver



Scissors  
or Knife



Pencil

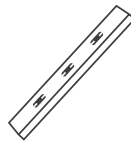

Level

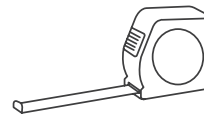

Tape Measurer  
or Ruler



Drill and  
1/8" Drill Bit



### CAUTION

Heavy object. Team handling is required during the installation process.

## Getting Started

### Step 1: Unboxing

Carefully remove all packaging and wraps from the air conditioner and its accessories.



### CAUTION

Heavy object. Team handling is required during the installation process.

### Step 2: Testing

Before installing your AC, let's test it to make sure it works properly, and your outlet has the proper power level.

First, place it on a flat surface, plug it directly into a wall outlet (never use a powerstrip or other device), and turn it on.

Next, use the Mode button on your control panel to change the AC to Cool Mode and press the down arrow to set the temperature to the lowest setting. After 3 minutes, the AC should be blowing cool air. If so, please continue to the next step. If not, see detailed troubleshooting tips at support.

# Prepare Air Conditioner for Installation

## **⚠ WARNING**

### **Excessive Weight Hazard**

Use two or more people to move and install air conditioner.  
Failure to do so can result in back or other injury.

### **1. Unpack the Air Conditioner**

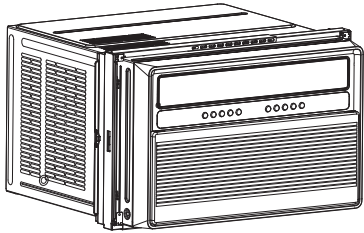

#### **Remove Packaging Materials:**

Gently handle the air conditioner while unpacking the unit.

Place the air conditioner on a hard, flat surface.

Remove tape and glue residue from surfaces before turning on the air conditioner. Rub a small amount of liquid dish soap over the adhesive with the fingers. Wipe with a damp cloth and dry. Do not use sharp instruments, rubbing alcohol, flammable fluids, or abrasive cleaners to remove tape or glue. These products can damage the surface of the air conditioner.

Remove any packaging materials inserted into the side louvers.

Dispose of/recycle packaging materials in an appropriate way.

### **2. Remove filter and front panel**

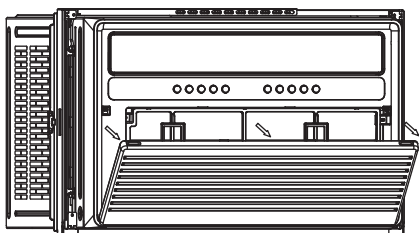

Pull down the front panel and remove the filter.  
Lift the front panel up wards and remove from the air conditioner.

### **3. Remove front panel and cabinet screws**

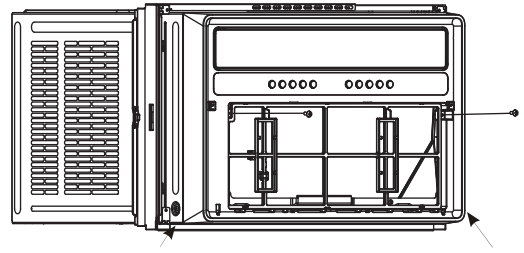

Remove the four screws.

NOTES: The front panel screws must be reinstalled before mounting the air conditioner.

### **4. Remove the connection**

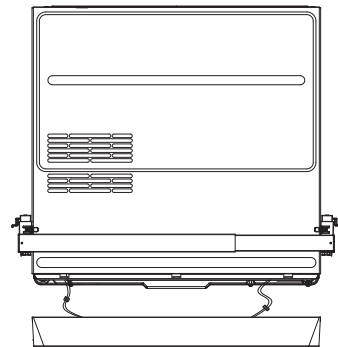

Remove the cable connecting the display board

### **5. Remove chassis**

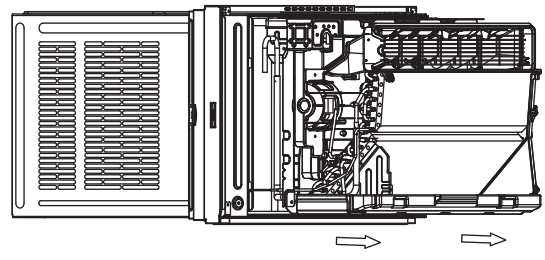

Hold the cabinet while pulling on the base handle to carefully remove the unit.  
**IMPORTANT:** To avoid damage, do not pull or lift near the top of the unit.

### Step 3: Applying the Adhesive Foam Seal

Measure the length of the upper window frame, trim the adhesive foam seal to the appropriate length, and apply as shown below.

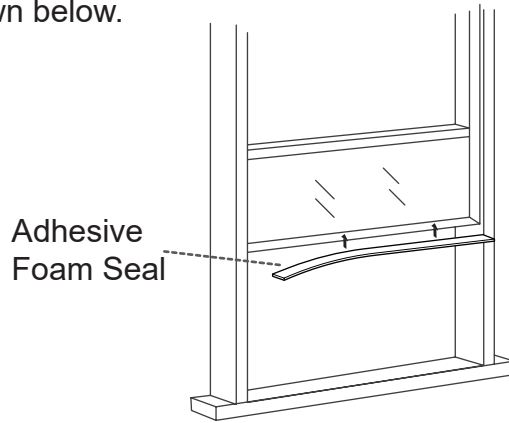

### Step 4: Placing Inside an Open Window

Using team lift, carefully lift the air conditioner and place in the windowsill. Next, close the window, making sure the air conditioner is centered and the bottom rail is flush against the windowsill.

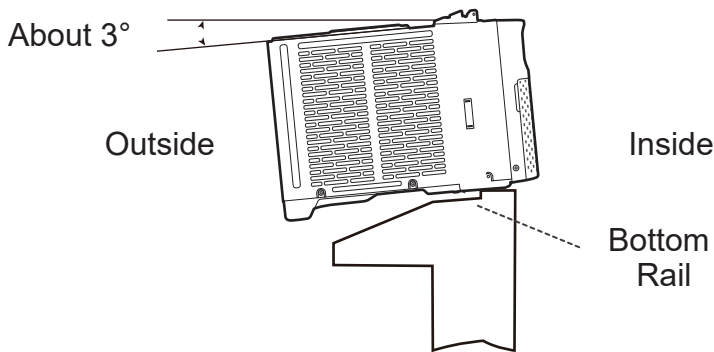

#### CAUTION

Be careful to avoid cuts from the sharp metal edges and aluminum fins on the front and rear coils!

Note: The air conditioner should be tilted about 3° to allow for better drainage of condensate and rainwater. Using a level, measure about 1/3 bubble for the correct slant.

### Step 5: Securing the Side Brackets

Extend the side brackets from both sides of the air conditioner onto the left and right window frames and secure by installing four 3/4" screws as shown

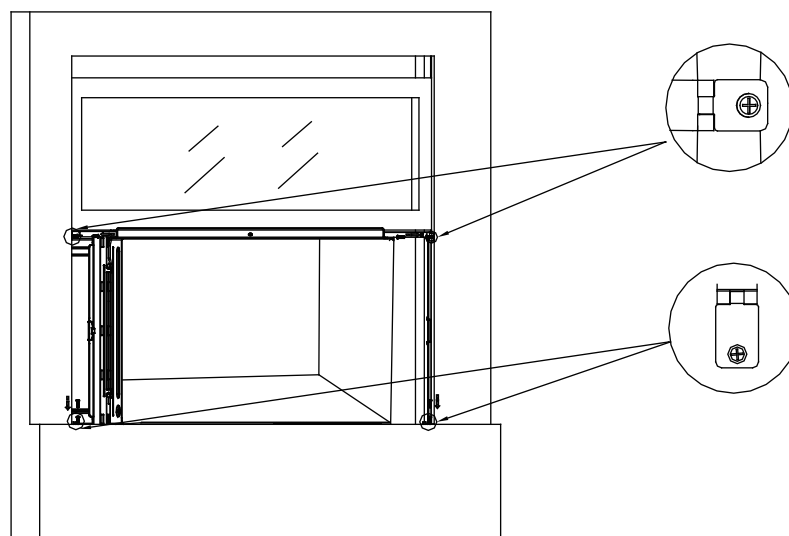

NOTE: Fix the upper screws first, then the lower screws.

## Step 6: Securing the Side Panels

Pull the side panels inwards to align with the brackets, then secure onto the sides by snapping the jutting points onto the locking pins.

The side panels should be locked by 1/4" Long Hex-head Screw .

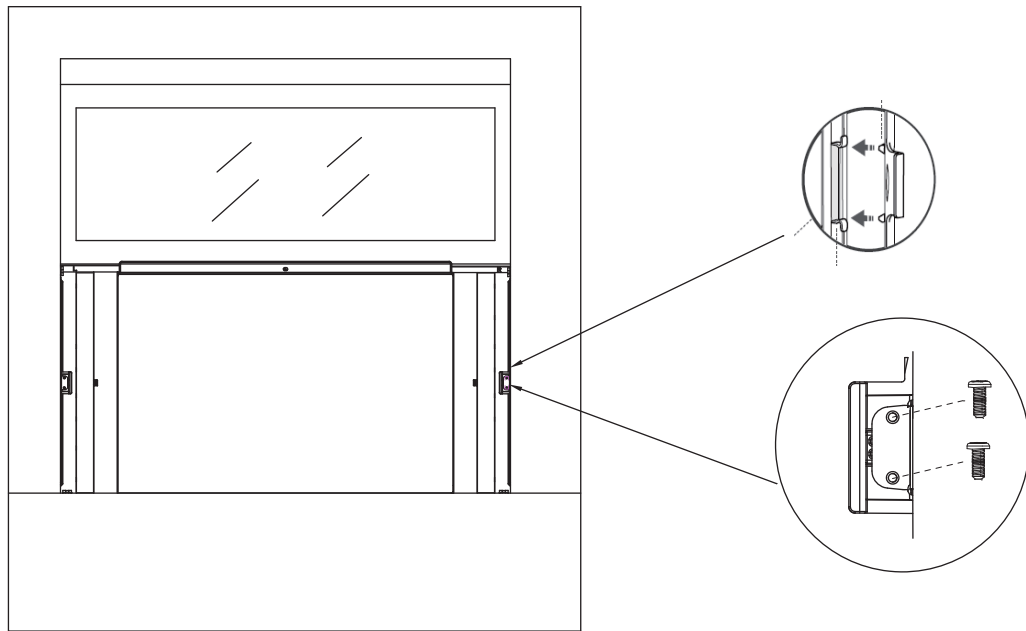

## Step 7: Sealing Any Gaps with Modeling Clay (Plasticene)

Fill the crevices between the side brackets and panels with the included plasticene.

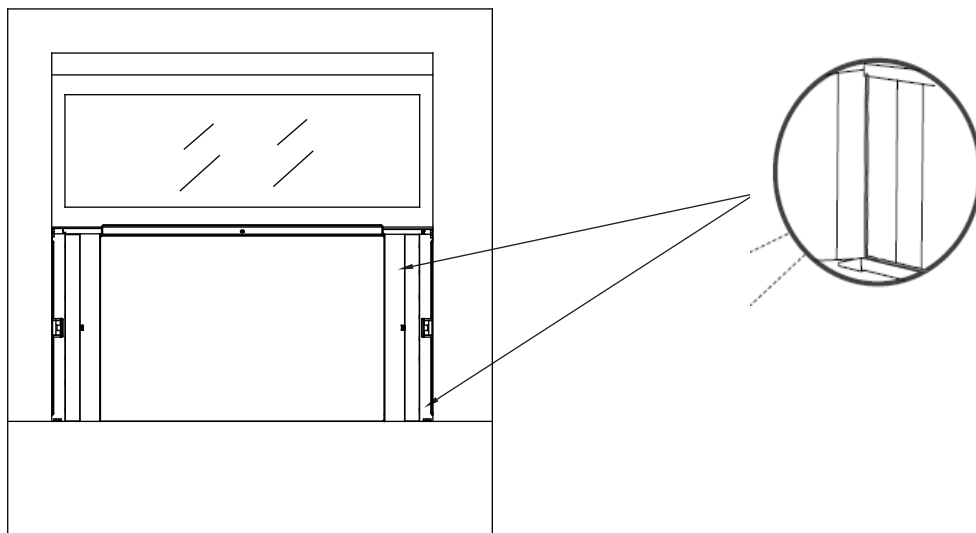

## Step 8: Securing the Screw into the Top Rail

Secure the ½" Screw into the top rail of the air conditioner to the window frame.

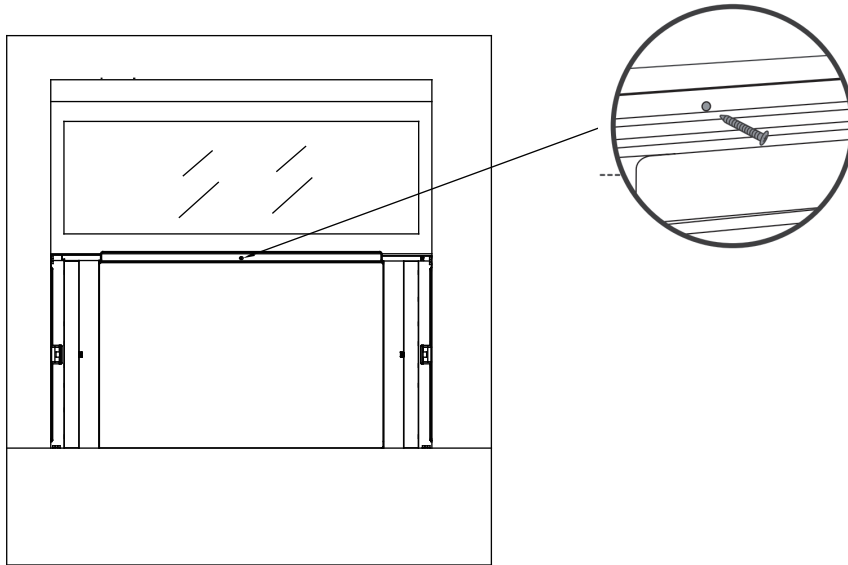

## Step 9: Installing the Security Bracket (Recommended)

For security purposes, it is recommended to attach the security bracket to the top of the window using two ½" screws to prevent opening the window from outside. However, the security bracket can be removed to allow you to open the window when desired.

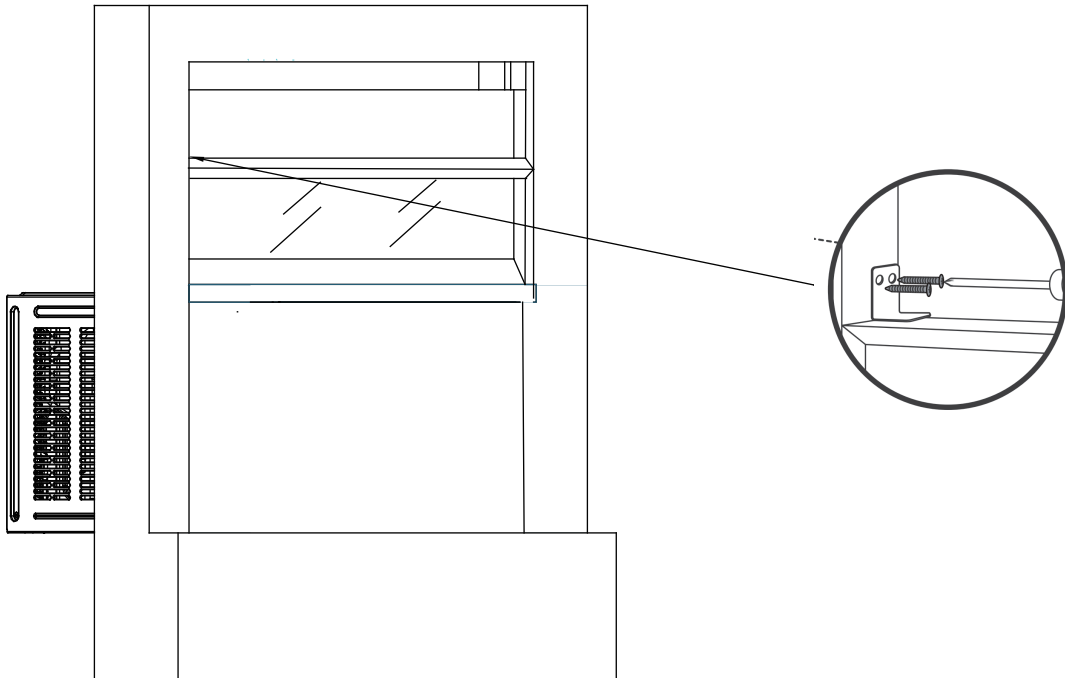

## Step 10: Filling the Gap Between Sashes

### Applying the Panel Seals

Trim the non-adhesive foam seal to the appropriate length and insert between the window sashes. **CAUTION:** When open the window, be sure that the fixed screws are available from the curtain to the window frame.

Measure the length extended by the side panels, trim the panel seals to the appropriate length, peel off the backings and apply on the panels on both sides.

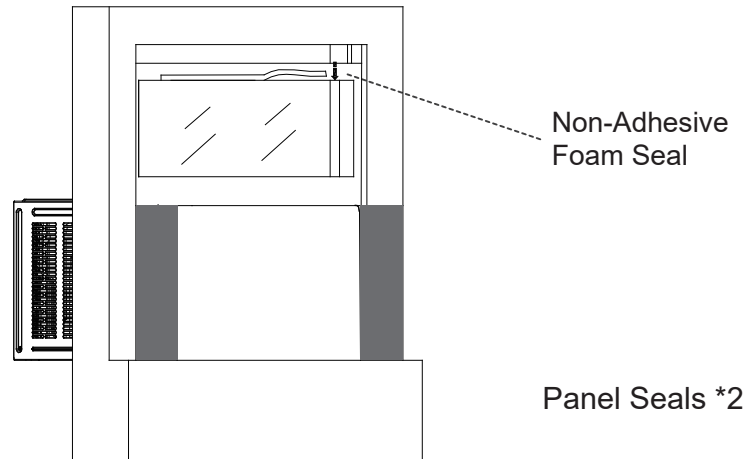

### Install Support Brackets

1. Hold each support bracket flush against the outside of the window sill. Tighten each bracket to the bottom of the cabinet as shown below. Mark the brackets at top level of the window sill and then remove.

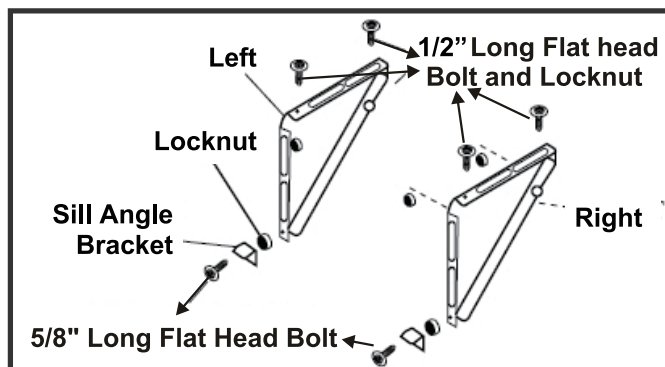
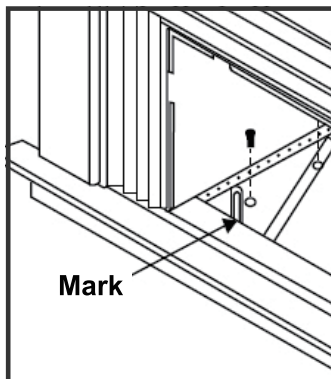

2. Assemble the sill angle brackets to the support brackets at the marked position as shown above. Hand tighten, but not all the way for any changes that may need to be made later during installation.
3. Install the support brackets (with sill angle brackets attached) to the bottom of the cabinet as shown below.
4. Tighten all 6 bolts securely.

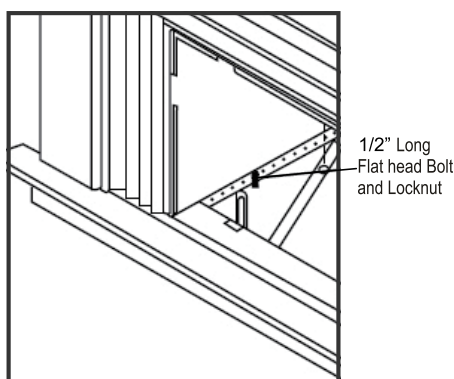

## Installing the Chassis into the Cabinet

1. Team lift (two people) the air conditioner chassis and carefully slide it into the cabinet. Let the front of the air conditioner hang out approximately 6".
2. CAUTION: DO NOT PUSH ON THE CONTROLS OR FINNED COILS.
3. Be sure the chassis is firmly seated in the back of the cabinet.
4. Insert all screws removed during window installation and reattach the front panel, air filter and grille.

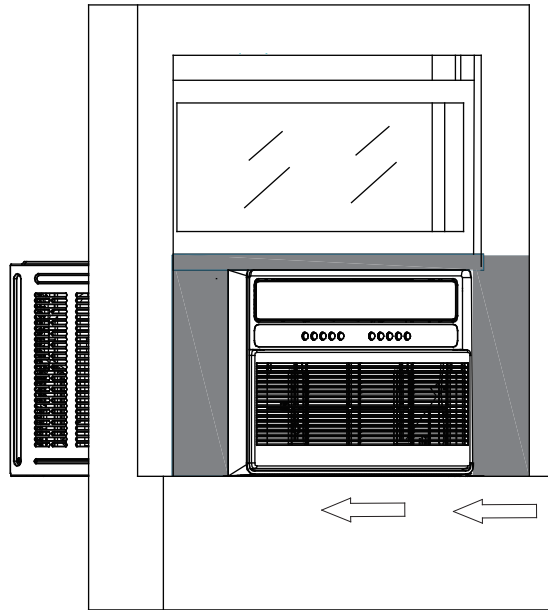

## If AC is Blocked by Storm Window Frame

Add wood as shown above or remove storm window frame/obstruction before installing the window air conditioner.

If the Storm Window Frame must remain, be sure the drain holes or slots are not caulked or painted shut. Accumulated rainwater or condensation must be allowed to drain out.

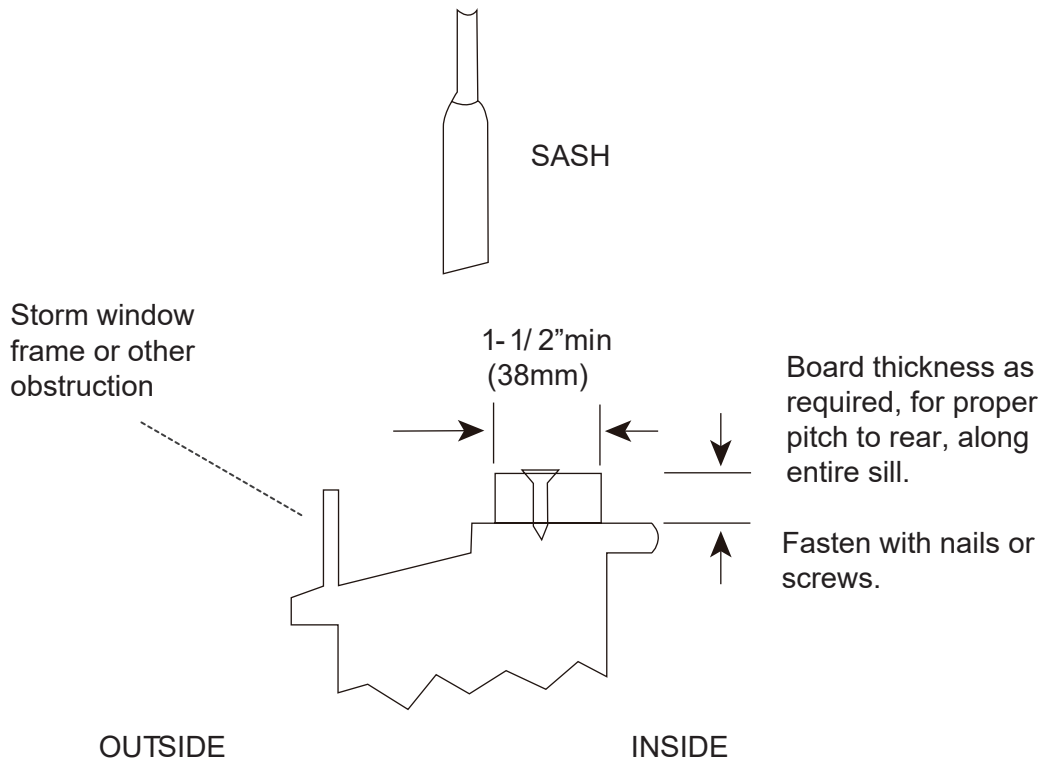

### CAUTION

When opening the window, be sure that the fixed screws are secured properly in place without any objects affecting their attachment to these side brackets and associated window frame to prevent the unit from becoming unstable and falling.



# ASSEMBLY & INSTALLATION-THRU-THE-WALL (CONT.)

## 1.Unpack the Air Conditioner

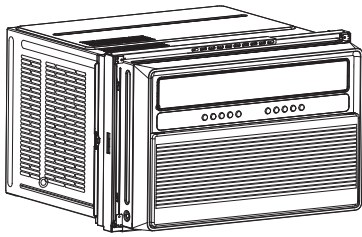

## 2.Remove parts

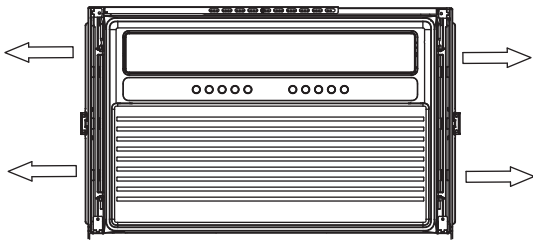

Remove Left Telescopic Curtain Support Assy.  
Remove Right Telescopic Curtain Support Assy.

## 3.Remove Hinge

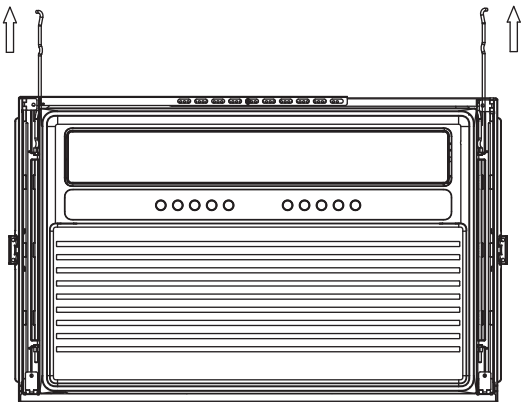

## 4.Remove filter and front panel

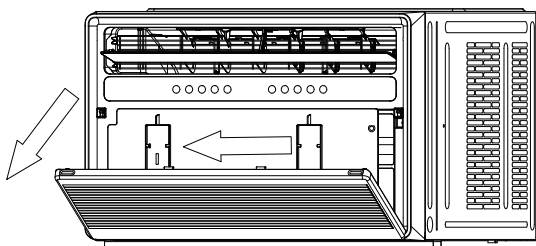

## 5.Remove faceplate screws

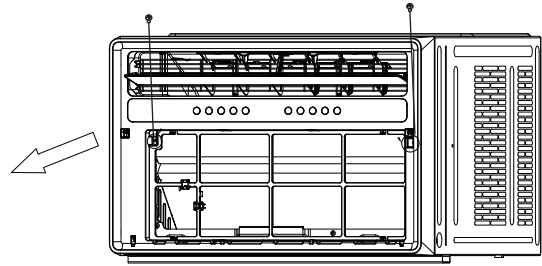

Remove the two faceplate screws.

## 6.Remove case screws

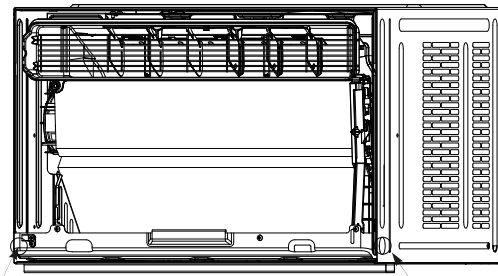

Remove 2 screws fixed on left and right sides  
of case and chassis

## 7.Remove chassis

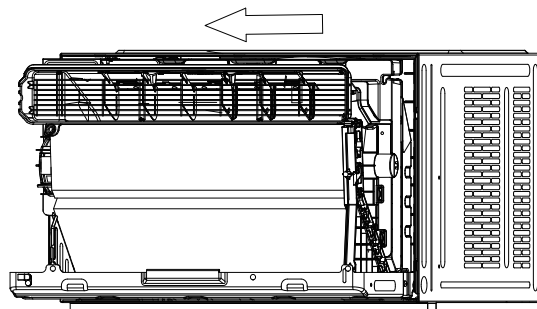

## 8.Remove Upper guide rail

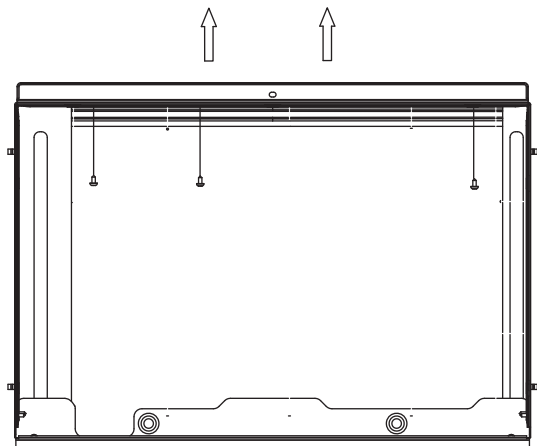

# ASSEMBLY & INSTALLATION-THRU-THE-WALL (CONT.)

## Prepare the Wall

1. Prepare the wall in frame construction (including brick and stucco veneer). Working from inside the room, find the wall stud that is nearest the center of the installation area.
2. Cut a hole on each side of the center stud.
3. Measure between the inside edges of every other stud as shown below.

Carefully measure and cut an opening with the following dimensions depending on your model.

WIDTH "X" = inside model plus twice the thickness of the framing material used.

HEIGHT "Y" = inside model plus twice the thickness of framing material used.

Model	15K/18K/22K/24K
Inside Frame Height	(435mm)
Inside Frame Width	(650mm)

4. Build a wooden frame with the INSIDE dimensions of your model listed above (Measure twice). The frame depth should be the same as the wall thickness. Fill in extra space from the opening to the studs with wood spacers as shown below.
5. Nail the spacers to the studs. They should be flush with the dry wall.

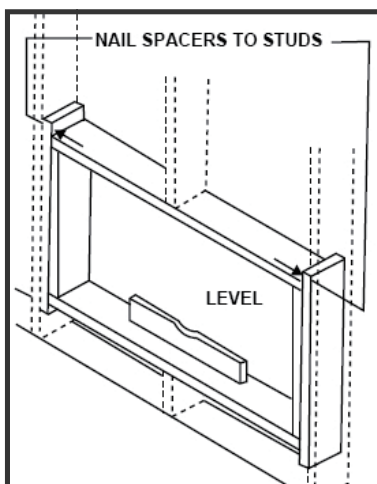
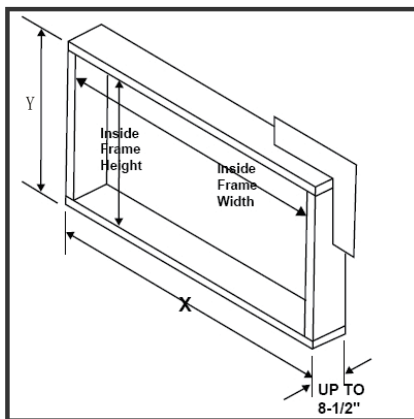

NOTE: If wall thickness is 8-1/2" or more, add aluminum flashing over the bottom of the frame opening to assure water is unable to enter the area between the inner and outer wall.

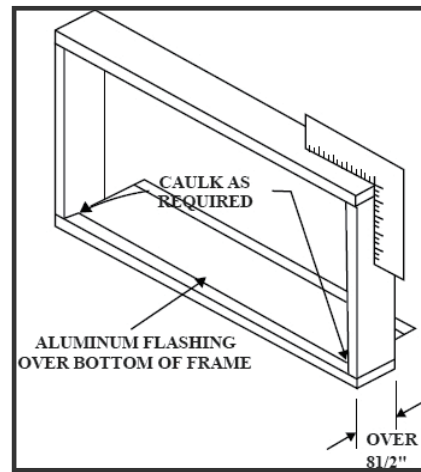

## Prepare and Install the Cabinet

1. Slide the chassis from the cabinet. Refer back to the REMOVE CHASSIS instructions in the WINDOW MOUNTING SECTION.
2. Place the cabinet into the opening with the bottom rail resting firmly on the bottom board of the wood frame.
3. Position the cabinet so it is tilted properly for water removal as seen below.

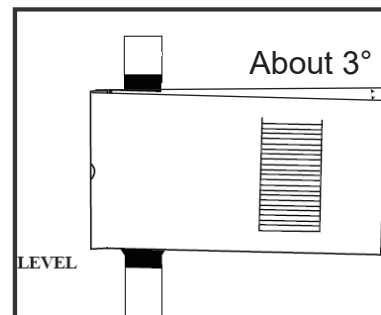

4. Secure the bottom rail to the wood frame with two 1/2" Long Hex-head Screws and gaskets as shown below.

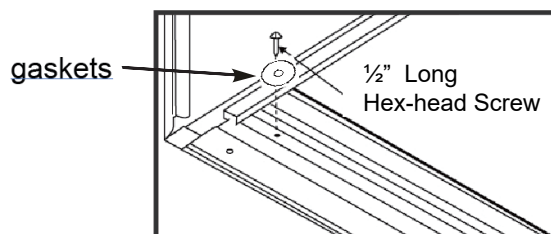

## ASSEMBLY & INSTALLATION-THRU-THE-WALL (CONT.)

Refer to the SUPPORT BRACKET ASSEMBLY in the WINDOW MOUNTING section to assemble the support brackets. A wooden strip nailed to the outside wall should be used in conjunction with the angled sill support brackets.

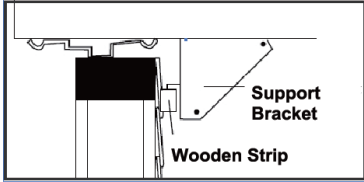

5. Screw or nail the cabinet to the wooden frame using shims if the frame is oversized, to eliminate possible noise. Remember to maintain proper slope for water elimination.

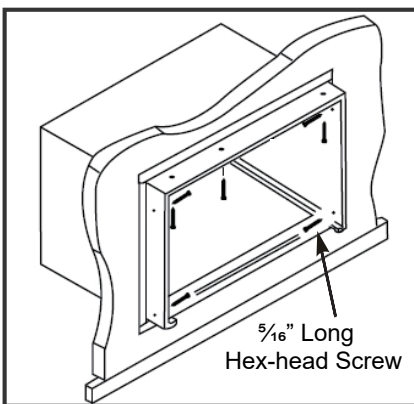

6. Install the chassis into the cabinet by following the steps described in the WINDOW MOUNTING section.

OPTIONAL: Caulking and installation of the trim on the interior wall may be done if desired. Caulk the openings around the top and sides of the cabinet and all sides of the wood sleeve to the opening.

NOTE: See the WINDOW MOUNTING instructions for the bottom rail seal location.

### Installing the Chassis into the Cabinet

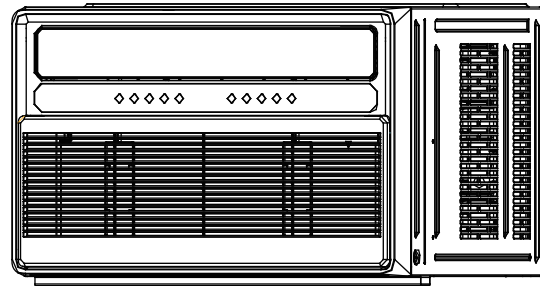

Push the whole machine into the outer box, fasten the screws on both sides of the outer box, and assemble the panels to complete the assembly of the whole machine.

## Other Features

### Filter Reminder

When the running time reaches 500 hours, the filter reminder will light up to indicate the filter needs to be cleaned. Press and hold the Filter button for 5 seconds to reset the filter reminder. Please see the maintenance section of this manual for filter cleaning instructions.

### Display Auto Off

- Display will dim after 30 seconds (or after 15 seconds in sleep mode)
- Wake up the display by pressing any button

### Memory

If the air conditioner is turned off but stays connected to the power, it will resume the previous settings (except the timer setting) when it is turned on again.

### Drain Water

This unit was designed to collect moisture from condensation in a collection pan in the base of the unit. The collected water is distributed by the rear fan on to the condenser coil. This aids in the overall efficiency of the unit.

It is normal to hear the water sloshing around when the fan is spinning.

If this behavior is not desired, the drain cap at the rear of the AC can be removed to drain a portion of the water. Doing so may lessen the efficiency of the AC. A minimal amount of water will still remain in the drain pan.

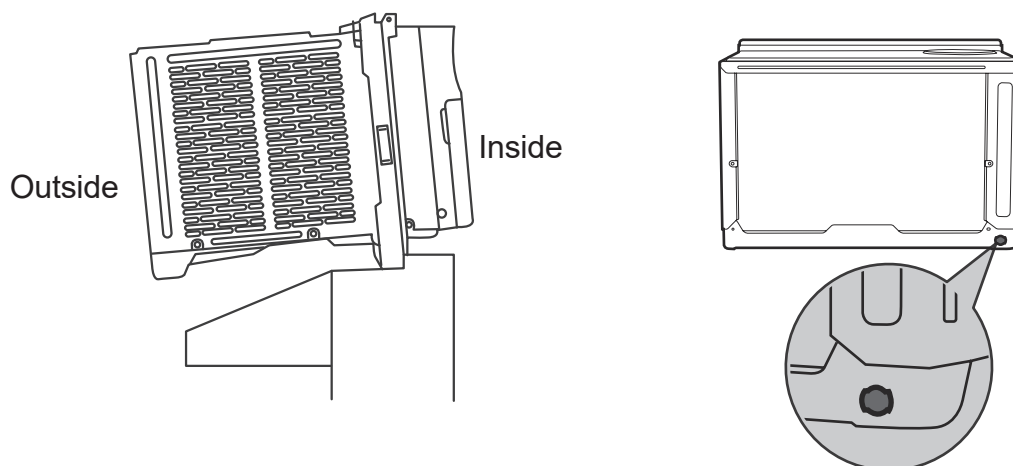

# Maintenance

## Care and Cleaning

Clean your air conditioner occasionally to keep it looking new. Before cleaning, be sure to unplug the unit from any and all power sources to prevent electric shock or fire hazards.

## Air Filter

The air filter should be checked at least once every month to see if it needs cleaning. Never use hot water over 104°F (40°C) to clean the air filter. Never attempt to operate the unit without the air filter. Trapped particles and dust can build up over time, which can result in decreased airflow and can cause the coils to accumulate frost. To clean the air filter:

1. Pull the grille out from the indents on both sides at the front and remove the filter inside.
2. Wash the filter using liquid dish soap and warm water. Rinse the filter thoroughly. Gently shake the filter to remove excess water.
3. Let the filter dry completely before placing it into the air conditioner.

Note: If you do not wish to wash the filter, you may vacuum the filter to remove the dust and other particles.

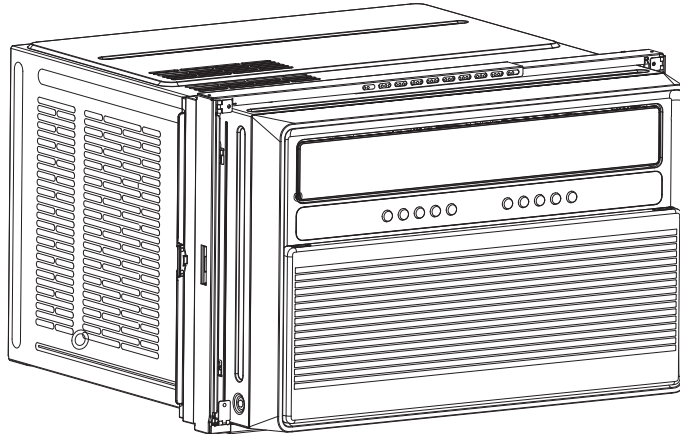

## Cabinet Cleaning

To clean the air conditioner's cabinet:

- Using a cloth dampened in a solution of warm water and mild liquid soap, wipe down the unit and the front panel. Then, using a clean dampened cloth, make sure to wipe down the unit to remove all excess soap and continue to dry.
- Never use harsh cleaners, wax, or polish on the cabinet front.
- Be sure to wring out excess water from the cloth before wiping round the control. Excess water may damage the unit.

## Storage

If you want to store the unit when not in use, we recommend removing the drain plug at the back of the unit and slightly tilting the unit towards the rear to drain any water in the pan in a safe manner. Next, clean the unit and then store it back in the original packaging or box until next use.

# Trouble shooting

PROBLEM	POSSIBLE CAUSES	SOLUTIONS
The air conditioner will not start	The air conditioner is unplugged	Make sure the air conditioner plug is pushed completely into the outlet.
	The fuse is blown/circuit breaker is tripped	Check the house fuse/circuit breaker box and replace the fuse or reset the breaker.
	Power failure	<ul style="list-style-type: none"> <li>• The unit will automatically restart when power is restored.</li> <li>• There is a protective time delay (approx. 3 minutes) to prevent tripping and overloading the compressor. For this reason, the unit may not start normal cooling for 3 minutes after it is turned back on.</li> </ul>
	The current interrupter device is tripped	<ul style="list-style-type: none"> <li>• Press the RESET button located on the power cord plug.</li> <li>• If the RESET button will not stay engaged, discontinue use of the air conditioner and contact a qualified service technician.</li> </ul>
The air conditioner does not cool as it should	Air flow is restricted	Make sure there are no curtains, blinds or furniture blocking the front of the air conditioner.
	The temperature control may not be set correctly.	Lower the set thermostat temperature.
	The air filter is dirty	Clean the filter. Refer to MAINTENANCE.
	The room may be too warm	Please allow time for the room to cool down after turning on the air conditioner.
	Cold air is escaping	Check for open furnace registers and cold air returns.
	The cooling coils are frozen	Switch to high fan speed and set the thermostat to a higher temperature.
	Temperature sensor is not well situated.	Temperature sensor behind the air filter is touching the coil. Try to move it so it does not contact the cold coil.

The air conditioner is freezing up	Ice blocks the air flow and stops the air conditioner from cooling the room	Switch to high fan speed and set the thermostat to a higher temperature.
The remote control is not working	The batteries are inserted incorrectly	Check the position of the batteries.
	The batteries may be dead	Replace the batteries.
Water is dripping outside	Hot and humid weather	This is normal.
Water is dripping INSIDE when the unit is cooling	The air conditioner is not correctly tilted outside	Improper installation. Tilt air conditioner slightly to the outside to allow water drainage. Refer to installation instructions.
Water is dripping INSIDE when the unit is cooling	Moisture removed from the air is draining into the base pan	This is normal for a short period in areas with low humidity and normal for a longer period in areas with high humidity
Noise when the unit starts	A "da-da" sound may occur for 30 seconds when the unit is turned on due to the compressor starting.	This is normal.

## CUSTOMER SUPPORT

---

Visit our website to contact us, find answers to Frequently Asked Questions, and for other resources which may include an updated version of this user's manual.

 **[www.impecca.com](http://www.impecca.com)**

If you wish to contact us by phone, please be sure to have your model number and serial number ready and call us between 9:00am and 6:00pm ET, at +1 866-954-4440.

Keep tabs on Impecca's newest innovations and enter contests via our social network feeds:

 [www.facebook.com/Impecca/](http://www.facebook.com/Impecca/)

 [www.instagram.com/impecca/](http://www.instagram.com/impecca/)

 [@impeccausa](https://twitter.com/impeccausa)

# ONE-YEAR LIMITED APPLIANCE WARRANTY (US)

Impecca™ warrants this product against defects in material and workmanship to the original purchaser as specified below.

**PARTS AND LABOR**— if the product is determined to have a manufacturing defect, within a period of one year from the date of the original purchase, Impecca™, at its own discretion, will repair or replace the product parts at no charge to you in the U.S.A.

To obtain warranty service by an authorized Impecca™ service center, please email us at: [service@impecca.com](mailto:service@impecca.com) to obtain a Repair and Maintenance Authorization (RMA) number and received instructions on how the repair and/or replacement procedure will take place.

**Any glass materials included with the appliance will be covered for a period of 60 days from purchase.**

Impecca™ specifically excludes from this warranty any non-electric/mechanical attachments, accessories and disposable parts including but not limited to outside case, connecting cables, batteries and AC adapters. Impecca™ reserves the right to repair or replace defective products with the same, equivalent or newer models.

We reserve the right to either repair or replace product at our discretion. Replacement may be either new or refurbished and while every endeavor will be made to ensure it is the same model, if not possible it will be equal or higher specification.

Normal "Wear and Tear" is not covered by this warranty. Further, Impecca™ hereby reserves the right to determine "Wear and Tear" on any and all products. Tampering or opening the product casing or shell will void this warranty in its entirety.

Exclusions: This warranty does not cover the following:

1. Any product that has a defaced or covered serial number.
2. Products that have been transferred to a second owner.
3. Rust on the interior or exterior of the unit.
4. Products listed as "As-Is" or "Refurbished."
5. Food loss due to any product failure.
6. Window air conditioners installed in a wall.
7. The product if used in a commercial setting.
8. Service calls that do not involve product malfunction.
9. Service calls for a product ruined by not following the provided instructions.
10. Service calls to correct improper installation.
11. Costs associated with making the product accessible for servicing (including but not limited to removal of

trim/molding/cabinetry, etc.)

12. Service calls to replace any consumables such as light bulbs, filters, etc.
13. Surcharges that may apply to service calls on weekends, nights, holidays. Damages to the finish of appliance or household furnishings due to installation of appliance.
14. Damages caused by any of the following: Acts of God; fires; misuse; accidents; incorrect power supply; service performed by unauthorized persons; use of non-genuine Impecca parts, etc.

ALL IMPLIED WARRANTIES, INCLUDING IMPLIED WARRANTIES OF MERCHANTABILITY AND FITNESS FOR A PARTICULAR PURPOSE ARE LIMITED IN DURATION TO 1 YEAR FROM THE DATE OF THE ORIGINAL RETAIL PURCHASE OF THIS PRODUCT.

THESE WARRANTIES AND REMEDIES ARE THE SOLE AND EXCLUSIVE WARRANTIES AND REMEDIES IN CONNECTION WITH THE SALE AND USE OF THE PRODUCT. NO OTHER WARRANTIES, ORAL OR WRITTEN, EXPRESSED OR IMPLIED, ARE GIVEN.

IMPECCA™ IS NOT RESPONSIBLE OR LIABLE FOR ANY DAMAGE, WHETHER SPECIAL, INCIDENTAL, CONSEQUENTIAL, DIRECT OR OTHERWISE, OR WHETHER KNOWN OR SHOULD HAVE BEEN KNOWN TO IMPECCA™, INCLUDING LOST PROFITS, GOODWILL, AND PROPERTY AND PERSONAL INJURY RESULTING FROM ANY BREACH OF WARRANTY, THE INABILITY TO USE THE PRODUCT OR UNDER ANY LEGAL THEORY IN CONTRACT OR TORT. IMPECCA LIABILITY IS LIMITED TO THE ACTUAL PURCHASE PRICE PAID TO THE RETAIL SELLER OF THE DEFECTIVE PRODUCT.

No Impecca™ dealer, agent or employee is authorized to make any modification, extension, change or amendment to this warranty without the written consent and authorization from Impecca™.

Some states do not allow the exclusion or limitation of implied warranties or liability for incidental or consequential damages, or do not allow a limitation on how long an implied warranty lasts, so the above limitations or exclusions may not apply to you. This warranty gives you specific legal rights, and you have other rights, which vary from state to state.

*Note: Our Warranty center services only to Continental U.S.A.*







## Wi-Fi User Manual

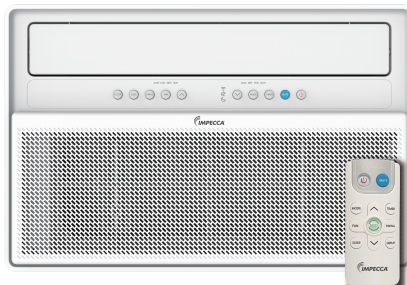

Models:

IWA08-VSA26

IWA15-VSA26

IWA10-VSA26

IWA18-VSB27

IWA12-VSA26

IWA24-VSB27

This description is applied to Air Conditioners with Wi-Fi function. Please read the manual carefully before using the product and keep it for future reference.

[www.impecca.com](http://www.impecca.com)

Need Help?

Please call us, we're here to assist you!

Impecca Customer Service

1-866-954-4440



# Let's get start!

**Operation guideline.** Please take below simple guideline instruction as reference.

Operation Steps	Operation Items	New Account	Re-install APP (registered before)
Step 1	Download and Install APP	YES	YES
Step 2	Activate APP	YES	YES
Step 3	Registration Account	YES	NO
Step 4	Login	YES	YES
Step 5	Add Device to control	YES	Registered Device will remain.

*Note: If you registered the account and added device before, when you re-install the APP again and login, the added device will remain .*

## FCC Caution (FCC ID: 2AJCLTWAC-TYWFS/2ANDL-WBR3)

This device complies with part 15 of the FCC Rules. Operation is subject to the following two conditions: (1) This device may not cause harmful interference, and (2) this device must accept any interference received, including interference that may cause undesired operation.

Any Changes or modifications not expressly approved by the party responsible for compliance could void the user's authority to operate the equipment.

Note: This equipment has been tested and found to comply with the limits for a Class B digital device, pursuant to part 15 of the FCC Rules. These limits are designed to provide reasonable protection against harmful interference in a residential installation. This equipment generates uses and can radiate radio frequency energy and, if not installed and used in accordance with the instructions, may cause harmful interference to radio communications. However, there is no guarantee that interference will not occur in a particular installation. If this equipment does cause harmful interference to radio or television reception, which can be determined by turning the equipment off and on, the user is encouraged to try to correct the interference by one or more of the following measures:

-Reorient or relocate the receiving antenna.

-Increase the separation between the equipment and receiver.

-Connect the equipment into an outlet on a circuit different from that to which the receiver is connected.

-Consult the dealer or an experienced radio/TV technician for help.

The distance between user and device should be no less than 20cm.

# CONTENTS

---

Wi-Fi Module specification and basic information.....	1
Download and Install the App.....	2
Activate APP.....	3
Registration.....	4
Login.....	6
Add device.....	8
Air conditioner control.....	10
Account management.....	28
Trouble Shooting.....	30

# Wi-Fi Module specification and basic information

## 1. Minimum specifications on a Smart phone:

Android 5.0 version or higher

IOS 9.0 version or higher

## 2. Basic parameters for Wi-Fi module

Parameters	Details
Network frequency	2.400 - 2.500GHz
Standards of WLAN	IEEE 802.11 b/g/n(channels 1-14)
Protocol stack support	IPv4/IPv6/TCP/UDP/HTTPS/TLS/MulticastDNS
Security support	WEP/WPA/WPA2/AES128
Network type support	STA/AP/STA+AP

# Download and Install the App



**SmartLife-SmartHome**

## For Android smart phone

Method1: Please scan the QR code with a browser scanner, download and install the APP.

Method2: Open the Google "Play Store" on your smart phone and search "SmartLife-SmartHome" , download and install the APP.



## For IOS smart phone

Method1: Please scan the QR code and follow the tips to get into "AppStore", download and install the APP.

Method2: Open the Apple "AppStore" on your smartphone and search "SmartLife-SmartHome" , download and install the APP.



**Note:**

**Please enable the permissions of Storage/Location/Camera for this APP when installing. Otherwise it will have some problems when operating.**

# Activate APP

The first time the app is used, it will need activating.

1. Launch the APP "SmartLife-SmartHome" on your smart phone.



**SmartLife-SmartHome**

2. Method1: Tap button "Scan" and scan the right Activate QR code

Method2: Tap "or Enter Activation Code" in bottom of the screen,

then enter the activate code 'IMPECCA' and tap "CONFIRM".

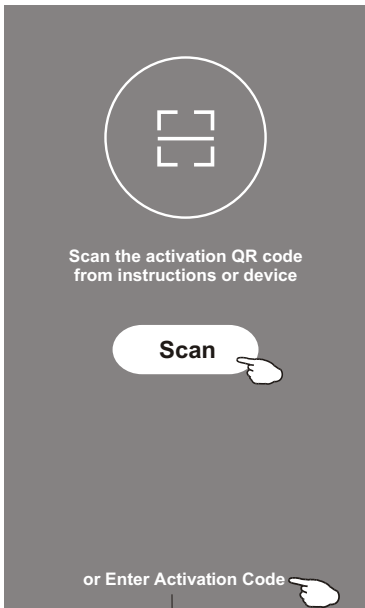

Activate QR code and activation code

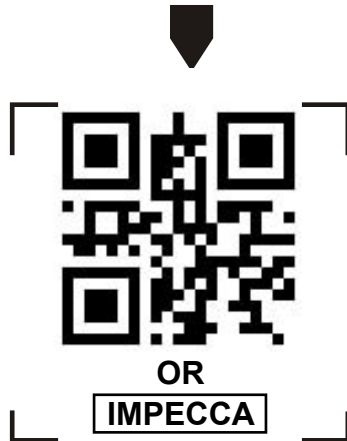

*Note: Without the QR code or activation code, you can't activate the APP and using it, please keep them safe.*

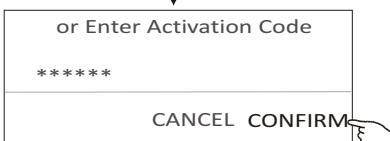

# Registration

- 1.If you don't have any account please tap button "Register".
- 2.Read the Privacy Policy and tap "Agree".

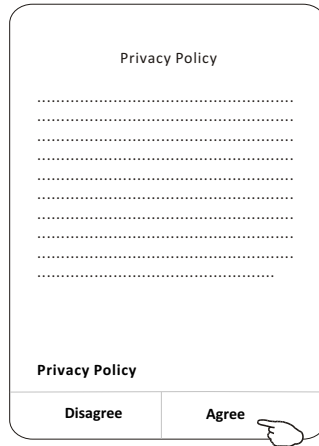
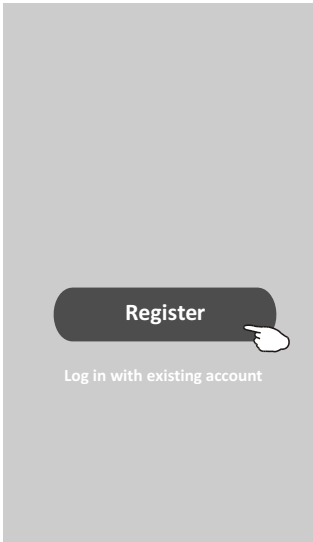

- 3.Tap ">" and choose the country.
- 4.Enter your e-mail address.
- 5.Tap the button "Obtain verification code".

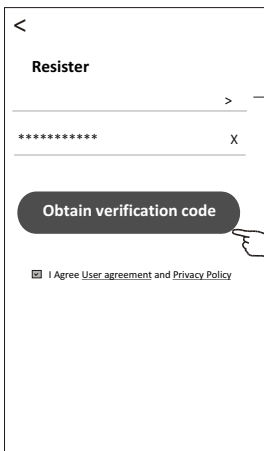

enter your e-mail address here

Search the country or slide the screen up/down to find and choose the Country.

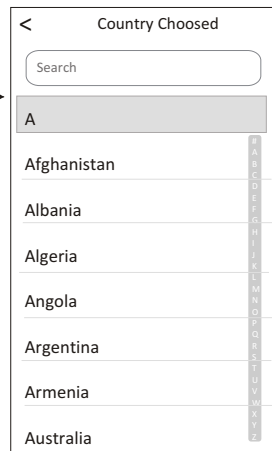

# Registration

6. Enter the verification code you received from e-mail.
7. Set the Password with 6-20 characters including characters and numbers.
8. Tap "Done".

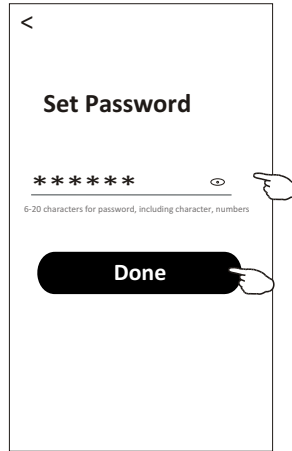
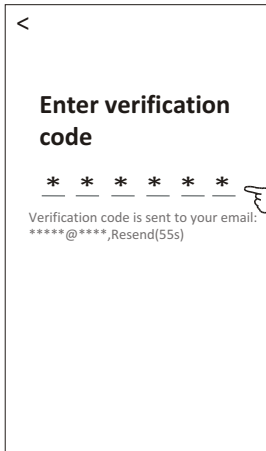

# Login

1. Tap "Log in with existing account".
2. Enter your registered account and password.
3. Tap "Log in" button.

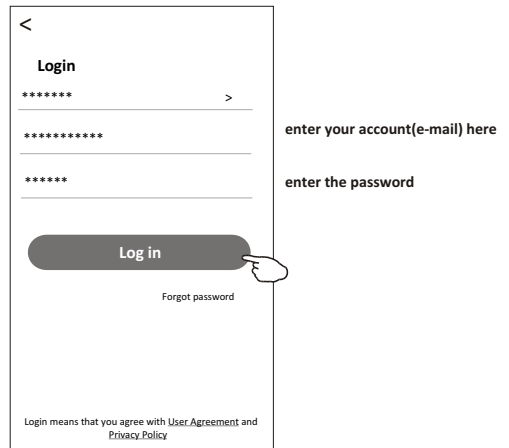
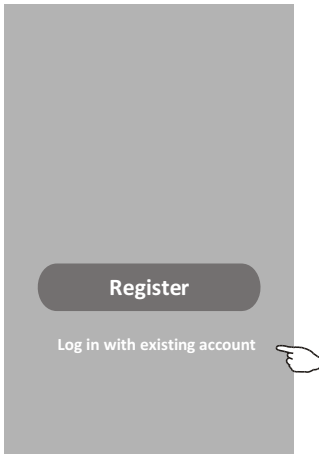

# Login

## The first time the APP is used, Create family is needed:

4. Tap "Create family".
5. Make name for the family.
6. Set the location.
7. Choose default rooms or add new rooms.
8. Tap "Done" and "Completed".

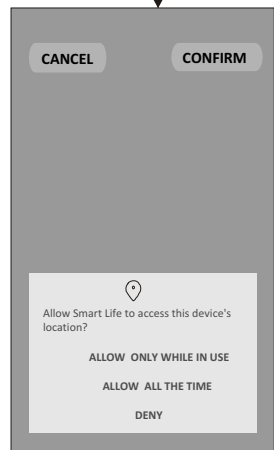
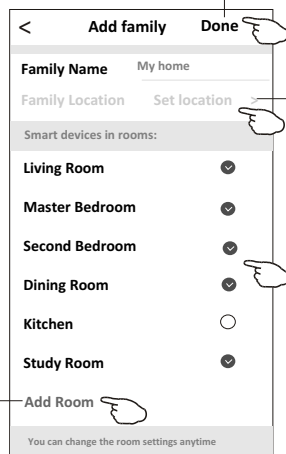
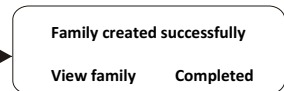
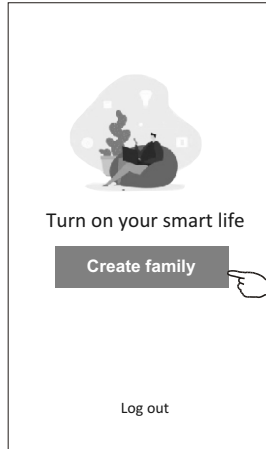

choose the recommended room or make a new room, then tap Done.

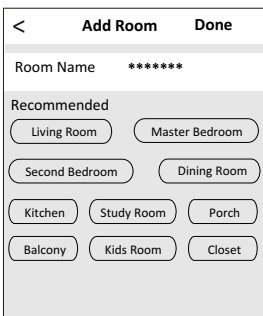

**Note:**  
The app can open the map on your phone and you can set the location where you are.

# Login

## Forgot the password

If you forgot the password or you want to reset the password, operate as below:

1. Tap "Forgot password".
2. Enter your account(e-mail address) and tap button "Obtain verification code".
3. Enter the verification code received by your e-mail.
4. Set the new password and tap button "Done".

<

**Login**

\*\*\*\*\* >

Email address

Password

Log in

Forgot password

Login means that you agree with [User Agreement](#) and [Privacy Policy](#)

<

**Forgot password**

\*\*\*\*\* >

\*\*\*\*\* X

Obtain verification code

<

**Enter verification code**

\* \* \* \* \*

Verification code is sent to your email:  
\*\*\*\*\* ,Resend(55s)

<

**Set Password**

\*\*\*\*\*

6-20 characters for password, including character, numbers

Done

# Add device

There are 2 modes CF(Quick connection) and AP(Access Point) for adding device.

## CF mode

- 1.Power on the indoor unit, no need to launch the air conditioner.
- 2.Click "+" in the upper right corner of the "Home" screen or tap "Add device" on the room which has no device.
- 3.Tap the "Window Type Air conditioner" logo.
- 4.Input the password of the Wi-Fi which the same as your smart phone connected, then tap "Next".
- 5.Choose "CF Mode" on the right corner, then follow the instruction on page before or screen to reset the Wi-Fi module, then tap "Next".
- 6.You can see the percent rate of connecting process, at the same time "PP", "SA", "AP" shining in turn on the indoor display.  
"PP" means "Searching the router"  
"SA" means "connected to the router"  
"AP" means "connected to the server"

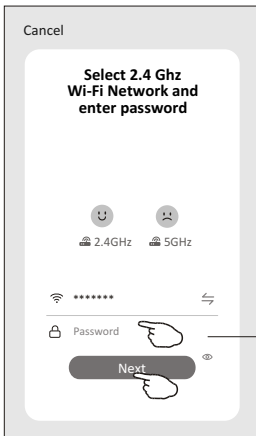
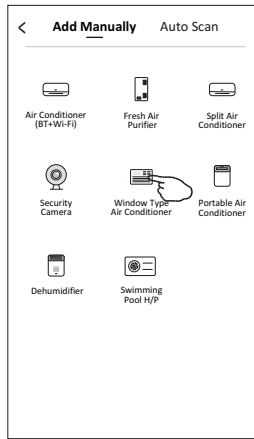
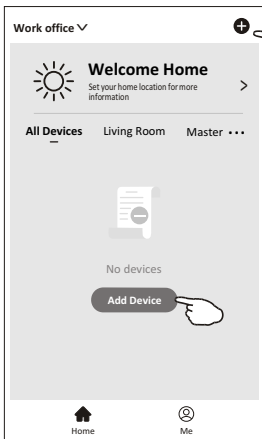

enter password

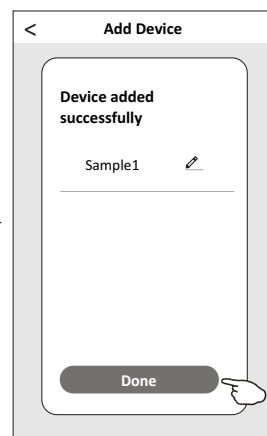
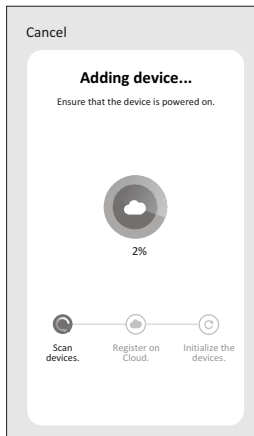

# Add device

There are 2 methods to add the device.

## 2-AP mode

1. Power on the indoor unit, no need to launch the air conditioner.
2. Click "+" in the upper right corner of the "Home" screen or tap "Add device" on the room which has no device.
3. Tap the "Window Type Air Conditioner" logo.
4. Input the password of the Wi-Fi which the same as your smart phone connected, then tap "Next".
5. Choose "AP Mode" on the right corner, then follow the instruction on page before or screen to reset the Wi-Fi module, then tap "Next".
6. Read the instruction carefully and tap "Connect now".
7. In the network setting screen, select "SmartLife-\*\*\*\*", and tap "<".
8. You can see the percent rate of connecting process, at the same time

"PP" means "Searching the router"

"SA" means "connected to the router"

"AP" means "connected to the server"

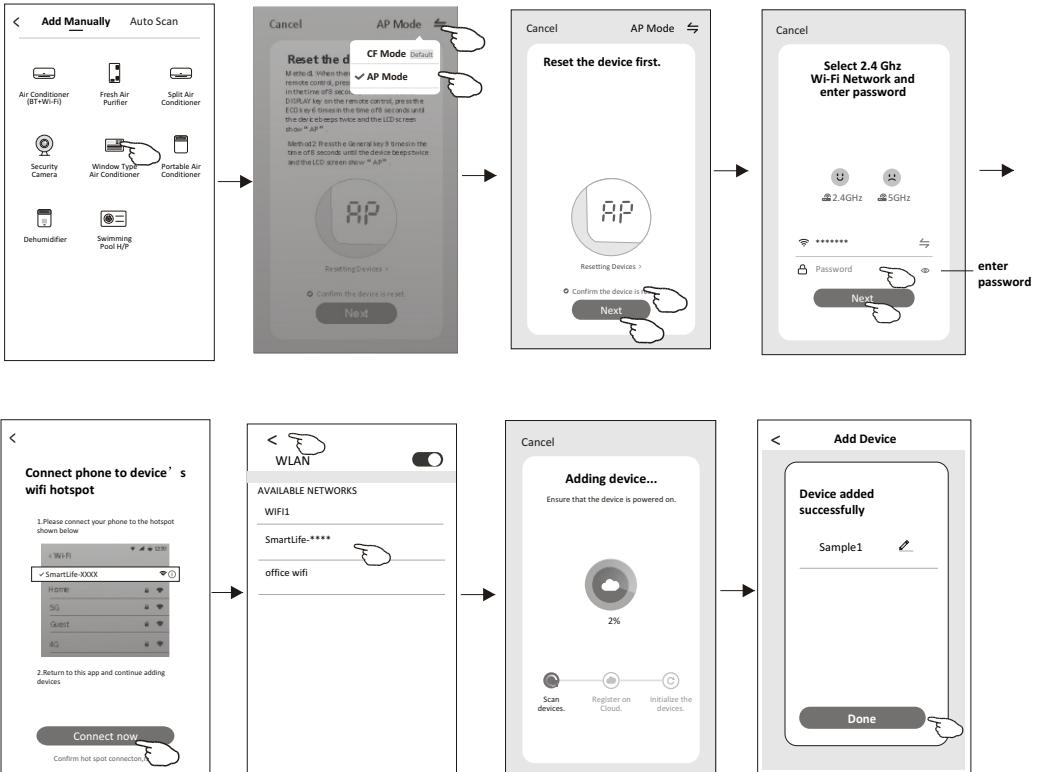
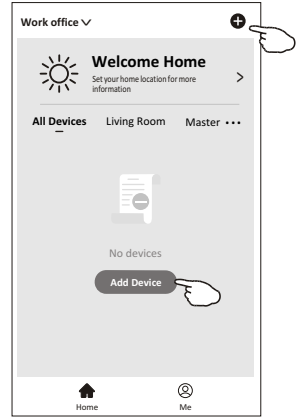

# Air conditioner control

The device control screen will pop up automatically after adding the device.

The device control screen will pop up manually by tapping the device name on the home screen.

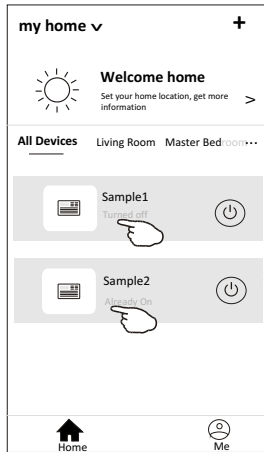

*Note:*

*There are two different control forms base on different software or Wi-Fi module firmware. Please read the manual carefully base on the real control interface.*

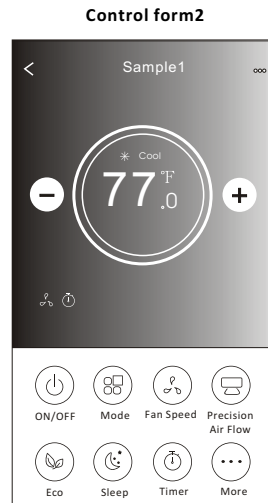
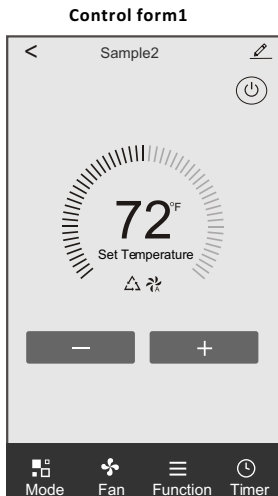

# Air conditioner control

## Control form1

### The main control interface

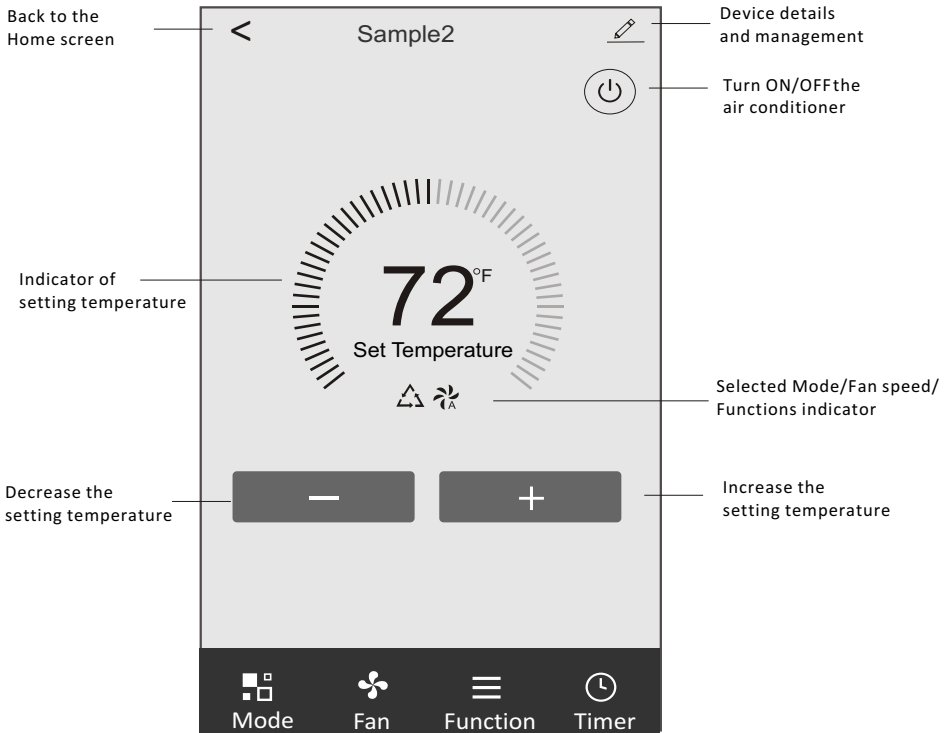

# Air conditioner control

## Control form1-Mode setting

1. Tap Mode to pop up the Mode screen.
2. Select one of the mode Feel/Cool/Heat/Dry/Fan.
3. Tap anywhere around the setting temperature to cancel the Mode setting.

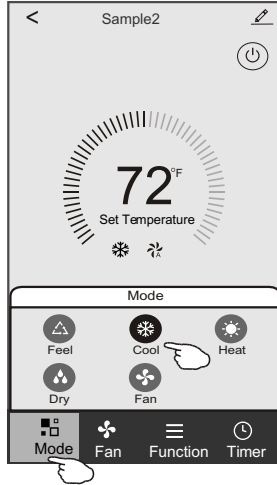

## Control form1-Select fan speed

1. Tap Fan to pop up the Fan screen.
2. Select one of the fan speed High/med/Low/Auto.
3. Tap anywhere around the setting temperature to cancel the selection.

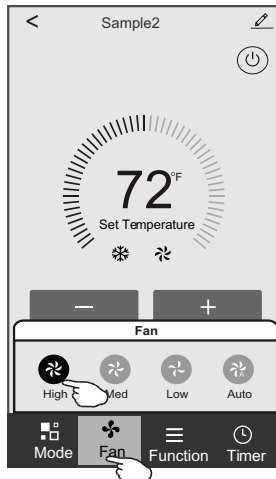

# Air conditioner control

## Control form1-Function setting

1. Tap Function to pop up the Function screen.
2. Select one of the functions Sleep/Turbo/ECO.
3. Select UP-DOWN/LEFT-RIGHT for auto swing with direction of UP-DOWN/LEFT-RIGHT.
4. Tap anywhere around the setting temperature to cancel the Function setting.



## Control form1-Timer adding

1. Tap Timer to pop up the Add Timer screen.
2. Tap Add Timer.

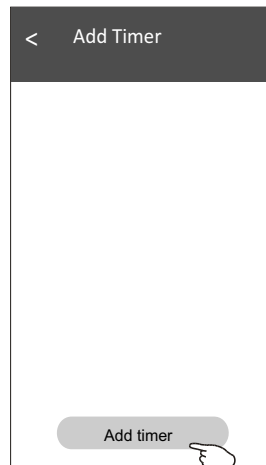
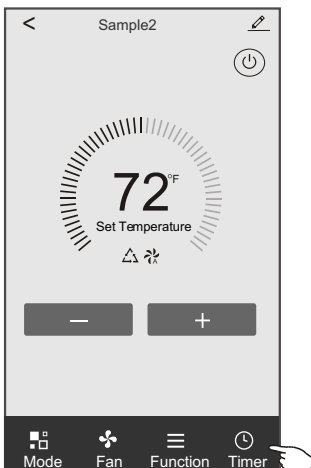

# Air conditioner control

## Control form1-Timer adding

3. Select the time, select the repeat days and Timer on/off.
4. Select the Mode/Fan speed/Function and select the setting temperature for Timer on.
5. Tap Save to add the timer.

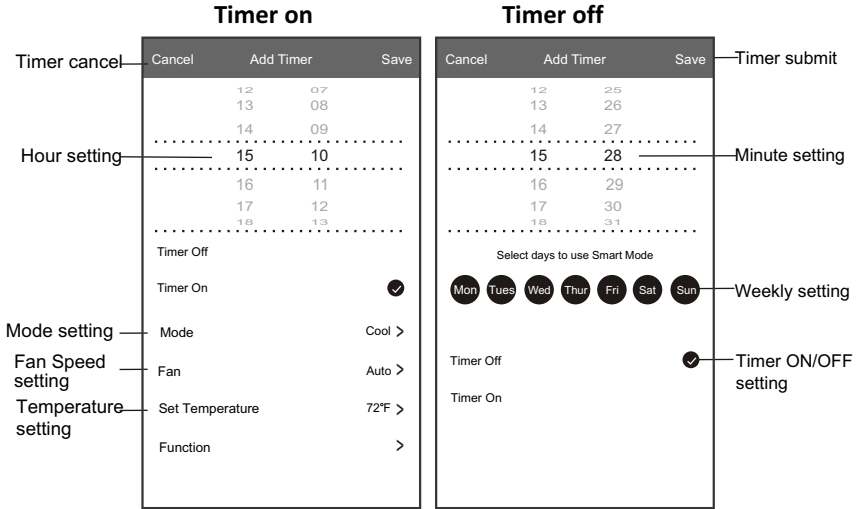

## Control form1-Timer Management

1. Tap the bar of timer to edit the Timer like the Timer adding process.
2. Click the switch to enable or disable the Timer.
3. Holdind the bar of Timer about 3seconds and pop up the Remove Timer screen, tap CONFIRM and remove the Timer.

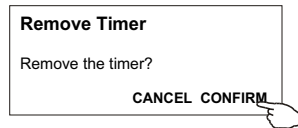
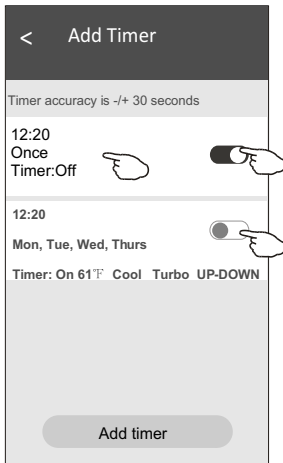

# Air conditioner control

## Control form2

### The main control interface

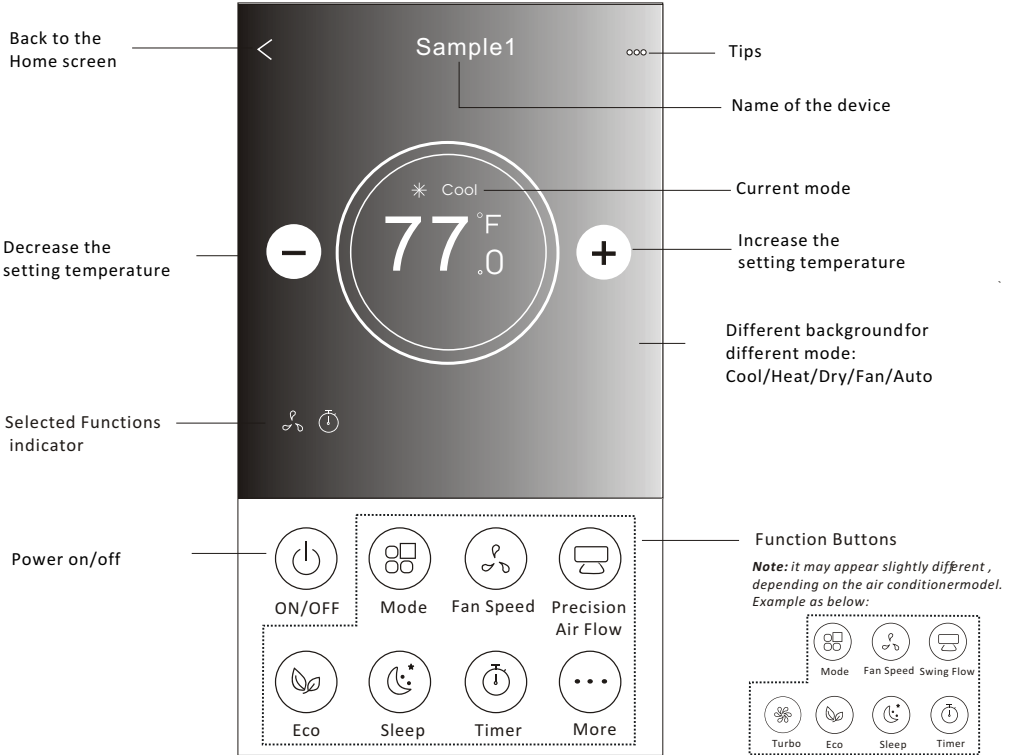

# Air conditioner control

## Control form2-Mode setting

1. Tap the Mode button.
2. There are 5 modes on the Mode screen, tap one button to set the Air conditioner working mode.
3. Tap the X button to back the main control screen.
4. The mode and background will change on the screen.

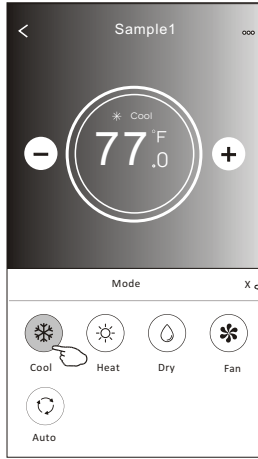
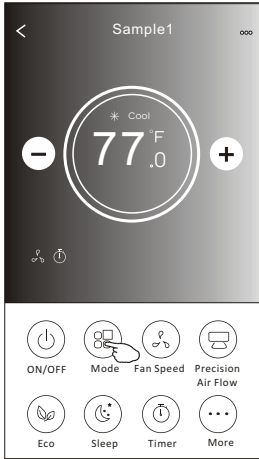

**Note:** please read the details of each mode in the user manual to control more comfortable.

## Control form2-Fan speed selection

1. Tap the Fan speed button.
2. Choose your desired fan speed and tap it.
3. Tap the X button to back the main control screen.
4. The selected fan speed indicator will appear on the screen.

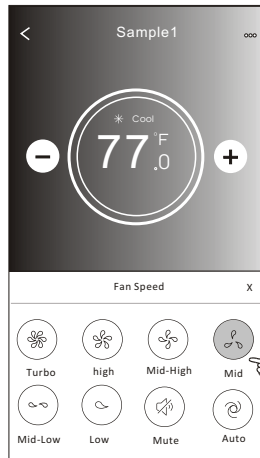
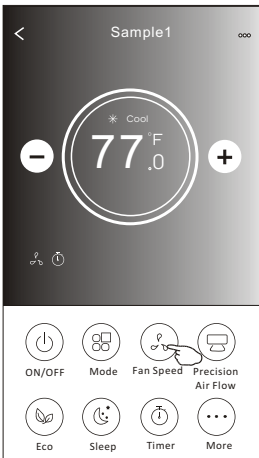

Mode	Fan Speed
Cool	All speeds
Fan	All speeds
Dry	
Heat	All speeds
Auto	All speeds

**Note:** Fan Speed can't be adjusted on Dry mode .

**Note:** Fan Speed screen may appear slightly different, depending on the air conditioner model. Example as below:

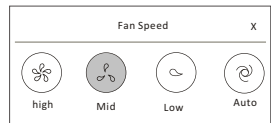

# Air conditioner control

## Control form2-Air Flow control

1. Tap the Precision Air Flow button or Swing Flow button.
2. Choose your desired air flow and tap it.
3. Tap the X button to back to the main control screen.
4. The selected air flow indicator will appear on the screen.

**Note:** For some models without auto Left-Right wind, If you active it, you will hear a beep, but no any actions.

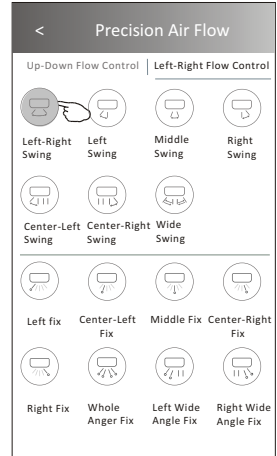
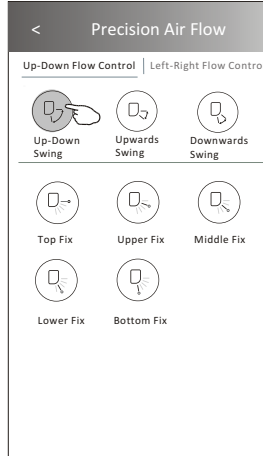
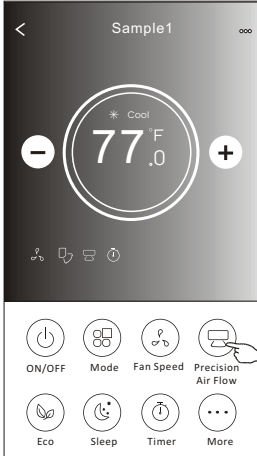

**Note:** The Main controlscreen and Air Flowscreen may appear slightlydifferent , depending on the airconditioner model.Example asbelow:

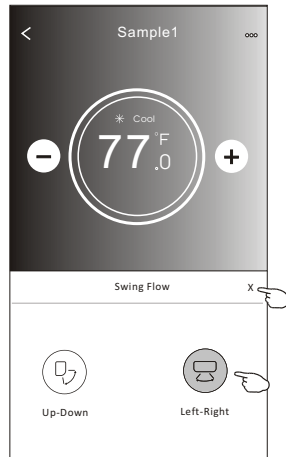
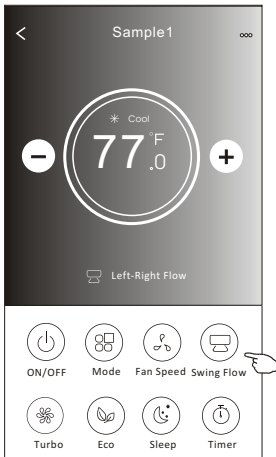

# Air conditioner control

## Control form2-ECO function

1. For Eco function, just tap the button to activate the function, the button will be lighting and the indicator will appear on the screen.
2. Tap again to disable the function.
3. Temperature controlled for some air conditioner model:
  - In Cooling mode, the new setting temperature will  $\geq 78^{\circ}\text{F}$ .
  - In heating mode, the new setting temperature will  $\leq 77^{\circ}\text{F}$ .

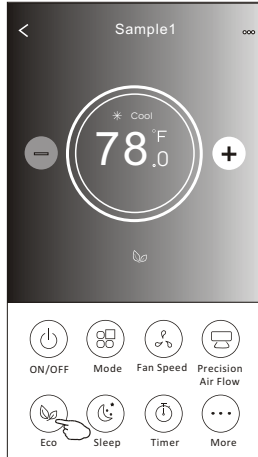
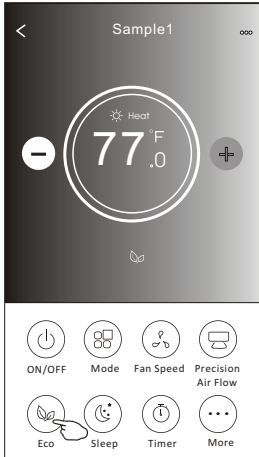

Mode	ECO enabled
Cool	Yes
Fan	
Dry	
Heat	Yes
Auto	

ECO is disabled on Fan/ Dry/Auto mode .

**Note:** The Main controlscreen and ECOcontrol method may appear slightly different, depending on the air conditioner model. Example as below:

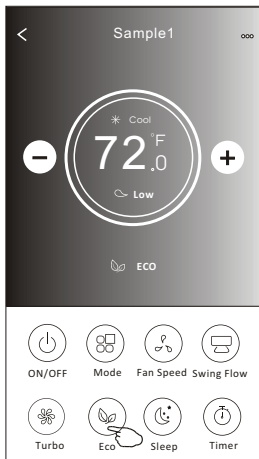

**Note:**  
ECO is disabled on Turbo/Sleep mode too for some air conditioner model.

# Air conditioner control

## Control form2-Sleep function

1. Tap the Sleep button.
2. Choose your desired sleep mode and tap it.
3. Tap the X button to back to the main control screen.
4. The selected sleep mode indicator will appear on the screen.

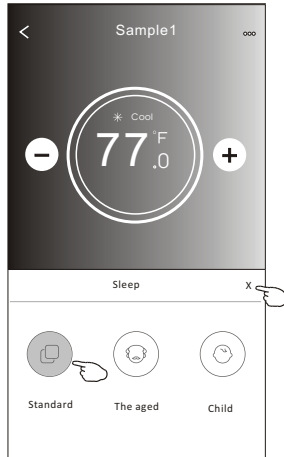
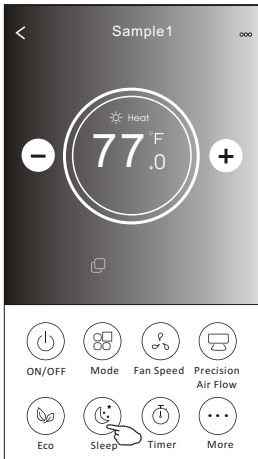

Mode	Sleep enabled
Cool	Yes
Fan	
Dry	
Heat	Yes
Auto	

Sleep is disabled on Fan/ Dry/Auto mode .

### Note:

The Main controlscreen may appear slightly different ,depending on the air conditioner model.  
Example as below:

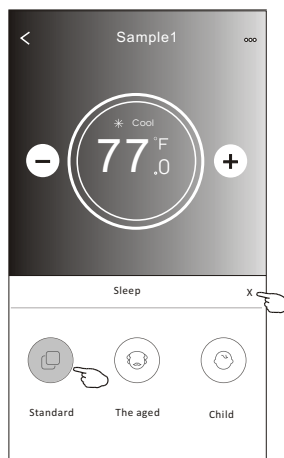
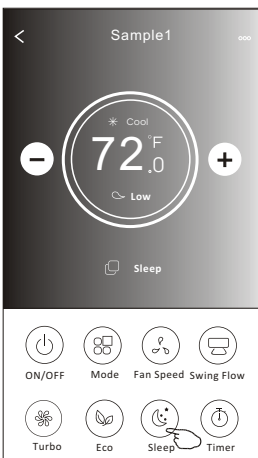

### Note:

Sleep is disabled on Turbo/Sleep mode too  
for some air conditioner model..

# Air conditioner control

## Control form2-Timer(on) setting

1. Tap the Timer button.
2. Tap + in the upper right corner of the Timer main screen.
3. Choose the Time/Repeat/Switch OFF then tap Save.
4. The timer(off) will appear on the Timer main screen.

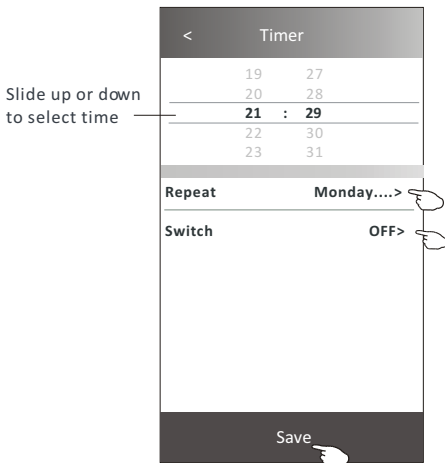
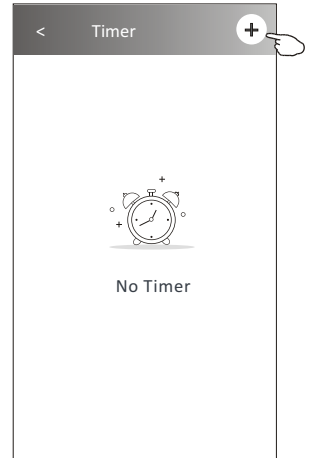
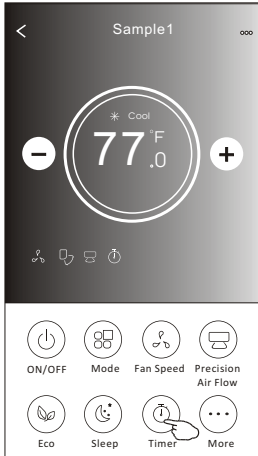

Tap repeat> then tap your desired repeat days or Once, then tap Confirm your selection.

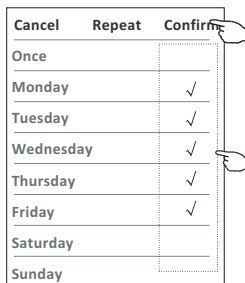

Tap Switch> then slide the screen to choose ON and Confirm.

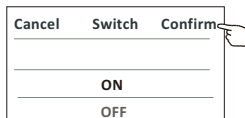

# Air conditioner control

## Control form2-Timer(off) setting

1. Tap the Timer button.
2. Tap + in the upper right corner of the Timer main screen.
3. Set the Time/Repeat Date/Switch(ON)/Temperature/Mode/  
Fan speed/Air Flow as your desired and then tap Save.
4. The timer will appear on the Timer main screen.

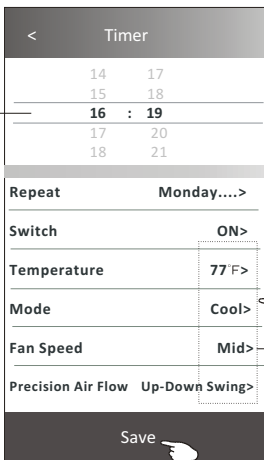
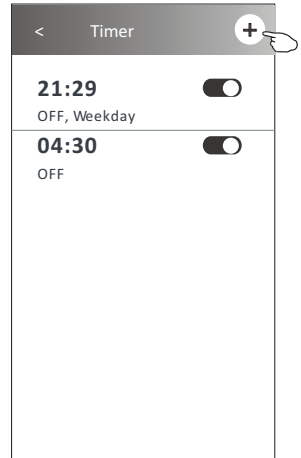
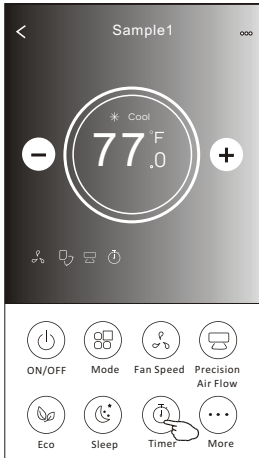

Slide up or down to select time

Tap repeat> then tap your desired repeat days or Once, then tap Confirm your selection.

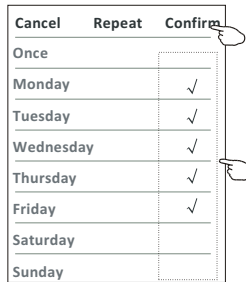

Tap Switch> then slide the screen to choose ON and Confirm.

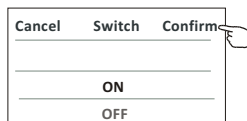

Tap Temperature/Mode/Fan Speed/ Air Flow > one by one then set as your desired as mentioned on the previous chapter and tap Confirm the setting.

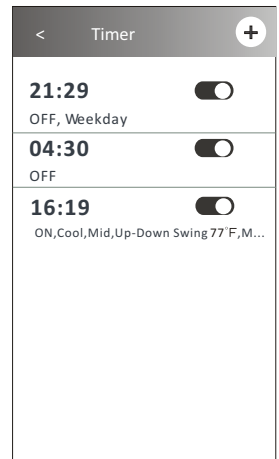

# Air conditioner control

## Control form2-Timer management

### 1.Change the Timer setting:

Tap anywhere of the timer list bar except the switch bar to get into the Timer setting screen, change the setting and then tap save.

### 2.Enable or Disable the Timer:

Tap the left of the switch to disable the Timer.  
Tap the right of the switch to enable the Timer.

### 3.Delete the Timer:

Slide the list bar of the Timer from right to left until Delete button appear, then tap delete.

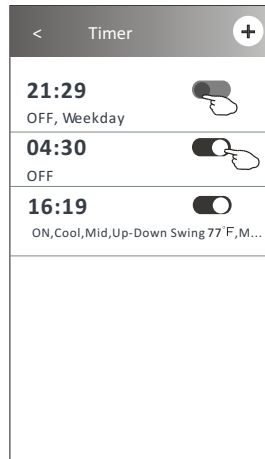
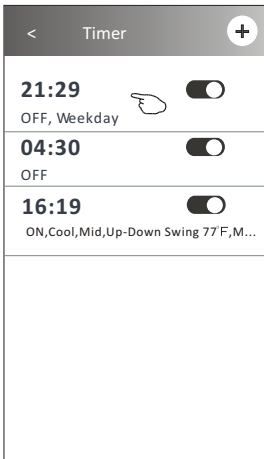

Slid left to disable the Timer.

Slid right to enable the Timer.

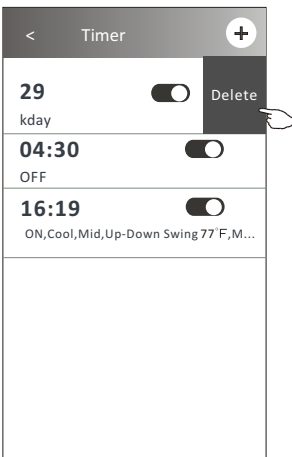

# Air conditioner control

## Control form2-More functions

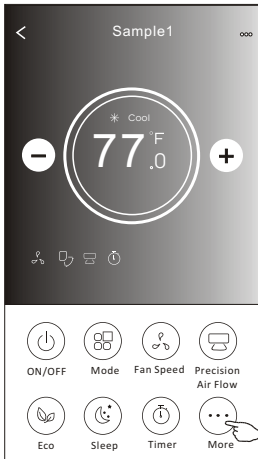

1. Tap the More button to operate additional functions if it appears on the screen.

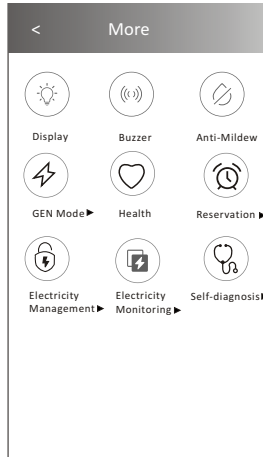

**Note:**  
Some air conditioner model don't have the more button.



**Note:** The appearance maybe different , some icons will be hidden if the air conditional do no have this function or do not enable on the current mode.

2. Tap the "  " to switch on/off the indoor LED display.  
Display
3. Tap the "  " to switch on/off the buzzing if it is available on the screen.  
Buzzer
4. Tap the "  " button to activate the Anti-Mildew function, if it is available on the screen.  
Anti-Mildew

After AC turning off , it will start drying , reduce residual moisture and prevent mould, after function finish, it will automatically turn off.

5. Tap the "  " to switch on/off the healthy function, if it is available on the screen.  
Health  
It activate the antibacterial ioniser function.This function only for models with the ioniser generator.
6. Tap the "GEN Mode" button, if it is available on the screen.  
In this Mode, you can choose one of the three levels of current.  
The air conditioner will maintain proper current to save energy.

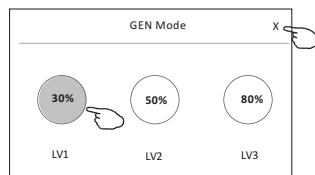
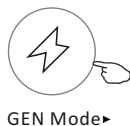

# Air conditioner control

## Control form2-More functions

7. Tap the "Electricity Monitoring" button if it is available on the screen.

In this function, you can monitor the air conditioner electricity consumption.



Electricity Monitoring ▶

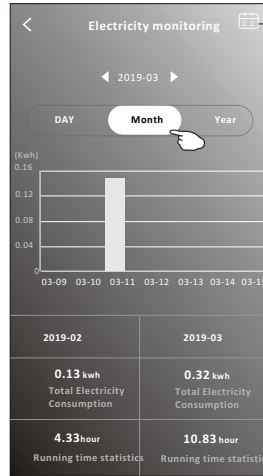
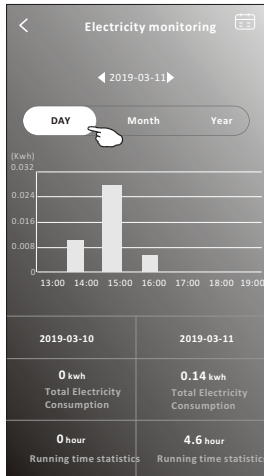

You can tap this button to pop up the calendar then select the date.

8. Tap the "Self-Cleaning" button, if it is available on the screen.



Self-Cleaning

Check the details of the Self-Cleaning function on User Manual.

9. Tap the "8°C Heat" button, if it is available on the screen.

This function help keep the room temperature over 8°C.

Check the details of the 8°C Heat function on User Manual.



8°C Heat

10. Tap the "Reservation" button, if it is available on the screen.

You can set the time, repeat day, temperature, mode, fan speed, air flow as you desired and then tap Save to activate the function.

The air conditioner will automatically reach your settings at the appointment time.



Reservation ▶

Reservation	
14	17
15	18
<b>16</b>	<b>19</b>
17	20
18	21

Repeat setting	Monday... >
Temperature	77°F >
Mode	Cool >
Fan Speed	Mid >
Precision Air Flow	Up-Down Swing >

Save

Reservation

**16:19:00**

ON, Cool, Mid, Up-Down Swing 77 F, M...

After the reservation is set up, the air conditioner will automatically reach your set requirement at your appointment time.

# Air conditioner control

## Control form2-More functions

11. Tap the "Self-diagnosis" button, if it is available on the screen.

The air conditioner will automatically diagnosis itself and indicate the Error code and the problem instructions if possible.

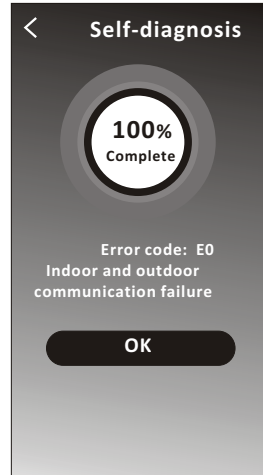
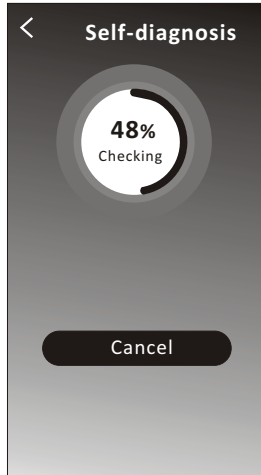

12. Tap the "  " button if it is available on the screen.

This function allow the air conditioner to turn on/off the display automatically according to the light intensity.

13. Tap the "  " button if it is available on the screen.

In this function, the air conditioner will blow soft airflow through the micro holes on the deflector.

# Air conditioner control

## Device details and management

Tap  on control form1 or tap ... on control form2 , get into the device details screen. Here you can get some useful information and sharing the device to other accounts. Check the following pictures and instructions carefully.

Control form1

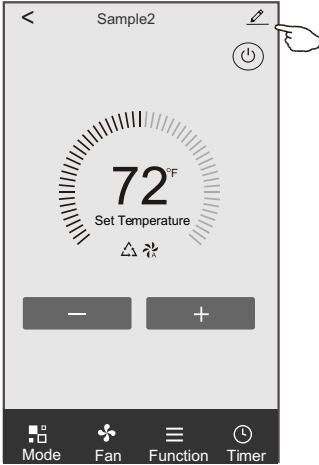

Control form2

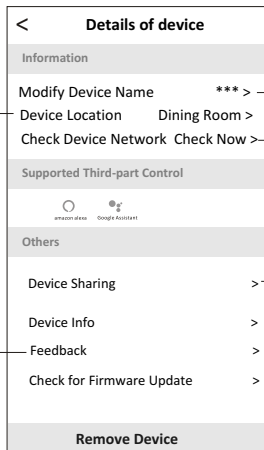
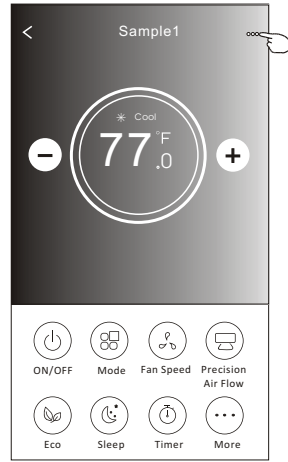

Tap to change the device location to another room

Feed back the problems or some suggestions to the APP administrator.

Tap to check the network status

Tap to check the network status

Tap to got the instruction for connecting the amazon alexa or Google Assistant voice controller

Tap to sharing the device to other account

Tap to check the Virtual ID/Wi-Fi name/IP address MAC address/Time Zone/Wi-Fi single strength

Check and update the firmware

Tap to remove the device and the device will be reset automatically once be deleted.

# Air conditioner control

## Device details and management

### How to share the devices to other accounts?

1. Tap "Device Sharing" and pop up Device Sharing screen.
2. Tap "Add Sharing".
3. Select the region and enter the account which you want to sharing.
4. Tap "Completed", the account will appear on your sharing list.
5. The received sharing members should hold pressing the home screen and slide down to refresh the device list, the device will appear on the device list.

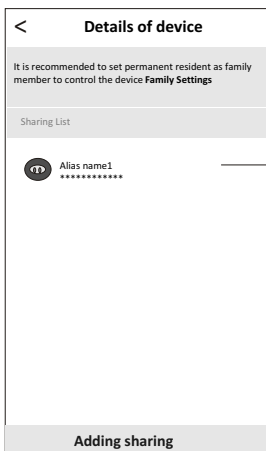
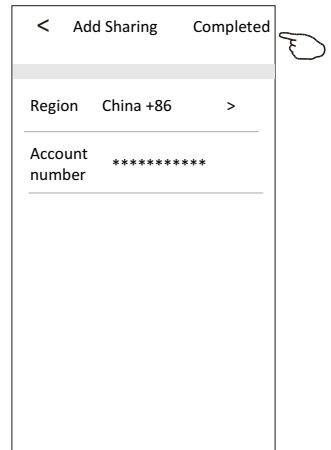
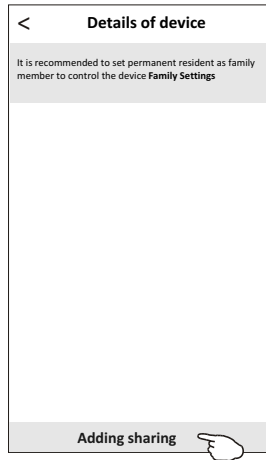
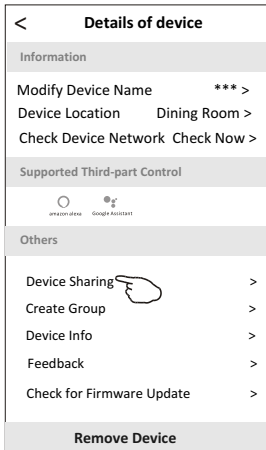

Hold the bar about 3s then you can delete the sharing account.

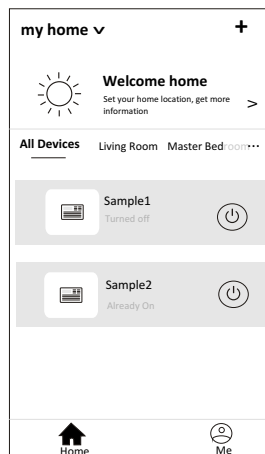

Hold on and slide down to refresh the device list

# Account management

## Account Profile setting

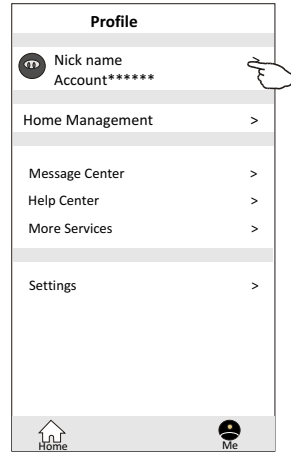
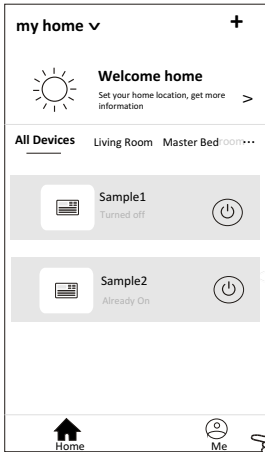

Change the nick name of your account

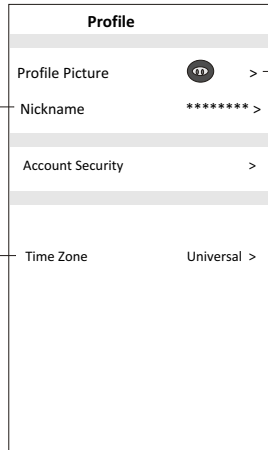
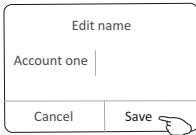

Select the time zone

Select a picture for the account from local album

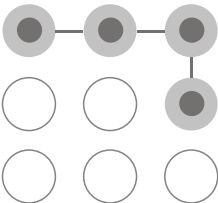

Set a pattern password for launching the APP

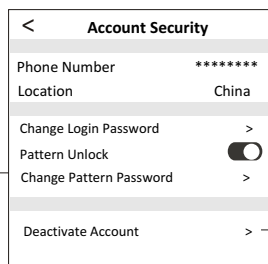

Change the password like reset password on page7

Tap the switch to enable or disable the Pattern password

Please carefully to deactivate the account for all data will be deleted.

# Account management

## Home(Family) management

1. Tap the name of home at the left upper corner of the Home Screen and select the Home Management.  
Or tap Me and tap Home Management.
2. Tap one of the families in the family list and get into Family Settings screen.

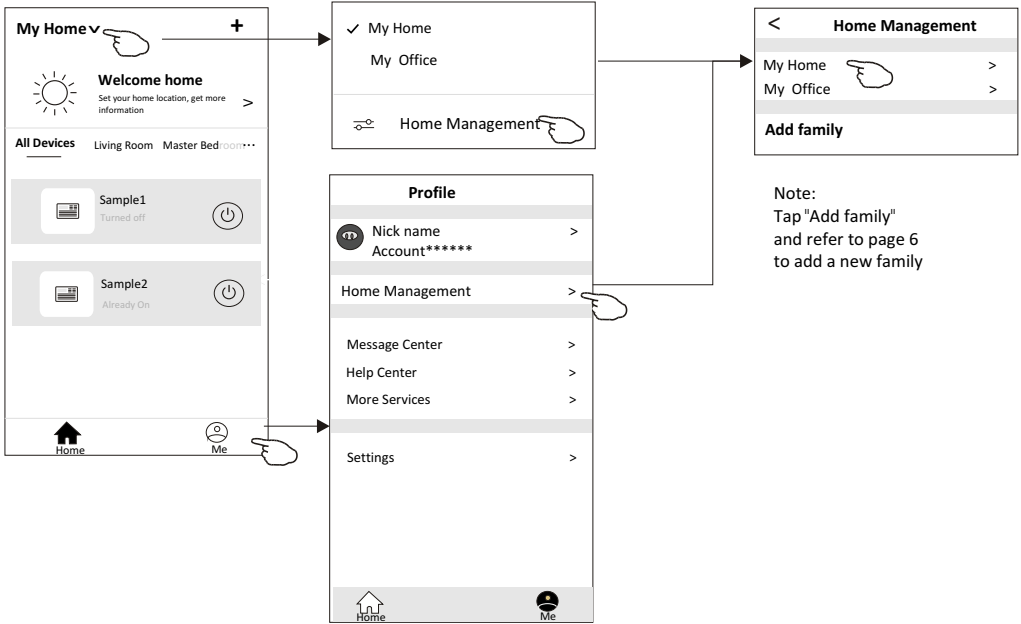

3. Set the family as the following indicators.

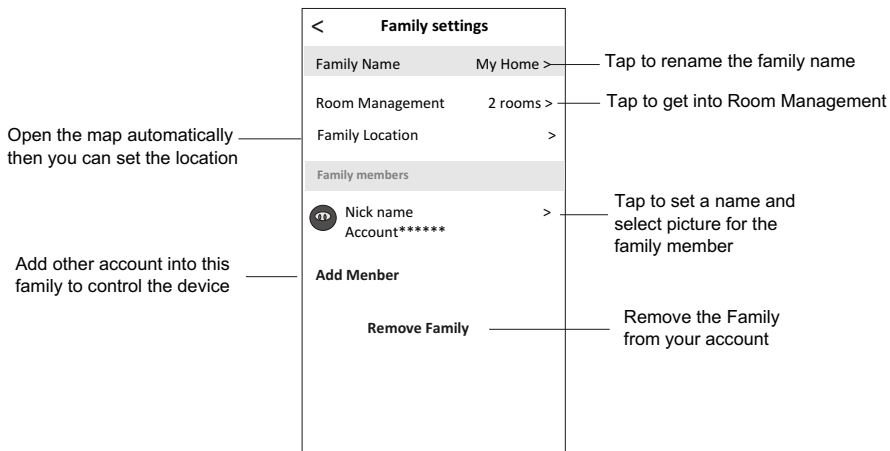

# Notice

1. For technical update, there is maybe deviation of the actual items from what is on the manual. We express our apologies. Please refer to your actual product and APP.
2. Smart air conditioner APP can be altered without notice for quality improvement and also be deleted depending on the circumstances of manufacturing firms .
3. In case Wi-Fi signal strength is weakened, smart App may be disconnected. So make sure the indoor unit near to wireless router.
4. DHCP server function should be activated for wireless router.
5. The internet connection may fail because of a firewall problem. In this case, contact your internet service provider.
6. For smart phone system security and network setting, make sure Smart air conditioner APP is trusted.

# Trouble Shooting

Description	Analysis of cause
<b>Air conditioner can't be configured successfully</b>	<ol style="list-style-type: none"> <li>1. Check the mobile connected WLAN router SSID and password is correct;</li> <li>2. Check whether there are additional settings of WLAN router as shown below.               <ol style="list-style-type: none"> <li>1) Firewall by router itself or by PC</li> <li>2) MAC address filtering</li> <li>3) Hidden SSID</li> <li>4) DHCP server</li> </ol> </li> </ol> <p>Reboot WLAN router, mobile device and air conditioner (WLAN module) and connect air conditioner by CF mode again. Before rebooting, check nobody has already connected to same air conditioner.</p>
<b>Mobile can't control air conditioner</b>	<ol style="list-style-type: none"> <li>1. When air conditioner (WLAN module) is rebooted and app displays Device remove, ignoring this confirmation will lead to mobile device losing control permission of the air conditioner. You will need to connect the air conditioner by CF mode again.</li> <li>2. In case of power failure, mobile device will lose control permission of air conditioner for 3 minutes after power failure. (Notification will now show up on the mobile device.) If you cannot control the app (air conditioner) even after power restored, you will need to connect the air conditioner by CF mode again.</li> </ol>
<b>Mobile can't find air conditioner</b>	<ol style="list-style-type: none"> <li>1. App display Air conditioner Device offline. Please check the following conditions.               <ol style="list-style-type: none"> <li>1)The air conditioner has been reconfigured.</li> <li>2)Air conditioner out of power.</li> <li>3)Router out of power.</li> <li>4)Air conditioner can't connect to router.</li> <li>5)Air conditioner can't connect to network through the router.</li> <li>6)Mobile device can't connect to network.</li> </ol> </li> <li>2. After adding the device, it disappears in device list . Hold and slide down to refresh the device list. If it has no change, shut down the app and start again.</li> </ol>



