

TRACVISION[®]

BY KVH INDUSTRIES

TracVision[®] M1DX with Multi-service Interface Box/Controller



TracVision[®] M1DX User's Guide

TracVision M1DX

Multi-service Interface Box/ Controller Configuration

User's Guide

This user's guide provides all of the basic information you need to operate, set up, and troubleshoot the TracVision M1DX satellite TV antenna system. For detailed installation information, please refer to the *TracVision M1DX Installation Guide*.



Please direct questions, comments, or suggestions to:

KVH Industries, Inc.
50 Enterprise Center
Middletown, RI 02842-5279 USA
Tel: +1 401 847-3327
Fax: +1 401 849-0045
E-mail: info@kvh.com
Internet: www.kvh.com

If you have any comments regarding this manual, please e-mail them to manuals@kvh.com. Your input is greatly appreciated!



KVH Part # 54-0580 Rev. C
© 2008-2011, KVH Industries, Inc., All rights reserved.
U.S. Patents Pending



Trademark Information

TracVision, KVH, and the unique light-colored dome with dark contrasting baseplate are registered trademarks of KVH Industries, Inc.

DVB (Digital Video Broadcasting) is a registered trademark of the DVB Project.

DIRECTV is an official trademark of DIRECTV, Inc.

DISH Network is an official trademark of EchoStar Communications Corporation.

All other trademarks are the property of their respective owners.

Disclaimer

Every effort has been made to ensure the correctness and completeness of the material in this document. No company shall be liable for errors contained herein. The information in this document is subject to change without notice. No warranty of any kind is made with regard to this material, including, but not limited to, the implied warranties of merchantability and fitness for a particular purpose.



Table of Contents

1	Introduction	
	Using this Manual	3
	System Overview	5
2	Operation	
	Receiving Satellite TV Signals	11
	Turning the System On/Off	12
	Understanding the Status Screen	13
	Switching Satellites	14
	Changing the Satellite Switching Mode	16
	Product Care	17
3	System Preferences	
	Adjusting the Display Brightness	21
	Entering Latitude/Longitude	22
4	Setup	
	DISH Network Setup	25
	DIRECTV Setup	30
	Manual Mode Setup	32
	Resetting the System to Change Setup	33

5	Troubleshooting	
	Five Simple Checks.....	37
	System Status Lights.....	38
	Error Messages.....	40
	Running the Diagnostics Test.....	41
	Viewing System Information.....	43
	Calibrating the Gyros.....	45
	Changing Tracking Parameters.....	46
	Technical Support.....	48
A	Wiring Diagrams	
	Wiring Diagram - 1 Receiver.....	51
	Wiring Diagram - 2 Receivers.....	52
	Wiring Diagram - 3 Receivers.....	53
B	Menus Quick Reference Guide	
	Interface Box Menus.....	57



1. Introduction

This chapter provides a basic overview of this manual and your TracVision system.

Contents

Using this Manual	3
System Overview	5





Using this Manual

This manual provides complete operation, setup, and troubleshooting information for your TracVision system.

Who Should Use This Manual

The **user** should refer to the “Operation” and “System Preferences” chapters to learn how to operate the system.

The **user, installer, or servicing technician** should refer to the “Setup” chapter for information on configuring the system for the desired satellite TV service and satellites. The **user, installer, or servicing technician** should also refer to the “Wiring Diagrams” appendix for information on connecting additional receivers.

The **user** and/or **servicing technician/installer** should refer to the “Troubleshooting” chapter to help identify the cause of a system problem.

Flowchart Conventions

When instructions indicate to select a specific menu option, press the corresponding interface box button located below the display (see Figure 1).

Figure 1 Example of Menu Option and Corresponding Interface Box Button

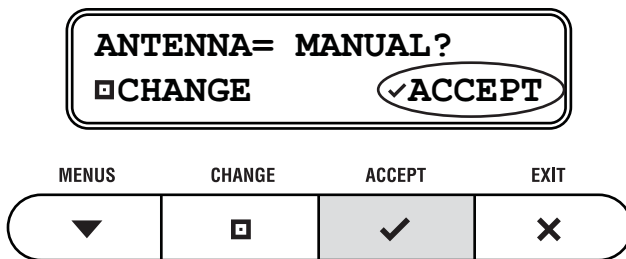

Typographical Conventions

This manual uses the following typographical conventions:

Text Example	Description
SELECT SATELLITES	Text as it appears on the interface box display; also denotes receiver remote control buttons
See “ System Overview ” on page 5.	Cross-reference to another chapter in the manual or to a website

Types of Notices

This manual uses the following types of notices to call attention to important or related information:

IMPORTANT!

Be sure to read these carefully to ensure proper operation and configuration of your TracVision system.

NOTE: Notes contain useful information about system settings.

TIP: Tips contain helpful information, allowing you to get the most out of your TracVision system.

Related Documentation

In addition to this User's Guide, the following documents are provided with your TracVision system:

Document	Description
Installation Guide	Complete installation instructions
Product Registration Form	Details on registering the product
Warranty Statement	Warranty terms and conditions
Contents List	List of every part supplied in the kit

System Overview

Your TracVision M1DX is a state-of-the-art, actively stabilized antenna system that delivers live satellite TV to your mobile audio/video entertainment system. A basic system is illustrated below. Detailed wiring diagrams are provided in [“Wiring Diagrams”](#) on page 49.

Figure 2 TracVision M1DX Basic System Diagram

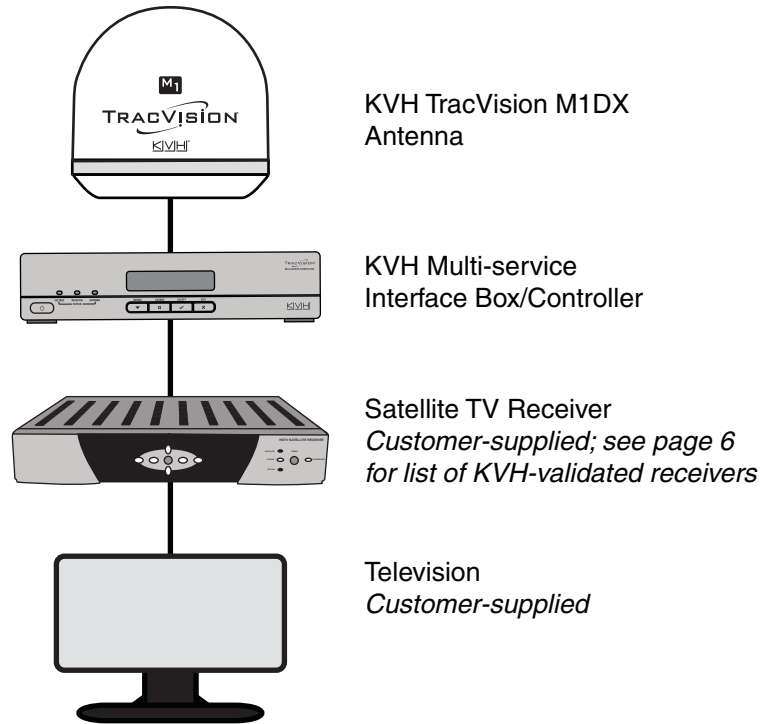

System Components

The TracVision M1DX system includes the following components:

The **antenna** uses integrated DVB technology to quickly acquire and track the correct satellite, switch between satellites, and send TV signals to the interface box. Internal gyros allow the antenna to track the satellite at all times, even while you're on the move!



The **multi-service interface box/controller** supplies power to the antenna and delivers satellite TV signals to your satellite TV receiver. The interface box also allows you to set up the system using the pushbuttons and LCD display.



NOTE: Henceforward, this manual uses the term “interface box” to refer to the multi-service interface box/controller.

Compatible Receivers

To ensure compatibility with the TracVision system, KVH recommends the receiver models shown in the table below. These receivers have all been validated by KVH to work well with the TracVision system. *For information on connecting different receiver models, contact KVH Technical Support at 401-847-3327.*

Figure 3 KVH-Validated Receivers

Standard-Definition Models	
DIRECTV	DISH Network
D12	311
D11	211k
D10	211
High-Definition (HD) Models	
DIRECTV	DISH Network
HD not supported	211k 211



DISH Network Configuration

Other than a satellite TV receiver, no additional components are necessary to receive both high-definition (HD) and standard-definition programming from three DISH Network satellites: 119, 110, and either 61 or 129 (choose the third satellite for your particular region - see [“DISH Network Setup” on page 25](#)). The antenna will automatically switch between these three satellites as necessary as you change channels using the primary receiver's remote.



DIRECTV Configuration

You can receive DIRECTV programming from the 101 and 119 satellites without any special equipment. All you need is a DIRECTV receiver. The antenna will automatically switch between these two satellites as necessary as you change channels using the primary receiver's remote.





2. Operation

This chapter explains everything you need to know to operate the TracVision system.

Contents

Receiving Satellite TV Signals	11
Turning the System On/Off	12
Understanding the Status Screen.....	13
Switching Satellites.....	14
Changing the Satellite Switching Mode.....	16
Product Care.....	17



Receiving Satellite TV Signals

Television satellites are located in fixed positions above the Earth's equator and beam TV signals down to certain regions of the planet (not worldwide). To receive TV signals from a satellite, you must be located within that satellite's unique coverage area.

TIP: For your convenience, KVH provides links to several websites that offer satellite coverage information. Simply visit our website at www.kvh.com/footprint.

Figure 4 Example of a Satellite Location and Coverage Area



In addition, since TV satellites are located above the equator, the TracVision antenna must have a clear view of the sky to receive satellite TV signals. Anything that stands between the antenna and the satellite can block the signal, resulting in lost reception. Common causes of blockage include trees, buildings, bridges, and onboard equipment. Heavy rain, ice, or snow might also temporarily interrupt satellite signals.

Figure 5 Example of Satellite Blockage

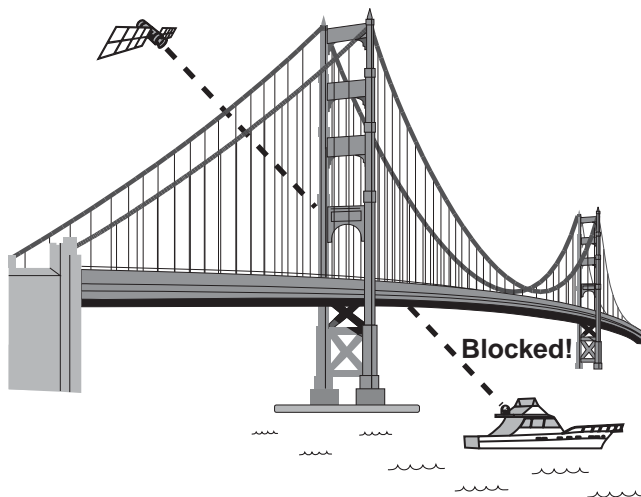

Understanding the Status Screen

Following startup, the interface box displays the current system status.

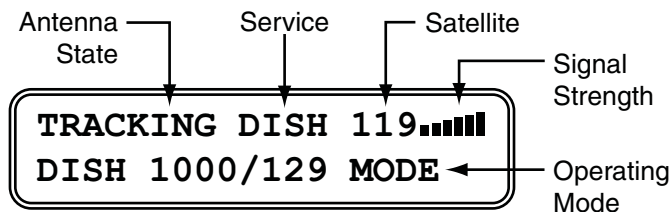
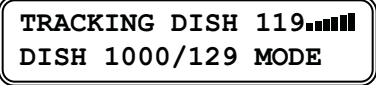

Figure 7 Interface Box Status Screen



Screen Field	Description
Antenna State	Current state of the antenna: <ul style="list-style-type: none"> • Idle • Initializing • Searching • Tracking • Error
Service	Satellite TV service currently set up in the TracVision system: <ul style="list-style-type: none"> • DTV (DIRECTV) • DISH (DISH Network) • MAN (Manual)
Satellite	Satellite that the antenna is currently tracking <i>This number refers to the satellite's "orbital slot," which is its longitudinal location above the equator.</i>
Signal Strength	Strength of the satellite TV signal, as measured by RF level <i>The more bars, the stronger the signal, just like a cell phone. Three bars = good reception.</i>
Operating Mode	Mode of operation currently set up in the TracVision system: <ul style="list-style-type: none"> • Dual-Sat (DIRECTV) • DISH 1000/129 (DISH Network) • DISH 1000/61 (DISH Network) • DISH 500 (DISH Network) <i>For a list of satellites tracked in each operating mode, see "Setup" on page 23.</i>

Switching Satellites

If your system is set up to track multiple satellites, you can easily switch between them. Use the switching method that applies to your particular setup. You can identify the current satellite switching method by the format of the status screen:

Status Screen Examples	Satellite Switching Method
	Automatic
	Manual

Automatic Switching

All operating modes provide automatic satellite switching using the primary receiver (the receiver connected to the “Unstacked Output” jack on the interface box). The antenna will automatically switch satellites as you change channels using the primary receiver’s remote.

NOTE: *The receiver might take up to 30 seconds to display video when changing channels, switching between satellites, and/or switching between standard-definition and high-definition channels.*

NOTE: *DISH Network receivers may switch to a different satellite on their own in response to a blockage condition. For example, if the antenna’s view of the 110 satellite becomes blocked for over a minute, the receiver may try switching to the 119 satellite. If this occurs, you will see an error message on the TV. Once the antenna can see the selected satellite again, the receiver will automatically switch back and the error message will disappear.*

How Switching Satellites Affects Additional Receivers

The TracVision system tracks one satellite at a time. Therefore, if you switch satellites using the primary receiver, televisions connected to other receivers might display different programming, no programming, or an error message. Simply select a channel carried by the new satellite, or use the primary receiver to switch back to the original satellite. Only the primary receiver controls satellite selection.

Manual Switching

If you set up the system to track a custom set of satellites in Manual mode, you can use the interface box to switch among them. Simply press the CHANGE button until the display shows the desired satellite. Then press ACCEPT.

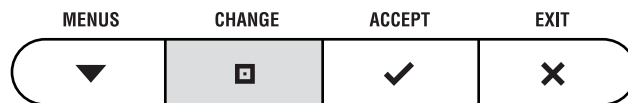

Changing the Satellite Switching Mode

Unless your system is set up in Manual mode, the antenna will automatically switch satellites as you change channels using the receiver's remote control. However, if you want to manually select a satellite for some reason, the interface box allows you to switch from automatic to manual switching. (You can also switch back to automatic switching using this same menu function.)

Follow the steps in the flowchart below to change the satellite switching mode.

Figure 8 Satellite Switching Mode

Press MENUS until
DIAGNOSTICS= No is displayed.

DIAGNOSTICS= NO
▼NEXT MENU CHANGE

DIAGNOSTICS= YES?
CHANGE ACCEPT

ENTERING DIAGNOSTICS

SYSTEM RESET= NO
▼NEXT MENU CHANGE

Press MENUS until
SAT SWITCH= AUTO
is displayed.

SAT SWITCH= AUTO
▼NEXT MENU CHANGE

SAT SWITCH= MANUAL?
CHANGE ACCEPT

SAT SWITCH= MANUAL



Product Care

Please consider the following antenna care guidelines for maintaining peak performance:

- Periodically wash the exterior of the antenna dome with fresh water and mild detergent. Avoid harsh cleansers and volatile solvents (such as acetone) and do not spray the dome directly with high-pressure water.
- If you wish to paint the dome, use only non-metallic automotive paint without a primer coat. Any paint that contains metal will block satellite signals and impair reception.



3. System Preferences

This chapter explains how to change the brightness and latitude/longitude settings.

Contents

Adjusting the Display Brightness.....	21
Entering Latitude/Longitude	22



Adjusting the Display Brightness

Follow the steps in the flowchart below if you need to adjust the brightness of the interface box display.

Figure 9 Brightness Setting

Press **MENUS** until
BRIGHTNESS is displayed.

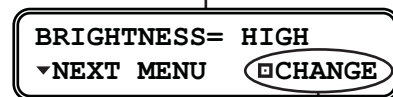

Press **CHANGE** until
the desired setting is
displayed: **HIGH**,
MEDIUM, or **LOW**.

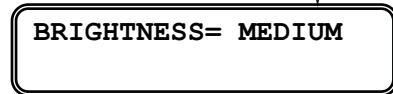
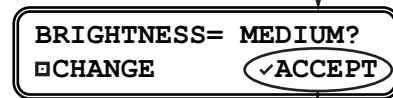

Press **EXIT** to exit the menu.

Entering Latitude/Longitude

Follow the steps in the flowchart below to enter your vessel's latitude and longitude into the system. The antenna will use your position information to speed up satellite acquisition. (If the antenna knows where you are located, it knows where it should start looking for the satellite.)

Figure 10 Latitude/Longitude Setting

Press MENUS until
LAT/LONG is displayed.

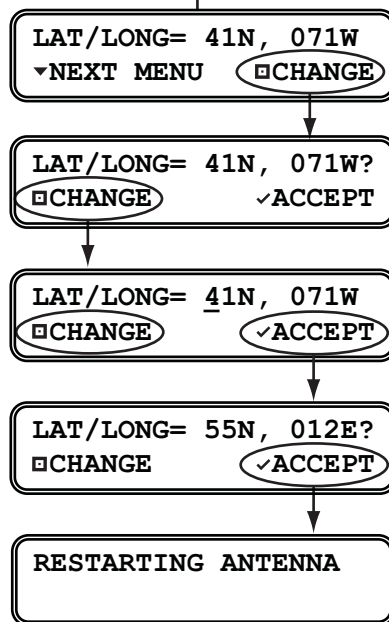

Press CHANGE to set each digit plus N/S (north or south) and E/W (east or west). Press ACCEPT to save each digit.



4. Setup

When you turn on the TracVision system for the first time, the interface box display shows "SYSTEM NEEDS SETUP." This chapter explains how to set up the system for your desired satellite TV service.

Contents

DISH Network Setup	25
DIRECTV Setup.....	30
Manual Mode Setup.....	32
Resetting the System to Change Setup	33



DISH Network Setup

You can set up the system for any one of the following DISH Network operating modes:



Mode	Satellites Tracked
DISH 1000/129	119, 110, and 129
DISH 1000/61	119, 110, and 61
DISH 500	119 and 110

Whichever mode you choose, the antenna will automatically switch between satellites as necessary as you change channels using your primary receiver's remote control.

DISH 1000/129 or DISH 1000/61

To ensure you receive the best satellite reception, use the map in Figure 11 to help determine the appropriate DISH 1000 mode for your geographic area. Check with DISH Network for local channels availability.

Figure 11 Approximate Areas Recommended for DISH 1000 Modes



= DISH 129 Satellite Recommended

= DISH 61 Satellite Recommended

DISH 500

Select this mode if you wish to receive programming from just the 119 and 110 satellites for DISH 500 service.

Setup Process

Once you have chosen an operating mode, perform the steps on the following pages to set up the system for DISH Network service:

1. Set the operating mode in the antenna
2. Run receiver Check Switch tests

Step 1 - Set the Operating Mode in the Antenna

Follow the steps in Figure 12 to set up the antenna for your selected DISH Network operating mode. Then keep the antenna turned on for the next step.

NOTE: If the status screen does not show "SYSTEM NEEDS SETUP," follow the steps in ["Resetting the System to Change Setup"](#) on page 33.

Figure 12 DISH Network Setup

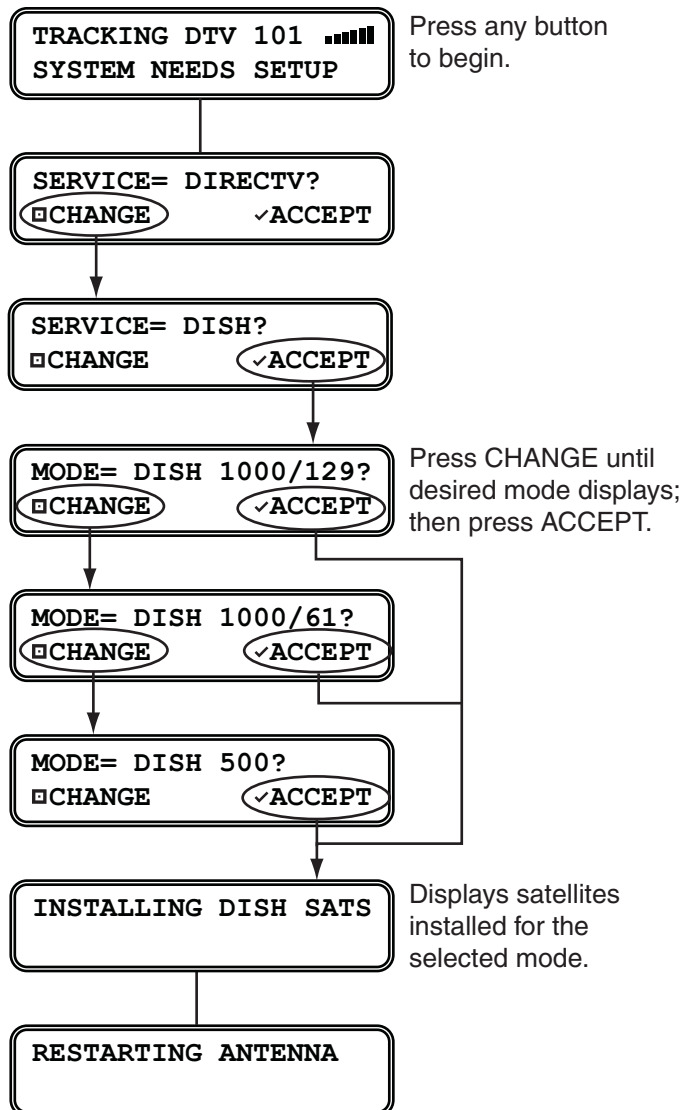

Step 2 - Run Receiver Check Switch Tests

— **IMPORTANT!** —

If your primary receiver was **preconfigured** by KVH for your desired DISH Network satellites, you only need to run **one** Check Switch test to set up the system, not two as described below.

To configure the **primary receiver** for your selected DISH Network mode and automatic satellite switching, you need to run two Check Switch tests on the receiver. The first Check Switch test finds the correct satellites; the second configures the receiver for those satellites. To configure **additional receivers** for your selected mode, you need to run just one Check Switch test on each (see [page 29](#)).

— **IMPORTANT!** —

If you remove a receiver from the vessel and configure it for a home setup, you will need to repeat this step to reconfigure that receiver for a mobile setup whenever you reconnect it to the TracVision system.

Primary Receiver - Run Two Check Switch Tests

Follow these steps to run two Check Switch tests on the primary receiver, which is connected to the “Unstacked Output” jack on the interface box. This receiver controls satellite selection.

1. Make sure the vessel is docked in calm water, and ensure the antenna has an unobstructed view of the sky so it can “see” all of the desired satellites.
2. Apply power to the TV and receiver. (If the antenna is turned off, turn it back on using the interface box power switch and wait for system startup, until the interface box shows “TRACKING.”)
3. Using the receiver’s remote, go to the “Point Dish/Signal Strength” screen (press MENU, 6, 1, 1).
4. Choose **Check Switch**, then press SELECT.
5. Choose **Test**, then press SELECT.
6. Wait at least 15 minutes, or until the interface box shows “PLEASE RUN ANOTHER CHECK SWITCH,” before proceeding to allow the antenna to find all of the satellites. Disregard any messages that appear on the TV screen; they do not correctly indicate when the antenna is ready for the next Check Switch test.
7. Once you have waited the appropriate amount of time, select **Test** again to run a second Check Switch test.

8. Once the Check Switch test is complete, refer to the tables in Figure 13 and verify the values displayed on your TV match those required for your selected service.

If your values match: Exit the menu and allow the receiver to download the program guide.

If your values do not match: Reset the system (follow the process on [page 33](#)), then repeat the entire DISH setup process, starting with Step 1 on [page 26](#).

Figure 13 Expected Check Switch Results

DISH 1000/129 Results

Port	1	2	3
Satellite	119	110	129
Trans	OK	OK	OK
Status	Reception Verified		
Switch	SW64		

DISH 1000/61 Results

Port	1	2	3
Satellite	119	110	61.5
Trans	OK	OK	OK
Status	Reception Verified		
Switch	SW64		

DISH 500 Results

Input	1	1	2	2
Satellite	119	119	110	110
Polarity	Odd	Even	Odd	Even
Status	Reception Verified			
Switch	SW42			



Additional Receiver(s) - Run One Check Switch Test

IMPORTANT!

You do not need to run a Check Switch test on an additional receiver if it was **preconfigured** by KVH for your desired DISH Network satellites.

If any receivers are connected to the “Stacked Output” jack on the interface box, follow these steps to run a single Check Switch test on each additional receiver, one at a time.

1. Temporarily disconnect the primary receiver from the “Unstacked Output” jack on the interface box. Connect the additional receiver in its place.
2. Perform Steps 1-5 on [page 27](#) to run the test.
3. Wait 15 minutes, then verify that the values displayed on the TV match those shown in [Figure 13 on page 28](#). If the values do not match, try running another Check Switch test.

DIRECTV Setup

You can set up the system for any one of the following DIRECTV operating modes:

Mode	Satellites Tracked
Tri-Sat Auto	Not used
Tri-Sat Pairs	
Dual-Sat	101 and 119



Tri-Sat Auto or Tri-Sat Pairs – Not Used

These modes are no longer used. The Tri-Sat Auto mode supported the Tri-Sat AutoSwitch; the Tri-Sat Pairs mode supported the HDTV Converter. Neither of these devices is available today.

Dual-Sat

Select this mode to receive programming from the 101 and 119 satellites for DIRECTV service. Follow the steps in [Figure 14 on page 31](#) to set up the antenna.

NOTE: If the status screen does not show “SYSTEM NEEDS SETUP,” follow the steps in [“Resetting the System to Change Setup” on page 33](#).

Figure 14 DIRECTV Setup

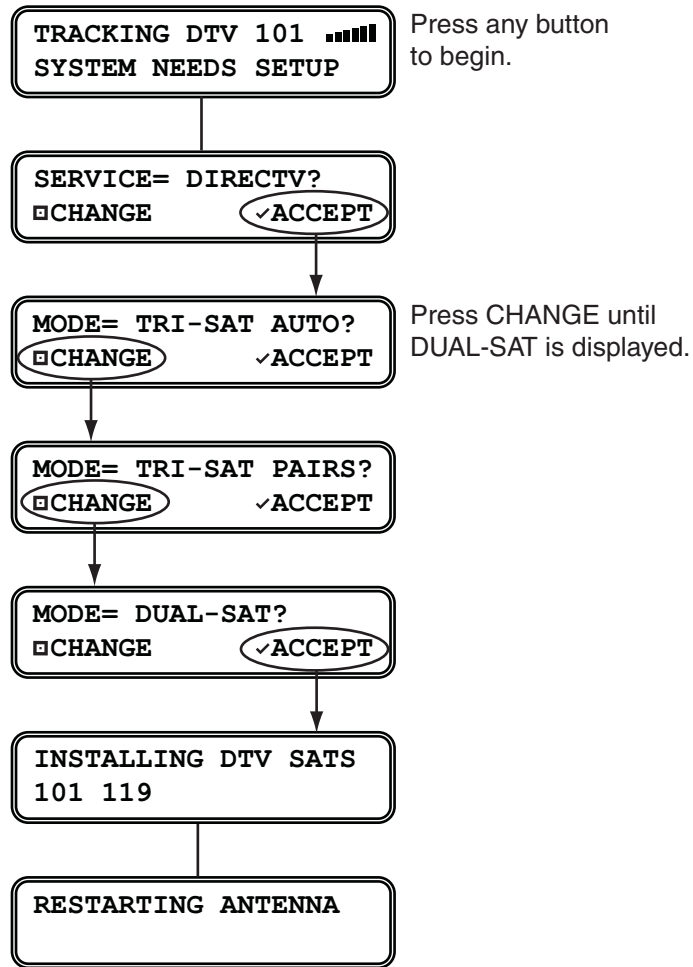

Manual Mode Setup

If none of the automatic modes described earlier include all of the satellites you wish to track, you can set up the system in Manual mode to track up to five satellites of your choice. You will then be able to switch between these satellites using the buttons on the interface box.

Follow the steps in Figure 15 to set up the antenna in Manual mode.

NOTE: If the status screen does not show "SYSTEM NEEDS SETUP," follow the steps in ["Resetting the System to Change Setup"](#) on page 33.

Figure 15 Manual Mode Setup

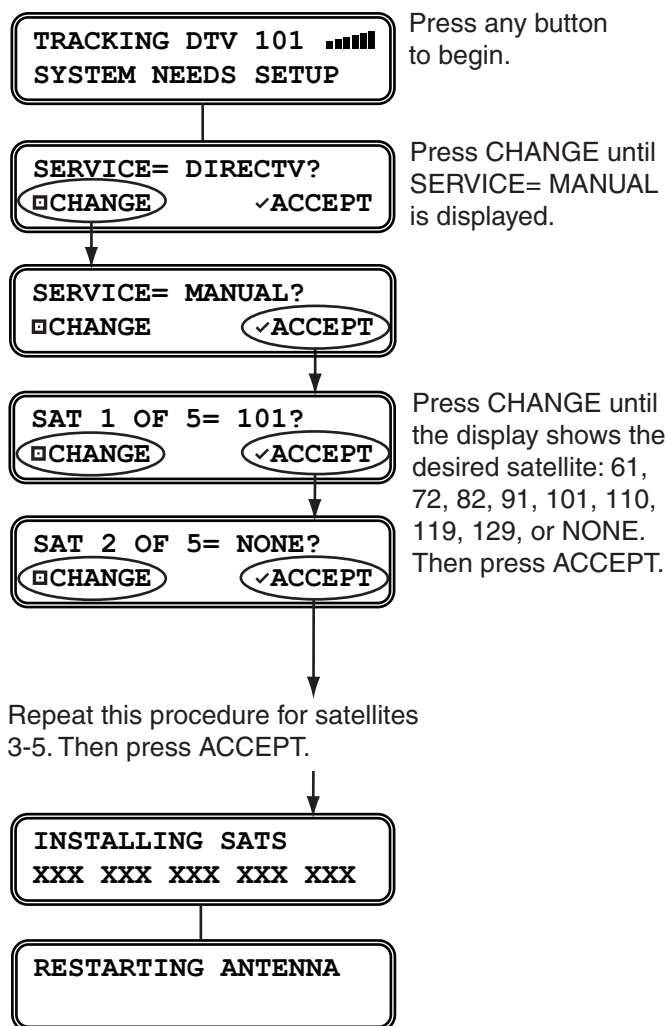

Resetting the System to Change Setup

If you need to change the antenna's setup to receive a different satellite TV service and/or track a different satellite, follow the steps in Figure 16 to reset the system. Once the system has reset to its factory conditions, you will be able to set up the system as described earlier in this section.

IMPORTANT!

(DISH Network only) You will need to reconfigure all of the receivers after you select a different operating mode. Refer to [page 27](#) for details.

Figure 16 Factory Reset

Press MENUS until
 DIAGNOSTICS= No is displayed.

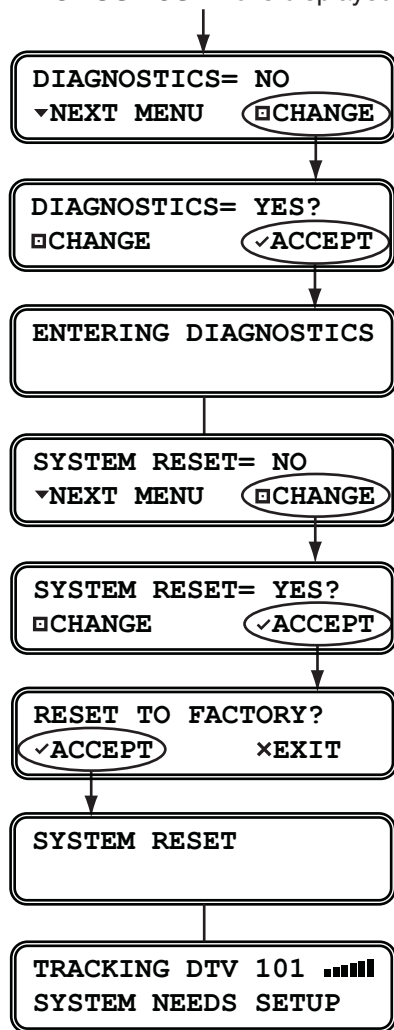



5. Troubleshooting

This chapter identifies potential problems along with their possible causes and solutions. It also explains how to get technical support.

Contents

Five Simple Checks	37
System Status Lights.....	38
Error Messages	40
Running the Diagnostics Test.....	41
Viewing System Information.....	43
Calibrating the Gyros	45
Changing Tracking Parameters	46
Technical Support.....	48





Five Simple Checks

If you are experiencing a problem receiving satellite TV with your TracVision system, perform the five simple checks below. If none of these are the problem, check the status lights on the interface box and/or perform a diagnostics test, as explained in [“System Status Lights” on page 38](#) and [“Running the Diagnostics Test” on page 41](#).

***TIP:** You can also try resetting the satellite TV receiver. Turn off and unplug the receiver, wait one minute, then plug it back in and turn it back on.*

Can the antenna see the satellite?

The antenna requires an unobstructed view of the sky to receive satellite TV signals. Common causes of blockage include trees, buildings, bridges, mountains, and onboard equipment.

Is there excessive dirt or moisture on the antenna dome?

Dirt buildup or moisture on the dome can reduce satellite reception. Clean the exterior of the dome periodically.

Is it raining heavily?

Heavy rain or snow can weaken satellite TV signals. Reception should improve once the inclement weather subsides.

Is the receiver configured for your selected mode? (DISH Network Only)

All DISH Network receivers that you connect to the TracVision system need to be configured for the antenna's operating mode. To configure a receiver, you need to run its Check Switch test. Refer to the step-by-step instructions on [page 27](#).

Is everything turned on and connected properly?

Make sure the power switch on the front of the interface box is turned on (the VOLTAGE light on the front of the interface box should be lit green). Also, make sure your TV and receiver are both turned on and set up for the satellite input. Finally, check the cables connecting all of these components to ensure none have come loose.

System Status Lights

Three status lights on the front of the interface box indicate the current status of the system and can help you identify problems (see Figure 17).

Figure 17 System Status Lights

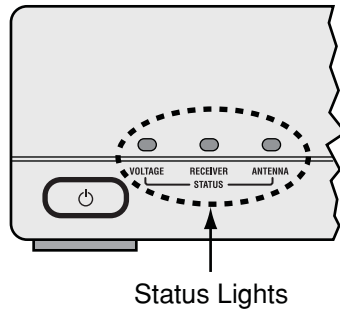

During normal operation, all three status lights should be lit green. The following tables explain what the different light conditions indicate.

VOLTAGE Light

The table below explains what the VOLTAGE light indicates.

Light is...	Indicates	Description
Off	Off	Interface box is off (power switch is off) or no power input
Green	OK	Good power (10-16 VDC at interface box)
Green, flashing	Cable Open	Open detected in antenna cable (check the antenna coax connection)
Orange	Low Power	Low power (9-10 VDC) at interface box)
Red, flashing	Bad Power	Insufficient power (less than 9 VDC or more than 16 VDC input)

RECEIVER Light

The table below explains what the RECEIVER light indicates.

Light is...	Indicates	Description
Green	OK	Good communications with receiver
Orange	No comm	No communications with receiver; receiver is off or disconnected
Orange, flashing	Overload	Overload or short circuit detected on the antenna cable
Red	Fault	Power fault detected in interface box



ANTENNA Light

The table below explains what the ANTENNA light indicates.

Light is...	Indicates	Description
Off	Off	Antenna is off, disconnected, or has insufficient power
Green	Tracking	Antenna is tracking the selected satellite
Green, flashing	Searching	Antenna is searching for a satellite
Orange, flashing	Overload	Overload or short circuit detected on the antenna cable
Red	No comm	No communications with antenna
Red, flashing	Fault	Error detected in antenna

Error Messages

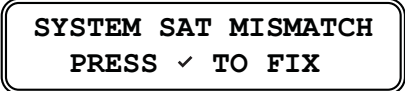
The table below lists possible error messages and the appropriate corrective action.

Warning	Description
	The interface box and antenna are out of sync. Just press ACCEPT to synchronize.
	The receiver is tuned to a channel carried by a satellite that is not installed in the antenna. You might need to change your setup.
	This is not a true error message. This screen indicates that the system needs to be configured for the desired satellite service/configuration. Refer to “Setup” on page 23 for detailed setup information.

Running the Diagnostics Test

In addition to the front panel status lights, the interface box includes a self-test function within its Diagnostics menu. Follow the steps in Figure 18 to perform a diagnostic test. For information on diagnostic test results, see [“Diagnostic Test Results” on page 42](#).

Figure 18 Diagnostics Test

Press MENUS until
 DIAGNOSTICS= No is displayed.

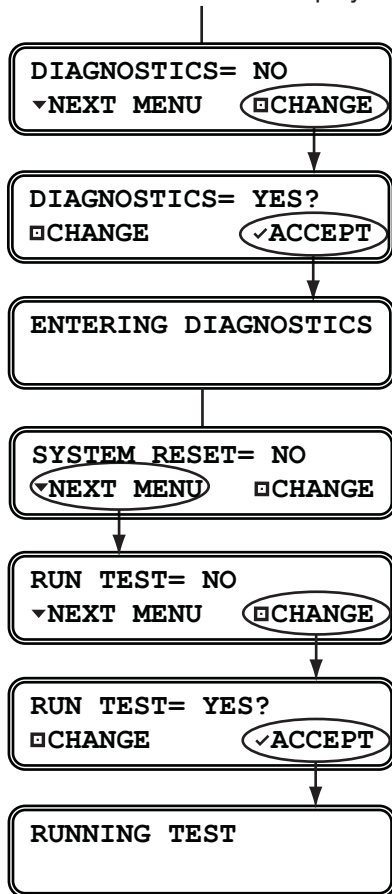

Once the test is complete, the
 display shows the antenna status.

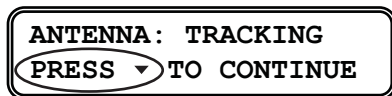

Press MENUS to scroll
 through the remaining
 status messages.

Diagnostic Test Results

The table below lists all of the status messages.

Status Message	Description
ANTENNA: TRACKING PRESS ▼ TO CONTINUE	Antenna status: Idle, Initializing, Searching, Tracking, or Error
SATELLITE: 119 PRESS ▼ TO CONTINUE	Name of the currently selected satellite
BIT ERROR: OK, 928 PRESS ▼ TO CONTINUE	Bit error rate: OK: Less than 2001 High: Between 2001-8000 Bad: Greater than 8000
AGC LEVEL: OK, 22500 PRESS ▼ TO CONTINUE	Automatic gain control level: OK: Between 20000-25000 Bad: Less than 20000 or greater than 25000
SAT 1: 119 PRESS ▼ TO CONTINUE	List of installed satellites. Press MENUS to scroll through the list
LAT/LONG: 41N, 071W PRESS ▼ TO CONTINUE	Last latitude/longitude that you entered into the antenna
CABLE STATE: OK PRESS ▼ TO CONTINUE	Antenna cable status: OK, Open, or Shorted
SYSTEM DC: OK, 12.3 PRESS ▼ TO CONTINUE	Input voltage (DC power): OK: 10-16 VDC Low: 9-10 VDC Bad: Less than 9 VDC or more than 16 VDC
ANTENNA DC: OK, 41.0 PRESS ▼ TO CONTINUE	Antenna voltage (DC power): OK: 39-42 VDC Low: 37-39 VDC Bad: Less than 37 VDC

Viewing System Information

You can view the TracVision system's software versions and serial numbers on the interface box display. Follow the steps in Figure 19 to display the system information. For more information on system information results, see ["System Information Results"](#) on page 44.

Figure 19 System Information

Press MENUS until

DIAGNOSTICS= No is displayed.

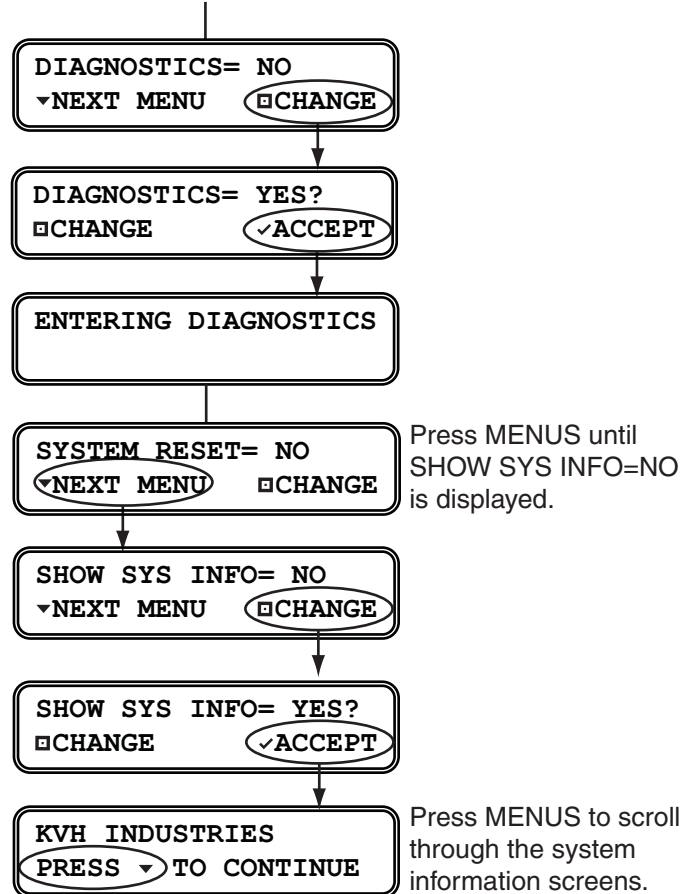

System Information Results

The table below lists all of the status information messages.

Information Message	Description
TRACVISION M1 PRESS ▼ TO CONTINUE	Model of TracVision Antenna
SYS SW: 1.2 PRESS ▼ TO CONTINUE	Version of antenna main software
RF SW: 1.3 PRESS ▼ TO CONTINUE	Version of antenna RF software
MOTOR SW: 1.4 PRESS ▼ TO CONTINUE	Version of antenna motor controller software
JBOX SW: 1.5 PRESS ▼ TO CONTINUE	Version of interface box software
ANT.SER.# 081201234 PRESS ▼ TO CONTINUE	Serial number of antenna
JBOX SER.# 081205678 PRESS ▼ TO CONTINUE	Serial number of interface box

NOTE: The first 4 digits of the serial number indicate the year and month (YYMM) the product was manufactured. For example, if the antenna has a serial number of 081201234, it was built in December 2008.

Calibrating the Gyros

The TracVision antenna's gyros continuously measure the motion of your vessel and send this data to the antenna's motor control circuitry to keep the antenna pointed at the satellite. At the factory, each antenna gyro is precisely calibrated to work with the antenna's circuit board. Therefore, if you ever replace a gyro or circuit board in your antenna, follow the steps in Figure 20 to recalibrate the gyros for the new part.

IMPORTANT!

Calibrate the gyros only if directed by KVH Technical Support, and only while the vessel is stationary in calm water. A poor gyro calibration can reduce the performance of the antenna.

Figure 20 Gyro Calibration

Press **MENUS** until
DIAGNOSTICS= NO is displayed.

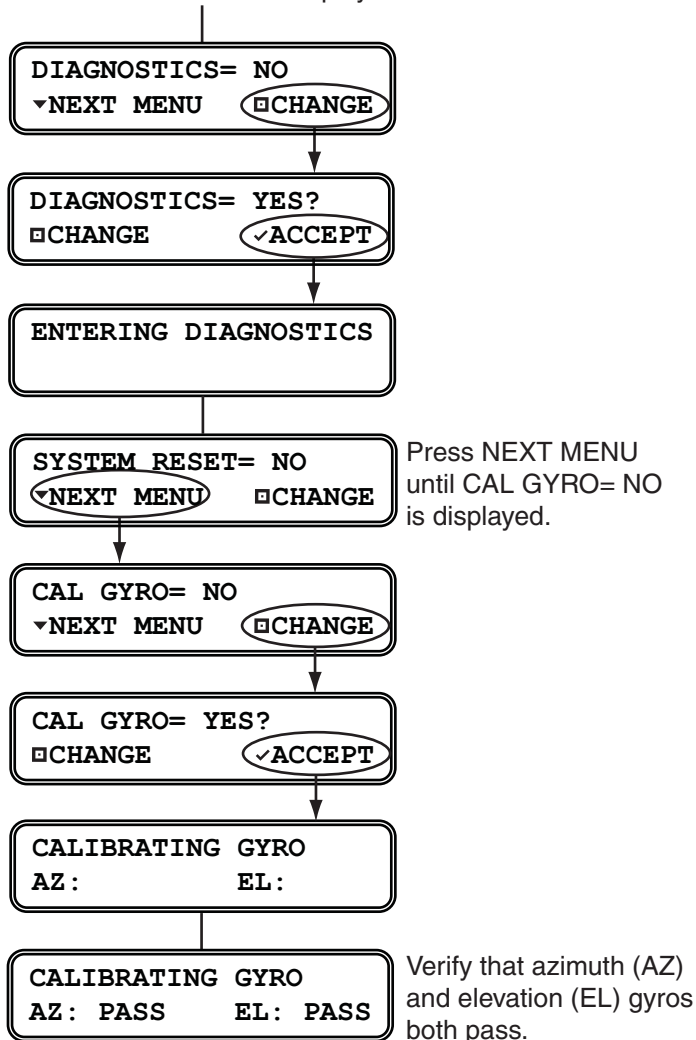

Changing Tracking Parameters

On rare occasions, a satellite service provider may change the configuration of one of its satellites. Since your TracVision antenna identifies a satellite based on the configuration data it has stored in memory, the antenna will no longer be able to track the satellite if its configuration changes. For this reason, the interface box allows you to change any satellite parameter stored in the antenna's memory.

IMPORTANT!

Change tracking parameters only if directed by KVH Technical Support. An incorrect tracking parameter can significantly reduce the performance of the antenna.

Follow the steps in Figure 21 on the next page to change a tracking parameter for an installed satellite.

Figure 21 Tracking Parameter Changes

Press MENUS until
 DIAGNOSTICS= NO is displayed.

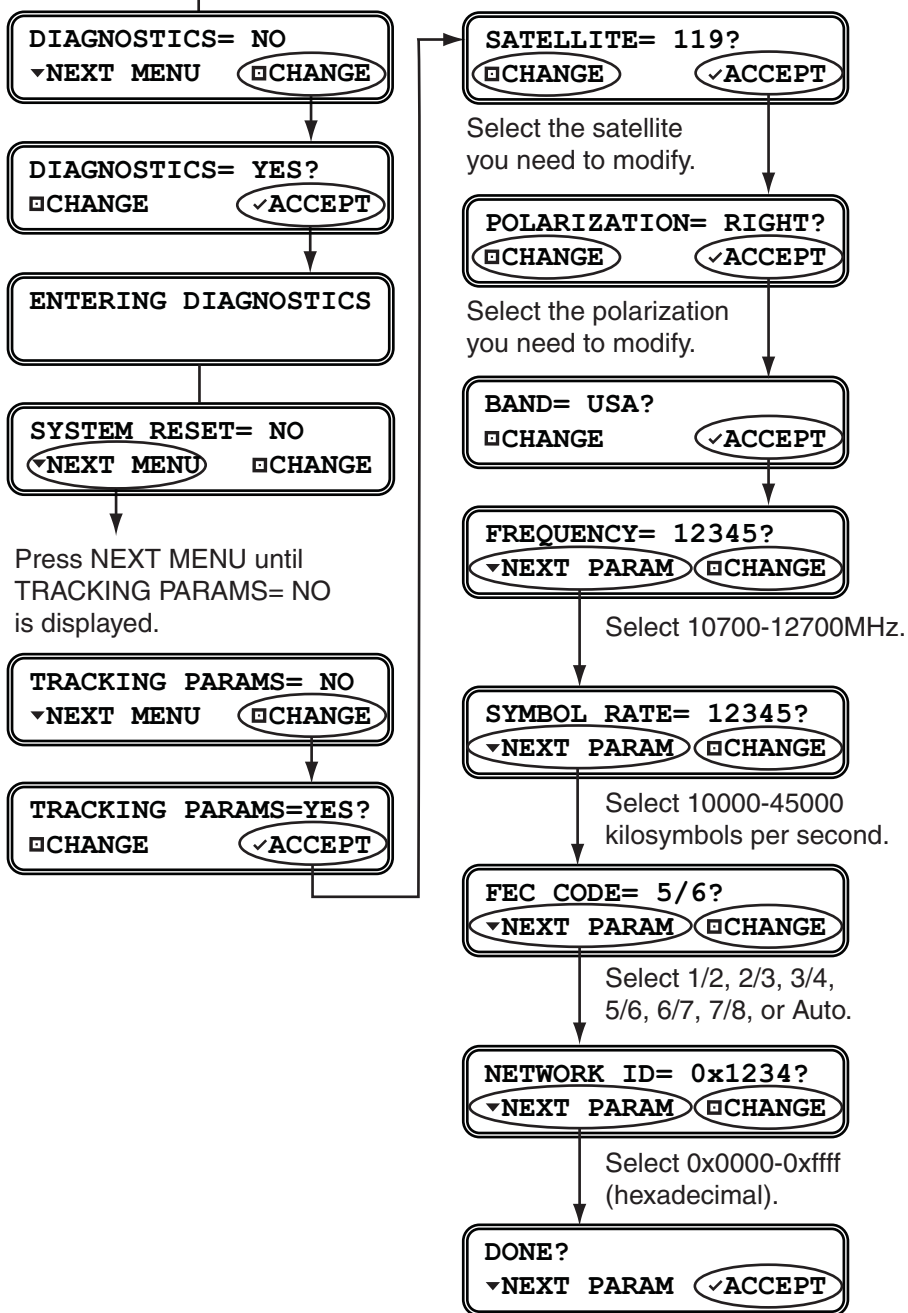

Technical Support

Your TracVision system is a sophisticated electronic device; only KVH-authorized technicians have the tools and expertise necessary to diagnose and repair a system fault. Therefore, if you experience an operating problem or require technical assistance, please call or visit your local authorized TracVision dealer or distributor. You can find an authorized technician near you by visiting our website at www.kvh.com/wheretogetservice.

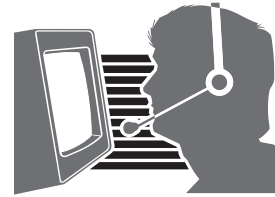

If you need help finding an authorized technician, please contact KVH Technical Support:

Phone: +1 401 847-3327

E-mail: techs@kvh.com

(Mon.-Fri., 9 am-6 pm ET; Sat. 9 am-2 pm ET)

Product Registration

Be sure to register your TracVision system with KVH. The registration process is quick, easy, online, and ensures the best possible service from KVH. Visit www.kvh.com/register or refer to the Product Registration Form.

When you register, you'll enjoy a wide range of benefits, including:

- Free e-mail notification of enhancements and software updates to improve the performance of your system
- Fast, convenient customer and technical support
- Alerts about changes and improvements to services and programming
- Product news and special offers
- Complete privacy - KVH will never sell or share your data with other companies or organizations



Appendix A Wiring Diagrams

This appendix provides wiring diagrams for various receiver configurations.

Contents

Wiring Diagram - 1 Receiver	51
Wiring Diagram - 2 Receivers.....	52
Wiring Diagram - 3 Receivers.....	53



Wiring Diagram - 1 Receiver

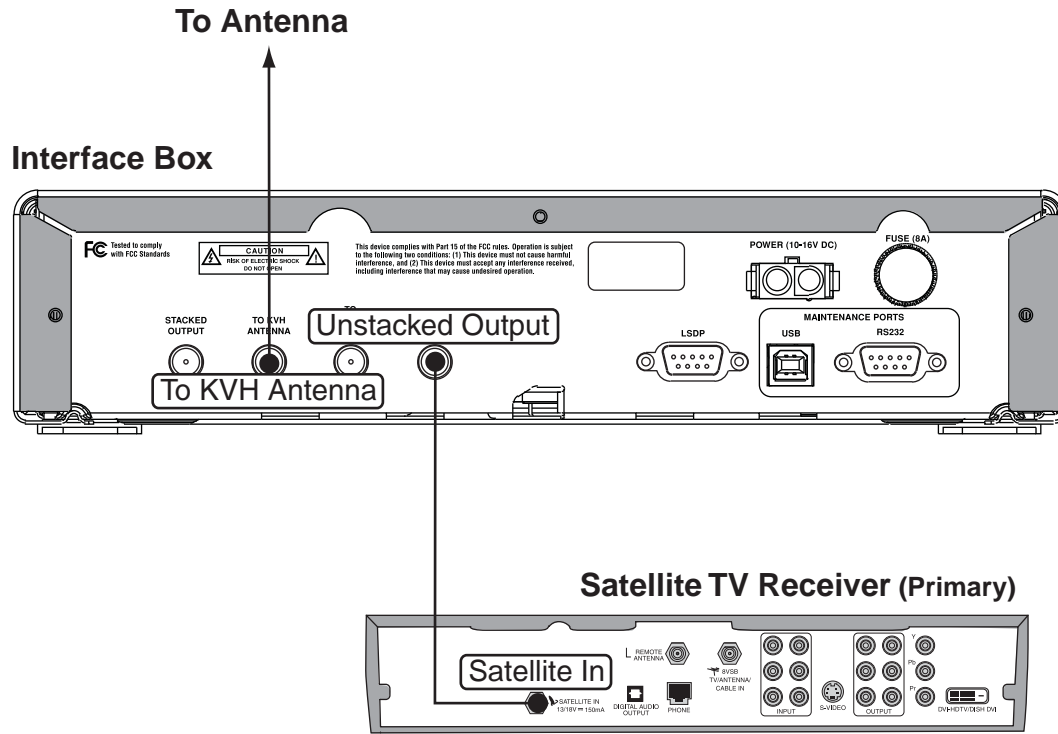

Wiring Diagram - 2 Receivers

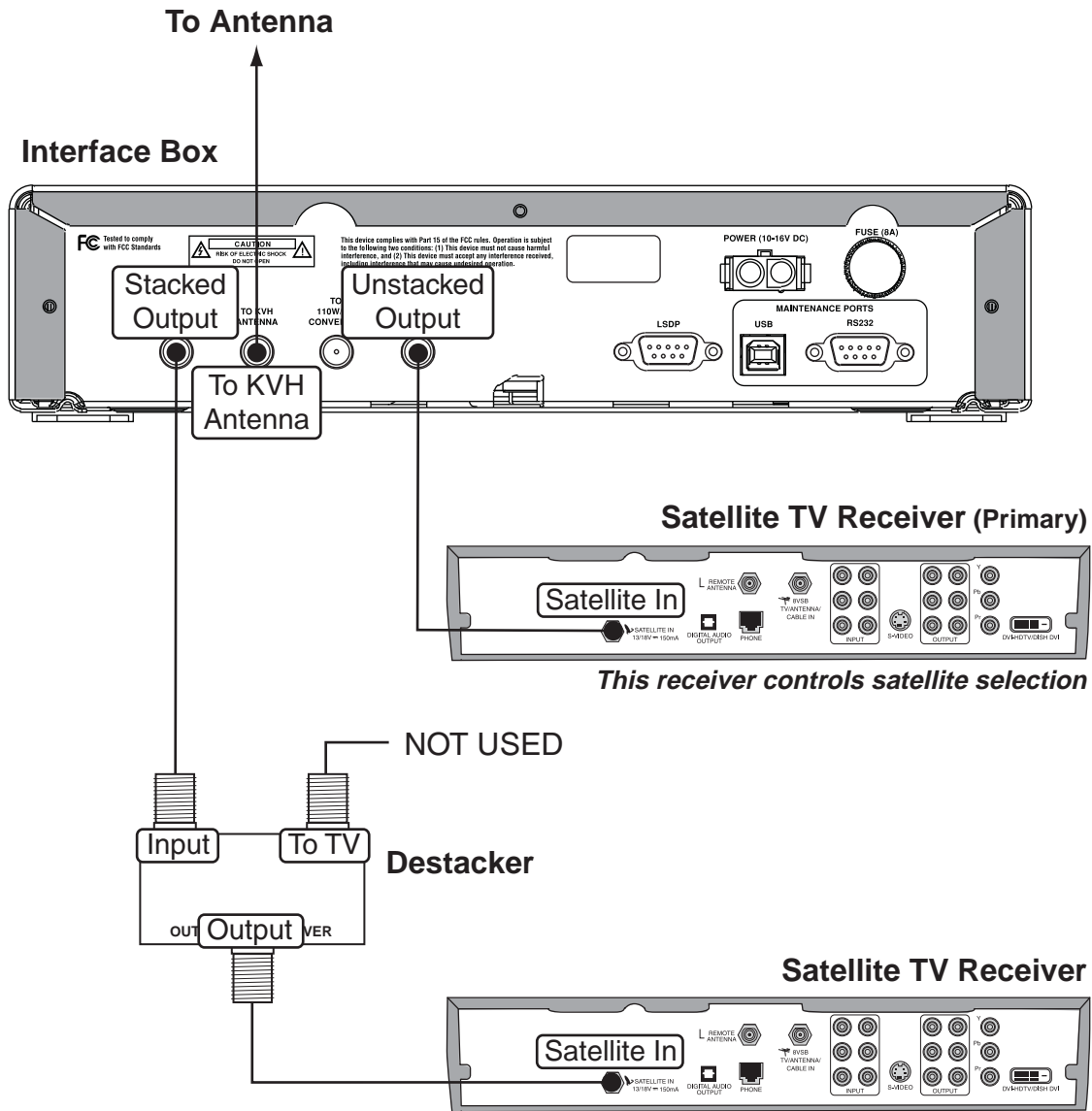

Destacker (Single-Output) Required

The single-output destacker (KVH part #19-0347) converts a stacked signal into an unstacked signal, which standard satellite TV receivers are configured to decode. The interface box has two satellite TV outputs: “Unstacked” and “Stacked.” You will need to install the destacker between the “Stacked” output and your second receiver.

Primary Receiver Controls Satellite Selection

The receiver that you connect to the “Unstacked” output is the primary receiver. If the system is set up for automatic switching, the primary receiver controls satellite selection.

Wiring Diagram - 3 Receivers

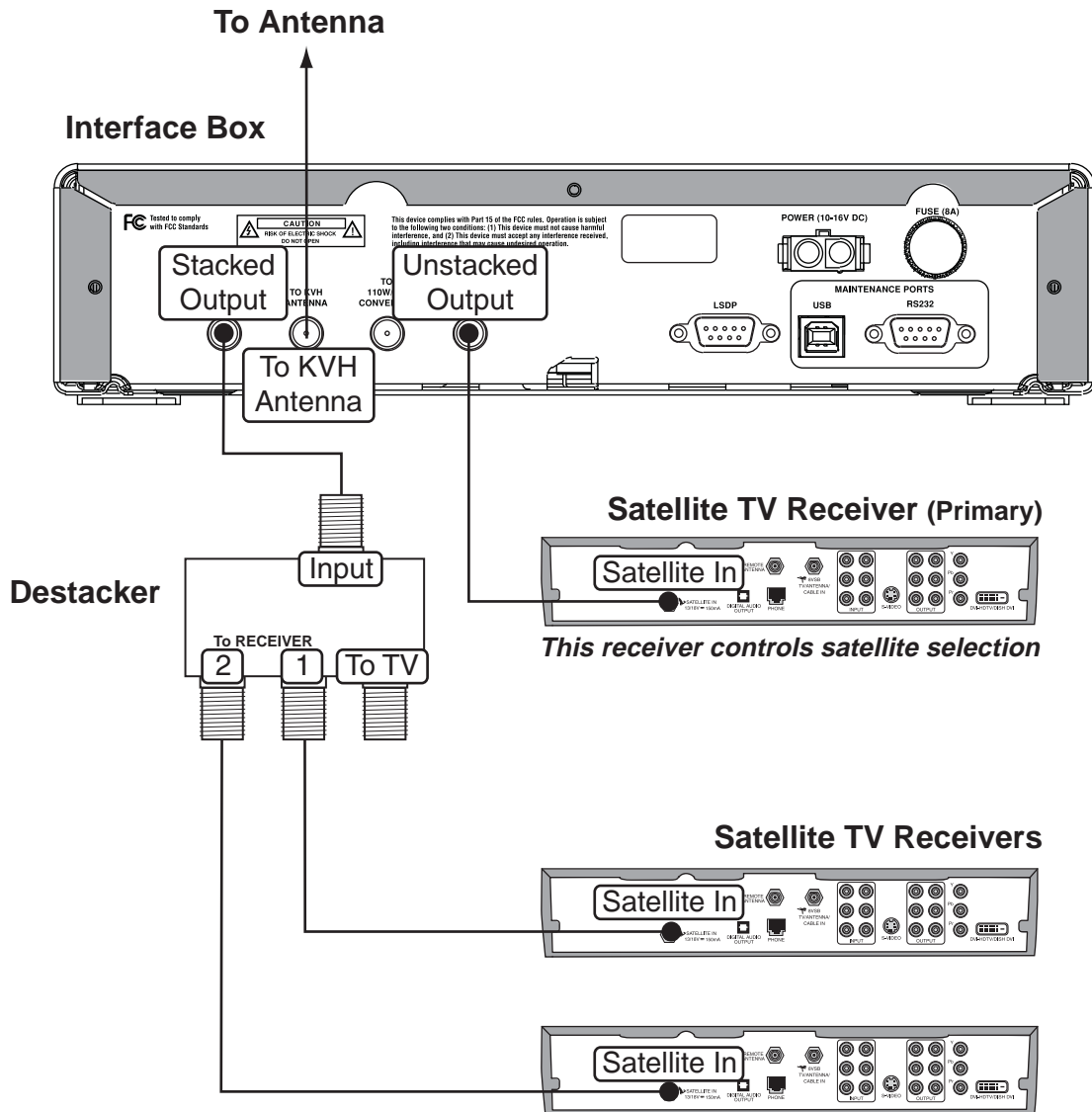

Destacker (Dual-Output) Required

The dual-output destacker (KVH part #19-0410) converts a stacked signal into two unstacked signals, which standard satellite TV receivers are configured to decode. The interface box has two satellite TV outputs: “Unstacked” and “Stacked.” You will need to install the destacker between the “Stacked” output and your second and third receivers.

Primary Receiver Controls Satellite Selection

The receiver that you connect to the “Unstacked” output is the primary receiver. If the system is set up for automatic switching, the primary receiver controls satellite selection.



Appendix B Menus Quick Reference Guide

This appendix provides a quick reference guide to the interface box menu structure.

Contents

Interface Box Menus.....	57
--------------------------	----



Interface Box Menus

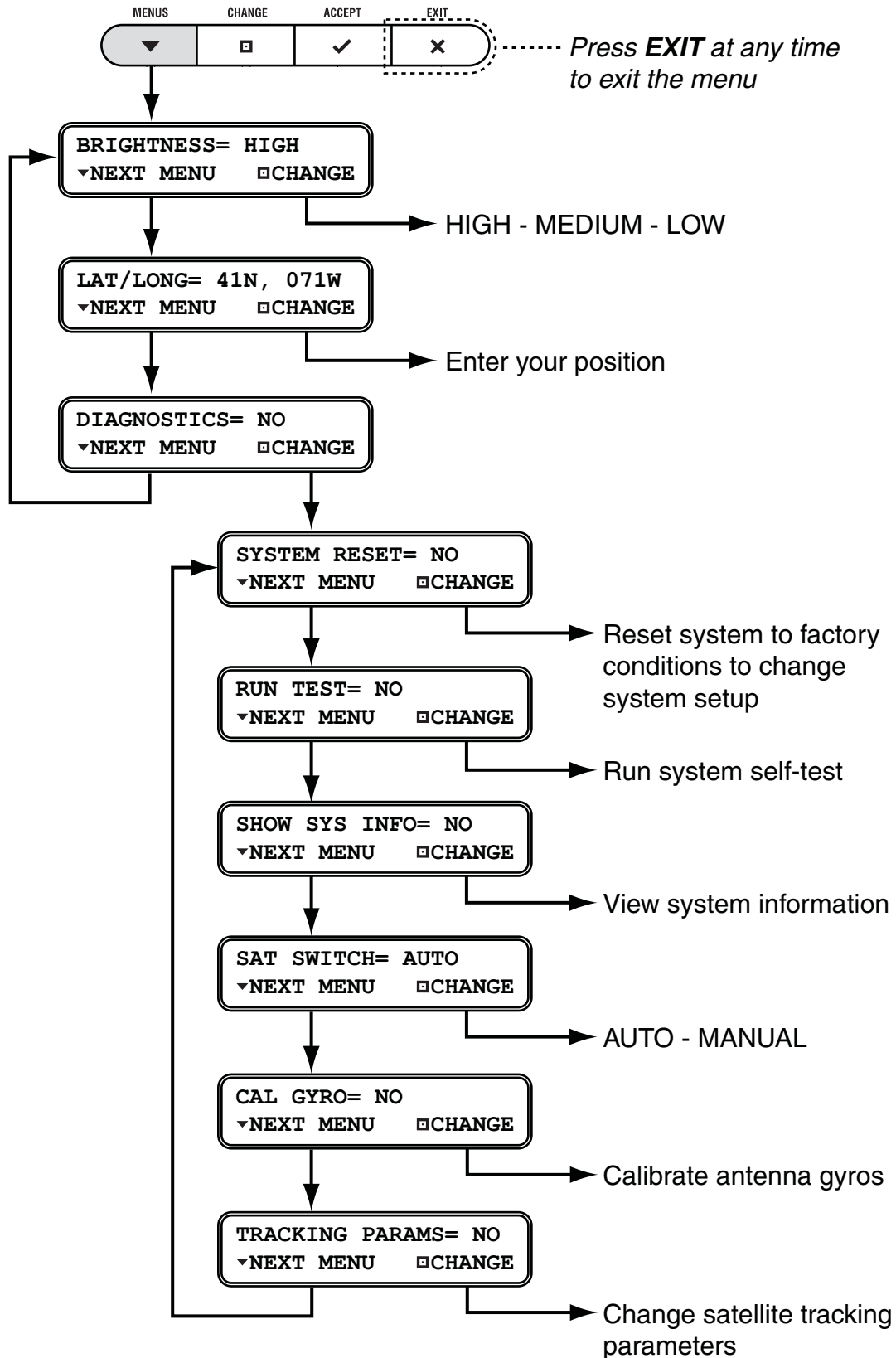



www.kvh.com

KVH Industries, Inc.
Middletown, RI U.S.A.
Tel: +1 401 847 3327
Fax: +1 401 849 0045
E-mail: info@kvh.com

KVH Europe A/S
Kokkedal, Denmark
Tel: +45 45 160 180
Fax: +45 45 160 181
E-mail: info@kvh.dk

KVH Norway AS
Horten, Norway
Tel: +47 33 03 05 30
Fax: +47 33 03 05 31
E-mail: commboxsales@kvh.com

KVH Singapore
Singapore
Tel: +65 6829 2343
Fax: +65 6829 2121
E-mail: infokvhsingapore@kvh.com