

TRACVISION[®]
BY KVH INDUSTRIES



**DIRECTV[®] Mobile
Receiver/Controller
User's Guide**

DIRECTV®

Mobile Receiver/Controller User's Guide

Congratulations! You have chosen TracVision, a revolutionary antenna system delivering *live* satellite TV entertainment on the go. With hundreds of channels of digital-quality TV and music to enjoy, traveling will never be the same!

This User's Guide provides all of the basic information you need to operate the DIRECTV mobile receiver/controller and receive the DIRECTV programming you want. For detailed antenna system installation information, please refer to the *TracVision Installation Guide*.

TRACVISION®



KVH Part # 54-0376 Rev. C

© 2007 KVH Industries, Inc., All rights reserved.

KVHI™
NASDAQ
LISTED

Trademarks

KVH, TracVision, and DewShield are trademarks of KVH Industries, Inc.

Programming, pricing, terms, and conditions are subject to change. Pricing residential. Taxes not included. Receipt of DIRECTV programming is subject to the DIRECTV Customer Agreement, a copy of which is provided at DIRECTV.com/legal and in your first bill.

DIRECTV and the Cyclone Design logo, DIRECTV INTERACTIVE, TOTAL CHOICE, DIRECTV HOME SERVICES, FREEVIEW, and DIRECT TICKET are trademarks of DIRECTV, Inc. All trademarks, marks, names, or product names referenced in this publication are the property of their respective owners, and KVH neither endorses nor otherwise sponsors any such products or services referred to herein.

StarSight Information – StarSight features licensed under one or more of the following patents: 4,706,121; 5,151,789; 5,353,121; 5,353,277; 5,479,266; 5,479,268; and 5,532,754. Use rights reserved.

TruSurround Information – TruSurround and the  symbol are trademarks of SRS Labs, Inc. TruSurround technology is incorporated under license from SRS Labs, Inc.

ENERGYSTAR Information – ENERGYSTAR and the ENERGYSTAR certification mark are registered U.S. marks.

TiVo is a registered trademark of TiVo Inc., or its subsidiaries.

Software contained in the mobile receiver/controller and referenced in this manual is copyright ©1995-2006 by DIRECTV, Inc. Some features are patent pending. WatchWizard, PreSelect, TurboTune, and OneLine Guide are trademarks of Hughes Network Systems. "NFL," the NFL Shield, and "NFL SUNDAY TICKET" are registered trademarks of the National Football League and its affiliates. "NHL," the NHL Shield, and "NHL CENTER ICE" are registered trademarks of the National Hockey League. "MLB," "MLB EXTRA INNINGS," "Major League Baseball," and the Major League Baseball silhouetted batter logo are service marks of Major League Baseball Properties, Inc. Major League Baseball trademarks and copyright are used with permission of Major League Baseball Properties, Inc. All other trademarks and service marks are the property of their respective owners.

Disclaimer

Every effort has been made to ensure the correctness and completeness of the material in this document. No company shall be liable for errors contained herein. The information in this document is subject to change without notice. No warranty of any kind is made with regard to this material, including, but not limited to, the implied warranties of merchantability and fitness for a particular purpose.

Note on recording programming

Most television programs and films are copyrighted. This means that someone has legal rights governing the reproduction and distribution of this material. In certain circumstances, copyright law may apply to private taping of copyrighted materials. In most cases, it is permissible to record for your personal use, as long as you do not sell the material. You must act responsibly in this area—check into the matter if you are unsure.

Some pay-per-view programs may be licensed from producers as "view-only" programs. These are copyrighted programs, and may not be copied or reproduced for any purpose without the express written permission of the copyright owner.

Important Safety Instructions - *Please Read*

For your safety and protection, read this safety section carefully.

Heed Cautions – Be sure to follow all cautions on the product and in the operating instructions. Cautions are indicated by a  icon.

Follow Instructions – Be sure to follow all operating instructions as detailed in this manual.

The following caution appears on the back of the receiver/controller:



Do not open the receiver/controller's cover. Opening or removing the cover may expose you to dangerous voltage.



WARNING!

Avoid Driver Distraction

It is dangerous to watch television or operate the remote control while you are driving a vehicle or piloting a vessel. TracVision is designed specifically to provide entertainment to passengers and should never be connected to active video screens visible to the vehicle/vessel driver while in motion. Failure to pay full attention to travel conditions could result in an accident or collision with personal injury or death resulting.

Do Not Attempt Repairs Yourself

Refer all servicing needs to qualified service personnel. Servicing is required when a unit has been damaged in any way or does not operate normally. Evidence of tampering or unauthorized repairs will void the warranty.

Federal Communications Commission (FCC) Regulatory Information for Vehicle Use

Declaration of Conformity – Standards to which Conformity is declared:
FCC Part 15

This device complies with Part 15 of the FCC Rules. Operation is subject to the following two conditions: (1) this device may not cause harmful interference, and (2) this device must accept any interference received, including interference that may cause undesired operation.

Responsible Party's Name: KVH Industries, Inc.

Address: 50 Enterprise Center, Middletown, RI 02842

Telephone: 1-401-847-3327

Trade Name: KVH

Type of Equipment: Satellite Receiver

Model Number: TracVision DIRECTV Mobile Receiver/Controller

Federal Communications Commission (FCC) – This equipment complies with Part 15 of the FCC rules.

Part 15 Compliance – This equipment has been tested and found to comply with the limits for a Class B digital device, pursuant to Part 15 of the FCC rules. These limits are designed to provide reasonable protection against harmful interference in a vehicle installation. This equipment generates, uses, and can radiate radio frequency energy and, if not installed and used in accordance with the instructions, may cause harmful interference to radio communications.

However there is no guarantee that interference will not occur in a particular installation. If this equipment does cause harmful interference to radio or television reception, which can be determined by removing and applying power to the equipment, the user is encouraged to try to correct the interference by one or more of the following measures:

- Increase the separation between the equipment and the receiver/controller.
- Connect the equipment on a circuit different from that to which the receiver/controller is connected.
- Consult the dealer or an experienced auto electronics technician for help.

The user may find the following booklet, prepared by the Federal Communications Commission, helpful: "How to Identify and Resolve Radio and TV Interference Problems." This booklet is available from the U.S. Government Printing Office, Washington, DC.

To meet FCC requirements, only components certified to comply with Class B limits may be attached to this device. Operation with noncertified peripherals is likely to result in interference to radio and TV reception.

To meet FCC requirements, shielded cables are required to connect the device to another Class B certified device.

Receiver/Controller Activation

NOTICE: This product will NOT work correctly unless you follow the procedure below.

Before you can start watching satellite TV via TracVision, the receiver/controller must be activated. Once your antenna system is fully installed, follow the steps below to activate the receiver/controller.

1. Ensure your antenna has a clear view of the southern sky then turn on your TracVision system and tune to the preview channel (100).
2. Locate your red Activation Card.
3. Call KVH's Activation Department at:

1-866-551-8004

(24 hours a day, 7 days a week)



Please have the antenna and receiver/controller serial numbers handy when calling to activate. The serial numbers are noted on the red Activation Card.

4. After activation is complete, KVH's Activation Department will provide an access card number, receiver ID number, DIRECTV serial number, and model number. Enter these numbers in the associated boxes on the red Activation Card.

Technical Support

The TracVision system has been designed with durability and low maintenance in mind. If you experience an operating problem or otherwise require technical assistance, please call your local authorized TracVision dealer/installer. If an authorized dealer/installer is not located nearby, contact KVH Technical Support directly:

Phone: **1-401-847-3327**

E-mail: techs@kvh.com

Send Us Your Comments About This Manual

If you have any comments regarding this manual, please e-mail them to manuals@kvh.com. Your feedback is greatly appreciated!

Table of Contents

1 Introduction	1.1
1-1 Using this Manual	1.3
1-2 System Overview	1.4
1-3 Receiving Satellite TV Signals	1.5
2 Getting Started	2.1
2-1 Turning On the Antenna	2.3
2-2 Changing Channels	2.5
2-3 Turning Off the Antenna	2.5
2-4 Viewing a Program Description	2.5
3 Using the Remote Control	3.1
3-1 Remote Control Functions	3.3
3-2 Programming the Remote Control to Operate Other Components	3.9
3-3 Controlling Multiple Receivers	3.10
3-4 Installing the Remote Control Batteries	3.11
4 Overview of Onscreen Displays	4.1
4-1 The Channel Banner	4.3
4-2 The Program Guide	4.4
4-3 The Menu System	4.5
5 Using Program Guides	5.1
5-1 Program Guide Styles	5.3
5-2 Using the Program Guide	5.5
5-3 Using the OneLine Guide	5.6
5-4 Using TurboTune for Quick Access to Favorite Channels	5.7
5-5 Setting Guide Preferences	5.9
6 Setting Favorites and Filters	6.1
6-1 Using Favorite Channel Lists	6.3
6-2 Filtering the Program Guide	6.7
6-3 Selecting Guide Times	6.8
6-4 Using WatchWizard to Search for Programs	6.9

7 Using Access Controls7.1

- 7-1 Locking & Unlocking the System7.3
- 7-2 Setting Ratings Limits7.5
- 7-3 Setting Time Limits7.6

8 Other Menu Functions8.1

- 8-1 Adjusting Audio Settings8.3
- 8-2 Adjusting Video Settings8.5
- 8-3 Using the Program Director to Schedule Future Programs8.6
- 8-4 Reading Mail from DIRECTV8.8
- 8-5 Setting System Preferences8.9
- 8-6 Advanced System Setup Functions8.11

9 Antenna Controls9.1

- 9-1 Viewing Current Settings9.3
- 9-2 Turning DewShield On/Off9.4
- 9-3 Turning the Beeper On/Off9.5

- 9-4 Designating the Receiver as Primary or Secondary9.6
- 9-5 Switching Satellites9.8
- 9-6 Changing the List of Available Satellites9.10

10 Troubleshooting10.1

- 10-1 Five Simple Checks10.3
- 10-2 Troubleshooting Matrix10.4
- 10-3 Causes and Solutions to Common Problems10.5
- 10-4 System Status Lights10.10
- 10-5 Viewing Diagnostic Information10.12
- 10-6 Viewing Serial Numbers10.13
- 10-7 Viewing Software Versions10.14
- 10-8 Technical Support10.15

AppendicesA.1

- A System Wiring DiagramsA.3
- B Elevation MapsA.23

1 Introduction

This section provides a basic overview of this manual and the TracVision system. It also explains the three essentials for good satellite TV reception.

Contents

1-1	Using this Manual	1.3
1-2	System Overview	1.4
1-3	Receiving Satellite TV Signals	1.5

1-1 Using this Manual

This manual provides complete instructions for operating your mobile receiver/controller.

Throughout this manual, important information is marked for your attention by the following icons:



A helpful tip that either directs you to a related area within the manual or offers suggestions on getting the highest quality out of your system.



An alert to important information regarding procedures, product specifications, or product use.



Indicates the most commonly used functions listed in *Section 3-1, "Remote Control Functions."*

Format Conventions

This manual uses the following typographical conventions to help clarify instructions:

Text Example	Description
...the MUTE button.	Remote control buttons
...the Cancel button.	Onscreen items

“Highlight”

For the purposes of this manual, the term “highlight” refers to the following operator action:

“Use the remote control’s joystick to move the highlight onto the desired onscreen item.”

Example: “Highlight the **Lock & Limits** tab” means “Use the remote control’s joystick to move the highlight onto the **Lock & Limits** tab.”

“Receiver”

For the purposes of this manual, the term “receiver” refers to the DIRECTV mobile receiver/controller.

1-2 System Overview

Your TracVision system is a state-of-the-art, actively stabilized antenna system that delivers live satellite TV to your mobile audio/video entertainment system.

TracVision System Diagram (Typical Installation)

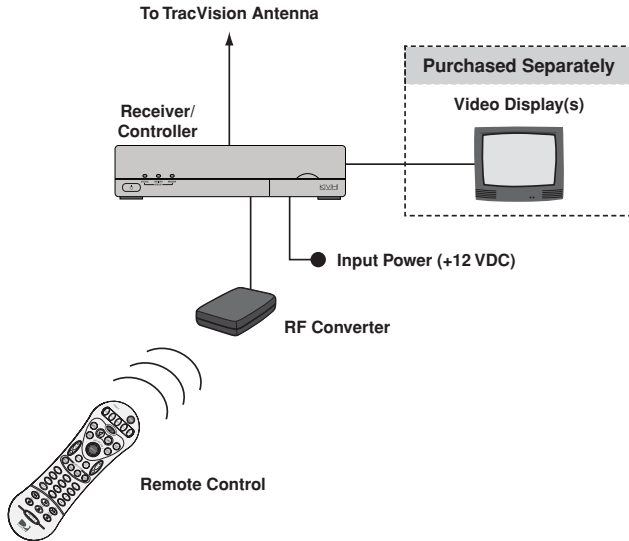

Mobile Receiver/Controller

The mobile receiver/controller decodes satellite TV signals from the antenna unit and sends the signals to the audio/video system. It also powers and controls the TracVision antenna.



Remote Control

The wireless RF/IR remote control allows you to control all receiver functions. The remote does not need to be pointed directly at the receiver for the signal to be received.



RF Converter

The RF converter receives RF commands from the remote control, converts them to digital signals, and sends them to the receiver for processing. *Since the receiver does not include an IR eye, the RF converter is required to receive commands from the remote.*



1-3 Receiving Satellite TV Signals

Like a satellite dish used at home, the TracVision antenna needs a clear view of the DIRECTV® satellite(s) to receive satellite TV signals. Consider the three essentials noted on the following pages to ensure trouble-free reception.

Satellite Footprint

Each DIRECTV satellite is located at a fixed position above the Earth's equator and beams TV signals down to North America. To receive TV signals from one of these satellites, you must be located within its coverage area (for example, the 101 satellite encompasses much of the continental United States). As you approach the edges of the coverage area, the strength of the signal degrades, resulting in weaker reception.

DIRECTV 101 Satellite Location



To view satellite coverage maps, please visit KVH's website at www.kvh.com/footprint.

Elevation Angle

Since TV satellites are located above the equator, the TracVision antenna needs to point toward the southern sky to receive satellite TV signals. In addition, the antenna must be tilted at the proper elevation angle to point at the satellite. The further south you go, the higher the elevation becomes. For example, if you're in the Massachusetts area, the 101 satellite is located 33° above the southern horizon. But if you go to Florida, the elevation increases to 50°.

While you're moving, the antenna automatically rotates toward the southern sky and tilts to the proper elevation, ensuring you're always pointed at the satellite. Elevation ranges of TracVision antennas:

Antenna Model	Elevation Range
TracVision A7	31°-57°
TracVision R6	15°-60°
TracVision M3 or M2	10°-80°

Maps of approximate elevation angles for DIRECTV satellites are provided in *Appendix B on page A.23*.

Blockage

Since the TracVision antenna must have a clear view of the DIRECTV satellite to receive satellite TV signals, anything that stands between the antenna and the satellite can block the signal, resulting in lost reception. Common causes of blockage include trees, buildings, and bridges. Heavy rain, ice, or snow may also temporarily interrupt satellite signals.

Higher Satellite Elevation = Less Blockage

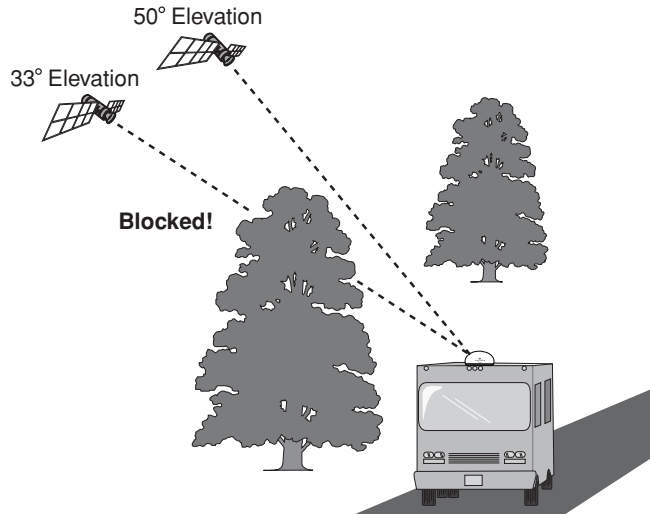

2 Getting Started

This section provides basic operation instructions, so you can quickly start using your TracVision system.

Contents

2-1	Turning On the Antenna	2.3
2-2	Changing Channels	2.5
2-3	Turning Off the Antenna	2.5
2-4	Viewing a Program Description	2.5

2-1 Turning On the Antenna

To quickly start watching satellite TV using the TracVision system, follow the simple steps below.

1. Apply power to the mobile receiver/controller. The Receiver status light should turn green.
2. Turn on your TV and select the satellite input (*not the VCR input*).
3. Wait 30-60 seconds for the antenna to acquire the satellite signal. The TV will show the following:

Message 1

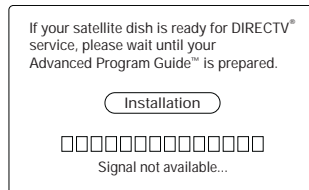

Message 2

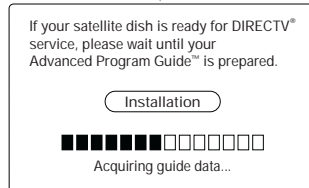

4. If Message 1 does not appear after 30 seconds, press the remote control's **SAT** button. Then press the remote's **PWR** button. The receiver beeps twice, the Antenna status light begins to flash green, and the Voltage status light should be lit green.

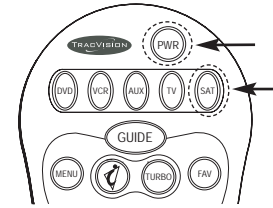

Status Lights

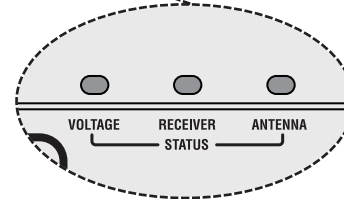

For details about the status lights, see Section 10-4, "System Status Lights" on page 10.10.

If the receiver's Voltage status light is off, press the power switch on the front of the receiver to turn on the receiver.

Power Switch

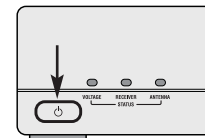

5. If Message 2 does not appear after Message 1, ensure that the antenna has a clear view of the satellite. The antenna requires an unobstructed view of the sky to receive satellite TV signals.* Once the antenna locks onto the satellite, the receiver starts downloading the program guide. This may take up to 60 seconds.

Once the program guide has loaded, you can start enjoying satellite TV!**

* For details about satellite reception requirements, see page 1.5.

** If you can only view the DIRECTV Preview Channel, your receiver has not been activated. See page v.





Why Does the Receiver Beep?

The receiver beeps to indicate the status of the antenna.

2 beeps = Antenna is powering on

1 beep = Antenna is powering off

Program Guide

PROGRAM GUIDE All Channels		Thu, Feb 7 • 6:00PM		
Selected Program Description None • 6:00PM - 7:00PM		Picture-in-Guide An image of the currently airing program highlighted in the menu selection appears here.		
Today	6 PM	6:30	7 PM	7:30
	Selected Program		Next Scheduled Program	
	Alternate Program 1			
	Alternate Program 2			
	Alternate Program 3		Next Scheduled Program	

2-2 Changing Channels

To change the channel, press the SAT button then select any of the following options:

- A** Press the CHANNEL (CH) button to tune to the next or previous channel.

or

- B** Using the numeric keypad, enter the channel number.

or

- C** Press the GUIDE button to bring up the **program guide**. While in the program guide, use the joystick or CHANNEL (CH) button to scroll through the list, and press the SELECT button to tune to a channel.

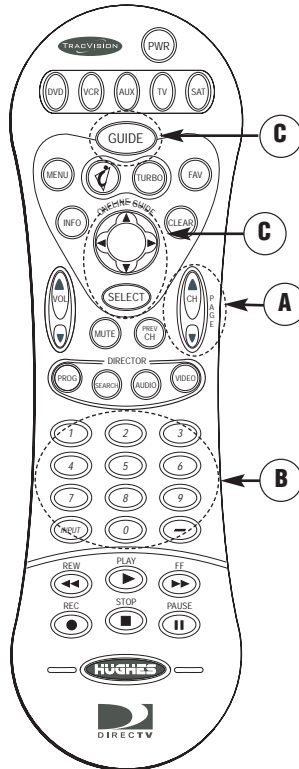

2-3 Turning Off the Antenna

To turn off the antenna, follow the steps below:

1. Press the remote control's SAT button. The button should blink red.
2. Press the PWR button. The receiver beeps once to indicate that power to the antenna is turned off.

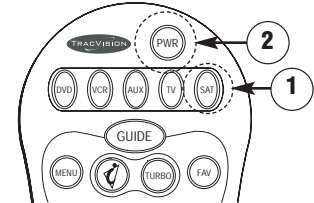

2-4 Viewing a Program Description

To view a description of the currently selected program, press the INFO button.

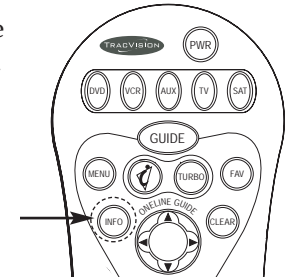

3 Using the Remote Control

This section explains how to use the remote control functions, program the remote to work with other components, and replace the remote control batteries.

Contents

3-1	Remote Control Functions	3.3
3-2	Programming the Remote Control to Operate Other Components	3.9
3-3	Controlling Multiple Receivers	3.10
3-4	Installing the Remote Control Batteries	3.11

TracVision Remote Control

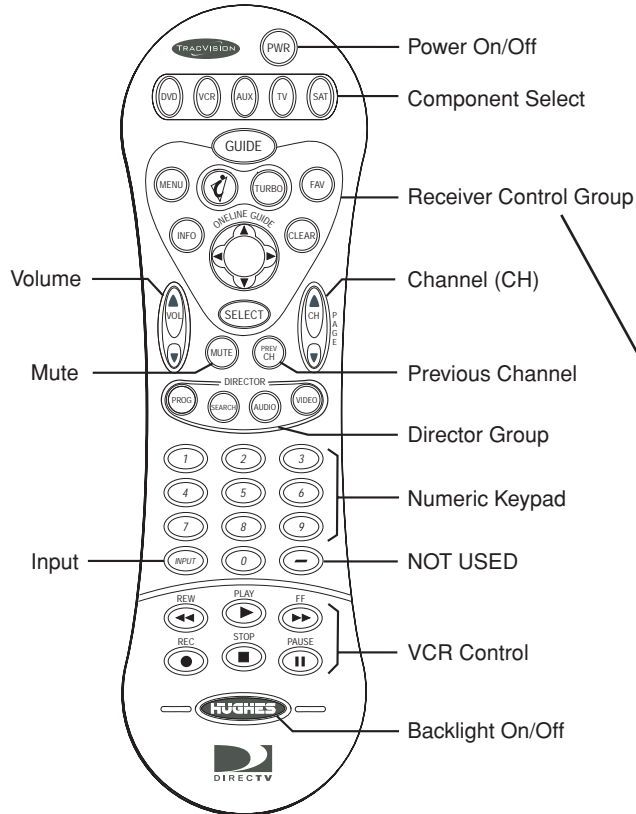

3-1 Remote Control Functions

Your system comes with an easy-to-use, backlit remote control that uses RF (radio frequency) signals instead of IR (infrared) to control the receiver. This allows you to operate the receiver without pointing the remote directly at it. This page shows the locations and names of the remote control buttons. The next few pages detail the buttons' functions. A  icon indicates the most frequently used functions.



*For your safety, this product must **NOT** be operated by the driver of the vehicle/vessel.*

Receiver Control Group

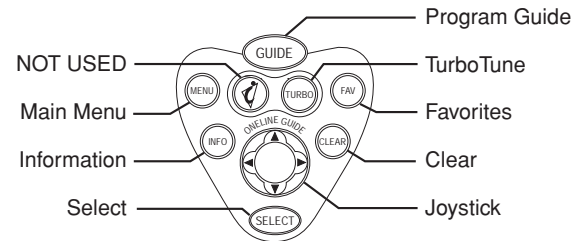

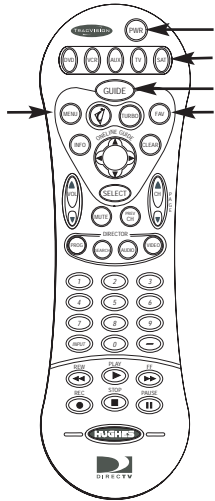

Press the PWR button to turn the selected component's power on/off. If the SAT button is currently selected, pressing the PWR button turns the TracVision antenna on/off (but receiver remains powered in standby).



Press the SAT component select button to control the mobile receiver. To control a different component, press the associated component select button. For example, press the VCR button to control the VCR.



Press the GUIDE button to display the program guide. Press it a second time (while a program title is highlighted) to display the Category Filter menu. See *Section 5, "Using Program Guides,"* on page 5.1 for details.



Press the MENU button to bring up the main menu. The menu system allows you to access all system features and settings. See *Section 4-3, "The Menu System,"* on page 4.5 for details.



Press the TURBO button to display the TurboTune™ guide. TurboTune gives you quick access to 27 of your favorite channels. See *Section 5-4, "Using TurboTune for Quick Access to Favorite Channels,"* on page 5.7 for details.

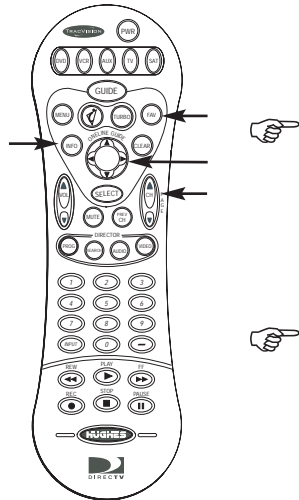

Press the FAV button to view listings for your favorite channels. You can set up four different lists of favorite channels. Each press of the FAV button brings up the next favorite channel list. See *Section 6-1, "Using Favorite Channel Lists,"* on page 6.3 for details.



Press the INFO button to display a brief description about the program you are viewing. If the program guide is displayed, the INFO button provides scheduling information about the highlighted program.



Use the joystick to move up, down, left, or right through the onscreen displays.

If you are currently watching a program, press the joystick up or down to display the OneLine guide. When the OneLine guide appears, press the joystick up or down to step to the next higher- or lower-numbered channel.



Press the SELECT button to activate or choose a highlighted menu option.



Press the CLEAR button to exit from any onscreen guide, remove banners, or cancel an action.



Use the VOLUME (VOL) button to raise or lower the volume on your TV. *The remote control must be programmed to operate your TV for the VOLUME button to work (see Section 3-2, "Programming the Remote Control to Operate Other Components," on page 3.9).*



Press the MUTE button to turn off the volume on your TV. *The remote control must be programmed to operate your TV for the MUTE button to work (see Section 3-2, "Programming the Remote Control to Operate Other Components," on page 3.9).*



Press the PREVIOUS CHANNEL (PREV CH) button to toggle between the current channel and the last channel you were watching.



Use the CHANNEL (CH) button to change the channel to the previous or next available channel. Also use it to scroll through a page of program guide listings.

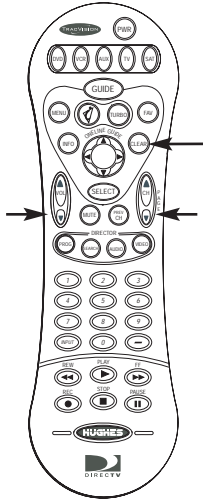

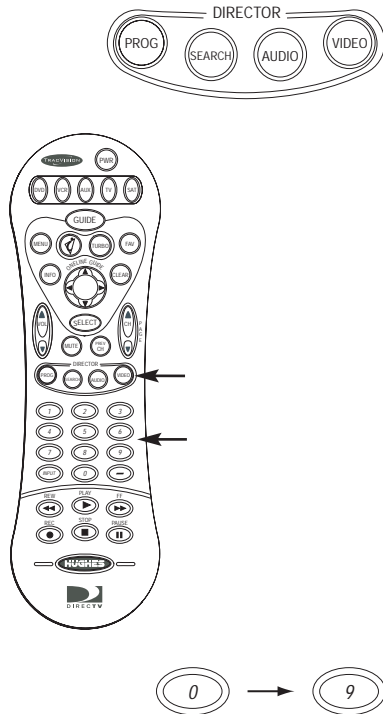

The DIRECTOR buttons provide convenient shortcuts to the following functions:

If the program guide is currently displayed, press the PROG button to use the program director, which allows you to program an event for viewing in advance. See *Section 8-3, "Using the Program Director to Schedule Future Programs,"* on page 8.6 for details.

Press the SEARCH button to bring up the WatchWizard™, which allows you to search for programs using criteria such as rating, showtime, language, and category. See *Section 6-4, "Using WatchWizard to Search for Programs,"* on page 6.9 for details.

Press the AUDIO button to bring up the audio adjustment menu. See *Section 8-1, "Adjusting Audio Settings,"* on page 8.3 for details.

Press the VIDEO button to bring up the video adjustment menu. See *Section 8-2, "Adjusting Video Settings,"* on page 8.5 for details.

Use the numeric keypad buttons (0 - 9) whenever you need to enter a specific number, such as a channel or a lock code.

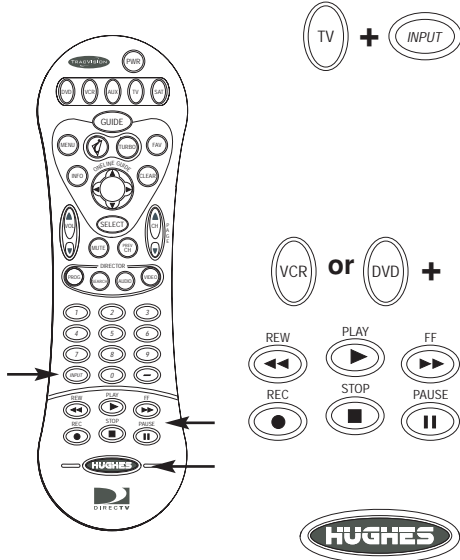

The INPUT button allows you to select a video feed from a different source connected to your TV, such as a VCR (if the TV component button is selected). *The remote control must be programmed to operate your TV for the INPUT button to work (see Section 3-2, "Programming the Remote Control to Operate Other Components," on page 3.9).*

Use the VCR control buttons to operate your VCR or DVD player (the VCR or DVD component button must be selected first). *The remote control must be programmed to operate your VCR/DVD player for the VCR control buttons to work (see Section 3-2, "Programming the Remote Control to Operate Other Components," on page 3.9).*

Press the HUGHES button to turn the remote control's backlight on/off.



If you lose your remote control, please call or visit your local KVH authorized dealer to order a replacement.

3-2 Programming the Remote Control to Operate Other Components

In addition to controlling the mobile receiver, you may be able to operate your TV, VCR, DVD, or AUX components using your TracVision remote control. To program your remote control, follow the steps below.

1. Keep the remote control aimed at the IR input (or “eye”) for the component you want to control. For example, if you want to program the remote control to operate the TV, keep the remote aimed at the TV’s IR input.
2. Press and hold the remote control’s component button (for example, TV).
3. At the same time, press the MUTE button for two seconds.
4. Release both buttons.

The component button should light and remain lit. If it doesn’t remain lit, repeat Steps 1 through 4 above.

5. Repeatedly press the upper part of the CHANNEL (CH) button.
6. Continue pressing the CHANNEL (CH) button to step through the codes until the component turns off, indicating that you have found the correct device code. *If you accidentally pass a code that responds or realize you may not have been aiming the remote control at the component, repeatedly press the lower part of the CHANNEL (CH) button to step backward through the codes.*
7. Press the remote control’s PWR button to verify that you have found the proper code. The correct code will turn the component on and off.
8. Press the component button again to lock in the code (in this example, the TV button).

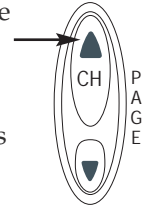

To operate a component, first press the desired component button (DVD, VCR, AUX, TV, or SAT). Then use the remote control buttons that apply to that component. *For example, the VOLUME (VOL) and MUTE buttons apply only to a TV; the VCR control buttons apply only to a VCR or DVD player.*

3-3 Controlling Multiple Receivers

If you are using multiple KVH mobile receivers, you can change a remote control ID to avoid interference or “cross talk” between the two remotes. The remote control ID can be a number from “001” to “008.”

For example, if you have two receivers, you can set one receiver and remote to 001 and the other receiver/remote to 002. That way, the 002 remote cannot operate the 001 receiver, and the 001 remote cannot operate the 002 receiver.



For details on ordering an additional mobile receiver, please call or visit your local KVH authorized dealer/installer.

To set a remote control and receiver to use a different remote ID, follow the steps below.

1. First turn off the receiver(s) you do **not** want to control with the remote you are programming.

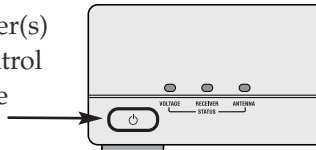

2. Turn on the receiver you want to control with the remote.
3. Press the MENU button to access the main menu.
4. From the main menu, highlight the **System Setup** tab and press SELECT.
5. Highlight the **Remote** tab to access Remote Control Settings.

Remote Control Code Entry

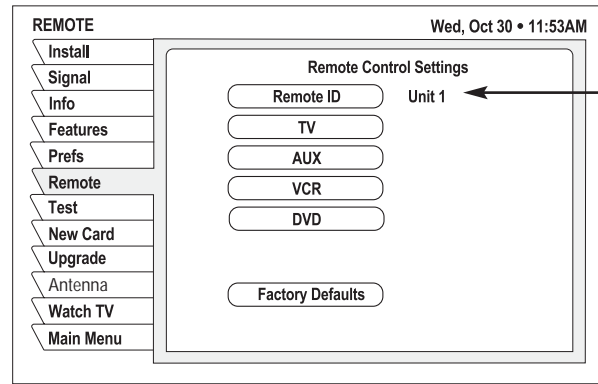

6. Highlight the **Remote ID** button.
7. Press and hold the SAT button.

8. At the same time, press the MUTE button for two seconds.
9. Release both buttons. The SAT button should remain lit. If it doesn't, repeat Steps 7-9.
10. Enter the desired ID number (between "001" and "008") using the numeric keypad.
11. Press the SAT button to lock in the code.
12. Press the SELECT button twice.

The number to the right of the highlighted **Remote ID** button will change to the new code. Check that the ID has been set properly by testing the remote control to ensure that it controls the receiver.

3-4 Installing the Remote Control Batteries

To install or replace the remote control's batteries, follow the steps below.

1. Remove the battery compartment cover, located on the back of the remote control.
2. Insert two AAA batteries as shown, observing the correct polarity.
3. Replace the battery compartment cover.

Remote Control Batteries

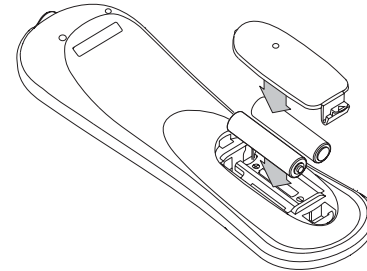

4 Overview of Onscreen Displays

This section introduces the three types of onscreen displays: the Channel Banner, the Program Guide, and the Menu System.

Contents

4-1	The Channel Banner	4.3
4-2	The Program Guide	4.4
4-3	The Menu System	4.5

4-1 The Channel Banner

Whenever you change channels while you are watching TV, the channel banner appears at the top of the screen. You can also display the channel banner by pressing the INFO button while watching TV.

The channel banner displays the following information:

- Currently selected channel and program
- Description of the currently selected program
- Date/time
- Icons may appear below the date/time to indicate system status or details about the program

The channel banner disappears from the screen after a few seconds. Or press the CLEAR button to remove the channel banner immediately.

Channel Banner

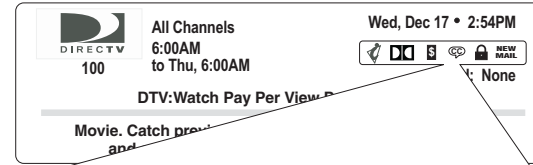

Icon	\$				NEW MAIL			CAN'T TAPE	ALT. AUDIO	DATA SVGS.	FULL DAY	
Meaning	Pay per view	Interactive programming available	Dolby Digital audio available	Closed caption available	Unread mail	Limits enforced	Limits override	Taping not allowed	Other audio available	Data available	All Day Ticket	Letter Box format





4-2 The Program Guide

To display the program guide, press the GUIDE button. You can also access the program guide from the menu system's **Program Guide** tab.

The program guide displays the following information:

- Listing of current programs and up to seven days of future programming
- Short description of the program currently highlighted
- Date/time
- Icons may appear below the date/time to indicate system status or details about the program currently highlighted
- If the picture-in-guide feature is enabled, video of the currently selected channel appears in the upper right corner of the screen

Program Guide

PROGRAM GUIDE		Thu, Feb 7 • 6:00PM	
All Channels		 Picture-in-Guide An image of the currently airing program highlighted in the menu selection appears here.	
Selected Program Description		None • 6:00PM - 7:00PM	
Today	6 PM	6:30	7 PM
			7:30
	Selected Program		Next Scheduled Program
	Alternate Program 1		
	Alternate Program 2		
	Alternate Program 3		Next Scheduled Program

For details on how to use the program guide, see *Section 5, "Using Program Guides,"* on page 5.1.

With favorite channel lists and category filters, you can easily customize the channel guide to show only those channels or programs of interest to you. See *Section 6, "Setting Favorites and Filters,"* on page 6.1 for details.

4-3 The Menu System

To display the main menu, press the MENU button.

The menu system gives you access to all system functions and settings. The common elements of all menus are noted below.

The following icons appear in several menus:



Toggle or Step - Press SELECT to toggle (switch) a setting from “on” to “off” *or* to step through the available choices each time you press SELECT.



List of Options - Menu button will display a list of choices in a pop-up menu when you press SELECT.



Series of Boxes - Multiple screens will appear in a series requesting that you enter numbers and/or letters for the particular feature when you press SELECT.

Main Menu

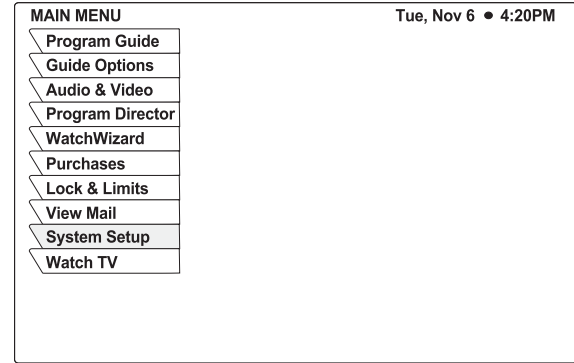

Menu Elements

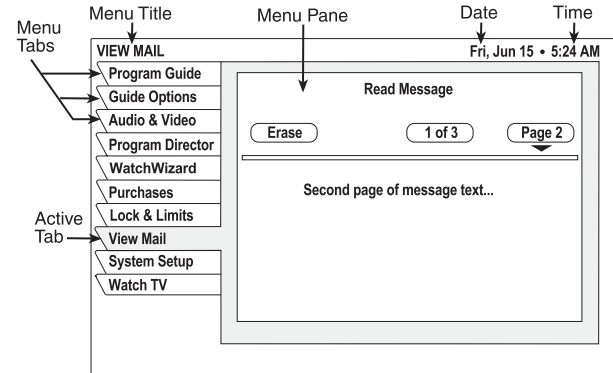

To move the highlight:

Use the joystick to move the highlight within the menus.

To select a menu item:

Highlight the desired menu item and press the SELECT button to select a main menu item or execute an action.

To exit a menu or cancel an action:

Press the CLEAR button to exit a menu or cancel an action.

The following pages list all of the functions accessible from the menu system. These functions are explained in detail in later sections of this manual.



*You will not be able to use the **Purchases** tab. This function requires a phone line connection, which is not possible with TracVision.*

Main Menu Tab	Screens	Functions	See Page:
Program Guide	Program Guide	<ul style="list-style-type: none"> View and modify the program guide 	5.1
Guide Options	Theme	<ul style="list-style-type: none"> Filter the program guide by program category 	6.7
	Times	<ul style="list-style-type: none"> Change the time period shown in the program guide 	6.8
	Fav List	<ul style="list-style-type: none"> Select a specific channel list (Fav. A, Fav. B, Fav. C, Family, or New Channels) to be an active program guide 	6.4
	Fav Setup	<ul style="list-style-type: none"> Create and edit a channel list (Fav. A, Fav. B, Fav. C, Family, or New Channels) 	6.3
	Options	<ul style="list-style-type: none"> Set Guide Options: <ul style="list-style-type: none"> Guide style (grid or logo) Picture in guide (on/off) Guide zoom (on/off) Multi-color (on/off) Channel sort (numeric or alphabetical) Filters (temporary or persistent) 1-line guide (1-4 rows) Reset options to default settings 	5.9
	Set Turbo	<ul style="list-style-type: none"> Set and edit TurboTune channels 	5.7

Main Menu Tab	Screens	Functions	See Page:
Audio & Video	Audio	<ul style="list-style-type: none"> • Set default audio language and alternate audio language • Set left/right audio balance 	8.3
	Video	<ul style="list-style-type: none"> • Select screen ratio (4:3 or 16:9) • Center menus on your monitor (up/down and right/left) • Select color scheme and onscreen display translucency 	8.5
Program Director	Schedule	<ul style="list-style-type: none"> • Automatically tune to programs at a specific date/time 	8.6
WatchWizard	WWSetup	<ul style="list-style-type: none"> • Search for programming using specific words and other criteria 	6.9
	WWResult	<ul style="list-style-type: none"> • Display search results 	6.10
	Channels	<ul style="list-style-type: none"> • Search for channels based on categories of programming 	6.11
Purchases	Upcoming	NOT USED	--
	Past	NOT USED	--
Lock & Limits	Lock	<ul style="list-style-type: none"> • Lock and unlock the system 	7.3
	Fav Setup	<ul style="list-style-type: none"> • Create a program listing containing only selected channels 	6.3
	Ratings	<ul style="list-style-type: none"> • Set maximum program rating allowed for viewing 	7.5
	Limits	<ul style="list-style-type: none"> • Set viewing times and maximum viewing hours 	7.6
View Mail	Mail	<ul style="list-style-type: none"> • Read messages from DIRECTV 	8.8

Main Menu Tab	Screens	Functions	See Page:
System Setup	Install	<ul style="list-style-type: none"> • Change the list of available satellites • Scan the sky for available satellites • Reload the program guide 	8.11
	Signal	<ul style="list-style-type: none"> • View satellite signal strength 	8.11
	Info	<ul style="list-style-type: none"> • Display receiver information 	8.12
	Features	<ul style="list-style-type: none"> • Display current receiver features 	8.12
	Prefs	<ul style="list-style-type: none"> • Adjust user-selectable system settings 	8.9
	Remote	<ul style="list-style-type: none"> • Change the remote ID 	3.10
	Test	<ul style="list-style-type: none"> • Initiate a simple diagnostics test 	8.12
	New Card	<ul style="list-style-type: none"> • Prepare a new access card 	8.12
	Upgrade	<ul style="list-style-type: none"> • Display upgrade status and history 	8.12
	Antenna	<ul style="list-style-type: none"> • View current settings • Turn DewShield on/off (<i>TracVision R6 only</i>) • Turn the beeper on/off • Designate the receiver as primary or secondary • Switch satellites 	9.1

5 Using Program Guides

This section explains how to select a program guide style, use the different guide features, and set guide preferences.

Contents

- 5-1 Program Guide Styles5.3
- 5-2 Using the Program Guide5.5
- 5-3 Using the OneLine Guide5.6
- 5-4 Using TurboTune for Quick Access
to Favorite Channels5.7
- 5-5 Setting Guide Preferences5.9

5-1 Program Guide Styles

You can set up the program guide to present information using either of two styles:

- Grid
- Logo

The following sections explain how to select a style and describe the features of each style.

Selecting a Guide Style

To select a guide style, follow the steps below.

1. Press the GUIDE button twice to display the **Guide Options** menu [or select **Guide Options** from the main menu].



When the program guide is onscreen, simply press the GUIDE button once to display the Guide Options menu.

2. Highlight the **Options** tab.

Selecting a Guide Style

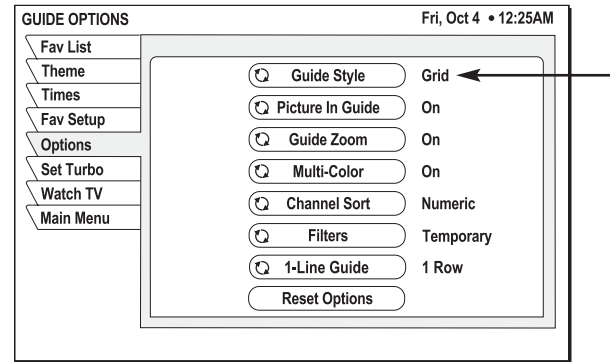





3. Highlight the **Guide Style** button.
4. Press the SELECT button to toggle between **Grid** and **Logo** guide styles.
5. Press the CLEAR button to return to the program you were viewing.

Grid Guide

- Easy to see what programs are available at a particular time.
- Lists up to seven days of current and upcoming programming.
- The program title and description appear above the grid as you highlight each program.





















Grid Guide

PROGRAM GUIDE		Thu, Feb 7 • 6:00PM		
All Channels				
Selected Program Description		Picture-in-Guide		
None • 6:00PM - 7:00PM		An image of the currently airing program highlighted in the menu selection appears here.		
Today	6 PM	6:30	7 PM	7:30
	Selected Program		Next Scheduled Program	
	Alternate Program 1			
	Alternate Program 2			
	Alternate Program 3	Next Scheduled Program		

Logo Guide

- Select your favorite channels, rather than selecting specific programs.
- Only current programming can be selected from the logo guide.
- The current program title and description appear above the logo grid as you highlight each channel.

Logo Guide

LOGO GUIDE		Thu, Feb 7 • 6:00PM		
All Channels				
A description of the program currently airing on the highlighted network menu appears here, if available.		Picture-in-Guide		
An image of the currently airing program highlighted in the menu selection appears here		Title of the program on the network selected in menu		
				
				
				
				

5-2 Using the Program Guide

To display the program guide:

Press the GUIDE button to bring up the guide.

To move the highlight:

Use the joystick to move the highlight within the guide.

Move the highlight to the right to show future programming. Move the highlight up/down to scroll through the listing. Move the highlight onto a channel icon to view that channel's current program in the picture-in-guide window (*if enabled*).

To scroll up/down one page:

Press the CHANNEL (CH) button up/down to scroll through a full page of guide entries at a time.

To jump to a specific channel listing:

Use the numeric keypad to enter the channel number to go directly to the listing for a specific channel.

To view a program's description:

Press the INFO button for a full description of the highlighted program.

To tune to a program:

Press the SELECT button to tune to a highlighted program. *The program must be currently in progress.*

To exit the guide:

Press the CLEAR button to exit the program guide.



Cells with arrows indicate the program started at an earlier time or continues later than can be shown in the selected time period.



If program information cannot entirely fit in the space provided, an ellipsis (...) indicates that a portion of the title is not shown.

5-3 Using the OneLine Guide

The OneLine Guide, which appears at the bottom of your screen, displays a segment of the program guide, starting with the currently viewed channel. It displays 1, 2, 3, or 4 rows at a time, based on the current guide preferences.

OneLine Guide

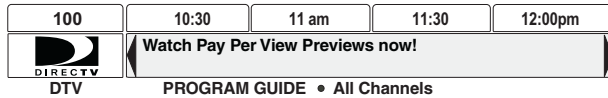

To display the OneLine Guide:

Press the joystick up or down while watching TV to bring up the OneLine guide.

To move the highlight:

Use the joystick to move the highlight within the guide.

Move the highlight to the right to show future programming. Move the highlight up/down to display the next or previous channel.

To show the OneLine Guide for a specific channel:

Use the numeric keypad to enter the channel number to display the OneLine Guide for that channel.

To view a program's description:

Press the INFO button to display current or future program information in the channel banner.

To tune to a program:

Press the SELECT button to tune to a highlighted program.

To exit the guide:

Press the CLEAR button to exit the OneLine guide.

5-4 Using TurboTune for Quick Access to Favorite Channels

The TurboTune feature gives you quick access to 27 of your favorite channels. Three groups of nine of your favorite channels are available as Turbo 1, Turbo 2, and Turbo 3.

Setting TurboTune Channels

To set up channels in TurboTune, follow the steps below.

1. Press the TURBO button, then highlight the **Setup** button and press SELECT [or select **Guide Options** from the main menu, then highlight the **Set Turbo** tab].

TurboTune Guide

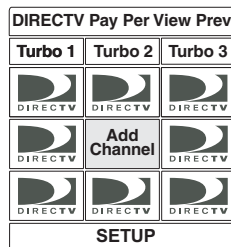

2. Highlight a vacant channel box (shows “Add Channel”) and press SELECT. *Or you can highlight an occupied box instead to overwrite its set channel with your new selection.*
3. Using the joystick or the CHANNEL (CH) button, choose the desired channel in the setup box (shown below) and press SELECT. *You can also use the numeric remote control buttons to enter a specific channel number.*

Adding a Channel to TurboTune

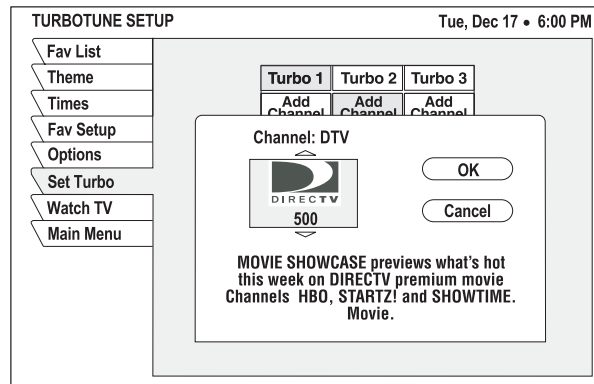









4. Highlight the **OK** button and press SELECT.

Adding the Current Channel to TurboTune

If you want to add the channel you're currently watching to TurboTune, follow the steps below.

1. Press the TURBO button to display the TurboTune guide.

TurboTune Guide

DIRECTV Pay Per View Prev		
Turbo 1	Turbo 2	Turbo 3
		
	Add Channel	
		
SETUP		

2. Highlight a vacant channel box (shows "Add Channel") and press SELECT to add the channel you are watching to the TurboTune guide.

Selecting a Channel from TurboTune

To tune to a channel in TurboTune, follow the steps below.

1. Press the TURBO button.



Press the TURBO button to cycle through Turbo 1, Turbo 2, and Turbo 3 program groups while the TurboTune guide is onscreen.

2. Highlight the channel you want to watch and press SELECT.

Renaming TurboTune Groups

You can rename each nine-channel TurboTune group to anything you choose, using up to 10 letters, numbers, spaces, etc. For example, Turbo 1 could be renamed “Mom” and Turbo 2 renamed “Dad.”

To rename a group, follow the steps below.

1. Press the TURBO button [*or* select **Guide Options** from the main menu and highlight the **Set Turbo** tab].
2. Highlight the grid name (**Turbo 1**, **Turbo 2**, or **Turbo 3**) that you want to rename and press SELECT.
3. Use the onscreen keyboard to enter the new name (to enter a letter on the keyboard, highlight the letter and press SELECT).
4. Once you’ve entered the desired name, highlight the **OK** button and press SELECT.

*To redo the entry, highlight the **Clear** button and press SELECT. To cancel the change, press the **CLEAR** button [*or* highlight the **Cancel** button and press SELECT].*

5-5 Setting Guide Preferences

The Guide Options menu allows you to customize the appearance and behavior of onscreen guides.

To set guide preferences, follow the steps below.

1. Press the GUIDE button twice while watching a program [*or* select the **Guide Options** tab from the main menu].
2. Highlight the **Options** tab.

Guide Options

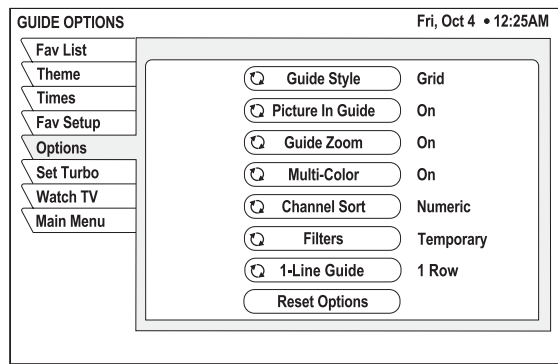

3. Highlight the menu button for the setting you wish to modify:

Guide Style

Press SELECT to choose either **grid** or **logo** style of program guide. See *Section 5-1, "Program Guide Styles,"* on page 5.3 for details.

Picture In Guide

Press SELECT to turn the picture-in-guide feature on/off. If turned on, video of the currently selected program appears in a small box when you're viewing the program guide.

Guide Zoom

Press SELECT to turn guide zoom on/off. If turned on, and the picture-in-guide feature is turned on, video of the currently selected program "zooms in" to the small screen when the program guide is selected. If turned off, the "zooming" animation from full screen to small screen is disabled.

Multi-Color

Press SELECT to turn multi-color on/off. If turned on, program cells appear in different colors, based on their type of content. The four colors are as follows:

Color	Category
Orange	News
Green	Sports
Purple	Movies
Blue	Other

If multi-color is turned off, all cells are blue in color.

Channel Sort

Press SELECT to choose either **numeric** or **alpha**. If numeric, the program guide is sorted by channel number. If alpha, the program guide channels are sorted alphabetically.

Filters

Press SELECT to choose either **temporary** or **persistent**. If temporary, the filters you apply are active only while the program guide remains onscreen; once you exit the program guide, all filters are cleared. If persistent, the filters you apply remain active after you exit the program guide.

1-Line Guide

Press SELECT to choose the number of rows that will display whenever you select the OneLine guide. You can choose from 1 to 4 rows.

6 Setting Favorites and Filters

This section explains how to set up lists of favorite channels, filter the program guide by category and time, and search for programs based on content.

Contents

6-1	Using Favorite Channel Lists6.3
6-2	Filtering the Program Guide6.7
6-3	Selecting Guide Times6.8
6-4	Using WatchWizard to Search for Programs6.9

6-1 Using Favorite Channel Lists

Favorite channel lists help you organize the hundreds of available channels into more manageable groups. Each of the four lists can contain as many or as few channels as you wish. You can customize these groups in several ways. For example, Fav. A could be Dad's favorite channels, Fav. B could be Mom's favorites, Fav. C could be the kids' channels, and Family could be all channels that Mom and Dad have deemed appropriate for the entire family.

Creating a Channel List

1. Press the MENU button to access the main menu.
2. Highlight the **Guide Options** or **Lock & Limits** tab from the main menu and press SELECT.
3. Highlight the **Fav Setup** tab and press SELECT to open the Favorite List Setup pane.

Favorite List Setup

Fri, Sep 18 • 6:00 PM

FAVORITE LIST SETUP

Fav List

Theme

Times

Fav Setup

Options

Set Turbo

Watch TV

Main Menu

List: MYLIST

Channel	↑	↓	←	→	
120 • WABC	<input checked="" type="checkbox"/>	<input type="checkbox"/>	<input type="checkbox"/>	<input checked="" type="checkbox"/>	Auto Set
121 • WQED	<input checked="" type="checkbox"/>	<input type="checkbox"/>	<input type="checkbox"/>	<input checked="" type="checkbox"/>	Rename
122 • ESPN	<input type="checkbox"/>	<input type="checkbox"/>	<input type="checkbox"/>	<input checked="" type="checkbox"/>	Add All
123 • HBOW	<input checked="" type="checkbox"/>	<input type="checkbox"/>	<input type="checkbox"/>	<input checked="" type="checkbox"/>	Delete All
New Channels	26				New Chan

Quality entertainment for the whole family, featuring animated XYZ classics, original series, entertainment specials, and movies. Included at no additional charge in DIRECTV TOTAL CHOICE Packages.

The four columns of small boxes are called tag boxes. The first three columns of tag boxes are the Fav. A, Fav. B, and Fav. C. channel lists. The last column is the Family list.

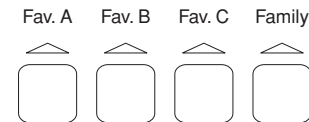



If the Family list has not had any channels added to it, and the receiver is locked, no channels can be viewed without first unlocking the receiver. To avoid this inconvenience, create the Family list before locking the receiver. See Section 7, "Using Access Controls," on page 7.1 for details about controlling system access.

4. In the desired channel list column, highlight the tag box for the channel that you want to add or remove. *Use the joystick or CHANNEL (CH) button to scroll up or down to view other channels.*
5. Press SELECT to add or remove the check mark in the tag box. A check mark indicates that the channel is included in the favorite channel list. (In the example on the previous page, WABC is included in the Fav. A and Family channel lists, but not the Fav. B or Fav. C channel lists.)
6. When you have added all of the channels that you want in your list, press the CLEAR button to resume watching TV.

Switching Between Favorite Lists

Once you have created your favorite channel lists, use the remote control's FAV button to cycle through them quickly and easily. Each press of the FAV button brings up the next favorite channel list. [You can also select a list by highlighting the **Fav List** tab from the Guide Options menu.] Only channels that are set up in the selected favorite channel list will be accessible for viewing.

Favorite Lists

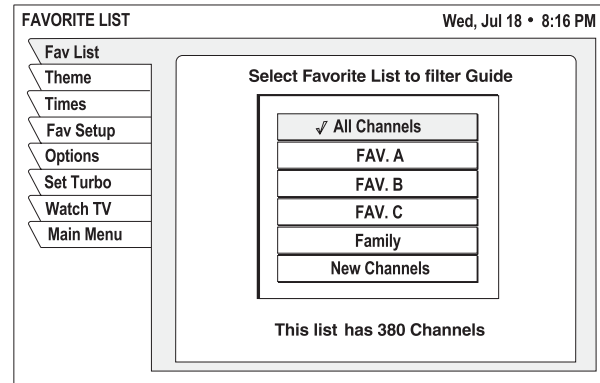

Renaming a Channel List

1. At the Favorite List Setup pane, highlight the **Rename** button and press SELECT.

A Rename List menu appears. You can rename the first three lists. You cannot rename the All or Family lists.
2. Highlight the list you wish to rename and press SELECT.
3. Use the onscreen keyboard to enter the new name (to enter a letter on the keyboard, highlight the letter and press SELECT).
4. Once you've entered the desired name, highlight the **OK** button and press SELECT.

*To redo the entry, highlight the **Clear** button and press SELECT. To cancel the change, press the **CLEAR** button [or highlight the **Cancel** button and press SELECT].*

Generating an Auto Set List

The Auto Set function generates a complete list of viewable channels.



Auto Set may exclude some channels, such as the Music Choice channels, or include some pay per view channels. This does not mean that the receiver is faulty. These channels were excluded or included due to the receiver's analysis process. You can manually edit the list to correct these oversights.

To generate an Auto Set list, follow the steps below.

1. At the Favorite List Setup pane, highlight the **Auto Set** button and press SELECT.
2. Highlight a favorite channel list to be programmed and press SELECT.

It may take several minutes for the receiver to scan through all channels and determine which ones you're authorized to receive. The scan results will be stored in the selected favorite channel list.

Adding and Removing Channels

To add or delete a channel from a selected favorite channel list, follow the steps below.

To add all available channels to a favorite list:

1. At the Favorite List Setup pane, highlight the **Add All** button and press SELECT.
2. Highlight the list you wish to modify and press SELECT.

To remove all channels from a favorite list:

1. At the Favorite List Setup pane, highlight the **Delete All** button and press SELECT.
2. Highlight the list you wish to modify and press SELECT.

To add or delete individual channels from a favorite list:

At the Favorite List Setup pane, highlight the tag box for the particular channel you wish to add or remove and press SELECT. A check mark indicates that the channel is included in the selected favorite channel list. An empty tag box indicates that the channel is excluded from the list.

Finding New Channels

Occasionally, new channels are added to the available programming selections. The number of channels that have been added since you created your channel list appears in the New Channels window on the Favorite List Setup pane. To view these channels in the lists, highlight the **New Channels** button and press SELECT.

Favorite List Setup

Fri, Sep 18 • 6:00 PM

<ul style="list-style-type: none"> Fav List Theme Times Fav Setup Options Set Turbo Watch TV Main Menu 	<table style="width: 100%; border-collapse: collapse;"> <thead> <tr> <th style="text-align: left;">Channel</th> <th style="text-align: left;">List: MYLIST</th> <th></th> </tr> </thead> <tbody> <tr> <td>120 • WABC</td> <td><input checked="" type="checkbox"/> <input type="checkbox"/> <input type="checkbox"/> <input checked="" type="checkbox"/></td> <td><input type="button" value="Auto Set"/></td> </tr> <tr> <td>121 • WQED</td> <td><input checked="" type="checkbox"/> <input type="checkbox"/> <input type="checkbox"/> <input checked="" type="checkbox"/></td> <td><input type="button" value="Rename"/></td> </tr> <tr> <td>122 • ESPN</td> <td><input type="checkbox"/> <input type="checkbox"/> <input type="checkbox"/> <input checked="" type="checkbox"/></td> <td><input type="button" value="Add All"/></td> </tr> <tr> <td>123 • HBOW</td> <td><input checked="" type="checkbox"/> <input type="checkbox"/> <input type="checkbox"/> <input checked="" type="checkbox"/></td> <td><input type="button" value="Delete All"/></td> </tr> <tr> <td>New Channels</td> <td><input type="text" value="26"/></td> <td><input type="button" value="New Chan"/></td> </tr> </tbody> </table> <p style="font-size: small; margin-top: 10px;">Quality entertainment for the whole family, featuring animated XYZ classics, original series, entertainment specials, and movies. Included at no additional charge in DIRECTV TOTAL CHOICE Packages.</p>	Channel	List: MYLIST		120 • WABC	<input checked="" type="checkbox"/> <input type="checkbox"/> <input type="checkbox"/> <input checked="" type="checkbox"/>	<input type="button" value="Auto Set"/>	121 • WQED	<input checked="" type="checkbox"/> <input type="checkbox"/> <input type="checkbox"/> <input checked="" type="checkbox"/>	<input type="button" value="Rename"/>	122 • ESPN	<input type="checkbox"/> <input type="checkbox"/> <input type="checkbox"/> <input checked="" type="checkbox"/>	<input type="button" value="Add All"/>	123 • HBOW	<input checked="" type="checkbox"/> <input type="checkbox"/> <input type="checkbox"/> <input checked="" type="checkbox"/>	<input type="button" value="Delete All"/>	New Channels	<input type="text" value="26"/>	<input type="button" value="New Chan"/>
Channel	List: MYLIST																		
120 • WABC	<input checked="" type="checkbox"/> <input type="checkbox"/> <input type="checkbox"/> <input checked="" type="checkbox"/>	<input type="button" value="Auto Set"/>																	
121 • WQED	<input checked="" type="checkbox"/> <input type="checkbox"/> <input type="checkbox"/> <input checked="" type="checkbox"/>	<input type="button" value="Rename"/>																	
122 • ESPN	<input type="checkbox"/> <input type="checkbox"/> <input type="checkbox"/> <input checked="" type="checkbox"/>	<input type="button" value="Add All"/>																	
123 • HBOW	<input checked="" type="checkbox"/> <input type="checkbox"/> <input type="checkbox"/> <input checked="" type="checkbox"/>	<input type="button" value="Delete All"/>																	
New Channels	<input type="text" value="26"/>	<input type="button" value="New Chan"/>																	

6-2 Filtering the Program Guide

The Category Filter menu allows you to filter the program guide to show just those channels that match your viewing interests.

To filter the guide by program categories, such as movies, sports, or news, follow the steps below.

1. Press the **GUIDE** button twice while watching TV [or select the **Guide Options** tab from the main menu]. *If the Program Guide is currently displayed, press the **GUIDE** button just once.*
2. Highlight the **Theme** tab.
3. Highlight a category (other than **All**) and press **SELECT**.
4. A subcategory menu appears, allowing you to further refine a chosen theme. To choose a subcategory, highlight the subcategory and press **SELECT**.

For example, if you select the **Movies** category, you can refine your selection using a subcategory such as **Action/Adventure**.

Category Filter

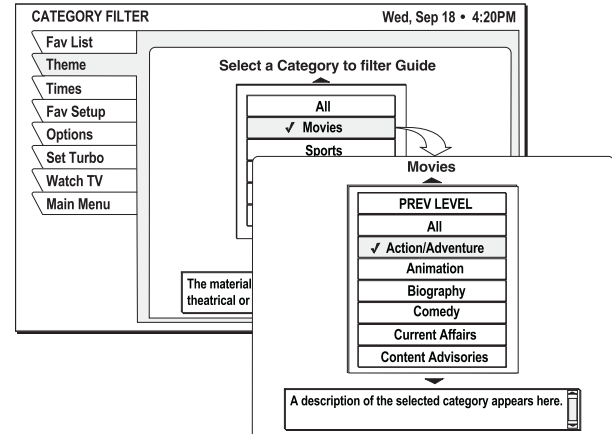

Once you've selected a category/subcategory, the program guide will be filtered to show only those channels offering programs of the selected category and subcategory. In this example, the guide would only display channels featuring **Action/Adventure** movies.

6-3 Selecting Guide Times

The Guide Times menu provides easy access to future programming information.

To advance the guide to a future day/time period, follow the steps below.

1. Press the GUIDE button twice while watching TV [or select the **Guide Options** tab from the main menu]. *If the Program Guide is currently displayed, press the GUIDE button just once.*
2. Highlight the **Times** tab.
3. Highlight the **AM/PM** button and press SELECT to toggle between **AM** and **PM**.
4. Highlight the day you want the guide to begin and press SELECT.

Guide Times

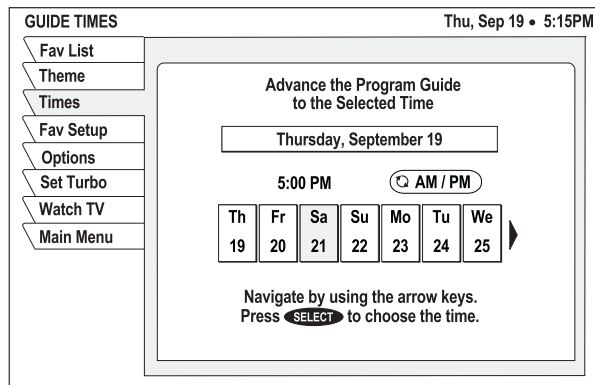

6-4 Using WatchWizard to Search for Programs

WatchWizard allows you to search for programs using criteria such as rating, showtime, language, and category. You can even search for a specific word found in program titles or descriptions. WatchWizard can store up to eight separate searches using any combination of criteria and text.

Performing a Search

1. Press the SEARCH button [or select the WatchWizard tab from the main menu].
2. Highlight the WWSetup tab.
3. Highlight one of the eight search buttons and press SELECT.
4. A search menu appears where you can enter your search criteria. Narrow your search results by combining multiple criteria. To choose a criteria, highlight the associated button and press SELECT.

WatchWizard Program Searches

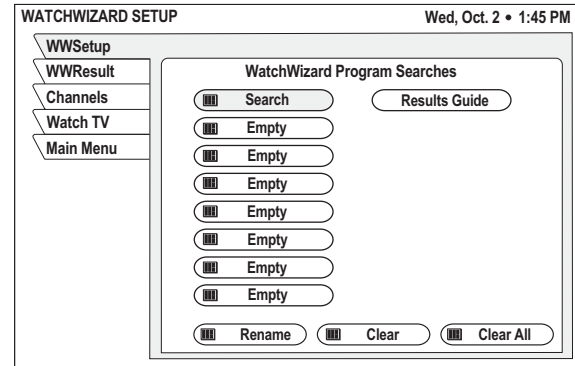

WatchWizard Search Menu

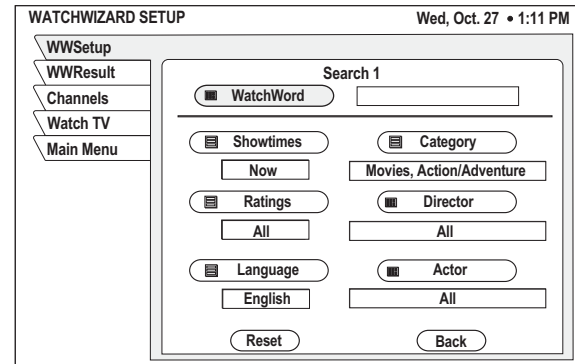

To enter text, use the onscreen keyboard (to enter a letter on the keyboard, highlight the letter and press SELECT). Once you've entered the desired text, highlight the **OK** button and press SELECT.

WatchWizard Keyboard Entry

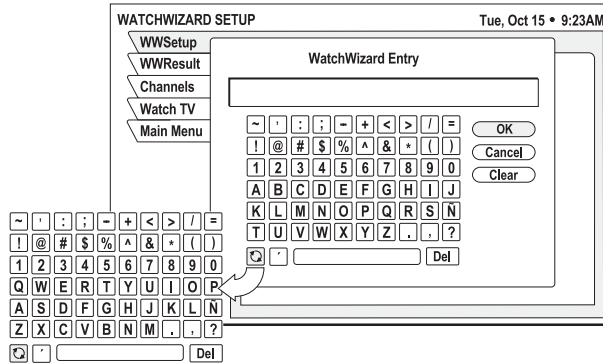

If you prefer, you can change the keyboard to a standard (QWERTY) layout. Simply highlight the toggle icon ☒ on the default button board and press SELECT.

Viewing Search Results

To view a list of programs matching your search criteria, highlight the **WWResult** tab. To view the search results as a guide, highlight the **Results Guide** button on the **WWSetup** tab and press SELECT.

WatchWizard Results

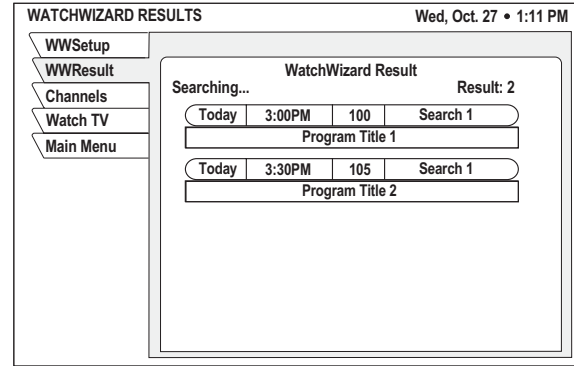

When a program guide is onscreen, press the **SEARCH** button on the remote control to automatically highlight programs matching your search results. Press the **SEARCH** button again to highlight the next result, based on starting time.

Using the Channels Search

You can also search for channels that offer a specific type of programming by using the category-based channels search.

1. Press the SEARCH button while watching TV [*or* select the **WatchWizard** tab from the main menu].
2. Highlight the **Channels** tab.
3. Highlight the **Category** button and press SELECT.
4. Highlight the desired category from the list and press SELECT.
5. A subcategory menu appears, allowing you to further refine your search. To choose a subcategory, highlight the subcategory and press SELECT. A list of channels offering the selected type of programming appears.

Channels Search

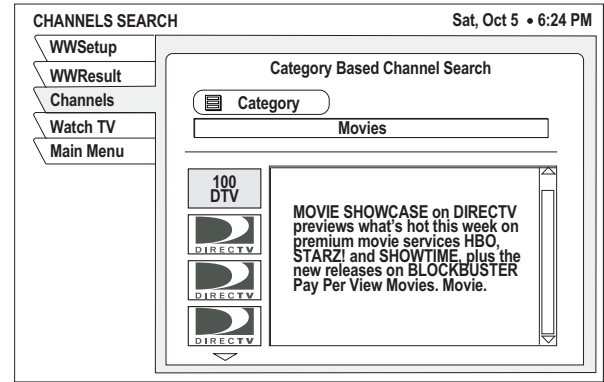

7 Using Access Controls

This section explains how to lock and unlock the system using a passcode. It also explains how to set rating and time limits.

Contents

7-1	Locking & Unlocking the System	7.3
7-2	Setting Ratings Limits	7.5
7-3	Setting Time Limits	7.6

7-1 Locking & Unlocking the System

You can easily set limits to restrict the viewing of satellite TV programming. When accompanied by the channel lists, these limits provide a great degree of control.

When you first install the mobile receiver, it will be unlocked. That is, no limits or restrictions are in effect. To enforce limits (ratings, TV timer, and “Family” favorite list), you must lock the system using a passcode.



Once the system is locked, only existing Family list channels will be accessible. If the Family list does not contain any channels, no channels can be viewed without first unlocking the system. To avoid this, verify the contents of the Family list before locking the receiver. See Section 6-1, “Using Favorite Channel Lists,” on page 6.3 for details.

Locking the Receiver

To lock the system, follow the steps below.

1. Press the MENU button to access the main menu.
2. Highlight the **Lock & Limits** tab and press SELECT.
3. Highlight the **Lock** tab to display the Parental Lock pane.
4. Highlight the **Lock** button and press SELECT.

Parental Lock

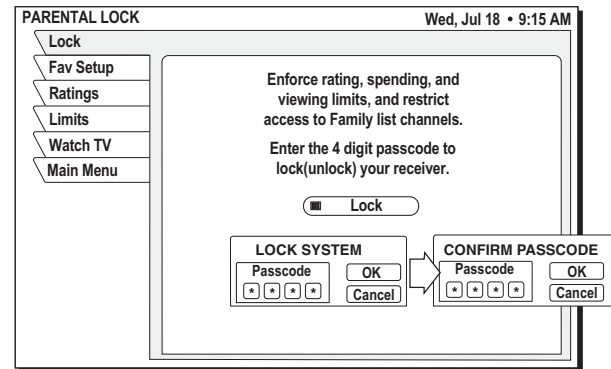

5. The Lock System pop-up panel appears. Enter a four-digit passcode using the remote control's numeric keypad.
6. Highlight the **OK** button and press SELECT.



*To abort the locking process, highlight the **Cancel** button and press SELECT.*

7. Enter the code again to confirm, then highlight the **OK** button and press SELECT.

Once you select OK, the mobile receiver is locked. You must enter the proper passcode to unlock it. A lock icon appears in the program guide and channel banner to remind you that the system is locked.



If you forget your four-digit code, please call DIRECTV at 1-800-DIRECTV (347-3288).

Overriding the System Lock

When the system is locked, inaccessible channels will show a "limit exceeded" message. To temporarily override the system lock, follow the steps below.

1. While the "limit exceeded" message is onscreen, press SELECT.
2. Enter your four-digit passcode using the remote control's numeric keypad.
3. Highlight the **OK** button and press SELECT.

An icon indicating lock override appears under the date/time whenever the program guide or channel banner is displayed.



Unlocking the System

To remove the lock and all of its restrictions, follow the steps below.

1. Press the MENU button to access the main menu.
2. Highlight the **Lock & Limits** tab and press SELECT.
3. Highlight the **Lock** tab.
4. Highlight the **Unlock** button and press SELECT.



The button used to lock the system is also used to unlock the system.

5. Use the remote control's numeric keypad to enter the same code you entered to lock the system.
6. Highlight the **OK** button and press SELECT. *To abort and keep the lock in effect, highlight the **Cancel** button and press SELECT.*

Once the system is unlocked, all limits and restrictions are removed!

7-2 Setting Ratings Limits

Ratings help you to determine whether a program's content is appropriate for a particular audience. To select the maximum ratings limits that can be viewed on your system, follow the steps below.

1. Press the MENU button to access the main menu.
2. Highlight the **Lock & Limits** tab and press SELECT.
3. Highlight the **Ratings** tab.

Ratings Limits Setup

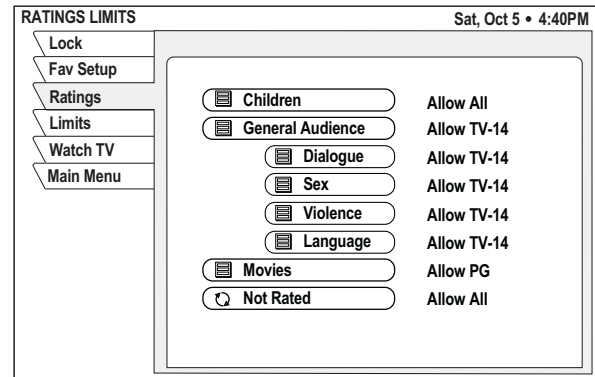

4. Highlight the button for the type of programming you want to restrict and press SELECT.
5. Highlight the maximum rating you want to allow (for the selected type of programming) from the pop-up submenu and press SELECT. *You may choose **Block All** or **Allow All** instead of setting a specific limit.*

Ratings Limits

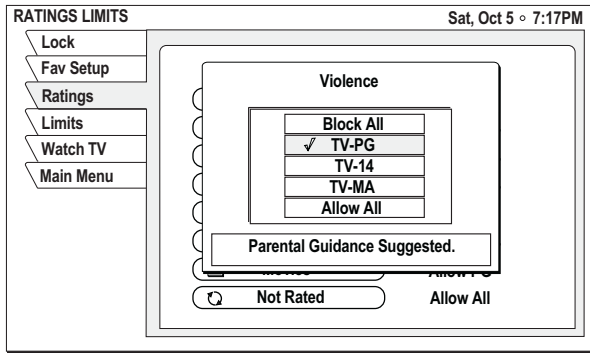

Remember, limits are only active while the system is locked. If the system is unlocked, all restrictions are removed.

7-3 Setting Time Limits

You can restrict your system to allow viewing only during specific hours and/or a maximum number of hours. To set time limits, follow the steps below.

1. Press the MENU button to access the main menu.
2. Highlight the **Lock & Limits** tab and press SELECT.
3. Highlight the **Limits** tab.

Maximum Viewing Limits

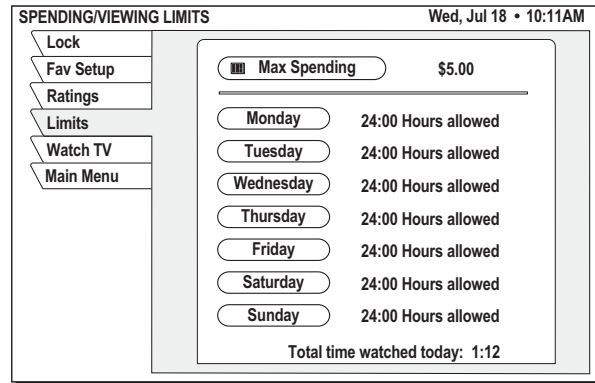



The **Max Spending** button is not applicable to your TracVision system.

4. Highlight the day of the week that you want to limit and press SELECT.
5. a. If you want to limit the maximum number of viewing hours for that day, highlight the **Total Time** button and use the remote control's numeric keypad to enter the limit.

Setting Maximum Viewing Hours

SPENDING / VIEWING LIMITS Wed, May 9 • 4:50 PM

Lock
Fav Lists
Ratings
Limits

Max Spending \$10.00

Saturday Viewing Time Limit

From N/A Through N/A -OR- Total time 18:00 OK Cancel

Thursday 24:00 Hours allowed
Friday 24:00 Hours allowed
Saturday 18:00 Hours allowed
Sunday 24:00 Hours allowed

- b. If you want to limit that day's viewing to a specific time period, highlight the **From** button and use the remote control's numeric keypad to set the earliest time. Then highlight the **Through** button and set the latest time.

Setting Allowable Viewing Times

SPENDING / VIEWING LIMITS Wed, May 9 • 4:50 PM

Lock
Fav Lists
Ratings
Limits

Max Spending \$10.00

Saturday Viewing Time Limit

From 10:00 AM Through 11:30 PM -OR- Total time N/A OK Cancel

Thursday 24:00 Hours allowed
Friday 24:00 Hours allowed
Saturday 9:30 Hours allowed
Sunday 24:00 Hours allowed

6. Highlight the **OK** button and press SELECT.



Remember, limits are only active while the system is locked. If the system is unlocked, all restrictions are removed.

8 Other Menu Functions

This section explains how to change audio/video settings, schedule future programs, and change system settings.

Contents

8-1	Adjusting Audio Settings8.3
8-2	Adjusting Video Settings8.5
8-3	Using the Program Director to Schedule Future Programs8.6
8-4	Reading Mail from DIRECTV8.8
8-5	Setting System Preferences8.9
8-6	Advanced System Setup Functions8.11

8-1 Adjusting Audio Settings

From the Audio Adjustment menu, you can select languages for default audio and alternate audio. You can also adjust the left/right balance.

To set audio preferences, follow the steps below.

1. Press the AUDIO button [or select the **Audio & Video** tab from the main menu].

Audio Adjustment

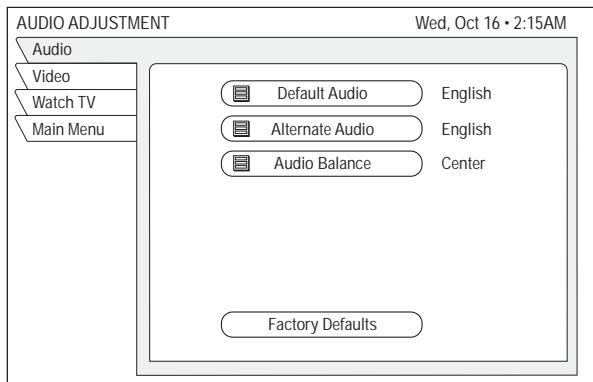

2. Highlight the menu button for the setting you wish to modify:

Default Audio and Alternate Audio

Your receiver supports alternate audio services. A **ALT-AUDIO** icon appears below the date and time in a program's description to indicate alternate audio is available for that particular program.

You will hear the default audio language all the time if that language is being transmitted and an alternate language has not been activated. If your selected default language is not being transmitted for a program, you will hear the language in which the program is broadcast.



Occasionally, an audio track may be offered that is not being broadcast, in which case the audio will not change or you will not hear any audio. Change channels to restore the audio track to the one specified on the Audio Adjustment menu.

To set up your default and alternate audio languages, follow the steps below.

1. Press the AUDIO button to access the Audio Adjustment menu.
2. Highlight the **Default Audio** button (to set your primary language preference) or the **Alternate Audio** button (to select your alternate language preference) and press SELECT.
3. Highlight the desired language for the default or alternate language and press SELECT.

Selecting Default Audio Language

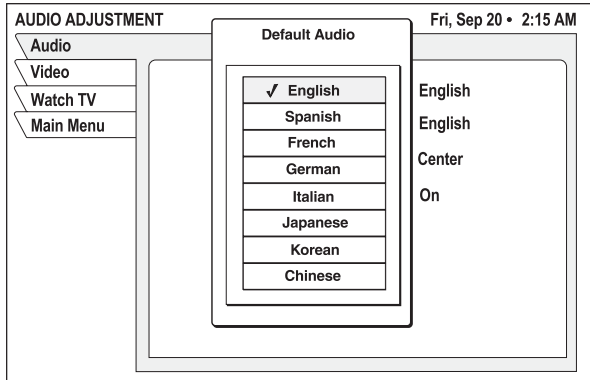

To select the alternate audio when watching TV, follow the steps below.

1. If the **ALT. AUDIO** icon appears below the date and time in a program's description, press the joystick left or right while you are viewing that program.
2. An alternate language option based on your alternate audio selection appears. Press SELECT to listen to the program in the alternate language.

When you change the channel, audio will revert to your selected Default Audio language.

Audio Balance

To adjust the audio balance left or right, highlight the **Audio Balance** button and press SELECT. Use the joystick to adjust the balance, then highlight the **Done** button and press SELECT.

8-2 Adjusting Video Settings

From the Video Adjustment menu, you can set the screen's aspect ratio and change the appearance of onscreen displays.

To set video preferences, follow the steps below.

1. Press the VIDEO button [*or* select the **Audio & Video** tab from the main menu].

Video Adjustments

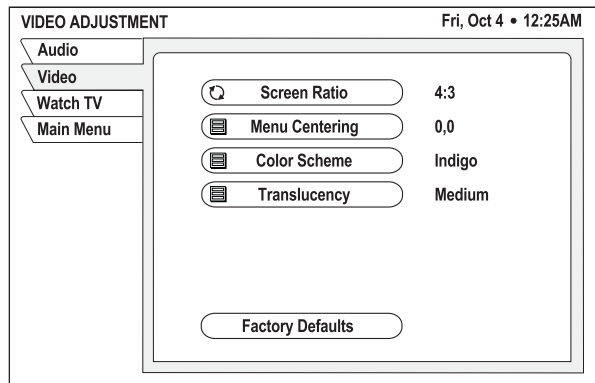

2. Highlight the menu button for the setting you wish to modify:

Screen Ratio

Press SELECT to choose either a **4:3** (standard) or **16:9** (widescreen) screen aspect ratio.

Menu Centering

Press SELECT to bring up the centering pop-up panel. Use the joystick to adjust the onscreen menu position on your TV, then highlight the **OK** button and press SELECT.

Color Scheme

Press SELECT to bring up a color pop-up menu. Highlight the desired menu color scheme (**Indigo**, **Ice**, **Sky**, **Forest**, or **Merlot**) and press SELECT.

Translucency

Press SELECT to bring up the translucency pop-up menu. Use the joystick to adjust the amount of menu translucency, from solid to 100% translucent, then highlight the **DONE** button and press SELECT.

8-3 Using the Program Director to Schedule Future Programs

The Program Director allows you to automatically tune to a program at a specific date and time, or tune to a program on a repeating basis. The receiver will turn on (if necessary) and tune to the specified channel at the chosen date and time. You can program up to 32 events in advance.

Scheduling an Event from the Program Guide

You can easily schedule an upcoming program that you find listed in the program guide. Simply highlight the upcoming program in the program guide and press SELECT. A check mark appears next to your selection. At the start date/time of the scheduled program, the receiver will automatically tune to that program.



From the program guide, you can schedule a program only for a specific date and time. To schedule recurring programs and future programs not yet listed on the program guide, use the Program Director menu.

Scheduling an Event from the Program Director

To schedule a program from the Program Director menu, follow the steps below.

1. Press the MENU button to access the main menu.
2. Highlight the **Program Director** tab and press SELECT.

Program Director

The screenshot shows the 'PROGRAM DIRECTOR' menu with the following elements:

- Top bar: PROGRAM DIRECTOR (left), Wed, Oct 2 • 7:14PM (right)
- Left sidebar menu: Schedule, Watch TV, Main Menu
- Main content area: Add and Modify Scheduled Events
- Table header: Chan, Start, Length, Frequency
- Table body: One empty row with four columns for data entry.

3. Highlight an empty slot and press SELECT.

- Highlight the **Schedule to View** button from the Schedule Options pop-up menu and press SELECT.

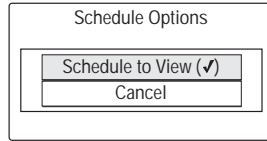

- Use the joystick or numeric keypad to choose the desired channel from the channel selection pane. Then highlight the **OK** button and press SELECT.

Channel Selection Pane

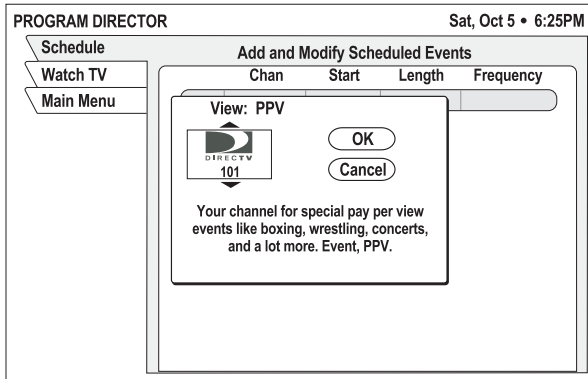

- Highlight the **Start** column and use the joystick or numeric keypad to set the program's start time. Be sure to specify **AM** or **PM** (or **N** for noon, **M** for midnight if you specified 12:00).
- Highlight the **Duration** column and use the joystick or numeric keypad to set the program's duration in hours and minutes.
- Highlight the **Frequency** column and use the joystick to select when, or how often, the event occurs: Today, Tomorrow, Every Mon, Every Tue, Every Wed, Every Thu, Every Fri, Every Sat, Every Sun, Everyday, Mon-Fri, or "/" (specify a date).



If you specify a date, use the month/day format. The year is set automatically.

- Review your settings, then highlight the **OK** button and press SELECT. To abort, highlight the **Cancel** button and press SELECT.

Deleting a Scheduled Event

To cancel a scheduled event, follow the steps below.

1. Press the MENU button to access the main menu.
2. Highlight the **Program Director** tab and press SELECT.
3. Highlight the event you want to cancel and press SELECT.
4. Highlight the **Delete Event** button from the Schedule Options pop-up menu and press SELECT.



If the program you want to cancel is a one-time program that's not currently in progress, you can cancel the event from the program guide. Simply highlight the program you want to cancel in the program guide and press SELECT to remove the check mark.

8-4 Reading Mail from DIRECTV

DIRECTV uses the Mail feature to send you important information, notify you of special events, and tell you about special offers. When you receive a new message, a **NEW MAIL** icon appears at the top of all menus until you've read the message.

Reading Your Messages

To read your mail, follow the steps below.

1. Press the MENU button to access the main menu.
2. Highlight the **View Mail** tab and press SELECT.
3. If the message is longer than a single page, highlight the **Page** button and use the CHANNEL (CH) button to step through the pages.
4. If you have more than one message in your mailbox, highlight the **Message** button and use the joystick to navigate through multiple messages.

View Mail

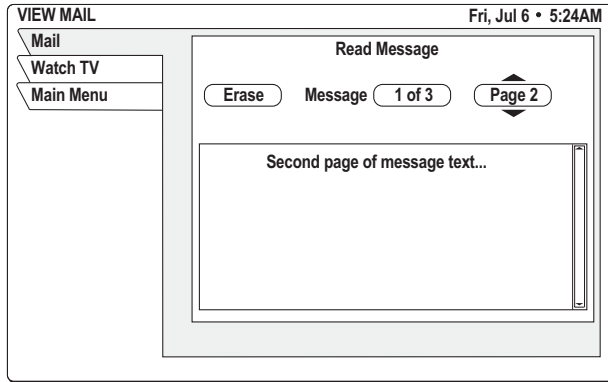

Erasing a Message

To permanently remove a message, highlight the **Erase** button and press SELECT. *Messages are automatically deleted as they become outdated or if space is needed for newer incoming messages.*



Once you erase a message, it cannot be retrieved.

8-5 Setting System Preferences

The Preferences menu allows you to customize various system settings.

To set system preferences, follow the steps below.

1. Press the MENU button to access the main menu.
2. Highlight the **System Setup** tab and press SELECT.
3. Highlight the **Prefs** tab.

Preferences

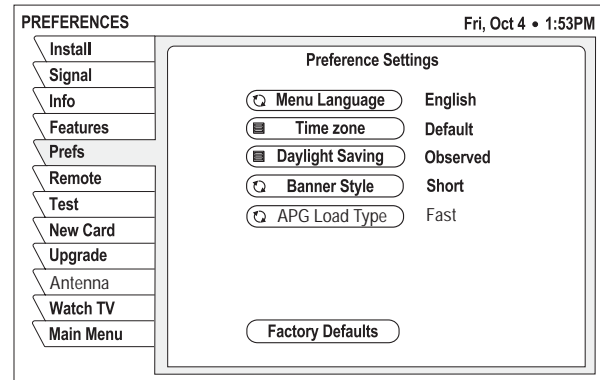

4. Highlight the menu button for the setting you wish to modify:

Menu Language

Press SELECT to choose either **English** (default) or **Spanish** for the menu language. The text in all onscreen menus will be shown in the selected language.

Time Zone

Press SELECT to bring up the time zone pop-up menu. Then highlight your time zone and press SELECT. The program guide will show programming times based on this time zone. The default setting is the time zone used on your account.

Daylight Saving

Press SELECT to bring up the Daylight Saving pop-up menu. Then highlight the desired daylight saving option (**Observed**, **Not Observed**, or **Default**) and press SELECT.

Banner Style

Press SELECT to choose either a **Short** or **Full** banner style. A full banner always shows the program description within the channel banner; a short banner shows just the program's title.



*When you press the INFO button while watching TV, a **full** channel banner is displayed, regardless of the Banner Style setting.*

APG Load Type

Press SELECT to choose either a **Fast** or **Full** program guide load. With fast load selected, you should see a picture on the TV within 15 seconds after startup. With full load selected, you might have to wait 45 seconds or more to see a picture on the TV. Therefore, KVH recommends that you keep APG Load Type set to Fast.

Factory Defaults

Press SELECT to restore the Preferences options to their original factory settings.

8-6 Advanced System Setup Functions

Besides the Remote and Preferences menus described previously, the System Setup menu provides other functions, all of which are rarely, if ever, used.

To use the advanced system setup functions, follow the steps below.

1. Press the MENU button to access the main menu.
2. Highlight the **System Setup** tab and press SELECT.

System Setup Menu (Install Tab Selected)

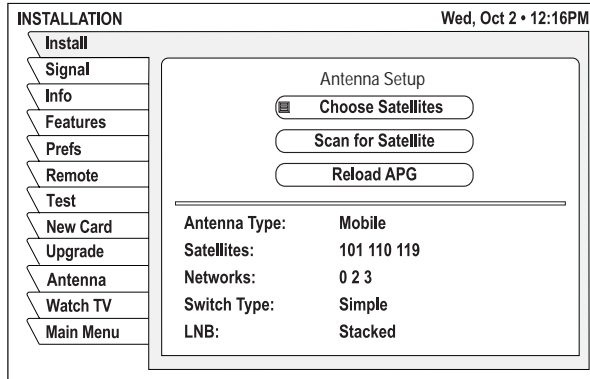

3. Highlight the menu tab for the advanced function you wish to use.

Install

The Antenna Setup pane offers three functions:

Function	Description
Choose Satellites	Allows you to select which satellites to include in the list of available satellites; refer to <i>Section 9-6, "Changing the List of Available Satellites"</i> on page 9.10
Scan for Satellite	Commands the antenna to search the sky for available satellites; this function is not recommended – use the Choose Satellites function instead
Reload APG	Reloads the complete program guide; use this function to fix a guide problem

Signal

The Signal pane shows the strength of the satellite signal. The higher the signal strength, the better the reception.

Info

The System Information pane lists general information about your mobile receiver, including model, ID, access card, and software version.

Features

The Features pane lists some of the receiver's special features.

Test

The Test function performs a simple diagnostics test on the system. When complete, a report shows system information and indicates whether the Signal, Tuning, and Front Panel functions passed the test.

New Card

In the unlikely event that your receiver's access card must be replaced, use the New Card function to initialize the new card.



If you need a new access card, please call KVH at 401-847-3327.

Upgrade

The Upgrade pane shows your receiver's upgrade history. Occasionally, DIRECTV will automatically update your receiver's software.

Antenna

The Antenna Controls pane allows you to configure the TracVision antenna. Complete details are provided in the next section.

9 Antenna Controls

This section explains how to control the TracVision antenna using the receiver's onscreen menus.

Contents

9-1	Viewing Current Settings	9.3
9-2	Turning DewShield On/Off	9.4
9-3	Turning the Beeper On/Off	9.5
9-4	Designating the Receiver as Primary or Secondary	9.6
9-5	Switching Satellites	9.8
9-6	Changing the List of Available Satellites	9.10

9-1 Viewing Current Settings

Follow the steps below to view the antenna's current settings.

1. Press the MENU button to access the main menu.
2. Highlight the **System Setup** tab and press SELECT.
3. Highlight the **Antenna** tab.
4. Highlight the **Current Settings** button and press SELECT.

The following settings are reported:

Function	Possible Settings
Sat Switching	Auto / Manual
Current Sat	Name of satellite selected for tracking
DewShield*	Auto / Off
Beeper	On / Off
Receiver Type	Primary / Secondary

* DewShield is only available with TracVision R6 systems.

Antenna Controls – Current Settings

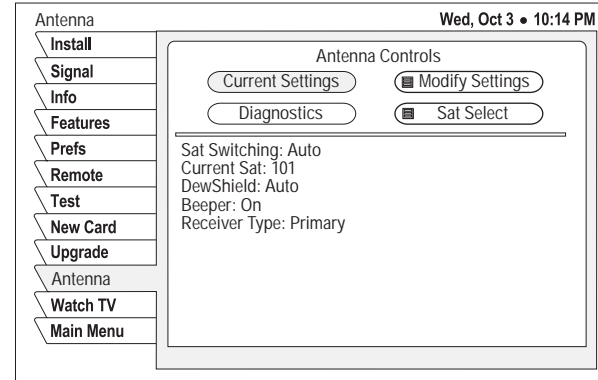

If you are using the onscreen menu on a secondary receiver, only “Beeper” and “Receiver Type” settings are available.

9-2 Turning DewShield On/Off

TracVision R6 Systems Only

The DewShield electronic dew elimination system (*patent pending*) keeps the antenna dome clear of dew, ensuring optimum reception of satellite TV signals (moisture weakens satellite signals).

Unless conserving vehicle power is a critical concern, you should leave DewShield set to AUTO. Follow the steps below if you need to change the current setting.

1. Using your primary receiver, press the MENU button to access the main menu.
2. Highlight the **System Setup** tab and press SELECT.
3. Highlight the **Antenna** tab.
4. Highlight the **Modify Settings** button and press SELECT.
5. If you want to enable DewShield, highlight **DewShield Auto**. If you want to turn off DewShield, highlight **DewShield Off**. Then press SELECT.

Change Settings – DewShield

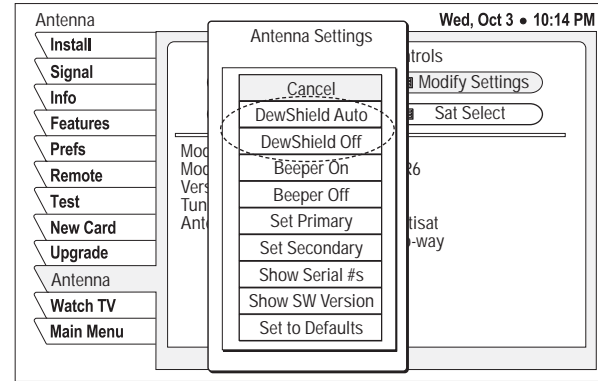

*DewShield is designed to **prevent** dew from forming. If DewShield is set to OFF, and dew has formed on the dome, setting DewShield back to AUTO will not shed water. For this reason, KVH recommends you always keep DewShield set to AUTO.*

9-3 Turning the Beeper On/Off

The mobile receiver beeps to indicate the status of the antenna.

2 beeps = Antenna is powering on

1 beep = Antenna is powering off

If you prefer, you can silence (turn off) the beeper. Follow the steps below if you need to turn the beeper on or off.

1. Press the MENU button to access the main menu.
2. Highlight the **System Setup** tab and press SELECT.
3. Highlight the **Antenna** tab.
4. Highlight the **Modify Settings** button and press SELECT.
5. If you want to turn on the beeper, highlight **Beeper On**. If you want to turn off the beeper, highlight **Beeper Off**. Then press SELECT.

Change Settings – Beeper

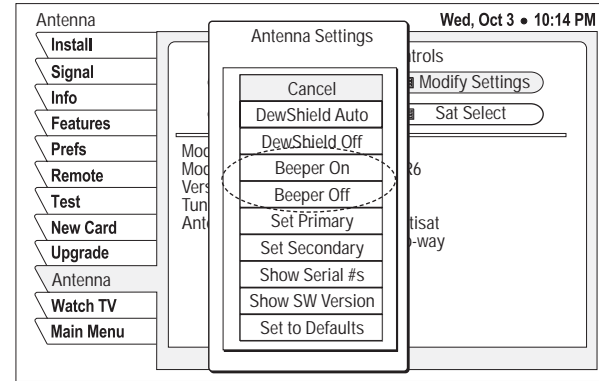

9-4 Designating the Receiver as Primary or Secondary

Each mobile receiver/controller must be designated as either a primary or a secondary receiver.

Primary Receiver

- Supplies power to the antenna
- Allows you to control the antenna
- Can receive local channels (*within your DMA*)
- Must be connected directly to the antenna, either via a single coax cable or a splitter's "Primary" jack (*see Appendix A for wiring diagrams*)
- Only one allowed per system

Secondary Receiver

- Does not power or control the antenna
- Simply receives a TV signal from the antenna
- A system may have one, none, or multiple secondary receivers

Follow the steps below to designate the receiver as a primary or secondary receiver.

1. Press the MENU button to access the main menu.
2. Highlight the **System Setup** tab and press SELECT.
3. Highlight the **Antenna** tab.
4. Highlight the **Modify Settings** button and press SELECT.

Change Settings – Receiver Designation

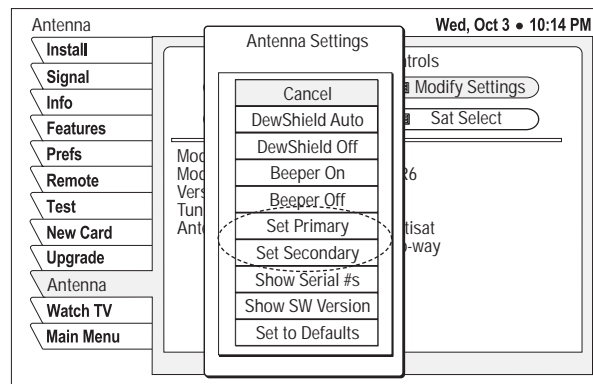

5. If you want to designate the receiver as the primary receiver, highlight **Set Primary**. If you want to designate the receiver as a secondary receiver, highlight **Set Secondary**. Then press SELECT.



Receivers are set to "Primary" by default at the factory. Therefore, you will need to set any additional receivers to "Secondary."

ANTENNA Light on Secondary Receivers

The ANTENNA light on secondary receivers will remain off at all times. Only the primary receiver can monitor antenna status.

ANTENNA Light on Secondary Receiver

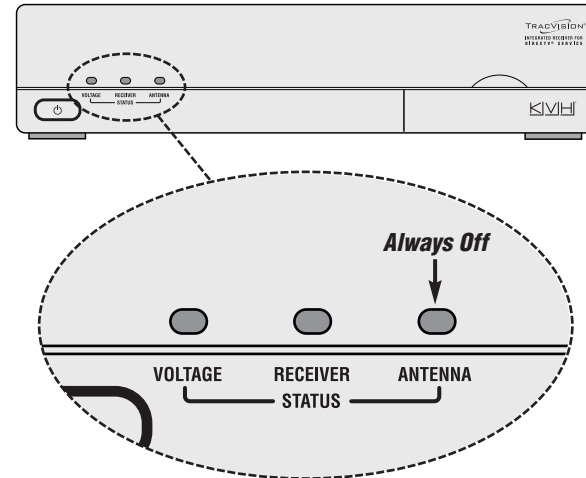

9-5 Switching Satellites

If your antenna system is configured for multiple satellites, you can easily switch between the available satellites either automatically or manually.

Automatic Switching

When the system is set up for automatic switching, the antenna automatically switches satellites as you change channels using the primary receiver's remote.

Follow the steps below to select automatic switching.

1. Using the primary receiver, press the MENU button to access the main menu.
2. Highlight the **System Setup** tab and press SELECT.
3. Highlight the **Antenna** tab.
4. Highlight the **Sat Select** button and press SELECT.
5. Highlight **Auto Switch** and press SELECT. You can now switch satellites simply by changing channels on the remote control.

Sat Select – Automatic

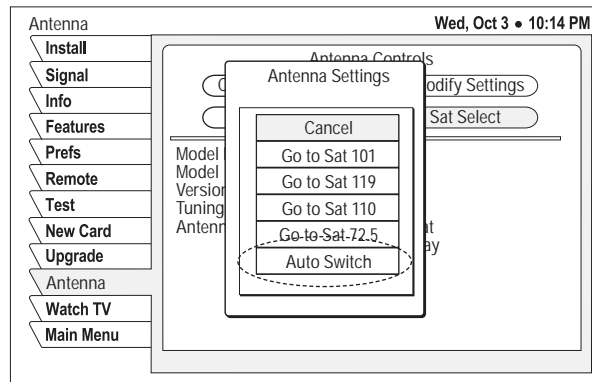

Manual Switching

If you prefer, you can switch satellites manually from the Sat Select menu.

Follow the steps below to manually switch to a different satellite.

1. Using the primary receiver, press the MENU button to access the main menu.
2. Highlight the **System Setup** tab and press SELECT.
3. Highlight the **Antenna** tab.
4. Highlight the **Sat Select** button and press SELECT.
5. Highlight the **Go to Sat** selection for the desired satellite and press SELECT. *For example, to switch to the 119 satellite, highlight **Go to Sat 119** and press SELECT.*

The antenna enters Manual mode and begins tracking the selected satellite.

Sat Select – Manual

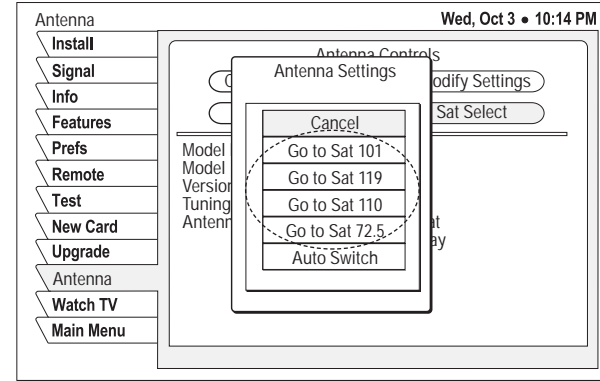

When you manually select a satellite, the system enters Manual mode. To restore automatic switching, you need to select “Auto Switch” from the Sat Select menu.

9-6 Changing the List of Available Satellites

If your antenna system supports multiple satellites, you can choose which satellites will be active for your system. Follow the steps below to add or remove satellites from the list of supported satellites.

1. Using your primary receiver, press the MENU button to access the main menu.
2. Highlight the **System Setup** tab and press SELECT.
3. Highlight the **Install** tab.
4. At the Antenna Setup pane, highlight the **Choose Satellites** button and press SELECT.
5. At the pop-up menu, highlight one of the satellites that you want to add or remove.
6. Press SELECT to add or remove the check mark next to the satellite's name. A check mark indicates that the satellite is included in the list of available satellites.

Antenna Setup

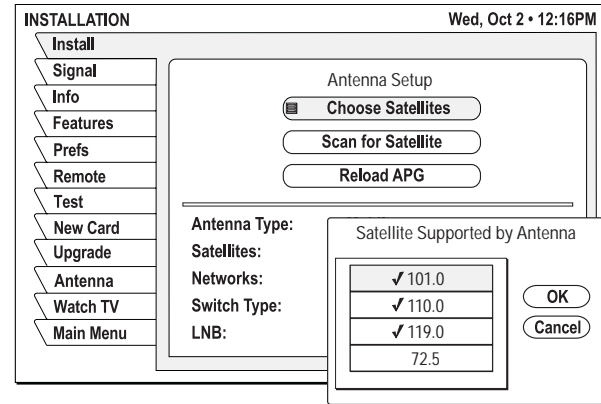

7. When you have selected all of the satellites that you want in the list, highlight the **OK** button and press SELECT.

10 Troubleshooting

This section identifies basic problems along with their possible causes and solutions. It also explains what the status lights indicate, how to view diagnostic information, and how to get technical support.

Contents

10-1	Five Simple Checks	10.3
10-2	Troubleshooting Matrix	10.4
10-3	Causes and Solutions to Common Problems	10.5
10-4	System Status Lights	10.10
10-5	Viewing Diagnostics Information	10.12
10-6	Viewing Serial Numbers	10.13
10-7	Viewing Software Versions	10.14
10-8	Technical Support	10.15

10-1 Five Simple Checks

If you are experiencing a problem, first check the five simple things below. If none of these are the problem, continue troubleshooting using the remainder of this section as a guide.

1 Can the antenna see the satellite?

The antenna requires an unobstructed view of the southern sky to receive satellite TV signals. Common causes of blockage include trees, buildings, bridges, or mountains.

2 Excessive dirt or moisture on the antenna dome?

Dirt buildup or moisture on the dome can reduce satellite reception. Clean the exterior of the dome periodically. In addition, if you have a TracVision R6, keep DewShield set to AUTO to ensure optimum reception (see *Section 9-2 on page 9.4*).

3 Is It Raining Cats and Dogs?

Heavy rain or snow can weaken satellite TV signals. Reception should improve once the inclement weather subsides.

4 Does the TV Display “Please Call Ext. 722”?

If you can only access the preview channels, such as channel 100, while all other channels show a message to call Ext. 722, the receiver may have lost its activation data. To fix this problem, call DIRECTV customer service at 1-800-DIRECTV (347-3288). *Be sure the antenna is tracking the satellite when you call.*

5 Are the Receiver and TV Connected and Turned On?

Make sure the power switch on the front of the KVH mobile receiver/controller is turned on (VOLTAGE light is lit green). Also make sure your TV is turned on and set up for the satellite input. Finally, check the connecting cables to ensure none have come loose.



You can also try resetting the receiver:

1. Stop in a blockage-free area.
2. Turn off the receiver's power switch (on the front panel, not on the remote).
3. Wait one minute, then turn the receiver's power switch back on.
4. If the TracVision antenna is turned off, turn it on (press SAT then PWR).
5. Wait one minute for initialization.

10-2 Troubleshooting Matrix

SYMPTOM	POSSIBLE CAUSE																						
	Receiver power switch turned off	Blown fuse	Insufficient power	Loose cable connectors	Satellite signal blocked	Satellite coverage issue	Weak satellite signal	Receiver not activated	Receiver lost activation information	Proper component information	INPUT button not pressed	Audio/video system not set to satellite source	System locked by passcode	Favorite channel list active	Remote control not programmed	Program Guide load interrupted	Receiver locked up	Outside Designated Market Area (DMA)	RF converter not set up for all satellites	Remote control batteries dead	Ground loop generating electrical noise	Antenna faulty	Receiver faulty
System does not power on	X	X	X	X					X										X		X	X	X
No video on TV screen	X	X	X	X						X	X										X		X
Intermittent picture for short intervals				X	X	X	X														X	X	X
System works at rest, but not on the move					X																	X	
System does not find satellite			X	X	X	X	X															X	X
System restarts itself			X	X																			X
Receiver beeps continuously at startup			X																				
Snowy DIRECTV television picture			X	X					X	X				X		X					X		X
Picture jumbled or freezing				X	X	X	X														X		X
Some channels are not accessible						X	X				X	X		X		X	X					X	X
Remote does not work	X			X										X		X			X	X			X
Remote does not operate other component									X					X									
Only Preview channels are accessible							X	X															
Local channels are not accessible																	X	X				X	
Audio is noisy				X																X	X		

10-3 Causes and Solutions to Common Problems

There are a number of common issues that can affect the signal reception quality or the operation of the TracVision system. The following sections identify these issues and provide potential solutions.

Receiver Power Switch Turned Off

Your mobile receiver's power switch (see below) must remain on for the system to work. If the system is entirely non-functional, check the switch to ensure that it is turned on. *The VOLTAGE status light illuminates green when turned on.*

Power Switch

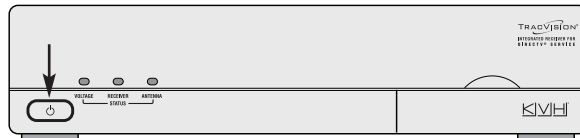

Blown Fuse

The rear panel of the receiver includes a fast-blow fuse rated for 8 amps. If this fuse has blown, the system will not operate.

Unscrew the cap and replace the fuse. If you replace the fuse, but it blows again, check the receiver to ensure that it is clear of debris and the connectors are tight. **Do not replace the fuse with a larger amperage fuse.**

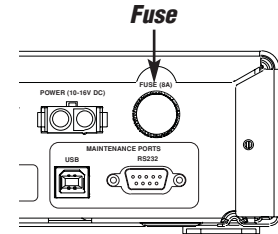

Insufficient Power

With the vehicle/vessel powered up and the receiver turned on, power at the receiver must measure at least 10 VDC (supporting 60 watts) for the TracVision system to work properly. Check the receiver's power connection and ensure that it is wired to a dedicated circuit. If other devices are wired to the same circuit, these additional loads might drain power away from the receiver.

Loose Cable Connectors

A loose connector can reduce the signal quality. Check the cable connections at the antenna unit, receiver, RF converter, audio/video components, and other equipment to ensure they are securely attached.

Satellite Signal Blocked

Satellite signals can be blocked or degraded by tall or solid structures such as trees, buildings, mountains, or bridges. Simply moving to clear an obstruction will restore signal quality. Rain clouds, heavy rain, and snow can also affect satellite signal reception. For more details about satellite blockage, see *Section 1-3, "Receiving Satellite TV Signals," on page 1.5.*

In addition, dirt, snow, ice, or heavy moisture on the antenna dome can disrupt satellite signals, so be sure to clean the antenna periodically.

Satellite Coverage Issue

TracVision will provide good satellite TV reception throughout the entire satellite coverage area. However, signal quality can be degraded as you

approach the fringe of this area. *To view the most up-to-date coverage maps, visit KVH's website at www.kvh.com/footprint. For more details about satellite coverage, see *Section 1-3, "Receiving Satellite TV Signals," on page 1.5.**

Weak Satellite Signal

Just like radio stations, some satellite TV channels transmit a stronger signal than others. If you're unable to receive a clear signal on one channel, try switching to another channel. Weaker channels are more vulnerable to interference, such as rain or snow.

Receiver Not Activated

If you can only access the DIRECTV preview channels, such as channel 100, while all other channels show a message to call DIRECTV, your receiver has not been activated. **To activate your system, please call KVH's Activation Department at 1-866-551-8004. Activation support is available 24 hours a day, seven days a week.**

Receiver Lost Activation Information

If you can only access the DIRECTV preview channels, such as channel 100, while all other channels show a message to call Ext. 722, and you have already activated the receiver, the receiver may have lost its stored activation data. This may occur if the receiver is left idle (does not receive a satellite signal) for an extended period of time. To fix this problem, please call DIRECTV customer service at 1-800-DIRECTV (347-3288). You will need to provide your phone number. *Be sure the TracVision system is turned on, has a clear view of the sky, and is tuned to the DIRECTV preview channel before you call. The system will receive a signal from the satellite to fix the problem.*

Proper Component Button Not Pressed

To operate the satellite TV system using the remote control, first press the remote control's SAT button. The remote control will not operate the receiver unless the SAT button is active. To operate a component other than the satellite receiver, first press the corresponding component button on the remote control. For example, to operate the TV monitor using the remote control, first press the TV button.

INPUT Button Not Set to Satellite Source

If satellite programming is not displayed on your TV, you may have selected an alternate video input. Press the remote control's TV button. Then press the remote's INPUT button until the correct satellite input is displayed.

Audio/Video System Not Set Up Properly

If satellite programming is not displayed on your TV, you may have the wrong input selected on your audio/video system. Try switching to another input (for example, VIDEO 1 or VIDEO 2; AUX1, AUX2, or A/V) whichever input is assigned to the mobile receiver. In addition, ensure that the audio/video system is powered on.

System Locked by Passcode

If you can only access Family list channels, and the lock icon (🔒) appears under the date/time, the system has been locked with a passcode. For details on unlocking the system, see *Section 7-1, "Locking & Unlocking the System,"* on page 7.3. If no channels are assigned to the Family list, no channels can be viewed without first unlocking the system

Favorite Channel List Active

If a favorite channel list is active, only channels set up in that list are accessible. Press the remote control's FAV button to cycle through the lists. See *Section 6-1, "Using Favorite Channel Lists,"* on page 6.3 for details.

Remote Control Not Programmed

If you cannot operate a component with the remote control, first ensure that the associated component button (DVD, VCR, AUX, or TV) is selected. If the correct button is selected, you need to program the remote control to operate the component. See *Section 3-2, "Programming the Remote Control to Operate Other Components,"* on page 3.9 for details.

Program Guide Load Interrupted

If the program guide load is interrupted at startup, certain channels may not be available temporarily. Guide load interruptions could occur as a result of satellite blockage (see *"Satellite Signal Blocked"* on page 10.6). The missing channels will eventually be restored as the receiver completes the program guide download during normal operation.

Receiver Locked Up

Since your mobile receiver is a computing component, it is susceptible to erratic changes in power and/or signal, like any computer, and these sudden changes can cause it to become "confused." To clear this condition, try pressing the remote control's SAT button before trying to control the receiver. If that doesn't work, turn off vehicle/vessel power or the receiver's power switch for 30 seconds, then turn it back on.

Outside Designated Market Area (DMA)

Local channels are available only within the Designated Market Area (DMA) used on your account. The antenna cannot receive local channels if you travel outside of your DMA.

System Not Set Up for All Satellites

If your antenna system supports multiple satellites, you can choose to omit certain satellites from the system's list of available satellites. If you do so, you will not be able to access channels that are carried on those omitted satellites. For details, see *Section 9-6, "Changing the List of Available Satellites"* on page 9.10.

RF Converter Too Close to Receiver

The RF converter must be placed at least three feet away from the receiver. Placing the RF converter closer to the receiver may result in interference, causing the remote control to operate intermittently or not at all. Also make sure the RF converter is not located behind a metal structure.

Remote Control Batteries Dead

Replace the two AAA batteries as shown below, observing the correct polarity.

Remote Control Batteries

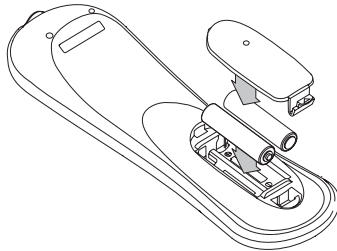

If you lose your remote control, please call or visit your local KVH authorized dealer to order a replacement.

Ground Loop Generating Electrical Noise

The system's audio cables might pick up the electrical noise or hum caused by a ground loop on the vehicle/vessel. To eliminate this noise, install a ground loop isolator in-line between the receiver's "Audio" jacks and your TV's audio input. (*use Radio Shack model 270-054 or equivalent*)

Audio/Video System Faulty

If there is no picture on your TV, your mobile audio/video system may be faulty. Please seek technical assistance from either the installer of your audio/video system or a dealer authorized by the system's manufacturer to repair the system.

Antenna or Receiver Faulty

In the case of a faulty antenna or receiver, please seek technical support as described in *Section 10-8, "Technical Support"* on page 10.15.



Do NOT attempt repairs yourself. Refer all servicing needs to qualified service personnel. Evidence of tampering or unauthorized repairs will void the warranty.

10-4 System Status Lights

Three status lights on the front of the mobile receiver indicate the current status of the system and can help you identify problems.

During normal operation, all three status lights should be lit green. The following tables explain what the different light conditions indicate.



If multiple receivers are connected, the ANTENNA light on secondary receivers will remain off at all times. Only the primary receiver can monitor antenna status.

System Status Lights

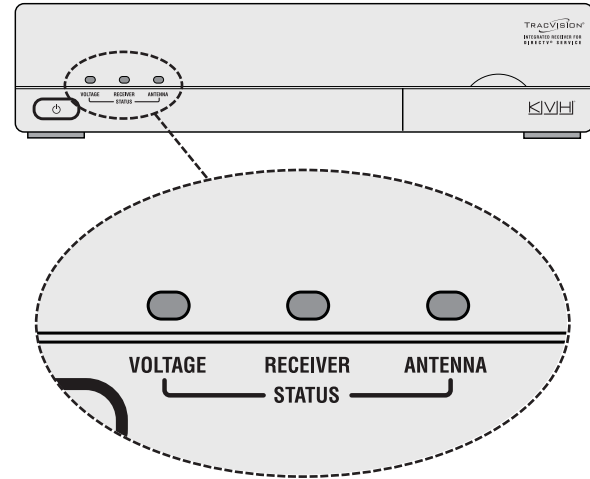

VOLTAGE Light Indications

Light is...	Indicates	Description
Off	Off	Receiver is OFF (power switch is off) or no power input
Green	OK	Good power (between 10-16 VDC at receiver)
Green, flashing	Cable Open	Open detected in antenna cable (check antenna coax connection)
Orange	Low Power	Low power (between 8-10 VDC at receiver)
Red, flashing	Bad Power	Insufficient power (less than 8 VDC or more than 16 VDC input)

RECEIVER Light Indications

Light is...	Indicates	Description
Off	Off	Receiver is OFF (power switch is off)
Green	OK	Receiver is ON
Orange	Standby	Receiver is ON but antenna is turned OFF
Orange, flashing*	Overload	Overload or short circuit detected on the antenna cable
Red	Fault	Internal power fault

ANTENNA Light Indications

Light is...	Indicates	Description
Off	Off	Antenna is OFF or disconnected, bad power, receiver in Standby, or receiver set to Secondary
Green	Tracking	Antenna is tracking the DIRECTV satellite
Green, flashing	Searching	Antenna is searching for a satellite
Orange, flashing*	Overload	Overload or short circuit detected on the antenna cable
Red	No Comm	Receiver cannot communicate with the antenna
Red, flashing	Fault	Error detected in antenna

* The RECEIVER and ANTENNA lights both flash orange if an overload or short circuit is detected.

10-5 Viewing Diagnostic Information

Follow the steps below to view diagnostics information on the receiver.

1. Using your primary receiver, press the MENU button to access the main menu.
2. Highlight the **System Setup** tab and press SELECT.
3. Highlight the **Antenna** tab.
4. Highlight the **Diagnostics** button and press SELECT.

Component	Possible States
Receiver State	OK / Error
Antenna State	Idle / Initializing / Searching / Tracking / Error
Current Sat	Name of satellite the antenna is tracking
RF	OK / Low / Error; Actual RF level
Available Sats	List of installed satellites / Error

Diagnostics

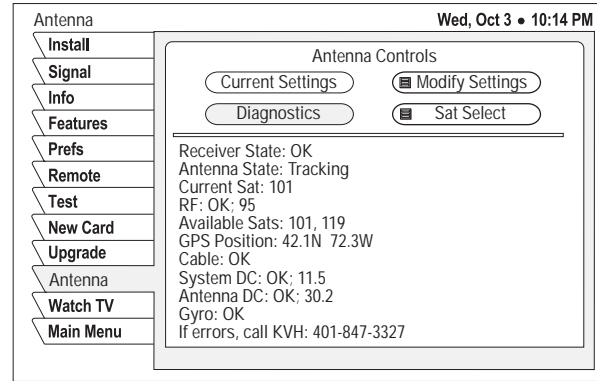

Component	Possible States
GPS Position	Current position in latitude/longitude / Acquiring / Error
Cable	OK / Shorted / Open
System DC	OK / Low / Bad; Actual VDC at receiver
Antenna DC	OK / Error; Actual VDC at antenna
Gyro	OK / Error

If the receiver reports an error, please contact Technical Support for assistance. See *Section 10-8, "Technical Support"* on page 10.15.

10-6 Viewing Serial Numbers

Follow the steps below to view the system serial numbers.

1. Using your primary receiver, press the MENU button to access the main menu.
2. Highlight the **System Setup** tab and press SELECT.
3. Highlight the **Antenna** tab.
4. Highlight the **Modify Settings** button and press SELECT.
5. Highlight **Show Serial #s** and press SELECT.

The receiver and antenna serial numbers appear on the screen.



If you use this function on a secondary receiver, only the receiver serial number will appear on the screen.

Change Settings – Show Serial #s

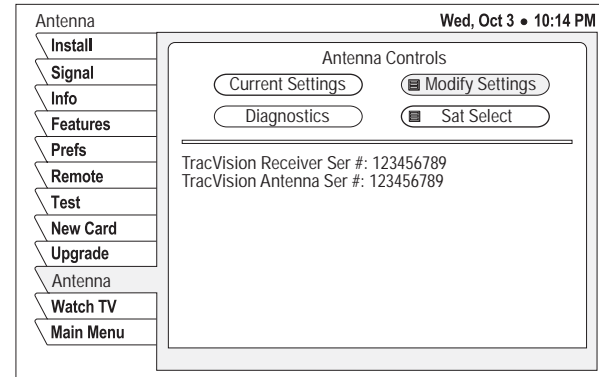
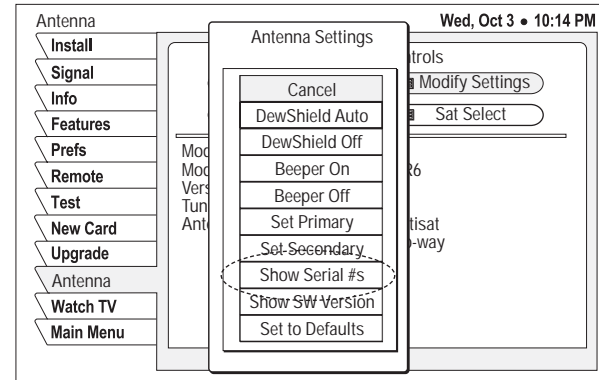

10-7 Viewing Software Versions

Follow the steps below to view the system software versions.

1. Using your primary receiver, press the MENU button to access the main menu.
2. Highlight the **System Setup** tab and press SELECT.
3. Highlight the **Antenna** tab.
4. Highlight the **Modify Settings** button and press SELECT.
5. Highlight **Show SW Version** and press SELECT.

The TracVision software versions appear on the screen.

Change Settings – Show Software Versions

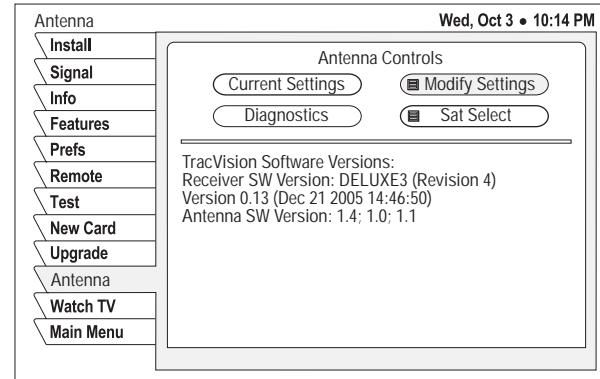
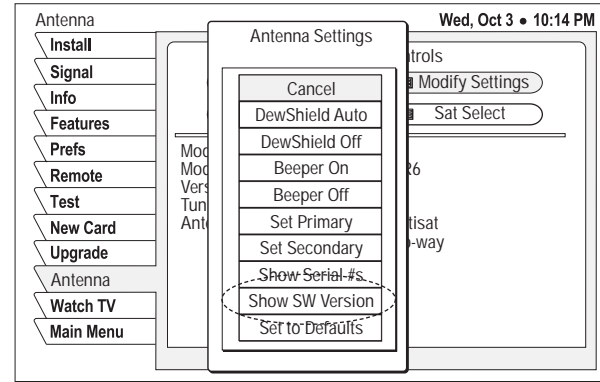

10-8 Technical Support

The TracVision antenna and mobile receiver/controller are sophisticated electronic devices; only KVH-authorized technicians have the tools and expertise necessary to diagnose and repair a system fault. Therefore, if you experience any operating problem or require technical assistance, please call or visit your local authorized TracVision dealer. You can find an authorized technician near you by visiting our website at www.kvh.com/wheretogetservice.

If you need help finding an authorized technician, please contact KVH Technical Support:

Phone: 401-847-3327

E-mail: techs@kvh.com

Please have your antenna and receiver/controller serial numbers ready before calling technical support. The serial numbers are located on the red Activation Card. You can also find the serial numbers from the primary receiver's onscreen menu (see *Section 10-6, "Viewing Serial Numbers" on page 10.13*).

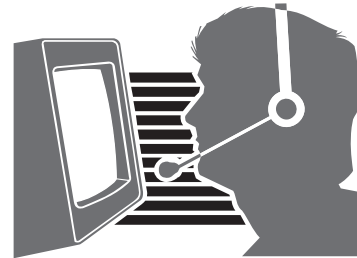

Appendices

This section provides wiring diagrams and notes for typical TracVision configurations and maps showing the DIRECTV® satellites' elevation angles off the horizon.

Contents

A	System Wiring Diagrams	A.3
B	Elevation Maps	A.23

Appendix A

System Wiring Diagrams

The diagrams on the following pages show how to wire the system for various configurations:



Before making any wiring changes, be sure to turn off vehicle/vessel power.

If your desired configuration is not shown here, please call KVH Technical Support at 401-847-3327 for assistance.

Original KVH mobile receiver/controller* AND:	Requires Part #:	Page:
No additional receivers	N/A	A.4
One (1) additional mobile receiver/controller	72-0177	A.6
Two (2) additional mobile receiver/controllers	72-0177 (x2)	A.8
One (1) standard-def home receiver**	72-0177 & 19-0347	A.10
Two (2) standard-def home receivers**	72-0177 & 19-0410	A.12
One (1) additional mobile receiver/controller and one (1) standard-def home receiver**	72-0177 (x2) & 19-0347	A.14
One (1) standard-def digital video recorder (DVR)**	72-0177 & 19-0410	A.16
One (1) standard-def home receiver and one (1) standard-def DVR**	72-0177, 19-0410, & 19-0123	A.18
One (1) additional mobile receiver/controller and one (1) standard-def DVR**	72-0177 (x2) & 19-0410	A.20

* The original mobile receiver/controller, bundled with the TracVision system, is required in all configurations. It supplies power to the antenna.

** The KVH mobile receiver/controller is a standard-definition unit, not a high-definition (HD) unit, so the system cannot recognize high-definition (HD) channels. If you wish to use a home receiver or DVR with the system, be sure to use a standard-definition (non-HD) model.

Wiring Diagram for a Single Mobile Receiver/Controller

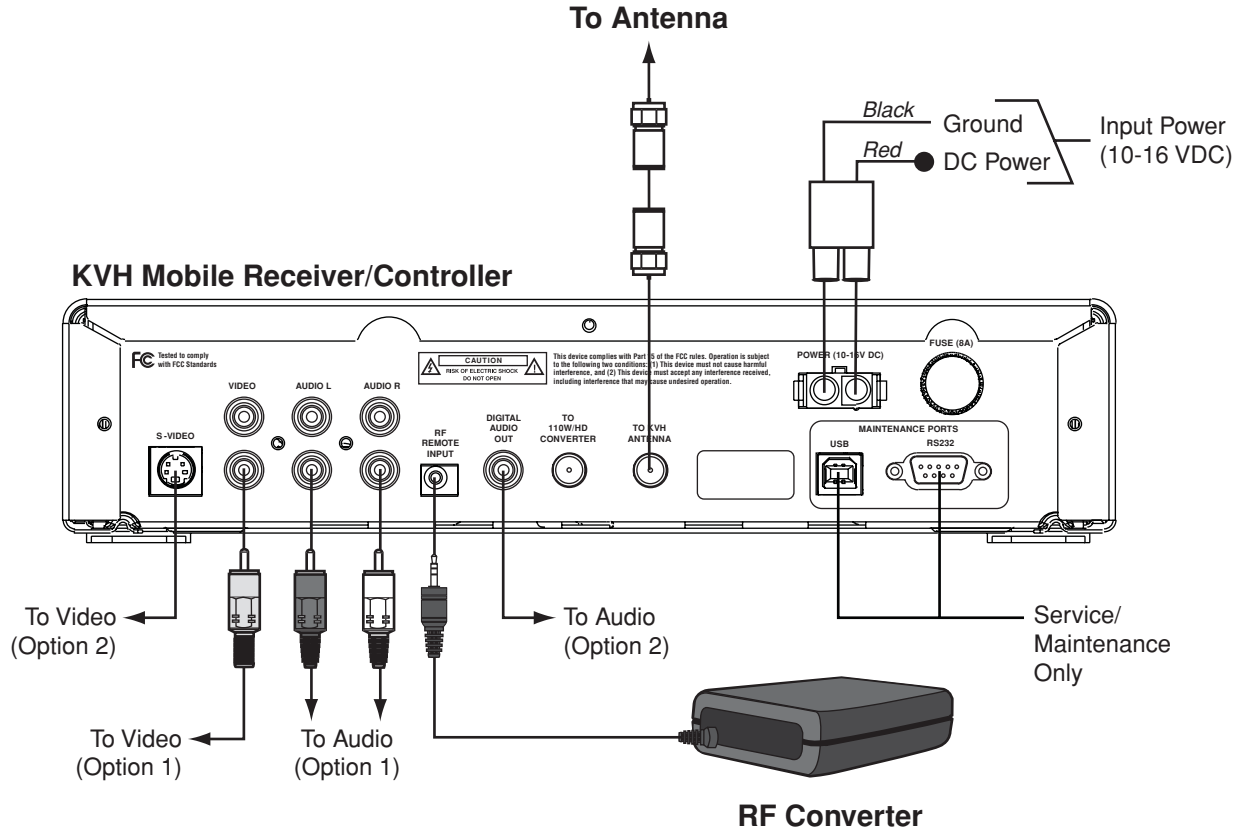

Single Mobile Receiver/Controller

Audio/Video Connections

- To connect the receiver/controller to the TV's **video** input, you can choose either of the following options:
Option 1 - RCA-type jack
Option 2 - S-Video jack
- To connect the receiver/controller to the TV's **audio** input, you can choose either of the following options:
Option 1 - RCA-type jacks
Option 2 - Digital audio jack
- Standard audio/video cables with RCA-type connectors are included with the receiver/controller.
- If the TV has only a coaxial input, you will need to use an RF modulator to convert the RCA-type input to a coaxial output. (*use Radio Shack model 15-2526 or equivalent*)

Power

- The receiver/controller requires a 10-16 volts DC (VDC) power input supporting 60 watts.
- If vehicle/vessel power fluctuates or is noisy, KVH recommends that you use an AC/DC power supply to connect power to the receiver/controller.

RF Converter

- The RF converter should be placed at least 3 feet away from the receiver/controller. If it is too close to the receiver/controller, the remote control might not operate properly.
- Avoid placing the RF converter behind a metal surface or in an area surrounded by metal.

Wiring Diagram for Two Mobile Receiver/Controllers

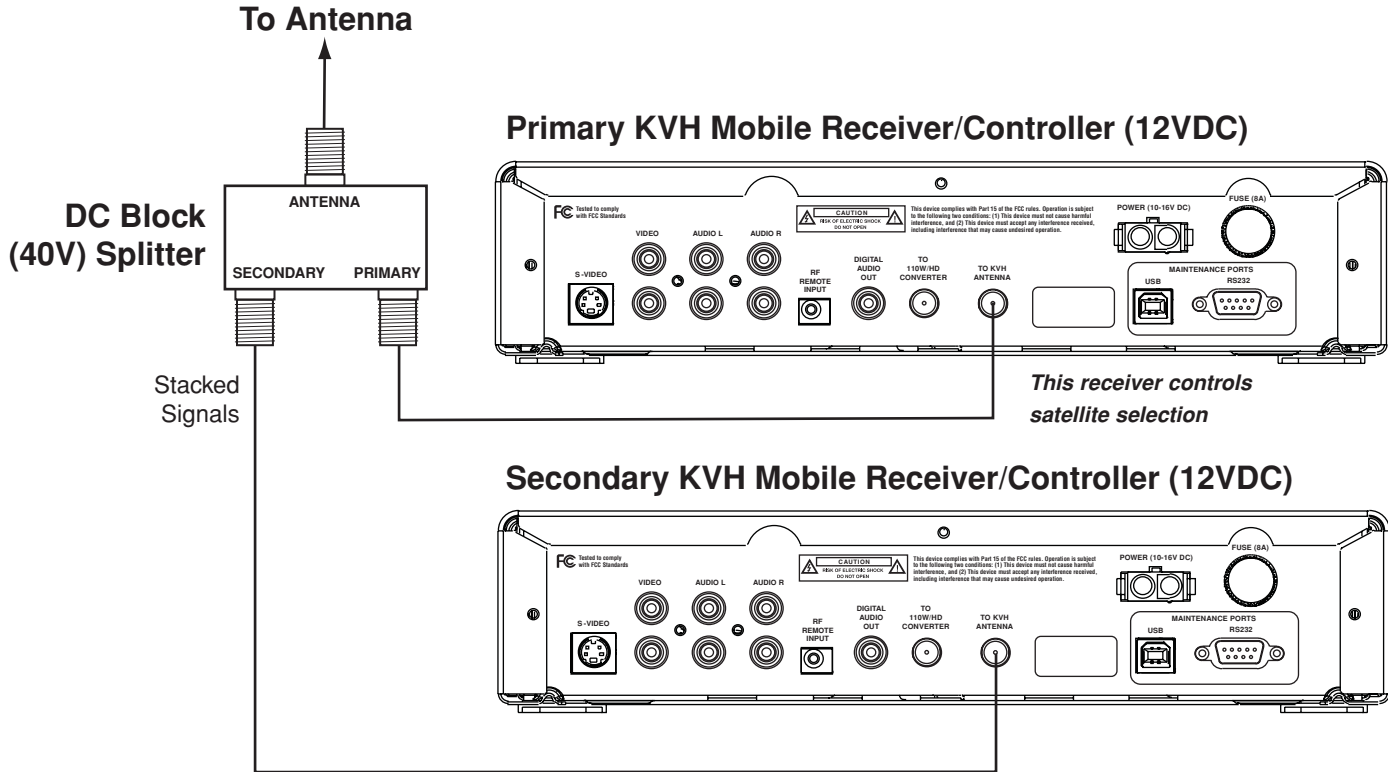

Two Mobile Receiver/Controllers

Components Required

- Splitter Kit, KVH P/N 72-0177
- (*TracVision M3/M2 only*) A Splitter Kit is included in the Extra Receiver Kit (P/N 01-0288-01).
- The special DC block (40V) splitter included in the Splitter Kit permits communications between the antenna and the primary receiver/controller. **A standard off-the-shelf splitter will not work.**

Primary vs. Secondary

- The receiver/controller you connect to the splitter's "Primary" jack is the primary receiver/controller. Only the primary receiver/controller can communicate directly with the antenna to report status and select satellites.
- The receiver/controller you connect to the splitter's "Secondary" jack is the secondary receiver/controller.

- The secondary receiver/controller needs to be set up for secondary operation. Follow the steps in *Section 9-4, "Designating the Receiver as Primary or Secondary" on page 9.6.*
- The primary receiver/controller supplies power to the antenna. It must be turned on in order to use the secondary receiver/controller.
- Only the primary receiver/controller can receive local channels (*within the DMA used on your account*).

Remote Control for Secondary Receiver/Controller

- To avoid interference or "cross talk" between the two remote controls, you can program one of the remotes for a different ID code. See *Section 3-3, "Controlling Multiple Receivers" on page 3.10* for details.

ANTENNA Light on Secondary Receiver/Controller

- The ANTENNA light on the front panel of the secondary receiver/controller will remain off at all times. Only the primary receiver/controller can monitor antenna status.

Wiring Diagram for Three Mobile Receiver/Controllers

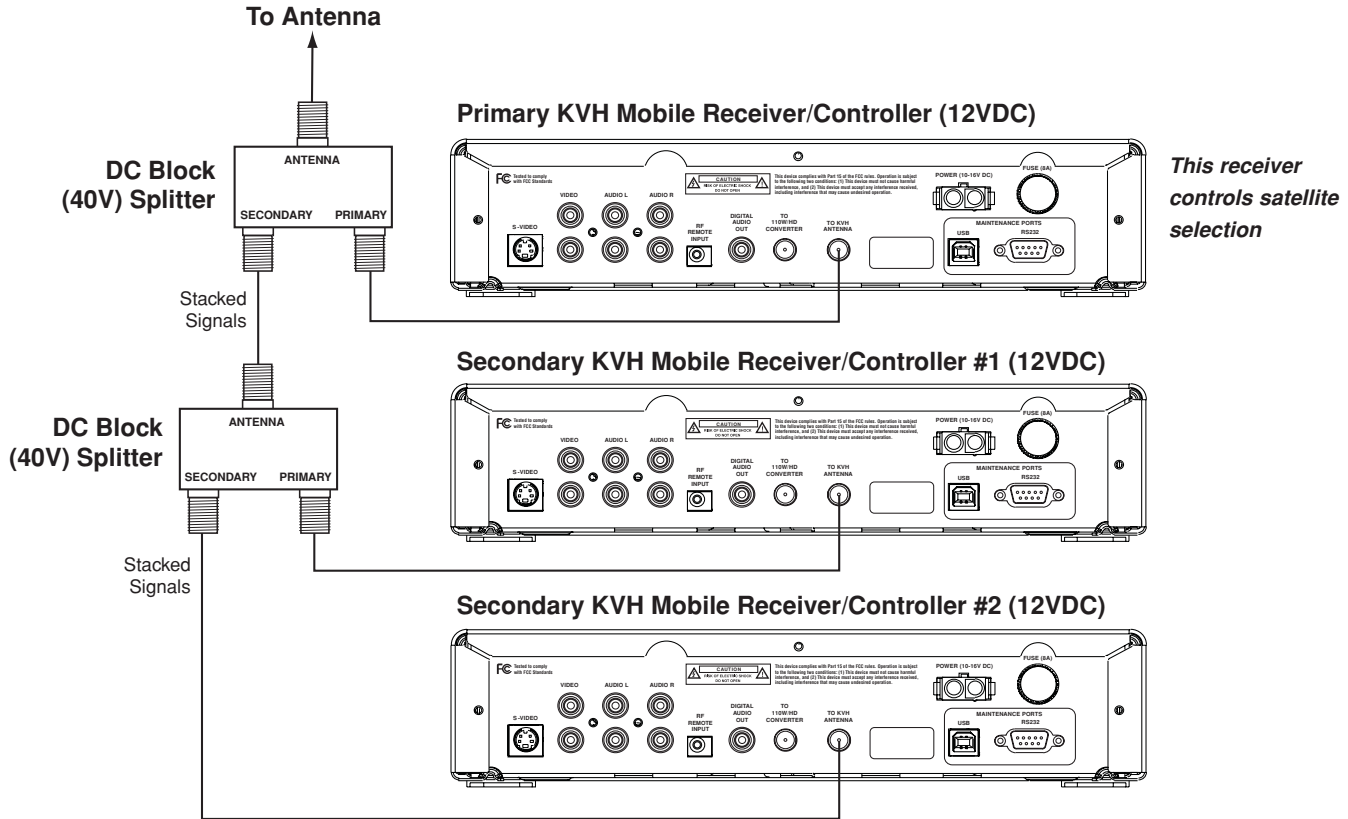

Three Mobile Receiver/Controllers

Components Required

- Two Splitter Kits, KVH P/N 72-0177
- (*TracVision M3/M2 only*) A Splitter Kit is included in the Extra Receiver Kit (P/N 01-0288-01).
- The special DC block (40V) splitter included in the Splitter Kit permits communications between the antenna and the primary receiver/controller. **A standard off-the-shelf splitter will not work.**

Primary vs. Secondary

- The receiver/controller you connect to the first splitter's "Primary" jack is the primary receiver/controller. Only the primary receiver/controller can communicate directly with the antenna to report status and select satellites.
- All other receiver/controllers are secondary receiver/controllers.
- The secondary receiver/controllers need to be set up for secondary operation. Follow the steps in *Section 9-4, "Designating the Receiver as Primary or Secondary" on page 9.6.*

- The primary receiver/controller supplies power to the antenna. It must be turned on in order to use the secondary receiver/controllers.
- Only the primary receiver/controller can receive local channels (*within the DMA used on your account*).

Remote Control for Secondary Receiver/Controllers

- To avoid interference or "cross talk" between the three remote controls, you can program each remote for a different ID code. See *Section 3-3, "Controlling Multiple Receivers" on page 3.10* for details.

ANTENNA Light on Secondary Receiver/Controllers

- The ANTENNA light on the front panel of the secondary receiver/controllers will remain off at all times. Only the primary receiver/controller can monitor antenna status.

Minimize Signal Loss

- Cable lengths between receiver/controllers should be kept as short as possible to minimize signal loss.

Wiring Diagram for One Mobile Receiver/Controller and One Standard-Def Home Receiver

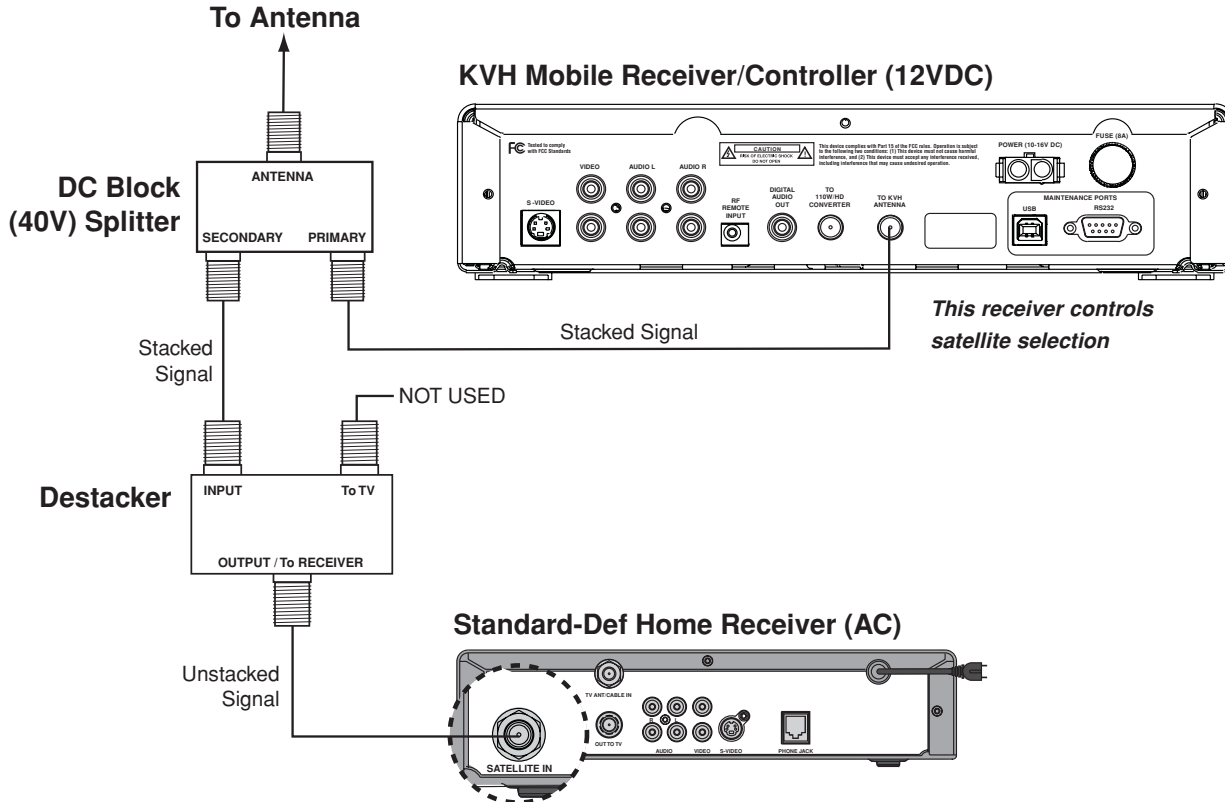

One Mobile Receiver/Controller and One Standard-Def Home Receiver

Components Required

- Splitter Kit, KVH P/N 72-0177
- Destacker, Single-output, KVH P/N 19-0347
- The special DC block (40V) splitter included in the Splitter Kit permits communications between the antenna and the primary receiver/controller. **A standard off-the-shelf splitter will not work.**

Why Do I Need a Destacker?

- The output of the TracVision antenna is a special stacked signal, which the mobile receiver/controller is configured to decode. Since all home receivers are configured to decode unstacked signals, a destacker is needed to convert the antenna's stacked signal into an unstacked signal.

Compatible DIRECTV Receiver Models

- The TracVision antenna is compatible with all new DIRECTV-branded, standard-definition (non-HD) receiver models manufactured today. Older, non-DIRECTV-branded receiver models are not supported.

Wiring Diagram for One Mobile Receiver/Controller and Two Standard-Def Home Receivers

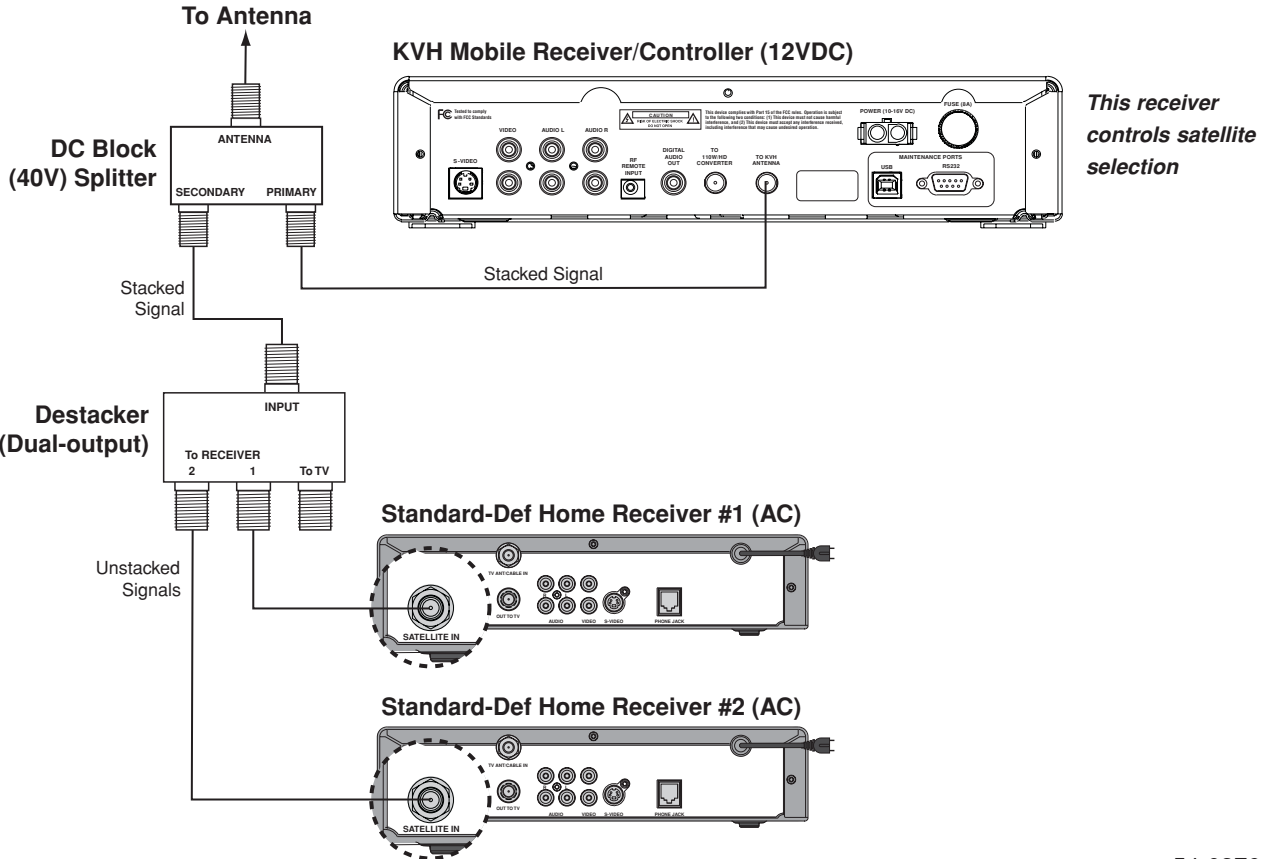

One Mobile Receiver/Controller and Two Standard-Def Home Receivers

Components Required

- Splitter Kit, KVH P/N 72-0177
- Destacker, Dual-output, KVH P/N 19-0410
- The special DC block (40V) splitter included in the Splitter Kit permits communications between the antenna and the primary receiver/controller. **A standard off-the-shelf splitter will not work.**

Why Do I Need a Dual-output Destacker?

- The output of the TracVision antenna is a special stacked signal, which the mobile receiver/controller is configured to decode. Since all home receivers are configured to decode unstacked signals, a dual-output destacker is needed to convert the antenna's stacked signal into two unstacked signals.

Compatible DIRECTV Receiver Models

- The TracVision antenna is compatible with all new DIRECTV-branded, standard-definition (non-HD) receiver models manufactured today. Older, non-DIRECTV-branded receiver models are not supported.

Wiring Diagram for Two Mobile Receiver/Controllers and One Standard-Def Home Receiver

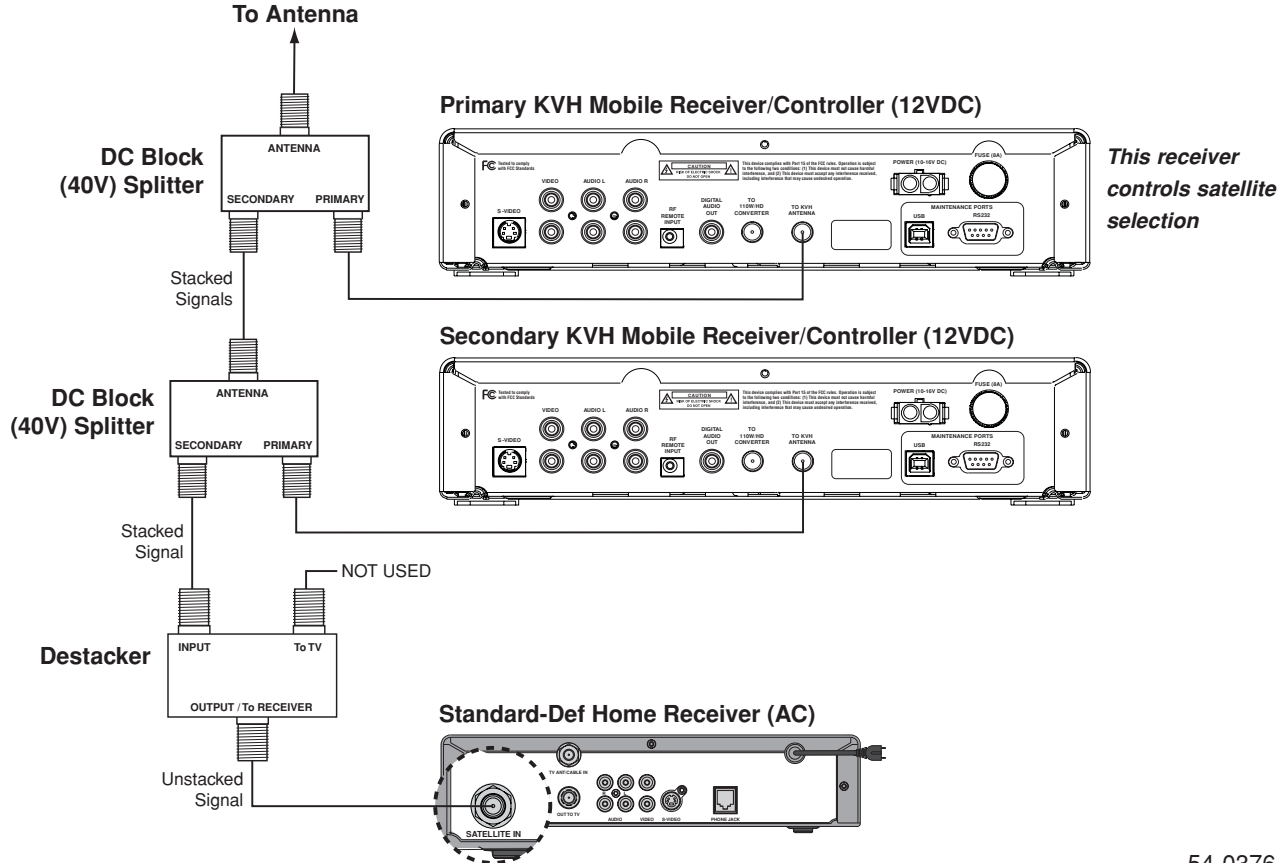

Two Mobile Receiver/Controllers and One Standard-Def Home Receiver

Components Required

- Two Splitter Kits, KVH P/N 72-0177
- (*TracVision M3/M2 only*) A Splitter Kit is included in the Extra Receiver Kit (P/N 01-0288-01).
- Destacker, Single-output, KVH P/N 19-0347
- The special DC block (40V) splitter included in the Splitter Kit permits communications between the antenna and the primary receiver/controller. **A standard off-the-shelf splitter will not work.**

Installing the Second Mobile Receiver/Controller

- Refer to “*Two TracVision Mobile Receivers*” on page A.7 for details.

Why Do I Need a Destacker?

- The output of the TracVision antenna is a special stacked signal, which the mobile receiver/controller is configured to decode. Since all home receivers are configured to decode unstacked signals, a destacker is needed to convert the antenna’s stacked signal into an unstacked signal.

Compatible DIRECTV Receiver Models

- The TracVision antenna is compatible with all new DIRECTV-branded, standard-definition (non-HD) receiver models manufactured today. Older, non-DIRECTV-branded receiver models are not supported.

Wiring Diagram for One Mobile Receiver/Controller and One Standard-Def DVR

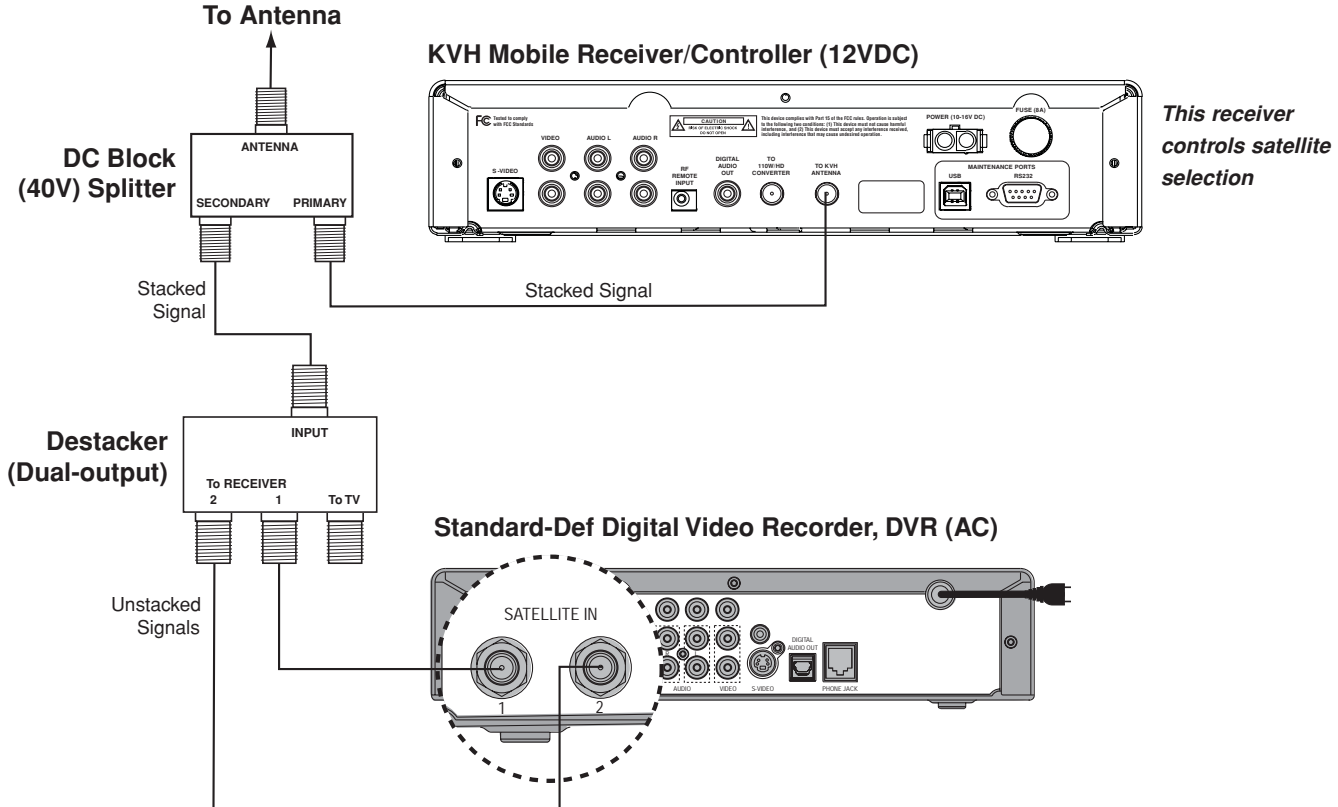

One Mobile Receiver/Controller and One Standard-Def DVR

Components Required

- Splitter Kit, KVH P/N 72-0177
- Destacker, Dual-output, KVH P/N 19-0410
- The special DC block (40V) splitter included in the Splitter Kit permits communications between the antenna and the primary receiver/controller. **A standard off-the-shelf splitter will not work.**

Why Do I Need a Dual-output Destacker?

- The output of the TracVision antenna is a special stacked signal, which the mobile receiver/controller is configured to decode. Since all DVRs are configured to decode unstacked signals, a dual-output destacker is needed to convert the antenna's stacked signal into two unstacked signals.
- A **dual-output** destacker is required because DVRs, such as TiVo, have two unstacked inputs, whereas standard receivers have only one input.

Recording Limitation

- Since the mobile receiver/controller controls satellite selection, the DVR can record any channel that is carried on the currently selected satellite; however it cannot record a channel that is carried on a different satellite. For example, if your mobile receiver/controller is tuned to a channel on the 119 satellite, you would not be able to record a program on the 101 satellite. You would need to switch to the 101 satellite on the mobile receiver/controller.

Wiring Diagram for One Mobile Receiver/Controller, One Standard-Def Home Receiver, and One Standard-Def DVR

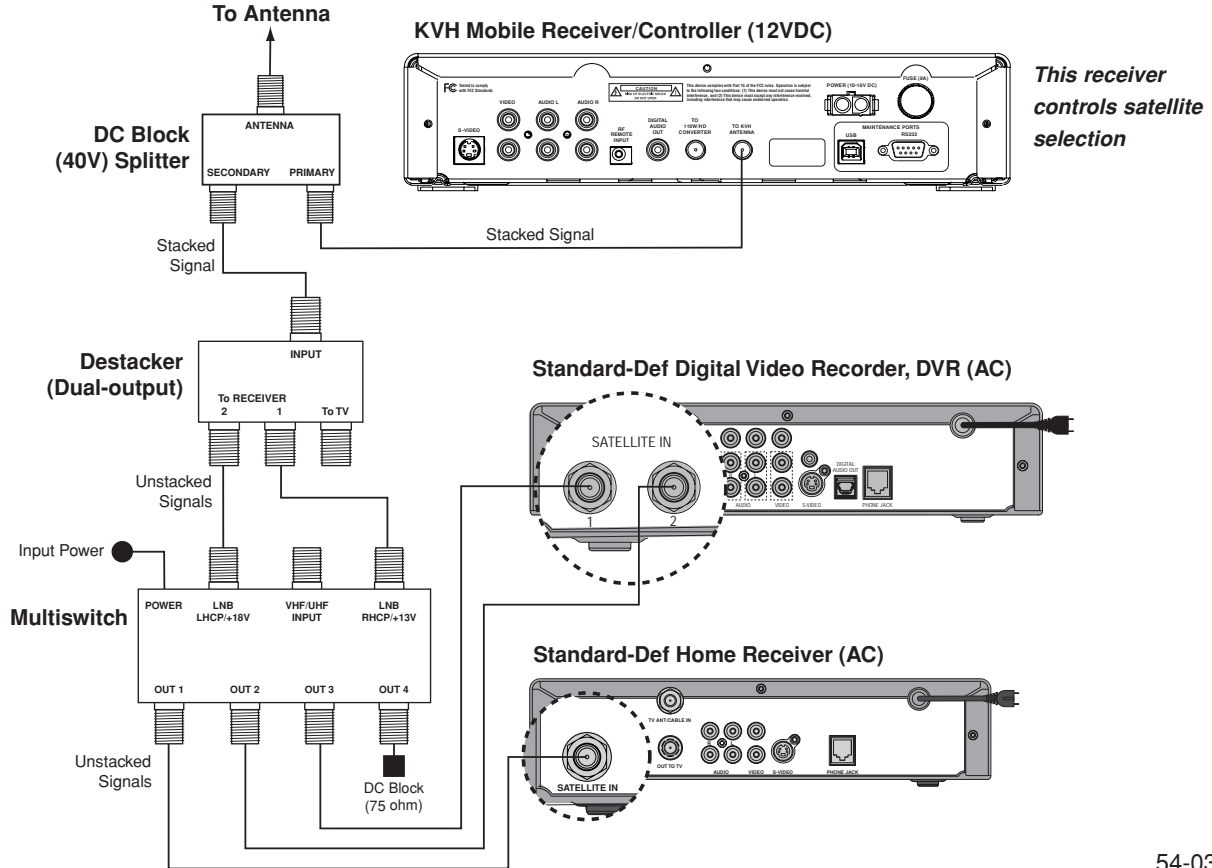

This receiver controls satellite selection

One Mobile Receiver/Controller, One Standard-Def Home Receiver, and One Standard-Def DVR

Components Required

- Splitter Kit, KVH P/N 72-0177
- Destacker, Dual-output, KVH P/N 19-0410
- Multiswitch, KVH P/N 19-0123
- The special DC block (40V) splitter included in the Splitter Kit permits communications between the antenna and the primary receiver/controller. **A standard off-the-shelf splitter will not work.**

Why Do I Need a Dual-output Destacker?

- The multiswitch requires two unstacked inputs. Since the output of the TracVision antenna is a stacked signal, the dual-output destacker is used to split the signal into two unstacked signals.

Compatible DIRECTV Receiver Models

- The TracVision antenna is compatible with all new DIRECTV-branded, standard-definition (non-HD) receiver models manufactured today. Older, non-DIRECTV-branded receiver models are not supported.

Recording Limitation

- Since the mobile receiver/controller controls satellite selection, the DVR can record any channel that is carried on the currently selected satellite; however it cannot record a channel that is carried on a different satellite.

Multiswitch

- You will need an active multiswitch to connect multiple components to the TracVision system. KVH recommends Channel Master model 6314IFD or equivalent. This active (powered) multiswitch amplifies the signal to compensate for signal loss. **A passive multiswitch will not provide the necessary amplification.**

Two Mobile Receiver/Controllers and One Standard-Def DVR

Components Required

- Two Splitter Kits, KVH P/N 72-0177
- (*TracVision M3/M2 only*) A Splitter Kit is included in the Extra Receiver Kit (P/N 01-0288-01).
- Destacker, Dual-output, KVH P/N 19-0410
- The special DC block (40V) splitter included in the Splitter Kit permits communications between the antenna and the primary receiver/controller. **A standard off-the-shelf splitter will not work.**

Why Do I Need a Dual-output Destacker?

- The output of the TracVision antenna is a special stacked signal, which the mobile receiver/controller is configured to decode. Since all DVRs are configured to decode unstacked signals, a dual-output destacker is needed to convert the antenna's stacked signal into two unstacked signals.

- A **dual-output** destacker is required because DVRs, such as TiVo, have two unstacked inputs, whereas standard receivers have only one input.

Adding the Second Mobile Receiver/Controller

- Refer to *“Two TracVision Mobile Receivers”* on page A.7 for details.

Recording Limitation

- Since the mobile receiver/controller controls satellite selection, the DVR can record any channel that is carried on the currently selected satellite; however it cannot record a channel that is carried on a different satellite. For example, if your mobile receiver/controller is tuned to a channel on the 119 satellite, you would not be able to record a program on the 101 satellite. You would need to switch to the 101 satellite on the mobile receiver/controller.

Appendix B Elevation Maps

Elevation Map for Satellite 101

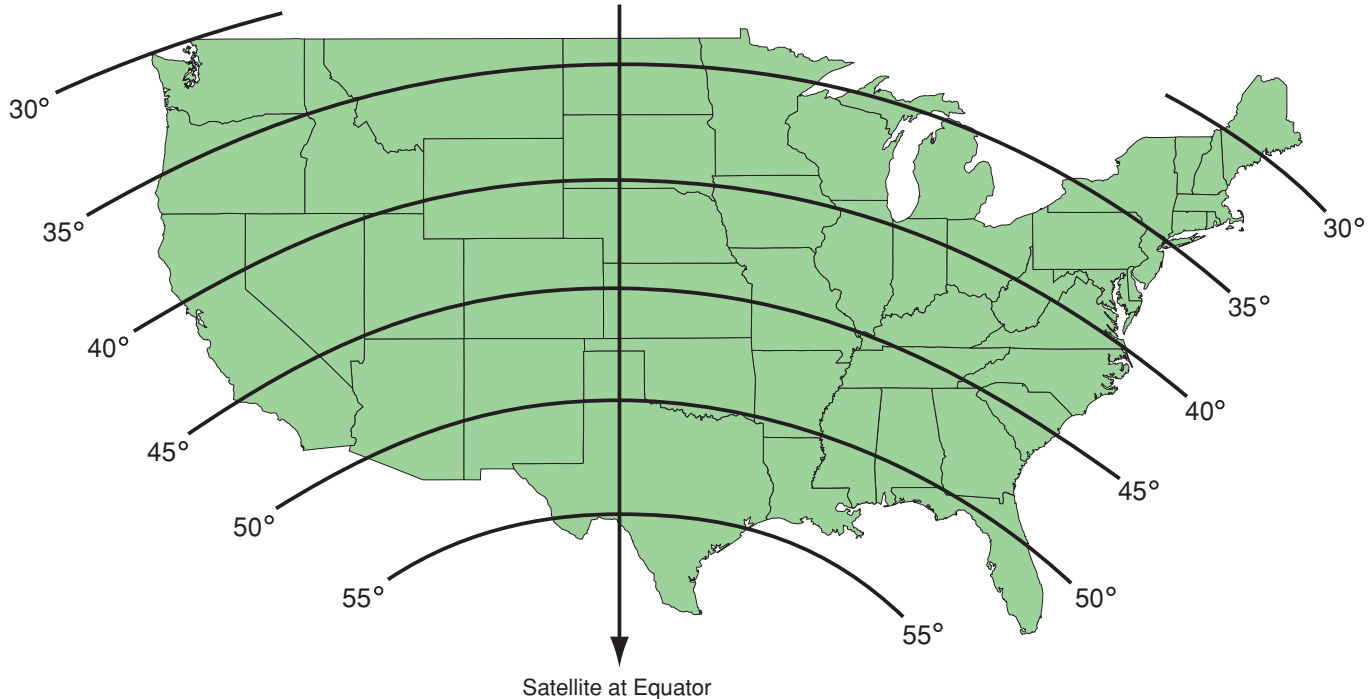

Elevation Map for Satellite 110

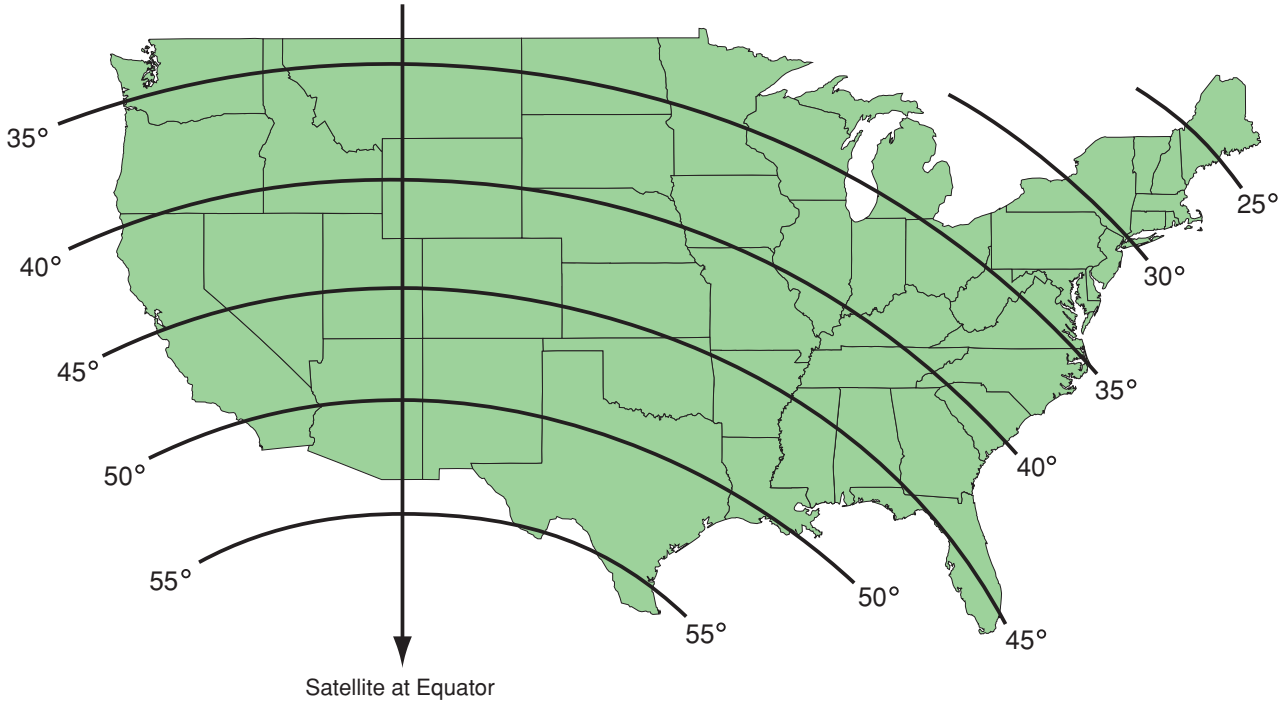

Elevation Map for Satellite 119

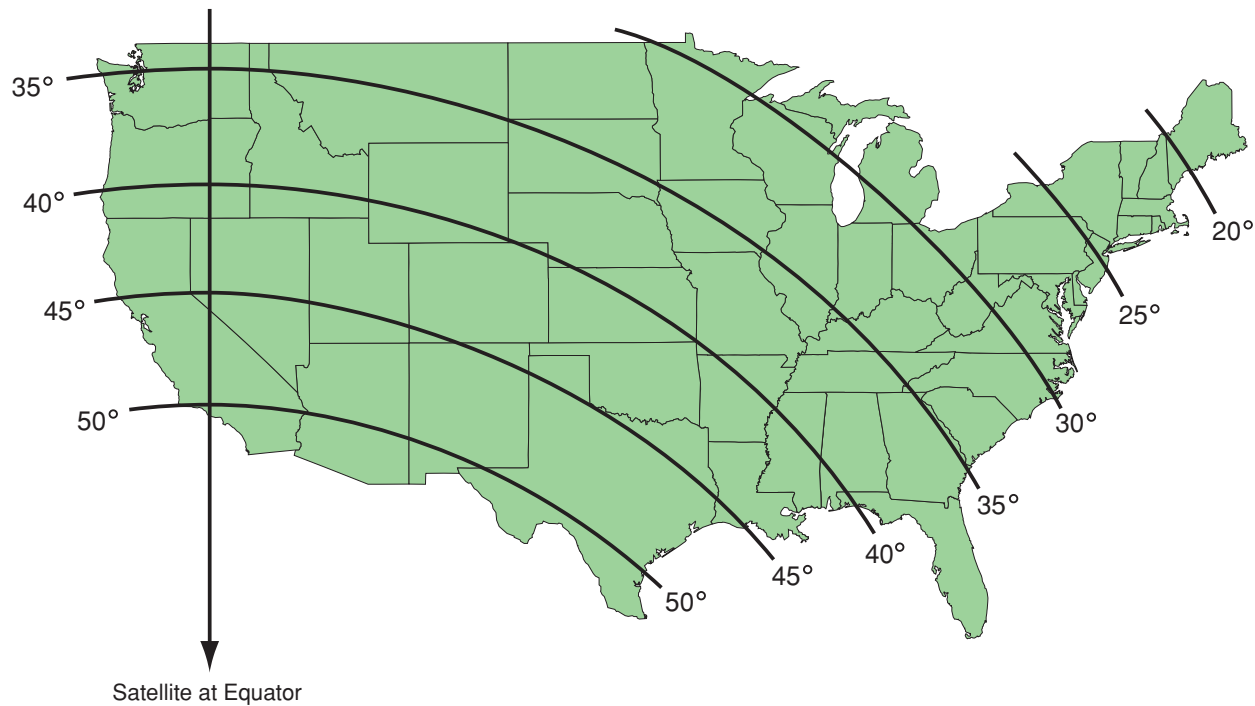

Elevation Map for Satellite 72.5

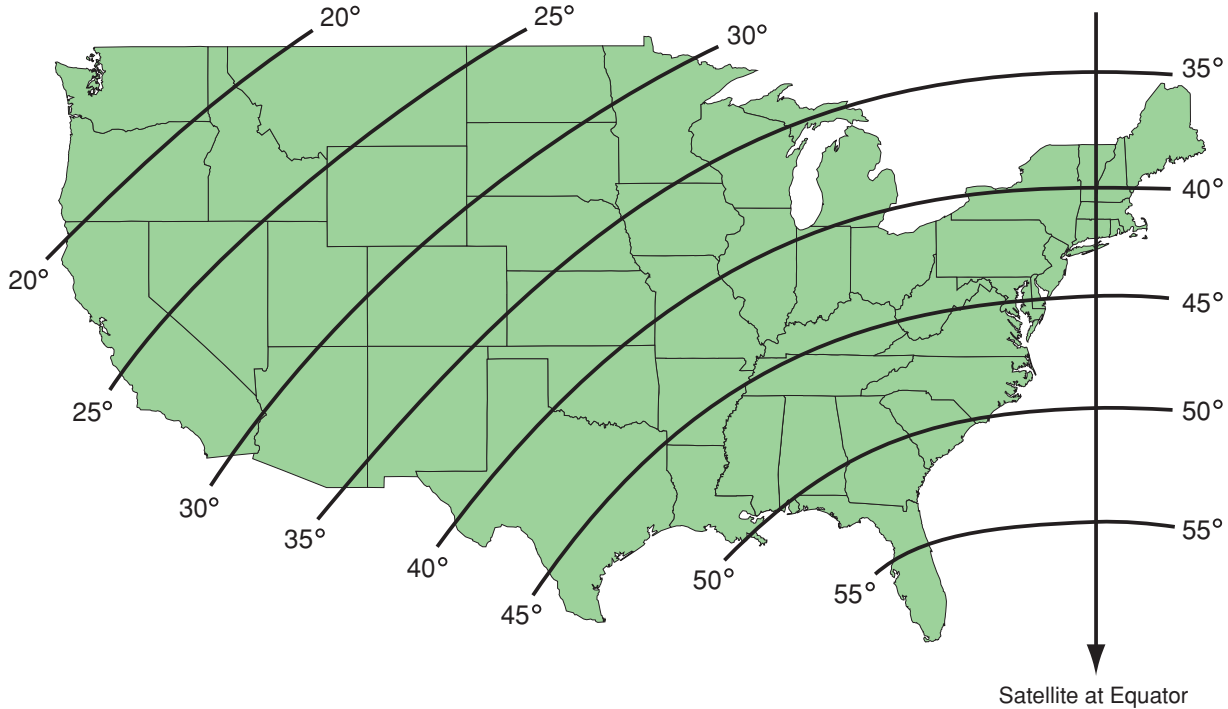

Index

A

- access card, 8.12
- accessories, A.3
- AC/DC power supply, A.5
- activate receiver, 10.6
- adjust audio settings, 8.3-8.4
- adjust video settings, 8.5
- advanced setup, 8.11-8.12
- amperage, fuse, 10.5
- Antenna light, 9.7, 10.10-10.11
- antenna unit
 - connect to receiver, A.4
 - controls, 9.3-9.10
 - current settings, 9.3
 - diagnostics, 10.12
 - repair, 10.9
 - serial number, 10.13
 - software versions, 10.14

- status, 10.12
- turn on, 2.3
- turn off, 2.5

- APG load type, 8.10
- arrows, in program guide, 5.5
- aspect ratio, 8.5
- audio adjustment, 8.3-8.4
- AUDIO button, 3.7
- audio/video input, 10.7
- audio/video system repair, 10.9
- automatic satellite switching, 9.8
- Auto Set, 6.5
- A/V jacks, A.5

B

- backlight, 3.3, 3.8
- balance, audio, 8.4
- banner style, 8.10
- batteries, remote control, 3.11
- beeping, receiver, 2.4, 9.5, 10.4

- blockage, 1.6, 10.3
- buttons, remote control, 3.3-3.8

C

- cable status, 10.12
- cabling diagrams, A.3
- Category Filter, 6.7
- caution, 3.3, 10.9, A.3
- center the menu, 8.5
- CH button, 3.6
- change channels, 2.5
- change remote ID, 3.10-3.11
- channel banner, 4.3, 8.10
- check mark, in program guide, 8.6
- checks, simple, 10.3
- choose satellites, 9.10
- CLEAR button, 3.6
- color scheme, menus, 8.5
- colors, program guide, 5.10
- commission receiver, *See activate receiver*

DIRECTV Mobile Receiver/Controller User's Guide

connecting additional receivers, A.3-A.21
connecting a DVR, A.16-A.21
connectors, receiver, A.4
control multiple receivers, 3.10-3.11
control other components, 3.9
coverage area, 1.5, 10.6
cross talk, 3.10

D

daylight saving, 8.10
default settings, 8.10
delete mail, 8.9
description, system, 1.4
Designated Market Area (DMA), 10.8
destacker, A.10-A.21
device code, 3.9
dew on antenna, 10.3, 9.4
DewShield, 9.4
diagnostics test, 8.12, 10.12

diagram, system, 1.4
digital video recorder (DVR), A.16-A.21
DIRECTOR buttons, 3.7
DIRECTV customer service, 7.4
DIRECTV receiver, home, A.10-A.19
dirt on antenna, 10.3
download the program guide, 2.4
DVD player control, 3.8, 3.9

E

elevation angle, 1.6, A.23
ellipsis, in guide field, 5.5
equator, 1.5
erase mail, 8.9
“Ext. 722” message, 10.3

F

Family list, 6.4, 7.3
FAV button, 3.5
favorite channel lists, 6.3-6.6

filter the program guide, 6.7-6.8
footprint, satellite, 1.5
fuse, 10.5
future programs, 6.8

G

“Go To” commands, 9.9
GPS position, 10.12
grid guide, 5.4
ground loop isolation, 10.9
GUIDE button, 3.4
guide load, speed, 8.10
Guide Options, 5.9-5.11
Guide Times, 6.8
guide zoom, 5.10
gyro status, 10.12

H

highlight, 1.3
HUGHES button, 3.8

I

ice on antenna, 10.6
icons, channel banner, 4.3
icons, menu, 4.5
INFO button, 3.5
initialize a new access card, 8.12
INPUT button, 3.8, 10.7
install batteries, 3.11
interference, remote controls, 3.10
IR eye, 3.9

J

joystick, 3.5

K

keyboard, 6.10

L

language, menu, 8.10
languages, alternate, 8.3-8.4

lights

Voltage, 10.10
Receiver, 10.10-10.11
Antenna, 10.10-10.11
limit exceeded message, 7.4
limit access, 7.3-7.7
local channels, 10.8, A.11
location of RF converter, 10.9

lock icon, 7.4

lock override icon, 7.4

lock up, receiver, 10.8

lock the system, 7.3-7.4

logo guide, 5.4

lost remote, 3.8

M

mail, 8.8

main menu, 4.5

manual satellite switching, 9.9

MENU button, 3.4

menu color scheme, 8.5
menu elements, 4.5
menu functions, table, 4.7-4.9
menu system, 4.5-4.6
moisture on antenna, 10.3
multiswitch, A.18-A.19
MUTE button, 3.6

N

new channels, 6.6
New Mail icon, 8.8
number buttons, 3.7

O

OneLine Guide, 5.6, 5.11
open circuit, 10.12
operate other components, 3.9
order a receiver, 3.10
order a remote control, 3.8
overload, 10.11
override lock, 7.4

P

part numbers, accessories, A.3
passcode, 7.4
picture-in-guide, 4.4, 5.10
power indications, 10.10, 10.12
power input, 10.5, A.4-A.5
power switch, receiver, 2.3, 10.5
power off the system, 2.5
power on the system, 2.3-2.4
power supply, A.5
preferences, system, 8.9-8.10
PREV CH button, 3.6
preview channel, 10.3, 10.6, 10.7
primary receiver, 9.6, A.7
PROG button, 3.7
Program Director, 8.6-8.8
program guide
 colors, meaning, 5.10
 description, 4.4

download, 2.4
filter, 6.7
future programs, 6.8
load type, 8.10
preferences, 5.9-5.11
styles, 5.3-5.4
use, 5.5

program, remote control, 3.9-3.11

Purchases tab, 4.8

PWR button, 3.4

R

rain, 10.3
ratings limits, 7.5-7.6
read mail, 8.8
receiver
 activation, 10.7
 beeps, 2.4
 connectors, A.4
 description, 1.4
 home, A.10-A.19
 lights, 10.10-10.11

multiple, A.3-A.21
order additional, 3.10
power switch, 2.3
primary, 9.6, A.7
repair, 10.9
secondary, 9.6, A.7
serial number, 10.13
software upgrade, 8.12
software version, 10.14
status, 10.12

Receiver light, 10.10-10.11

reception, 1.5-1.6, 10.3, 10.6

recording, DVR, A.17

recurring programs, schedule, 8.6

reload guide, 8.11

remote control

 batteries, 3.11
 buttons, 3.3
 change ID, 3.10-3.11
 description, 1.4
 order a replacement, 3.8
 programming, 3.9-3.11

remote control ID, change, 3.10-3.11
repairs, 10.9
replace batteries, 3.11
reset system, 10.3
RF converter
 connect to receiver, A.4
 description, 1.4
 distance from receiver, 10.8, A.5
RF level, 10.12
RF modulator, A.5

S

S-Video, A.5
safety warning, 3.3, A.3
SAT button, 3.4
satellite(s)
 available, 10.12
 choose, 9.10
 coverage area, 1.5, 10.6
 current, 9.3
 elevation angle, 1.6, A.23

 location, 1.5
 supported, 9.10
 switch, 9.8-9.9
scan for satellites, 8.11
schedule programs, 8.6-8.8
SEARCH button, 3.7
search for programs, 6.9-6.11
secondary receiver, 9.6, A.7
SELECT button, 3.5
select satellites, 9.8-9.10
serial numbers, 10.13
set guide preferences, 5.9-5.11
set system preferences, 8.9-8.10
setup, advanced, 8.11-8.12
short circuit, 10.11, 10.12
signal loss, A.9
silence beeper, 9.5
snow on antenna, 10.3
software upgrade, 8.12

software versions, 10.14
sort the program guide, 5.10
spending limit, 7.7
splitter, A.6-A.21
stacked signal, A.11
standby mode, 10.11
status lights, 10.10-10.11
switch satellites, automatic, 9.8
switch satellites, manual, 9.9
symptoms, troubleshooting, 10.4
system information, 8.11

T

tag box, 6.3
technical support, 10.15
test, 8.12, 10.12
time limits, 7.6-7.7
time zone, 8.10
TiVo, A.16-A.21
translucency, menu, 8.5

troubleshoot, 10.1
troubleshooting matrix, 10.4
TURBO button, 3.4
TurboTune, 5.7-5.9
turn beeper on/off, 9.5
turn DewShield on/off, 9.4
turn off the system, 2.5
turn on the system, 2.3-2.4
TV control, 3.6, 3.9

U

unlock the system, 7.5
unstacked signal, A.11

V

VCR control, 3.8, 3.9
vehicle power, A.5
video adjustments, 8.5
VIDEO button, 3.7
view mail, 8.8

VOL button, 3.6
Voltage light, 10.10
volume, 3.6

W

WatchWizard, 6.9-6.11
weak signal, 10.6
weather, inclement, 10.3
widescreen, 8.5
wiring diagrams, A.3-A.21

TRACVISION[®]

BY KVH INDUSTRIES

KVH[®]
www.kvh.com

KVH Industries, Inc. • 50 Enterprise Center • Middletown, RI 02842-5279 U.S.A. • Phone: (401) 847-3327 • Fax: (401) 849-0045 • E-mail: info@kvh.com