

TRACVISION[®]
BY KVH INDUSTRIES



**TracVision 12-Volt Receiver for DIRECTV[®] Service
User's Guide**

TracVision

Receiver User's Guide

Congratulations!

You have chosen TracVision, a revolutionary antenna system delivering *live* satellite TV entertainment on the go. With hundreds of channels of digital-quality TV and music to enjoy, traveling will never be the same!

This User's Guide provides all of the basic information you need to use the system's receiver and receive the DIRECTV satellite entertainment you want. For detailed installation information, please refer to the *TracVision Installation Guide*.



KVH Part # 54-0287 Rev. B

© 2005 KVH Industries, Inc., All rights reserved.



Trademarks

KVH® and TracVision® are registered trademarks of KVH Industries, Inc.

DIRECTV® and the Cyclone Design logo, DIRECTV INTERACTIVE, TOTAL CHOICE, DIRECTV HOME SERVICES, FREEVIEW, and DIRECT TICKET are trademarks of DIRECTV, Inc. All trademarks, marks, names, or product names referenced in this publication are the property of their respective owners, and KVH neither endorses nor otherwise sponsors any such products or services referred to herein.

Dolby Laboratories Information – Manufactured under license from Dolby Laboratories. “Dolby,” “Pro Logic,” and the double-D symbol are trademarks of Dolby Laboratories.

Macrovision® Information – Macrovision is a registered trademark of Macrovision Corporation. This device incorporates an anticopy process technology that is protected by U.S. patents 4,631,603; 4,577,216; 4,819,098; and other intellectual property rights. The anticopy process is licensed for noncommercial, home use only. Reverse engineering or disassembly is prohibited.

StarSight® Information – StarSight features licensed under one or more of the following patents: 4,706,121; 5,151,789; 5,353,121; 5,353,277; 5,479,266; 5,479,268; and 5,532,754. Use rights reserved.

TruSurround™ Information – TruSurround and the  symbol are trademarks of SRS Labs, Inc. TruSurround technology is incorporated under license from SRS Labs, Inc.

WINK® Information – WINK and the  symbol are registered trademarks of WINK Communications, Inc.

ENERGYSTAR® Information – ENERGYSTAR and the ENERGYSTAR certification mark are registered U.S. marks.

Software contained in the TracVision receiver and referenced in this manual is copyright ©1995-2005 by Hughes Network Systems, Inc., a wholly owned subsidiary of Hughes Electronics Corporation. Some features are patent pending. WatchWizard, PreSelect, TurboTune, and OneLine Guide are trademarks of Hughes Network Systems. “NFL,” the NFL Shield, and “NFL SUNDAY TICKET” are registered trademarks of the National Football League and its affiliates. “NHL,” the NHL Shield, and “NHL CENTER ICE” are registered trademarks of the National Hockey League. “MLB,” “MLB EXTRA INNINGS,” “Major League Baseball,” and the Major League Baseball silhouetted batter logo are service marks of Major League Baseball Properties, Inc. Major League Baseball trademarks and copyright are used with permission of Major League Baseball Properties, Inc. All other trademarks and service marks are the property of their respective owners.

Disclaimer

Every effort has been made to ensure the correctness and completeness of the material in this document. No company shall be liable for errors contained herein. The information in this document is subject to change without notice. No warranty of any kind is made with regard to this material, including, but not limited to, the implied warranties of merchantability and fitness for a particular purpose.

Note on recording programming

Most television programs and films are copyrighted. This means that someone has legal rights governing the reproduction and distribution of this material. In certain circumstances, copyright law may apply to private taping of copyrighted materials. In most cases, it is permissible to record for your personal use, as long as you do not sell the material. You must act responsibly in this area—check into the matter if you are unsure.

Some pay-per-view programs may be licensed from producers as “view-only” programs. These are copyrighted programs, and may not be copied or reproduced for any purpose without the express written permission of the copyright owner.

Important Safety Instructions - Please Read

For your safety and protection, read this safety section carefully.

Heed Cautions – Be sure to follow all cautions on the product and in the operating instructions. Cautions are indicated by a  icon.

Follow Instructions – Be sure to follow all operating instructions as detailed in this manual.

The following caution appears on the back of the receiver:



Do not open the receiver's cover. Opening or removing the cover may expose you to dangerous voltage.



WARNING!

Avoid Driver Distraction

It is dangerous to watch television or operate the remote control while you are driving a vehicle or vessel. TracVision is designed specifically to provide entertainment to passengers and should never be connected to active video screens visible to the vehicle/vessel driver while in motion. Failure to pay full attention to travel conditions could result in an accident or collision with personal injury or death resulting.

Do Not Attempt Repairs Yourself

Refer all servicing needs to qualified service personnel. Servicing is required when a unit has been damaged in any way or does not operate normally. Evidence of tampering or unauthorized repairs will void the warranty.

Federal Communications Commission (FCC) Regulatory Information for Vehicle Use

Declaration of Conformity – Standards to which Conformity is declared:
FCC Part 15

This device complies with Part 15 of the FCC Rules. Operation is subject to the following two conditions: (1) this device may not cause harmful interference, and (2) this device must accept any interference received, including interference that may cause undesired operation.

Responsible Party's Name: KVH Industries, Inc.

Address: 50 Enterprise Center, Middletown, RI 02842

Telephone: 1-401-847-3327

Trade Name: KVH

Type of Equipment: Satellite Receiver

Model Number: TracVision A5

Federal Communications Commission (FCC) – This equipment complies with Part 15 of the FCC rules.

Part 15 Compliance – This equipment has been tested and found to comply with the limits for a Class B digital device, pursuant to Part 15 of the FCC rules. These limits are designed to provide reasonable protection against harmful interference in a vehicle installation. This equipment generates, uses, and can radiate radio frequency energy and, if not installed and used in accordance with the instructions, may cause harmful interference to radio communications.

However there is no guarantee that interference will not occur in a particular installation. If this equipment does cause harmful interference to radio or television reception, which can be determined by removing and applying power to the equipment, the user is encouraged to try to correct the interference by one or more of the following measures:

- Increase the separation between the equipment and the receiver.
- Connect the equipment on a circuit different from that to which the receiver is connected.
- Consult the dealer or an experienced auto electronics technician for help.

The user may find the following booklet, prepared by the Federal Communications Commission, helpful: "How to Identify and Resolve Radio and TV Interference Problems." This booklet is available from the U.S. Government Printing Office, Washington, DC.

To meet FCC requirements, only components certified to comply with Class B limits may be attached to this device. Operation with noncertified peripherals is likely to result in interference to radio and TV reception.

To meet FCC requirements, shielded cables are required to connect the device to another Class B certified device.

Receiver Activation

NOTICE: *This product will NOT work correctly unless you follow the procedure below.*

Before you can start watching satellite TV via TracVision, the receiver must be activated. Once your antenna system is fully installed, follow the steps below to activate the receiver.

1. Ensure your antenna has a clear view of the sky then turn on your TracVision system and tune to the preview channel (channel 100).
2. Locate your red Activation Card.
3. Call KVH's Activation Department at:

1-866-551-8004

(24 hours a day, 7 days a week)



Please have the antenna and receiver serial numbers handy when calling to activate. The serial numbers are noted on the red Activation Card. The receiver cannot be activated without these numbers.

4. After activation is complete, KVH's Activation Department will provide an access card number, receiver ID number, Hughes serial number, and model number. Enter these numbers in the associated boxes on the red Activation Card.

Technical Support

The TracVision system has been designed with durability and low maintenance in mind. If you experience an operating problem or otherwise require technical assistance, please call your local authorized TracVision dealer/installer. If an authorized dealer/installer is not located nearby, contact KVH Technical Support directly:

Phone: **1-401-847-3327**

E-mail: techs@kvh.com

Internet: www.kvh.com/help

Send Us Your Comments About This Manual

If you have any comments regarding this manual, please e-mail them to manuals@kvh.com. Your feedback is greatly appreciated!

Table of Contents

1	Introduction	1.1
1-1	Using this Manual	1.3
1-2	System Overview	1.4
1-3	Receiving Satellite TV Signals	1.5
2	Getting Started	2.1
2-1	Turning On the Antenna	2.3
2-2	Changing Channels	2.5
2-3	Turning Off the Antenna	2.5
2-4	Viewing a Program Description	2.5
2-5	How the System Works	2.6
3	Using the Remote Control	3.1
3-1	Remote Control Functions	3.3
3-2	Receiver Front Panel Buttons	3.9
3-3	Programming the Remote Control to Operate Other Components	3.10
3-4	Controlling Multiple Receivers	3.11
3-5	Installing the Remote Control Batteries	3.12
4	Overview of Onscreen Displays	4.1
4-1	The Channel Banner	4.3
4-2	The Program Guide	4.4
4-3	The Menu System	4.5
5	Using Program Guides	5.1
5-1	Program Guide Styles	5.3
5-2	Using the Program Guide	5.5
5-3	Using the OneLine Guide	5.6
5-4	Using TurboTune for Quick Access to Favorite Channels	5.7
5-5	Setting Guide Preferences	5.9
6	Setting Favorites and Filters	6.1
6-1	Using Favorite Channel Lists	6.3
6-2	Filtering the Program Guide	6.7

6-3	Selecting Guide Times	6.9
6-4	Using WatchWizard to Search for Programs	6.10
7	Using Access Controls	7.1
7-1	Locking & Unlocking the System	7.3
7-2	Setting Ratings Limits	7.5
7-3	Setting Time Limits	7.6
8	Other Menu Functions	8.1
8-1	Adjusting Audio Settings	8.3
8-2	Adjusting Video Settings	8.5
8-3	Using the Program Director to Schedule Future Programs	8.7
8-4	Reading Mail from DIRECTV	8.10
8-5	Setting System Preferences	8.11
8-6	Advanced System Setup Functions	8.12

9	Troubleshooting	9.1
	Troubleshooting Matrix	9.3
9-1	Causes and Remedies for Common Operational Issues	9.4
9-2	Technical Support	9.13
9-3	System Status Lights	9.14
	Appendices	A.1
A	System Wiring Diagrams	A.3
B	Satellite Elevation Map	A.17

1 Introduction

This section provides a basic overview of this manual and the TracVision system. It also explains the three essentials for good satellite TV reception.

Contents

1-1	Using this Manual	1.3
1-2	System Overview	1.4
1-3	Receiving Satellite TV Signals	1.5

1-1 Using this Manual

This manual provides complete instructions for operating your TracVision receiver. Throughout this manual, important information is marked for your attention by the following icons:



A helpful tip that either directs you to a related area within the manual or offers suggestions on getting the highest quality out of your system.



An alert to important information regarding procedures, product specifications, or product use.



Indicates the most commonly used functions listed in *Section 3-1, "Remote Control Functions."*

Format Conventions

This manual uses the following typographical conventions to help clarify instructions:

Text Example	Description
...the MUTE button.	Remote control buttons
...the Cancel button.	Onscreen items

“Highlight”

For the purposes of this manual, the term “highlight” refers to the following operator action:

“Use the remote control’s joystick to move the highlight onto the desired onscreen item.”

Example: “Highlight the **Lock & Limits** tab” means “Use the remote control’s joystick to move the highlight onto the **Lock & Limits** tab.”

1-2 System Overview

Your TracVision system is a state-of-the-art, actively stabilized antenna system that delivers live satellite TV to your mobile audio/video entertainment system.

TracVision System Diagram (Typical Installation)

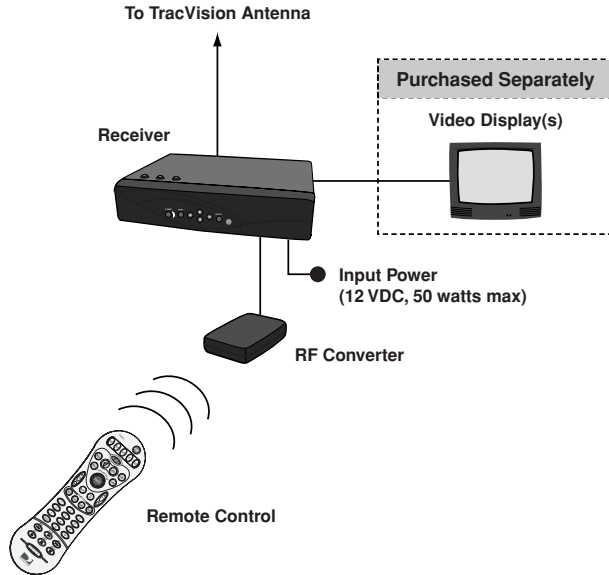

Receiver

The receiver decodes satellite TV signals from the antenna unit and sends the signals to the audio/video system. It also supplies power to the TracVision antenna.



Remote Control

The wireless RF/IR remote control allows you to control all receiver functions. The remote does not need to be pointed directly at the receiver for the signal to be received.



RF Converter

The RF converter receives RF commands from the remote control, converts them to digital signals, and sends them to the receiver for processing.



1-3 Receiving Satellite TV Signals

Like a satellite dish used at home, the TracVision antenna needs a clear view of the DIRECTV® satellite to receive satellite TV signals. Consider the three essentials noted on the following pages to ensure trouble-free reception.

Satellite Footprint

The DIRECTV satellite is located at a fixed position above the Earth's equator and beams TV signals down to North America. To receive TV signals from the satellite, you must be located within the satellite's coverage area, which encompasses much of the continental United States and coastal waters. As you approach the edges of this coverage area, the strength of the signal degrades, resulting in weaker reception.

DIRECTV Satellite Location



To view an up-to-date satellite coverage map, please visit KVH's web site at www.kvh.com/footprint.

Elevation Angle

Since the satellite is located above the equator, the TracVision antenna needs to point toward the southern sky to receive satellite TV signals. In addition, the antenna must be tilted at the proper elevation angle to point at the satellite. The further south you go, the higher the elevation becomes. For example, if you're in the Massachusetts area, the satellite is located 33° above the southern horizon. But if you go to South Carolina, the elevation increases to 45° .

While you're moving, the antenna inside the TracVision radome automatically rotates toward the southern sky and tilts to the proper elevation, ensuring you're always pointed at the satellite and receiving the satellite entertainment you want.

A map showing the DIRECTV satellite's elevation angles for the continental U.S. is provided on page A.17 of this manual.

Blockage

Since the TracVision antenna must have a clear view of the DIRECTV satellite to receive satellite TV signals, anything that stands between the antenna and the satellite can block the signal, resulting in lost reception. Common causes of blockage include trees, buildings, and bridges. Heavy rain, ice, or snow may also temporarily interrupt satellite signals.

Examples of Satellite Blockage

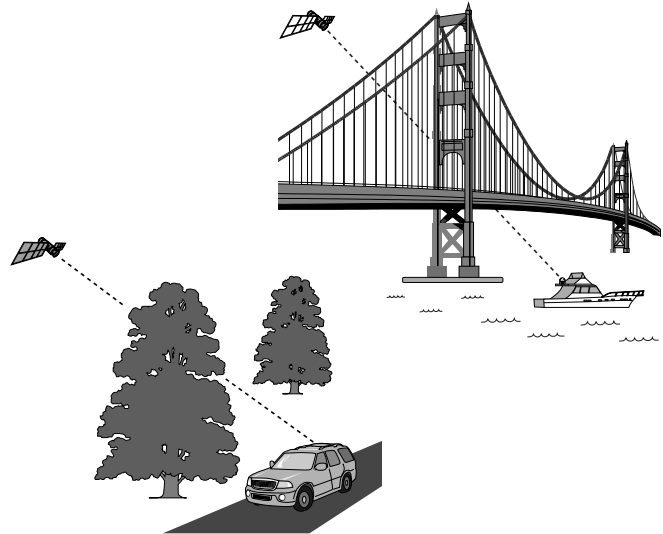

2 Getting Started

This section provides basic operation instructions, so you can quickly start using your TracVision system. It also briefly explains how the system works.

Contents

2-1	Turning On the Antenna2.3
2-2	Changing Channels2.5
2-3	Turning Off the Antenna2.5
2-4	Viewing a Program Description2.5
2-5	How the System Works2.6

2-1 Turning On the Antenna

To quickly start watching satellite TV using the TracVision system, follow the simple steps below.

1. Apply power to the TracVision receiver.
2. Turn on your TV and select the satellite input (*not the VCR input*).
3. Wait 30-60 seconds for the antenna to acquire the satellite signal. The TV will show the following:

Message 1

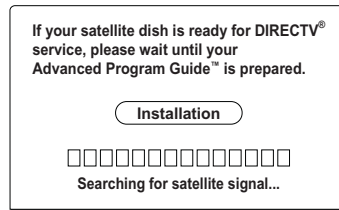

Message 2

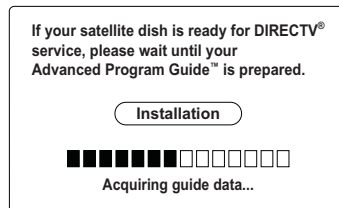

4. If Message 1 does not appear after 30 seconds, press the remote control's **SAT** button. Then press the remote's **PWR** button. The receiver beeps twice and its Antenna Power light comes on.

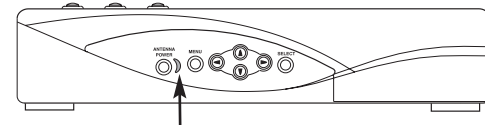
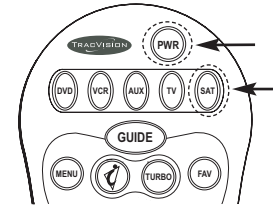

Antenna Power Light

5. If the receiver doesn't respond, check the Voltage status light on top of the receiver. If the Voltage light is off, check the rear panel power switch. If it is off, turn it on. The switch illuminates green. *This switch is normally left on at all times.*

Power Switch

Voltage Light

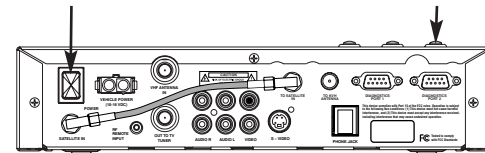





- If Message 2 does not appear after Message 1, ensure that the antenna has a clear view of the satellite. The antenna requires an unobstructed view of the sky to receive satellite TV signals.* Once the antenna locks onto the satellite, the receiver starts downloading the program guide. This may take up to 60 seconds.

Once the program guide has loaded, you can start enjoying satellite TV!**

* For details about satellite reception requirements, see page 1.5.

** If you can only view the DIRECTV Preview Channel, your receiver has not been activated. See page v.

Program Guide

PROGRAM GUIDE		Thu, Jun 23 • 10:00PM		
All Channels				
Nip/Tuck				
None • 10:00PM - 11:00PM				
Today	10:00 PM	10:30 PM	11:00 PM	11:30 PM
	Nip/Tuck		Rescue Me	
	Vegas Challenge		World Poker Tour	
	Showbiz Moms & Dads		Songwriters Hall of Fame	
	Yu-Gi-Oh!	Codename: Kids Next...	The New Scooby-Doo Movies	

2-2 Changing Channels

To change the channel, press the SAT button then select any of the following options:

- A** Press the CHANNEL (CH) button to tune to the next or previous channel.

or

- B** Using the numeric keypad, enter the channel number.

or

- C** Press the GUIDE button to bring up the **program guide**. While in the program guide, use the joystick or CHANNEL (CH) button to scroll through the list, and press the SELECT button to tune to a channel.

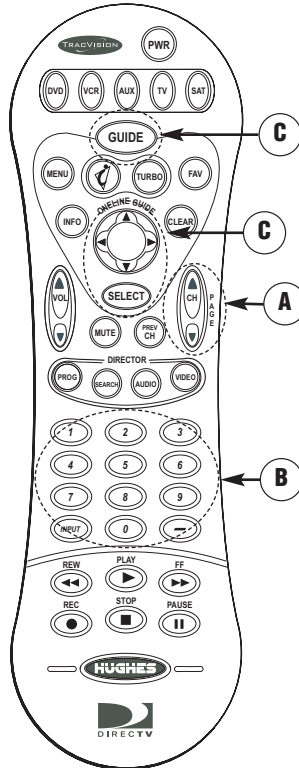

2-3 Turning Off the Antenna

To turn off the antenna, follow the steps below:

1. Press the remote control's SAT button. The button should blink red.
2. Press the PWR button. The receiver beeps once to indicate that power to the antenna is turned off.

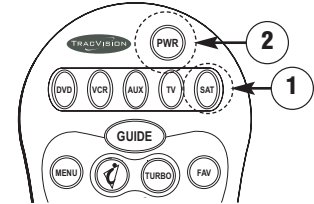

2-4 Viewing a Program Description

To view a description of the currently selected program, press the INFO button.

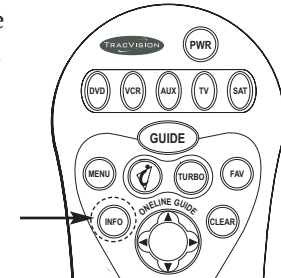

2-5 How the System Works

This section explains how the system starts up and how the antenna turns on and off. You do not need to read this section to operate the system. It is provided for information only.

System Startup

Whenever you apply power to the TracVision receiver, the system automatically starts up, regardless of whether the antenna was last turned on or off.

1. The receiver powers up. *The receiver's rear panel power switch must be turned on. Normally, this switch should remain on at all times.*
2. The receiver beeps two or three times and sends power to the antenna.
3. The antenna powers up and searches for the satellite signal. *You might hear slight mechanical noise as the antenna's internal motors operate.*

4. The antenna finds and starts tracking the DIRECTV satellite. *The antenna should become relatively quiet while tracking the satellite.*

The system exits the Startup mode after 30 seconds.

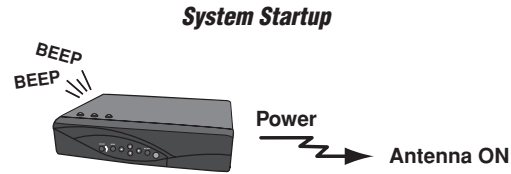

Why Does the Receiver BEEP?

The receiver beeps to indicate the status of the antenna.

2 beeps = Antenna is powering on

1 beep = Antenna is powering off

After 30-Second System Startup

Immediately following the 30-second system startup, the antenna will either power off or remain powered on, based on its last setting.

Whenever you turn off power to the receiver, the receiver saves the current status of the antenna (turned ON or turned OFF); and whenever you restore power, the system reverts to that setting after 30 seconds.

TracVision Antenna Is OFF:

1. The receiver **beeps once** and removes power from the antenna. The receiver's crescent-shaped front panel Antenna Power light stays off.
2. The antenna stops tracking the satellite and shuts down.

TracVision Antenna Is ON:

1. Following the 30-second system startup, the antenna stays powered on and continues to track the satellite.
2. The receiver does not beep, but its crescent-shaped Antenna Power light illuminates.

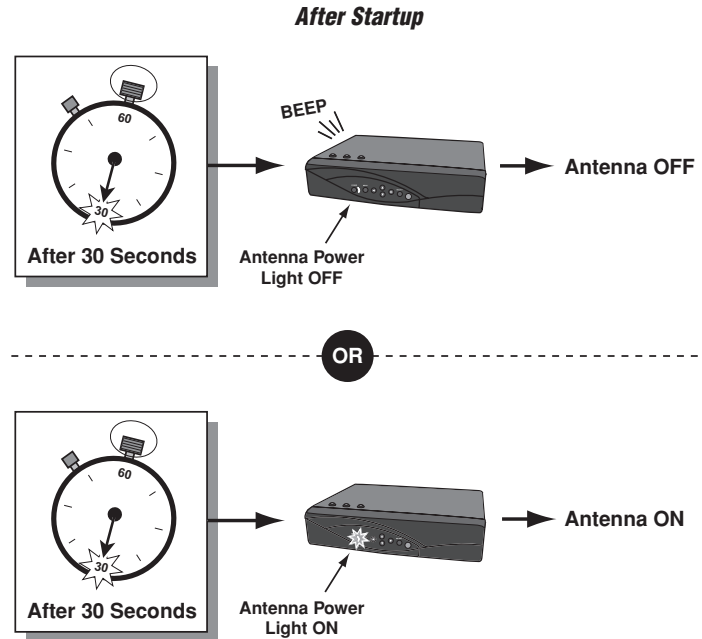

Turning On the Antenna

If the antenna is turned OFF, press the **SAT** button then the **PWR** button on the remote control to turn the antenna ON.

1. The receiver **beeps twice** and sends power to the antenna.
2. The receiver's crescent-shaped Antenna Power light illuminates.
3. The antenna powers up and searches for the satellite signal. *You might hear slight mechanical noise as the antenna's internal motors operate.*
4. The antenna finds and starts tracking the DIRECTV satellite. *The antenna should become relatively quiet while tracking the satellite.*

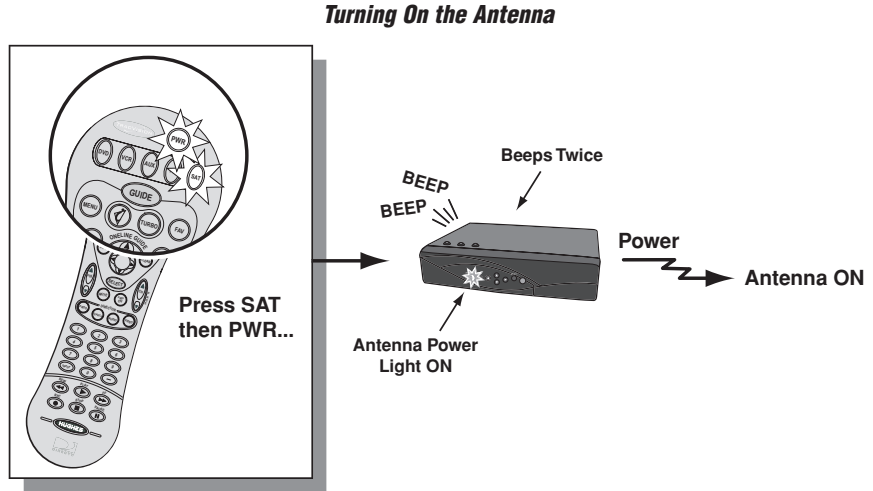

Turning Off the Antenna

If the antenna is turned ON, press the **SAT** button then the **PWR** button on the remote control to turn the antenna OFF.

1. The receiver **beeps once** and removes power from the antenna.
2. The receiver's crescent-shaped Antenna Power light goes out.
3. The antenna stops tracking the satellite and shuts down.

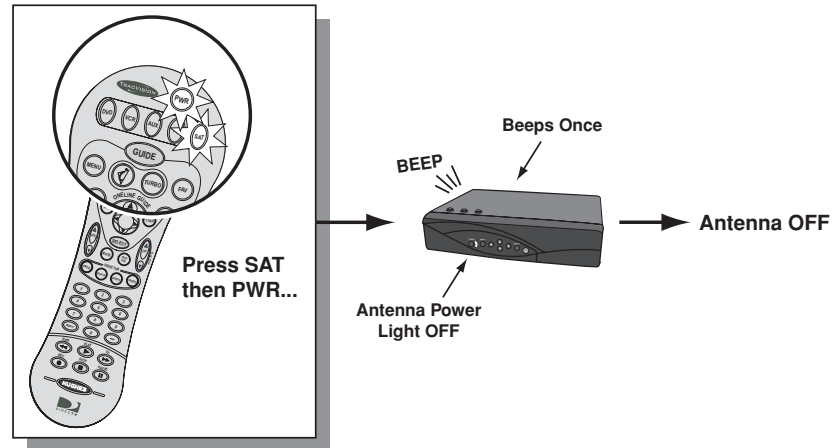

3 Using the Remote Control

This section explains how to use the remote control functions, program the remote to work with other components, and replace the remote control batteries.

Contents

3-1	Remote Control Functions	3.3
3-2	Receiver Front Panel Buttons	3.9
3-3	Programming the Remote Control to Operate Other Components	3.10
3-4	Controlling Multiple Receivers	3.11
3-5	Installing the Remote Control Batteries	3.12

TracVision Remote Control

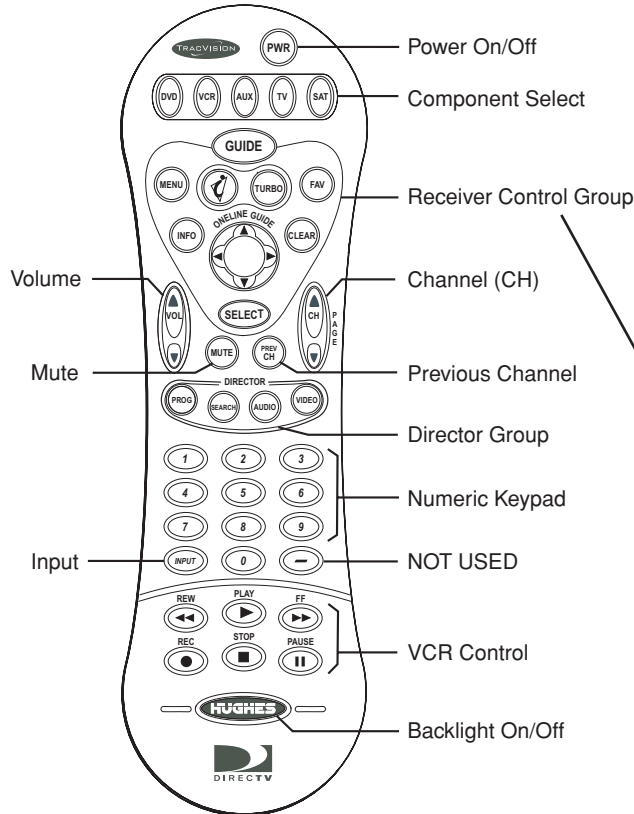

3-1 Remote Control Functions

Your system comes with an easy-to-use, backlit remote control that allows you to operate the receiver from virtually anywhere in the vehicle/vessel, day or night. This page shows the locations and names of the remote control buttons. The next few pages detail the buttons' functions. A  icon indicates the most frequently used functions.



*For your safety, this product must **NOT** be operated by the driver of the vehicle or vessel.*

Receiver Control Group

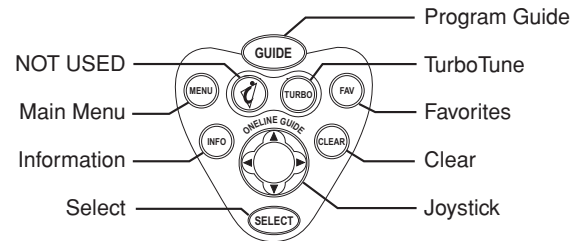

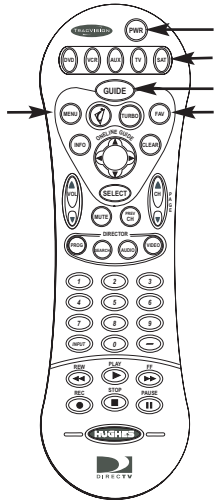

Press the PWR button to turn the selected component's power on/off. If the SAT button is currently selected, pressing the PWR button turns the TracVision antenna on/off.



Press the SAT component select button to control the TracVision receiver. To control a different component, press the associated component select button. For example, press the VCR button to control the VCR.



Press the GUIDE button to display the program guide. Press it a second time (while a program title is highlighted) to display the Category Filter menu. See *Section 5, "Using Program Guides,"* on page 5.1 for details.



Press the MENU button to bring up the main menu. The menu system allows you to access all system features and settings. See *Section 4-3, "The Menu System,"* on page 4.5 for details.



Press the TURBO button to display the TurboTune™ guide. TurboTune gives you quick access to 27 of your favorite channels. See *Section 5-4, "Using TurboTune for Quick Access to Favorite Channels,"* on page 5.7 for details.

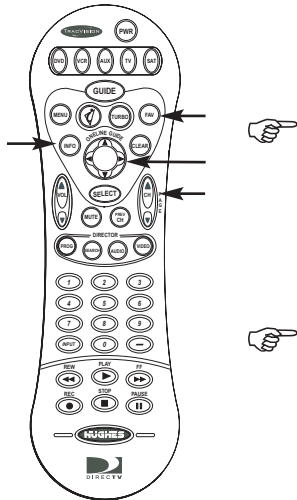

Press the FAV button to view listings for your favorite channels. You can set up four different lists of favorite channels. Each press of the FAV button brings up the next favorite channel list. See *Section 6-1, "Using Favorite Channel Lists,"* on page 6.3 for details.



Press the INFO button to display a brief description about the program you are viewing. If the program guide is displayed, the INFO button provides scheduling information about the highlighted program.



Use the joystick to move up, down, left, or right through the onscreen displays.

If you are currently watching a program, press the joystick up or down to display the OneLine guide. When the OneLine guide appears, press the joystick up or down to step to the next higher- or lower-numbered channel.



Press the SELECT button to activate or choose a highlighted menu option.



Press the CLEAR button to exit from any onscreen guide, remove banners, or cancel an action.



Use the VOLUME (VOL) button to raise or lower the volume on your TV (if the TV component button is selected). *The remote control must be programmed to operate your TV for the VOLUME button to work (see Section 3-3, "Programming the Remote Control to Operate Other Components," on page 3.10).*



Press the MUTE button to turn off the volume on your TV (if the TV component button is selected). *The remote control must be programmed to operate your TV for the MUTE button to work (see Section 3-3, "Programming the Remote Control to Operate Other Components," on page 3.10).*



Press the PREVIOUS CHANNEL (PREV CH) button to toggle between the current channel and the last channel you were watching.



Use the CHANNEL (CH) button to change the channel to the previous or next available channel. Also use it to scroll through a page of program guide listings.

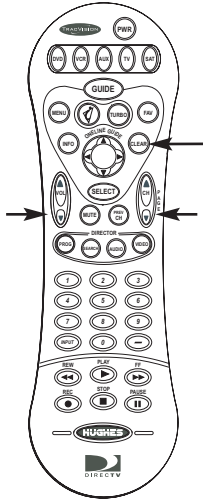

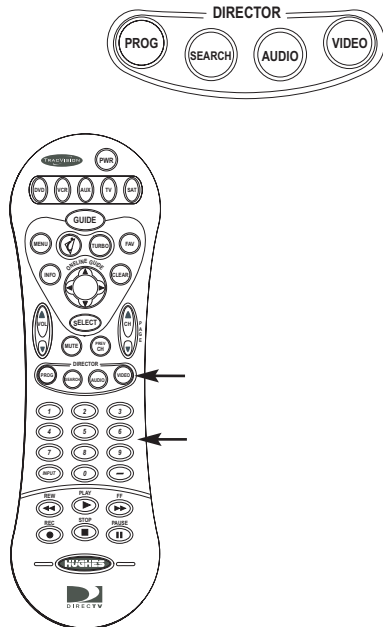

The DIRECTOR buttons provide convenient shortcuts to the following functions:

If the program guide is currently displayed, press the PROG button to use the program director, which allows you to program an event for viewing in advance. See *Section 8-3, "Using the Program Director to Schedule Future Programs,"* on page 8.7 for details.

Press the SEARCH button to bring up the WatchWizard™, which allows you to search for programs using criteria such as rating, showtime, language, and category. See *Section 6-4, "Using WatchWizard to Search for Programs,"* on page 6.10 for details.

Press the AUDIO button to bring up the audio adjustment menu. See *Section 8-1, "Adjusting Audio Settings,"* on page 8.3 for details.

Press the VIDEO button to bring up the video adjustment menu. See *Section 8-2, "Adjusting Video Settings,"* on page 8.5 for details.



Use the numeric keypad buttons (0 - 9) whenever you need to enter a specific number, such as a channel or a lock code.

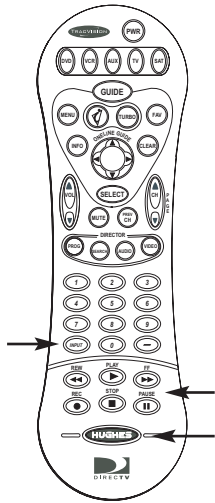

The INPUT button allows you to select a video feed from another source such as a VCR. Repeatedly press INPUT to cycle through each available input source in your system.

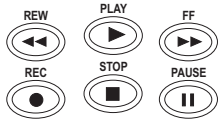

Use the VCR control buttons to operate your VCR or DVD player (the VCR component button must be selected first). *The remote control must be programmed to operate your VCR/DVD player for the VCR control buttons to work (see Section 3-3, "Programming the Remote Control to Operate Other Components," on page 3.10).*



Press the HUGHES button to turn the remote control's backlight on/off.

3-2 Receiver Front Panel Buttons

If you don't have the remote control handy, you can operate the system using the receiver front panel buttons. You can turn the antenna on/off, bring up the main menu, navigate through the menu system, and select menu items from the receiver's front panel. The crescent-shaped Antenna Power light is lit if the antenna is turned on.



If you lose your remote control, please call or visit your local KVH authorized dealer to order a replacement.

Buttons Available on Both Remote Control and Receiver Front Panel

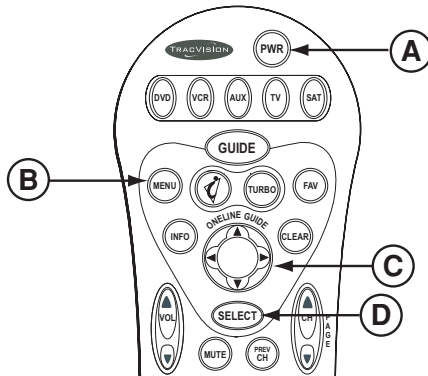

**Remote Control
Buttons**

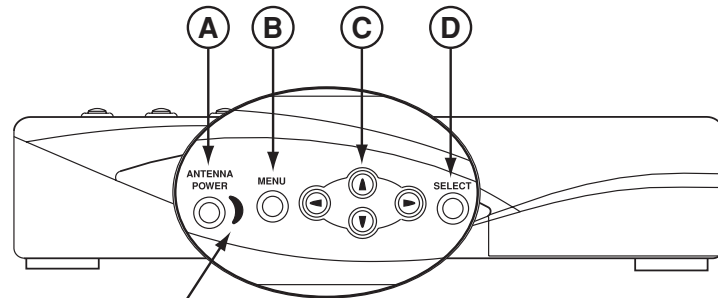

Antenna Power Light

**Receiver Front Panel
Buttons**

3-3 Programming the Remote Control to Operate Other Components

In addition to controlling the satellite receiver, you may be able to operate your TV, VCR, DVD, or AUX components using your TracVision remote control. To program your remote control, follow the steps below.

1. Keep the remote control aimed at the IR input (or "eye") for the component you want to control. For example, if you want to program the remote control to operate the TV, keep the remote aimed at the TV's IR input.
2. Press and hold the remote control's component button (for example, TV).
3. At the same time, press the MUTE button for two seconds.
4. Release both buttons.

The component button should light and remain lit. If it doesn't remain lit, repeat Steps 1 through 4 above.

5. Repeatedly press the upper part of the CHANNEL (CH) button.
6. Continue pressing the CHANNEL (CH) button to step through the codes until the component turns off, indicating that you have found the correct device code. *If you accidentally pass a code that responds or realize you may not have been aiming the remote control at the component, repeatedly press the lower part of the CHANNEL (CH) button to step backward through the codes.*
7. Press the remote control's PWR button to verify that you have found the proper code. The correct code will turn the component on and off.
8. Press the component button again to lock in the code (in this example, the TV button).

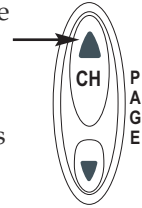

To operate a component, first press the desired component button (DVD, VCR, AUX, TV, or SAT). Then use the remote control buttons that apply to that component. *For example, the VOLUME (VOL) and MUTE buttons apply only to a TV; the VCR control buttons apply only to a VCR or DVD player.*

3-4 Controlling Multiple Receivers

If you are using multiple KVH receivers, you can change a remote control ID to avoid interference or “cross talk” between the two remotes. The remote control ID can be a number from “001” to “008.”

For example, if you have two receivers, you can set one receiver and remote to 001 and the other receiver/remote to 002. That way, the 002 remote cannot operate the 001 receiver, and the 001 remote cannot operate the 002 receiver.



For details on ordering an additional TracVision receiver, please call or visit your local KVH authorized dealer/installer.

To set a remote control and receiver to use a different remote ID, follow the steps below.

1. First turn off the rear panel power switch on the receiver you do **not** wish to change.

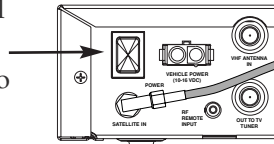

2. Turn on the receiver you want to change.
3. Press the MENU button to access the main menu.
4. From the main menu, highlight the **System Setup** tab and press SELECT.
5. Highlight the **Remote** tab to access Remote Control Settings.

Remote Control Code Entry

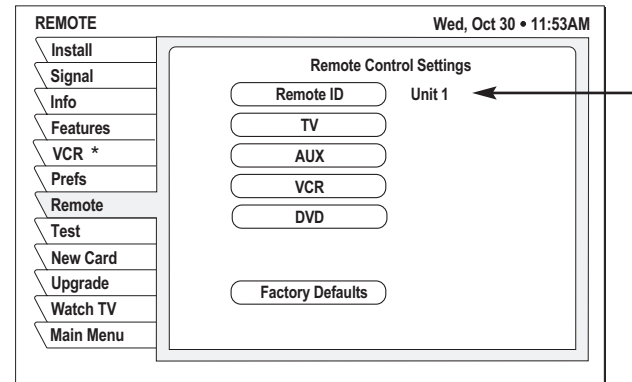

* VCR tab not available

6. Highlight the **Remote ID** button.

7. Press and hold the SAT button.
8. At the same time, press the MUTE button for two seconds.
9. Release both buttons. The SAT button should remain lit. If it doesn't, repeat Steps 7-9.
10. Enter the desired ID number ("001" to "008") using the numeric keypad.
11. Press the SAT button to lock in the code.
12. Press the SELECT button twice.

The number to the right of the highlighted **Remote ID** button will change to the new code. Check that the ID has been set properly by testing the remote control to ensure that it controls the satellite receiver.

3-5 Installing the Remote Control Batteries

To install or replace the remote control's batteries, follow the steps below.

1. Remove the battery compartment cover, located on the back of the remote control.

Remote Control Batteries

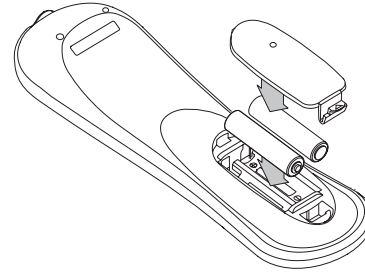

2. Insert two AAA batteries as shown, observing the correct polarity.
3. Replace the battery compartment cover.

4 Overview of Onscreen Displays

This section introduces the three types of onscreen displays: the Channel Banner, the Program Guide, and the Menu System.

Contents

4-1	The Channel Banner	4.3
4-2	The Program Guide	4.4
4-3	The Menu System	4.5

4-1 The Channel Banner

Whenever you change channels while you are watching TV, the channel banner appears at the top of the screen. You can also display the channel banner by pressing the INFO button while watching TV.

The channel banner displays the following information:

- Currently selected channel and program
- Description of the currently selected program
- Date/time
- Icons may appear below the date/time to indicate system status or details about the program

The channel banner disappears from the screen after a few seconds. Or press the CLEAR button to remove the channel banner immediately.

Channel Banner

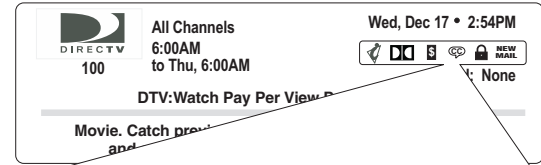

Icon	\$				NEW MAIL			CAN'T TAPE	ALT. AUDIO	DATA SVGS.	FULL DAY	
Meaning	Pay per view	Interactive programming available	Dolby Digital audio available	Closed caption available	Unread mail	Limits enforced	Limits override	Taping not allowed	Other audio available	Data available	All Day Ticket	Letter Box format





4-2 The Program Guide

To display the program guide, press the GUIDE button. You can also access the program guide from the menu system's **Program Guide** tab.

The program guide displays the following information:

- Listing of current programs and up to seven days of future programming
- Short description of the program currently highlighted
- Date/time
- Icons may appear below the date/time to indicate system status or details about the program currently highlighted
- If the picture-in-guide feature is enabled, video of the currently selected channel appears in the upper right corner of the screen

Program Guide

PROGRAM GUIDE		Thu, Jun 23 • 10:00PM		
All Channels				
Nip/Tuck				
None • 10:00PM - 11:00PM				
				
Today	10:00 PM	10:30 PM	11:00 PM	11:30 PM
	Nip/Tuck		Rescue Me	
	Vegas Challenge		World Poker Tour	
	Showbiz Moms & Dads		Songwriters Hall of Fame	
	Yu-Gi-Oh!	Codename: Kids Next...	The New Scooby-Doo Movies	

For details on how to use the program guide, see *Section 5, "Using Program Guides,"* on page 5.1.

With favorite channel lists and category filters, you can easily customize the channel guide to show only those channels or programs of interest to you. See *Section 6, "Setting Favorites and Filters,"* on page 6.1 for details.

4-3 The Menu System

To display the main menu, press the MENU button.

The menu system gives you access to all system functions and settings. The common elements of all menus are noted below.

The following icons appear in several menus:



Toggle or Step - Press SELECT to toggle (switch) a setting from “on” to “off” *or* to step through the available choices each time you press SELECT.



List of Options - Menu button will display a list of choices in a pop-up menu when you press SELECT.



Series of Boxes - Multiple screens will appear in a series requesting that you enter numbers and/or letters for the particular feature when you press SELECT.

Main Menu

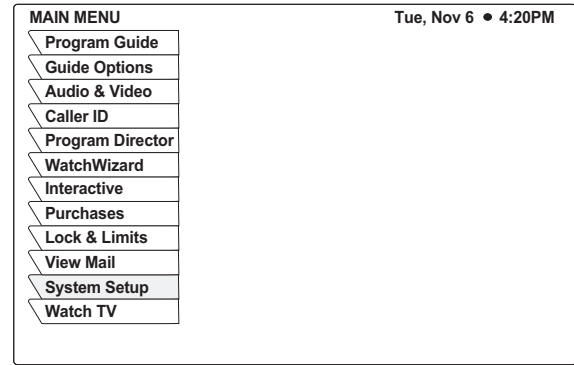

Menu Elements

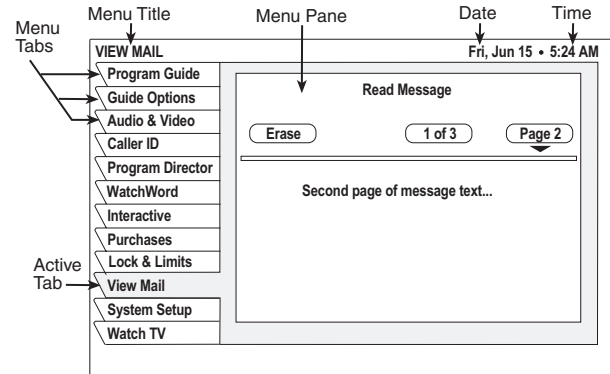

To move the highlight:

Use the joystick to move the highlight within the menus.

To select a menu item:

Highlight the desired menu item and press the SELECT button to select a main menu item or execute an action.

To exit a menu or cancel an action:

Press the CLEAR button to exit a menu or cancel an action.

The following pages list all of the functions accessible from the menu system. These functions are explained in detail in later sections of this manual.



*You will not be able to use the **Caller ID**, **Interactive**, or **Purchases** tabs. These functions require a phone line connection, which is not possible with TracVision.*

Main Menu Tab	Screens	Functions	See Page:
Program Guide	Program Guide	<ul style="list-style-type: none"> • View and modify the program guide 	5.1
Guide Options	Theme	<ul style="list-style-type: none"> • Filter the program guide by program category 	6.7
	Times	<ul style="list-style-type: none"> • Change the time period shown in the program guide 	6.9
	Fav List	<ul style="list-style-type: none"> • Select a specific channel list (Fav. A, Fav. B, Fav. C, Family, or New Channels) to be an active program guide 	6.4
	Fav Setup	<ul style="list-style-type: none"> • Create and edit a channel list (Fav. A, Fav. B, Fav. C, Family, or New Channels) 	6.3
	Options	<ul style="list-style-type: none"> • Set Guide Options: <ul style="list-style-type: none"> - Guide style (grid or logo) - Picture in guide (on/off) - Guide zoom (on/off) - Multi-color (on/off) - Channel sort (numeric or alphabetical) - Filters (temporary or persistent) - Reset options to default settings 	5.9
	Set Turbo	<ul style="list-style-type: none"> • Set and edit TurboTune channels 	5.7

Main Menu Tab	Screens	Functions	See Page:
Audio & Video	Audio	<ul style="list-style-type: none"> • Set default audio language and alternate audio language • Set left/right audio balance • SRS TruSurround (on/off) 	8.3
	Video	<ul style="list-style-type: none"> • Select screen ratio (4:3 or 16:9) • Center menus on your monitor (up/down and right/left) • Color scheme, onscreen display translucency, and color balance 	8.5
Caller ID	Caller ID	NOT USED	--
Program Director	Schedule	<ul style="list-style-type: none"> • Automatically tune to programs at a specific date/time 	8.7
WatchWizard	WWSetup	<ul style="list-style-type: none"> • Search for programming using specific words and other criteria 	6.10
	WWResult	<ul style="list-style-type: none"> • Display search results 	6.11
	Channels	<ul style="list-style-type: none"> • Search for channels based on categories of programming 	6.12
Interactive	Interact	NOT USED	--
Purchases	Upcoming	NOT USED	--
	Past	NOT USED	--

Main Menu Tab	Screens	Functions	See Page:
Lock & Limits	Lock	<ul style="list-style-type: none"> Lock and unlock the system 	7.3
	Fav Setup	<ul style="list-style-type: none"> Create a program listing containing only selected channels 	6.3
	Ratings	<ul style="list-style-type: none"> Set maximum program rating allowed for viewing 	7.5
	Limits	<ul style="list-style-type: none"> Set viewing times and maximum viewing hours 	7.6
View Mail	Mail	<ul style="list-style-type: none"> Read messages from DIRECTV 	8.10
System Setup	Install	NOT USED	--
	Signal	NOT USED	--
	Info	<ul style="list-style-type: none"> Display receiver information 	8.13
	Features	<ul style="list-style-type: none"> Display current receiver features 	8.13
	Prefs	<ul style="list-style-type: none"> Adjust user-selectable system settings 	8.11
	Remote	<ul style="list-style-type: none"> Change the remote ID 	3.12
	Test	<ul style="list-style-type: none"> Initiate a simple diagnostics test 	8.13
	New Card	<ul style="list-style-type: none"> Prepare a new access card 	8.13
	Upgrade	<ul style="list-style-type: none"> Display upgrade status and history 	8.13

5 Using Program Guides

This section explains how to select a program guide style, use the different guide features, and set guide preferences.

Contents

- 5-1 Program Guide Styles5.3
- 5-2 Using the Program Guide5.5
- 5-3 Using the OneLine Guide5.6
- 5-4 Using TurboTune for Quick Access
to Favorite Channels5.7
- 5-5 Setting Guide Preferences5.9

5-1 Program Guide Styles

You can set up the program guide to present information using either of two styles:

- Grid
- Logo

The following sections explain how to select a style and describe the features of each style.

Selecting a Guide Style

To select a guide style, follow the steps below.

1. Press the GUIDE button twice to display the **Guide Options** menu [or select **Guide Options** from the main menu].



When the program guide is onscreen, simply press the GUIDE button once to display the Guide Options menu.

2. Highlight the **Options** tab.

Selecting a Guide Style

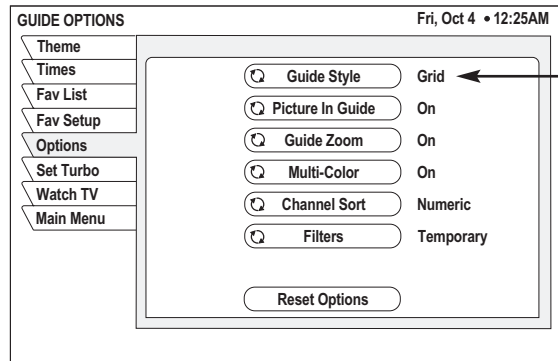



3. Highlight the **Guide Style** button.
4. Press the SELECT button to toggle between **Grid** and **Logo** guide styles.
5. Press the CLEAR button to return to the program you were viewing.

Grid Guide

- Easy to see what programs are available at a particular time.
- Lists up to seven days of current and upcoming programming.
- The program title and description appear above the grid as you highlight each program.





















Grid Guide

PROGRAM GUIDE		Thu, Jun 23 • 10:00PM		
All Channels				
Nip/Tuck				
None • 10:00PM - 11:00PM				
Today	10:00 PM	10:30 PM	11:00 PM	11:30 PM
	Nip/Tuck		Rescue Me	
	Vegas Challenge		World Poker Tour	
	Showbiz Moms & Dads		Songwriters Hall of Fame	
	Yu-Gi-Oh!	Codename: Kids Next...	The New Scooby-Doo Movies	

Logo Guide

- Select your favorite channels, rather than selecting specific programs.
- Only current programming can be selected from the logo guide.
- The current program title and description appear above the logo grid as you highlight each channel.

Logo Guide

LOGO GUIDE		Thu, Feb 7 • 6:00PM		
All Channels				
<p>A description of the program currently airing on the highlighted network menu appears here, if available.</p>		<p><u>Picture-in-Guide</u></p> <p>An image of the currently airing program highlighted in the menu selection appears here</p>		
Title of the program on the network selected in menu				
				
				
				
				

5-2 Using the Program Guide

To display the program guide:

Press the GUIDE button to bring up the guide.

To move the highlight:

Use the joystick to move the highlight within the guide.

Move the highlight to the right to show future programming. Move the highlight up/down to scroll through the listing. Move the highlight onto a channel icon to view that channel's current program in the picture-in-guide window (*if enabled*).

To scroll up/down one page:

Press the CHANNEL (CH) button up/down to scroll through a full page of guide entries at a time.

To jump to a specific channel listing:

Use the numeric keypad to enter the channel number to go directly to the listing for a specific channel.

To view a program's description:

Press the INFO button for a full description of the highlighted program.

To tune to a program:

Press the SELECT button to tune to a highlighted program. *The program must be currently in progress.*

To exit the guide:

Press the CLEAR button to exit the program guide.



Cells with arrows indicate the program started at an earlier time or continues later than can be shown in the selected time period.



If program information cannot entirely fit in the space provided, an ellipsis (...) indicates that a portion of the title is not shown.

5-3 Using the OneLine Guide

The OneLine Guide, which appears at the bottom of your screen, displays a single line from the program guide, starting with the currently viewed channel.

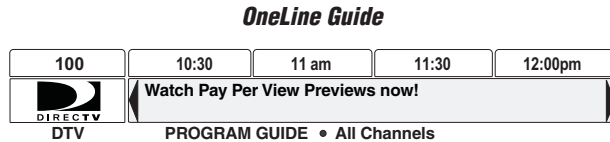

To display the OneLine Guide:

Press the joystick up or down while watching TV to bring up the OneLine guide.

To move the highlight:

Use the joystick to move the highlight within the guide.

Move the highlight to the right to show future programming. Move the highlight up/down to display the next or previous channel.

To show the OneLine Guide for a specific channel:

Use the numeric keypad to enter the channel number to display the OneLine Guide for that channel.

To view a program's description:

Press the INFO button to display current or future program information in the channel banner.

To tune to a program:

Press the SELECT button to tune to a highlighted program.

To exit the guide:

Press the CLEAR button to exit the OneLine guide.

5-4 Using TurboTune for Quick Access to Favorite Channels

The TurboTune feature gives you quick access to 27 of your favorite channels. Three groups of nine of your favorite channels are available as Turbo 1, Turbo 2, and Turbo 3.

Setting TurboTune Channels

To set up channels in TurboTune, follow the steps below.

1. Press the TURBO button, then highlight the **Setup** button and press SELECT [or select **Guide Options** from the main menu, then highlight the **Set Turbo** tab].

TurboTune Guide

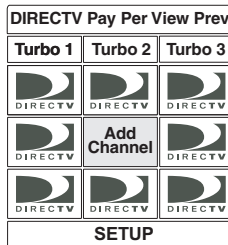

2. Highlight a vacant channel box (shows “Add Channel”) and press SELECT. *Or you can highlight an occupied box instead to overwrite its set channel with your new selection.*
3. Using the joystick or the CHANNEL (CH) button, choose the desired channel in the setup box (shown below) and press SELECT. *You can also use the numeric remote control buttons to enter a specific channel number.*

Adding a Channel to TurboTune

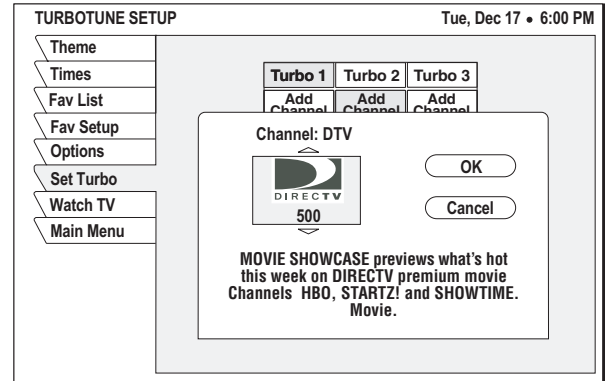









4. Highlight the **OK** button and press SELECT.

Adding the Current Channel to TurboTune

If you want to add the channel you're currently watching to TurboTune, follow the steps below.

1. Press the TURBO button to display the TurboTune guide.

TurboTune Guide

DIRECTV Pay Per View Prev		
Turbo 1	Turbo 2	Turbo 3
		
	Add Channel	
		
SETUP		

2. Highlight a vacant channel box (shows "Add Channel") and press SELECT to add the channel you are watching to the TurboTune guide.

Selecting a Channel from TurboTune

To tune to a channel in TurboTune, follow the steps below.

1. Press the TURBO button.



Press the TURBO button to cycle through Turbo 1, Turbo 2, and Turbo 3 program groups while the TurboTune guide is onscreen.

2. Highlight the channel you want to watch and press SELECT.

Renaming TurboTune Groups

You can rename each nine-channel TurboTune group to anything you choose, using up to 10 letters, numbers, spaces, etc. For example, Turbo 1 could be renamed “Mom” and Turbo 2 renamed “Dad.”

To rename a group, follow the steps below.

1. Press the TURBO button [*or* select **Guide Options** from the main menu and highlight the **Set Turbo** tab].
2. Highlight the grid name (**Turbo 1**, **Turbo 2**, or **Turbo 3**) that you want to rename and press SELECT.
3. Use the onscreen keyboard to enter the new name (to enter a letter on the keyboard, highlight the letter and press SELECT).
4. Once you’ve entered the desired name, highlight the **OK** button and press SELECT.

*To redo the entry, highlight the **Clear** button and press SELECT. To cancel the change, press the **CLEAR** button [*or* highlight the **Cancel** button and press SELECT].*

5-5 Setting Guide Preferences

The Guide Options menu allows you to customize the appearance and behavior of onscreen guides.

To set guide preferences, follow the steps below.

1. Press the GUIDE button twice while watching a program [*or* select the **Guide Options** tab from the main menu].
2. Highlight the **Options** tab.

Guide Options

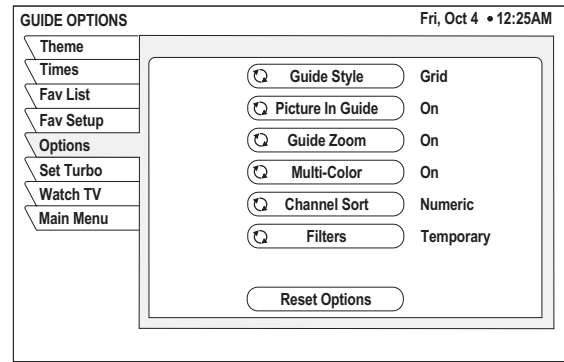

3. Highlight the menu button for the setting you wish to modify:

Guide Style

Press SELECT to choose either **grid** or **logo** style of program guide. See *Section 5-1, "Program Guide Styles,"* on page 5.3 for details.

Picture In Guide

Press SELECT to turn the picture-in-guide feature on/off. If turned on, video of the currently selected program appears in a small box when you're viewing the program guide.

Guide Zoom

Press SELECT to turn guide zoom on/off. If turned on, and the picture-in-guide feature is turned on, video of the currently selected program "zooms in" to the small screen when the program guide is selected. If turned off, the "zooming" animation from full screen to small screen is disabled.

Multi-Color

Press SELECT to turn multi-color on/off. If turned on, program cells appear in different colors, based on their type of content. The four colors are as follows:

Color	Category
Orange	News
Green	Sports
Purple	Movies
Blue	Other

If multi-color is turned off, all cells are blue in color.

Channel Sort

Press SELECT to choose either **numeric** or **alpha**. If numeric, the program guide is sorted by channel number. If alpha, the program guide channels are sorted alphabetically.

Filters

Press SELECT to choose either **temporary** or **persistent**. If temporary, the filters you apply are active only while the program guide remains onscreen; once you exit the program guide, all filters are cleared. If persistent, the filters you apply remain active after you exit the program guide.

6 Setting Favorites and Filters

This section explains how to set up lists of favorite channels, filter the program guide by category and time, and search for programs based on content.

Contents

6-1	Using Favorite Channel Lists	6.3
6-2	Filtering the Program Guide	6.7
6-3	Selecting Guide Times	6.9
6-4	Using WatchWizard to Search for Programs	6.10

6-1 Using Favorite Channel Lists

Favorite channel lists help you organize the hundreds of available channels into more manageable groups. Each of the four lists can contain as many or as few channels as you wish. You can customize these groups in several ways. For example, Fav. A could be Dad's favorite channels, Fav. B could be Mom's favorites, Fav. C could be the kids' channels, and Family could be all channels that Mom and Dad have deemed appropriate for the entire family.

Creating a Channel List

1. Press the MENU button to access the main menu.
2. Highlight the **Guide Options** or **Lock & Limits** tab from the main menu and press SELECT.
3. Highlight the **Fav Setup** tab and press SELECT to open the Favorite List Setup pane.

Favorite List Setup

Fri, Sep 18 • 6:00 PM

FAVORITE LIST SETUP

Theme

Times

Fav List

Fav Setup

Options

Set Turbo

Watch TV

Main Menu

List: MYLIST

Channel	✓	□	□	✓	
120 • WABC	✓	□	□	✓	Auto Set
121 • WQED	✓	□	□	✓	Rename
122 • ESPN	□	□	□	✓	Add All
123 • HBOW	✓	□	□	✓	Delete All
New Channels	26				New Chan

Quality entertainment for the whole family, featuring animated XYZ classics, original series, entertainment specials, and movies. Included at no additional charge in DIRECTV TOTAL CHOICE Packages.

The four columns of small boxes are called tag boxes. The first three columns of tag boxes are the Fav. A, Fav. B, and Fav. C. channel lists. The last column is the Family list.

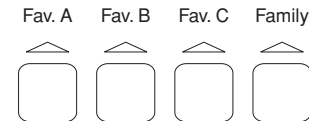



If the Family list has not had any channels added to it, and the receiver is locked, no channels can be viewed without first unlocking the receiver. To avoid this inconvenience, create the Family list before locking the receiver. See Section 7, "Using Access Controls," on page 7.1 for details about controlling system access.

4. In the desired channel list column, highlight the tag box for the channel that you want to add or remove. *Use the joystick or CHANNEL (CH) button to scroll up or down to view other channels.*
5. Press SELECT to add or remove the check mark in the tag box. A check mark indicates that the channel is included in the favorite channel list. (In the example on the previous page, WABC is included in the Fav. A and Family channel lists, but not the Fav. B or Fav. C channel lists.)
6. When you have added all of the channels that you want in your list, press the CLEAR button to resume watching TV.

Switching Between Favorite Lists

Once you have created your favorite channel lists, use the remote control's FAV button to cycle through them quickly and easily. Each press of the FAV button brings up the next favorite channel list. [You can also select a list by highlighting the **Fav List** tab from the Guide Options menu.] Only channels that are set up in the selected favorite channel list will be accessible for viewing.

Favorite Lists

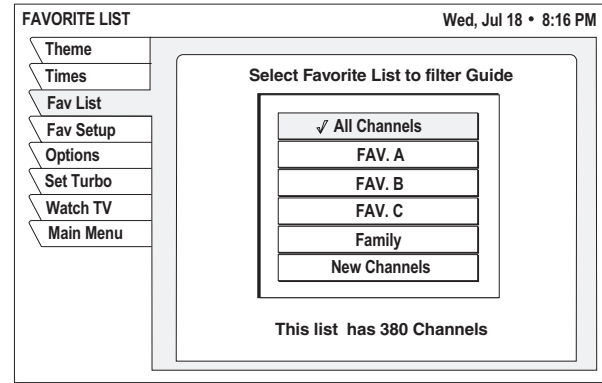

Renaming a Channel List

1. At the Favorite List Setup pane, highlight the **Rename** button and press SELECT.

A Rename List menu appears. You can rename the first three lists. You cannot rename the All or Family lists.
2. Highlight the list you wish to rename and press SELECT.
3. Use the onscreen keyboard to enter the new name (to enter a letter on the keyboard, highlight the letter and press SELECT).
4. Once you've entered the desired name, highlight the **OK** button and press SELECT.

*To redo the entry, highlight the **Clear** button and press SELECT. To cancel the change, press the **CLEAR** button [or highlight the **Cancel** button and press SELECT].*

Generating an Auto Set List

The Auto Set function generates a complete list of viewable channels.



Auto Set may exclude some channels, such as the Music Choice channels, or include some pay per view channels. This does not mean that the receiver is faulty. These channels were excluded or included due to the receiver's analysis process. You can manually edit the list to correct these oversights.

To generate an Auto Set list, follow the steps below.

1. At the Favorite List Setup pane, highlight the **Auto Set** button and press SELECT.
2. Highlight a favorite channel list to be programmed and press SELECT.

It may take several minutes for the receiver to scan through all channels and determine which ones you're authorized to receive. The scan results will be stored in the selected favorite channel list.

Adding and Removing Channels

To add or delete a channel from a selected favorite channel list, follow the steps below.

To add all available channels to a favorite list:

1. At the Favorite List Setup pane, highlight the **Add All** button and press SELECT.
2. Highlight the list you wish to modify and press SELECT.

To remove all channels from a favorite list:

1. At the Favorite List Setup pane, highlight the **Delete All** button and press SELECT.
2. Highlight the list you wish to modify and press SELECT.

To add or delete individual channels from a favorite list:

At the Favorite List Setup pane, highlight the tag box for the particular channel you wish to add or remove and press SELECT. A check mark indicates that the channel is included in the selected favorite channel list. An empty tag box indicates that the channel is excluded from the list.

Finding New Channels

Occasionally, new channels are added to the available programming selections. The number of channels that have been added since you created your channel list appears in the New Channels window on the Favorite List Setup pane. To view these channels in the lists, highlight the **New Channels** button and press SELECT.

Favorite List Setup

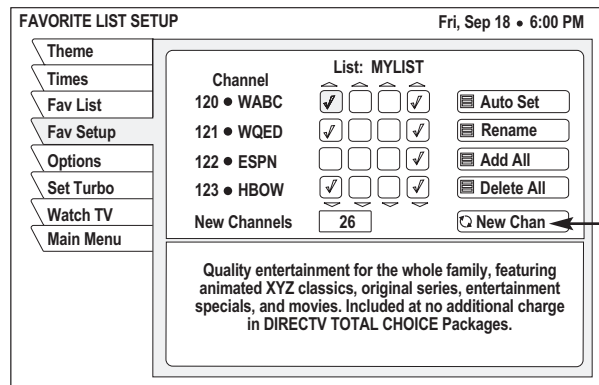

6-2 Filtering the Program Guide

The Category Filter menu allows you to filter the program guide to show just those channels that match your viewing interests.

To filter the guide by program categories, such as movies, sports, or news, follow the steps below.

1. Press the GUIDE button twice while watching TV [*or* select the **Guide Options** tab from the main menu]. *If the Program Guide is currently displayed, press the GUIDE button just once.*
2. Highlight the **Theme** tab.

Category Filter

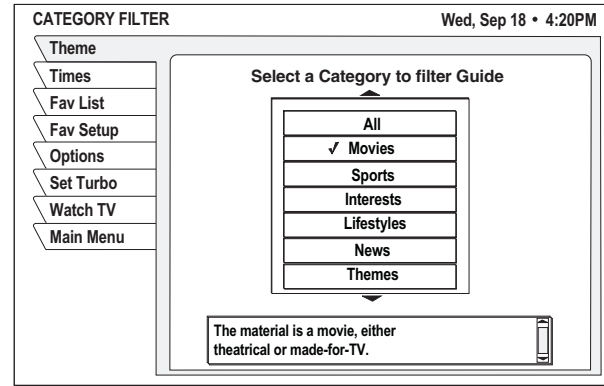

3. Highlight a category (other than **All**) and press **SELECT**.
4. A subcategory menu appears, allowing you to further refine a chosen theme (*see the illustration on the following page*). To choose a subcategory, highlight the subcategory and press **SELECT**.

For example, if you select the Movies category, you can then refine your selection using a subcategory such as Action/Adventure, Animation, Biography, Comedy, and others as shown below.

Filtering by Movie Categories

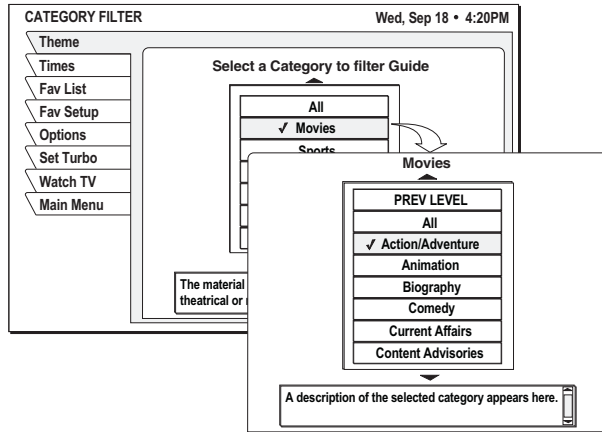

Once you've selected a category/subcategory, the program guide will be filtered to show only those channels offering programs of the selected category and subcategory. In this example, the guide would only display channels featuring Action/Adventure movies.

6-3 Selecting Guide Times

The Guide Times menu provides easy access to future programming information.

To advance the guide to a future day/time period, follow the steps below.

1. Press the GUIDE button twice while watching TV [or select the **Guide Options** tab from the main menu]. *If the Program Guide is currently displayed, press the GUIDE button just once.*
2. Highlight the **Times** tab.
3. Highlight the **AM/PM** button and press SELECT to toggle between **AM** and **PM**.
4. Highlight the day you want the guide to begin and press SELECT.

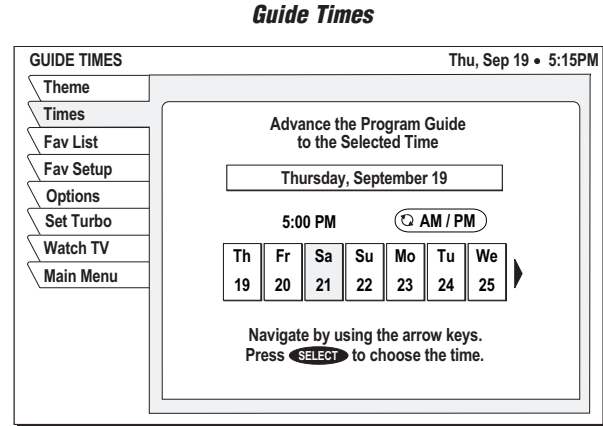

6-4 Using WatchWizard to Search for Programs

WatchWizard allows you to search for programs using criteria such as rating, showtime, language, and category. You can even search for a specific word found in program titles or descriptions. WatchWizard can store up to eight separate searches using any combination of criteria and text.

Performing a Search

1. Press the SEARCH button [or select the WatchWizard tab from the main menu].
2. Highlight the WWSetup tab.
3. Highlight one of the eight search buttons and press SELECT.
4. A search menu appears where you can enter your search criteria. Narrow your search results by combining multiple criteria. To choose a criteria, highlight the associated button and press SELECT.

WatchWizard Program Searches

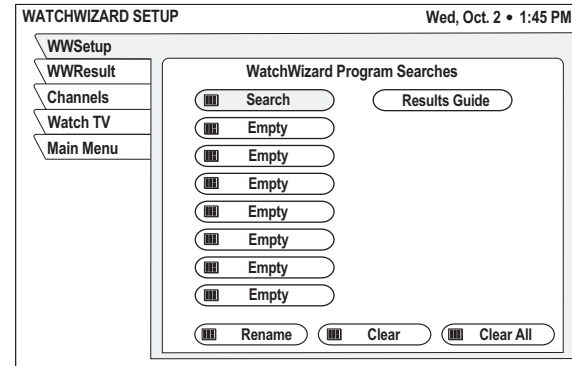

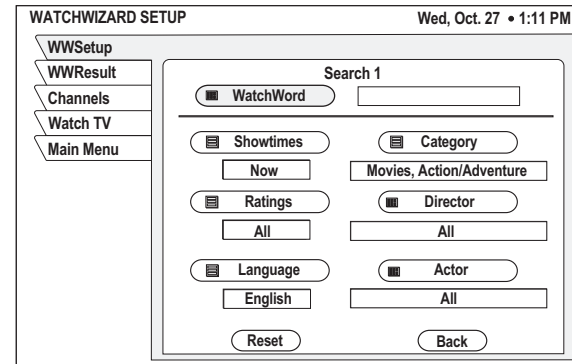

WatchWizard Search Menu

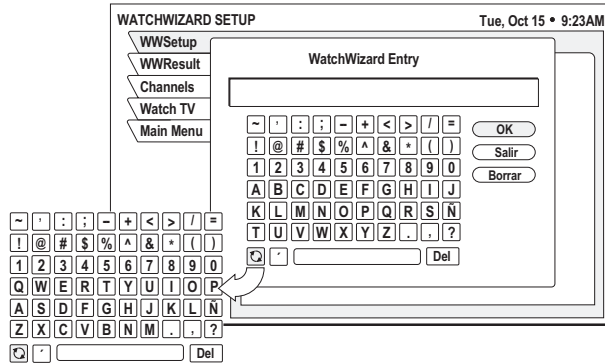

To enter text, use the onscreen keyboard (to enter a letter on the keyboard, highlight the letter and press SELECT). Once you've entered the desired text, highlight the **OK** button and press SELECT.

WatchWizard Keyboard Entry



If you prefer, you can change the keyboard to a standard (QWERTY) layout. Simply highlight the toggle icon  on the default button board and press SELECT.

Viewing Search Results

To view a list of programs matching your search criteria, highlight the **WWResult** tab. To view the search results as a guide, highlight the **Results Guide** button on the **WWSetup** tab and press SELECT.

WatchWizard Results

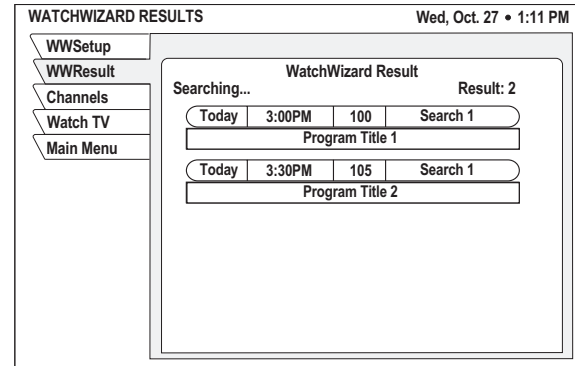

When a program guide is onscreen, press the **SEARCH** button on the remote control to automatically highlight programs matching your search results. Press the **SEARCH** button again to highlight the next result, based on starting time.

Using the Channels Search

You can also search for channels that offer a specific type of programming by using the category-based channels search.

1. Press the SEARCH button while watching TV [*or* select the **WatchWizard** tab from the main menu].
2. Highlight the **Channels** tab.
3. Highlight the **Category** button and press SELECT.
4. Highlight the desired category from the list and press SELECT.
5. A subcategory menu appears, allowing you to further refine your search. To choose a subcategory, highlight the subcategory and press SELECT. A list of channels offering the selected type of programming appears.

Channels Search

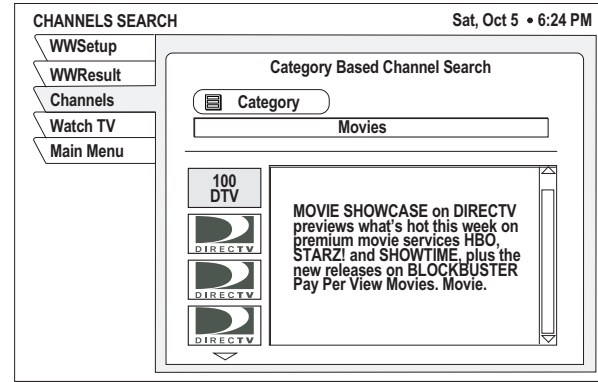

7 Using Access Controls

This section explains how to lock and unlock the system using a passcode. It also explains how to set rating and time limits.

Contents

- 7-1 Locking & Unlocking the System7.3
- 7-2 Setting Ratings Limits7.5
- 7-3 Setting Time Limits7.6

7-1 Locking & Unlocking the System

You can easily set limits to restrict the viewing of satellite TV programming. When accompanied by the channel lists, these limits provide a great degree of control.

When you first install the TracVision receiver, it will be unlocked. That is, no limits or restrictions are in effect. To enforce limits (ratings, TV timer, and “Family” favorite list), you must lock the system using a passcode.



Once the system is locked, only existing Family list channels will be accessible. If the Family list does not contain any channels, no channels can be viewed without first unlocking the system. To avoid this, verify the contents of the Family list before locking the receiver. See Section 6-1, “Using Favorite Channel Lists,” on page 6.3 for details.

Locking the Receiver

To lock the system, follow the steps below.

1. Press the MENU button to access the main menu.
2. Highlight the **Lock & Limits** tab and press SELECT.
3. Highlight the **Lock** tab to display the Parental Lock pane.
4. Highlight the **Lock** button and press SELECT.

Parental Lock

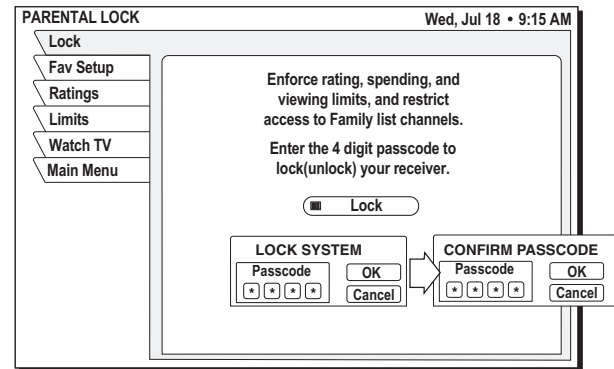

5. The Lock System pop-up panel appears. Enter a four-digit passcode using the remote control's numeric keypad.
6. Highlight the **OK** button and press SELECT.



*To abort the locking process, highlight the **Cancel** button and press SELECT.*

7. Enter the code again to confirm, then highlight the **OK** button and press SELECT.

Once you select OK, the satellite receiver is locked. You must enter the proper passcode to unlock it. A lock icon appears in the program guide and channel banner to remind you that the system is locked.



If you forget your four-digit code, please call DIRECTV at 1-800-DIRECTV (347-3288).

Overriding the System Lock

When the system is locked, inaccessible channels will show a "limit exceeded" message. To temporarily override the system lock, follow the steps below.

1. While the "limit exceeded" message is onscreen, press SELECT.
2. Enter your four-digit passcode using the remote control's numeric keypad.
3. Highlight the **OK** button and press SELECT.

An icon indicating lock override appears under the date/time whenever the program guide or channel banner is displayed.



Unlocking the System

To remove the lock and all of its restrictions, follow the steps below.

1. Press the MENU button to access the main menu.
2. Highlight the **Lock & Limits** tab and press SELECT.
3. Highlight the **Lock** tab.
4. Highlight the **Unlock** button and press SELECT.



The button used to lock the system is also used to unlock the system.

5. Use the remote control's numeric keypad to enter the same code you entered to lock the system.
6. Highlight the **OK** button and press SELECT. *To abort and keep the lock in effect, highlight the **Cancel** button and press SELECT.*

Once the system is unlocked, all limits and restrictions are removed!

7-2 Setting Ratings Limits

Ratings help you to determine whether a program's content is appropriate for a particular audience. To select the maximum ratings limits that can be viewed on your system, follow the steps below.

1. Press the MENU button to access the main menu.
2. Highlight the **Lock & Limits** tab and press SELECT.
3. Highlight the **Ratings** tab.

Ratings Limits Setup

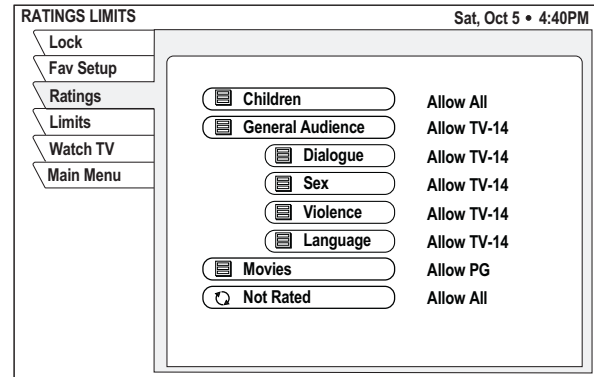

4. Highlight the button for the type of programming you want to restrict and press SELECT.
5. Highlight the maximum rating you want to allow (for the selected type of programming) from the pop-up submenu and press SELECT. *You may choose **Block All** or **Allow All** instead of setting a specific limit.*

Ratings Limits

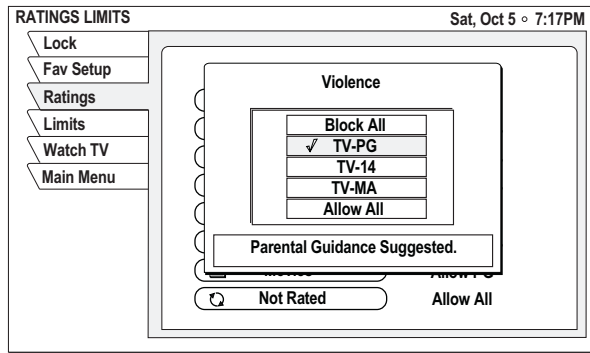

Remember, limits are only active while the system is locked. If the system is unlocked, all restrictions are removed.

7-3 Setting Time Limits

You can restrict your system to allow viewing only during specific hours and/or a maximum number of hours. To set time limits, follow the steps below.

1. Press the MENU button to access the main menu.
2. Highlight the **Lock & Limits** tab and press SELECT.
3. Highlight the **Limits** tab.

Maximum Viewing Limits

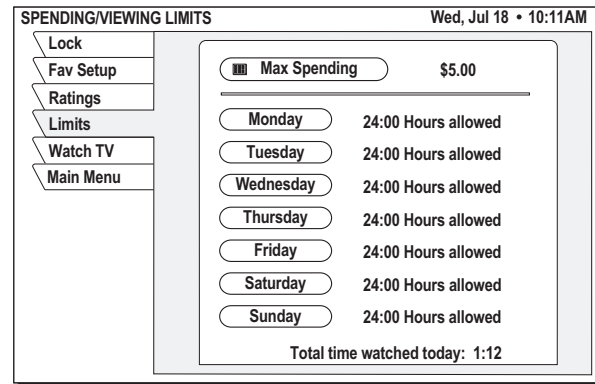



The **Max Spending** button is not applicable to your TracVision system.

4. Highlight the day of the week that you want to limit and press SELECT.
5. a. If you want to limit the maximum number of viewing hours for that day, highlight the **Total Time** button and use the remote control's numeric keypad to enter the limit.

Setting Maximum Viewing Hours

SPENDING / VIEWING LIMITS Wed, May 9 • 4:50 PM

Lock
Fav Lists
Ratings
Limits

Max Spending \$10.00

Saturday Viewing Time Limit

From N/A Through N/A -OR- Total time 18:00 OK Cancel

Thursday 24:00 Hours allowed
Friday 24:00 Hours allowed
Saturday 18:00 Hours allowed
Sunday 24:00 Hours allowed

- b. If you want to limit that day's viewing to a specific time period, highlight the **From** button and use the remote control's numeric keypad to set the earliest time. Then highlight the **Through** button and set the latest time.

Setting Allowable Viewing Times

SPENDING / VIEWING LIMITS Wed, May 9 • 4:50 PM

Lock
Fav Lists
Ratings
Limits

Max Spending \$10.00

Saturday Viewing Time Limit

From 10:00 AM Through 11:30 PM -OR- Total time N/A OK Cancel

Thursday 24:00 Hours allowed
Friday 24:00 Hours allowed
Saturday 9:30 Hours allowed
Sunday 24:00 Hours allowed

6. Highlight the **OK** button and press SELECT.



Remember, limits are only active while the system is locked. If the system is unlocked, all restrictions are removed.

8 Other Menu Functions

This section explains how to change audio/video settings, schedule future programs, and change system settings.

Contents

8-1	Adjusting Audio Settings	8.3
8-2	Adjusting Video Settings	8.5
8-3	Using the Program Director to Schedule Future Programs	8.7
8-4	Reading Mail from DIRECTV	8.10
8-5	Setting System Preferences	8.11
8-6	Advanced System Setup Functions	8.12

8-1 Adjusting Audio Settings

From the Audio Adjustment menu, you can select languages for default audio and alternate audio, adjust left/right balance, and enable TruSurround™ audio processing.

To set audio preferences, follow the steps below.

1. Press the AUDIO button [or select the **Audio & Video** tab from the main menu].

Audio Adjustment

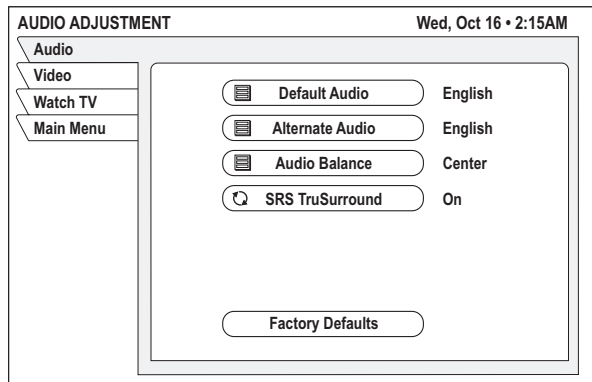

2. Highlight the menu button for the setting you wish to modify:

Default Audio and Alternate Audio

Your receiver supports alternate audio services. A **ALT-AUDIO** icon appears below the date and time in a program's description to indicate alternate audio is available for that particular program.

You will hear the default audio language all the time if that language is being transmitted and an alternate language has not been activated. If your selected default language is not being transmitted for a program, you will hear the language in which the program is broadcast.



Occasionally, an audio track may be offered that is not being broadcast, in which case the audio will not change or you will not hear any audio. Change channels to restore the audio track to the one specified on the Audio Adjustment menu.

To set up your default and alternate audio languages, follow the steps below.

1. Press the AUDIO button to access the Audio Adjustment menu.
2. Highlight the **Default Audio** button (to set your primary language preference) or the **Alternate Audio** button (to select your alternate language preference) and press SELECT.
3. Highlight the desired language for the default or alternate language and press SELECT.

Selecting Default Audio Language

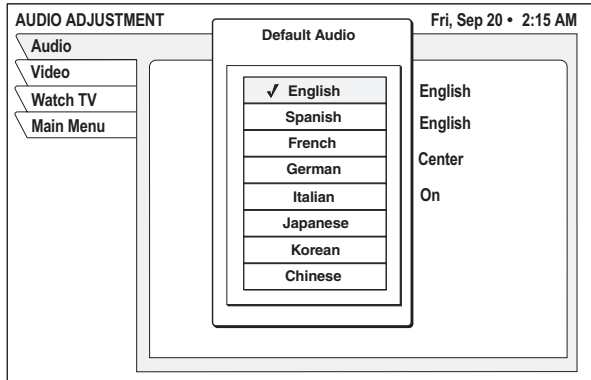

To select the alternate audio when watching TV, follow the steps below.

1. If the **ALT. AUDIO** icon appears below the date and time in a program's description, press the joystick left or right while you are viewing that program.
2. An alternate language option based on your alternate audio selection appears. Press SELECT to listen to the program in the alternate language.

When you change the channel, audio will revert to your selected Default Audio language.

Audio Balance

To adjust the audio balance left or right, highlight the **Audio Balance** button and press SELECT. Use the joystick to adjust the balance, then highlight the **Done** button and press SELECT.

SRS TruSurround

TruSurround technology lets you take advantage of any multichannel format without having to add extra speakers or equipment. Using two speakers, TruSurround “virtually” places the individual audio channels where they are supposed to be, as though you had speakers all around you.

To toggle TruSurround on/off, highlight the **SRS TruSurround** button and press SELECT.

8-2 Adjusting Video Settings

From the Video Adjustment menu, you can set the screen’s aspect ratio, change the appearance of onscreen displays, and adjust picture levels.

To set video preferences, follow the steps below.

1. Press the VIDEO button [or select the **Audio & Video** tab from the main menu].

Video Adjustments

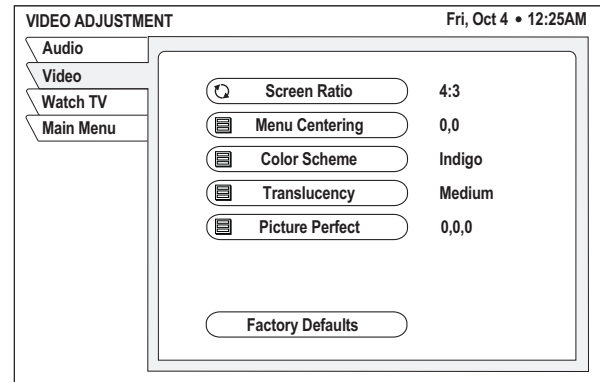

2. Highlight the menu button for the setting you wish to modify:

Screen Ratio

Press SELECT to choose either a **4:3** (standard) or **16:9** (widescreen) screen aspect ratio.

Menu Centering

Press SELECT to bring up the centering pop-up panel. Use the joystick to adjust the onscreen menu position on your TV, then highlight the **OK** button and press SELECT.

Color Scheme

Press SELECT to bring up a color pop-up menu. Highlight the desired menu color scheme (**Indigo**, **Ice**, **Sky**, **Forest**, or **Merlot**) and press SELECT.

Translucency

Press SELECT to bring up the translucency pop-up menu. Use the joystick to adjust the amount of menu translucency, from solid to 100% translucent, then highlight the **DONE** button and press SELECT.

Picture Perfect

Press SELECT to bring up the picture perfect pop-up menu. Use the joystick to adjust the brightness, contrast, and saturation, then highlight the **DONE** button and press SELECT.

Video Adjustments

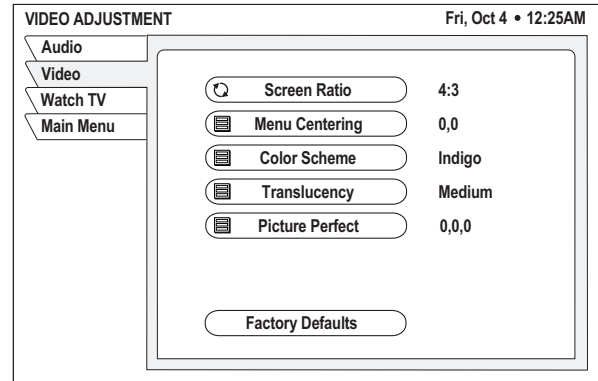

8-3 Using the Program Director to Schedule Future Programs

The Program Director allows you to automatically tune to a program at a specific date and time, or tune to a program on a repeating basis. The receiver will turn on (if necessary) and tune to the specified channel at the chosen date and time. You can program up to 32 events in advance.

Scheduling an Event from the Program Guide

You can easily schedule an upcoming program that you find listed in the program guide. Simply highlight the upcoming program in the program guide and press SELECT. A check mark appears next to your selection. At the start date/time of the scheduled program, the receiver will automatically tune to that program.



From the program guide, you can schedule a program only for a specific date and time. To schedule recurring programs and future programs that are not yet listed on the program guide, use the Program Director menu.

Scheduling an Event from the Program Director

To schedule a program from the Program Director menu, follow the steps below.

1. Press the MENU button to access the main menu.
2. Highlight the **Program Director** tab and press SELECT.

Program Director

PROGRAM DIRECTOR		Wed, Oct 2 • 7:14PM			
Schedule	Add and Modify Scheduled Events				
By Title *	Chan	Start	Length	Frequency	
Watch TV					
Main Menu					

* By Title tab not available

3. Highlight an empty slot and press SELECT.

4. Highlight the **Schedule to View** button from the Schedule Options pop-up menu and press SELECT.

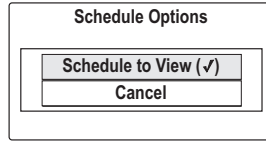

5. Use the joystick or numeric keypad to choose the desired channel from the channel selection pane. Then highlight the **OK** button and press SELECT.

Channel Selection Pane

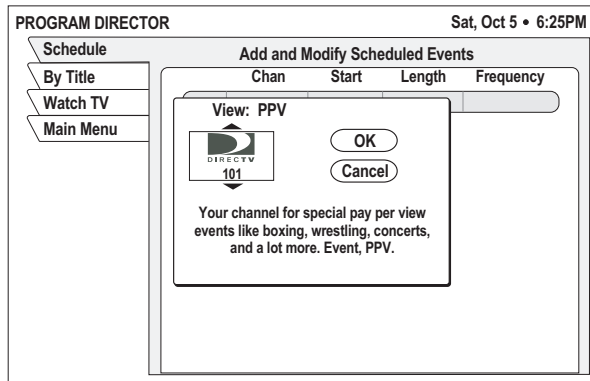

6. Highlight the **Start** column and use the joystick or numeric keypad to set the program's start time. Be sure to specify **AM** or **PM** (or **N** for noon, **M** for midnight if you specified 12:00).
7. Highlight the **Length** column and use the joystick or numeric keypad to set the program's duration in hours and minutes.
8. Highlight the **Frequency** column and use the joystick to select when, or how often, the event occurs: Today, Tomorrow, Every Mon, Every Tue, Every Wed, Every Thu, Every Fri, Every Sat, Every Sun, Everyday, Mon-Fri, or "/" (specify a date).



If you specify a date, use the month/day format. The year is set automatically.

9. Review your settings, then highlight the **OK** button and press SELECT. To abort, highlight the **Cancel** button and press SELECT.

Canceling a Scheduled Event

To cancel a scheduled event, follow the steps below.

1. Press the MENU button to access the main menu.
2. Highlight the **Program Director** tab and press SELECT.
3. Highlight the event you want to cancel and press SELECT.
4. Highlight the **Cancel** button from the Schedule Options pop-up menu and press SELECT.



If the program you want to cancel is a one-time program that's not currently in progress, you can cancel the event from the program guide. Simply highlight the program you want to cancel in the program guide and press SELECT to remove the check mark.

8-4 Reading Mail from DIRECTV

DIRECTV uses the Mail feature to send you important information, notify you of special events, and tell you about special offers. When you receive a new message, a **NEW MAIL** icon appears at the top of all menus until you've read the message.

Reading Your Messages

To read your mail, follow the steps below.

1. Press the MENU button to access the main menu.
2. Highlight the **View Mail** tab and press SELECT.
3. If the message is longer than a single page, highlight the **Page** button and use the CHANNEL (CH) button to step through the pages.
4. If you have more than one message in your mailbox, highlight the **Message** button and use the joystick to navigate through multiple messages.

View Mail

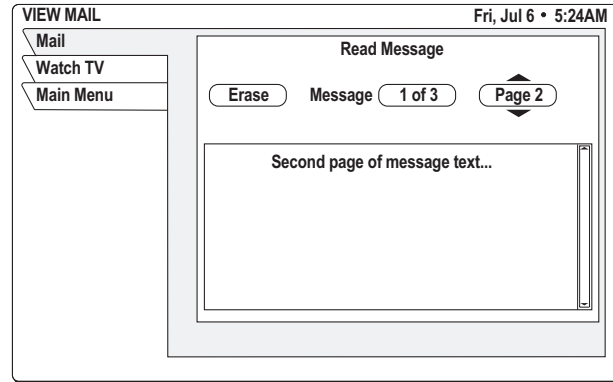

Erasing a Message

To permanently remove a message, highlight the **Erase** button and press SELECT. *Messages are automatically deleted as they become outdated or if space is needed for newer incoming messages.*



Once you erase a message, it cannot be retrieved.

8-5 Setting System Preferences

The Preferences menu allows you to customize various system settings.

To set system preferences, follow the steps below.

1. Press the MENU button to access the main menu.
2. Highlight the **System Setup** tab and press SELECT.
3. Highlight the **Prefs** tab.

Preferences

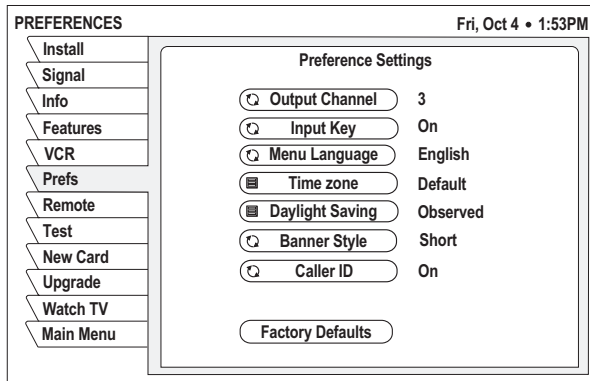

4. Highlight the menu button for the setting you wish to modify:

Output Channel

Press SELECT to choose either channel **3** or **4**, whichever is unused in your area.

Input Key

Press SELECT to turn the remote control INPUT button on/off. *If you have a VCR connected to the system, keep the Input Key set to "On."*

Menu Language

Press SELECT to choose either **English** (default) or **Spanish** for the menu language. The text in all onscreen menus will be shown in the selected language.

Time Zone

Press SELECT to bring up the time zone pop-up menu. Then highlight your time zone and press SELECT. The program guide will show programming times based on this time zone.

Daylight Saving

Press SELECT to bring up the Daylight Saving pop-up menu. Then highlight the desired daylight saving option (**Observed**, **Not Observed**, or **Default**) and press SELECT.

Banner Style

Press SELECT to choose either a **Short** or **Full** banner style. A full banner always shows the program description within the channel banner; a short banner shows just the program's title.



*When you press the INFO button while watching TV, a **full** channel banner is displayed, regardless of the Banner Style setting.*

Caller ID

NOT USED.

Factory Defaults

Press SELECT to restore the Preferences options to their original factory settings.

8-6 Advanced System Setup Functions

Besides the Remote and Preferences menus described previously, the System Setup menu provides other functions, all of which are rarely, if ever, used.

To use the advanced system setup functions, follow the steps below.

1. Press the MENU button to access the main menu.
2. Highlight the **System Setup** tab and press SELECT.

System Setup Menu (Test Tab Selected)

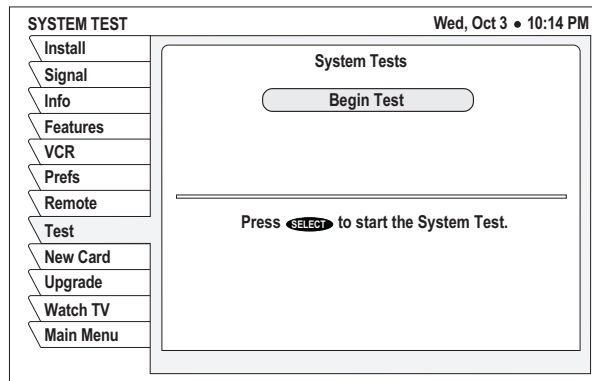

3. Highlight the menu button for the advanced function you wish to use:

Install

NOT USED.

Signal

NOT USED.

Info

The System Information pane lists general information about your TracVision receiver, including manufacturer, model, ID number, access card, and software version.

Features

The Features pane lists some of the receiver's special features.

Test

The Test function performs a simple diagnostics test on the system. When complete, a report shows system information and indicates whether the Signal, Tuning, and Front Panel functions passed the test.

New Card

In the unlikely event that your receiver's access card must be replaced, use the New Card function to initialize the new card.



If you need a new access card, please call KVH at 401-847-3327.

Upgrade

The Upgrade pane shows your receiver's upgrade history. Occasionally, DIRECTV will automatically update your receiver's software. This update is completely transparent to the user.

9 Troubleshooting

This section identifies some basic trouble symptoms, along with their possible causes and solutions. It also explains what the system status lights indicate and how to get technical support.

Contents

Troubleshooting Matrix	9.3
9-1 Causes and Remedies for Common Operational Issues	9.4
9-2 Technical Support	9.13
9-3 System Status Lights	9.14

Troubleshooting Matrix

SYMPTOM	POSSIBLE CAUSE																				
	Receiver power switch turned off	Blown fuse	Insufficient power	Loose cable connectors	Satellite signal blocked	Weak satellite coverage	Receiver not activated	Receiver lost activation information	INPUT button not pressed	Audio/video system not set to satellite source	System locked by passcode	Favorite channel list active	Remote control not programmed	Program Guide load interrupted	RF converter locked up	Remote control too close to receiver	Audio/video batteries dead	Antenna system faulty	Receiver faulty	Receiver set to "Unstacked LNB"	
System does not power on	X	X	X	X				X								X		X	X		
No picture on video screen	X	X	X	X					X	X								X	X	X	
Intermittent picture for short intervals				X	X	X	X										X	X	X		
System works at rest, but not on the move					X													X			
System does not find satellite			X	X	X	X	X											X	X		
System restarts itself			X	X															X		
Receiver beeps continuously at startup			X																		
Snowy DIRECTV television picture			X	X				X	X			X		X			X		X		
Picture jumbled or freezing				X	X	X	X										X		X		
Certain channels do not work							X						X					X	X		
Remote does not work	X			X								X		X	X	X					
Remote does not operate other component								X				X									
Only Preview channels are accessible							X	X													
Only certain channels are accessible										X	X						X				
Program guide does not load																				X	

9-1 Causes and Remedies for Common Operational Issues

There are a number of common issues that can affect the signal reception quality or the operation of the TracVision system. The following sections identify these issues and provide potential solutions.



If the TracVision system is not working properly, try resetting the system before you begin troubleshooting. To reset, follow the simple steps below.

1. Stop in a blockage-free area.
2. Turn off the receiver's rear panel power switch.
3. Turn the receiver's rear panel power switch back on.
4. If the TracVision antenna is turned off, turn it on (press SAT then PWR).
5. Wait one minute for the antenna to acquire the satellite.

Receiver Power Switch Turned Off

Your TracVision receiver's rear panel power switch (see below) must remain on for the system to work. If the system is entirely non-functional, check the switch to ensure that it is turned on. *The switch illuminates green when turned on.*

Receiver Power Switch

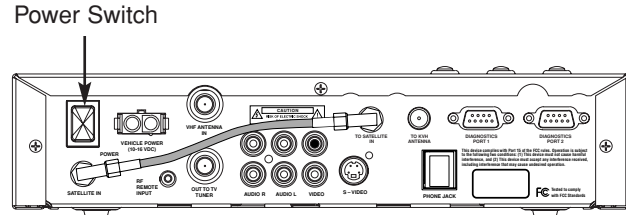

Blown Fuse

The receiver's power input cable includes an in-line fast-blow fuse, rated for 6 amps, located on the end of the cable nearest the receiver. If this fuse has blown, the system will not operate. Unscrew the cap on the fuse holder and replace the fuse. If you replace the fuse, but it blows again, check the receiver to ensure that it is clear of debris and the connectors are tight. **Do not replace the fuse with a larger amperage fuse.**

Insufficient Power

With the vehicle/vessel powered up and the receiver turned on, power at the receiver must measure at least 10 VDC for the TracVision system to work properly. Check the receiver's power connection and ensure that it is wired to a dedicated circuit. If other devices are wired to the same circuit, these additional loads will drain power away from the receiver.

Loose Cable Connectors

A loose connector can reduce the signal quality. Check the cable connections at the antenna unit, receiver, RF converter, and audio/video components to ensure they are securely attached.

Satellite Signal Blocked

Satellite signals can be blocked or degraded by tall or solid structures such as trees, buildings, mountains, or bridges. Simply moving to clear an obstruction will restore signal quality. Rain clouds, heavy rain, and snow can also affect satellite signal reception. For more details about satellite blockage, see *Section 1-3, "Receiving Satellite TV Signals," on page 1.5.*

In addition, dirt, snow, ice, or heavy moisture on the antenna dome can disrupt satellite signals, so be sure to clean the antenna regularly.

Satellite Coverage Issue

TracVision will provide good satellite TV reception throughout the entire satellite coverage area. However, signal quality can be degraded as you approach the fringe of this area. *To view the most up-to-date coverage map, visit KVH's web site at www.kvh.com/footprint. For more details about satellite coverage, see *Section 1-3, "Receiving Satellite TV Signals," on page 1.5.**

Weak Satellite Signal

Just like radio stations, some satellite TV channels transmit a stronger signal than others. If you're unable to receive a clear signal on one channel, try switching to another channel. Weaker channels are more vulnerable to interference, such as rain or snow.

Receiver Not Activated

If you can only access the DIRECTV preview channels, such as channel 100, while all other channels show a message to call DIRECTV, your receiver has not been activated. **To activate your system, please call KVH's Activation Department at 1-866-551-8004. Activation support is available 24 hours a day, seven days a week.**

Receiver Lost Activation Information

If you can only access the DIRECTV preview channels, such as channel 100, while all other channels show a message to call Ext. 722, and you have already activated the receiver, the receiver may have lost its stored activation data. This may occur if the receiver is left idle (does not receive a satellite signal) for an extended period of time. To fix this problem, please call DIRECTV customer service at 1-800-DIRECTV (347-3288). *Be sure the TracVision system is turned on, has a clear view of the southern sky, and is tuned to the DIRECTV preview channel before you call. The system will need to receive a signal from the satellite to correct the problem.*

Proper Component Button Not Pressed

To operate the satellite TV system using the remote control, first press the remote control's SAT button. The remote control will not operate the receiver unless the SAT button is active. To operate a component other than the satellite receiver, first press the corresponding component button on the remote control. For example, to operate the TV monitor using the remote control, first press the TV button.

INPUT Button Not Set to Satellite Source

If satellite programming is not displayed on your TV, you may have selected an alternate video input. Press the remote control's INPUT button until the correct satellite input is displayed.



You can disable the INPUT button by turning it off via the menu system. See Section 8-5, "Setting System Preferences," on page 8.11 for details.

Audio/Video System Not Set Up Properly

If satellite programming is not displayed on your TV, you may have the wrong input selected on your audio/video system. Try switching to another input (for example, VIDEO 1 or VIDEO 2; AUX1, AUX2, or A/V) whichever input is assigned to the satellite receiver. In addition, ensure that the audio/video system is powered on.

System Locked by Passcode

If you can only access Family list channels, and the lock icon (🔒) appears under the date/time, the system has been locked with a passcode. For details on unlocking the system, see *Section 7-1, "Locking & Unlocking the System,"* on page 7.3.



*If the Family list does not have any channels assigned to it, **NO** channels can be viewed without first unlocking the system.*

Favorite Channel List Active

If a favorite channel list is active, only channels set up in that list are accessible. Press the remote control's FAV button to cycle through the lists. See *Section 6-1, "Using Favorite Channel Lists,"* on page 6.3 for details.

Remote Control Not Programmed

If you cannot operate a component with the remote control, first ensure that the associated component button (DVD, VCR, AUX, or TV) is selected. If the correct button is selected, you need to program the remote control to operate the component. See *Section 3-3, "Programming the Remote Control to Operate Other Components,"* on page 3.10 for details.

Program Guide Load Interrupted

If the program guide load is interrupted at startup, certain channels may not be viewable temporarily. Guide load interruptions could occur as a result of satellite blockage (see *"Satellite Signal Blocked"* on page 9.5). The missing channels will eventually be restored as the receiver completes the program guide download during normal operation.

Receiver Locked Up

Since your receiver is a computing component, it is susceptible to erratic changes in power and/or signal, like any other computer, and these sudden changes can cause it to become “confused.” To clear this condition, try pressing the remote control’s SAT button before trying to control the receiver. If that doesn’t work, press the SAT and MUTE buttons together and try again.

If that doesn’t work, turn off vehicle/vessel power or the receiver’s rear panel power switch for 30 seconds, then turn it back on.

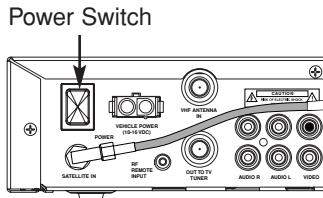

RF Converter Too Close to Receiver

The RF converter must be placed at least three feet away from the receiver. Placing the RF converter closer to the receiver may result in interference, causing the remote control to operate intermittently or not at all.

Remote Control Batteries Dead

To replace the remote control’s batteries, follow the steps below.

1. Remove the battery compartment cover on the back of the remote control.
2. Insert two AAA batteries as shown, observing the correct polarity.
3. Replace the battery compartment cover.

Remote Control Batteries

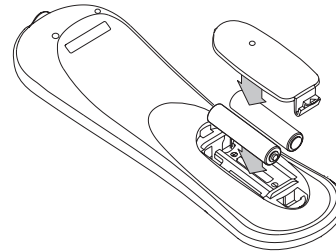

If you lose your remote control, please call or visit your local KVH authorized dealer to order a replacement.

Audio/Video System Faulty

If there is no picture on your TV, your mobile audio/video system may be faulty. Please seek technical assistance from either the installer of your audio/video system or a dealer authorized by the system's manufacturer to repair the system.

Antenna or Receiver Faulty

In the case of a faulty antenna or receiver, please seek technical support as described in the next section.



*Do **NOT** attempt repairs yourself. Refer all servicing needs to qualified service personnel. Evidence of tampering or unauthorized repairs will void the warranty.*

Receiver Set to “Unstacked LNB”

If the program guide stops loading after the TracVision system is turned on, the LNB type setting on the receiver may have changed. The receiver's LNB type must be set to “Stacked” for proper operation. If the LNB type is set to “Unstacked,” the program guide will start loading, but will stop in the middle of the process, as shown below.

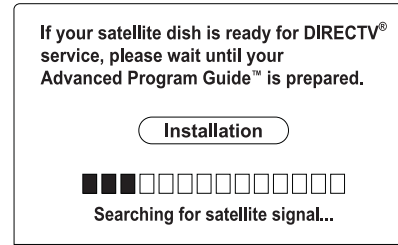

If this symptom occurs, first follow the steps below to verify that the LNB type has changed.

1. While the program guide is loading, press the SELECT button on the remote control to access the System Setup menu.

2. Highlight the **Install** tab and check the “LNB” setting.

Install Tab

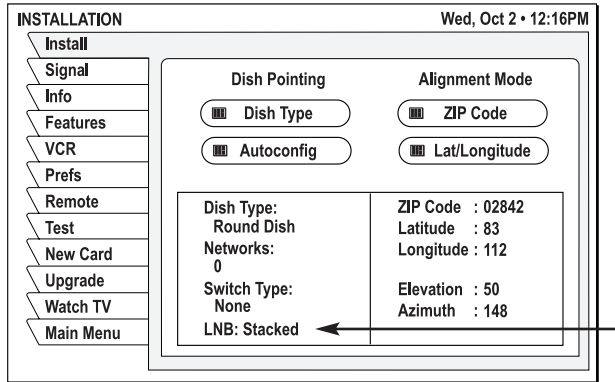

3. If the LNB type is set to “Stacked,” you do not need to change the setting. A different problem is causing the program guide not to load. Please call KVH Technical Support at 401-847-3327 (or e-mail techs@kvh.com) for assistance.

If the LNB type is set to “Unstacked,” follow the steps in the next section to change the setting to “Stacked.”

Setting the LNB Type to “Stacked”

If the LNB type is set to “Unstacked,” follow the steps below to change the setting to “Stacked.”

1. Highlight the **Test** tab.

Test Tab

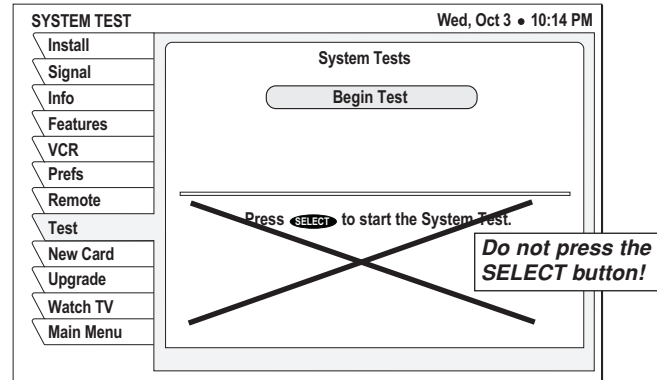

2. Highlight the **Begin Test** button.
3. Press the FAV button on the remote control.

- The System Diagnostics menu appears. Highlight the **LNB Type** button and press SELECT.

System Diagnostics

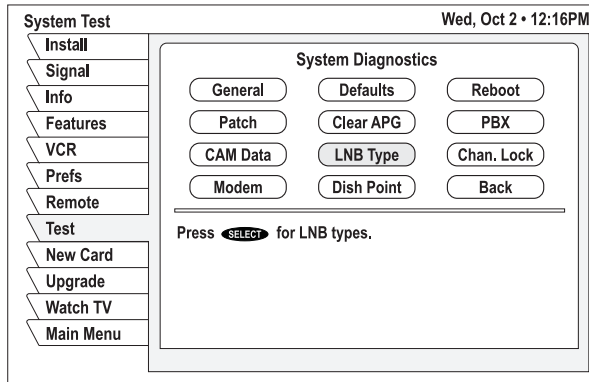

- Highlight “Stacked” from the pop-up submenu and press SELECT.

LNB Type Submenu

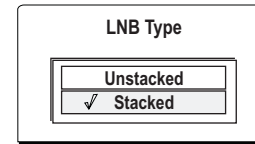

- With the **LNB Type** button still highlighted, press SELECT and verify that a check mark appears next to “Stacked.” Press SELECT again to exit.
- Highlight the **Install** tab (shown on page 9.10).
- Highlight the **Dish Type** button and press SELECT.

- Highlight "Oval Dish 2" from the pop-up submenu and press SELECT. This action ensures the "Stacked" setting is saved in the receiver's memory.

Dish Type Submenu

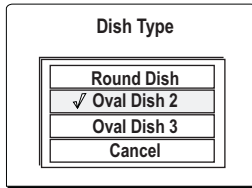

- Highlight the **Install** tab.
- Wait for the receiver to finish loading the program guide.
- Once the program guide has loaded, highlight the **Dish Type** button and press SELECT.
- Highlight "Round Dish" from the pop-up submenu and press SELECT.

- Turn off the receiver's rear panel power switch.
- Wait 10 seconds, then turn the rear panel power switch back on.
- Verify that the program guide loads successfully and verify good TV reception.

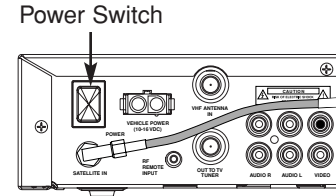

9-2 Technical Support

If you experience an operating problem or require technical assistance, please contact your local authorized TracVision dealer/installer first. You can find an authorized technician near you by visiting our web site at www.kvh.com/wheretogetservice.

If an authorized dealer/installer is not located nearby, contact KVH Technical Support directly:

Phone: 401-847-3327

E-mail: techs@kvh.com

Internet: www.kvh.com/help

Please have your antenna and receiver serial numbers ready before calling technical support. The serial numbers are located on the red Activation Card, as well as on the antenna and receiver.



Detailed information on KVH's global support program is available at www.kvh.com/global_support.

9-3 System Status Lights

Three status lights on the top of the receiver indicate the current status of the system and can help you identify problems.

- A** VOLTAGE light
- B** RECEIVER light
- C** ANTENNA light

During normal operation, all three status lights should be lit green. The following tables explain what the different light conditions indicate.

System Status Lights

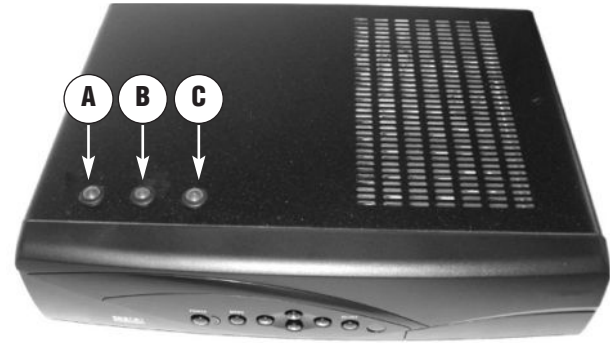

If multiple receivers are connected, the ANTENNA light on any additional receivers will remain red at all times. Only the original master receiver can monitor antenna status.

A VOLTAGE Light Indications

Light is...	Indicates	Description
Off	Off	Receiver is OFF (rear panel power switch is off) or no power input
Green	OK	Good power (between 10-18 VDC at receiver)
Orange	Low Power	Low power (between 8-10 VDC at receiver)
Red, flashing	Bad Power	Insufficient power (less than 8 VDC or more than 18 VDC input)

B *RECEIVER Light Indications*

Light is...	Indicates	Description
Off	Off	Receiver is OFF (rear panel power switch is off)
Green	OK	Receiver is ON
Orange	Standby	Receiver is ON but antenna is turned OFF
Orange, flashing	Overload	Overload or short circuit detected on the antenna cable
Red	Fault 1	Internal power fault
Red, flashing	Fault 2	Antenna power or power supply problem

C *ANTENNA Light Indications*

Light is...	Indicates	Description
Off	Off	Antenna is OFF, insufficient power, or no receiver video detected
Green	Tracking	Antenna is tracking the DIRECTV satellite
Green, flashing slowly	Searching	Antenna is searching for a satellite
Green, flashing quickly	Identifying	Antenna has found a satellite and is checking its identification code
Orange, flashing	Overload	Overload or short circuit detected on the antenna cable
Red	No Comm	Receiver cannot communicate with the antenna
Red, flashing	Fault	Error detected in antenna

Appendices

This section provides wiring diagrams for typical TracVision installations and a map showing the DIRECTV® satellite's elevation angle off the horizon.

Contents

A	System Wiring Diagrams	A.3
B	Satellite Elevation Map	A.17

Appendix A

System Wiring Diagrams

The diagrams on the following pages show how to wire the system for various configurations:

Original TracVision A5/M3 12V receiver* AND:	Total # receivers:	Requires Kit P/N:	See page:
No additional receivers	1	N/A	A.4
One (1) additional TracVision A5/M3 12V receiver**	2	02-1340	A.6
Two (2) additional TracVision A5/M3 12V receivers**	3	02-1340 (x2)	A.8
One (1) generic (non-A5/M3) receiver – M3 use only	2	72-0182	A.10
Two (2) generic (non-A5/M3) receivers – M3 use only	3	72-0181	A.12
Three (3) or more receivers of any type – M3 use only	4+	72-0181 & 19-0123	A.14

* The original TracVision A5/M3 12V receiver (supplied with the TracVision A5/M3 system) is required in all configurations. This receiver supplies power to the antenna.

** If you connect a **non-A5/M3** TracVision 12V receiver for DIRECTV service (KVH P/N 02-1442), treat it as a generic receiver.



For complete system wiring details, refer to the installation instructions provided with the system or upgrade kit. Before making any wiring changes, be sure to turn off vehicle/vessel power.

Wiring Diagram for a Single TracVision A5/M3 12V Receiver

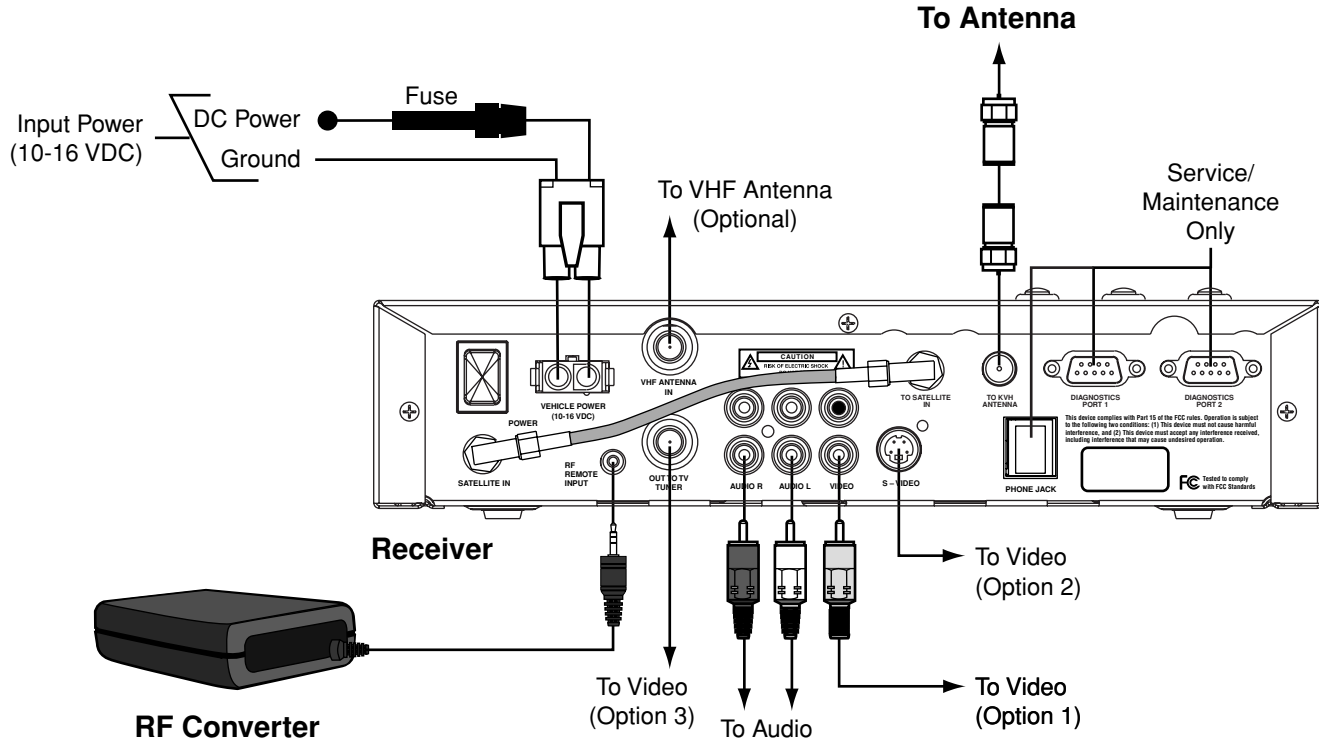

Single TracVision A5/M3 12V Receiver

- DO NOT disconnect the short cable that connects from one jack to another on the receiver's rear panel. The system will not work if this cable is removed.
- You can connect the receiver to the entertainment system using one of the following options:
 Option 1 - RCA-type A/V jacks (*use bottom row*)
 Option 2 - S-Video jack
 Option 3 - RF coaxial connector
- Standard audio/video (A/V) cables with RCA-type connectors are included with the receiver.
- Be sure to tighten all connections adequately.
- Before you connect the power wires, be sure to read the important guidelines provided in the Installation Guide (*included with the system*).

TracVision A5/M3 12V Receiver Rear Panel Connections

Connector	Function
Vehicle Power	Connect to input power (+12 VDC); <i>applies to a vehicle or a vessel</i>
RF Remote Input	Connect to RF converter
VHF Antenna In	Not applicable for satellite TV; can be used for over-the-air channels if you have a TV tuner & VHF antenna
To KVH Antenna	Connect to the TracVision antenna
Diagnostics Ports, Phone Jack	Technician's use only, for diagnostics purposes
Audio R, Audio L	Connect right (R) and left (L) outputs to your audio component
Out to TV Tuner	Connect to your TV if it only has an RF (coaxial) connector and built-in TV tuner
Video	Connect to your TV if it has standard RCA-type A/V jacks (better picture quality)
S-Video	Connect to your TV if it has an S-Video input (best picture quality)

Two TracVision A5/M3 12V Receivers

- A two-way splitter is provided in the Additional TracVision A5/M3 Receiver Kit (KVH part number 02-1340). The splitter has a frequency range of 40-2150 MHz with one port DC passive.
 - In this diagram, receiver #1 is the master receiver. Receiver #1 must be turned on in order to use receiver #2.
 - The receiver and remote control provided in the second receiver kit are programmed for ID code "002." This avoids interference or "cross talk" between remotes. In other words, the remote for the second receiver will only operate receiver #2, and not receiver #1.
 - If you order a replacement remote control (KVH part number 19-0335), and you want to use it to operate the second receiver, you will need to change the remote's ID code to "002." Refer to the instructions in *Section 3-4, "Controlling Multiple Receivers,"* on page 3.11.
- Both receiver #1 and receiver #2 must be activated for DIRECTV service. To activate the second receiver under the same account, call KVH's Activation Department at 866-551-8004. Be sure to tell the representative that you need to add a second receiver to your account.
 - The Antenna status light on receiver #2 will remain red at all times. This is normal. Only receiver #1, which is connected directly to the antenna, can monitor antenna status.

Receiver #2



Wiring Diagram for Three TracVision A5/M3 12V Receivers

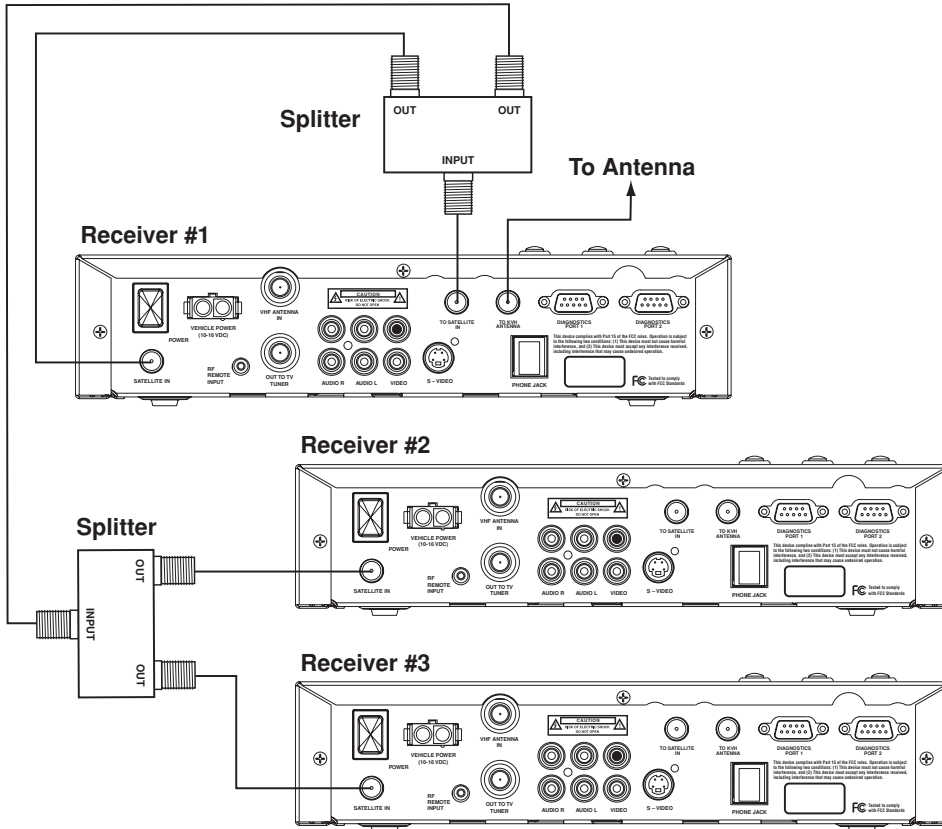

Three TracVision A5/M3 12V Receivers

- To connect two additional TracVision A5/M3 12V receivers, you will need **two** Second TracVision A5/M3 Receiver Kits (KVH part number 02-1340). Each kit includes a splitter with a frequency range of 40-2150 MHz with one port DC passive.
- In this diagram, receiver #1 is the master receiver. Receiver #1 must be turned on in order to use receiver #2 or receiver #3.
- The remote control supplied in the Second TracVision A5/M3 Receiver Kit is programmed with remote ID code "002". To prevent "cross talk" between the second and third receiver remote controls, you can program the third receiver's remote control for ID code "003". Refer to the instructions in *Section 3-4, "Controlling Multiple Receivers,"* on page 3.11.
- All three receivers must be activated for DIRECTV service. To activate the additional receivers under the same account, call KVH's Activation Department at 866-551-8004. Be sure to tell the representative that you need to add additional receivers to your account.
- The Antenna status light on receiver #2 and receiver #3 will remain red at all times. This is normal. Only receiver #1, which is connected directly to the antenna, can monitor antenna status.

Receivers #2 and #3



Wiring Diagram for One TracVision A5/M3 12V Receiver and One Generic (Non-A5/M3) Receiver

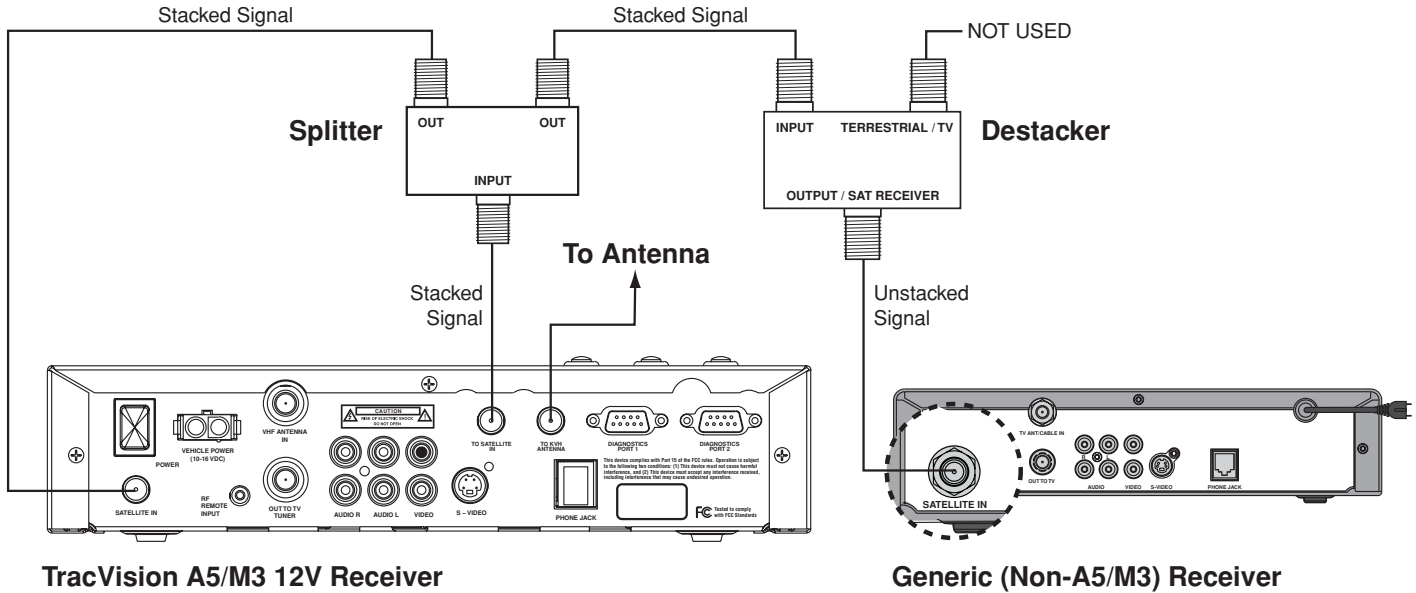

One Generic (Non-A5/M3) Receiver

– M3 Marine Use Only

- If you wish to connect a single generic (non-A5/M3) receiver to the system, you will need a Single AC Receiver Add-on Kit (KVH part number 72-0182). This kit includes a splitter, a single-output destacker, connecting cables, and instructions.
- The output of the TracVision antenna is a special stacked signal, which the TracVision A5/M3 12V receiver is configured to decode. However, all generic (non-A5/M3) receivers are configured to decode unstacked signals instead. Therefore, a single-output destacker is needed to convert the antenna's stacked signal into an unstacked signal that a generic (non-A5/M3) receiver can decode.



The TracVision M3 is compatible with all new DIRECTV receiver models manufactured today (when wired in the configuration shown on the previous page). Older receiver models may function differently, however, and KVH does not support their use.

Wiring Diagram for One TracVision A5/M3 12V Receiver and Two Generic (Non-A5/M3) Receivers

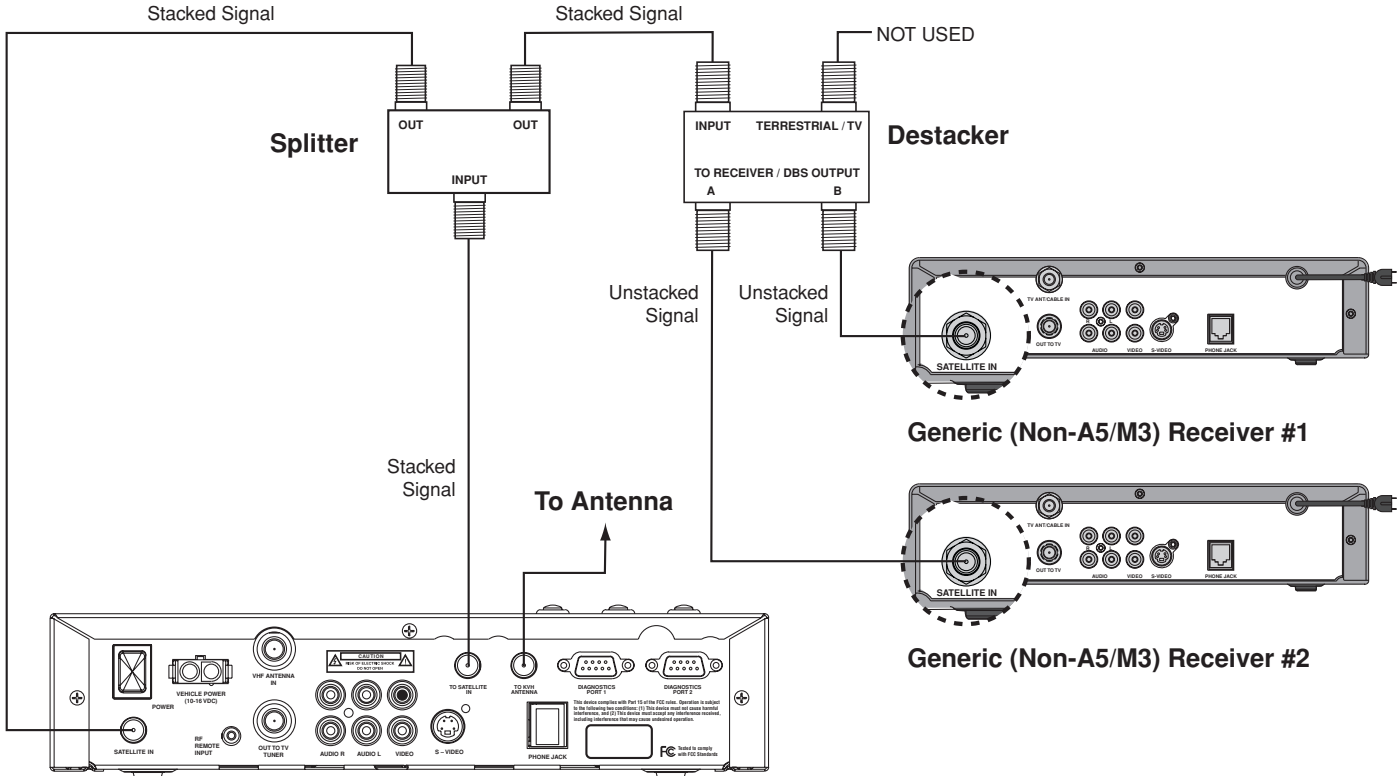

TracVision A5/M3 12V Receiver

Two Generic (Non-A5/M3) Receivers

– M3 Marine Use Only

- If you wish to connect two generic (non-A5/M3) receivers to the system, you will need a Multiple AC Receivers Add-on Kit (KVH part number 72-0181). This kit includes a splitter, a dual-output destacker, connecting cables, and instructions.
- The output of the TracVision antenna is a special stacked signal, which the TracVision A5/M3 12V receiver is configured to decode. However, all generic (non-A5/M3) receivers are configured to decode unstacked signals instead. Therefore, a dual-output destacker is needed to convert the antenna's stacked signal into an unstacked signal that a generic (non-A5/M3) receiver can decode.



The TracVision M3 is compatible with all new DIRECTV receiver models manufactured today (when wired in the configuration shown on the previous page). Older receiver models may function differently, however, and KVH does not support their use.

Wiring Diagram for Multiple Receivers of Any Type

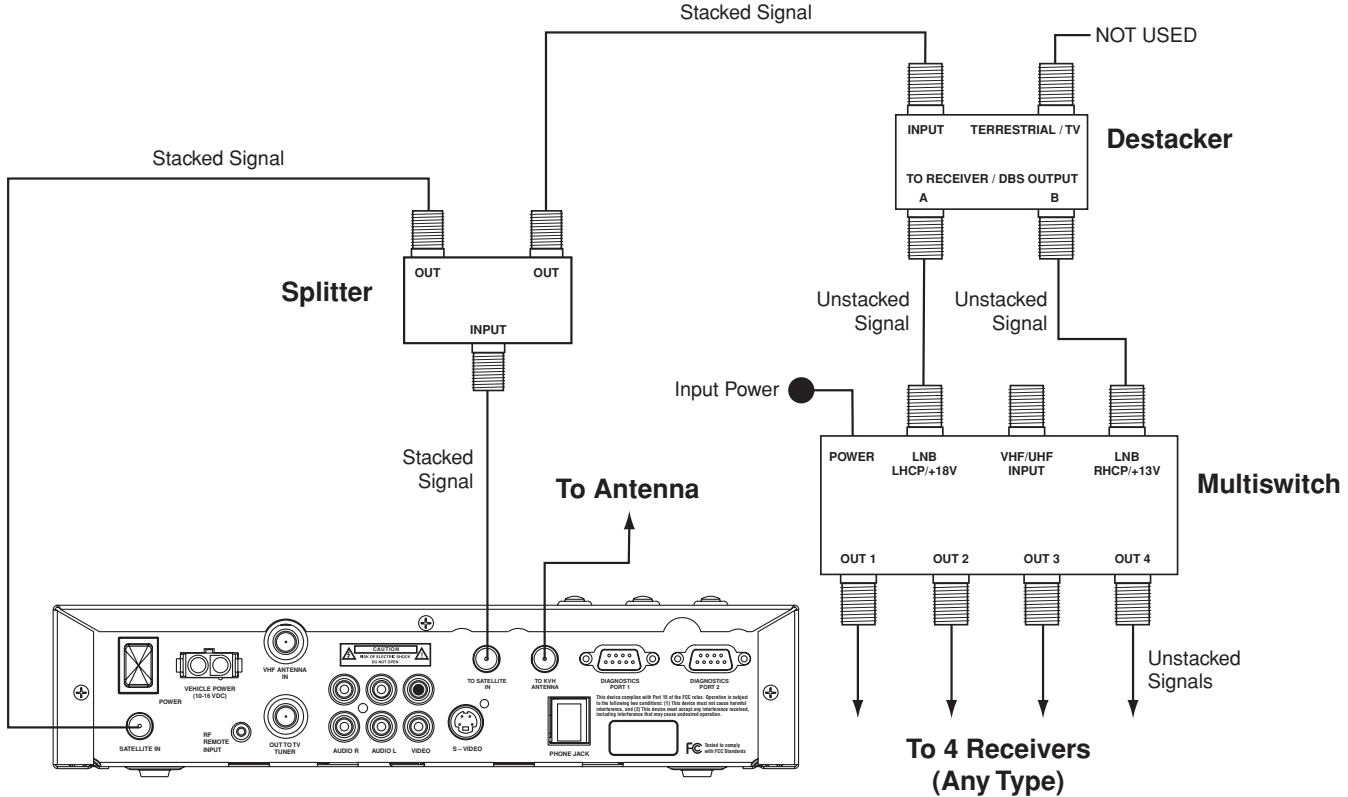

TracVision A5/M3 12V Receiver

Four or More Receivers – M3 Marine Use Only

- If you wish to connect three or more additional receivers to the system, KVH recommends you install an active multiswitch along with a dual-output destacker and a splitter. The Multiple AC Receivers Add-on Kit (KVH part number 72-0181) includes the dual-output destacker and a splitter. The active multiswitch is sold separately (KVH part number 19-0123).
- An **active** multiswitch amplifies the signal to compensate for signal loss. **A simple splitter or passive multiswitch does not provide the necessary amplification.**
- A dual-output destacker is needed to modify the TV signal for connection to a multiswitch.
- You can connect multiple TracVision A5/M3 12V receivers and/or generic (non-A5/M3) receivers to the multiswitch.



The TracVision M3 is compatible with all new DIRECTV receiver models manufactured today (when wired in the configuration shown on the previous page). Older receiver models may function differently, however, and KVH does not support their use.

- **Any TracVision A5/M3 12V receivers that you connect to the multiswitch need to be configured for an unstacked signal** (follow all of the steps in “Receiver Set to ‘Unstacked’ LNB” on page 9.9, except select “Unstacked” instead of “Stacked”).

Appendix B

Satellite Elevation Map

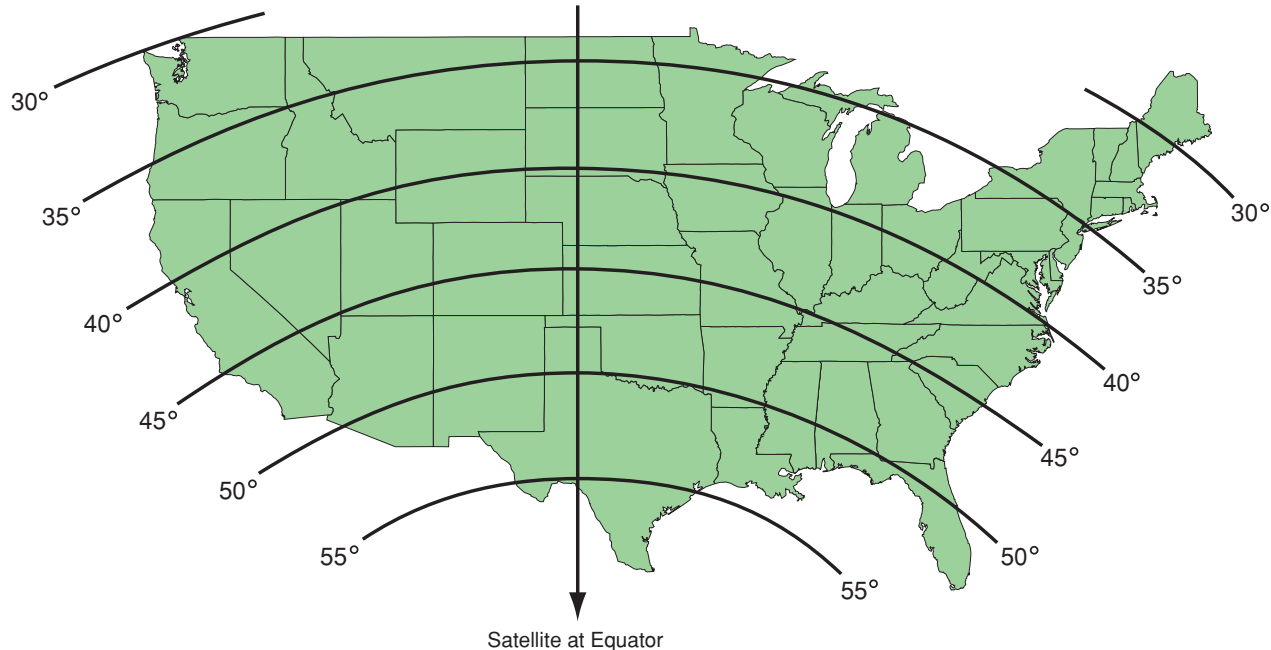

Index

A

A/V jacks, A.5
access card, 8.13
activating the receiver, 9.6
adjusting audio settings, 8.3-8.5
adjusting video settings, 8.5-8.6
advanced setup, 8.12-8.13
Antenna light, 9.14-9.15
Antenna Power light, 3.9
antenna unit
 connection to receiver, A.4
 repairing, 9.9
 turning on, 2.3
 turning off, 2.5
arrows, in program guide, 5.5
aspect ratio, 8.6
audio adjustments, 8.3-8.5
AUDIO button, 3.7

54-0287

audio/video input, 9.7
audio/video system repairs, 9.9
Auto Set, 6.5

B

backlight, 3.3, 3.8
banner style, 8.12
batteries, remote control, 3.13
beeping, receiver, 2.6
blockage, 1.6, 9.5
brightness, 8.6
buttons, receiver 3.9
buttons, remote control, 3.3-3.8

C

cabling diagrams, A.3
Caller ID tab, 4.6
Category Filter, 6.7-6.8
caution, 3.3, 9.9, A.3
centering the menu, 8.6
CH button, 3.6

changing channels, 2.5
changing LNB type, 9.10-9.12
changing remote ID, 3.11-3.12
channel banner, 4.3, 8.12
check mark, in program guide, 8.7
CLEAR button, 3.6
color scheme, menus, 8.6
colors, program guide, 5.10
connections
 one A5/M3 receiver, A.4
 two A5/M3 receivers, A.6
 three A5/M3 receivers, A.8
 one generic receiver, A.10
 two generic receivers, A.12
 four or more receivers, A.14
connectors, receiver, A.4
contrast, 8.6
controlling other components, 3.10
coverage area, 1.5, 9.5
cross talk, 3.11

D

daylight saving, 8.12
default settings, 8.12
deleting mail, 8.10
description, system, 1.4
destacker, A.10-A.15
device code, 3.10
dew on antenna, 9.5
diagnostics test, 8.13
diagram, system, 1.4
DIRECTOR buttons, 3.7
DIRECTV customer service, 7.4
DIRECTV receiver, other, A.10-A.15
dirt on antenna, 9.5
downloading the program guide, 2.4
DVD player control, 3.8, 3.10

E

elevation angle, 1.6, A.17
ellipsis, in guide field, 5.5

equator, 1.5
erasing mail, 8.10

F

Family list, 6.4, 7.3
FAV button, 3.5
favorite channel lists, 6.3-6.6
filtering the program guide, 6.7-6.8
footprint, satellite, 1.5
fuse, 9.4
future programs, viewing, 6.9

G

grid guide, 5.4
GUIDE button, 3.4
Guide Options, 5.9-5.11
Guide Times, 6.9

H

highlight, 1.3
HUGHES button, 3.8

I

ice on antenna, 9.5
icons, channel banner, 4.3
icons, menu, 4.5
INFO button, 3.5
initializing a new access card, 8.13
INPUT button, 3.8, 9.6
installing batteries, 3.12
Interactive tab, 4.6
interference, remote controls, 3.11
IR eye, 3.10

J

joystick, 3.5

K

keyboard, 6.11

L

language, menu, 8.11
languages, alternate, 8.3-8.4

lights

- Antenna Power, 3.9
- Voltage, 9.14
- Receiver, 9.14-9.15
- Antenna, 9.14-9.15

limit exceeded message, 7.4

limiting access, 7.3-7.4, 7.5-7.7

locating the RF-to-IR converter, 9.8

lock icon, 7.4

lock override icon, 7.4

lock up, receiver, 9.8

locking the system, 7.3-7.4

logo guide, 5.4

lost remote, 3.9

M

mail, 8.10

main menu, 4.5

MENU button, 3.4

menu color scheme, 8.6

menu elements, 4.5

menu functions, table, 4.7-4.9

menu system, 4.5-4.6

multiswitch, A.14-A.15

MUTE button, 3.6

N

new channels, 6.6

New Mail icon, 8.10

noise, antenna, 2.6

number buttons, 3.7

O

OneLine Guide, 5.6

operating other components, 3.10

ordering a receiver, 3.11

ordering a remote control, 3.9

overriding lock, 7.4

P

passcode, 7.4

picture-in-guide, 4.4, 5.10

power indications, 9.14

power input, A.4

power switch, receiver, 2.3

powering off the system, 2.5, 2.9

powering on the system, 2.3-2.4, 2.8

preferences, system, 8.11-8.12

PREV CH button, 3.6

preview channel, 9.6

PROG button, 3.7

Program Director, 8.7-8.9

program guide

colors, meaning, 5.10

description, 4.4

download, 2.4

filtering, 6.7-6.8

future programs, 6.9

preferences, 5.9-5.11

styles, 5.3-5.4

using, 5.5

programming, remote control, 3.10

Purchases tab, 4.6

PWR button, 3.4

R

ratings limits, 7.5-7.6
reading mail, 8.10
receiver
 activation, 9.6
 beeping, 2.6
 buttons, 3.9
 connectors, A.4
 description, 1.5
 lights, 9.14-9.15
 multiple, A.3-A.15
 generic, A.10-A.15
 ordering additional, 3.11
 power switch, 2.3
 repairing, 9.9
 software upgrade, 8.13
Receiver light, 9.14-9.15
reception, 1.5-1.6
recurring programs, scheduling, 8.7
remote control
 batteries, 3.12
 buttons, 3.3

 changing ID, 3.11-3.12
 description, 1.4
 ordering a replacement, 3.9
 programming, 3.10
remote control ID, changing, 3.11-3.12
repairs, 9.9
replacing batteries, 3.12
resetting the system, 9.4
RF converter
 connection to receiver, A.4
 description, 1.4
 distance from receiver, 9.8

S

S-Video, A.5
safety warning, 3.3, A.3
SAT button, 3.4
satellite
 coverage area, 1.5, 9.5
 elevation angle, 1.6, A.17
 location, 1.5
saturation, 8.6
scheduling programs, 8.7-8.9
SEARCH button, 3.7
searching for programs, 6.10-6.12
SELECT button, 3.5
setting guide preferences, 5.9-5.11
setting system preferences, 8.11-8.12
setup, advanced, 8.12-8.13
snow on antenna, 9.5
software upgrade, 8.13
sorting the program guide, 5.10
spending limit, 7.7
splitter, A.6-A.15
SRS TruSurround, 8.5
system startup, 2.6
Stacked LNB, setup, 9.10-9.12
status lights, 9.14-9.15
symptoms, troubleshooting, 9.3
system information, 8.13

T

tag box, 6.3
technical support, 9.13
test, 8.13
time limits, 7.6-7.7
time zone, 8.11
translucency, menu, 8.6
troubleshooting, 9.1
troubleshooting matrix, 9.3
TruSurround, 8.5
TURBO button, 3.4
TurboTune, 5.7-5.9
turning off the system, 2.5, 2.9
turning on the system, 2.3-2.4, 2.8
TV control, 3.6, 3.10

U

unlocking the system, 7.5
Unstacked LNB, 9.9

V

VCR control, 3.8, 3.10
VCR control buttons, 3.8
vehicle power, A.5
VHF antenna, A.5
video adjustments, 8.5-8.6
VIDEO button, 3.7
viewing a program description, 2.5
viewing future programs, 6.9
viewing mail, 8.10
VOL button, 3.6
Voltage light, 9.14
volume, 3.6

W

WatchWizard, 6.10-6.12
weather, inclement, 9.5
widescreen, 8.6
wiring diagrams, A.3

wiring

one A5/M3 receiver, A.4
two A5/M3 receivers, A.6
three A5/M3 receivers, A.8
one generic receiver, A.10
two generic receivers, A.12
four or more receivers, A.14

TRACVISION[®]
BY KVH INDUSTRIES

KVH[®]
www.kvh.com

KVH Industries, Inc. • 50 Enterprise Center • Middletown, RI 02842-5279 U.S.A . • Phone: (401) 847-3327 • Fax: (401) 849-0045 • E-mail: info@kvh.com