

Messhilfe für Verschraubungsmaterial

- Measuring help for screw connections
- Gabarit pour système de serrage
- Misura per il materiale di avvitamento

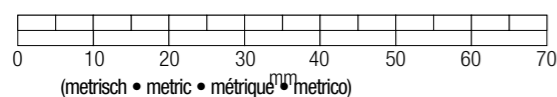
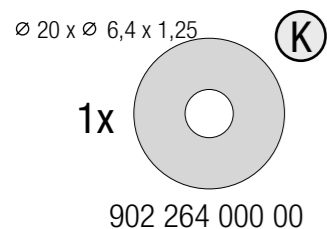
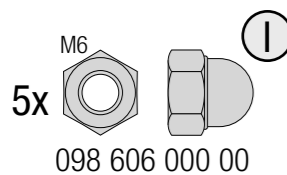
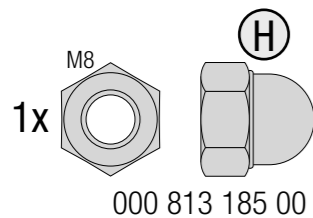
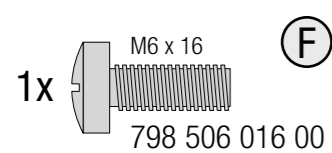
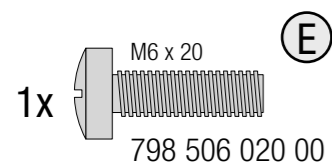
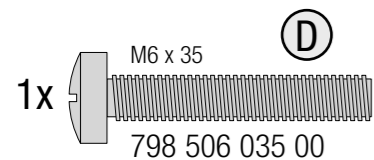
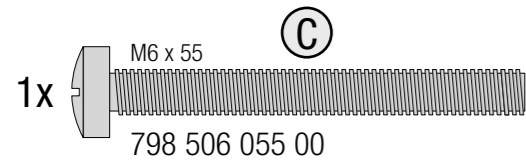
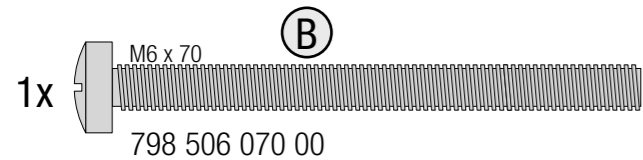
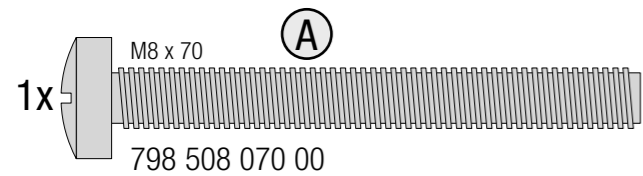

Ab Kaufdatum + garantierter Ersatzteilservice

From the date of purchase + guaranteed spare part service
A partir de la date d'achat + garantie service pièces détachées
Dalla data di acquisto + garanzia parti di ricambio a partire

Ausgenommen gebrauchsbedingter Abnutzung

The warranty does not cover damages caused by improper use or neglect
La garantie est exclue en cas de défaut d'entretien ou d'utilisation anormale
Sono esclusi danni causati da uso improprio o usura

----- USA only -----

180 days warranty

From the date of purchase + guaranteed spare part service

The warranty does not cover damages caused by improper use or neglect



- CHOKING HAZARD: Small parts. Danger of being swallowed. Contains small parts in non assembled state. Must be assembled by adults.
- Adult supervision required.
- Never use near steps, slopes, driveways, hills, roadways, alleys or swimming pool areas.
- Always wear shoes.
- Never allow more than one rider.
- The use of protective gear and a safety helmet is highly recommended.



- Achtung, verschluckbare Teile! Contains small parts, danger of being swallowed!
- Contient des petites pièces détachables peuvent être avalées!

rollyDIGGER rolyDigger

36 Months - 60 Months



rolly toys Service:
Tel: +49 (0) 95-68/-/85-61-46
Fax: +49 (0) 95-68/-/85-61-83
e-mail: service@rollytoys.de

2007/02

100.000.800.00

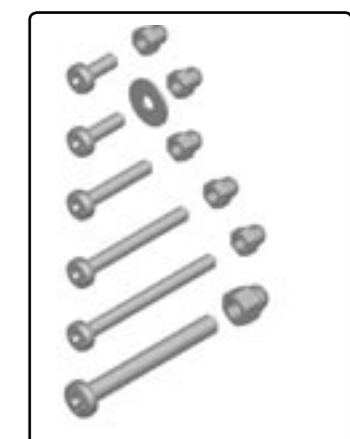
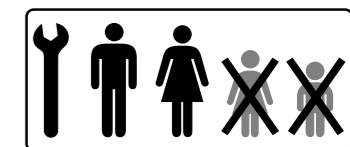
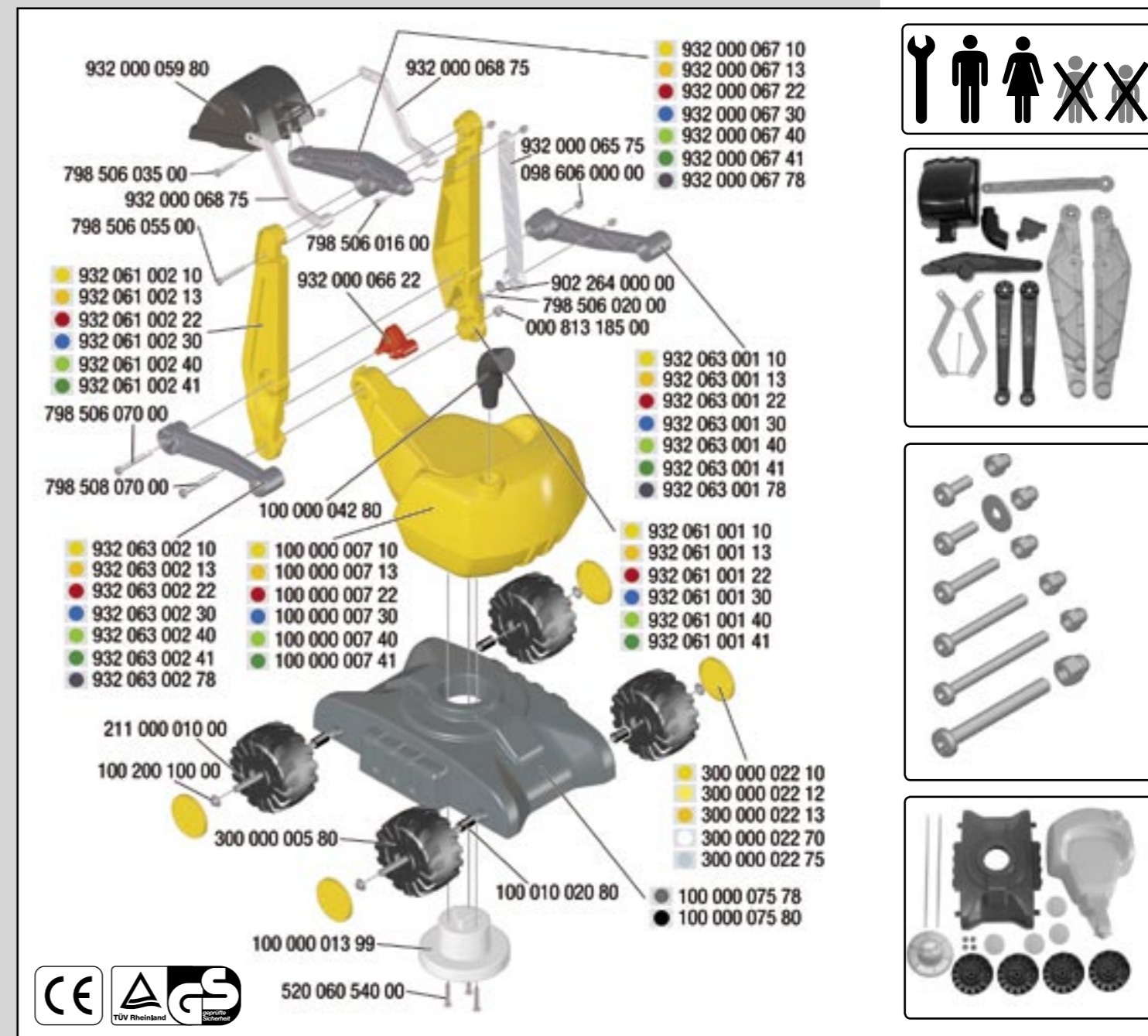

Vertretungen • Representatives abroad • Agences • Rappresentanti all'estero

A	Handelsagentur KundeGraber Tel. 0 22 30 / 79 0 79; Fax 0 22 30 / 79 0 80	FIN	Hot-Toys OY Tel. 0 19-688 4765; Fax 0 19-688 4880	PL	Brimarex Tel. 061 / 862 07 00; Fax 061 / 867 93 23
AUS	John Deere Ltd. Tel. 07 3802 / 3222; Fax 07 3803 / 6555	GB	Robbie Toys Ltd. Tel. 01 843 / 60 44 48; Fax 01 843 / 60 35 05	RO	RT CENTER SRL Tel. 0040 742 141 585; Fax 0040 269 212 099
B/L	QUAX N.V. Tel. 09 386 / 23 30; Fax 09 386 / 93 50	GR	John Hellas Ltd. Tel. 023 10 68 86 54; Fax 023 10 68 89 10	RU	OOO „JOHN-RUS“ Tel. 095 785 3993; Fax 095 369 6629
CH	Sombo AG Tel. 0 62 / 887 74 74; Fax 0 62 / 887 74 57	GY	Farfan and Mendes Limited Tel. 592 226 8130; Fax 592 225 8651	SC	Cobraplast d.o.o. Tel. +381 15 301240; Fax: +381 15 301242
CY	Costakis D. Koureas & Son LTD Tel. 025 71 13 08; Fax 025 71 13 32	HR	domi Tel. 01240 84 20; Fax: 01240 96 96	SE	SpeedGame AB Tel. 042 23 86 85; Fax 042 23 86 95
CZ	OLYMPtoys s.r.o. Tel. 0284 822 716; Fax 0284 822 341	I	Rolly Toys Italiana S.R.L. Tel. 0438 4466; Fax 0438 27372	SK	Tinako Tel. 00421 2 4594 4626; Fax: 00421 2 4594 4628
DK/N	Grandprix ApS, Bjarne Boie Tel. 049 17 / 60 78; Fax 049 17 / 60 70	IRL	Banaghan & Co. Ltd. Tel. 067 / 338 88; Fax 067 / 334 33	SLO	Moko d.o.o. Tel. 01 729 51 20; Fax: 01 729 51 27
	Service (DK/N/SE): Funnyland / Supertoys Tel. 075 61 / 10 70; Fax 075 61 / 10 95	N	ATEC AS (agricultural market) Tel. 051 77 07 30; Fax 051 77 07 40	USA	Kettler USA Tel. 001 757 427 24 00; Fax 001 757 427 01 83
F	Claude Piveteau, Agence Commerciale Tel. 04 68 68 40 10; Fax 04 68 68 40 11	NL	Born Agenturen Tel. 035 64 68 299; Fax 035 64 68 298	ZA	Jeffrey Stein Sales (PTY) Ltd. 2A-80/1 Cape Town

Franz Schneider GmbH & Co KG
P.O.Box 1460
D-96459 - Neustadt bei Coburg - Germany
Tel.: +49 (0) 95 68 / 8 56-0
Fax.: +49 (0) 95 68 / 8 56-190
www.rollytoys.com • e-mail: service@rollytoys.de

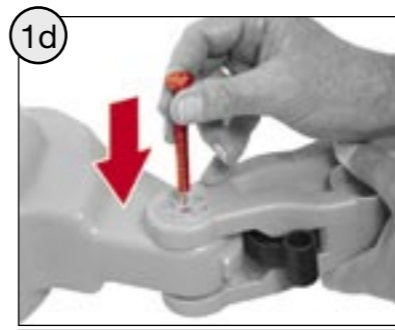
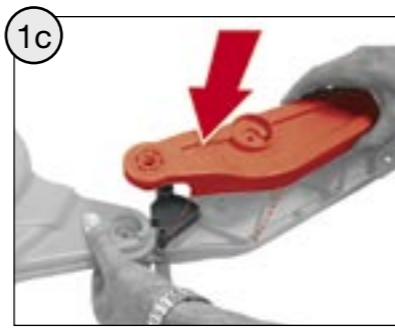
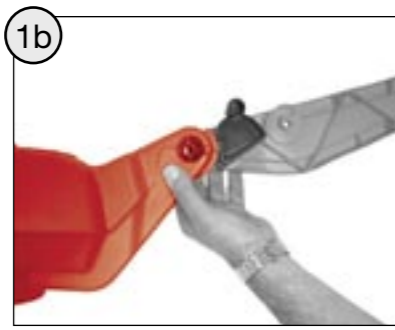
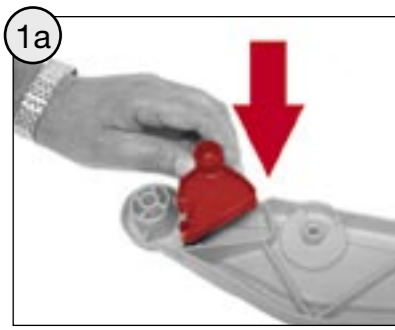

2x ^(A) M8 x 70



2x ^(H) M8

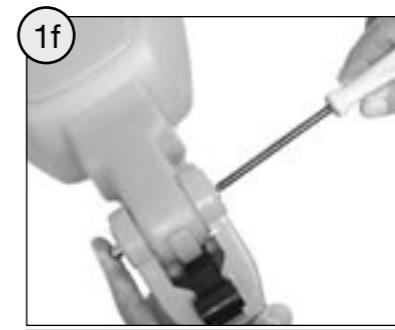

 ⁽⁺⁾

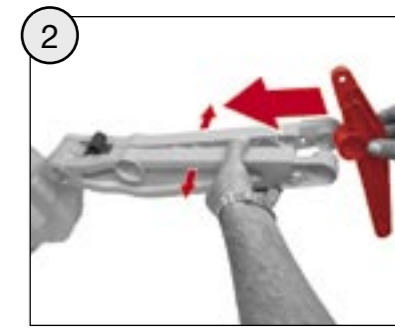

1x ^(B) M6 x 70 ^(I) M6



 ⁽⁺⁾

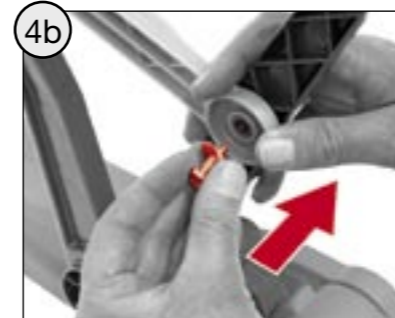

1x ^(E) M6 x 20 ^(K) ø20



1x ^(I) M6



 ⁽⁺⁾



1x ^(F) M6 x 16 ^(I) M6

 ⁽⁺⁾



 ⁽⁺⁾

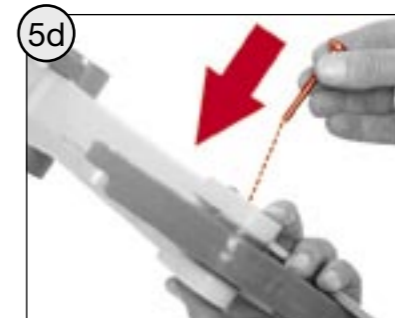
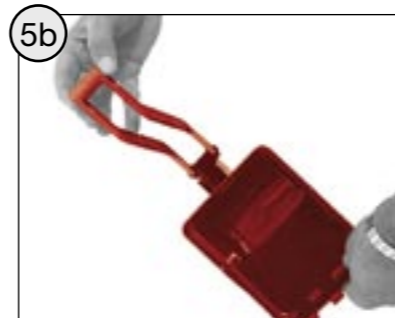

1x ^(C) M6 x 55



1x ^(I) M6



 ⁽⁺⁾



1x ^(D) M6 x 35 ^(I) M6



 ⁽⁺⁾

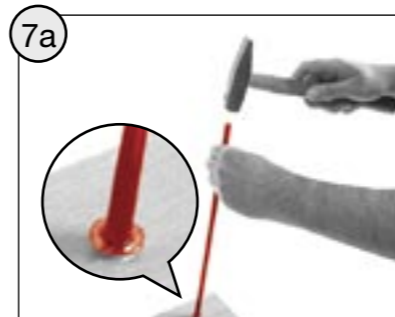

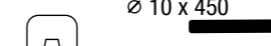
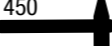
2x  ø 10 x 450 

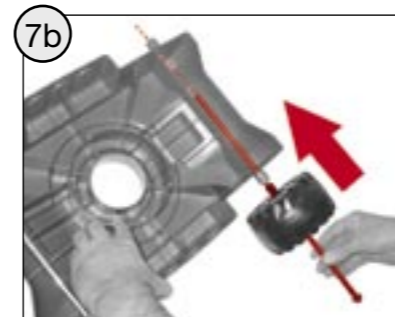

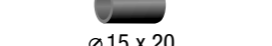

2x  ø 15 x 20

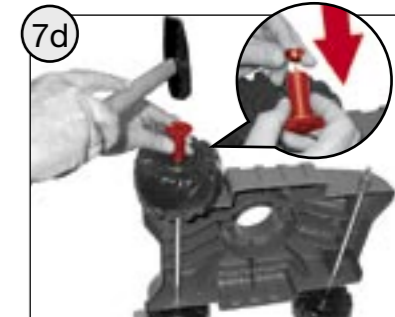

2x  ø 15 x 20



2x  



4x 



3x ^(G) ø 4 x 40

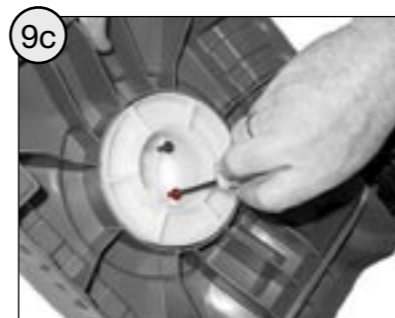

 ⁽⁺⁾



1x 