

Euro Sign System

The simple sign solution at the best cost.

The EURO Sign System comes in 5 anodized colors and is designed to make tamper resistant signs and directories. The clean lines of both 3/8" round or 3/8" square extrusions make an attractive, functional, inexpensive solution to interior signage.

AVAILABLE COLORS:

- SATIN SILVER
- POLISHED SILVER
- MATTE BLACK
- POLISHED YELLOW GOLD
- POLISHED ROSE GOLD.

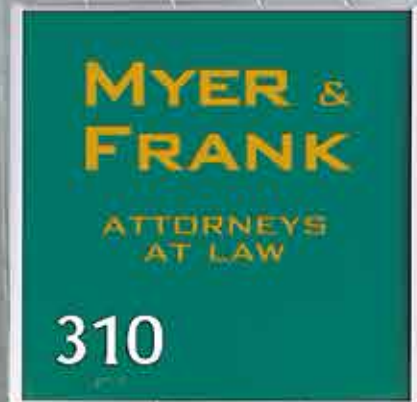
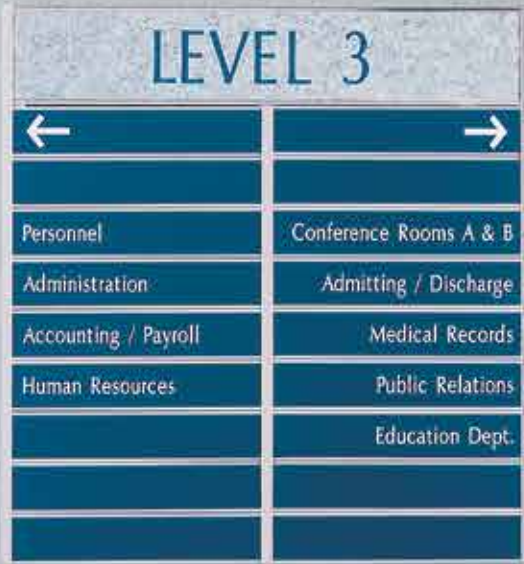

Square and round-headed screws are specially designed to cap off extrusions, and lock in holder assemblies. Simply remove the top screws and slide sign assemblies out for quick change. Screw holes are tapped for repeated use.



Euro Sign System

Square and round head screws are specially designed to cap off extrusions, and lock in the holder assemblies. Simply remove the top screws and slide sign assemblies out for a quick change. Screw holes are tapped for repeated use. Custom sizes are available. Please request a quotation. Available colors: Satin Silver, Polished Silver, Matte Black, Polished Yellow Gold and Polished Rose Gold. Call for quote on anodized finishes not listed. Prices are for frames up to 99 perimeter inches. Please request a quote for larger frames. Frames may be subject to crating charge.

Maximum frame size is 36" x 36".

2" x 8", 2" x 10" and other popular size directories in the Euro System use standard JRS holders (#36, 106, 109, 112, 89 and 37). Sign assemblies with sizes such as 6" x 6", 8" x 8", 12" x 12" etc. and other custom sizes use 2 #75 J-moldings as top and bottom rails for sign assemblies.

Note: All Euro Holders hold 1/16".

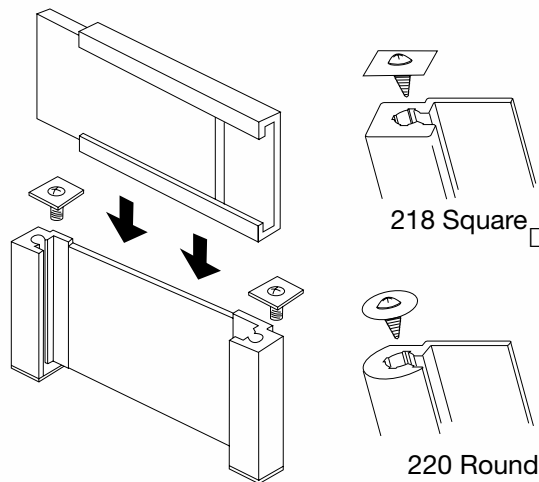

| Part No. | Size |
|----------------|-----------|
| 218208 Square | 2" x 8" |
| 220208 Round | 2" x 8" |
| 218210 Square | 2" x 10" |
| 220210 Round | 2" x 10" |
| 218312 Square | 3" x 12" |
| 220312 Round | 3" x 12" |
| 218618 Square | 6" x 18" |
| 220618 Round | 6" x 18" |
| 218606 Square | 6" x 6" |
| 220606 Round | 6" x 6" |
| 2181212 Square | 12" x 12" |
| 2201212 Round | 12" x 12" |
| 218808 Square | 8" x 8" |
| 220808 Round | 8" x 8" |
| 218806 Square | 8" x 6" |
| 220806 Round | 8" x 6" |

Commonly ordered sizes listed above. Not stocked. Non-returnable.

All frames can be combined for quantity discounts.

All frames are made to order. Custom sizes available. Non-returnable.

QUANTITY DISCOUNTS:

| | |
|-----------|-----|
| 25 pcs. | 5% |
| 100 pcs. | 10% |
| 500 pcs. | 20% |
| 1000 pcs. | 30% |



Euro Sign System

Sign assemblies are stacked to create multiple lines.

Commonly ordered sizes listed below. Not stocked. Non-returnable.

Specially designed machine screws lock the entire group of sign assemblies in place. Simply remove the top screws and slide sign assemblies out for a quick change. Screw holes are tapped for repeated use. Vertical dividers are used for multiple columns.

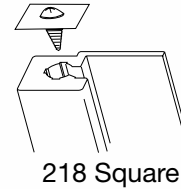
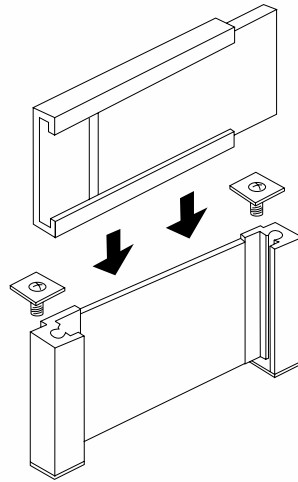
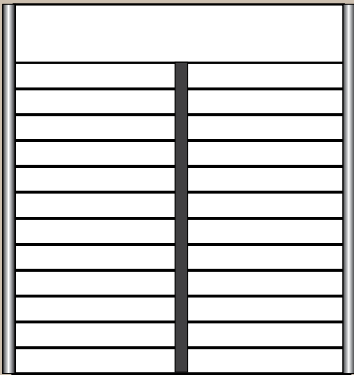
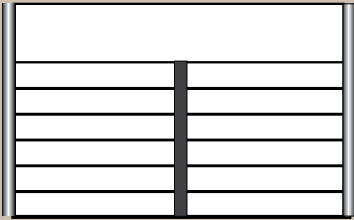
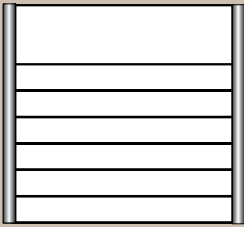
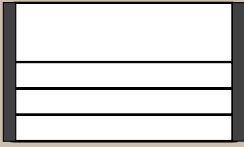

| Part No. | Header Size | Slots/ Size | Approximate Size |
|-------------------------------|-------------|-------------------------|------------------|
| 218D11 Square 220D11 Round | 2" | 3 Slots 3/4" x 8" | 4 3/4" x 8" |
| 218D21 Square 220D21 Round | 2" | 6 Slots 3/4" x 8" | 7 1/4" x 8" |
| 218D31 Square 220D31 Round | 2" | 12 Slots 3/4" x 6" | 7 1/4" x 12" |
| 218D41 Square 220D41 Round | 2" | 24 Slots 3/4" x 6" | 12 1/2" x 12" |
| 218D12 Square 220D12 Round | 2" | 3 Slots 1" x 8" | 5 1/2" x 8" |
| 218D22 Square 220D22 Round | 2" | 6 Slots 1" x 8" | 8 7/8" x 8" |
| 218D32 Square 220D32 Round | 2 1/2" | 12 Slots 1" x 6" | 9 1/4" x 12" |
| 218D13 Square 220D13 Round | 2 1/2" | 3 Slots 1 1/2" x 10" | 7 1/2" x 10" |
| 218D23 Square 220D23 Round | 2 1/2" | 6 Slots 1 1/2" x 10" | 12 1/4" x 10" |
| 218D42 Square 220D42 Round | 2 1/2" | 24 Slots 1" x 6" | 16" x 12" |
| 218D33 Square 220D33 Round | 3" | 12 Slots 1 1/2" x 8" | 12 7/8" x 16" |
| 218D43 Square 220D43 Round | 3" | 24 Slots 1 1/2" x 8" | 22 1/2" x 16" |

CUSTOM SIZES

218000 CALL FOR QUOTE
220000 CALL FOR QUOTE

QUANTITY DISCOUNTS:

25 pcs. 5%
100 pcs. 10%
500 pcs. 20%
1000 pcs. 30%

Prices are for frames up to 99 perimeter inches. Please request a quote for larger frames. Frames may be subject to crating charges.

All frames can be combined for quantity discounts.