



RSX2 LED Area Luminaire



Catalog Number
Notes
Type

Hit the Tab key or mouse over the page to see all interactive elements.

Mast arm to be fixed. No tilt/adjustable arm to be used

Specifications

EPA (ft²@0°):	0.69 ft ² (0.06 m ²)
Length:	29.3" (74.4 cm) (SPA mount)
Width:	13.4" (34.0 cm)
Height:	3.0" (7.6 cm) Main Body 7.2" (18.3 cm) Arm
Weight (max):	39.0 lbs (17.7 kg)

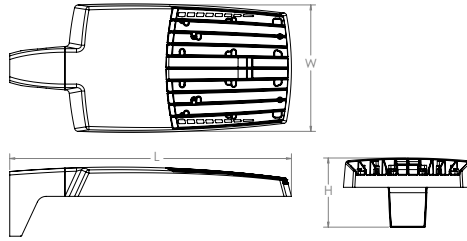

Introduction

The new RSX LED Area family delivers maximum value by providing significant energy savings, long life and outstanding photometric performance at an affordable price. The RSX2 delivers 11,000 to 31,000 lumens allowing it to replace 250W to 1000W HID luminaires.

The RSX features an integral universal mounting mechanism that allows the luminaire to be mounted on most existing drill hole patterns. This "no-drill" solution provides significant labor savings. An easy-access door on the bottom of mounting arm allows for wiring without opening the electrical compartment. A mast arm adaptor, adjustable integral slipfitter and other mounting configurations are available.

Ordering Information

EXAMPLE: RSX2 LED P6 40K R3 MVOLT SPA DDBXD

RSX2 LED					
Series	Performance Package	Color Temperature	Distribution	Voltage	Mounting
RSX2 LED	P1	30K 3000K	R2 Type 2 Wide	MVOLT (120V-277V) ²	SPA Square pole mounting (3.0" min. SQ pole for 1 at 90°, 3.5" min. SQ pole for 2, 3, 4 at 90°) RPA Round pole mounting (3.2" min. dia. RND pole for 2, 3, 4 at 90°, 3.0" min. dia. RND pole for 1 at 90°, 2 at 180°, 3 at 120°) MA Mast arm adaptor (fits 2-3/8" OD horizontal tenon) IS Adjustable slipfitter (fits 2-3/8" OD tenon) ⁵ WBA Wall bracket ¹ WBASC Wall bracket with surface conduit box AASP Adjustable tilt arm square pole mounting ⁵ AARP Adjustable tilt arm round pole mounting ⁵ AAWB Adjustable tilt arm with wall bracket ⁵ AAWSC Adjustable tilt arm wall bracket and surface conduit box ⁵
	P2	40K 4000K	R3 Type 3 Wide	HVOLT (347V-480V) ³	
	P3	50K 5000K	R3S Type 3 Short	(use specific voltage for options as noted)	
	P4		R4 Type 4 Wide	120 ³ 277 ⁴	
	P5		R4S Type 4 Short	208 ³ 347 ⁴	
	P6		R5 Type 5 Wide ¹	240 ³ 480 ⁴	
			R5S Type 5 Short ¹		
			AFR Automotive Front Row		
			AFRR90 Automotive Front Row Right Rotated		
			AFRL90 Automotive Front Row Left Rotated		

Options	Finish
<p>Shipped Installed</p> <p>HS House-side shield⁶</p> <p>PE Photocontrol, button style^{7,8}</p> <p>PEX Photocontrol external threaded, adjustable^{8,9}</p> <p>PER7 Seven-wire twist-lock receptacle only (no controls)^{8,10,11,12}</p> <p>CE34 Conduit entry 3/4" NPT (Qty 2)</p> <p>SF Single fuse (120, 277, 347)⁴</p> <p>DF Double fuse (208, 240, 480)⁴</p> <p>SPD20KV 20KV Surge pack (10KV standard)</p> <p>FAO Field adjustable output^{8,12}</p> <p>DMG 0-10V dimming extend out back of housing for external control (control ordered separate)^{8,12}</p> <p>DS Dual switching^{8,13}</p>	<p>Shipped Installed</p> <p>*Standalone and Networked Sensors/Controls (factory default settings, see table page 9)</p> <p>NLTAIR2 nLight AIR generation 2^{12,14,15}</p> <p>PIRHN Networked, Bi-Level motion/ambient sensor (for use with NLTAIR2)^{12,15,16}</p> <p>*Note: PIRHN with nLight Air can be used as a standalone dimming sensor with out-of-box settings or as a wireless networked solution. See factory default settings table. Sensor coverage pattern is affected when luminaire is tilted.</p> <p>Shipped Separately (requires some field assembly)</p> <p>EGS External glare shield⁵</p> <p>EGFV External glare full visor (360° around light aperture)⁶</p> <p>BS Bird spikes¹⁷</p>
	<p>DDBXD Dark Bronze</p> <p>DBLXD Black</p> <p>DNAXD Natural Aluminum</p> <p>DWHXD White</p> <p>DBTDXD Textured Dark Bronze</p> <p>DBL BXD Textured Black</p> <p>DNATXD Textured Natural Aluminum</p> <p>DWHGXD Textured White</p>



Ordering Information

Accessories

Ordered and shipped separately.

RSX2HS	RSX2 House side shield (includes 2 shields)
RSX2EGS (FINISH) U	External glare shield (specify finish)
RSX2HSAFRR (FINISH) U	RSX2 House side shields for AFR rotated optics (includes 2 shields)
RSX2EGFV (FINISH) U	External glare full visor (specify finish)
RSXRPA (FINISH) U	RSX Universal round pole adaptor plate (specify finish)
RSXWBA (FINISH) U	RSX WBA wall bracket (specify finish) ¹
RSXSBCB (FINISH) U	RSX Surface conduit box (specify finish, for use with WBA, WBA not included)
DLL127F 1.5 JU	Photocell -SSL twist-lock (120-277V) ¹⁸
DLL347F 1.5 CULJU	Photocell -SSL twist-lock (347V) ¹⁸
DLL480F 1.5 CULJU	Photocell -SSL twist-lock (480V) ¹⁸
DSHORT SBK U	Shorting cap ¹⁸

NOTES

- 1 Any Type 5 distribution, is not available with WBA.
- 2 MVOLT driver operates on any line voltage from 120-277V (50/60 Hz).
- 3 HVOLT driver operates on any line voltage from 347-480V (50/60 Hz).
- 4 Single fuse (SF) requires 120V, 277V or 347V. Double fuse (DF) requires 208V, 240V or 480V.
- 5 Maximum tilt is 90° above horizontal.
- 6 It may be ordered as an accessory.
- 7 Requires MVOLT or 347V.
- 8 Not available in combination with other light sensing control options (following options cannot be combined: PE, PEX, PER7, FAO, DMG, DS, PIRHN).
- 9 Requires 120V, 208V, 240V, 277V or 347V.
- 10 Twistlock photocell ordered and shipped as a separate line item from Acuity Brands Controls. See accessories. Shorting Cap included. Dimming leads capped for future use.

- 11 For units with option PER7, the mounting must be restricted to +/- 45° from horizontal aim per ANSI C136.10-2010.
- 12 Two or more of the following options cannot be combined including DMG, DS, PER7, FAO and PIRHN.
- 13 DS only available on performance package P4, P5 and P6.
- 14 Must be ordered with PIRHN.
- 15 Requires MVOLT or HVOLT.
- 16 Must be ordered with NLTAIR2. For additional information on PIRHN visit [here](#).
- 17 Must be ordered with fixture for factory pre-drilling.
- 18 Requires luminaire to be specified with PER7 option. Ordered and shipped as a separate line item from Acuity Brands Controls.

External Shields

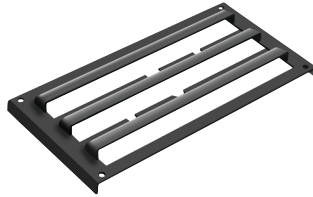

House Side Shield



External Glare Shield



External 360 Full Visor

Pole/Mounting Information

Accessories including bullhorns, cross arms and other adapters are available under the accessories tab at Lithonia's Outdoor Poles and Arms product page. Click here to visit [Accessories](#).

HANDHOLE ORIENTATION

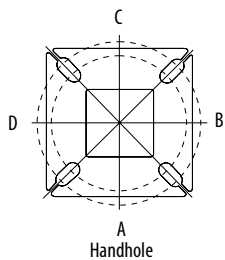

RSX POLE DRILLING

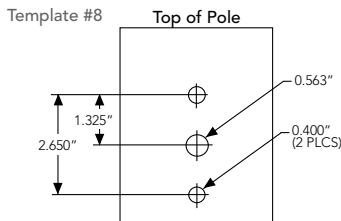

RSX STANDARD ARM & ADJUSTABLE ARM

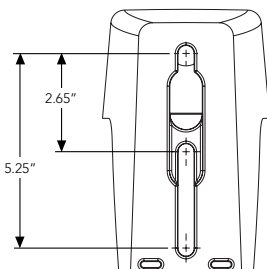

Round Tenon Mount - Pole Top Slipfitters

Tenon O.D.	RSX Mounting	Single	2 at 180°	2 at 90°	3 at 120°	3 at 90°	4 at 90°
2 - 3/8"	RPA, AARP	AS3-5 190	AS3-5 280	AS3-5 290	AS3-5 320	AS3-5 390	AS3-5 490
2 - 7/8"	RPA, AARP	AST25-190	AST25-280	AST25-290	AST25-320	AST25-390	AST25-490
4"	RPA, AARP	AST35-190	AST35-280	AST35-290	AST35-320	AST35-390	AST35-490

Drill/Side Location by Configuration Type

Drilling Template	Mounting Option	Single	2 @ 180	2 @ 90	3 @ 120	3 @ 90	4 @ 90
	Head Location	Side B	Side B & D	Side B & C	Round Pole Only	Side B, C & D	Side A, B, C & D
#8	Drill Nomenclature	DM19AS	DM28AS	DM29AS	DM32AS	DM39AS	DM49AS

RSX2 - Luminaire EPA

*Includes luminaire and integral mounting arm. Other tenons, arms, brackets or other accessories are not included in this EPA data.

Fixture Quantity & Mounting Configuration	Single	2 @ 90	2 @ 180	3 @ 90	3 @ 120	4 @ 90	2 Side by Side	3 Side by Side	4 Side by Side
SPA - Square Pole Adaptor	0.69	1.22	1.27	1.8	1.61	2.39	1.37	2.06	2.74
RPA - Round Pole Adaptor	0.74	1.27	1.37	1.9	1.71	2.49	1.42	2.16	2.84
MA - Mast Arm Adaptor	0.61	1.14	1.11	1.64	1.45	2.23	1.29	1.9	2.58
IS - Integral Slipfitter AASP/AARP - Adjustable Arm Square/Round Pole	0°	0.69	1.22	1.27	1.8	1.61	2.39	1.37	2.06
	10°	0.53	1.06	1.05	1.58	1.37	2.08	1.06	1.69
	20°	0.52	1.02	1.03	1.52	1.33	2.02	1.05	1.55
	30°	0.64	1.11	1.18	1.63	1.45	2.21	1.27	1.91
	40°	0.81	1.21	1.35	1.74	1.65	2.39	1.62	2.43
	45°	0.91	1.25	1.5	1.81	1.75	2.48	1.82	2.73
	50°	1.34	1.83	2.17	2.61	2.56	3.62	2.68	4.02
	60°	2.2	2.97	3.57	4.24	4.17	5.89	4.41	6.61
	70°	2.86	4.13	4.7	5.89	5.71	8.21	5.71	8.57
	80°	3.4	5.13	5.67	7.34	7.09	10.21	6.79	10.19
90°	3.85	5.96	6.55	8.58	8.31	11.88	7.70	11.56	

Photometric Diagrams

To see complete photometric reports or download .ies files for this product, visit Lithonia Lighting's RSX Area homepage.

Isofootcandle plots for the RSX2 LED P6 40K. Distances are in units of mounting height (30').

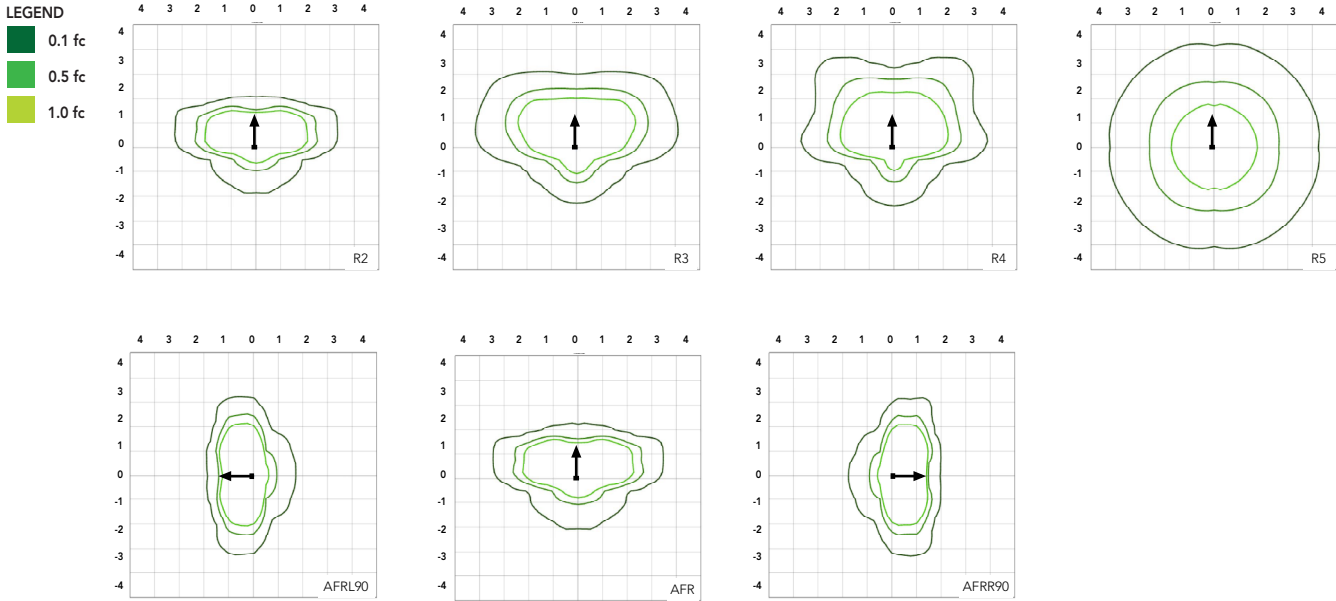

Performance Data

Lumen Ambient Temperature (LAT) Multipliers

Use these factors to determine relative lumen output for average ambient temperatures from 0-50°C (32-122°F).

Ambient	Ambient	Lumen Multiplier
0°C	32°F	1.05
5°C	41°F	1.04
10°C	50°F	1.03
15°C	59°F	1.02
20°C	68°F	1.01
25°C	77°F	1.00
30°C	86°F	0.99
35°C	95°F	0.98
40°C	104°F	0.97
45°C	113°F	0.96
50°C	122°F	0.95

Electrical Load

Performance Package	System Watts (W)	Current (A)					
		120V	208V	240V	277V	347V	480V
P1	71W	0.59	0.34	0.30	0.26	0.20	0.15
P2	111W	0.93	0.53	0.46	0.40	0.32	0.23
P3	147W	1.23	0.70	0.61	0.53	0.42	0.31
P4	187W	1.55	0.90	0.78	0.68	0.53	0.38
P5	210W	1.75	1.01	0.87	0.76	0.60	0.44
P6	244W	2.03	1.17	1.01	0.88	0.70	0.51

Projected LED Lumen Maintenance

Operating Hours	50,000	75,000	100,000
Lumen Maintenance Factor	>0.97	>0.95	>0.92

Values calculated according to IESNA TM-21-11 methodology and valid up to 40°C.

Lumen Output

Lumen values are from photometric tests performed in accordance with IESNA LM-79-08. Data is considered to be representative of the configurations shown, within the tolerances allowed by Lighting Facts. Contact factory for performance data on any configurations not shown here.

Performance Package	System Watts	Distribution Type	30K (3000K, 70 CRI)					40K (4000K, 70 CRI)					50K (5000K, 70 CRI)				
			Lumens	B	U	G	LPW	Lumens	B	U	G	LPW	Lumens	B	U	G	LPW
P1	71W	R2	10,040	2	0	1	139	11,031	2	0	1	153	11,031	2	0	1	153
		R3	10,005	2	0	2	141	10,992	2	0	2	155	10,992	2	0	2	155
		R3S	10,271	2	0	2	143	11,285	2	0	2	157	11,285	2	0	2	157
		R4	10,136	2	0	2	143	11,136	2	0	2	157	11,136	2	0	2	157
		R4S	9,779	2	0	2	138	10,744	2	0	2	151	10,744	2	0	2	151
		R5	10,271	4	0	2	145	11,285	4	0	2	159	11,285	4	0	2	159
		R5S	10,544	3	0	1	149	11,585	3	0	2	163	11,585	3	0	2	163
		AFR	10,026	2	0	1	141	11,016	2	0	1	155	11,016	2	0	1	155
		AFRR90	10,122	3	0	2	140	11,121	3	0	2	154	11,121	3	0	2	154
		AFRL90	10,164	3	0	2	141	11,167	3	0	2	155	11,167	3	0	2	155
P2	111W	R2	15,712	2	0	2	138	17,263	2	0	2	151	17,263	2	0	2	151
		R3	15,657	2	0	3	141	17,202	3	0	3	155	17,202	3	0	3	155
		R3S	16,075	2	0	2	141	17,661	2	0	2	155	17,661	2	0	2	155
		R4	15,862	2	0	3	143	17,427	2	0	3	157	17,427	2	0	3	157
		R4S	15,304	2	0	2	138	16,815	2	0	2	151	16,815	2	0	2	151
		R5	16,075	4	0	2	145	17,661	5	0	3	159	17,661	5	0	3	159
		R5S	16,502	4	0	2	149	18,130	4	0	2	163	18,130	4	0	2	163
		AFR	15,691	2	0	2	141	17,240	2	0	2	155	17,240	2	0	2	155
		AFRR90	15,841	3	0	3	139	17,404	4	0	3	153	17,404	4	0	3	153
		AFRL90	15,907	3	0	3	139	17,477	4	0	3	153	17,477	4	0	3	153
P3	147W	R2	19,855	3	0	2	132	21,814	3	0	2	145	21,814	3	0	2	145
		R3	19,785	3	0	3	135	21,737	3	0	4	148	21,737	3	0	4	148
		R3S	20,312	3	0	3	135	22,317	3	0	3	149	22,317	3	0	3	149
		R4	20,044	3	0	3	136	22,022	3	0	4	150	22,022	3	0	4	150
		R4S	19,339	3	0	3	132	21,247	3	0	3	145	21,247	3	0	3	145
		R5	20,313	5	0	3	138	22,317	5	0	3	152	22,317	5	0	3	152
		R5S	20,852	4	0	2	142	22,910	4	0	2	156	22,910	4	0	2	156
		AFR	19,828	3	0	2	135	21,785	3	0	2	148	21,785	3	0	2	148
		AFRR90	20,017	4	0	3	133	21,992	4	0	3	147	21,992	4	0	3	147
		AFRL90	20,101	4	0	3	134	22,084	4	0	3	147	22,084	4	0	3	147
P4	187W	R2	22,836	3	0	2	120	25,090	3	0	2	132	25,090	3	0	2	132
		R3	22,756	3	0	4	122	25,002	3	0	4	134	25,002	3	0	4	134
		R3S	23,363	3	0	3	123	25,668	3	0	3	135	25,668	3	0	3	135
		R4	23,054	3	0	4	123	25,329	3	0	4	135	25,329	3	0	4	135
		R4S	22,243	3	0	3	119	25,059	3	0	3	134	25,059	3	0	3	134
		R5	23,363	5	0	3	125	25,669	5	0	4	137	25,669	5	0	4	137
		R5S	23,983	4	0	2	128	26,350	4	0	2	141	26,350	4	0	2	141
		AFR	22,806	3	0	2	122	25,056	3	0	2	134	25,056	3	0	2	134
		AFRR90	23,023	4	0	3	121	25,295	4	0	3	133	25,295	4	0	3	133
		AFRL90	23,120	4	0	3	122	25,401	4	0	3	134	25,401	4	0	3	134
P5	210W	R2	26,141	3	0	2	122	28,721	3	0	2	135	28,721	3	0	2	135
		R3	26,049	3	0	4	124	28,620	3	0	4	136	28,620	3	0	4	136
		R3S	26,744	3	0	3	125	29,383	3	0	4	138	29,383	3	0	4	138
		R4	26,390	3	0	4	126	28,994	3	0	4	138	28,994	3	0	4	138
		R4S	25,462	3	0	3	121	27,974	3	0	3	133	27,974	3	0	3	133
		R5	26,744	5	0	4	127	29,383	5	0	4	140	29,383	5	0	4	140
		R5S	27,454	4	0	2	131	30,163	4	0	2	144	30,163	4	0	2	144
		AFR	26,106	3	0	2	124	28,682	3	0	2	137	28,682	3	0	2	137
		AFRR90	26,354	4	0	3	123	28,955	5	0	3	136	28,955	5	0	3	136
		AFRL90	26,465	4	0	3	124	29,077	5	0	3	136	29,077	5	0	3	136
P6	244W	R2	27,646	3	0	2	112	30,374	3	0	2	123	30,374	3	0	2	123
		R3	27,549	3	0	4	113	30,267	3	0	4	124	30,267	3	0	4	124
		R3S	28,283	3	0	3	115	31,075	3	0	4	126	31,075	3	0	4	126
		R4	27,909	3	0	4	114	30,663	3	0	4	126	30,663	3	0	4	126
		R4S	26,928	3	0	3	110	29,585	3	0	3	121	29,585	3	0	3	121
		R5	28,284	5	0	4	116	31,075	5	0	4	127	31,075	5	0	4	127
		R5S	29,035	4	0	2	119	31,900	5	0	3	131	31,900	5	0	3	131
		AFR	27,608	3	0	2	112	30,332	3	0	2	123	30,332	3	0	2	123
		AFRR90	27,872	4	0	3	113	30,622	5	0	3	124	30,622	5	0	3	124
		AFRL90	27,989	4	0	3	113	30,751	5	0	3	125	30,751	5	0	3	125

Dimensions

RSX2 with Round Pole Adapter (RPA)

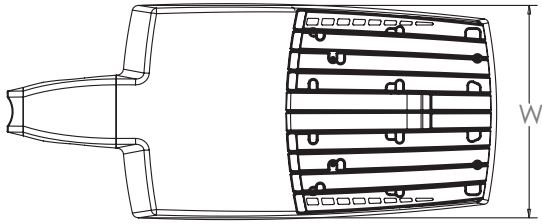

Length: 30.3" (77.0 cm)
Width: 13.4" (34.0 cm)
Height: 3.0" (7.6 cm) Main Body
7.2" (18.3 cm) Arm

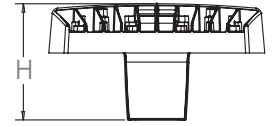
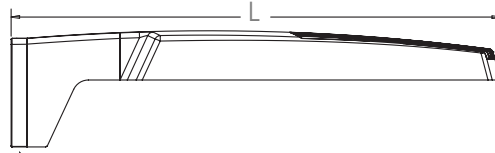

Note: RPA — Round Pole mount can also be used to mount on square poles by omitting the round pole adapter plate shown here.



RSX2 with Mast Arm Adapter (MA)

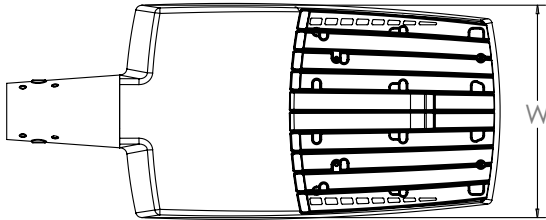

Length: 30.6" (77.7 cm)
Width: 13.4" (34.0 cm)
Height: 3.0" (7.6 cm) Main Body
3.5" (8.9 cm) Arm

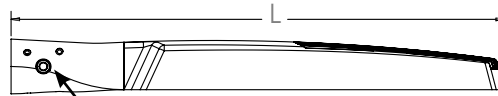

7/16" locking thru bolt/nut provided

~~RSX2 with Adjustable Slipfitter (IS)~~

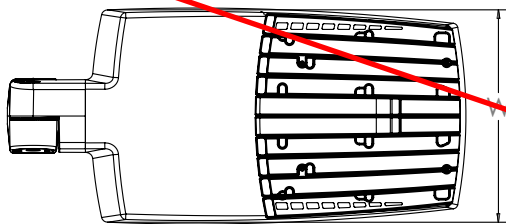

Length: 28.3" (71.9 cm)
Width: 13.4" (34.0 cm)
Height: 3.0" (7.6 cm) Main Body
7.6" (19.3 cm) Arm

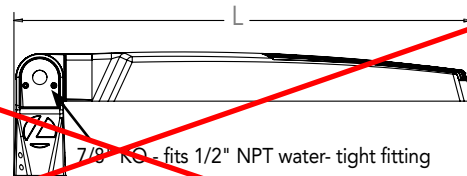

7/8" KO - fits 1/2" NPT water-tight fitting

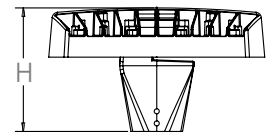

Dimensions

RSX2 with Wall Bracket (WBA)

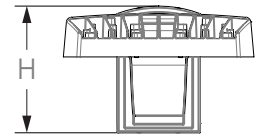
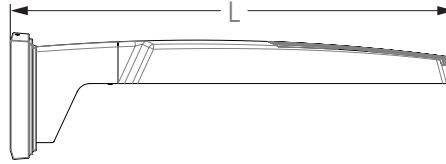
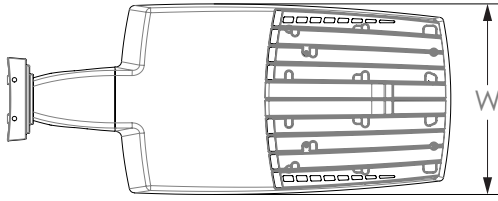

Length: 31.2" (79.2 cm)
 Width: 13.4" (41.7 cm)
 Height: 3.0" (7.6 cm) Main Body
 8.9" (22.6 cm) Arm

Wall Bracket (WBA) Mounting Detail

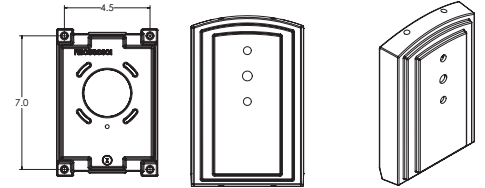

RSX2 with Wall Bracket with Surface Conduit Box (WBASC)

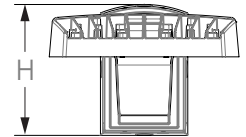
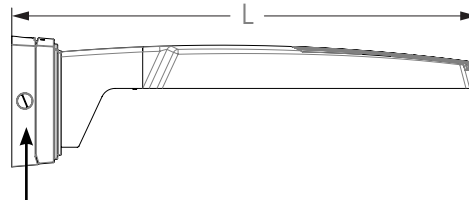
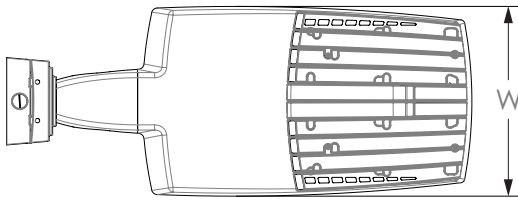

3/4" NPT taps with plugs - Qty (4) provided

Length: 32.8" (83.3 cm)
 Width: 13.4" (41.7 cm)
 Height: 3.0" (7.6 cm) Main Body
 9.2" (23.4 cm) Arm

Surface Conduit Box (SCB) Mounting Detail

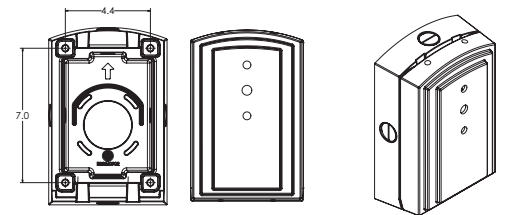

Dimensions

RSX2 with Adjustable Tilt Arm - Square or Round Pole (AASP or AARP)

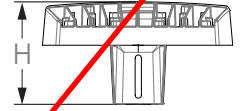
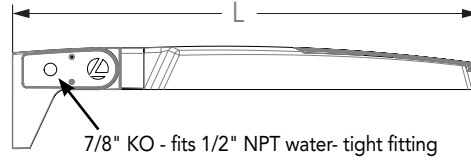
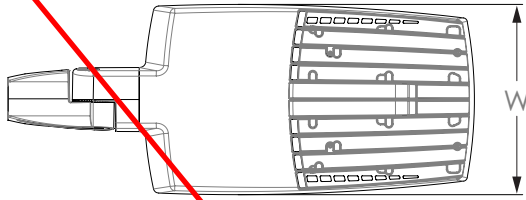

Length: 32.8" (83.3 cm) **AASP**
 33.8" (85.9 cm) **AARP**
 Width: 13.4" (34.0 cm)
 Height: 3.0" (7.6 cm) Main Body
 7.2" (18.2 cm) Arm

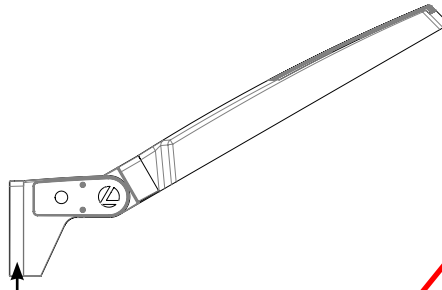

NOTE:
 RPA - Round Pole mount can also be used to mount on square poles by omitting the round pole adapter plate shown here.



Notes
 AASP: Requires 3.0" min. square pole for 1 at 90°. Requires 3.5" min. square pole for mounting 2, 3, 4 at 90°.
 AARP: Requires 3.2" min. dia. round pole for 2, 3, 4 at 90°. Requires 3.0" min. dia. round pole for mounting 1 at 90°, 2 at 180°, 3 at 120°.

RSX2 with Adjustable Tilt Arm with Wall Bracket (AAWB)

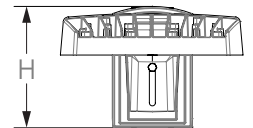
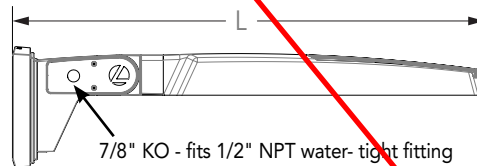
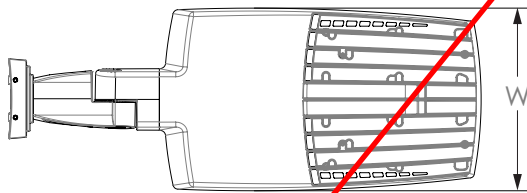

Length: 34.7" (88.0 cm)
 Width: 13.4" (34.0 cm)
 Height: 3.0" (7.6 cm) Main Body
 8.9" (22.6 cm) Arm

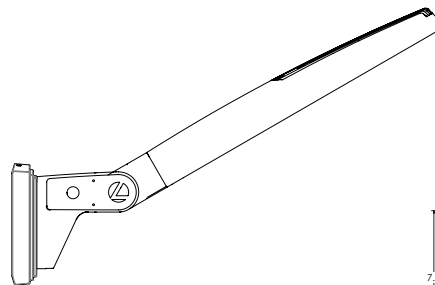

Wall Bracket (WBA) Mounting Detail

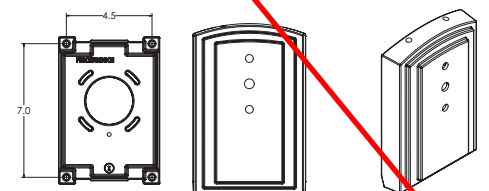

Dimensions

RSX2 with Adjustable Tilt Arm with Wall Bracket and Surface Conduit Box (AAWSC)

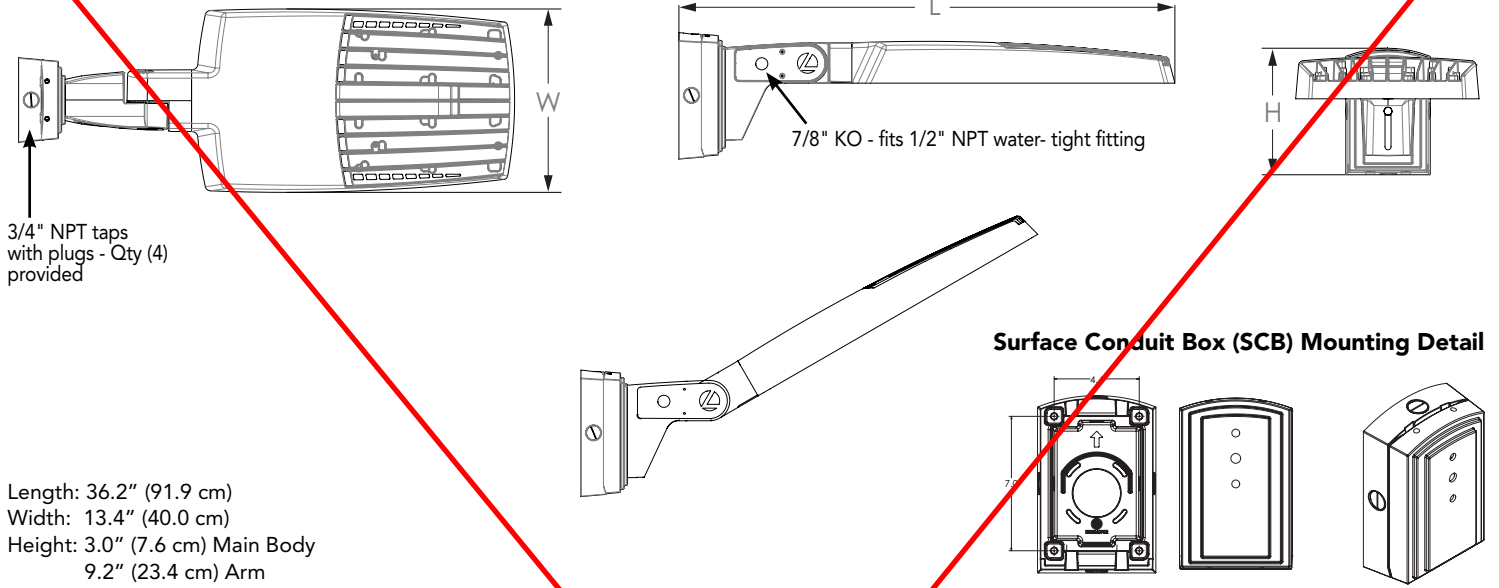

Additional Reference Drawings

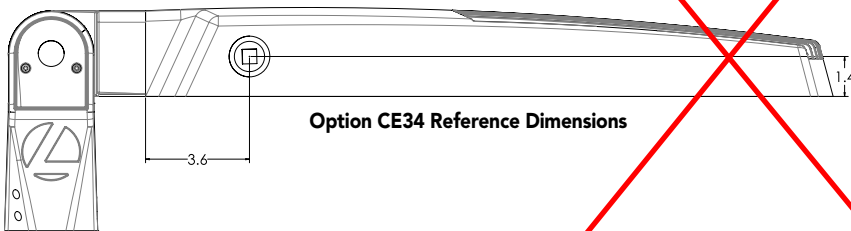

Automotive Front Row - Rotated Optics (AFRR90/R90)

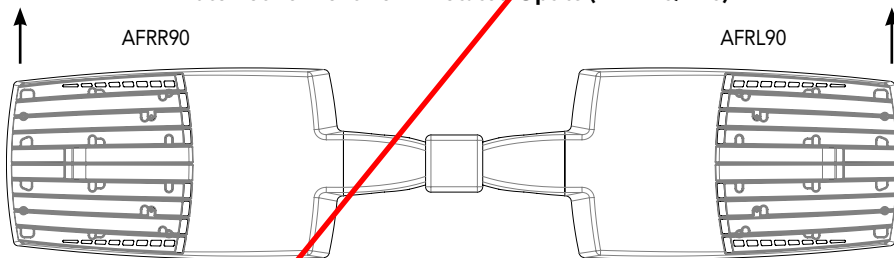

PIRHN nLight Sensor Coverage Pattern

nLight PIRHN

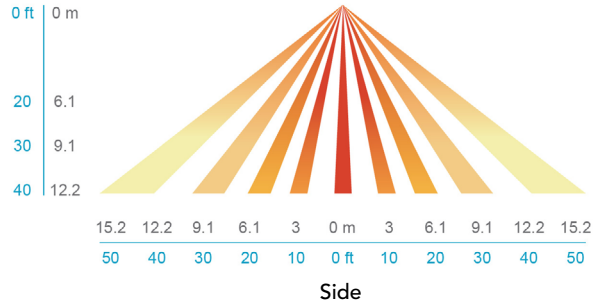
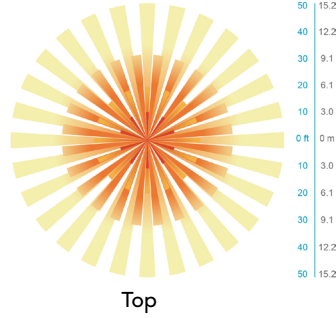
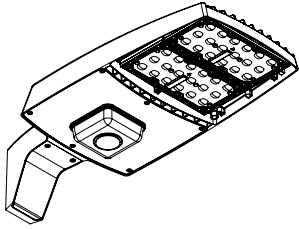

Motion Sensor Default Settings - Option PIRHN						
Option	Dimmed State (unoccupied)	High Level (when occupied)	Photocell Operation	Dwell Time (occupancy time delay)	Ramp-up Time (from unoccupied to occupied)	Ramp-down Time (from occupied to unoccupied)
PIRHN	Approx. 30% Output	100% Output	Enabled @ 1.5FC	7.5 minutes	3 seconds	5 minutes

*Note: PIRHN default settings including photocell set-point, high/low dim rates, and occupancy sensor time delay are all configurable using the Clarity Pro App.

FEATURES & SPECIFICATIONS

INTENDED USE

The RSX LED area family is designed to provide a long-lasting, energy-efficient solution for the one-for-one replacement of existing metal halide or high pressure sodium lighting. The RSX2 delivers 11,000 to 31,000 lumens and is ideal for replacing 250W to 1000W HID pole-mounted luminaires in parking lots and other area lighting applications.

CONSTRUCTION AND DESIGN

The RSX LED area luminaire features a rugged die-cast aluminum main body that uses heat-dissipating fins and flow-through venting to provide optimal thermal management that both enhances LED performance and extends component life. Integral "no drill" mounting arm allows the luminaire to be mounted on existing pole drillings, greatly reducing installation labor. The light engines and housing are sealed against moisture and environmental contaminants to IP66. The low-profile design results in a low EPA, allowing pole optimization. Vibration rated per ANSI C136.31: 3G Mountings: SPA, RPA, MA, IS, AASP, AARP rated for 3G vibration. 1.5G Mountings: WBA, WBASC, AAWB and AAWSC rated for 1.5G vibration.

FINISH

Exterior parts are protected by a zinc-infused Super Durable TGIC thermoset powder coat finish that provides superior resistance to corrosion and weathering. A tightly controlled multi-stage process ensures superior adhesion as well as a minimum finish thickness of 3 mils. The result is a high-quality finish that is warranted not to crack or peel.

OPTICS

Precision acrylic refractive lenses are engineered for superior application efficiency, distributing the light to where it is needed most. Available in short and wide pattern distributions including Type 2, Type 3, Type 3S, Type 4, Type 4S, Type 5, Type 5S, AFR (Automotive Front Row) and AFR rotated AFRR90 and ARFL90.

ELECTRICAL

Light engine(s) configurations consist of high-efficacy LEDs mounted on metal-core circuit boards and aluminum heat sinks to maximize heat dissipation. Light engines are IP66 rated. LED lumen maintenance is >L92/100,000 hours. CCT's of 3000K, 4000K and 5000K (minimum 70 CRI) are available. Class 1 electronic drivers ensure system power factor >90% and THD <20%. Easily serviceable 10kV surge protection device meets a minimum Category C Low operation (per ANSI/IEEE C62.41.2).

STANDARD CONTROLS

The RSX LED area luminaire has a wide assortment of control options. Dusk to dawn controls include MVOLT and 347V button-type photocells and NEMA twist-lock photocell receptacles.

nLIGHT AIR CONTROLS

The RSX LED area luminaire is also available with nLight® AIR for the ultimate in wireless control. This powerful controls platform provides out-of-the-box basic motion sensing with photocontrol functionality and is suitable for mounting heights up to 40 feet. No commissioning is required when using factory default settings that provide basic stand-alone motion occupancy dimming that is switched on and off with a built-in photocell. See chart above for motion sensor default out-of-box settings. For more advanced wireless functionality, such as group dimming, nLight AIR can be commissioned using a smartphone and the easy-to-use CLAIRITY app. nLight AIR equipped luminaires can be grouped, resulting in motion sensor and photocell group response without the need for additional equipment. Scheduled dimming with motion sensor over-ride can be achieved when used with the nLight Eclipse. Additional information about nLight Air can be found [here](#).

INSTALLATION

Integral "no-drill" mounting arm allows for fast, easy mounting using existing pole drillings. Select the "SPA" option for square poles and the "RPA" option to mount to round poles. Note, the RPA mount can also be used for mounting to square poles by omitting the RPA adapter plate. Select the "MA" option to attach the luminaire to a 2 3/8" horizontal mast arm or the "IS" option for an adjustable slipfitter that mounts on a 2 3/8" OD tenon. The adjustable slipfitter has an integral junction box and offers easy installation. Can be tilted up to 90° above horizontal. Additional mountings are available including a wall bracket, adjustable tilt arm for direct-to-pole and wall and a surface conduit box for wall mount applications.

LISTINGS

CSA Certified to meet U.S. and Canadian standards. Suitable for wet locations. Rated for -40°C minimum ambient. DesignLights Consortium® (DLC) Premium qualified product and DLC qualified product. Not all versions of this product may be DLC Premium qualified or DLC qualified. Please check the DLC Qualified Products List at www.designlights.org/QPL to confirm which versions are qualified.

WARRANTY

5-year limited warranty. Complete warranty terms located at: www.acuitybrands.com/support/customer-support/terms-and-conditions

Note: Actual performance may differ as a result of end-user environment and application. All values are design or typical values, measured under laboratory conditions at 25 °C. Specifications subject to change without notice.



RSX3 LED Area Luminaire



Mast arm to be fixed. No tilt/adjustable arm to be used

Catalog Number
Notes
Type

Hit the Tab key or mouse over the page to see all interactive elements.

Specifications

EPA (ft²@0°):	0.70 ft ² (0.07 m ²)
Length:	33.8" (85.9 cm) (SPA mount)
Width:	16.1" (40.9 cm)
Height:	3.0" (7.6 cm) Main Body 7.2" (18.3 cm) Arm
Weight (max):	48.0 lbs (21.8 kg)

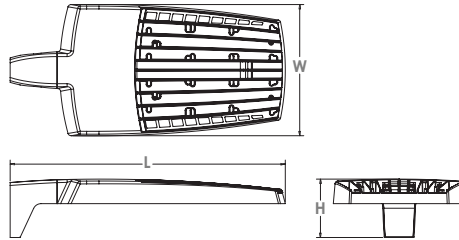

Introduction

The new RSX LED Area family delivers maximum value by providing significant energy savings, long life and outstanding photometric performance at an affordable price. The RSX3 delivers 25,000 to 41,000 lumens allowing it to replace 400W to 1000W HID luminaires.

The RSX features an integral universal mounting mechanism that allows the luminaire to be mounted on most existing drill hole patterns. This "no-drill" solution provides significant labor savings. An easy-access door on the bottom of mounting arm allows for wiring without opening the electrical compartment. A mast arm adaptor, adjustable integral slipfitter and other mounting configurations are available.

Ordering Information

EXAMPLE: RSX3 LED P4 40K R3 MVOLT SPA DBBXD

Series	Performance Package	Color Temperature	Distribution	Voltage	Mounting
RSX3 LED	P1 P2 P3 P4	30K 3000K 40K 4000K 50K 5000K	R2 Type 2 Wide R3 Type 3 Wide R3S Type 3 Short R4 Type 4 Wide R4S Type 4 Short R5 Type 5 Wide R5S Type 5 Short AFR Automotive Front Row AFRR90 Automotive Front Row Right Rotated AFRL90 Automotive Front Row Left Rotated	MVOLT (120V-277V) ¹ HVOLT (347V-480V) ² (use specific voltage for options as noted) 120 ³ 277 ³ 208 ³ 347 ³ 240 ³ 480 ³	SPA Square pole mounting (3.0" min. SQ pole for 1 at 90°, 3.5" min. SQ pole for 2, 3, 4 at 90°) RPA Round pole mounting (3.2" min. dia. RND pole for 2, 3, 4 at 90°, 3.0" min. dia. RND pole for 1 at 90°, 2 at 180°, 3 at 120°) MA Mast arm adaptor (fits 2-3/8" OD horizontal tenon) IS Adjustable slipfitter (fits 2-3/8" OD tenon) ⁴ WBA Wall bracket WBASC Wall bracket with surface conduit box AASP Adjustable tilt arm square pole mounting ⁴ AARP Adjustable tilt arm round pole mounting ⁴ AAWB Adjustable tilt arm with wall bracket ⁴ AAWSC Adjustable tilt arm wall bracket and surface conduit box ⁴

Options	Finish	
<p>Shipped Installed</p> <p>HS House-side shield⁵</p> <p>PE Photocontrol, button style^{6,7}</p> <p>PEX Photocontrol external threaded, adjustable^{7,8}</p> <p>PER7 Seven-wire twist-lock receptacle only (no controls)^{7,9,10,11}</p> <p>CE34 Conduit entry 3/4" NPT (Qty 2)</p> <p>SF Single fuse (120, 277, 347)³</p> <p>DF Double fuse (208, 240, 480)³</p> <p>SPD20KV 20KV Surge pack (10KV standard)</p> <p>FAO Field adjustable output^{7,11}</p> <p>DMG 0-10V dimming wires pulled outside fixture (for use with an external control, ordered separately)^{7,11}</p>	<p>Shipped Installed</p> <p>*Standalone and Networked Sensors/Controls (factory default settings, see table page 9)</p> <p>NLTAIR2 nLight AIR generation 2^{11,12,13}</p> <p>PIRHN Networked, Bi-Level motion/ambient sensor (for use with NLTAIR2)^{11,13,14}</p> <p>*Note: PIRHN with nLight Air can be used as a standalone or networked solution. Sensor coverage pattern is affected when luminaire is tilted.</p> <p>Shipped Separately (requires some field assembly)</p> <p>EGS External glare shield⁵</p> <p>EGFV External glare full visor (360° around light aperture)⁵</p> <p>BS Bird spikes¹⁵</p>	<p>DBBXD Dark Bronze</p> <p>DBLXD Black</p> <p>DNAXD Natural Aluminum</p> <p>DWHXD White</p> <p>DBTDXD Textured Dark Bronze</p> <p>DBL BXD Textured Black</p> <p>DNATXD Textured Natural Aluminum</p> <p>DWHGXD Textured White</p>



Ordering Information

Accessories

Ordered and shipped separately.

RSX3HS U	RSX3 House side shield (includes 3 shields)
RSX3HSAFRR U	RSX3 House side shields for AFR rotated optics (includes 3 shields)
RSX3EGS (FINISH) U	External glare shield (specify finish)
RSX3EGFV (FINISH) U	External glare full visor (specify finish)
RSXRPA (FINISH) U	RSX Universal round pole adaptor plate (specify finish)
RSXWBA (FINISH) U	RSX WBA wall bracket (specify finish)
RSXSBCB (FINISH) U	RSX Surface conduit box (specify finish, for use with WBA, WBA not included)
DLL127F 1.5 JU	Photocell -SSL twist-lock (120-277V) ¹⁶
DLL347F 1.5 CUL JU	Photocell -SSL twist-lock (347V) ¹⁶
DLL480F 1.5 CUL JU	Photocell -SSL twist-lock (480V) ¹⁶
DSHORT SBK U	Shorting cap ¹⁶

NOTES

- 1 MVOLT driver operates on any line voltage from 120-277V (50/60 Hz).
- 2 HVOLT driver operates on any line voltage from 347-480V (50/60 Hz).
- 3 Single fuse (SF) requires 120V, 277V or 347V. Double fuse (DF) requires 208V, 240V or 480V.
- 4 Maximum tilt is 90° above horizontal.
- 5 It may be ordered as an accessory.
- 6 Requires MVOLT or 347V.
- 7 Not available in combination with other light sensing control options (following options cannot be combined: PE, PEX, PER7, FAO, DMG, PIRHN).
- 8 Requires 120V, 208V, 240V, 277V or 347V.
- 9 Twistlock photocell ordered and shipped as a separate line item from Acuity Brands Controls. See accessories. Shorting Cap included. Dimming leads capped for future use.
- 10 For units with option PER7, the mounting must be restricted to +/- 45° from horizontal aim per ANSI C136.10-2010.
- 11 Two or more of the following options cannot be combined including DMG, PER7, FAO and PIRHN.
- 12 Must be ordered with PIRHN.
- 13 Requires MVOLT or HVOLT.
- 14 Must be ordered with NLTAIR2. For additional information on PIRHN visit [here](#).
- 15 Must be ordered with fixture for factory pre-drilling.
- 16 Requires luminaire to be specified with PER7 option. Ordered and shipped as a separate line item from Acuity Brands Controls.

External Shields

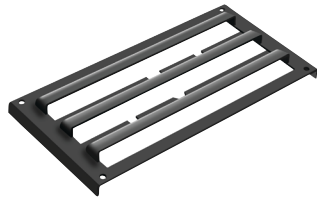

House Side Shield



External Glare Shield



External 360 Full Visor

Pole/Mounting Information

Accessories including bullhorns, cross arms and other adaptors are available under the accessories tab at Lithonia's Outdoor Poles and Arms product page. Click here to visit [Accessories](#).

HANDHOLE ORIENTATION

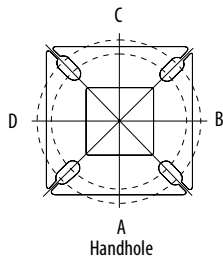

RSX POLE DRILLING

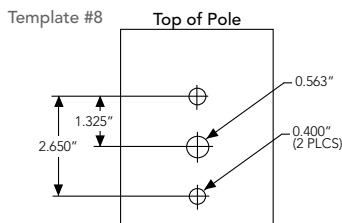

RSX STANDARD ARM & ADJUSTABLE ARM

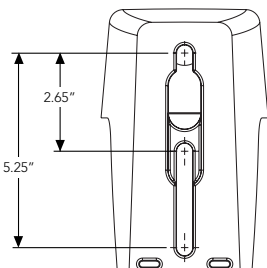

Round Tenon Mount - Pole Top Slipfitters

Tenon O.D.	RSX Mounting	Single	2 at 180°	2 at 90°	3 at 120°	3 at 90°	4 at 90°
2-3/8"	RPA, AARP	AS3-5 190	AS3-5 280	AS3-5 290	AS3-5 320	AS3-5 390	AS3-5 490
2-7/8"	RPA, AARP	AST25-190	AST25-280	AST25-290	AST25-320	AST25-390	AST25-490
4"	RPA, AARP	AST35-190	AST35-280	AST35-290	AST35-320	AST35-390	AST35-490

Drill/Side Location by Configuration Type

Drilling Template	Mounting Option	Single	2 @ 180	2 @ 90	3 @ 120	3 @ 90	4 @ 90
#8	Head Location	Side B	Side B & D	Side B & C	Round Pole Only	Side B, C & D	Side A, B, C & D
#8	Drill Nomenclature	DM19AS	DM28AS	DM29AS	DM32AS	DM39AS	DM49AS

RSX3 - Luminaire EPA

*Includes luminaire and integral mounting arm. Other tenons, arms, brackets or other accessories are not included in this EPA data.

Fixture Quantity & Mounting Configuration	Tilt	EPA (ft ²)								
		Single	2 @ 90	2 @ 180	3 @ 90	3 @ 120	4 @ 90	2 Side by Side	3 Side by Side	4 Side by Side
SPA - Square Pole Adaptor	0°	0.7	1.32	1.37	2	1.76	2.62	1.39	2.09	2.8
RPA - Round Pole Adaptor		0.75	1.37	1.47	2.1	1.86	2.72	1.44	2.19	2.9
MA - Mast Arm Adaptor		0.62	1.24	1.21	1.84	1.6	2.46	1.31	1.93	2.64
IS - Integral Slipfitter AARP/AASP - Adjustable Arm Square/Round Pole	0°	0.7	1.32	1.37	2	1.76	2.62	1.39	2.09	2.8
	10°	0.96	1.85	1.84	2.76	2.4	3.64	1.92	2.82	3.84
	20°	1.34	2.58	2.64	3.83	3.35	5.11	2.68	2.68	5.36
	30°	2.04	3.52	3.79	5.2	4.7	7.03	4.09	4.09	8.16
	40°	3.12	4.54	5.23	6.6	6.33	9.02	6.23	6.23	12.48
	45°	3.72	5.05	6.12	7.45	7.15	10.01	7.45	7.45	14.88
	50°	4.01	5.49	6.6	7.87	7.91	10.88	8.02	8.02	16.04
	60°	4.77	6.36	7.69	9.09	9.11	12.61	9.44	9.44	18.88
	70°	4.9	7.01	8.05	10.02	9.78	13.94	9.88	9.80	19.6
	80°	4.95	7.4	8.23	10.61	10.26	14.75	9.90	9.90	19.8
90°	4.91	7.55	8.34	10.88	10.54	15.05	9.82	9.82	19.64	



COMMERCIAL OUTDOOR

One Lithonia Way • Conyers, Georgia 30012 • Phone: 800.705.7378 • www.acuitybrands.com
© 2018-2019 Acuity Brands Lighting, Inc. All rights reserved.

Lithonia RSX3 Area LED
Rev. 09/17/19
Page 2 of 9

Photometric Diagrams

To see complete photometric reports or download .ies files for this product, visit Lithonia Lighting's [RSX Area homepage](#).

Isofootcandle plots for the RSX3 LED P4 40K. Distances are in units of mounting height (30').

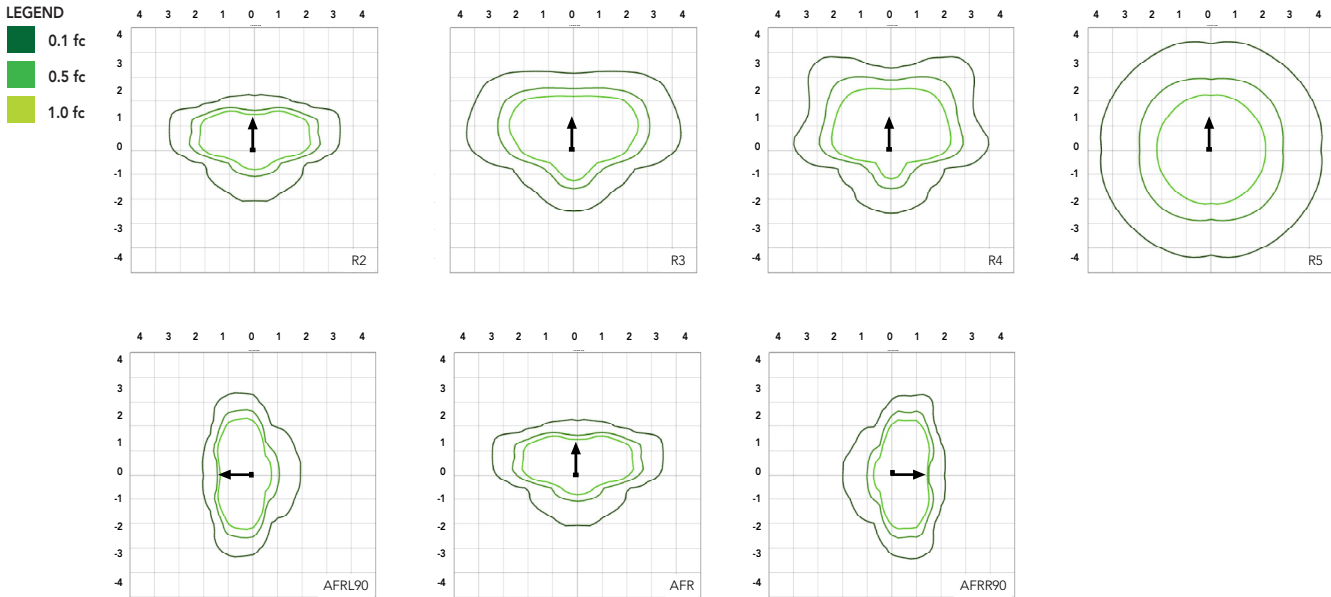

Performance Data

Lumen Ambient Temperature (LAT) Multipliers

Use these factors to determine relative lumen output for average ambient temperatures from 0-50°C (32-122°F).

Ambient	Ambient	Lumen Multiplier
0°C	32°F	1.05
5°C	41°F	1.04
10°C	50°F	1.03
15°C	59°F	1.02
20°C	68°F	1.01
25°C	77°F	1.00
30°C	86°F	0.99
35°C	95°F	0.98
40°C	104°F	0.97
45°C	113°F	0.96
50°C	122°F	0.95

Electrical Load

Performance Package	System Watts (W)	Current (A)					
		120V	208V	240V	277V	347V	480V
P1	194W	1.61	0.92	0.80	0.69	0.56	0.40
P2	222W	1.85	1.06	0.92	0.80	0.63	0.45
P3	266W	2.22	1.27	1.10	0.95	0.76	0.55
P4	312W	2.60	1.49	1.29	1.11	0.89	0.64

Projected LED Lumen Maintenance

Operating Hours	50,000	75,000	100,000
Lumen Maintenance Factor	>0.97	>0.95	>0.92

Values calculated according to IESNA TM-21-11 methodology and valid up to 40°C.

Lumen Output

Lumen values are from photometric tests performed in accordance with IESNA LM-79-08. Data is considered to be representative of the configurations shown, within the tolerances allowed by Lighting Facts. Contact factory for performance data on any configurations not shown here.

Performance Package	System Watts	Distribution Type	30K (3000K, 70 CRI)					40K (4000K, 70 CRI)					50K (5000K, 70 CRI)				
			Lumens	B	U	G	LPW	Lumens	B	U	G	LPW	Lumens	B	U	G	LPW
P1	194W	R2	24,920	3	0	2	128	27,379	3	0	2	141	27,379	3	0	2	141
		R3	24,832	3	0	4	128	27,283	3	0	4	141	27,283	3	0	4	141
		R3S	25,494	3	0	3	131	28,010	3	0	3	144	28,010	3	0	3	144
		R4	25,157	3	0	4	130	27,639	3	0	4	142	27,639	3	0	4	142
		R4S	24,272	3	0	3	125	26,667	3	0	3	137	26,667	3	0	3	137
		R5	25,494	5	0	4	131	28,010	5	0	4	144	28,010	5	0	4	144
		R5S	26,171	4	0	2	135	28,754	4	0	2	148	28,754	4	0	2	148
		AFR	24,886	3	0	2	128	27,342	3	0	2	141	27,342	3	0	2	141
		AFRR90	25,123	4	0	3	129	27,602	4	0	3	142	27,602	4	0	3	142
AFRL90	25,229	4	0	3	130	27,718	4	0	3	142	27,718	4	0	3	142		
P2	222W	R2	27,570	3	0	2	124	30,291	3	0	2	136	30,291	3	0	2	136
		R3	27,473	3	0	4	124	30,185	3	0	4	136	30,185	3	0	4	136
		R3S	28,206	3	0	3	127	30,990	3	0	4	139	30,990	3	0	4	139
		R4	27,833	3	0	4	125	30,579	3	0	4	138	30,579	3	0	4	138
		R4S	26,854	3	0	3	120	29,504	3	0	3	132	29,504	3	0	3	132
		R5	28,206	5	0	4	127	30,990	5	0	4	140	30,990	5	0	4	140
		R5S	28,955	4	0	2	130	31,813	5	0	3	143	31,813	5	0	3	143
		AFR	27,533	3	0	2	124	30,251	3	0	2	136	30,251	3	0	2	136
		AFRR90	27,795	4	0	3	125	30,538	5	0	3	137	30,538	5	0	3	137
AFRL90	27,912	4	0	3	125	30,667	5	0	3	138	30,667	5	0	3	138		
P3	266W	R2	32,285	3	0	3	121	35,471	3	0	3	133	35,471	3	0	3	133
		R3	32,172	3	0	4	121	35,346	3	0	5	133	35,346	3	0	5	133
		R3S	33,030	3	0	4	124	36,289	3	0	4	136	36,289	3	0	4	136
		R4	32,593	3	0	4	123	35,809	3	0	5	135	35,809	3	0	5	135
		R4S	31,446	3	0	4	118	34,550	3	0	4	129	34,550	3	0	4	129
		R5	33,030	5	0	4	124	36,289	5	0	4	136	36,289	5	0	4	136
		R5S	33,907	5	0	3	127	37,253	5	0	3	140	37,253	5	0	3	140
		AFR	32,242	3	0	3	121	35,424	3	0	3	133	35,424	3	0	3	133
		AFRR90	32,549	5	0	4	122	35,761	5	0	4	134	35,761	5	0	4	134
AFRL90	32,686	5	0	3	123	35,911	5	0	4	135	35,911	5	0	4	135		
P4	312W	R2	36,945	3	0	3	118	40,591	3	0	3	130	40,591	3	0	3	130
		R3	36,815	3	0	5	118	40,448	3	0	5	130	40,448	3	0	5	130
		R3S	37,797	3	0	4	121	41,527	3	0	4	133	41,527	3	0	4	133
		R4	37,297	3	0	5	120	40,978	3	0	5	131	40,978	3	0	5	131
		R4S	35,985	3	0	4	115	39,537	3	0	4	127	39,537	3	0	4	127
		R5	37,797	5	0	4	121	41,527	5	0	5	133	41,527	5	0	5	133
		R5S	38,801	5	0	3	124	42,630	5	0	3	137	42,630	5	0	3	137
		AFR	36,896	3	0	3	118	40,537	3	0	3	130	40,537	3	0	3	130
		AFRR90	37,247	5	0	4	119	40,923	5	0	4	131	40,923	5	0	4	131
AFRL90	37,403	5	0	4	120	41,095	5	0	4	132	41,095	5	0	4	132		

Dimensions

RSX3 with Round Pole Adapter (RPA)

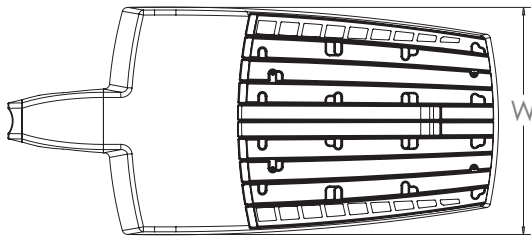

Length: 34.8" (88.4 cm)
 Width: 16.1" (40.9 cm)
 Height: 3.0" (7.6 cm) Main Body
 7.2" (18.3 cm) Arm

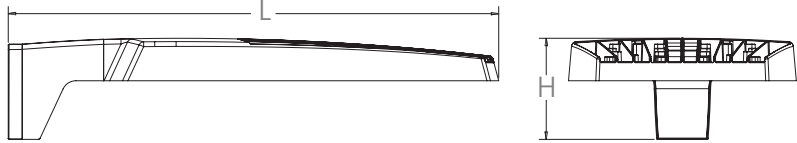

NOTE:
 RPA - Round Pole mount can also be used to mount on square poles by omitting the round pole adapter plate shown here.



RSX3 with Mast Arm Adapter (MA)

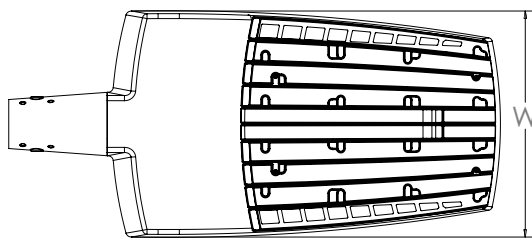

Length: 35.1" (89.1 cm)
 Width: 16.1" (40.9 cm)
 Height: 3.0" (7.6 cm) Main Body
 3.5" (8.9 cm) Arm

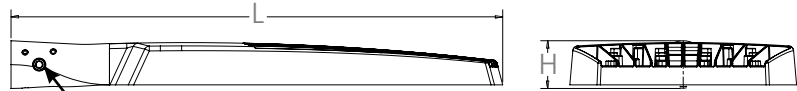

7/16" locking thru bolt/nut provided

~~RSX3 with Adjustable Slipfitter (IS)~~

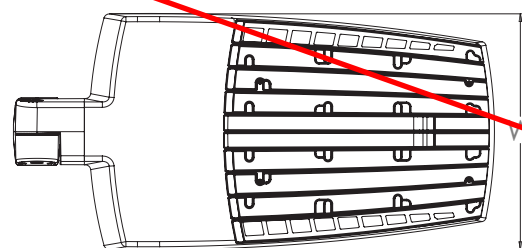

Length: 32.8" (83.3 cm)
 Width: 16.1" (40.9 cm)
 Height: 3.0" (7.6 cm) Main Body
 7.6" (19.3 cm) Arm

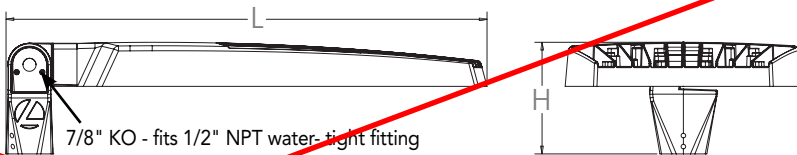

7/8" KO - fits 1/2" NPT water-tight fitting

Dimensions

RSX3 with Wall Bracket (WBA)

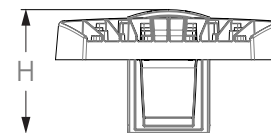
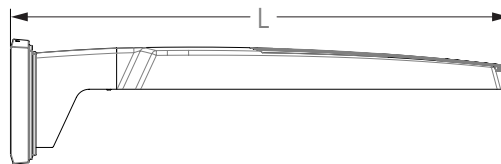
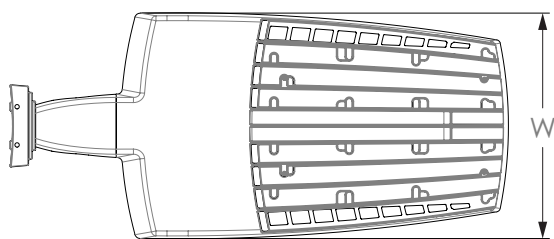

Length: 35.5" (90.2 cm)
 Width: 16.1" (40.9 cm)
 Height: 3.0" (7.6 cm) Main Body
 8.9" (22.6 cm) Arm

Wall Bracket (WBA) Mounting Detail

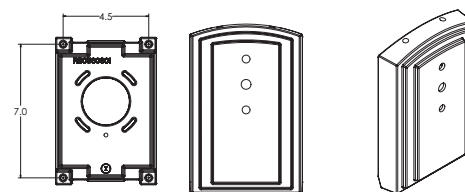

RSX3 with Wall Bracket with Surface Conduit Box (WBASC)

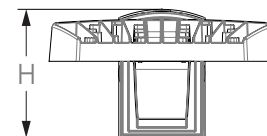
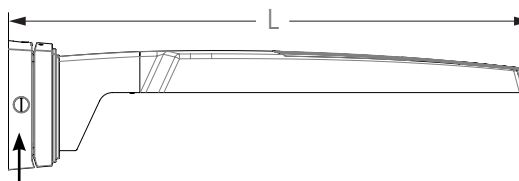
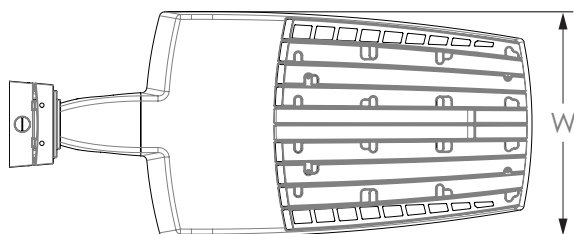

3/4" NPT taps with plugs - Qty (4) provided

Length: 37.4" (95.0 cm)
 Width: 16.1" (40.9 cm)
 Height: 3.0" (7.6 cm) Main Body
 9.2" (23.4 cm) Arm

Surface Conduit Box (SCB) Mounting Detail

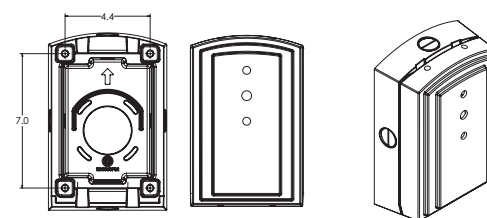

Dimensions

RSX3 with Adjustable Tilt Arm - Square or Round Pole (AASP or AARP)

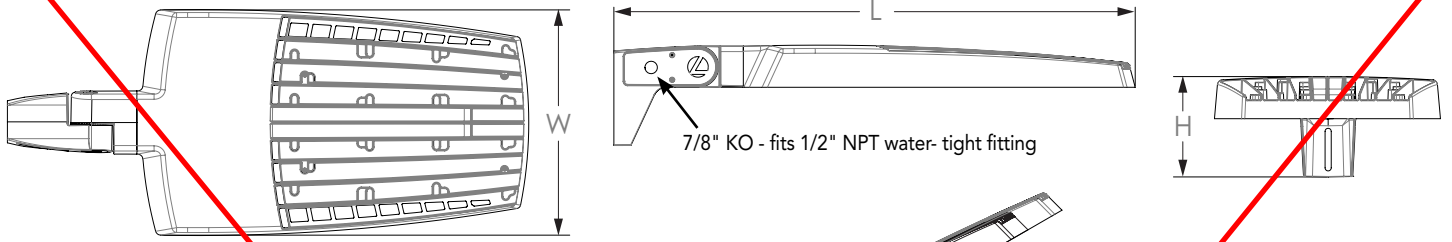

Length: 37.2" (94.5 cm) **AASP**
 38.2" (97.1 cm) **AARP**
 Width: 16.1" (40.9 cm)
 Height: 3.0" (7.6 cm) Main Body
 7.2" (18.2 cm) Arm

NOTE:
 RPA - Round Pole mount can also be used to mount on square poles by omitting the round pole adapter plate shown here.



Notes
 AASP: Requires 3.5" min. square pole for mounting 2, 3, 4 at 90°. Requires 3.0" min. square pole for 1 at 90°.
 AARP: Requires 3.2" min. dia. round pole for 2, 3, 4 at 90°. Requires 3.0" min. dia. round pole for mounting 1 at 90°, 2 at 180°, 3 at 120°.

RSX3 with Adjustable Tilt Arm with Wall Bracket (AAWB)

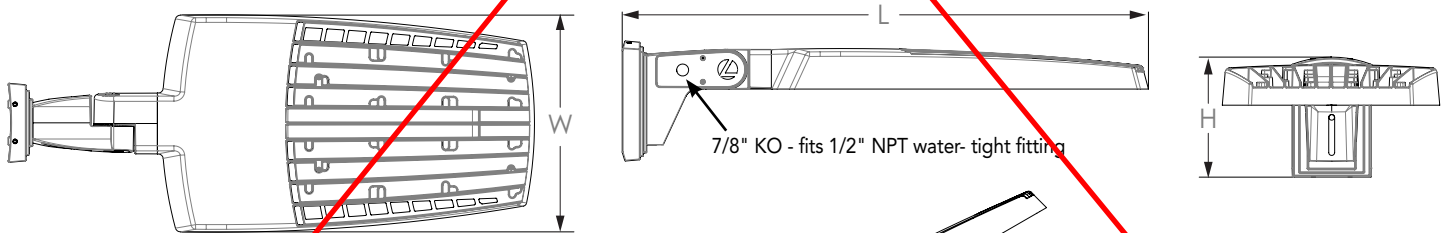

Length: 39.0" (99.1 cm)
 Width: 16.1" (40.9 cm)
 Height: 3.0" (7.6 cm) Main Body
 8.9" (22.6 cm) Arm

Wall Bracket (WBA) Mounting Detail

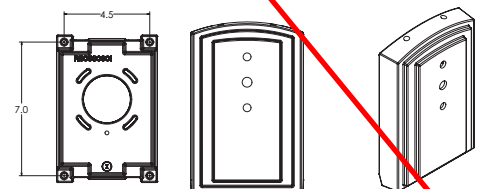

Dimensions

RSX3 with Adjustable Tilt Arm with Wall Bracket and Surface Conduit Box (AAWSC)

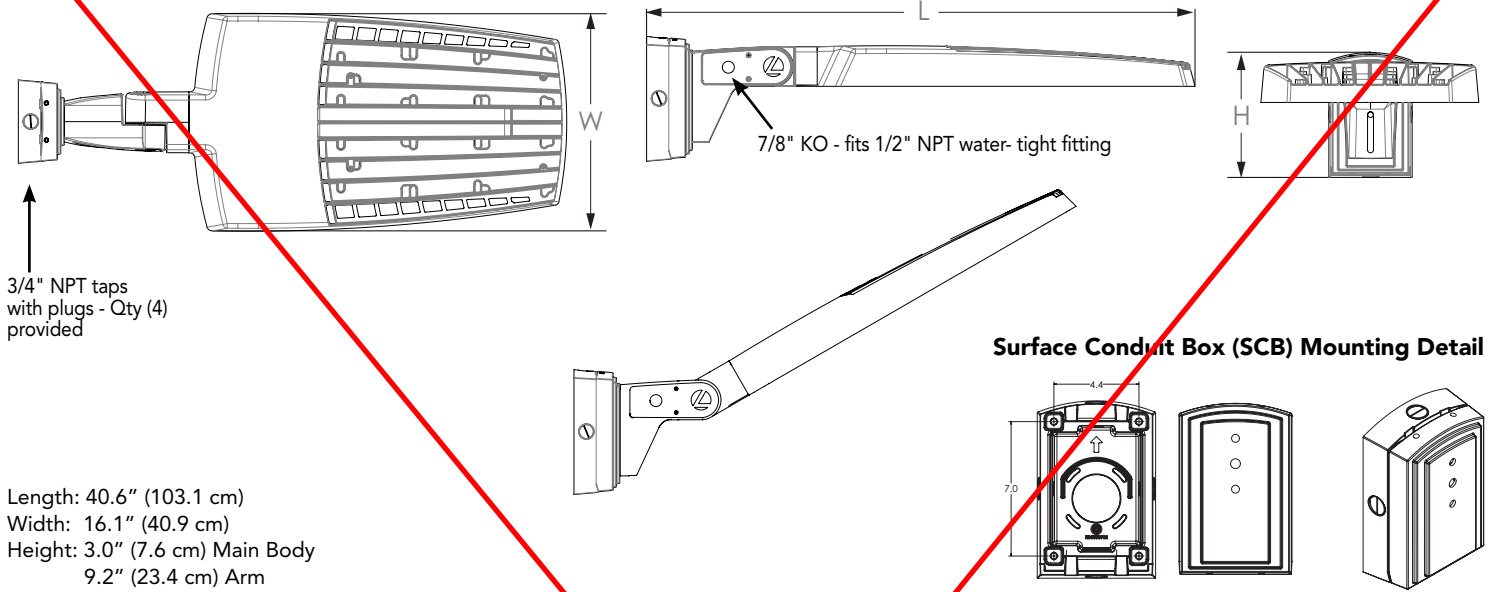

Additional Reference Drawings

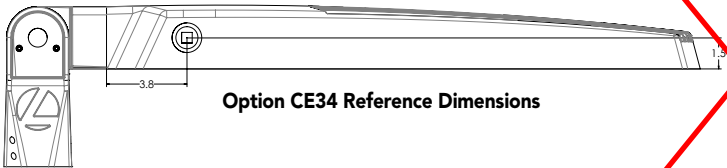

Automotive Front Row - Rotated Optics (AFRL90/R90)

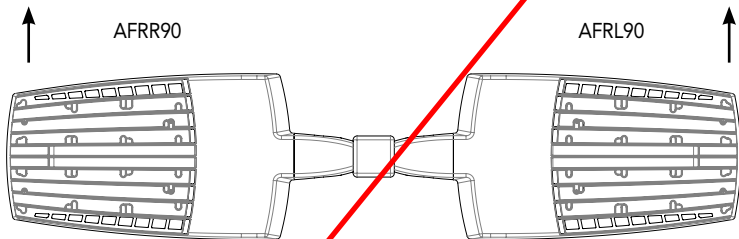

PIRHN nLight Sensor Coverage Pattern

nLight PIRHN

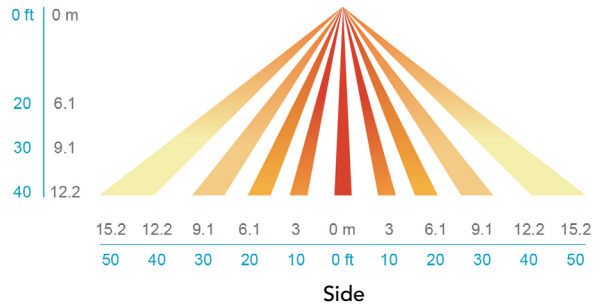
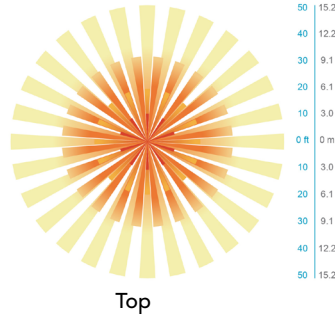
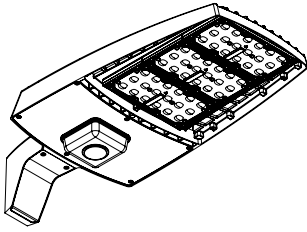

Motion Sensor Default Settings - Option PIRHN						
Option	Dimmed State (unoccupied)	High Level (when occupied)	Photocell Operation	Dwell Time (occupancy time delay)	Ramp-up Time (from unoccupied to occupied)	Ramp-down Time (from occupied to unoccupied)
PIRHN	Approx. 30% Output	100% Output	Enabled @ 1.5FC	7.5 minutes	3 seconds	5 minutes

*Note: PIRHN default settings including photocell set-point, high/low dim rates, and occupancy sensor time delay are all configurable using the Clarity Pro App.

FEATURES & SPECIFICATIONS

INTENDED USE

The RSX LED area family is designed to provide a long-lasting, energy-efficient solution for the one-for-one replacement of existing metal halide or high pressure sodium lighting. The RSX3 delivers 25,000 to 41,000 lumens and is ideal for replacing 400W to 1000W HID pole-mounted luminaires in parking lots and other area lighting applications.

CONSTRUCTION

The RSX LED area luminaire features a rugged die-cast aluminum main body that uses heat-dissipating fins and flow-through venting to provide optimal thermal management that both enhances LED performance and extends component life. Integral "no drill" mounting arm allows the luminaire to be mounted on existing pole drillings, greatly reducing installation labor. The light engines and housing are sealed against moisture and environmental contaminants to IP66. The low-profile design results in a low EPA, allowing pole optimization. Vibration rated per ANSI C136.31: 3G Mountings: SPA, RPA, MA, IS, AASP and AARP rated for 3G vibration. 1.5G Mountings: WBA, WBASC, AAWB and AAWSC rated for 1.5G vibration.

FINISH

Exterior parts are protected by a zinc-infused Super Durable TGIC thermoset powder coat finish that provides superior resistance to corrosion and weathering. A tightly controlled multi-stage process ensures superior adhesion as well as a minimum finish thickness of 3 mils. The result is a high-quality finish that is warranted not to crack or peel.

OPTICS

Precision acrylic refractive lenses are engineered for superior application efficiency, distributing the light to where it is needed most. Available in short and wide pattern distributions including Type 2, Type 3S, Type 4, Type 4S, Type 5, Type 5S, AFR (Automotive Front Row) and AFR rotated AFRR90 and ARFL90.

ELECTRICAL

Light engine(s) configurations consist of high-efficacy LEDs mounted on metal-core circuit boards and aluminum heat sinks to maximize heat dissipation. Light engines are IP66 rated. LED lumen maintenance is >L92/100,000 hours. CCT's of 3000K, 4000K and 5000K (minimum 70 CRI) are available. Class 1 electronic drivers ensure system power factor >90% and THD <20%. Easily serviceable 10kV surge protection device meets a minimum Category C Low operation (per ANSI/IEEE C62.41.2).

STANDARD CONTROLS

The RSX LED area luminaire has a wide assortment of control options. Dusk to dawn controls include MVOLT and 347V button-type photocells and NEMA twist-lock photocell receptacles.

nLIGHT AIR CONTROLS

The RSX LED area luminaire is also available with nLight® AIR for the ultimate in wireless control. This powerful controls platform provides out-of-the-box basic motion sensing with photocontrol functionality and is suitable for mounting heights up to 40 feet. No commissioning is required when using factory default settings that provide basic stand-alone motion occupancy dimming that is switched on and off with a built-in photocell. See chart above for motion sensor default out-of-box settings. For more advanced wireless functionality, such as group dimming, nLight AIR can be commissioned using a smartphone and the easy-to-use CLAIRITY app. nLight AIR equipped luminaires can be grouped, resulting in motion sensor and photocell group response without the need for additional equipment. Scheduled dimming with motion sensor over-ride can be achieved when used with the nLight Eclipse. Additional information about nLight Air can be found [here](#).

INSTALLATION

Integral "no-drill" mounting arm allows for fast, easy mounting using existing pole drillings. Select the "SPA" option for square poles and the "RPA" option to mount to round poles. Note that the RPA mount can also be used for mounting to square poles by omitting the RPA adapter plate. Select the "MA" option to attach the luminaire to a 2 3/8" horizontal mast arm or the "IS" option for an adjustable slipfitter that mounts on a 2 3/8" OD tenon. The adjustable slipfitter has an integral junction box offering easy installation. Can be tilted up to 90° above horizontal. Additional mountings are available including a wall bracket, adjustable tilt arm for direct-to-pole and wall and a surface conduit box for wall mount applications.

LISTINGS

CSA Certified to meet U.S. and Canadian standards. Suitable for wet locations. Rated for -40°C minimum ambient. DesignLights Consortium® (DLC) Premium qualified product and DLC qualified product. Not all versions of this product may be DLC Premium qualified or DLC qualified. Please check the DLC Qualified Products List at www.designlights.org/QPL to confirm which versions are qualified.

WARRANTY

5-year limited warranty. Complete warranty terms located at: www.acuitybrands.com/resources/terms-and-conditions

Note: Actual performance may differ as a result of end-user environment and application. All values are design or typical values, measured under laboratory conditions at 25 °C. Specifications subject to change without notice.