

Project		Catalog #		Type	
Prepared by		Notes		Date	



Lumark

Prevail LED

Area / Site Luminaire

Product Features



Interactive Menu

- Ordering Information [page 2](#)
- Mounting Details [page 3](#)
- Optical Configurations [page 4](#)
- Product Specifications [page 4](#)
- Energy and Performance Data [page 5](#)
- Control Options [page 6](#)

Product Certifications



Quick Facts

- Lumen packages range from 4,800 - 52,300 lumens (35W - 350W)
- Replaces 70W up to 1,000W HID equivalents
- Efficacies up to 160 lumens per watt
- Energy and maintenance savings up to 85% versus HID solutions
- Standard universal quick mount arm with universal drill pattern

Connected Systems

- WaveLinX

Dimensional Details

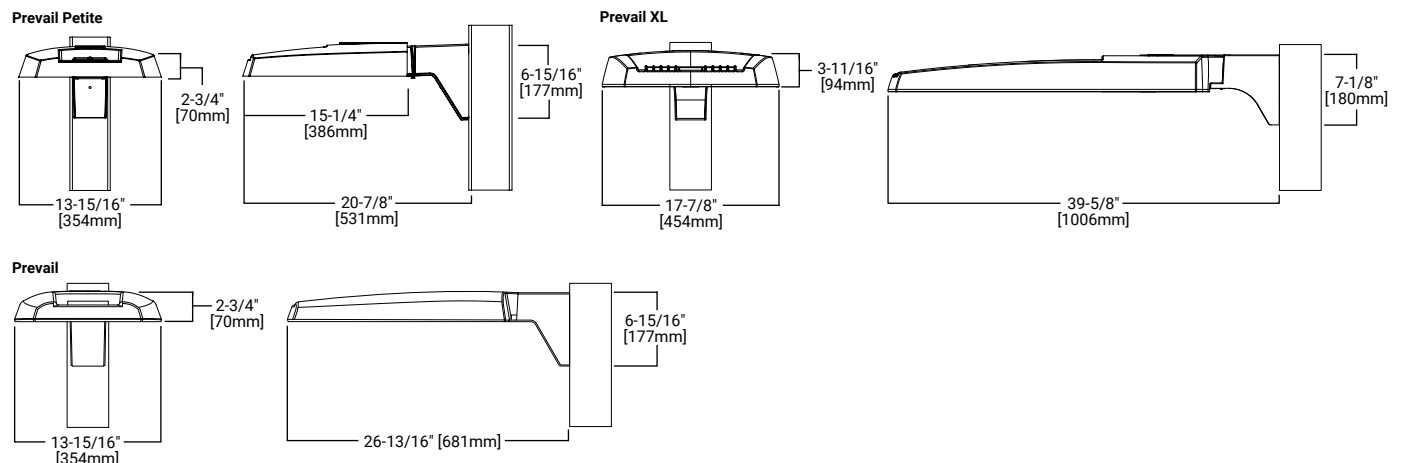

NOTES:
 1. Visit <https://www.designlights.org/search/> to confirm qualification. Not all product variations are DLC qualified.
 2. IDA Certified for 3000K CCT and warmer only.

Ordering Information

SAMPLE NUMBER: PRV-XL-C75-D-UNV-T4-SA-BZ

Product Family ^{1,2}	Light Engine ⁴	Driver	Voltage	Distribution	Mounting	Color
PRV-P =Prevail Petite BAA-PRV-P =Prevail Petite BAA Compliant ³ TAA-PRV-P =Prevail Petite TAA Compliant ³	C10 =(1 LED) 4,900 Nominal Lumens C15 =(1 LED) 6,900 Nominal Lumens C20 =(1 LED) 9,800 Nominal Lumens C25 =(1 LED) 11,800 Nominal Lumens	D =Dimming (0-10V)	UNV =Universal (120-277V) 347 =347V 480 =480V ⁵ DV =DuraVolt (277-480V) ^{5,6}	T2 =Type II T3 =Type III T4 =Type IV T5 =Type V	SA =Standard Versatile Arm MA =Mast Arm WM =Wall Mount Arm ADJA =Adjustable Arm - Pole Mount ADJS =Adjustable Arm - Slipfitter, 3in vertical tenon ADJA-WM =Adjustable Arm - Wall Mount	BZ =Bronze AP =Grey BK =Black DP =Dark Platinum GM =Graphite Metallic WH =White
PRV =Prevail BAA-PRV =Prevail BAA Compliant ³ TAA-PRV =Prevail TAA Compliant ³	C15 =(1 LED) 7,100 Nominal Lumens C25 =(2 LEDs) 13,100 Nominal Lumens C40 =(2 LEDs) 17,100 Nominal Lumens C60 =(2 LEDs) 20,000 Nominal Lumens					
PRV-XL =Prevail XL BAA-PRV-XL =Prevail XL BAA Compliant ³ TAA-PRV-XL =Prevail XL TAA Compliant ³	C75 =(4 LED) 26,100 Nominal Lumens C100 =(4 LED) 31,000 Nominal Lumens C125 =(4 LED) 36,000 Nominal Lumens C150 =(6 LED) 41,100 Nominal Lumens C175 =(6 LED) 48,600 Nominal Lumens					
Options (Add as Suffix)			Accessories (Order Separately) ^{20,21}			
7030 =70 CRI / 3000K CCT ⁷ 7050 =70 CRI / 5000K CCT ⁷ HSS =House Side Shield ⁸ L90 =Optics Rotated 90° Left R90 =Optics Rotated 90° Right 10K =10kV UL 1449 Fused Surge Protective Device 20MSP =20kV MOV Surge Protective Device 20K =Series 20kV UL 1449 Surge Protective Device HA =50°C High Ambient Temperature ⁹ CC =Coastal Construction ¹⁰ PER =NEMA 3-PIN Twistlock Photocontrol Receptacle ¹¹ PER7 =NEMA 7-PIN Twistlock Photocontrol R eceptacle ¹¹ MS/DIM-L08 =Dimming Motion and Daylight Sensor, IR Remote Programmable, < 8' Mounting ^{12,13} MS/DIM-L20 =Dimming Motion and Daylight Sensor, IR Remote Programmable, 8' - 20' Mounting ^{12,13} MS/DIM-L40 =Dimming Motion and Daylight Sensor, IR Remote Programmable, 21' - 40' Mounting ^{12,13}			SPB1 =Dimming Motion and Daylight Sensor, Bluetooth Programmable, < 8' Mounting ^{12,14} SPB2 =Dimming Motion and Daylight Sensor, Bluetooth Programmable, 8' - 20' Mounting ^{12,14} SPB4 =Dimming Motion and Daylight Sensor, Bluetooth Programmable, 21' - 40' Mounting ^{12,14} ZW =Wavelinx-enabled 4-PIN Twistlock Receptacle ¹² ZD =SR Driver-enabled 4-PIN Twistlock Receptacle ¹² ZW-SWPD4XX =WaveLinX, Dimming Motion and Daylight, WAC Programmable, 7' - 15' Mounting ^{12,15,16,17} ZW-SWPD5XX =WaveLinX, Dimming Motion and Daylight, WAC Programmable, 15' - 40' Mounting ^{12,15,16,17} ZD-SWPD4XX =WaveLinX, SR Driver, Dimming Motion and Daylight, WAC Programmable, 7' - 15' Mounting ^{12,15,16,17} ZD-SWPD5XX =WaveLinX, SR Driver, Dimming Motion and Daylight, WAC Programmable, 15' - 40' Mounting ^{12,15,16,17} (See Table Below) =LumenSafe Integrated Network Security Camera ^{16,19}			
NOTES: 1. DesignLights Consortium® Qualified. Refer to www.designlights.org Qualified Products List under Family Models for details. 2. Customer is responsible for engineering analysis to confirm pole and fixture compatibility for all applications. Refer to installation instructions IB500002EN and pole white paper WP513001EN for additional support information. 3. Only product configurations with these designated prefixes are built to be compliant with the Buy American Act of 1933 (BAA) or Trade Agreements Act of 1979 (TAA), respectively. Please refer to DOMESTIC PREFERENCES website for more information. Components shipped separately may be separately analyzed under domestic preference requirements. 4. Standard 4000K CCT and 70CRI. 5. 480V not to be used with ungrounded or impedance grounded systems. 6. DuraVolt drivers feature added protection from power quality issues such as loss of neutral, transients and voltage fluctuations. Visit www.signify.com/duravolt for more information. 7. Use dedicated IES files on product website for non-standard CCTs. 8. House Side Shield not suitable with T5 distribution. Not available with PRV-C60 lumen package. 9. Not available with PRV-C60 lumen package. Not available with PRV-P-C25 lumen package. 10. Salt spray tested to over 5,000-hours per ASTM B117 with a scribe rating of 9 per ASTM D1654. Also achieves 7,000-hour rating per ASTM B117 with a scribe rating of 4 per ASTM D1654. Extended lead times may apply. 11. If DuraVolt (DV) is specified, use a photocontrol that matches the input voltage used. 12. Controls system is not available in combination with a photocontrol receptacle (PER or PER7) or another controls system (MS, SPB, ZD, or ZW). Option not available with DuraVolt (DV) voltage option. 13. Utilizes the Wattstopper sensor FSP-211. Sensor color white unless specified otherwise via PDR. To field-configure, order FSIR-100 accessory separately. 14. Utilizes the Wattstopper sensor FSP-3XX series. Sensor color determined by product finish. See Sensor Color Reference Table. Field-configures via mobile application. See Controls section for details.			15. Sensor passive infrared (PIR) may be overly sensitive when operating below -20°C (-4°F). 16. For the device to be field-configurable, requires WAC Gateway components WAC-PoE and WPOE-120 in appropriate quantities. Only compatible with WaveLinX system and software and requires system components to be installed for operation. See website for more Wavelinx application information. 17. Replace XX with sensor color (WH, BZ, or BK). 18. Only available in PRV-XL configurations C75, C100, C125, C150, or C175. 19. Not available with 347V, 480V, DV, or HA options. Consult LumenSafe system product pages for additional details and compatibility information. 20. Replace XX with paint color. 21. For BAA or TAA requirements, Accessories sold separately will be separately analyzed under domestic preference requirements. Consult factory for further information. 22. Only for use with PRV and PRV-P. 23. Only for use with PRV. Not available for use with PRV-P or PRV-XL configurations. 24. Must order one per optic/LED when ordering as a field-installable accessory (1, 2, 4, or 6). 25. This tool enables adjustment to Motion Sensor (MS) parameters including high and low modes, sensitivity, time delay, cutoff and more. Consult your lighting representative for more information. 26. Requires 4-PIN twistlock receptacle (ZD or ZW) option. 27. Requires 7-PIN NEMA twistlock photocontrol receptacle (PER7) option. The WOLC-7 cannot be used in conjunction with other controls systems (MS, ZD, ZW or LWR). Operates on 120-347V input voltages.			

LumenSafe Integrated Network Security Camera Technology Options (Add as Suffix)

Product Family	Camera Type	Data Backhaul		
L =LumenSafe Technology 	H =Dome Camera, High Res Z =Dome Camera, Remote PTZ	C =Cellular, Customer Installed SIM Card A =Cellular, Factory Installed AT&T SIM Card	V =Cellular, Factory Installed Verizon SIM Card S =Cellular, Factory Installed Sprint SIM Card	E =Ethernet Networking

Stock Ordering Information

Product Family ¹	Light Engine	Voltage	Distribution
PRVS =Prevail	C15 =(1 LED) 7,100 Nominal Lumens C25 =(2 LEDs) 13,100 Nominal Lumens C40 =(2 LEDs) 17,100 Nominal Lumens C60 =(2 LEDs) 20,000 Nominal Lumens	UNV =Universal (120-277V) 347 =347V ²	T3 =Type III T4 =Type IV
PRVS-XL =Prevail XL	C75 =(4 LED) 26,100 Nominal Lumens C100 =(4 LED) 31,000 Nominal Lumens C125 =(4 LED) 36,000 Nominal Lumens C150 =(6 LED) 41,100 Nominal Lumens C175 =(6 LED) 48,600 Nominal Lumens		
NOTES: 1. All stock configurations are standard 4000K/70CRI, bronze finish, and include the standard versatile mounting arm. 2. Only available in PRVS configurations C15, C25, C40 or C60.			

Mounting Details

Pole Mount Arm (PRV & PRV-P)

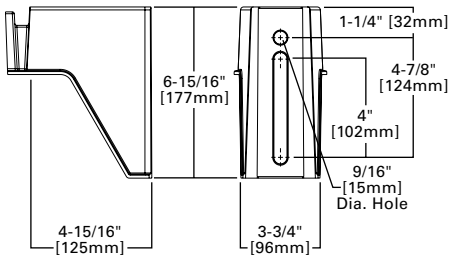

Pole Mount Arm (PRV-XL)

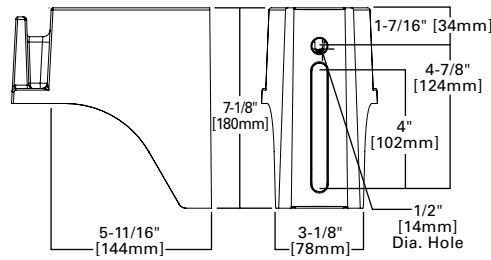

Versatile Mount System

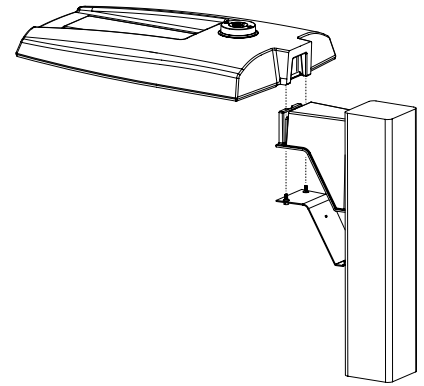

Wall Mount (PRV & PRV-P)

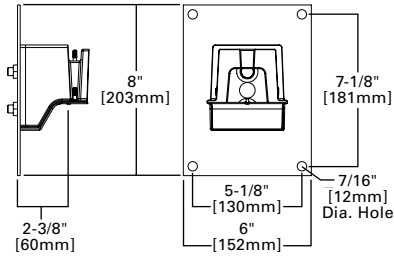

Wall Mount (PRV-XL)

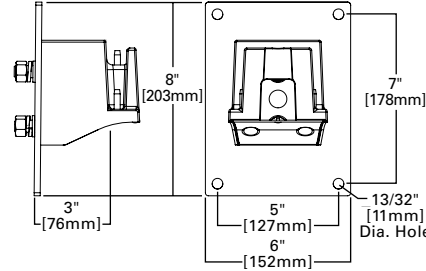

Mast Arm Mount (PRV & PRV-P)

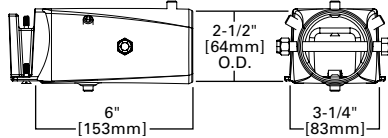

Mast Arm Mount (PRV-XL)

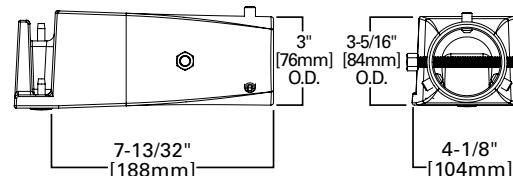

Adjustable Pole Mount Arm (PRV & PRV-P)

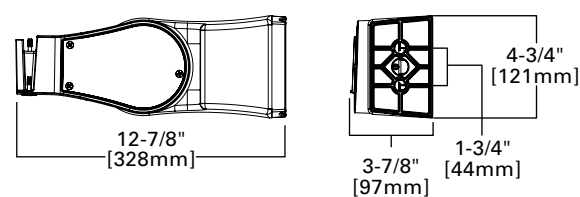

Adjustable Pole Mount Arm (PRV-XL)

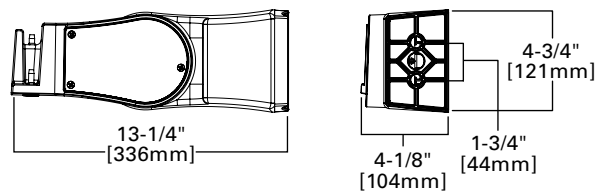

Adjustable Wall Mount (PRV & PRV-P)

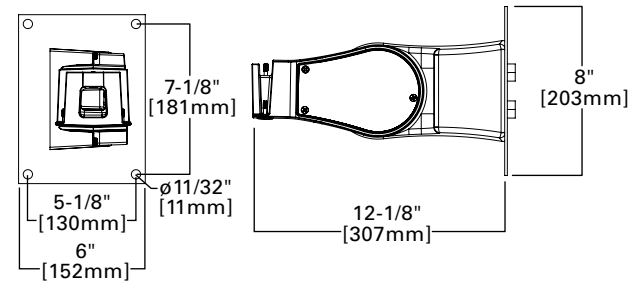

Adjustable Wall Mount (PRV-XL)

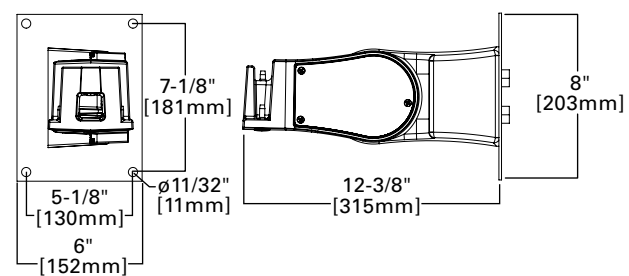

Adjustable Slipfitter (PRV & PRV-P)

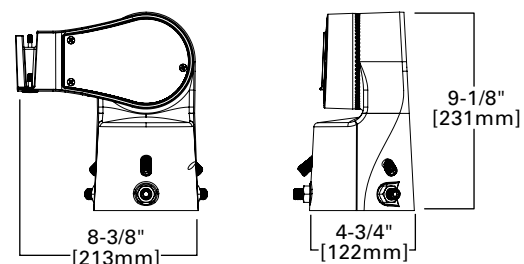

Adjustable Slipfitter (PRV-XL)

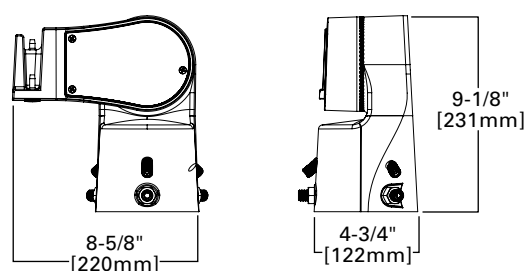

Mounting Details

Mounting Configurations and EPAs

NOTE: For 2 PRV's mounted at 90°, requires minimum 3" square or 4" round pole for fixture clearance. For 2 PRV-XL's mounted at 90°, requires minimum 4" square or round pole for fixture clearance. Customer is responsible for engineering analysis to confirm pole and fixture compatibility for applications.

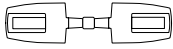
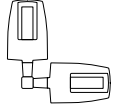
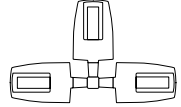
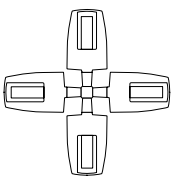
						
Housing Size	Tilt Angle (Degrees)	Arm Mount Single	Arm Mount 2 @ 180°	Arm Mount 2 @ 90°	Arm Mount 3 @ 90°	Arm Mount 4 @ 90°
Prevail Petite	0°	0.54	1.08	0.84	1.38	1.38
	60°	1.68	1.85	2.42	3.15	3.30
Prevail	0°	0.92	1.35	1.42	1.63	1.63
	60°	2.20	2.40	3.05	3.88	4.07
	60° + Full Drop Visor	2.20	2.40	3.25	4.28	4.47
Prevail XL	0°	1.12	2.25	2.13	2.52	2.52
	60°	3.99	4.30	5.26	6.51	6.79
	60° + Full Drop Visor	3.99	4.30	5.59	7.17	7.49

Optical Configurations

PRV-P-C10/C15/C20/C25
(4,900/6,900/9,800/11,800 Nominal Lumens)

PRV-C15
(7,100 Nominal Lumens)

PRV-C25/C40/C60
(13,100/17,100/20,000 Nominal Lumens)

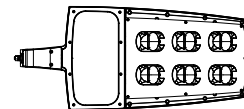
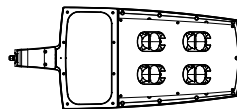
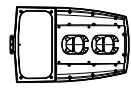
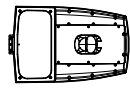

PRV-XL-C75/C100/C125
(26,100/31,000/36,300 Nominal Lumens)

PRV-XL-C150/C175
(41,100/48,600 Nominal Lumens)

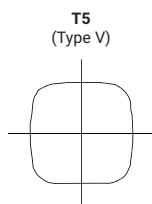
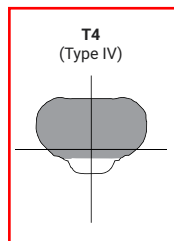
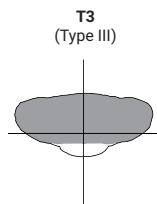
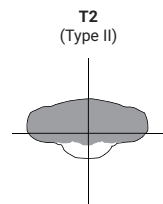

Optical Distributions



 = Distribution with House Side Shield (HSS)
 = Optical Distribution

Product Specifications

Construction

- Single-piece die-cast aluminum housing
- Tethered die-cast aluminum door

Optics

- Dark Sky Approved (3000K CCT and warmer only)
- Precision molded polycarbonate optics

Electrical

- -40°C minimum operating temperature
- 40°C maximum operating temperature
- >.9 power factor
- <20% total harmonic distortion
- Class 1 electronic drivers have expected life of 100,000 hours with <1% failure rate
- 0-10V dimming driver is standard with leads external to the fixture
- Standard MOV surge protective device designed to withstand 10kV of transient line surge

Mounting

- Versatile, patented, standard mount arm accommodates multiple drill patterns ranging from 1-1/2" to 4-7/8" (Type M drilling recommended for new installations)
- A knock-out on the standard mounting arm enables round pole mounting
- Adjustable pole and wall mount arms adjust in 5° increments from 0° to 60°; Downward facing orientation only (Type N drilling required for ADJA mount)
- Adjustable slipfitter arm adjusts in 5° increments from -5° to 85°; Downward facing orientation only
- Adjustable Arms: 1.5G vibration rated
- Prevail and Prevail Petite: 3G vibration rated
- Prevail XL Mast Arm: 3G vibration rated
- Prevail XL Standard Arm: 1.5G vibration rated

Typical Applications

- Parking lots, Walkways, Roadways and Building Areas

Finish

- Five-stage super TGIC polyester powder coat paint, 2.5 mil nominal thickness
- Finish is compliant to 3,000 hour salt spray standard (per ASTM B117)

Shipping Data

- Prevail Petite: 18 lbs. (7.94 kgs.)
- Prevail: 20 lbs. (9.09 kgs.)
- Prevail XL: 45 lbs. (20.41 kgs.)

Warranty

- Five year limited warranty, consult website for details. www.cooperlighting.com/legal

Energy and Performance Data

[View PRV-P IES files](#)
[View PRV IES files](#)
[View PRV-XL IES files](#)

Power and Lumens

Product Family	Prevail Petite				Prevail				Prevail XL					
Light Engine	C10	C15	C20	C25	C15	C25	C40	C60	C75	C100	C125	C150	C175	
Power (Watts)	35	49	73	94	52	96	131	153	176	217	264	285	346	
Input Current @ 120V (A)	0.29	0.41	0.61	0.79	0.43	0.80	1.09	1.32	1.50	1.84	2.21	2.38	2.92	
Input Current @ 277V (A)	0.13	0.18	0.27	0.35	0.19	0.35	0.48	0.57	0.66	0.82	0.97	1.04	1.25	
Input Current @ 347V (A)	0.11	0.16	0.23	0.29	0.17	0.30	0.41	0.48	0.54	0.66	0.79	0.84	1.02	
Input Current @ 480V (A)	0.08	0.12	0.17	0.22	0.12	0.22	0.30	0.35	0.40	0.48	0.57	0.62	0.74	
Distribution ¹														
Type II	4000K Lumens	4,775	6,717	9,542	11,521	7,123	13,205	17,172	20,083	26,263	31,231	36,503	41,349	48,876
	BUG Rating	B1-U0-G1	B1-U0-G1	B2-U0-G2	B2-U0-G2	B2-U0-G2	B2-U0-G2	B3-U0-G3	B3-U0-G3	B3-U0-G3	B3-U0-G4	B4-U0-G4	B4-U0-G4	B4-U0-G5
	Lumens per Watt	138	137	131	122	137	138	131	131	149	144	138	145	141
	3000K Lumens ¹	4,869	6,595	9,369	11,312	6,994	12,965	16,860	19,718	25,786	30,664	35,840	40,598	47,989
Type III	4000K Lumens	4,782	6,727	9,556	11,538	7,111	13,183	17,144	20,050	26,120	31,061	36,304	41,124	48,610
	BUG Rating	B1-U0-G2	B1-U0-G2	B2-U0-G3	B2-U0-G3	B1-U0-G2	B2-U0-G3	B3-U0-G4	B3-U0-G4	B3-U0-G5	B3-U0-G5	B3-U0-G5	B4-U0-G5	B4-U0-G5
	Lumens per Watt	138	137	131	123	137	137	131	131	148	143	138	144	140
	3000K Lumens ¹	4,695	6,605	9,383	11,329	6,982	12,944	16,832	19,686	25,646	30,497	35,645	40,377	47,727
Type IV	4000K Lumens	4,880	6,865	9,752	11,774	7,088	13,140	17,087	19,984	26,098	31,035	36,274	41,089	48,569
	BUG Rating	B1-U0-G2	B1-U0-G2	B2-U0-G3	B2-U0-G3	B1-U0-G3	B2-U0-G4	B2-U0-G4	B3-U0-G5	B3-U0-G5	B3-U0-G5	B3-U0-G5	B3-U0-G5	B4-U0-G5
	Lumens per Watt	141	140	134	125	136	137	130	131	148	143	137	144	140
	3000K Lumens ¹	4,792	6,740	9,575	11,561	6,959	12,901	16,777	19,621	25,624	30,471	35,615	40,343	47,687
Type V	4000K Lumens	5,067	7,128	10,126	12,226	7,576	14,045	18,264	21,360	28,129	33,450	39,097	44,287	52,349
	BUG Rating	B3-U0-G2	B3-U0-G2	B4-U0-G3	B4-U0-G3	B3-U0-G3	B4-U0-G3	B4-U0-G4	B5-U0-G4	B5-U0-G5	B5-U0-G5	B5-U0-G5	B5-U0-G5	B5-U0-G5
	Lumens per Watt	146	145	139	130	146	146	139	140	160	154	148	155	151
	3000K Lumens ¹	4,975	6,999	9,942	12,004	7,438	13,790	17,932	20,972	27,618	32,843	38,387	43,483	51,398

NOTES:
 1. For 3000K, 5000K or HSS data, refer to published IES files.

Lumen Maintenance

Configuration	TM-21 Lumen Maintenance (50,000 Hours)	Theoretical L70 (Hours)
Prevail and Prevail Petite at 25°C	91.30%	> 194,000
Prevail and Prevail Petite at 40°C	87.59%	> 134,000
Prevail XL at 25°C	91.40%	> 204,000
Prevail XL at 40°C	89.41%	> 158,000

Sensor Color Reference Table (SPBx)

Housing Finish	Sensor Color
AP=Grey	Grey
BZ=Bronze	Bronze
BK=Black	Black
DP=Dark Platinum	Grey
GM=Graphite Metallic	Black
WH=White	White

Lumen Multiplier

Ambient Temperature	Lumen Multiplier
10°C	1.02
15°C	1.01
25°C	1.00
40°C	0.99

Control Options

0-10V This fixture provides 0-10V dimming wire leads for use with a lighting control panel or other control method.

Photocontrol (PER and PER7) Photocontrol receptacles provide a flexible solution to enable “dusk-to-dawn” lighting by sensing light levels. Advanced control systems compatible with NEMA 7-PIN standards can be utilized with the PER7 receptacle.

Dimming Occupancy Sensor (SPB, MS/DIM-LXX and MS-LXX) These sensors are factory installed in the luminaire housing. When the SPB or MS/DIM sensor options are selected, the luminaire will dim down after five minutes of no activity detected. When activity is detected, the luminaire returns to full light output. When a sensor for ON/OFF operation (MS-LXX) is selected, the luminaire will turn off after five minutes of no activity. These occupancy sensors include an integral photocell for “dusk-to-dawn” control or “daylight harvesting.” Factory default is enabled for the MS sensors and disabled for the SPB. SPB motion sensors require the Sensor Configuration mobile application by Wattstopper to change factory default dimming level, time delay, sensitivity and other parameters. Available for iOS and Android devices. The SPB sensor is factory preset to dim down to approximately 10% power with a time delay of five minutes.

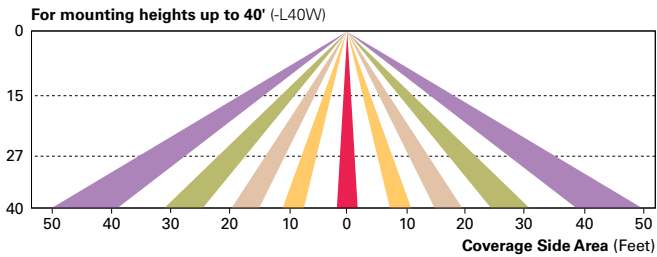
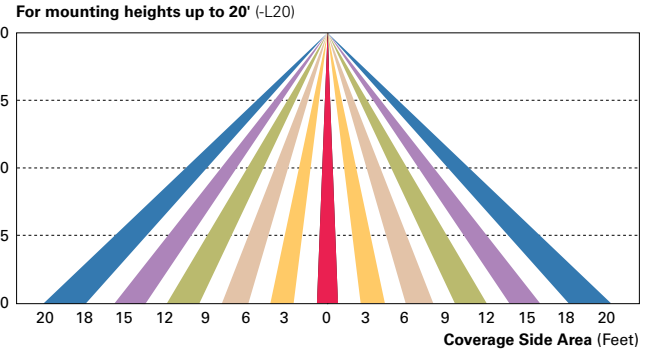
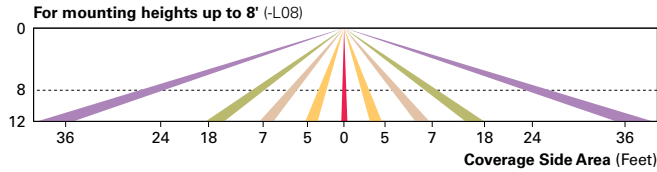

WaveLinx Wireless Control and Monitoring System Available in 7-PIN or 4-PIN configurations, the WaveLinx Outdoor control platform operates on a wireless mesh network based on IEEE 802.15.4 standards enabling wireless control of outdoor lighting. At least one Wireless Area Controller (WAC) is required for full functionality and remote communication (including adjustment of any factory pre-sets).

WaveLinx Outdoor Control Module (WOLC-7P-10A) A photocontrol that enables astronomic or time-based schedules to provide ON, OFF and dimming control of fixtures utilizing a 7-PIN receptacle. The out-of-box functionality is ON at dusk and OFF at dawn.

WaveLinx Wireless Sensor (SWPD4 and SWPD5) These outdoor sensors offer passive infrared (PIR) occupancy sensing and a photocell for closed-loop daylight sensing. These sensors can be factory installed or field-installed via simple, tool-less integration into luminaires equipped with the Zhaga Book 18 compliant 4-PIN receptacle (ZD or ZW). These sensors are factory preset to dim down to approximately 50 percent power after 15 minutes of no activity detected, and the photocell for “dusk-to-dawn” control is default enabled. A variety of sensor lenses are available to optimize the coverage pattern for mounting heights from 7'-40'.

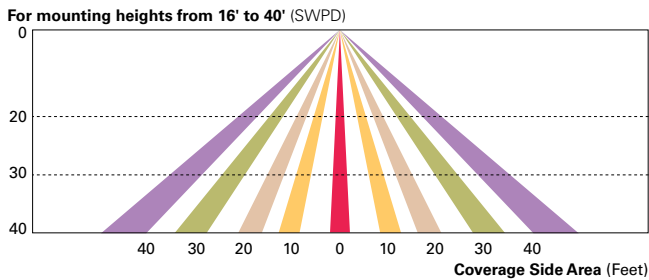

LumenSafe (LD) The LumenSafe integrated network camera is a streamlined, outdoor-ready camera that provides high definition video surveillance. This IP camera solution is optimally designed to integrate into virtually any video management system or security software platform of choice. No additional wiring is needed beyond providing line power to the luminaire. LumenSafe features factory-installed power and networking gear in a variety of networking options allowing security integrators to design the optimal solution for active surveillance.

Project		Catalog #		Type	
Prepared by		Notes		Date	



Lumark

Prevail LED

Area / Site Luminaire

Product Features



Interactive Menu

- Ordering Information [page 2](#)
- Mounting Details [page 3](#)
- Optical Configurations [page 4](#)
- Product Specifications [page 4](#)
- Energy and Performance Data [page 5](#)
- Control Options [page 6](#)

Product Certifications



Quick Facts

- Lumen packages range from 4,800 - 52,300 lumens (35W - 350W)
- Replaces 70W up to 1,000W HID equivalents
- Efficacies up to 160 lumens per watt
- Energy and maintenance savings up to 85% versus HID solutions
- Standard universal quick mount arm with universal drill pattern

Connected Systems

- WaveLinX

Dimensional Details

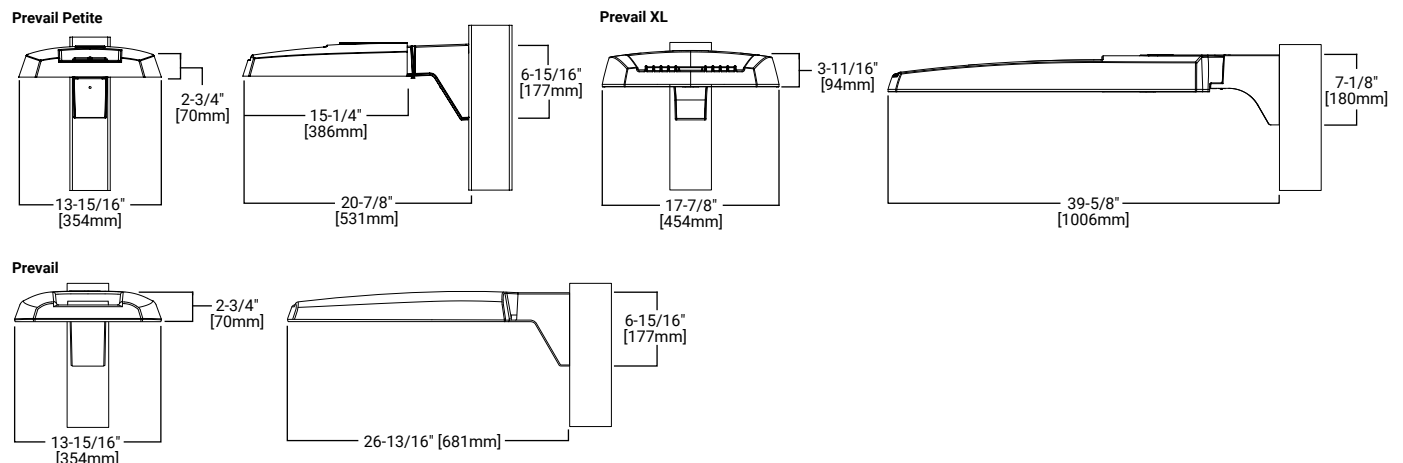

NOTES:
 1. Visit <https://www.designlights.org/search/> to confirm qualification. Not all product variations are DLC qualified.
 2. IDA Certified for 3000K CCT and warmer only.

Ordering Information

SAMPLE NUMBER: PRV-XL-C75-D-UNV-T4-SA-BZ

Product Family ^{1,2}	Light Engine ⁴	Driver	Voltage	Distribution	Mounting	Color
PRV-P =Prevail Petite BAA-PRV-P =Prevail Petite BAA Compliant ³ TAA-PRV-P =Prevail Petite TAA Compliant ³	C10 =(1 LED) 4,900 Nominal Lumens C15 =(1 LED) 6,900 Nominal Lumens C20 =(1 LED) 9,800 Nominal Lumens C25 =(1 LED) 11,800 Nominal Lumens	D =Dimming (0-10V)	UNV =Universal (120-277V) 347 =347V 480 =480V ⁵ DV =DuraVolt (277-480V) ^{5,6}	T2 =Type II T3 =Type III T4 =Type IV T5 =Type V	SA =Standard Versatile Arm MA =Mast Arm WM =Wall Mount Arm ADJA =Adjustable Arm - Pole Mount ADJS =Adjustable Arm - Slipfitter, 3in vertical tenon ADJA-WM =Adjustable Arm - Wall Mount	BZ =Bronze AP =Grey BK =Black DP =Dark Platinum GM =Graphite Metallic WH =White
PRV =Prevail BAA-PRV =Prevail BAA Compliant ³ TAA-PRV =Prevail TAA Compliant ³	C15 =(1 LED) 7,100 Nominal Lumens C25 =(2 LEDs) 13,100 Nominal Lumens C40 =(2 LEDs) 17,100 Nominal Lumens C60 =(2 LEDs) 20,000 Nominal Lumens					
PRV-XL =Prevail XL BAA-PRV-XL =Prevail XL BAA Compliant ³ TAA-PRV-XL =Prevail XL TAA Compliant ³	C75 =(4 LED) 26,100 Nominal Lumens C100 =(4 LED) 31,000 Nominal Lumens C125 =(4 LED) 36,000 Nominal Lumens C150 =(6 LED) 41,100 Nominal Lumens C175 =(6 LED) 48,600 Nominal Lumens					
Options (Add as Suffix)			Accessories (Order Separately) ^{20,21}			
7030 =70 CRI / 3000K CCT ⁷ 7050 =70 CRI / 5000K CCT ⁷ HSS =House Side Shield ⁸ L90 =Optics Rotated 90° Left R90 =Optics Rotated 90° Right 10K =10kV UL 1449 Fused Surge Protective Device 20MSP =20kV MOV Surge Protective Device 20K =Series 20kV UL 1449 Surge Protective Device HA =50°C High Ambient Temperature ⁹ CC =Coastal Construction ¹⁰ PER =NEMA 3-PIN Twistlock Photocontrol Receptacle ¹¹ PER7 =NEMA 7-PIN Twistlock Photocontrol Receptacle ¹¹ MS/DIM-L08 =Dimming Motion and Daylight Sensor, IR Remote Programmable, < 8' Mounting ^{12,13} MS/DIM-L20 =Dimming Motion and Daylight Sensor, IR Remote Programmable, 8' - 20' Mounting ^{12,13} MS/DIM-L40 =Dimming Motion and Daylight Sensor, IR Remote Programmable, 21' - 40' Mounting ^{12,13}			SPB1 =Dimming Motion and Daylight Sensor, Bluetooth Programmable, < 8' Mounting ^{12,14} SPB2 =Dimming Motion and Daylight Sensor, Bluetooth Programmable, 8' - 20' Mounting ^{12,14} SPB4 =Dimming Motion and Daylight Sensor, Bluetooth Programmable, 21' - 40' Mounting ^{12,14} ZW =Wavelinx-enabled 4-PIN Twistlock Receptacle ¹² ZD =SR Driver-enabled 4-PIN Twistlock Receptacle ¹² ZW-SWPD4XX =WaveLinX, Dimming Motion and Daylight, WAC Programmable, 7' - 15' Mounting ^{12,15,16,17} ZW-SWPD5XX =WaveLinX, Dimming Motion and Daylight, WAC Programmable, 15' - 40' Mounting ^{12,15,16,17} ZD-SWPD4XX =WaveLinX, SR Driver, Dimming Motion and Daylight, WAC Programmable, 7' - 15' Mounting ^{12,15,16,17} ZD-SWPD5XX =WaveLinX, SR Driver, Dimming Motion and Daylight, WAC Programmable, 15' - 40' Mounting ^{12,15,16,17} (See Table Below) =LumenSafe Integrated Network Security Camera ^{14,19}			
NOTES: 1. DesignLights Consortium® Qualified. Refer to www.designlights.org Qualified Products List under Family Models for details. 2. Customer is responsible for engineering analysis to confirm pole and fixture compatibility for all applications. Refer to installation instructions IB500002EN and pole white paper WP513001EN for additional support information. 3. Only product configurations with these designated prefixes are built to be compliant with the Buy American Act of 1933 (BAA) or Trade Agreements Act of 1979 (TAA), respectively. Please refer to DOMESTIC.PREFERENCES website for more information. Components shipped separately may be separately analyzed under domestic preference requirements. 4. Standard 4000K CCT and 70CRI. 5. 480V not to be used with ungrounded or impedance grounded systems. 6. DuraVolt drivers feature added protection from power quality issues such as loss of neutral, transients and voltage fluctuations. Visit www.signify.com/duravolt for more information. 7. Use dedicated IES files on product website for non-standard CCTs. 8. House Side Shield not suitable with T5 distribution. Not available with PRV-C60 lumen package. 9. Not available with PRV-C60 lumen package. Not available with PRV-P-C25 lumen package. 10. Salt spray tested to over 5,000-hours per ASTM B117 with a scribe rating of 9 per ASTM D1654. Also achieves 7,000-hour rating per ASTM B117 with a scribe rating of 4 per ASTM D1654. Extended lead times may apply. 11. If DuraVolt (DV) is specified, use a photocontrol that matches the input voltage used. 12. Controls system is not available in combination with a photocontrol receptacle (PER or PER7) or another controls system (MS, SPB, ZD, or ZW). Option not available with DuraVolt (DV) voltage option. 13. Utilizes the Wattstopper sensor FSP-211. Sensor color white unless specified otherwise via PDR. To field-configure, order FSIR-100 accessory separately. 14. Utilizes the Wattstopper sensor FSP-3XX series. Sensor color determined by product finish. See Sensor Color Reference Table. Field-configures via mobile application. See Controls section for details.			PRVSA-XX =Standard Arm Mounting Kit ²² PRVMA-XX =Mast Arm Mounting Kit ²² PRVWM-XX =Wall Mount Kit ²² PRV-ADJA-XX =Adjustable Arm - Pole Mount Kit ²² PRV-ADJS-XX =Adjustable Arm - Slipfitter Kit ²² PRV-ADJA-WM-XX =Adjustable Arm - Wall Mount Kit ²² PRVXLSA-XX =Standard Arm Mounting Kit ¹⁸ PRVXLMA-XX =Mast Arm Mounting Kit ¹⁸ PRVXLWM-XX =Wall Mount Kit ¹⁸ PRV-XL-ADJA-XX =Adjustable Arm - Pole Mount Kit ¹⁸ PRV-XL-ADJS-XX =Adjustable Arm - Slipfitter Kit ¹⁸ PRV-XL-ADJA-WM-XX =Adjustable Arm - Wall Mount Kit ¹⁸ MA1010-XX =Single Tenon Adapter for 3-1/2" O.D. Tenon MA1011-XX =2@180° Tenon Adapter for 3-1/2" O.D. Tenon MA1017-XX =Single Tenon Adapter for 2-3/8" O.D. Tenon MA1018-XX =2@180° Tenon Adapter for 2-3/8" O.D. Tenon SRA238 =Tenon Adapter from 2-3/8" to 3" PRV/COB-FDV =Full Drop Visor ²³ PRVXL/COB-FDV =Full Drop Visor ¹⁸ HS/VERD =House Side Shield ²⁴ VGS-F/B =Vertical Glare Shield, Front/Back ²⁴ VGS-SIDE =Vertical Glare Shield, Side ²⁴ OA/RA1013 =Photocontrol Shorting Cap OA/RA1014 =NEMA Photocontrol - 120V OA/RA1016 =NEMA Photocontrol - Multi-Tap 105-285V OA/RA1201 =NEMA Photocontrol - 347V OA/RA1027 =NEMA Photocontrol - 480V FSIR-100 =Wireless Configuration Tool for Occupancy Sensor ²⁵ SWPD4-XX =WaveLinX Sensor, Dimming Motion and Daylight, WAC Programmable, 7' - 15' Mounting ^{15,16,17,26} SWPD5-XX =WaveLinX Sensor, Dimming Motion and Daylight, WAC Programmable, 15' - 40' Mounting ^{15,16,17,26} WOLC-7P-10A =WaveLinX Outdoor Control Module (7-PIN) ²⁷			

LumenSafe Integrated Network Security Camera Technology Options (Add as Suffix)

Product Family	Camera Type	Data Backhaul		
L =LumenSafe Technology 	H =Dome Camera, High Res Z =Dome Camera, Remote PTZ	C =Cellular, Customer Installed SIM Card A =Cellular, Factory Installed AT&T SIM Card	V =Cellular, Factory Installed Verizon SIM Card S =Cellular, Factory Installed Sprint SIM Card	E =Ethernet Networking

Stock Ordering Information

Product Family ¹	Light Engine	Voltage	Distribution
PRVS =Prevail	C15 =(1 LED) 7,100 Nominal Lumens C25 =(2 LEDs) 13,100 Nominal Lumens C40 =(2 LEDs) 17,100 Nominal Lumens C60 =(2 LEDs) 20,000 Nominal Lumens	UNV =Universal (120-277V) 347 =347V ²	T3 =Type III T4 =Type IV
PRVS-XL =Prevail XL	C75 =(4 LED) 26,100 Nominal Lumens C100 =(4 LED) 31,000 Nominal Lumens C125 =(4 LED) 36,000 Nominal Lumens C150 =(6 LED) 41,100 Nominal Lumens C175 =(6 LED) 48,600 Nominal Lumens		
NOTES: 1. All stock configurations are standard 4000K/70CRI, bronze finish, and include the standard versatile mounting arm. 2. Only available in PRVS configurations C15, C25, C40 or C60.			

Mounting Details

Pole Mount Arm (PRV & PRV-P)

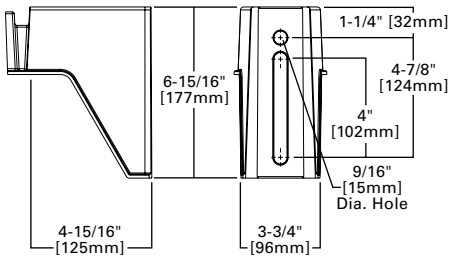

Pole Mount Arm (PRV-XL)

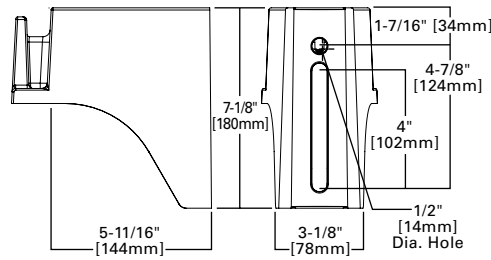

Versatile Mount System

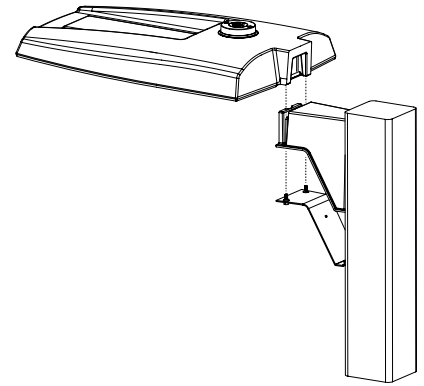

Wall Mount (PRV & PRV-P)

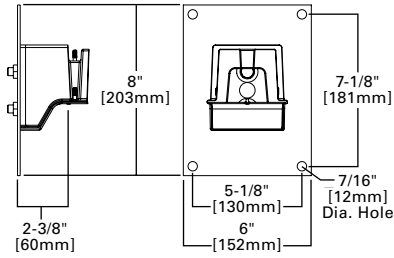

Wall Mount (PRV-XL)

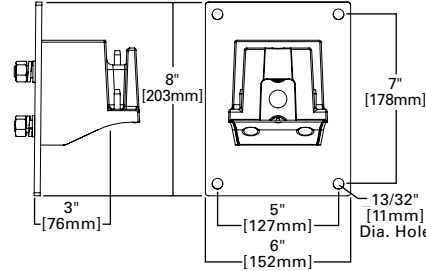

Mast Arm Mount (PRV & PRV-P)

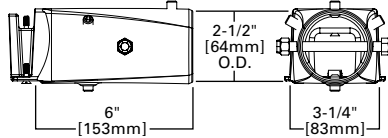

Mast Arm Mount (PRV-XL)

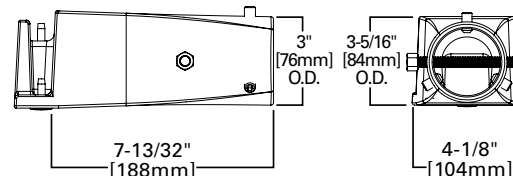

Adjustable Pole Mount Arm (PRV & PRV-P)

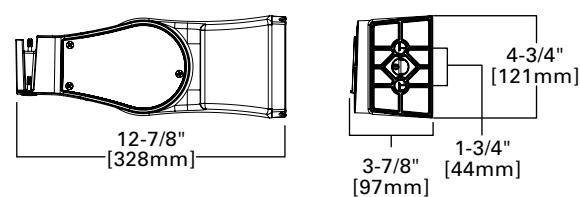

Adjustable Pole Mount Arm (PRV-XL)

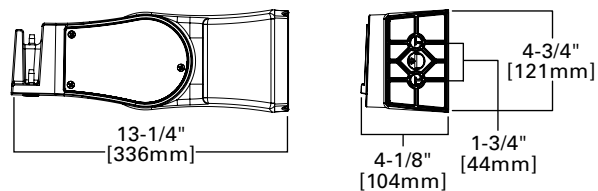

Adjustable Wall Mount (PRV & PRV-P)

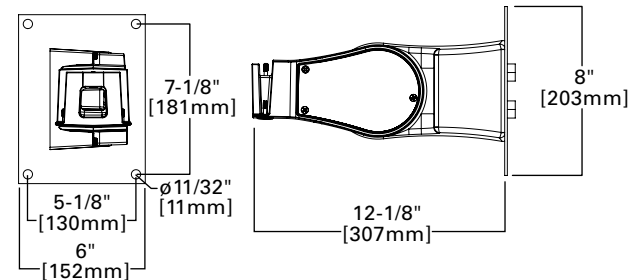

Adjustable Wall Mount (PRV-XL)

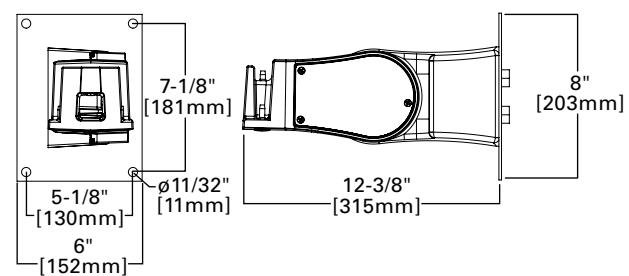

Adjustable Slipfitter (PRV & PRV-P)

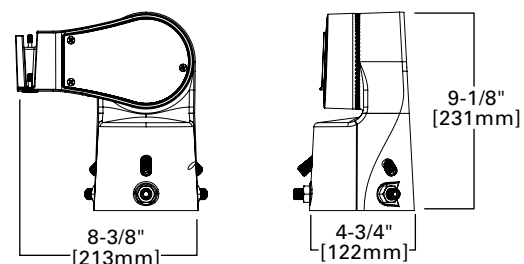

Adjustable Slipfitter (PRV-XL)

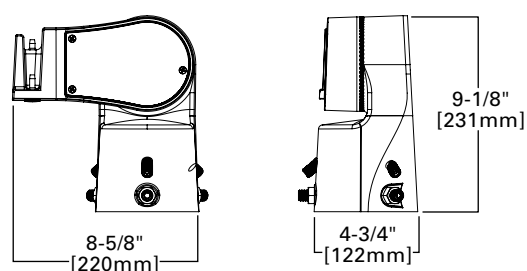

Mounting Details

Mounting Configurations and EPAs

NOTE: For 2 PRV's mounted at 90°, requires minimum 3" square or 4" round pole for fixture clearance. For 2 PRV-XL's mounted at 90°, requires minimum 4" square or round pole for fixture clearance. Customer is responsible for engineering analysis to confirm pole and fixture compatibility for applications.

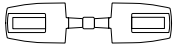
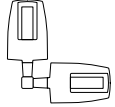
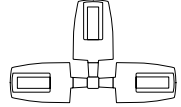
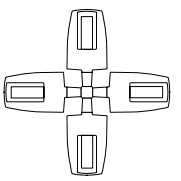
						
Housing Size	Tilt Angle (Degrees)	Arm Mount Single	Arm Mount 2 @ 180°	Arm Mount 2 @ 90°	Arm Mount 3 @ 90°	Arm Mount 4 @ 90°
Prevail Petite	0°	0.54	1.08	0.84	1.38	1.38
	60°	1.68	1.85	2.42	3.15	3.30
Prevail	0°	0.92	1.35	1.42	1.63	1.63
	60°	2.20	2.40	3.05	3.88	4.07
	60° + Full Drop Visor	2.20	2.40	3.25	4.28	4.47
Prevail XL	0°	1.12	2.25	2.13	2.52	2.52
	60°	3.99	4.30	5.26	6.51	6.79
	60° + Full Drop Visor	3.99	4.30	5.59	7.17	7.49

Optical Configurations

PRV-P-C10/C15/C20/C25
(4,900/6,900/9,800/11,800 Nominal Lumens)

PRV-C15
(7,100 Nominal Lumens)

PRV-C25/C40/C60
(13,100/17,100/20,000 Nominal Lumens)

PRV-XL-C75/C100/C125
(26,100/31,000/36,300 Nominal Lumens)

PRV-XL-C150/C175
(41,100/48,600 Nominal Lumens)

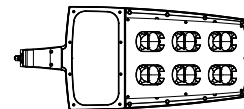
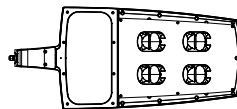
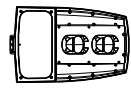
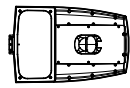

Optical Distributions

T2
(Type II)

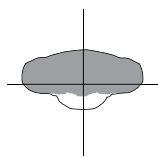

T3
(Type III)

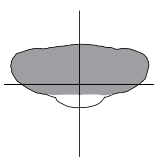

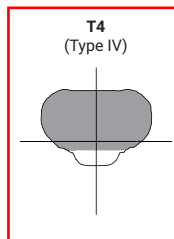

T4
(Type IV)

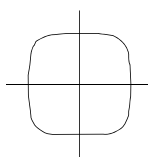

T5
(Type V)



 = Distribution with House Side Shield (HSS)
 = Optical Distribution

Product Specifications

Construction

- Single-piece die-cast aluminum housing
- Tethered die-cast aluminum door

Optics

- Dark Sky Approved (3000K CCT and warmer only)
- Precision molded polycarbonate optics

Electrical

- -40°C minimum operating temperature
- 40°C maximum operating temperature
- >.9 power factor
- <20% total harmonic distortion
- Class 1 electronic drivers have expected life of 100,000 hours with <1% failure rate
- 0-10V dimming driver is standard with leads external to the fixture
- Standard MOV surge protective device designed to withstand 10kV of transient line surge

Mounting

- Versatile, patented, standard mount arm accommodates multiple drill patterns ranging from 1-1/2" to 4-7/8" (Type M drilling recommended for new installations)
- A knock-out on the standard mounting arm enables round pole mounting
- Adjustable pole and wall mount arms adjust in 5° increments from 0° to 60°; Downward facing orientation only (Type N drilling required for ADJA mount)
- Adjustable slipfitter arm adjusts in 5° increments from -5° to 85°; Downward facing orientation only
- Adjustable Arms: 1.5G vibration rated
- Prevail and Prevail Petite: 3G vibration rated
- Prevail XL Mast Arm: 3G vibration rated
- Prevail XL Standard Arm: 1.5G vibration rated

Typical Applications

- Parking lots, Walkways, Roadways and Building Areas

Finish

- Five-stage super TGIC polyester powder coat paint, 2.5 mil nominal thickness
- Finish is compliant to 3,000 hour salt spray standard (per ASTM B117)

Shipping Data

- Prevail Petite: 18 lbs. (7.94 kgs.)
- Prevail: 20 lbs. (9.09 kgs.)
- Prevail XL: 45 lbs. (20.41 kgs.)

Warranty

- Five year limited warranty, consult website for details. www.cooperlighting.com/legal

Energy and Performance Data

[View PRV-P IES files](#)
[View PRV IES files](#)
[View PRV-XL IES files](#)

Power and Lumens

Product Family	Prevail Petite				Prevail				Prevail XL					
Light Engine	C10	C15	C20	C25	C15	C25	C40	C60	C75	C100	C125	C150	C175	
Power (Watts)	35	49	73	94	52	96	131	153	176	217	264	285	346	
Input Current @ 120V (A)	0.29	0.41	0.61	0.79	0.43	0.80	1.09	1.32	1.50	1.84	2.21	2.38	2.92	
Input Current @ 277V (A)	0.13	0.18	0.27	0.35	0.19	0.35	0.48	0.57	0.66	0.82	0.97	1.04	1.25	
Input Current @ 347V (A)	0.11	0.16	0.23	0.29	0.17	0.30	0.41	0.48	0.54	0.66	0.79	0.84	1.02	
Input Current @ 480V (A)	0.08	0.12	0.17	0.22	0.12	0.22	0.30	0.35	0.40	0.48	0.57	0.62	0.74	
Distribution ¹														
Type II	4000K Lumens	4,775	6,717	9,542	11,521	7,123	13,205	17,172	20,083	26,263	31,231	36,503	41,349	48,876
	BUG Rating	B1-U0-G1	B1-U0-G1	B2-U0-G2	B2-U0-G2	B2-U0-G2	B2-U0-G2	B3-U0-G3	B3-U0-G3	B3-U0-G3	B3-U0-G4	B4-U0-G4	B4-U0-G4	B4-U0-G5
	Lumens per Watt	138	137	131	122	137	138	131	131	149	144	138	145	141
	3000K Lumens ¹	4,869	6,595	9,369	11,312	6,994	12,965	16,860	19,718	25,786	30,664	35,840	40,598	47,989
Type III	4000K Lumens	4,782	6,727	9,556	11,538	7,111	13,183	17,144	20,050	26,120	31,061	36,304	41,124	48,610
	BUG Rating	B1-U0-G2	B1-U0-G2	B2-U0-G3	B2-U0-G3	B1-U0-G2	B2-U0-G3	B3-U0-G4	B3-U0-G4	B3-U0-G5	B3-U0-G5	B3-U0-G5	B4-U0-G5	B4-U0-G5
	Lumens per Watt	138	137	131	123	137	137	131	131	148	143	138	144	140
	3000K Lumens ¹	4,695	6,605	9,383	11,329	6,982	12,944	16,832	19,686	25,646	30,497	35,645	40,377	47,727
Type IV	4000K Lumens	4,880	6,865	9,752	11,774	7,088	13,140	17,087	19,984	26,098	31,035	36,274	41,089	48,569
	BUG Rating	B1-U0-G2	B1-U0-G2	B2-U0-G3	B2-U0-G3	B1-U0-G3	B2-U0-G4	B2-U0-G4	B3-U0-G5	B3-U0-G5	B3-U0-G5	B3-U0-G5	B3-U0-G5	B4-U0-G5
	Lumens per Watt	141	140	134	125	136	137	130	131	148	143	137	144	140
	3000K Lumens ¹	4,792	6,740	9,575	11,561	6,959	12,901	16,777	19,621	25,624	30,471	35,615	40,343	47,687
Type V	4000K Lumens	5,067	7,128	10,126	12,226	7,576	14,045	18,264	21,360	28,129	33,450	39,097	44,287	52,349
	BUG Rating	B3-U0-G2	B3-U0-G2	B4-U0-G3	B4-U0-G3	B3-U0-G3	B4-U0-G3	B4-U0-G4	B5-U0-G4	B5-U0-G5	B5-U0-G5	B5-U0-G5	B5-U0-G5	B5-U0-G5
	Lumens per Watt	146	145	139	130	146	146	139	140	160	154	148	155	151
	3000K Lumens ¹	4,975	6,999	9,942	12,004	7,438	13,790	17,932	20,972	27,618	32,843	38,387	43,483	51,398

NOTES:
1. For 3000K, 5000K or HSS data, refer to published IES files.

Lumen Maintenance

Configuration	TM-21 Lumen Maintenance (50,000 Hours)	Theoretical L70 (Hours)
Prevail and Prevail Petite at 25°C	91.30%	> 194,000
Prevail and Prevail Petite at 40°C	87.59%	> 134,000
Prevail XL at 25°C	91.40%	> 204,000
Prevail XL at 40°C	89.41%	> 158,000

Sensor Color Reference Table (SPBx)

Housing Finish	Sensor Color
AP =Grey	Grey
BZ =Bronze	Bronze
BK =Black	Black
DP =Dark Platinum	Grey
GM =Graphite Metallic	Black
WH =White	White

Lumen Multiplier

Ambient Temperature	Lumen Multiplier
10°C	1.02
15°C	1.01
25°C	1.00
40°C	0.99

Control Options

0-10V This fixture provides 0-10V dimming wire leads for use with a lighting control panel or other control method.

Photocontrol (PER and PER7) Photocontrol receptacles provide a flexible solution to enable “dusk-to-dawn” lighting by sensing light levels. Advanced control systems compatible with NEMA 7-PIN standards can be utilized with the PER7 receptacle.

Dimming Occupancy Sensor (SPB, MS/DIM-LXX and MS-LXX) These sensors are factory installed in the luminaire housing. When the SPB or MS/DIM sensor options are selected, the luminaire will dim down after five minutes of no activity detected. When activity is detected, the luminaire returns to full light output. When a sensor for ON/OFF operation (MS-LXX) is selected, the luminaire will turn off after five minutes of no activity. These occupancy sensors include an integral photocell for “dusk-to-dawn” control or “daylight harvesting.” Factory default is enabled for the MS sensors and disabled for the SPB. SPB motion sensors require the Sensor Configuration mobile application by Wattstopper to change factory default dimming level, time delay, sensitivity and other parameters. Available for iOS and Android devices. The SPB sensor is factory preset to dim down to approximately 10% power with a time delay of five minutes.

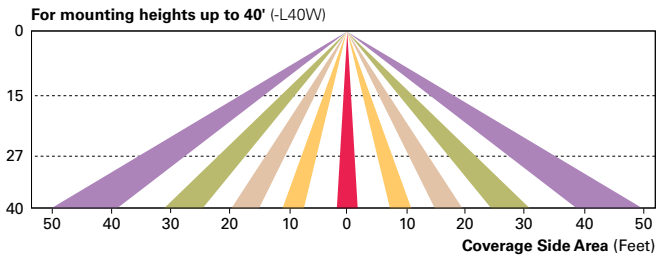
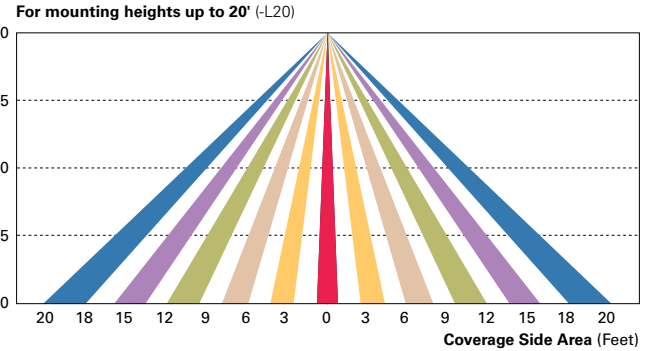
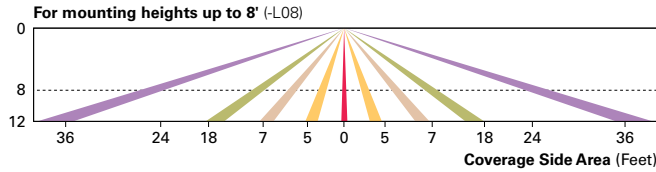

WaveLinx Wireless Control and Monitoring System Available in 7-PIN or 4-PIN configurations, the WaveLinx Outdoor control platform operates on a wireless mesh network based on IEEE 802.15.4 standards enabling wireless control of outdoor lighting. At least one Wireless Area Controller (WAC) is required for full functionality and remote communication (including adjustment of any factory pre-sets).

WaveLinx Outdoor Control Module (WOLC-7P-10A) A photocontrol that enables astronomic or time-based schedules to provide ON, OFF and dimming control of fixtures utilizing a 7-PIN receptacle. The out-of-box functionality is ON at dusk and OFF at dawn.

WaveLinx Wireless Sensor (SWPD4 and SWPD5) These outdoor sensors offer passive infrared (PIR) occupancy sensing and a photocell for closed-loop daylight sensing. These sensors can be factory installed or field-installed via simple, tool-less integration into luminaires equipped with the Zhaga Book 18 compliant 4-PIN receptacle (ZD or ZW). These sensors are factory preset to dim down to approximately 50 percent power after 15 minutes of no activity detected, and the photocell for “dusk-to-dawn” control is default enabled. A variety of sensor lenses are available to optimize the coverage pattern for mounting heights from 7'-40'.

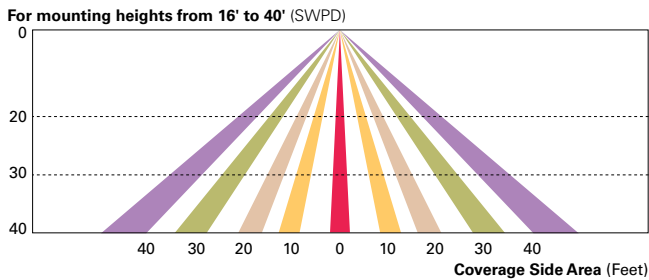

LumenSafe (LD) The LumenSafe integrated network camera is a streamlined, outdoor-ready camera that provides high definition video surveillance. This IP camera solution is optimally designed to integrate into virtually any video management system or security software platform of choice. No additional wiring is needed beyond providing line power to the luminaire. LumenSafe features factory-installed power and networking gear in a variety of networking options allowing security integrators to design the optimal solution for active surveillance.

Project		Catalog #		Type	
Prepared by		Notes		Date	



Lumark

Prevail LED

Area / Site Luminaire

Product Features



Interactive Menu

- Ordering Information [page 2](#)
- Mounting Details [page 3](#)
- Optical Configurations [page 4](#)
- Product Specifications [page 4](#)
- Energy and Performance Data [page 5](#)
- Control Options [page 6](#)

Product Certifications



Quick Facts

- Lumen packages range from 4,800 - 52,300 lumens (35W - 350W)
- Replaces 70W up to 1,000W HID equivalents
- Efficacies up to 160 lumens per watt
- Energy and maintenance savings up to 85% versus HID solutions
- Standard universal quick mount arm with universal drill pattern

Connected Systems

- WaveLinX

Dimensional Details

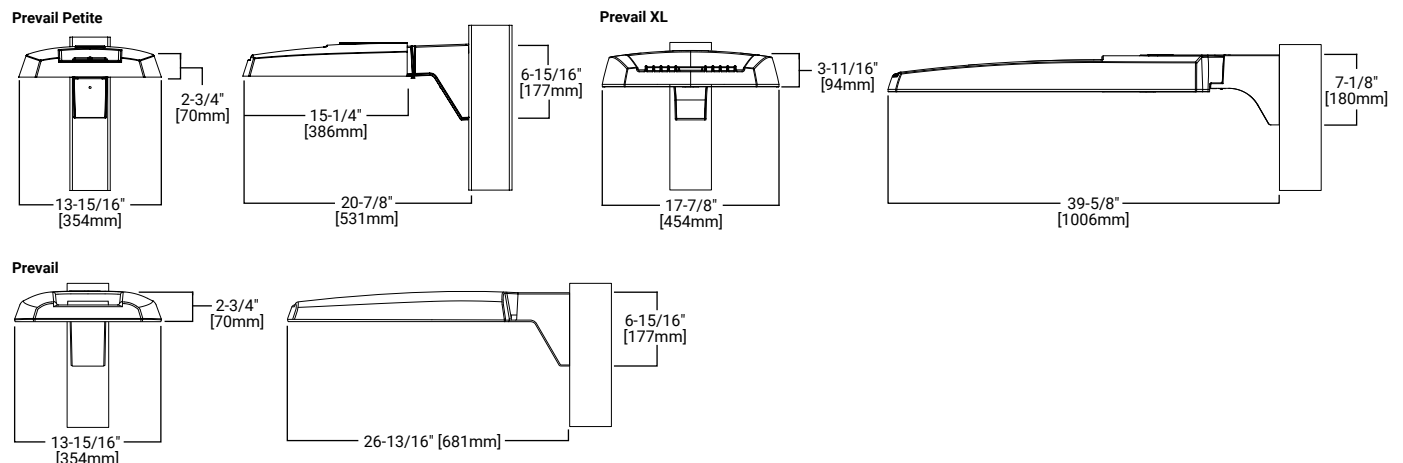

NOTES:
 1. Visit <https://www.designlights.org/search/> to confirm qualification. Not all product variations are DLC qualified.
 2. IDA Certified for 3000K CCT and warmer only.

Ordering Information

SAMPLE NUMBER: PRV-XL-C75-D-UNV-T4-SA-BZ

Product Family ^{1,2}	Light Engine ⁴	Driver	Voltage	Distribution	Mounting	Color
PRV-P =Prevail Petite BAA-PRV-P =Prevail Petite BAA Compliant ³ TAA-PRV-P =Prevail Petite TAA Compliant ³	C10 =(1 LED) 4,900 Nominal Lumens C15 =(1 LED) 6,900 Nominal Lumens C20 =(1 LED) 9,800 Nominal Lumens C25 =(1 LED) 11,800 Nominal Lumens	D =Dimming (0-10V)	UNV =Universal (120-277V) 347 =347V 480 =480V ⁵ DV =DuraVolt (277-480V) ^{5,6}	T2 =Type II T3 =Type III T4 =Type IV T5 =Type V	SA =Standard Versatile Arm MA =Mast Arm WM =Wall Mount Arm ADJA =Adjustable Arm - Pole Mount ADJS =Adjustable Arm - Slipfitter, 3in vertical tenon ADJA-WM =Adjustable Arm - Wall Mount	BZ =Bronze AP =Grey BK =Black DP =Dark Platinum GM =Graphite Metallic WH =White
PRV =Prevail BAA-PRV =Prevail BAA Compliant ³ TAA-PRV =Prevail TAA Compliant ³	C15 =(1 LED) 7,100 Nominal Lumens C25 =(2 LEDs) 13,100 Nominal Lumens C40 =(2 LEDs) 17,100 Nominal Lumens C60 =(2 LEDs) 20,000 Nominal Lumens					
PRV-XL =Prevail XL BAA-PRV-XL =Prevail XL BAA Compliant ³ TAA-PRV-XL =Prevail XL TAA Compliant ³	C75 =(4 LED) 26,100 Nominal Lumens C100 =(4 LED) 31,000 Nominal Lumens C125 =(4 LED) 36,000 Nominal Lumens C150 =(6 LED) 41,100 Nominal Lumens C175 =(6 LED) 48,600 Nominal Lumens					
Options (Add as Suffix)			Accessories (Order Separately) ^{20,21}			
7030 =70 CRI / 3000K CCT ⁷ 7050 =70 CRI / 5000K CCT ⁷ HSS =House Side Shield ⁸ L90 =Optics Rotated 90° Left R90 =Optics Rotated 90° Right 10K =10kV UL 1449 Fused Surge Protective Device 20MSP =20kV MOV Surge Protective Device 20K =Series 20kV UL 1449 Surge Protective Device HA =50°C High Ambient Temperature ⁹ CC =Coastal Construction ¹⁰ PER =NEMA 3-PIN Twistlock Photocontrol Receptacle ¹¹ PER7 =NEMA 7-PIN Twistlock Photocontrol Receptacle ¹¹ MS/DIM-L08 =Dimming Motion and Daylight Sensor, IR Remote Programmable, < 8' Mounting ^{12,13} MS/DIM-L20 =Dimming Motion and Daylight Sensor, IR Remote Programmable, 8' - 20' Mounting ^{12,13} MS/DIM-L40 =Dimming Motion and Daylight Sensor, IR Remote Programmable, 21' - 40' Mounting ^{12,13}			SPB1 =Dimming Motion and Daylight Sensor, Bluetooth Programmable, < 8' Mounting ^{12,14} SPB2 =Dimming Motion and Daylight Sensor, Bluetooth Programmable, 8' - 20' Mounting ^{12,14} SPB4 =Dimming Motion and Daylight Sensor, Bluetooth Programmable, 21' - 40' Mounting ^{12,14} ZW =Wavelinx-enabled 4-PIN Twistlock Receptacle ¹² ZD =SR Driver-enabled 4-PIN Twistlock Receptacle ¹² ZW-SWPD4XX =WaveLinX, Dimming Motion and Daylight, WAC Programmable, 7' - 15' Mounting ^{12,15,16,17} ZW-SWPD5XX =WaveLinX, Dimming Motion and Daylight, WAC Programmable, 15' - 40' Mounting ^{12,15,16,17} ZD-SWPD4XX =WaveLinX, SR Driver, Dimming Motion and Daylight, WAC Programmable, 7' - 15' Mounting ^{12,15,16,17} ZD-SWPD5XX =WaveLinX, SR Driver, Dimming Motion and Daylight, WAC Programmable, 15' - 40' Mounting ^{12,15,16,17} (See Table Below) =LumenSafe Integrated Network Security Camera ^{14,19}			
NOTES: 1. DesignLights Consortium® Qualified. Refer to www.designlights.org Qualified Products List under Family Models for details. 2. Customer is responsible for engineering analysis to confirm pole and fixture compatibility for all applications. Refer to installation instructions IB500002EN and pole white paper WP513001EN for additional support information. 3. Only product configurations with these designated prefixes are built to be compliant with the Buy American Act of 1933 (BAA) or Trade Agreements Act of 1979 (TAA), respectively. Please refer to DOMESTIC PREFERENCES website for more information. Components shipped separately may be separately analyzed under domestic preference requirements. 4. Standard 4000K CCT and 70CRI. 5. 480V not to be used with ungrounded or impedance grounded systems. 6. DuraVolt drivers feature added protection from power quality issues such as loss of neutral, transients and voltage fluctuations. Visit www.signify.com/duravolt for more information. 7. Use dedicated IES files on product website for non-standard CCTs. 8. House Side Shield not suitable with T5 distribution. Not available with PRV-C60 lumen package. 9. Not available with PRV-C60 lumen package. Not available with PRV-P-C25 lumen package. 10. Salt spray tested to over 5,000-hours per ASTM B117 with a scribe rating of 9 per ASTM D1654. Also achieves 7,000-hour rating per ASTM B117 with a scribe rating of 4 per ASTM D1654. Extended lead times may apply. 11. If DuraVolt (DV) is specified, use a photocontrol that matches the input voltage used. 12. Controls system is not available in combination with a photocontrol receptacle (PER or PER7) or another controls system (MS, SPB, ZD, or ZW). Option not available with DuraVolt (DV) voltage option. 13. Utilizes the Wattstopper sensor FSP-211. Sensor color white unless specified otherwise via PDR. To field-configure, order FSIR-100 accessory separately. 14. Utilizes the Wattstopper sensor FSP-3XX series. Sensor color determined by product finish. See Sensor Color Reference Table. Field-configures via mobile application. See Controls section for details.			PRVSA-XX =Standard Arm Mounting Kit ²² PRVMA-XX =Mast Arm Mounting Kit ²² PRVWM-XX =Wall Mount Kit ²² PRV-ADJA-XX =Adjustable Arm - Pole Mount Kit ²² PRV-ADJS-XX =Adjustable Arm - Slipfitter Kit ²² PRV-ADJA-WM-XX =Adjustable Arm - Wall Mount Kit ²² PRVXLSA-XX =Standard Arm Mounting Kit ¹⁸ PRVXLMA-XX =Mast Arm Mounting Kit ¹⁸ PRVXLWM-XX =Wall Mount Kit ¹⁸ PRV-XL-ADJA-XX =Adjustable Arm - Pole Mount Kit ¹⁸ PRV-XL-ADJS-XX =Adjustable Arm - Slipfitter Kit ¹⁸ PRV-XL-ADJA-WM-XX =Adjustable Arm - Wall Mount Kit ¹⁸ MA1010-XX =Single Tenon Adapter for 3-1/2" O.D. Tenon MA1011-XX =2@180° Tenon Adapter for 3-1/2" O.D. Tenon MA1017-XX =Single Tenon Adapter for 2-3/8" O.D. Tenon MA1018-XX =2@180° Tenon Adapter for 2-3/8" O.D. Tenon SRA238 =Tenon Adapter from 2-3/8" to 3" PRV/COB-FDV =Full Drop Visor ²³ PRVXL/COB-FDV =Full Drop Visor ¹⁸ HS/VERD =House Side Shield ²⁴ VGS-F/B =Vertical Glare Shield, Front/Back ²⁴ VGS-SIDE =Vertical Glare Shield, Side ²⁴ OA/RA1013 =Photocontrol Shorting Cap OA/RA1014 =NEMA Photocontrol - 120V OA/RA1016 =NEMA Photocontrol - Multi-Tap 105-285V OA/RA1201 =NEMA Photocontrol - 347V OA/RA1027 =NEMA Photocontrol - 480V FSIR-100 =Wireless Configuration Tool for Occupancy Sensor ²⁵ SWPD4-XX =WaveLinX Sensor, Dimming Motion and Daylight, WAC Programmable, 7' - 15' Mounting ^{15,16,17,26} SWPD5-XX =WaveLinX Sensor, Dimming Motion and Daylight, WAC Programmable, 15' - 40' Mounting ^{15,16,17,26} WOLC-7P-10A =WaveLinX Outdoor Control Module (7-PIN) ²⁷			

LumenSafe Integrated Network Security Camera Technology Options (Add as Suffix)

Product Family	Camera Type	Data Backhaul		
L =LumenSafe Technology 	H =Dome Camera, High Res Z =Dome Camera, Remote PTZ	C =Cellular, Customer Installed SIM Card A =Cellular, Factory Installed AT&T SIM Card	V =Cellular, Factory Installed Verizon SIM Card S =Cellular, Factory Installed Sprint SIM Card	E =Ethernet Networking

Stock Ordering Information

Product Family ¹	Light Engine	Voltage	Distribution
PRVS =Prevail PRVS-XL =Prevail XL	C15 =(1 LED) 7,100 Nominal Lumens C25 =(2 LEDs) 13,100 Nominal Lumens C40 =(2 LEDs) 17,100 Nominal Lumens C60 =(2 LEDs) 20,000 Nominal Lumens	UNV =Universal (120-277V) 347 =347V ²	T3 =Type III T4 =Type IV
NOTES: 1. All stock configurations are standard 4000K/70CRI, bronze finish, and include the standard versatile mounting arm. 2. Only available in PRVS configurations C15, C25, C40 or C60.			

Mounting Details

Pole Mount Arm (PRV & PRV-P)

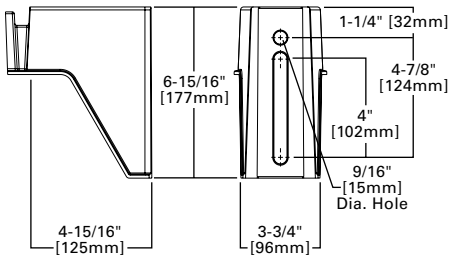

Pole Mount Arm (PRV-XL)

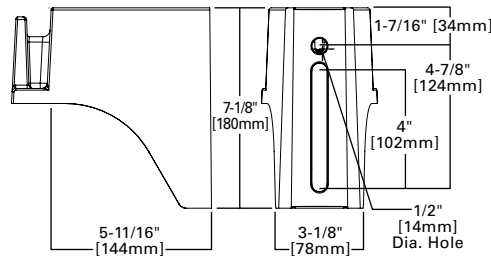

Versatile Mount System

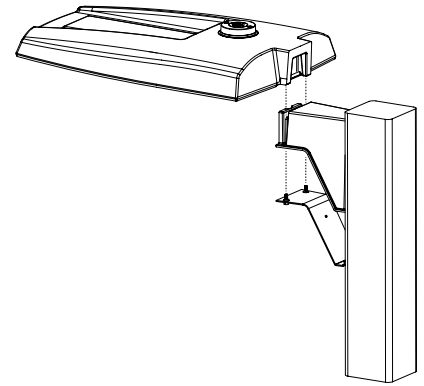

Wall Mount (PRV & PRV-P)

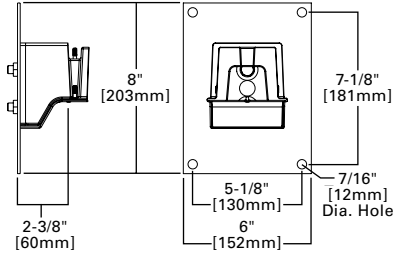

Wall Mount (PRV-XL)

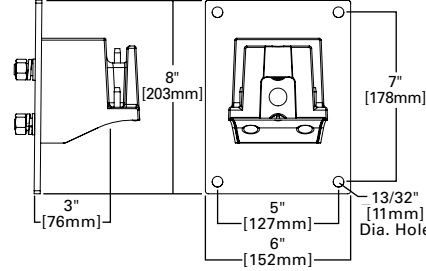

Mast Arm Mount (PRV & PRV-P)

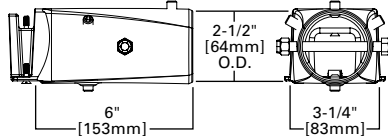

Mast Arm Mount (PRV-XL)

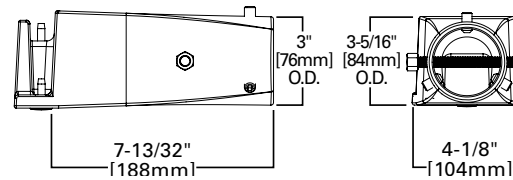

Adjustable Pole Mount Arm (PRV & PRV-P)

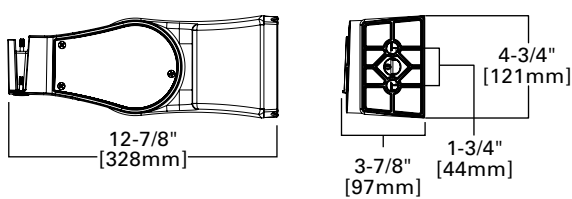

Adjustable Pole Mount Arm (PRV-XL)

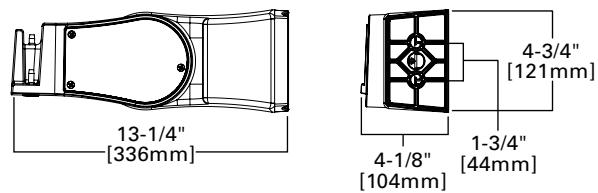

Adjustable Wall Mount (PRV & PRV-P)

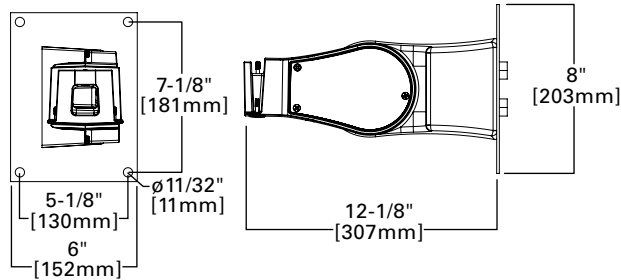

Adjustable Wall Mount (PRV-XL)

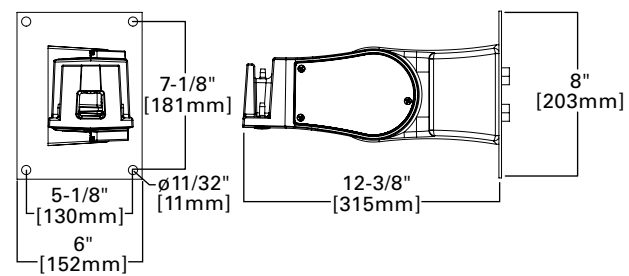

Adjustable Slipfitter (PRV & PRV-P)

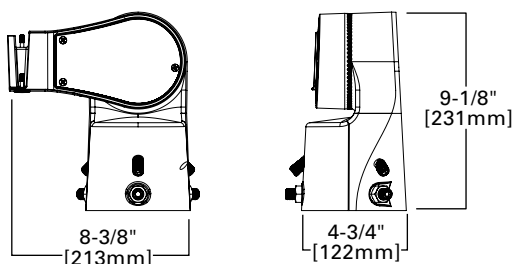

Adjustable Slipfitter (PRV-XL)

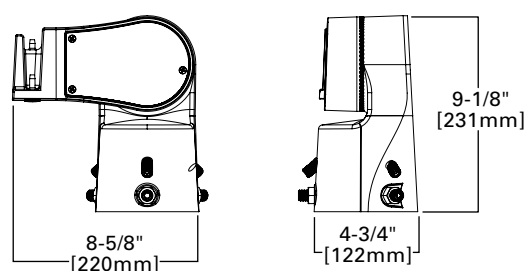

Mounting Details

Mounting Configurations and EPAs

NOTE: For 2 PRV's mounted at 90°, requires minimum 3" square or 4" round pole for fixture clearance. For 2 PRV-XL's mounted at 90°, requires minimum 4" square or round pole for fixture clearance. Customer is responsible for engineering analysis to confirm pole and fixture compatibility for applications.

Housing Size	Tilt Angle (Degrees)	Arm Mount Single	Arm Mount 2 @ 180°	Arm Mount 2 @ 90°	Arm Mount 3 @ 90°	Arm Mount 4 @ 90°
Prevail Petite	0°	0.54	1.08	0.84	1.38	1.38
	60°	1.68	1.85	2.42	3.15	3.30
Prevail	0°	0.92	1.35	1.42	1.63	1.63
	60°	2.20	2.40	3.05	3.88	4.07
	60° + Full Drop Visor	2.20	2.40	3.25	4.28	4.47
Prevail XL	0°	1.12	2.25	2.13	2.52	2.52
	60°	3.99	4.30	5.26	6.51	6.79
	60° + Full Drop Visor	3.99	4.30	5.59	7.17	7.49

Optical Configurations

PRV-P-C10/C15/C20/C25
(4,900/6,900/9,800/11,800 Nominal Lumens)

PRV-C15
(7,100 Nominal Lumens)

PRV-C25/C40/C60
(13,100/17,100/20,000 Nominal Lumens)

PRV-XL-C75/C100/C125
(26,100/31,000/36,300 Nominal Lumens)

PRV-XL-C150/C175
(41,100/48,600 Nominal Lumens)

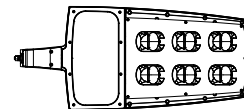
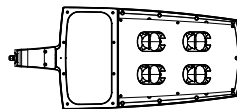
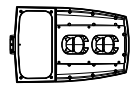
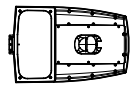

Optical Distributions

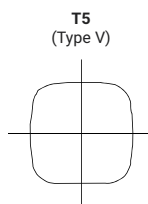
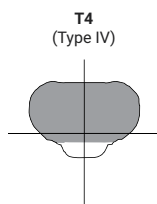
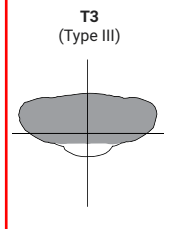
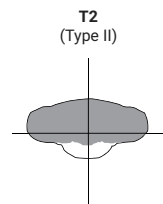

■ = Distribution with House Side Shield (HSS)
□ = Optical Distribution

Product Specifications

Construction

- Single-piece die-cast aluminum housing
- Tethered die-cast aluminum door

Optics

- Dark Sky Approved (3000K CCT and warmer only)
- Precision molded polycarbonate optics

Electrical

- -40°C minimum operating temperature
- 40°C maximum operating temperature
- >.9 power factor
- <20% total harmonic distortion
- Class 1 electronic drivers have expected life of 100,000 hours with <1% failure rate
- 0-10V dimming driver is standard with leads external to the fixture
- Standard MOV surge protective device designed to withstand 10kV of transient line surge

Mounting

- Versatile, patented, standard mount arm accommodates multiple drill patterns ranging from 1-1/2" to 4-7/8" (Type M drilling recommended for new installations)
- A knock-out on the standard mounting arm enables round pole mounting
- Adjustable pole and wall mount arms adjust in 5° increments from 0° to 60°; Downward facing orientation only (Type N drilling required for ADJA mount)
- Adjustable slipfitter arm adjusts in 5° increments from -5° to 85°; Downward facing orientation only
- Adjustable Arms: 1.5G vibration rated
- Prevail and Prevail Petite: 3G vibration rated
- Prevail XL Mast Arm: 3G vibration rated
- Prevail XL Standard Arm: 1.5G vibration rated

Typical Applications

- Parking lots, Walkways, Roadways and Building Areas

Finish

- Five-stage super TGIC polyester powder coat paint, 2.5 mil nominal thickness
- Finish is compliant to 3,000 hour salt spray standard (per ASTM B117)

Shipping Data

- Prevail Petite: 18 lbs. (7.94 kgs.)
- Prevail: 20 lbs. (9.09 kgs.)
- Prevail XL: 45 lbs. (20.41 kgs.)

Warranty

- Five year limited warranty, consult website for details. www.cooperlighting.com/legal

Energy and Performance Data

[View PRV-P IES files](#)
[View PRV IES files](#)
[View PRV-XL IES files](#)

Power and Lumens

Product Family	Prevail Petite				Prevail				Prevail XL					
Light Engine	C10	C15	C20	C25	C15	C25	C40	C60	C75	C100	C125	C150	C175	
Power (Watts)	35	49	73	94	52	96	131	153	176	217	264	285	346	
Input Current @ 120V (A)	0.29	0.41	0.61	0.79	0.43	0.80	1.09	1.32	1.50	1.84	2.21	2.38	2.92	
Input Current @ 277V (A)	0.13	0.18	0.27	0.35	0.19	0.35	0.48	0.57	0.66	0.82	0.97	1.04	1.25	
Input Current @ 347V (A)	0.11	0.16	0.23	0.29	0.17	0.30	0.41	0.48	0.54	0.66	0.79	0.84	1.02	
Input Current @ 480V (A)	0.08	0.12	0.17	0.22	0.12	0.22	0.30	0.35	0.40	0.48	0.57	0.62	0.74	
Distribution ¹														
Type II	4000K Lumens	4,775	6,717	9,542	11,521	7,123	13,205	17,172	20,083	26,263	31,231	36,503	41,349	48,876
	BUG Rating	B1-U0-G1	B1-U0-G1	B2-U0-G2	B2-U0-G2	B2-U0-G2	B2-U0-G2	B3-U0-G3	B3-U0-G3	B3-U0-G3	B3-U0-G4	B4-U0-G4	B4-U0-G4	B4-U0-G5
	Lumens per Watt	138	137	131	122	137	138	131	131	149	144	138	145	141
	3000K Lumens ¹	4,869	6,595	9,369	11,312	6,994	12,965	16,860	19,718	25,786	30,664	35,840	40,598	47,989
Type III	4000K Lumens	4,782	6,727	9,556	11,538	7,111	13,183	17,144	20,050	26,120	31,061	36,304	41,124	48,610
	BUG Rating	B1-U0-G2	B1-U0-G2	B2-U0-G3	B2-U0-G3	B1-U0-G2	B2-U0-G3	B3-U0-G4	B3-U0-G4	B3-U0-G5	B3-U0-G5	B3-U0-G5	B4-U0-G5	B4-U0-G5
	Lumens per Watt	138	137	131	123	137	137	131	131	148	143	138	144	140
	3000K Lumens ¹	4,695	6,605	9,383	11,329	6,982	12,944	16,832	19,686	25,646	30,497	35,645	40,377	47,727
Type IV	4000K Lumens	4,880	6,865	9,752	11,774	7,088	13,140	17,087	19,984	26,098	31,035	36,274	41,089	48,569
	BUG Rating	B1-U0-G2	B1-U0-G2	B2-U0-G3	B2-U0-G3	B1-U0-G3	B2-U0-G4	B2-U0-G4	B3-U0-G5	B3-U0-G5	B3-U0-G5	B3-U0-G5	B3-U0-G5	B4-U0-G5
	Lumens per Watt	141	140	134	125	136	137	130	131	148	143	137	144	140
	3000K Lumens ¹	4,792	6,740	9,575	11,561	6,959	12,901	16,777	19,621	25,624	30,471	35,615	40,343	47,687
Type V	4000K Lumens	5,067	7,128	10,126	12,226	7,576	14,045	18,264	21,360	28,129	33,450	39,097	44,287	52,349
	BUG Rating	B3-U0-G2	B3-U0-G2	B4-U0-G3	B4-U0-G3	B3-U0-G3	B4-U0-G3	B4-U0-G4	B5-U0-G4	B5-U0-G5	B5-U0-G5	B5-U0-G5	B5-U0-G5	B5-U0-G5
	Lumens per Watt	146	145	139	130	146	146	139	140	160	154	148	155	151
	3000K Lumens ¹	4,975	6,999	9,942	12,004	7,438	13,790	17,932	20,972	27,618	32,843	38,387	43,483	51,398

NOTES:
1. For 3000K, 5000K or HSS data, refer to published IES files.

Lumen Maintenance

Configuration	TM-21 Lumen Maintenance (50,000 Hours)	Theoretical L70 (Hours)
Prevail and Prevail Petite at 25°C	91.30%	> 194,000
Prevail and Prevail Petite at 40°C	87.59%	> 134,000
Prevail XL at 25°C	91.40%	> 204,000
Prevail XL at 40°C	89.41%	> 158,000

Sensor Color Reference Table (SPBx)

Housing Finish	Sensor Color
AP =Grey	Grey
BZ =Bronze	Bronze
BK =Black	Black
DP =Dark Platinum	Grey
GM =Graphite Metallic	Black
WH =White	White

Lumen Multiplier

Ambient Temperature	Lumen Multiplier
10°C	1.02
15°C	1.01
25°C	1.00
40°C	0.99

Control Options

0-10V This fixture provides 0-10V dimming wire leads for use with a lighting control panel or other control method.

Photocontrol (PER and PER7) Photocontrol receptacles provide a flexible solution to enable “dusk-to-dawn” lighting by sensing light levels. Advanced control systems compatible with NEMA 7-PIN standards can be utilized with the PER7 receptacle.

Dimming Occupancy Sensor (SPB, MS/DIM-LXX and MS-LXX) These sensors are factory installed in the luminaire housing. When the SPB or MS/DIM sensor options are selected, the luminaire will dim down after five minutes of no activity detected. When activity is detected, the luminaire returns to full light output. When a sensor for ON/OFF operation (MS-LXX) is selected, the luminaire will turn off after five minutes of no activity. These occupancy sensors include an integral photocell for “dusk-to-dawn” control or “daylight harvesting.” Factory default is enabled for the MS sensors and disabled for the SPB. SPB motion sensors require the Sensor Configuration mobile application by Wattstopper to change factory default dimming level, time delay, sensitivity and other parameters. Available for iOS and Android devices. The SPB sensor is factory preset to dim down to approximately 10% power with a time delay of five minutes.

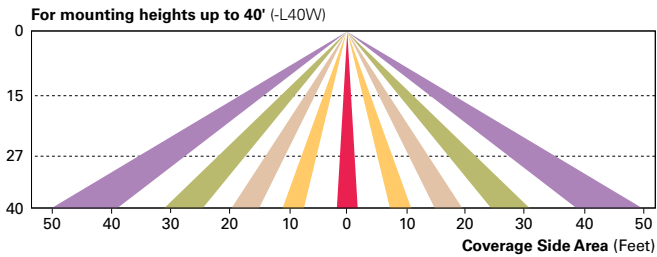
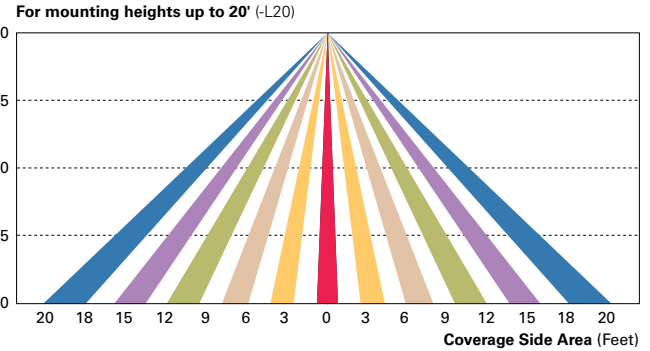
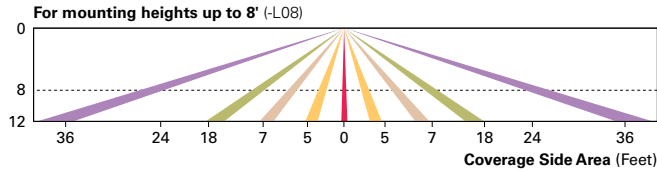

WaveLinx Wireless Control and Monitoring System Available in 7-PIN or 4-PIN configurations, the WaveLinx Outdoor control platform operates on a wireless mesh network based on IEEE 802.15.4 standards enabling wireless control of outdoor lighting. At least one Wireless Area Controller (WAC) is required for full functionality and remote communication (including adjustment of any factory pre-sets).

WaveLinx Outdoor Control Module (WOLC-7P-10A) A photocontrol that enables astronomic or time-based schedules to provide ON, OFF and dimming control of fixtures utilizing a 7-PIN receptacle. The out-of-box functionality is ON at dusk and OFF at dawn.

WaveLinx Wireless Sensor (SWPD4 and SWPD5) These outdoor sensors offer passive infrared (PIR) occupancy sensing and a photocell for closed-loop daylight sensing. These sensors can be factory installed or field-installed via simple, tool-less integration into luminaires equipped with the Zhaga Book 18 compliant 4-PIN receptacle (ZD or ZW). These sensors are factory preset to dim down to approximately 50 percent power after 15 minutes of no activity detected, and the photocell for “dusk-to-dawn” control is default enabled. A variety of sensor lenses are available to optimize the coverage pattern for mounting heights from 7'-40'.

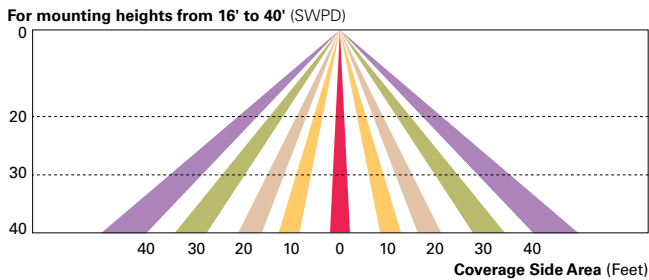

LumenSafe (LD) The LumenSafe integrated network camera is a streamlined, outdoor-ready camera that provides high definition video surveillance. This IP camera solution is optimally designed to integrate into virtually any video management system or security software platform of choice. No additional wiring is needed beyond providing line power to the luminaire. LumenSafe features factory-installed power and networking gear in a variety of networking options allowing security integrators to design the optimal solution for active surveillance.

LNC SERIES

Cat.#	
Job	Type



Approvals

SPECIFICATIONS

Intended Use:

The compact LED LNC is designed for entry/perimeter illumination for safety, security and identity. Typical mounting height is up to 12 feet with 40ft fixture spacing (without acrylic diffuser) and 30ft spacing with acrylic diffuser installed. Photocontrol option is available to provide dusk-to-dawn control for additional energy savings.

Construction:

Decorative die-cast aluminum housing and door. Rugged design protects internal components and provides excellent thermal management for long life – 60,000 hours minimum LED life at L96 rating per IESNA TM-21-11. Powder paint finishes provide lasting appearance in outdoor environments.

Optics/Electrical

LED:

Drivers are 120-277V, 50/60Hz Type II, III and Type IV lenses provide wide lateral spread.

0-10V dimming 120-277V only.

- LNC5L – 5 LEDs, Types II, III or IV available, see page 2 for electrical details
- LNC7L – 7 LEDs, Type II, III or IV available, see page 2 for electrical details
- LNC9L – 9 LEDs, Types II, III or IV available, see page 2 for electrical details
- 3000K - 80 CRI, 4000K - 70 CRI, and 5000K - 70 CRI, CCT nominal
- Minimum operating temperature is -40°C/-40°F
- Drivers have greater than .90 power factor and less than 20% Total Harmonic Distortion

Lenses:

Full cut-off distribution; Ambient diffuser included, use for applications near entrances or locations where reduced brightness is desired.

Installation:

Quick mount adapter provides quick installation, designed for recessed box 4" square junction box.

Listings:

Listed and labeled to UL 1598 for wet locations, 25° C ambient environments. DesignLights Consortium® (DLC) qualified. Please refer to the DLC website for specific product qualifications at: <http://www.designlights.org/>

- IES Progress Award Winner - 2012

Warranty:

Five year limited warranty. For more information visit: <http://www.hubbelloutdoor.com/resources/warranty/>

PRODUCT IMAGE(S)



LNC-5L



LNC-7L



LNC-9L



With diffuser



DIMENSIONS

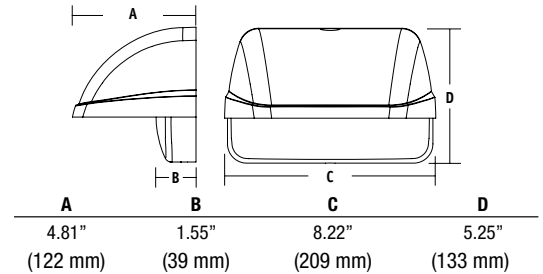

SHIPPING INFORMATION

Catalog Number	G.W(kg)/CTN	Carton Dimensions			Carton Qty. per Master Pack
		Length Inch (cm)	Width Inch (cm)	Height Inch (cm)	
LNC-5LU	9.6 (4.36)	14.5 (37)	9.6 (24.5)	6.8 (17.5)	2
LNC-7LU	9.6 (4.36)	14.5 (37)	9.6 (24.5)	6.8 (17.5)	2
LNC-9LU	9.6 (4.36)	14.5 (37)	9.6 (24.5)	6.8 (17.5)	2

CERTIFICATIONS/LISTINGS



*3000K and warmer CCTs only

ORDERING INFORMATION

ORDERING EXAMPLE: LNC-9LU-5K-3-1-PCU

SERIES	NUMBER OF LEDS	VOLTAGE	CCT	IES DISTRIBUTION	FINISH	OPTIONS
LNC	5L 5 LEDs 7L 7 LEDs 9L 9 LEDs	U 120V-277V 1 120V 2 208V 3 240V 4 277V	3K 3000K nominal, 70 CRI 4K 4000K nominal, 70 CRI 5K 5000K nominal	2 Type II 3 Type III 4 Type IV	1 Bronze 2 Black 3 Gray 4 White 5 Platinum	PCU Universal Button Photocell

AM¹ Amber (590 μm available for "Turtle Friendly"/observatory applications, 350 mA (consult factory))

1 Amber LEDs only available on 7LU and 9LU configurations, 350 mA only



Hubbell Outdoor Lighting • 701 Millennium Boulevard • Greenville, SC 29607 • Phone: 864-678-1000

Due to our continued efforts to improve our products, product specifications are subject to change without notice.

© 2016 HUBBELL OUTDOOR LIGHTING, All Rights Reserved • For more information visit our website: www.hubbelloutdoor.com • Printed in USA

LAREDLNC-SPEC
AUGUST 30, 2017 4:47 PM

REPLACEMENT PART

CATALOG NUMBER	DESCRIPTION
93039574	Frosted comfort shield, improved uniformity with only 5% reduction

PHOTOMETRICS

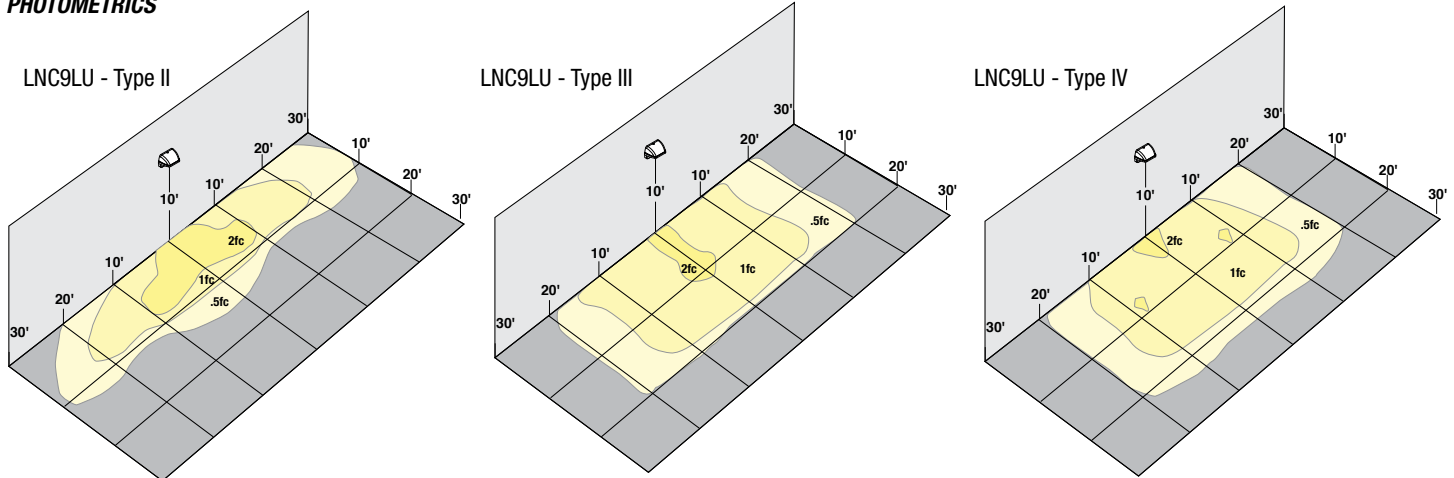

PERFORMANCE DATA

# OF LEDS	DRIVE CURRENT	SYSTEM WATTS	DIST. TYPE	5K (5000K nominal, 70 CRI)		4K (4000K nominal, 70 CRI)		3K (3000K nominal, 80 CRI)		AM (<580 nm wave-length)		
				LUMENS	LPW ¹	LUMENS	LPW ¹	LUMENS	LPW ¹	LUMENS	SYSTEM WATTS	LPW ¹
5	STD. (700mA)	13W	2	1,150	88.5	1,052	81	883	68			
			3	1,132	87	1,077	83	833	64			
			4	1,146	88	1,053	81	849	65			
7	AM (350mA)	17W	2	1,515	89	1,369	80.5	1,272	75			
			3	1,500	88	1,539	90.5	1,392	82	268	6.6	59
			4	1,557	91.5	1,535	90	1,425	84			
9		22W	2	2,069	94	2,033	92	1,588	72			
			3	2,024	92	1,989	90	1,623	74			
			4	2,095	95	2,059	93.5	1,680	76	382	8.3	46

Lumen values are from photometric tests performed in accordance with IESNA LM-79-08. Data is considered to be representative of the configurations shown. Actual performance may differ as a result of end-user environment and application. Please consult IES files for BUG ratings.

PROJECTED LUMEN MAINTENANCE

Ambient Temp.	OPERATING HOURS					
	0	25,000	50,000	TM-21-11 ¹ L96 60,000	100,000	L70 (hours)
25°C / 77°F	1.00	0.98	0.97	0.96	0.95	>791,000
40°C / 104°F	0.99	0.98	0.96	0.96	0.94	>635,000

1. Projected per IESNA TM-21-11 * (Nichia 219B, 700mA, 85°C Ts, 10,000hrs)
Data references the extrapolated performance projections for the LNC-12LU-5K base model in a 40°C ambient, based on 10,000 hours of LED testing per IESNA LM-80-08.

LUMINAIRE AMBIENT TEMPERATURE FACTOR (LATF)

AMBIENT TEMPERATURE		LUMEN MULTIPLIER
0° C	32° F	1.02
10° C	50° F	1.01
20° C	68° F	1.00
25° C	77° F	1.00
30° C	86° F	1.00
40° C	104° F	0.99
50° C	122° F	0.98

Use these factors to determine relative lumen output for average ambient temperatures from 0-50°C (32-122°F).

ELECTRICAL DATA

# OF LEDS	DRIVE CURRENT (mA)	DRIVE CURRENT (mA)	INPUT VOLTAGE (V)	CURRENT (Amps)	SYSTEM POWER (w)
5	1	STD. (700mA)	120	0.11	13
			277	0.05	13
7	1	STD. (700mA)	120	0.14	17
			277	0.07	17
9	1	STD. (700mA)	120	0.17	22
			277	0.09	22

Steel Poles



SSS SQUARE STRAIGHT STEEL

Catalog #		Type
Project		
Comments		Date
Prepared by		

FEATURES

- ASTM Grade steel base plate with ASTM A366 base cover
- Hand hole assembly 3" x 5" on 5" and 6" pole; and 2" x 4" on 4" pole
- 10'-39' mounting heights
- Drilled or tenon (specify)

DESIGN CONSIDERATIONS - VIBRATIONS AND NON-GROUND MOUNTED INSTALLATIONS

The information contained herein is for general guidance only and is not a replacement for professional judgment. Design considerations for wind-induced vibrations and non-ground mounted installations (e.g., installations on bridges or buildings) are not included in this document. Consult with a professional, and local and federal standards, before ordering to ensure product is appropriate for the intended purpose and installation location. Refer to the Cooper Lighting Solutions Light Pole White Paper for risk factors and design considerations. [Learn more.](#)

NOTE: The Limited Warranty for this product specifically excludes fatigue failure or similar damage resulting from vibration, harmonic oscillation or resonance.

Specifications and dimensions subject to change without notice. Consult your lighting representative at Cooper Lighting Solutions or visit www.cooperlighting.com for available options, accessories and ordering information.

ORDERING INFORMATION

SAMPLE NUMBER: SSA5A20SFM1XG

Product Family	Shaft Size (Inches) ¹	Wall Thickness (Inches)	Mounting Height (Feet)	Base Type	Finish	Mounting Type	Number and Location of Arms	Arm Lengths (Feet)	Options (Add as Suffix)
SSS=Square Straight Steel	4=4"	A=0.120"	10=10'	S=Square Steel Base	F=Dark Bronze	2=2-3/8" O.D. Tenon (4" Long)	1=Single	X=None	A=1/2" Tapped Hub ³ B=3/4" Tapped Hub ³ C=Convenience Outlet ⁴ E=GFCI Convenience Outlet ⁴ G=Ground Lug H=Additional Hand Hole ⁵ V=Vibration Dampener
	5=5"	M=0.188"	15=15'		G=Galvanized Steel	3=3-1/2" O.D. Tenon (5" Long)	2=2 at 180°	2=2'	
	6=6"	X=0.250"	20=20'		J=Summit White	4=4" O.D. Tenon (6" Long)	3=Triple ²	3=2.5'	
			25=25'		K=Carbon Bronze	9=3" O.D. Tenon (4" Long)	4=4 at 90°	4=4"	
			30=30'	L=Dark Platinum	6=2-3/8" O.D. Tenon (6" Long)	5=2 at 90°	6=6'		
			35=35'	R=Hartford Green	7=4" O.D. Tenon (10" Long)	X=None	8=8'		
			39=39'	S=Silver	A=Type A Drilling				
				T=Graphite Metallic	C=Type C Drilling				
				V=Grey	E=Type E Drilling				
				W=White	F=Type F Drilling				
				X=Custom Color	G=Type G Drilling				
				Y=Black	J=Type J Drilling				
					K=Type K Drilling				
					M=Type M Drilling				
					N=Type N Drilling				
					R=Type R Drilling				
					S=Standard Upsweep Arm ⁶				
					Z=Type Z Drilling				

NOTES: 1. All shaft sizes nominal. 2. Square poles are 3 at 90°, round poles are 3 at 120°. 3. Tapped Hub is located 5' below the pole top and on the same side of pole as hand hole, unless specified otherwise. 4. Outlet is located 4' above base and on same side of pole as hand hole, unless specified otherwise. Receptacle not included, provision only. 5. Additional hand hole is located 12" below pole top and 90° from standard hand hole location, unless otherwise specified. 6. Arm must be ordered separately.

ANCHORAGE DATA

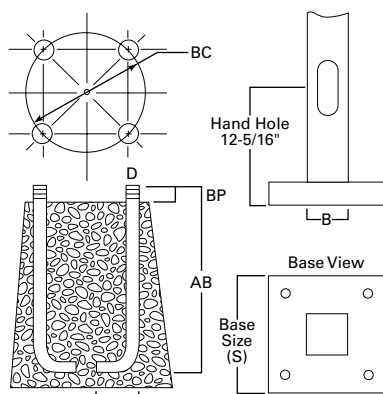

See technical information.

Pole	Template Number	Bolt Number	Bolt Circle (inches)	Number of Bolts	Bolt Size (inches)
SSS4	TMP1	AB1	8.5 - 11.0	4	3/4 x 25 x 3
SSS5	TMP1	AB1	11.0	4	3/4 x 25 x 3
SSS6	TMP2	AB3	12.5	4	1 x 36 x 4

EFFECTIVE PROJECTED AREA (At Pole Top)

Mounting Height (Feet)	Catalog Number ^{1,2}	Wall Thickness (Inches)	Base Square ³ (Inches)	Bolt Circle Diameter (Inches)	Anchor Bolt Projection ³ (Inches)	Shaft Size ³ (Inches)	Anchor Bolt Diameter x Length x Hook (Inches)	Net Weight (Pounds)	Maximum Effective Projected Area (Square Feet) ⁴				Max. Fixture Load - Includes Bracket (Pounds)
									80 mph	90 mph	100 mph	110 mph	
MH			S	BC	BP	B	D x AB x H						
10	SSS4A10S	0.120	10-1/2	11	4-1/2	4	3/4 x 25 x 3	85	30.0	22.0	17.0	13.0	100
15	SSS4A15S	0.120	10-1/2	11	4-1/2	4	3/4 x 25 x 3	118	15.0	11.5	8.7	6.5	100
20	SSS4A20S	0.120	10-1/2	11	4-1/2	4	3/4 x 25 x 3	150	8.7	5.9	3.9	2.5	150
20	SSS5A20S	0.120	10-1/2	11	4-1/2	5	3/4 x 25 x 3	183	15.4	11.1	7.9	5.5	150
25	SSS4A25S	0.120	10-1/2	11	4-1/2	4	3/4 x 25 x 3	181	3.7	1.7	0.3	--	200
25	SSS5A25S	0.120	10-1/2	11	5	5	3/4 x 25 x 3	222	9.3	6.0	3.5	1.6	200
25	SSS6A25S	0.120	12-1/2	12-1/2	5	6	1 x 36 x 4	284	9.9	6.1	3.5	1.2	200
30	SSS5A30S	0.120	10-1/2	11	4-1/2	5	3/4 x 25 x 3	260	4.7	2.1	--	--	200
30	SSS5M30S	0.188	10-1/2	11	4-1/2	5	3/4 x 25 x 3	392	10.4	6.4	3.5	1.5	200
30	SSS6A30S	0.120	12-1/2	12-1/2	5	6	1 x 36 x 4	330	4.3	1.4	--	--	200
30	SSS6M30S	0.188	12-1/2	12-1/2	5	6	1 x 36 x 4	489	19.0	13.0	8.7	5.6	200
35	SSS5M35S	0.188	10-1/2	11	4-1/2	5	3/4 x 25 x 3	453	5.8	2.8	--	--	200
35	SSS6M35S	0.188	12-1/2	12-1/2	5	6	1 x 36 x 4	564	12.8	7.2	3.7	1.0	200
35	SSS6X35S	0.250	12-1/2	12-1/2	5	6	1 x 36 x 4	738	16.5	11.0	6.8	3.5	200
39	SSS6M39S	0.188	12-1/2	12-1/2	5	6	1 x 36 x 4	618	7.3	3.0	--	--	300
39	SSS6X39S	0.250	12-1/2	12-1/2	5	6	1 x 36 x 4	816	13.0	7.0	3.7	0.8	300

EFFECTIVE PROJECTED AREA (Two Feet Above Pole Top)

Mounting Height (Feet)	Catalog Number ^{1,2}	Wall Thickness (Inches)	Base Square ³ (Inches)	Bolt Circle Diameter (Inches)	Anchor Bolt Projection ³ (Inches)	Shaft Size ³ (Inches)	Anchor Bolt Diameter x Length x Hook (Inches)	Net Weight (Pounds)	Maximum Effective Projected Area (Square Feet) ⁴				Max. Fixture Load - Includes Bracket (Pounds)
									80 mph	90 mph	100 mph	110 mph	
MH			S	BC	BP	B	D x AB x H						
10	SSS4A10S	0.120	10-1/2	11	4-1/2	4	3/4 x 25 x 3	85	23.0	17.5	14.0	11.0	100
15	SSS4A15S	0.120	10-1/2	11	4-1/2	4	3/4 x 25 x 3	118	13.4	10.0	7.5	5.7	100
20	SSS4A20S	0.120	10-1/2	11	4-1/2	4	3/4 x 25 x 3	150	7.6	5.2	3.4	2.1	150
20	SSS5A20S	0.120	10-1/2	11	4-1/2	5	3/4 x 25 x 3	183	13.8	9.9	7.1	4.9	150
25	SSS4A25S	0.120	10-1/2	11	4-1/2	4	3/4 x 25 x 3	181	3.4	1.6	0.3	--	200
25	SSS5A25S	0.120	10-1/2	11	5	5	3/4 x 25 x 3	222	8.5	5.5	3.2	1.5	200
25	SSS6A25S	0.120	12-1/2	12-1/2	5	6	1 x 36 x 4	284	9.1	5.6	3.0	1.2	200
30	SSS5A30S	0.120	10-1/2	11	4-1/2	5	3/4 x 25 x 3	260	1.8	--	--	--	200
30	SSS5M30S	0.188	10-1/2	11	4-1/2	5	3/4 x 25 x 3	392	9.6	5.9	1.9	0.2	200
30	SSS6A30S	0.120	12-1/2	12-1/2	5	6	1 x 36 x 4	330	4.1	1.3	--	--	200
30	SSS6M30S	0.188	12-1/2	12-1/2	5	6	1 x 36 x 4	489	18.5	12.5	8.4	5.3	200
35	SSS5M35S	0.188	10-1/2	11	4-1/2	5	3/4 x 25 x 3	453	5.5	2.4	--	--	200
35	SSS6M35S	0.188	12-1/2	12-1/2	5	6	1 x 36 x 4	564	11.8	7.0	3.5	1.0	200
35	SSS6X35S	0.250	12-1/2	12-1/2	5	6	1 x 36 x 4	738	16.0	10.5	6.4	3.4	200
39	SSS6M39S	0.188	12-1/2	12-1/2	5	6	1 x 36 x 4	618	7.0	2.4	--	--	300
39	SSS6X39S	0.250	12-1/2	12-1/2	5	6	1 x 36 x 4	816	12.0	6.7	3.0	0.5	300

- NOTES:
1. Catalog number includes pole with hardware kit. Anchor bolts not included. Before installing, make sure proper anchor bolts and templates are obtained.
 2. Tenon size or machining for rectangular arms must be specified. Hand hole position relative to drill location.
 3. Shaft size, base square, anchor bolts and projections may vary slightly. All dimensions nominal.
 4. EPAs based on shaft properties with wind normal to flat. EPAs calculated using base wind velocity as indicated plus 30% gust factor.

VIBRATION

Vibrations may cause damage to structures, including poles. Vibrations are unpredictable, and there are many factors and variables that can cause damaging vibrations. Many wind conditions exist that can create damaging vibrations to poles and luminaires, such as constant winds between 10-30 mph. Although all pole types can experience vibration, straight square poles seem to be most prone. Vibration dampers and/or a round tapered design may be used to mitigate damage from vibrations, but there is no guarantee damaging vibrations will be prevented. Vibration dampers are not included with this pole but can be ordered separately. Consult with a professional, and local and federal standards, to ensure this pole is appropriate for the intended purpose and installation location. Refer to Cooper Lighting Solutions' Light Pole White Paper for risk factors and design considerations.

MAINTENANCE

Perform inspections periodically. A prudent inspection schedule would be: one week after installation, one month after installation, yearly after installation, and following any major wind event. During the inspection, check the poles for cracks. If cracks are detected, remedial action is required. Recheck anchor bolt torques and re-tighten according to the recommended torque values. Check for missing covers and pole caps and replace as necessary. Check the pole for corrosion and deterioration of the finish. Should there be corrosion or deterioration, take remedial action to correct.

WARNING: Customer is responsible for engineering analysis to confirm pole and fixture compatibility for all applications. Refer to pole white paper WP513001EN for additional support information. Before installing, make sure proper anchor bolts and templates are obtained. The use of unauthorized accessories such as banners, signs, cameras or pennants for which the pole was not designed voids the pole warranty and may result in pole failure causing serious injury or property damage. Information regarding total loading capacity can be supplied upon request. The pole warranty is void unless poles are used and installed as a complete pole and luminaire combination. This warranty specifically excludes failure as the result of a third party act or omission, misuse, unanticipated uses, fatigue failure or similar phenomena resulting from induced vibration, harmonic oscillation or resonance associated with movement of air currents around the product.

Specifications and dimensions subject to change without notice. Consult your lighting representative at Cooper Lighting Solutions or visit www.cooperlighting.com for available options, accessories and ordering information.

DESCRIPTION

The Halo Surface LED Downlight (SLD) uses advanced LED technology to create an ultra-low profile **Z1** with the performance and look of a traditional downlight. SLD4 is designed for installation in many 3-1/2" and 4" round or octagon junction boxes. May also retrofit in 4" aperture IC and Non-IC recessed housings*. Dedicated LED wiring connector meets high-efficacy code requirement in recessed downlighting. Suitable for residential or commercial installations. Ideal for closets, storage areas, attics and basements. Compliant with NFPA® 70, NEC® Section 410.16 (A)(3) and 410.16 (C)(5).

SPECIFICATION FEATURES

CONSTRUCTION

- Die cast aluminum trim ring and die formed aluminum frame

OPTICS

- WaveStream™ technology provides uniform luminance from a low profile flat lens
- AccuAim™ optics provide directional control for the "cone-of-light" beam distribution of a traditional downlight
- Precision molded lens features high transmission polymer with UV stabilized protecting film

DESIGNER TRIMS

Accessories (sold separately) SLD designer trims are accessory rings that attach to the SLD for a permanent finish. Refer to SLD accessories specification sheet for details.

- White (Paintable)
- Satin Nickel
- Tuscan Bronze

ELECTRICAL JUNCTION BOX MOUNTING

- SLD may be used in compatible electrical junction boxes in direct contact with insulation including spray foam insulation
- Suitable for installation in many 3-1/2" and 4" octagon and round electrical junction boxes. **Note:** Driver consumes 3 cubic inches of junction box.
- Installer must ensure compatibility of fit, wiring and proper mounting in the electrical junction box. This includes all applicable national and local electrical and building codes.
- Proprietary Slot-N-Lock quick installation system for junction box installation

- T-bracket with Slot-N-Lock mounting tabs included.

RECESSED HOUSING MOUNTING Friction Blade

- Pre-installed precision formed friction blades included
- Friction blade design allows the SLD to be installed in any position within the housing aperture (360 degrees)

* **Note:** Not for use in recessed housings in direct contact with spray foam insulation refer to NEMA LSD 57-2013

LED

- Trilateral linear LED assembly is integrated in trim perimeter.
- Color Temperature: 2700K, 3000K, 3500K, 4000K
- CRI options: 80 and 90*
 - 90 CRI can be used to comply with California Title 24 High Efficacy requirements. Certified to California Appliance Efficiency Database under JA8

- L70 at 50,000 hours projected in accordance with TM-21

WARRANTY

Eaton provides a five year limited warranty on the SLD LED

LED CHROMATICITY

- A tight chromaticity specification ensures LED color uniformity, sustainable Color Rendering Index (CRI) and Correlated Color Temperature (CCT) over the useful life of the LED
- LED chromaticity of 3 SDCM exceeds ENERGY STAR® color standards per ANSI C78.377-2008
- 90 CRI model features high color performance with R9 greater than 50

Catalog #		Type
Project		
Comments		Date
Prepared by		



SLD4058xxWH
80CRI
2700K, 3000K, 3500K,
and 4000K

SLD4059xxWH
90CRI
2700K, 3000K, 3500K,
and 4000K

4" Surface LED Downlight

Suitable for ceiling or wall electrical junction boxes

Suitable for 4" recessed housing retrofit (IC, Non-IC & AIR-TITE™)

ENERGY DATA

	80 CRI	90 CRI
Lumens (4000K models)	800	710
Input Voltage	120V	120V
Frequency	50/60 Hz	50/60 Hz
Input Current	0.10 A	0.10 A
Input Power	12.2 W	12 W
Efficiency (4000K models)	66 lm/W	59 lm/W
THD	≤ 20%	
Power Factor	≥ 0.90	
T Ambient	-30 - +40°C	
Sound Rating	Class A	

NOMENCLATURE

SLD405830WH
405 = 4" SLD
8 = >80 CRI
30 = 3000K
WH = Matte White

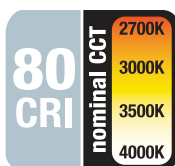

Refer to ENERGY STAR® Certified Products List.



Refer to ENERGY STAR® Qualified Products List. Can be used to comply with California Title 24 High Efficacy requirements. Certified to California Appliance Efficiency Database under JA8. Indoor LED nominal CCT of 4000K or less.

DIMMING

- Designed for continuous dimming capability to nominally 5% with many 120V Leading Edge (LE) and Trailing Edge (TE) phase control dimmers. Dimming to 5% is best assured using dimmers with low end trim adjustment. Consult dimmer manufacturer for compatibility and conditions of use. (Note some dimmers require a neutral in the wallbox.)

COMPLIANCE

- cULus Listed ceiling and wall
- cULus Damp Location listed ceiling and wall
- cULus Wet Location Listed, ceiling only (shower rated)
- Suitable for use in closets, compliant with NFPA® 70, NEC® Section 410.16 (A)(3) and 410.16 (C)(5)

- SLD may be used in compatible electrical junction boxes in direct contact with insulation including spray foam insulation
- May be installed in IC recessed housings in direct contact with insulation (Not for use in recessed housings in direct contact with spray foam insulation. Refer to NEMA LSD 57-2013)
- UL Classified when used in retrofit with listed housings (See Housing Compatibility)
- EMI/RFI: meets FCC 47CFR Part 15 Class B limits, and is suitable for use in residential and commercial installations
- Airtight certified per ASTM E283 (not exceeding 2.0 CFM under 57 Pascals pressure difference)
- 90 CRI: Can be used to comply with California Title 24 High Efficacy requirements.
- 80 CRI: Can be used to comply with California Title 24 Non-Residential Lighting Controls requirements as a LED luminaire.
- Can be used for International Energy Conservation Code (IECC)
- ENERGY STAR® Certified luminaire - consult ENERGY STAR® Certified Product List
- Contains no mercury or lead and RoHS compliant.
- Photometric testing in accordance with IES LM-79
- Lumen maintenance projections in accordance with IES LM-80 and TM-21



SLD4058xxWH
80CRI
2700K, 3000K, 3500K,
and 4000K

SLD4059xxWH
90CRI
2700K, 3000K, 3500K,
and 4000K

4" Surface LED Downlight

Suitable for ceiling or wall electrical junction boxes

Suitable for 4" recessed housing retrofit (IC, Non-IC & AIR-TITE™)

DIMENSIONS

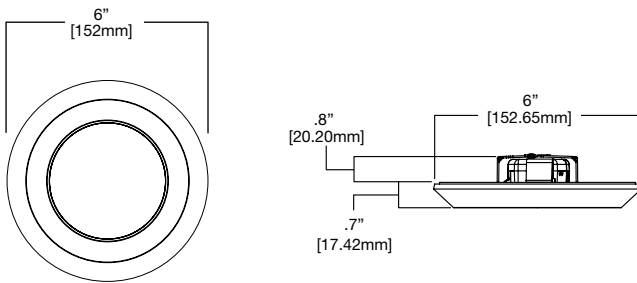

ORDERING INFORMATION

SAMPLE NUMBER: SLD405927WH SLD4TRMSN

Junction Box Installation: Order junction box separately, as supplied by others, to complete installation.

Recessed Installation: Order Halo recessed housing separately to complete installation.

Models	Color Rendering Index	Color Temperature (CCT)	Finish	Accessories
SLD405= 4" Surface LED Downlight, 120V California non-E26 Models SLD405927WH-CA SLD405930WH-CA SSLD405935WH-CA SSLD405940WH-CA	8=80 CRI 9=90 CRI	27=2700K 30=3000K 35=3500K 40=4000K	WH=White	Designer Trims Fit over the SLD4 for a designer finish SLD4TRMSN=4" SLD Satin Nickel SLD4TRMTBZ=4" SLD Tuscan Bronze SLD4TRMWH=4" SLD White (paintable) J-Box Spacer Extension Ring Add 15/16" depth when SLD driver cannot fit into installed junction box SLD4EXT=4" Surface LED J-Box Extender, 7.75" O.D. RAD Adapters When junction box is mounted flat on a ceiling or beam surface (not recessed in ceiling) SLD4RAD=4" SLD Round Surface J-Box Adapter, 6.15" O.D. (For 4-inch round or octagon junction boxes) Spare Parts SLD4ACCKIT=4" Accessory Parts Replacement Kit (Screwbase adapter, torsion springs, friction blades) SLD4BRKT=4" Junction Box Bracket & Screws Refer to SLD Accessories specification sheet for further information.

HOUSING COMPATIBILITY

The SLD4 is UL Listed in Halo recessed housings, and is UL Classified for use with any 4 inch diameter recessed housing constructed of steel or aluminum with an internal volume that exceeds 62.3 in³ in addition to those noted below:

Compatible Halo LED Housings with LED luminaire connector (high-efficacy compliant)		
HALO LED	Recessed Can Size	Catalog Number
		4"
Compatible Halo Incandescent E26 Screwbase Housings		
HALO	Recessed Can Size	Catalog Number
	4"	H99ICAT, H99TAT, H99RTAT, E4ICATSB, E4TATSB, E4RTATSB

COMPATIBLE WITH EATON'S CROUSE-HINDS JUNCTION BOXES

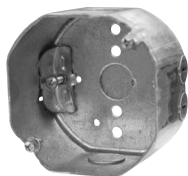

TP316
for non-metallic cable
4" x 4" x 2-1/8"
(102mm x 102mm x 54mm)

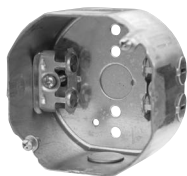

TP317
for metal clad cable
4" x 4" x 2-1/8"
(102mm x 102mm x 54mm)

- TP316 - for non-metallic cable
- TP317 - for metal clad cable
- UL Listed
- Refer to www.crouse-hinds.com

COMPATIBLE WITH MANY OTHER JUNCTION BOXES*



4" octagon light fixture/fan steel box
4" x 4" x 2-1/8"
(102mm x 102mm x 54mm)



4" octagon steel box
4" x 4" x 1-1/2"
(102mm x 102mm x 38mm)

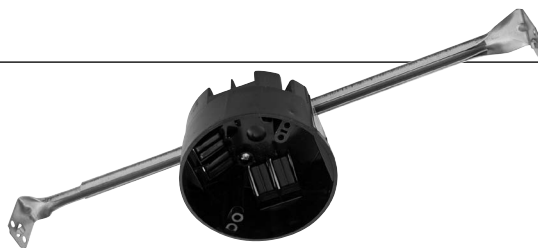

4" round new work non-metallic box with hanger bar assembly
4" diameter x 2-3/16" (102mm x 56mm)



4" round new work non-metallic light fixture/fan box
4" diameter x 2-3/16"
(102mm x 56mm)



3-1/2" round new work non-metallic ceiling box
3-1/2" diameter x 2-3/4"
(89mm x 70mm)



3-1/2" round old work non-metallic box
4-1/4" O.D. flange, 3-1/2" I.D. x 2-5/8"
(108mm O.D., 89mm I.D. x 67mm)



4" round surface mount box
4" diameter x 1-1/2"
(102mm x 38mm)
Requires SLD4RAD adapter

*This is a representative list of compatible junction boxes only. Information contained in this literature about other manufacturers' products is from published information made available by the manufacturer and is deemed to be reliable, but has not been verified. Eaton makes no specific recommendation on product selection and there are no warranties of performance or compatibility implied. Installer must determine that site conditions are suitable to allow proper installation of the SLD mounting bracket in the box.

PRODUCT DATA

Cat No.	CRI	CCT	Lumens	Power (W)	LPW
SLD405827WH	81	2700	720	12.2	59
SLD405830WH	81	3000	750	12.2	61
SLD405835WH	81	3500	780	12.2	64
SLD405840WH	81	4000	800	12.2	66
SLD405927WH	92	2700	650	12	54
SLD405930WH	92	3000	670	12	56
SLD405935WH	92	3500	690	12	58
SLD405940WH	92	4000	710	12	59

Performance values are presented as typical for the model(s) indicated. Field results may vary.

LIGHTING FACTS®

SLD405827WH - 80 CRI

Light Output (Lumens) 720
Watts 12.2
Lumens per Watt (Efficacy) 59.02

Color Accuracy
Color Rendering Index (CRI) 81

Light Color
Correlated Color Temperature (CCT) 2700 (Warm White)

Registration Number: F4QJ-78R3JK (4/17/2015)
Model Number: SLD405827WH
Type: Luminaire - Downlight

SLD405830WH - 80 CRI

Light Output (Lumens) 750
Watts 12.2
Lumens per Watt (Efficacy) 61.48

Color Accuracy
Color Rendering Index (CRI) 81

Light Color
Correlated Color Temperature (CCT) 3000 (Bright White)

Registration Number: F4QJ-C7D2C3 (5/7/2015)
Model Number: SLD405830WH (Upgrade 04/2015)
Type: Luminaire - Downlight

SLD405835WH - 80 CRI

Light Output (Lumens) 780
Watts 12.2
Lumens per Watt (Efficacy) 63.93

Color Accuracy
Color Rendering Index (CRI) 81

Light Color
Correlated Color Temperature (CCT) 3500 (Bright White)

Registration Number: F4QJ-B618FN (4/17/2015)
Model Number: SLD405835WH
Type: Luminaire - Downlight

SLD405840WH - 80 CRI

Light Output (Lumens) 800
Watts 12.2
Lumens per Watt (Efficacy) 65.57

Color Accuracy
Color Rendering Index (CRI) 81

Light Color
Correlated Color Temperature (CCT) 4000 (Bright White)

Registration Number: F4QJ-M8ZDPK (4/17/2015)
Model Number: SLD405840WH
Type: Luminaire - Downlight

SLD405927WH - 90 CRI

Light Output (Lumens) 650
Watts 12
Lumens per Watt (Efficacy) 54.17

Color Accuracy
Color Rendering Index (CRI) 92

Light Color
Correlated Color Temperature (CCT) 2700 (Warm White)

Registration Number: F4QJ-Q8MBG (4/17/2015)
Model Number: SLD405927WH
Type: Luminaire - Downlight

SLD405930WH - 90 CRI

Light Output (Lumens) 670
Watts 12
Lumens per Watt (Efficacy) 55.83

Color Accuracy
Color Rendering Index (CRI) 92

Light Color
Correlated Color Temperature (CCT) 3000 (Bright White)

Registration Number: F4QJ-14JH1 (5/7/2015)
Model Number: SLD405930WH (Upgrade 04/2015)
Type: Luminaire - Downlight

SLD405935WH - 90 CRI

Light Output (Lumens) 690
Watts 12
Lumens per Watt (Efficacy) 57.5

Color Accuracy
Color Rendering Index (CRI) 92

Light Color
Correlated Color Temperature (CCT) 3500 (Bright White)

Registration Number: F4QJ-2DFUT (4/17/2015)
Model Number: SLD405935WH
Type: Luminaire - Downlight

SLD405940WH - 90 CRI

Light Output (Lumens) 710
Watts 12
Lumens per Watt (Efficacy) 59.17

Color Accuracy
Color Rendering Index (CRI) 92

Light Color
Correlated Color Temperature (CCT) 4000 (Bright White)

Registration Number: F4QJ-1K230B (4/17/2015)
Model Number: SLD405940WH
Type: Luminaire - Downlight



Scottsdale® Legacy (CRUS)

LED Canopy Luminaire



OVERVIEW

Lumen Package	6,000 - 22,000
Wattage Range	61 - 159
Efficacy Range (LPW)	95 - 148
Weight lbs(kg)	27 (12.2)

QUICK LINKS

[Ordering Guide](#)[Performance](#)[Photometrics](#)[Dimensions](#)

FEATURES & SPECIFICATIONS

Construction

- Features a ultra-slim 3/4" profile die-cast housing, with flat glass lens. Unit is water-resistant, sealed and IP67 rated. Integral designed heat sink does not trap dirt and grime, ensuring cool running performance over the life of the fixture.
- Standard color is white and is finished with LSI's DuraGrip® polyester powder coat process. DuraGrip withstands extreme weather changes without cracking or peeling.
- Luminaire assembly incorporates a pressure stabilizing vent breather to prevent seal fatigue and failure.

Optical System

- Features an array of select, mid-power, high brightness, high efficiency LED chips; 5000K, 4000K, 3000K color temperature, 70 CRI.
- Choice of Symmetrical or Asymmetrical, which directs light through a clear tempered glass lens, to provide a uniform distribution.
- Five Lumen Packages: VLW (9,000), LW (10,000), SS (13,000), HO (18,000), VHO (22,000).

Electrical

- High performance factory programmable driver features over-voltage, under voltage, short-circuit and over temperature protection with integral surge protection

that meets IEEE C62.41.2 and ANSI C82.77-5 Location Category C Low standards. Additional 10kV surge protection device meets a minimum Category C Low standards (per ANSI/IEEE C62.41.2).

- Driver components are fully encased in potting for moisture resistance. Complies with IEC and FCC standards. 0-10 V dimming supplied standard with all drive currents.
- Die-cast aluminum, wet location rated driver/electrical enclosure is elevated above canopy deck to prevent water entry, provide easy "knock-out" connection of primary wiring and contributes to attaining the lowest operating temperatures available. Seals to optical housing via one-piece molded silicone gasket.
- Universal voltage power supply, 120-277 VAC, 50/60 HZ and 347-480 VAC, 50/60 HZ input.
- -40°C to 50°C (-40°F to +122°F) ambient operating temperature.
- Minimum 60,000 to 100,000 hours depending upon the ambient temperature of the installation location. See LSI website for specific guidance.

Hazardous Location

- Designed for lighter than air fuel applications. Product is suitable for Class 1 Divisions 2 only when properly installed per LSI installation instructions. See lsi-industries.com for specific guidance. LW

and SS lumen packages only.

Installation

- One-person installation.
- Installs in a 12" or 16" deck pan. Deck penetration consists of a 4" hole, simplifying installation and water sealing. Unit is designed to quickly retrofit into existing Scottsdale (4") hole as well as openings for Encore and Encore Top Access and to reconnect wiring for the SC/ECTA without having to relocate the conduit.
- Retro panels are available for existing Encores as well as kits for recessed and 2x2 installations (see separate spec sheets). Support brackets are provided standard, to prevent sagging of deck.

Warranty

- LSI LED Fixtures carry a 5-year warranty or 10-year warranty with registration for petroleum applications only (contact your LSI representative for details).

Listings

- UL and ETL listed to UL 1598, UL 8750 and other U.S. and International safety standards. Suitable for wet locations.
- Meets Buy American Act requirements.





Scottsdale® Legacy LED Canopy Luminaire

ORDERING GUIDE

[Back to Quick Links](#)

TYPICAL ORDER EXAMPLE: **CRUS SC LED SS 50 UE WHT**

Prefix	Distribution	Light Source	Drive Current	Color Temp	Input Voltage	Finish	Options
CRUS - LED Canopy Luminaire	SC - Symmetric	LED	VLW - Very Low Watt	50 - 5,000K	UE - Universal Voltage (120 - 277V) 347 - 480V	WHT - White BRZ - Bronze BLK - Black	HL ² - Hazardous Location
	AC ¹ - Asymmetric		LW - Low Watt	40 - 4,000K			
			SS - Super Saver HO - High Output VHO - Very High Output	30 - 3,000K			

Notes:

- 1 - AC distribution utilizes a reflector which alters the look from a standard SC distribution.
- 2 - LW and SS lumen packages only

PERFORMANCE

[Back to Quick Links](#)

DELIVERED LUMENS*											
Lumen Package	Distribution	3000K CCT			4000K CCT			5000K CCT			Avg. Watts
		Delivered Lumens	Efficacy	BUG Ratings	Delivered Lumens	Efficacy	BUG Ratings	Delivered Lumens	Efficacy	BUG Ratings	
VLW	SC	7933	130	B3-U0-G1	7977	131	B3-U0-G1	9055	148	B3-U0-G1	61
	AC	6687	110	B2-U0-G1	6723	110	B2-U0-G1	7632	125	B2-U0-G2	
LW	SC	9221	125	B3-U0-G1	9272	125	B3-U0-G1	10525	142	B3-U0-G1	74
	AC	7783	105	B2-U0-G1	7826	106	B2-U0-G1	8884	120	B2-U0-G2	
SS	SC	11980	122	B3-U0-G1	12046	128	B3-U0-G1	13674	140	B3-U0-G1	98
	AC	10159	104	B3-U0-G2	10215	104	B3-U0-G2	11595	118	B3-U0-G2	
HO	SC	16325	124	B3-U0-G1	16415	124	B3-U0-G1	18633	141	B3-U0-G1	132
	AC	13269	101	B3-U0-G2	13342	101	B3-U0-G2	15145	115	B3-U0-G2	
VHO	SC	19641	124	B4-U0-G2	19749	124	B4-U0-G2	22418	141	B4-U0-G2	159
	AC	15124	95	B3-U0-G2	15207	96	B3-U0-G2	17262	109	B3-U0-G2	

*LED Chips are frequently updated therefore values are nominal.

RECOMMENDED LUMEN MAINTENANCE					
Ambient Temperature C	0 hrs.	25K hrs.	50K hrs.	75K hrs.	100K hrs
25	25	100%	97%	92%	88%
30	30	100%	97%	92%	88%
35	40	100%	95%	90%	85%
40	50	100%	94%	89%	83%

FOOTNOTES:

- 1 - Lumen maintenance values at 25°C are calculated per TM-21 based on LM-80 data and in-situ luminaire testing.
- 2 - In accordance with IESNA TM-21-11, Projected Values represent interpolated value based on time durations that are within six times (6X) the IESNA LM-80-08 total test duration (in hours) for the device under testing ((DUT) i.e. the packaged LED chip).
- 3 - In accordance with IESNA TM-21-11, Calculated Values represent time durations that exceed six times NA LM-80-08 total test duration (in hours) for the device under testing ((DUT) i.e. the packaged LED chip).





PHOTOMETRICS

[Back to Quick Links](#)

Luminaire photometry has been conducted by an accredited testing laboratory in accordance with IESNA LM-79-08. As specified by IESNA LM-79-08 the entire luminaire is tested as the source resulting in a luminaire efficiency of 100%.

See <http://www.lsi-industries.com/products/led-lighting-solutions.aspx> for detailed photometric data.

CRUS-SC-SS-50

LUMINAIRE DATA

Wide Distribution	
Description	5000 Kelvin, 70 CRI
Delivered Lumens	13,674
Watts	97.9
Efficacy	140
IES Type	Type VS - Very Short
BUG Rating	B3-U0-G1

Zonal Lumen Summary

Zone	Lumens	%Luminaire
Low (0-30)°	3652.2	26.7%
Medium (30-60)°	7382.4	54.0%
High (60-80)°	2489.8	18.2%
Very High (80-90)°	149.4	1.1%
Uplight (90-180)°	0.0	0.0%
Total Flux	13673.8	100%

ISO FOOTCANDLE PLOT

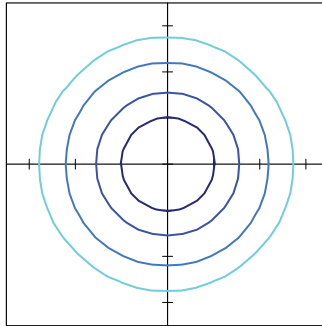

15' Mounting Height / 10' Grid Spacing

■ 10 FC ■ 5 FC ■ 2 FC ■ 1 FC

POLAR CURVE

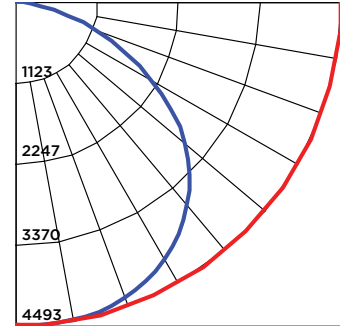

CRUS-AC-SS-50

LUMINAIRE DATA

Wide Distribution	
Description	5000 Kelvin, 70 CRI
Delivered Lumens	11595
Watts	98.8
Efficacy	117
IES Type	Type III - Very Short
BUG Rating	B2-U0-G2

Zonal Lumen Summary

Zone	Lumens	%Luminaire
Low (0-30)°	2766.0	23.9%
Medium (30-60)°	5868.8	50.6%
High (60-80)°	2712.2	23.4%
Very High (80-90)°	248.1	2.1%
Uplight (90-180)°	0.0	0.0%
Total Flux	11595.1	100%

ISO FOOTCANDLE PLOT

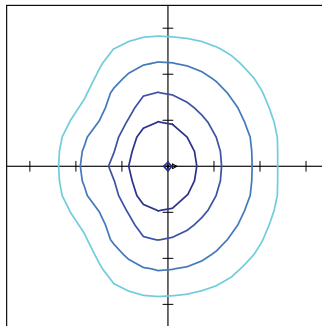

15' Mounting Height / 10' Grid Spacing

■ 10 FC ■ 5 FC ■ 2 FC ■ 1 FC

POLAR CURVE

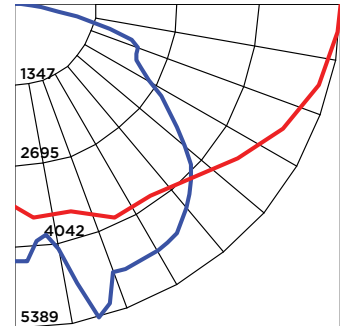

PRODUCT DIMENSIONS

[Back to Quick Links](#)

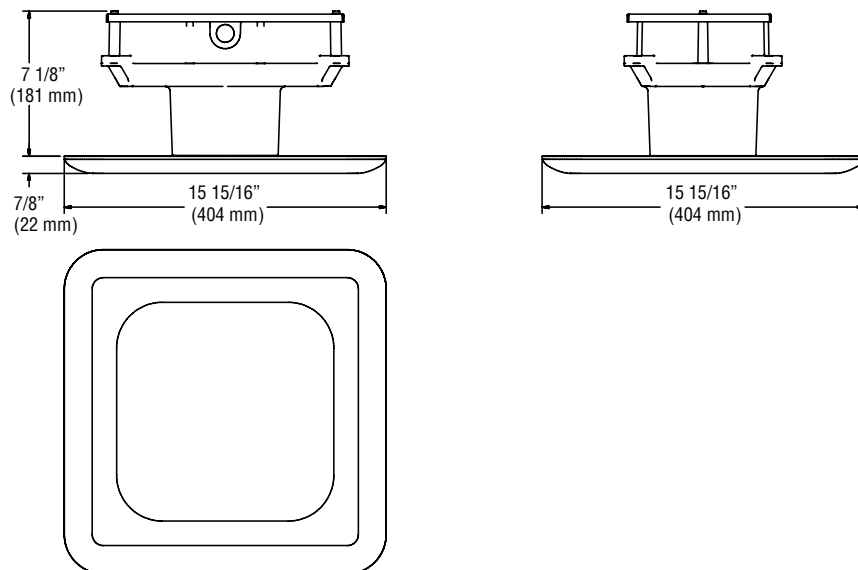

Project		Catalog #		Type	
Prepared by		Notes		Date	



Lumark

Prevail LED

Area / Site Luminaire

Product Features



Interactive Menu

- Ordering Information [page 2](#)
- Mounting Details [page 3](#)
- Optical Configurations [page 4](#)
- Product Specifications [page 4](#)
- Energy and Performance Data [page 5](#)
- Control Options [page 6](#)

Product Certifications



Quick Facts

- Lumen packages range from 4,800 - 52,300 lumens (35W - 350W)
- Replaces 70W up to 1,000W HID equivalents
- Efficacies up to 160 lumens per watt
- Energy and maintenance savings up to 85% versus HID solutions
- Standard universal quick mount arm with universal drill pattern

Connected Systems

- WaveLinX

Dimensional Details

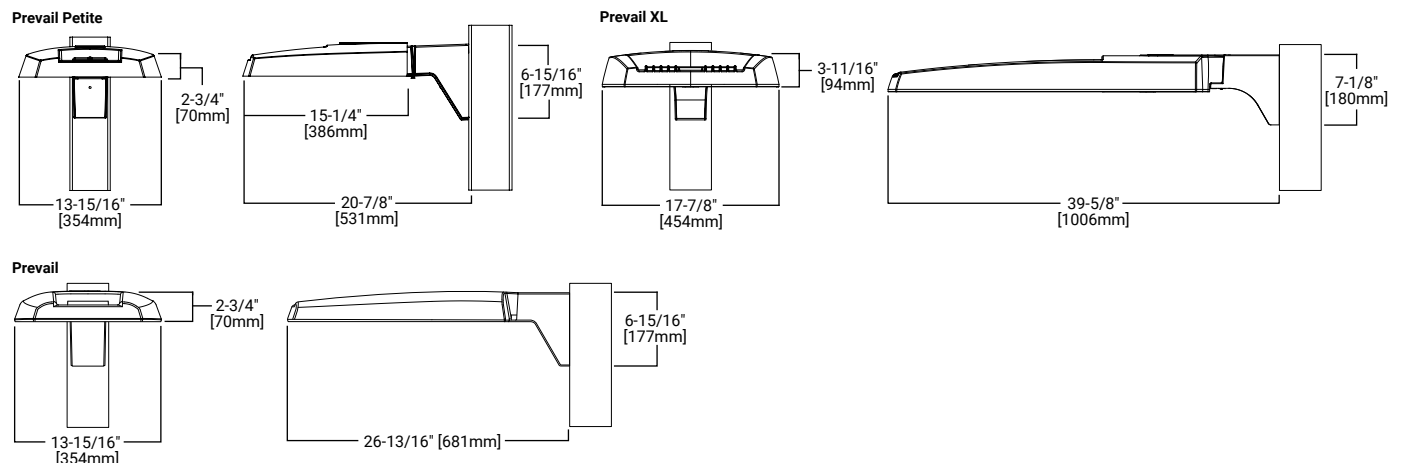

NOTES:
 1. Visit <https://www.designlights.org/search/> to confirm qualification. Not all product variations are DLC qualified.
 2. IDA Certified for 3000K CCT and warmer only.

Ordering Information

SAMPLE NUMBER: PRV-XL-C75-D-UNV-T4-SA-BZ

Product Family ^{1,2}	Light Engine ⁴	Driver	Voltage	Distribution	Mounting	Color
PRV-P=Prevail Petite BAA-PRV-P=Prevail Petite BAA Compliant ³ TAA-PRV-P=Prevail Petite TAA Compliant ³	C10=(1 LED) 4,900 Nominal Lumens C15=(1 LED) 6,900 Nominal Lumens C20=(1 LED) 9,800 Nominal Lumens C25=(1 LED) 11,800 Nominal Lumens	D=Dimming (0-10V)	UNV=Universal (120-277V) 347=347V 480=480V ⁵ DV=DuraVolt (277-480V) ^{5,6}	T2=Type II T3=Type III T4=Type IV T5=Type V	SA=Standard Versatile Arm MA=Mast Arm WM=Wall Mount Arm ADJA=Adjustable Arm - Pole Mount ADJS=Adjustable Arm - Slipfitter, 3in vertical tenon ADJA-WM=Adjustable Arm - Wall Mount	BZ=Bronze AP=Grey BK=Black DP=Dark Platinum GM=Graphite Metallic WH=White
PRV=Prevail BAA-PRV=Prevail BAA Compliant ³ TAA-PRV=Prevail TAA Compliant ³	C15=(1 LED) 7,100 Nominal Lumens C25=(2 LEDs) 13,100 Nominal Lumens C40=(2 LEDs) 17,100 Nominal Lumens C60=(2 LEDs) 20,000 Nominal Lumens					
PRV-XL=Prevail XL BAA-PRV-XL=Prevail XL BAA Compliant ³ TAA-PRV-XL=Prevail XL TAA Compliant ³	C75=(4 LED) 26,100 Nominal Lumens C100=(4 LED) 31,000 Nominal Lumens C125=(4 LED) 36,000 Nominal Lumens C150=(6 LED) 41,100 Nominal Lumens C175=(6 LED) 48,600 Nominal Lumens					

Options (Add as Suffix)

Accessories (Order Separately) ^{20,21}

7030=70 CRI / 3000K CCT ⁷ 7050=70 CRI / 5000K CCT ⁷ HSS=House Side Shield ⁸ L90=Optics Rotated 90° Left R90=Optics Rotated 90° Right 10K=10kV UL 1449 Fused Surge Protective Device 20MSP=20kV MOV Surge Protective Device 20K=Series 20kV UL 1449 Surge Protective Device HA=50°C High Ambient Temperature ⁹ CC=Coastal Construction ¹⁰ PER=NEMA 3-PIN Twistlock Photocontrol Receptacle ¹¹ PER7=NEMA 7-PIN Twistlock Photocontrol Receptacle ¹¹ MS/DIM-L08=Dimming Motion and Daylight Sensor, IR Remote Programmable, < 8' Mounting ^{12,13} MS/DIM-L20=Dimming Motion and Daylight Sensor, IR Remote Programmable, 8' - 20' Mounting ^{12,13} MS/DIM-L40=Dimming Motion and Daylight Sensor, IR Remote Programmable, 21' - 40' Mounting ^{12,13}	SPB1=Dimming Motion and Daylight Sensor, Bluetooth Programmable, < 8' Mounting ^{12,14} SPB2=Dimming Motion and Daylight Sensor, Bluetooth Programmable, 8' - 20' Mounting ^{12,14} SPB4=Dimming Motion and Daylight Sensor, Bluetooth Programmable, 21' - 40' Mounting ^{12,14} ZW=Wavelinx-enabled 4-PIN Twistlock Receptacle ¹² ZD=SR Driver-enabled 4-PIN Twistlock Receptacle ¹² ZW-SWPD4XX=WaveLinX, Dimming Motion and Daylight, WAC Programmable, 7' - 15' Mounting ^{12,15,16,17} ZW-SWPD5XX=WaveLinX, Dimming Motion and Daylight, WAC Programmable, 15' - 40' Mounting ^{12,15,16,17} ZD-SWPD4XX=WaveLinX, SR Driver, Dimming Motion and Daylight, WAC Programmable, 7' - 15' Mounting ^{12,15,16,17} ZD-SWPD5XX=WaveLinX, SR Driver, Dimming Motion and Daylight, WAC Programmable, 15' - 40' Mounting ^{12,15,16,17} (See Table Below)=LumenSafe Integrated Network Security Camera ^{16,19}	PRVSA-XX=Standard Arm Mounting Kit ²² PRVMA-XX=Mast Arm Mounting Kit ²² PRVWM-XX=Wall Mount Kit ²² PRV-ADJA-XX=Adjustable Arm - Pole Mount Kit ²² PRV-ADJS-XX=Adjustable Arm - Slipfitter Kit ²² PRV-ADJA-WM-XX=Adjustable Arm - Wall Mount Kit ²² PRVXLSA-XX=Standard Arm Mounting Kit ¹⁸ PRVXLSMA-XX=Mast Arm Mounting Kit ¹⁸ PRVXLWM-XX=Wall Mount Kit ¹⁸ PRV-XL-ADJA-XX=Adjustable Arm - Pole Mount Kit ¹⁸ PRV-XL-ADJS-XX=Adjustable Arm - Slipfitter Kit ¹⁸ PRV-XL-ADJA-WM-XX=Adjustable Arm - Wall Mount Kit ¹⁸ MA1010-XX=Single Tenon Adapter for 3-1/2" O.D. Tenon MA1011-XX=2@180° Tenon Adapter for 3-1/2" O.D. Tenon MA1017-XX=Single Tenon Adapter for 2-3/8" O.D. Tenon MA1018-XX=2@180° Tenon Adapter for 2-3/8" O.D. Tenon	SRA238=Tenon Adapter from 2-3/8" to 3" PRV/COB-FDV=Full Drop Visor ²³ PRVXL/COB-FDV=Full Drop Visor ¹⁸ HS/VERD=House Side Shield ^{8,24} VGS-F/B=Vertical Glare Shield, Front/Back ²⁴ VGS-SIDE=Vertical Glare Shield, Side ²⁴ OA/RA1013=Photocontrol Shorting Cap OA/RA1014=NEMA Photocontrol - 120V OA/RA1016=NEMA Photocontrol - Multi-Tap 105-285V OA/RA1201=NEMA Photocontrol - 347V OA/RA1027=NEMA Photocontrol - 480V FSIR-100=Wireless Configuration Tool for Occupancy Sensor ²⁵ SWPD4-XX=WaveLinX Sensor, Dimming Motion and Daylight, WAC Programmable, 7' - 15' Mounting ^{15,16,17,26} SWPD5-XX=WaveLinX Sensor, Dimming Motion and Daylight, WAC Programmable, 15' - 40' Mounting ^{15,16,17,26} WOLC-7P-10A=WaveLinX Outdoor Control Module (7-PIN) ²⁷
---	--	--	--

NOTES:

- DesignLights Consortium® Qualified. Refer to www.designlights.org Qualified Products List under Family Models for details.
- Customer is responsible for engineering analysis to confirm pole and fixture compatibility for all applications. Refer to installation instructions IB500002EN and pole white paper WP513001EN for additional support information.
- Only product configurations with these designated prefixes are built to be compliant with the Buy American Act of 1933 (BAA) or Trade Agreements Act of 1979 (TAA), respectively. Please refer to [DOMESTIC PREFERENCES](http://www.designlights.org) website for more information. Components shipped separately may be separately analyzed under domestic preference requirements.
- Standard 4000K CCT and 70CRI.
- 480V not to be used with ungrounded or impedance grounded systems.
- DuraVolt drivers feature added protection from power quality issues such as loss of neutral, transients and voltage fluctuations. Visit www.signify.com/duravolt for more information.
- Use dedicated IES files on product website for non-standard CCTs.
- House Side Shield not suitable with T5 distribution. Not available with PRV-C60 lumen package.
- Not available with PRV-C60 lumen package. Not available with PRV-P-C25 lumen package.
- Salt spray tested to over 5,000-hours per ASTM B117 with a scribe rating of 9 per ASTM D1654. Also achieves 7,000-hour rating per ASTM B117 with a scribe rating of 4 per ASTM D1654. Extended lead times may apply.
- If DuraVolt (DV) is specified, use a photocontrol that matches the input voltage used.
- Controls system is not available in combination with a photocontrol receptacle (PER or PER7) or another controls system (MS, SPB, ZD, or ZW). Option not available with DuraVolt (DV) voltage option.
- Utilizes the Wattstopper sensor FSP-211. Sensor color white unless specified otherwise via PDR. To field-configure, order FSIR-100 accessory separately.
- Utilizes the Wattstopper sensor FSP-3XX series. Sensor color determined by product finish. See Sensor Color Reference Table. Field-configures via mobile application. See Controls section for details.
- Sensor passive infrared (PIR) may be overly sensitive when operating below -20°C (-4°F).
- For the device to be field-configurable, requires WAC Gateway components WAC-PoE and WPOE-120 in appropriate quantities. Only compatible with WaveLinX system and software and requires system components to be installed for operation. See website for more Wavelinx application information.
- Replace XX with sensor color (WH, BZ, or BK).
- Only available in PRV-XL configurations C75, C100, C125, C150, or C175.
- Not available with 347V, 480V, DV, or HA options. Consult LumenSafe system product pages for additional details and compatibility information.
- Replace XX with paint color.
- For BAA or TAA requirements, Accessories sold separately will be separately analyzed under domestic preference requirements. Consult factory for further information.
- Only for use with PRV and PRV-P.
- Only for use with PRV. Not available for use with PRV-P or PRV-XL configurations.
- Must order one per optic/LED when ordering as a field-installable accessory (1, 2, 4, or 6).
- This tool enables adjustment to Motion Sensor (MS) parameters including high and low modes, sensitivity, time delay, cutoff and more. Consult your lighting representative for more information.
- Requires 4-PIN twistlock receptacle (ZD or ZW) option.
- Requires 7-PIN NEMA twistlock photocontrol receptacle (PER7) option. The WOLC-7 cannot be used in conjunction with other controls systems (MS, ZD, ZW or LWR). Operates on 120-347V input voltages.

LumenSafe Integrated Network Security Camera Technology Options (Add as Suffix)

Product Family	Camera Type	Data Backhaul		
L=LumenSafe Technology 	H=Dome Camera, High Res Z=Dome Camera, Remote PTZ	C=Cellular, Customer Installed SIM Card A=Cellular, Factory Installed AT&T SIM Card	V=Cellular, Factory Installed Verizon SIM Card S=Cellular, Factory Installed Sprint SIM Card	E=Ethernet Networking

Stock Ordering Information

Product Family ¹	Light Engine	Voltage	Distribution
PRVS=Prevail	C15=(1 LED) 7,100 Nominal Lumens C25=(2 LEDs) 13,100 Nominal Lumens C40=(2 LEDs) 17,100 Nominal Lumens C60=(2 LEDs) 20,000 Nominal Lumens	UNV=Universal (120-277V) 347=347V ²	T3=Type III T4=Type IV
PRVS-XL=Prevail XL	C75=(4 LED) 26,100 Nominal Lumens C100=(4 LED) 31,000 Nominal Lumens C125=(4 LED) 36,000 Nominal Lumens C150=(6 LED) 41,100 Nominal Lumens C175=(6 LED) 48,600 Nominal Lumens		

NOTES:

- All stock configurations are standard 4000K/70CRI, bronze finish, and include the standard versatile mounting arm.
- Only available in PRVS configurations C15, C25, C40 or C60.

Mounting Details

Pole Mount Arm (PRV & PRV-P)

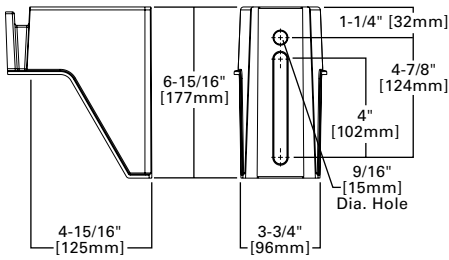

Pole Mount Arm (PRV-XL)

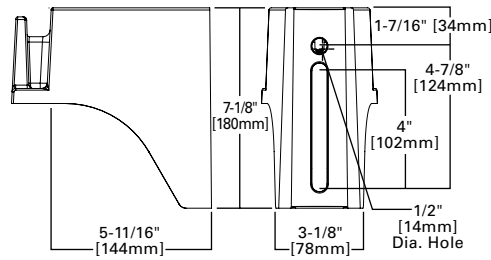

Versatile Mount System

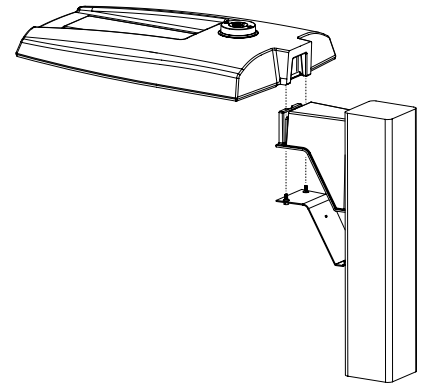

Wall Mount (PRV & PRV-P)

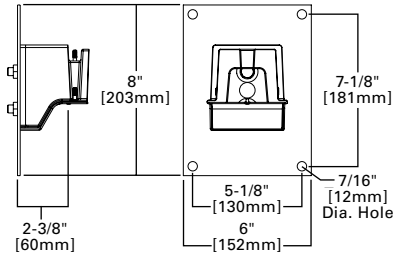

Wall Mount (PRV-XL)

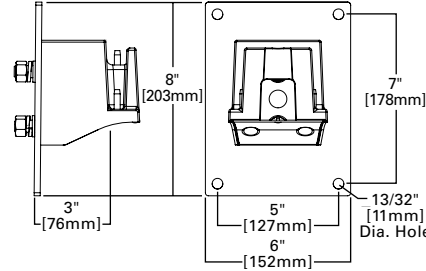

Mast Arm Mount (PRV & PRV-P)

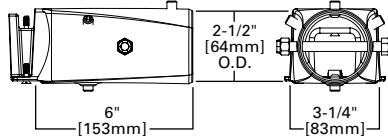

Mast Arm Mount (PRV-XL)

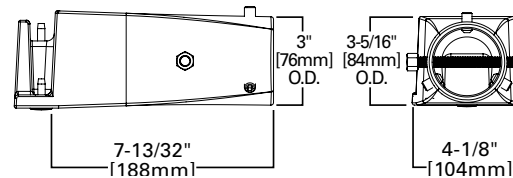

Adjustable Pole Mount Arm (PRV & PRV-P)

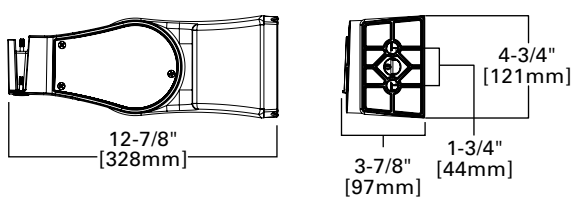

Adjustable Pole Mount Arm (PRV-XL)

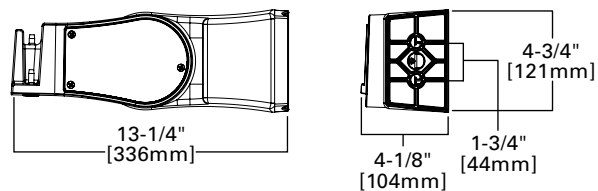

Adjustable Wall Mount (PRV & PRV-P)

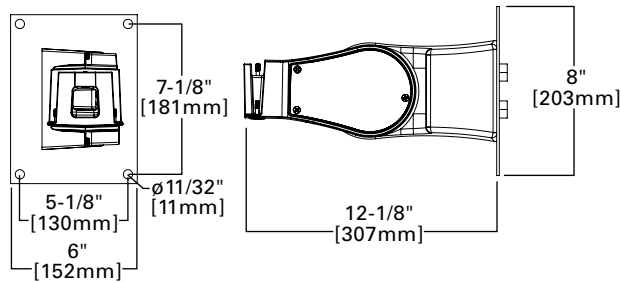

Adjustable Wall Mount (PRV-XL)

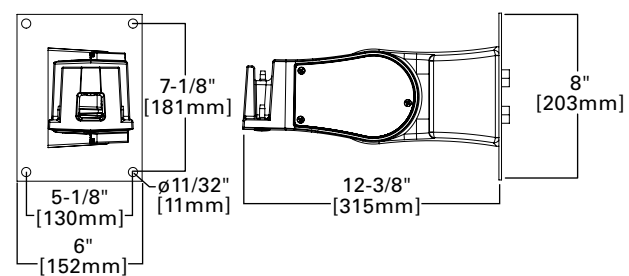

Adjustable Slipfitter (PRV & PRV-P)

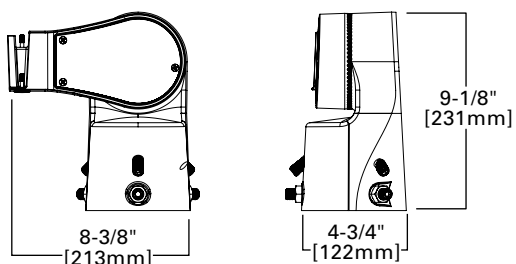

Adjustable Slipfitter (PRV-XL)

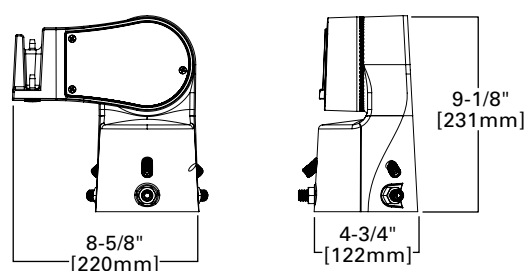

Mounting Details

Mounting Configurations and EPAs

NOTE: For 2 PRV's mounted at 90°, requires minimum 3" square or 4" round pole for fixture clearance. For 2 PRV-XL's mounted at 90°, requires minimum 4" square or round pole for fixture clearance. Customer is responsible for engineering analysis to confirm pole and fixture compatibility for applications.

Housing Size	Tilt Angle (Degrees)	Arm Mount Single	Arm Mount 2 @ 180°	Arm Mount 2 @ 90°	Arm Mount 3 @ 90°	Arm Mount 4 @ 90°
Prevail Petite	0°	0.54	1.08	0.84	1.38	1.38
	60°	1.68	1.85	2.42	3.15	3.30
Prevail	0°	0.92	1.35	1.42	1.63	1.63
	60°	2.20	2.40	3.05	3.88	4.07
	60° + Full Drop Visor	2.20	2.40	3.25	4.28	4.47
Prevail XL	0°	1.12	2.25	2.13	2.52	2.52
	60°	3.99	4.30	5.26	6.51	6.79
	60° + Full Drop Visor	3.99	4.30	5.59	7.17	7.49

Optical Configurations

PRV-P-C10/C15/C20/C25
(4,900/6,900/9,800/11,800
Nominal Lumens)

PRV-C15
(7,100 Nominal Lumens)

PRV-C25/C40/C60
(13,100/17,100/20,000
Nominal Lumens)

PRV-XL-C75/C100/C125
(26,100/31,000/36,300 Nominal Lumens)

PRV-XL-C150/C175
(41,100/48,600 Nominal Lumens)

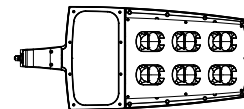
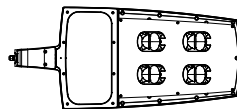
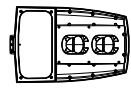
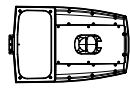

Optical Distributions

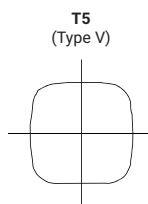
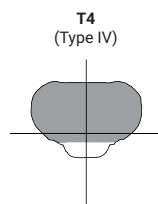
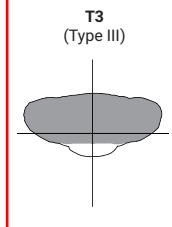
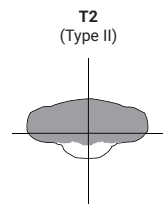

■ = Distribution with House Side Shield (HSS)
□ = Optical Distribution

Product Specifications

Construction

- Single-piece die-cast aluminum housing
- Tethered die-cast aluminum door

Optics

- Dark Sky Approved (3000K CCT and warmer only)
- Precision molded polycarbonate optics

Electrical

- -40°C minimum operating temperature
- 40°C maximum operating temperature
- >.9 power factor
- <20% total harmonic distortion
- Class 1 electronic drivers have expected life of 100,000 hours with <1% failure rate
- 0-10V dimming driver is standard with leads external to the fixture
- Standard MOV surge protective device designed to withstand 10kV of transient line surge

Mounting

- Versatile, patented, standard mount arm accommodates multiple drill patterns ranging from 1-1/2" to 4-7/8" (Type M drilling recommended for new installations)
- A knock-out on the standard mounting arm enables round pole mounting
- Adjustable pole and wall mount arms adjust in 5° increments from 0° to 60°; Downward facing orientation only (Type N drilling required for ADJA mount)
- Adjustable slipfitter arm adjusts in 5° increments from -5° to 85°; Downward facing orientation only
- Adjustable Arms: 1.5G vibration rated
- Prevail and Prevail Petite: 3G vibration rated
- Prevail XL Mast Arm: 3G vibration rated
- Prevail XL Standard Arm: 1.5G vibration rated

Typical Applications

- Parking lots, Walkways, Roadways and Building Areas

Finish

- Five-stage super TGIC polyester powder coat paint, 2.5 mil nominal thickness
- Finish is compliant to 3,000 hour salt spray standard (per ASTM B117)

Shipping Data

- Prevail Petite: 18 lbs. (7.94 kgs.)
- Prevail: 20 lbs. (9.09 kgs.)
- Prevail XL: 45 lbs. (20.41 kgs.)

Warranty

- Five year limited warranty, consult website for details. www.cooperlighting.com/legal

Energy and Performance Data

[View PRV-P IES files](#)
[View PRV IES files](#)
[View PRV-XL IES files](#)

Power and Lumens

Product Family	Prevail Petite				Prevail				Prevail XL					
Light Engine	C10	C15	C20	C25	C15	C25	C40	C60	C75	C100	C125	C150	C175	
Power (Watts)	35	49	73	94	52	96	131	153	176	217	264	285	346	
Input Current @ 120V (A)	0.29	0.41	0.61	0.79	0.43	0.80	1.09	1.32	1.50	1.84	2.21	2.38	2.92	
Input Current @ 277V (A)	0.13	0.18	0.27	0.35	0.19	0.35	0.48	0.57	0.66	0.82	0.97	1.04	1.25	
Input Current @ 347V (A)	0.11	0.16	0.23	0.29	0.17	0.30	0.41	0.48	0.54	0.66	0.79	0.84	1.02	
Input Current @ 480V (A)	0.08	0.12	0.17	0.22	0.12	0.22	0.30	0.35	0.40	0.48	0.57	0.62	0.74	
Distribution ¹														
Type II	4000K Lumens	4,775	6,717	9,542	11,521	7,123	13,205	17,172	20,083	26,263	31,231	36,503	41,349	48,876
	BUG Rating	B1-U0-G1	B1-U0-G1	B2-U0-G2	B2-U0-G2	B2-U0-G2	B2-U0-G2	B3-U0-G3	B3-U0-G3	B3-U0-G3	B3-U0-G4	B4-U0-G4	B4-U0-G4	B4-U0-G5
	Lumens per Watt	138	137	131	122	137	138	131	131	149	144	138	145	141
	3000K Lumens ¹	4,869	6,595	9,369	11,312	6,994	12,965	16,860	19,718	25,786	30,664	35,840	40,598	47,989
Type III	4000K Lumens	4,782	6,727	9,556	11,538	7,111	13,183	17,144	20,050	26,120	31,061	36,304	41,124	48,610
	BUG Rating	B1-U0-G2	B1-U0-G2	B2-U0-G3	B2-U0-G3	B1-U0-G2	B2-U0-G3	B3-U0-G4	B3-U0-G4	B3-U0-G5	B3-U0-G5	B3-U0-G5	B4-U0-G5	B4-U0-G5
	Lumens per Watt	138	137	131	123	137	137	131	131	148	143	138	144	140
	3000K Lumens ¹	4,695	6,605	9,383	11,329	6,982	12,944	16,832	19,686	25,646	30,497	35,645	40,377	47,727
Type IV	4000K Lumens	4,880	6,865	9,752	11,774	7,088	13,140	17,087	19,984	26,098	31,035	36,274	41,089	48,569
	BUG Rating	B1-U0-G2	B1-U0-G2	B2-U0-G3	B2-U0-G3	B1-U0-G3	B2-U0-G4	B2-U0-G4	B3-U0-G5	B3-U0-G5	B3-U0-G5	B3-U0-G5	B3-U0-G5	B4-U0-G5
	Lumens per Watt	141	140	134	125	136	137	130	131	148	143	137	144	140
	3000K Lumens ¹	4,792	6,740	9,575	11,561	6,959	12,901	16,777	19,621	25,624	30,471	35,615	40,343	47,687
Type V	4000K Lumens	5,067	7,128	10,126	12,226	7,576	14,045	18,264	21,360	28,129	33,450	39,097	44,287	52,349
	BUG Rating	B3-U0-G2	B3-U0-G2	B4-U0-G3	B4-U0-G3	B3-U0-G3	B4-U0-G3	B4-U0-G4	B5-U0-G4	B5-U0-G5	B5-U0-G5	B5-U0-G5	B5-U0-G5	B5-U0-G5
	Lumens per Watt	146	145	139	130	146	146	139	140	160	154	148	155	151
	3000K Lumens ¹	4,975	6,999	9,942	12,004	7,438	13,790	17,932	20,972	27,618	32,843	38,387	43,483	51,398

NOTES:
 1. For 3000K, 5000K or HSS data, refer to published IES files.

Lumen Maintenance

Configuration	TM-21 Lumen Maintenance (50,000 Hours)	Theoretical L70 (Hours)
Prevail and Prevail Petite at 25°C	91.30%	> 194,000
Prevail and Prevail Petite at 40°C	87.59%	> 134,000
Prevail XL at 25°C	91.40%	> 204,000
Prevail XL at 40°C	89.41%	> 158,000

Sensor Color Reference Table (SPBx)

Housing Finish	Sensor Color
AP =Grey	Grey
BZ =Bronze	Bronze
BK =Black	Black
DP =Dark Platinum	Grey
GM =Graphite Metallic	Black
WH =White	White

Lumen Multiplier

Ambient Temperature	Lumen Multiplier
10°C	1.02
15°C	1.01
25°C	1.00
40°C	0.99

Control Options

0-10V This fixture provides 0-10V dimming wire leads for use with a lighting control panel or other control method.

Photocontrol (PER and PER7) Photocontrol receptacles provide a flexible solution to enable “dusk-to-dawn” lighting by sensing light levels. Advanced control systems compatible with NEMA 7-PIN standards can be utilized with the PER7 receptacle.

Dimming Occupancy Sensor (SPB, MS/DIM-LXX and MS-LXX) These sensors are factory installed in the luminaire housing. When the SPB or MS/DIM sensor options are selected, the luminaire will dim down after five minutes of no activity detected. When activity is detected, the luminaire returns to full light output. When a sensor for ON/OFF operation (MS-LXX) is selected, the luminaire will turn off after five minutes of no activity. These occupancy sensors include an integral photocell for “dusk-to-dawn” control or “daylight harvesting.” Factory default is enabled for the MS sensors and disabled for the SPB. SPB motion sensors require the Sensor Configuration mobile application by Wattstopper to change factory default dimming level, time delay, sensitivity and other parameters. Available for iOS and Android devices. The SPB sensor is factory preset to dim down to approximately 10% power with a time delay of five minutes.

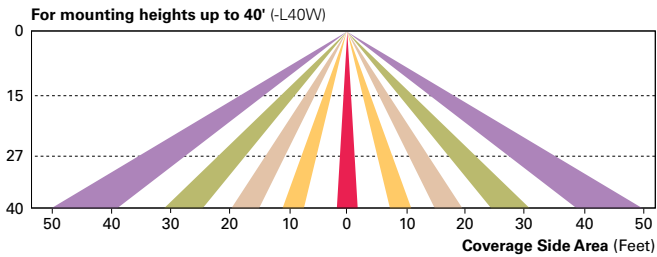
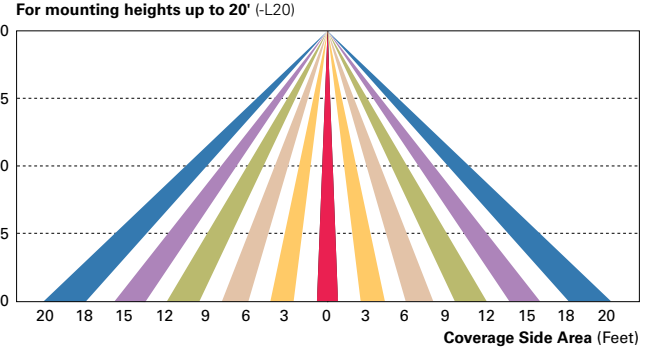
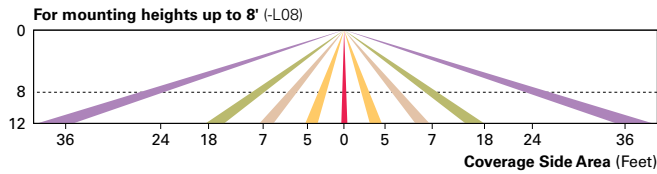

WaveLinx Wireless Control and Monitoring System Available in 7-PIN or 4-PIN configurations, the WaveLinx Outdoor control platform operates on a wireless mesh network based on IEEE 802.15.4 standards enabling wireless control of outdoor lighting. At least one Wireless Area Controller (WAC) is required for full functionality and remote communication (including adjustment of any factory pre-sets).

WaveLinx Outdoor Control Module (WOLC-7P-10A) A photocontrol that enables astronomic or time-based schedules to provide ON, OFF and dimming control of fixtures utilizing a 7-PIN receptacle. The out-of-box functionality is ON at dusk and OFF at dawn.

WaveLinx Wireless Sensor (SWPD4 and SWPD5) These outdoor sensors offer passive infrared (PIR) occupancy sensing and a photocell for closed-loop daylight sensing. These sensors can be factory installed or field-installed via simple, tool-less integration into luminaires equipped with the Zhaga Book 18 compliant 4-PIN receptacle (ZD or ZW). These sensors are factory preset to dim down to approximately 50 percent power after 15 minutes of no activity detected, and the photocell for “dusk-to-dawn” control is default enabled. A variety of sensor lenses are available to optimize the coverage pattern for mounting heights from 7'-40'.

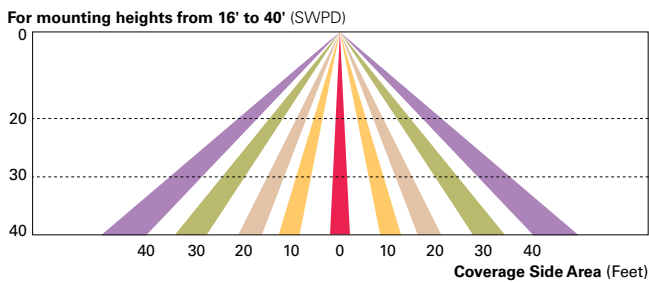

LumenSafe (LD) The LumenSafe integrated network camera is a streamlined, outdoor-ready camera that provides high definition video surveillance. This IP camera solution is optimally designed to integrate into virtually any video management system or security software platform of choice. No additional wiring is needed beyond providing line power to the luminaire. LumenSafe features factory-installed power and networking gear in a variety of networking options allowing security integrators to design the optimal solution for active surveillance.



DATE: _____ TYPE: _____

NAME: _____

PROJECT: _____

Halogen/incandescent

P5675-31

Cylinder

5" up/down cylinder with heavy duty aluminum construction and die cast wall bracket. Powder coated finish. Wet location listed when used with P8799 top cover lens

Category: Outdoor

Finish: Black (powdercoat)

Construction: Cast aluminum construction
metal shade



Width: 5"
Height: 14"
Depth: 7-7/8"
H/CTR: 7"

MOUNTING	ELECTRICAL	LAMPING	ADDITIONAL INFORMATION
Wall mounted Mounting strap for outlet box included Back plate covers a standard 4" hexagonal recessed outlet box 4-1/2" sq.	Pre-wired 6" of wire supplied 120V	Quantity: 2 75W PAR-30 or BR-30 Medium base porcelain sockets With two General Electric retrofit lamps #LED12P30RW83025	cCSAus Damp location listed location listed 1 year warranty Companion fixtures are available

FLL LED FLOODLIGHT

Cat.#

Job

Type



HUBBELL
Outdoor Lighting

Approvals

SPECIFICATIONS

Intended Use:

Large LED flood with beam distribution for lighting applications such as safety/security, facade, area, or signs

Construction:

- Corrosion resistant, rugged die-cast aluminum housing with powder coat paint finish
- Tempered glass lens protects LEDs and allows for cleaning/debris removal
- Vented housing isolates LED module from driver, maximizing product life and performance
- Visor, louver and vandal accessories available

LED:

- 28 high power LED's (Stock/MTO)
- 42 high power LED's (MTO)
- 140 high power LED's (Stock)
- Ambient operating temperature -35°C to 40°C
- Stock Versions: 4000K and 5000K CCT
- MTO Versions: 3000K nominal with 80 CRI, 4000K and 5000K CCT nominal with 70 CRI

Optical/Electrical:

- Variety of NEMA distributions - N (3x3), M (4x4), RM (5x4) and W (6x6) - for wide range of lighting applications; Stock version Wide (6x6) only
- 120-277V operation, 50/60Hz, 95W, 1050mA, 100 LPW (Stock/MTO - 28LED)
- 120-277V operation, 50/60Hz, 150W, 158mA, 98 LPW (Stock only - 140LED)

Optical/Electrical (Cont.)

- 120-277V, 347V, and 480V operation, 50/60Hz, 95W, 700mA, up to 119 LPW (MTO only - 42LED)
- IP65 fixture, Driver IP66 and RoHS compliant
- 10KV surge protector comes standard
- 0-10V dimming driver standard, continuous dimming option to have leads pulled out for easy connection

Installation:

- Knuckle mount 15' aiming angle increments for precise aiming and control, fits 2-3/8" tenons or pipes
- Heavy duty steel yoke with adjustable stainless steel hardware, mounting holes for one center - 3/4" bolt or two side - 3/8" bolts
- 3' SE00W cord with yoke mount

Listings:

- IP65, Listed to UL1598 for use in wet locations.
- DLC Qualified (4000K and 5000K models only); Consult DLC website for more details: <https://www.designlights.org/QPL>
- EPA = 1.0ft²

Warranty:

For more information visit:
<http://www.hubbellighting.com/resources/warranty/>

PRODUCT IMAGE(S)



DIMENSIONS

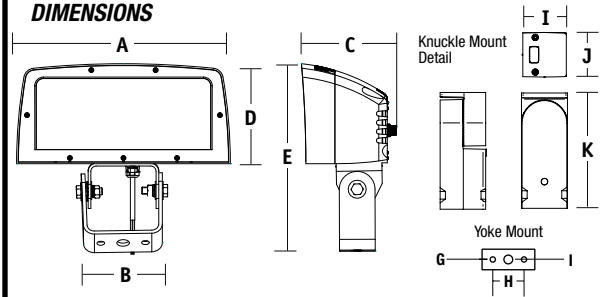

A	B	C	D	E	F	G	H	I	J	K
14.9"	5.5"	6.0"	7.0"	14.57"	17.32"	7/8"	3-1/8"	3.0"	2.9"	7.57"
378mm	140mm	152mm	177mm	370mm	14mm	22mm	79mm	77mm	75mm	192mm

CERTIFICATIONS/LISTINGS



SHIPPING INFORMATION

Catalog Number	G.W.(kg)/CTN	Carton Dimensions		
		Length Inch (cm)	Width Inch (cm)	Height Inch (cm)
FLL (Single Carton)	25 (12.3) lbs	17.72" (45)	13.0" (33)	10.00" (25.5)

Carton dimensions for shipping purposes only

ORDERING INFORMATION - STOCK VERSION

Catalog Number	Mount	Max Candle Power	Beam Pattern	Wattage	# Drivers/ Current	Voltage	Color Temperature/ CRI	Lumens	LPW	Weight lbs. (kg)	Finish
FLL-95-Y	Yoke	7789	Wide	97w	1@700mA	120-277V	5000K/70	10600	109	20 (9.0)	Bronze
FLL-95-4K-Y	Yoke	7265	Wide	97w	1@700mA	120-277V	4000K/70	10173	105	20 (9.0)	
FLL-150-4K-U-Y	Yoke	5627	Wide	150w	1@158mA	120-277V	4000K/80	14665	98	20 (9.0)	
FLL-150-5K-U-Y	Yoke	5731	Wide	150w	1@158mA	120-277V	5000K/80	14764	98.4	20 (9.0)	
FLL-150-4K-U-K	Knuckle	5627	Wide	150w	1@158mA	120-277V	4000K/80	14665	98	20 (9.0)	
FLL-150-5K-U-K	Knuckle	5731	Wide	150w	1@158mA	120-277V	5000K/80	14764	98.4	20 (9.0)	

ORDERING INFORMATION - MADE TO ORDER

FLL - [] - [] - [] - 7 - [] - [] - [] - [] - [] - [] - []

FAMILY	# LEDS	WATTS	CCT	CRI	DISTRIBUTION	VOLTAGE	MOUNTING	FINISH	CONTROL OPTION	OPTIONS
FLL	28L 28 LED 42L 42 LED	95 95W	3K 3000K 4K 4000K 5K 5000K	7 70 CRI	N 3x3 M 4x4 RM 5x4 W 6x6	U 120V-277V 1 120V 2 208V 3 240V 4 277V 5 ¹ 480V F ¹ 347V	K Knuckle Y Yoke	DB Bronze BL Black WH White GR Gray PS Platinum silver CC Custom Color	PC Photocontrol (voltage specified and determined by voltage field) CD Continuous dimming	F Fusing 120 or 277V only (determined by voltage field)

¹ 42L only



Hubbell Outdoor Lighting • 701 Millennium Boulevard • Greenville, SC 29607 • Phone: 864-678-1000

Due to our continued efforts to improve our products, product specifications are subject to change without notice.

© 2017 HUBBELL OUTDOOR LIGHTING, All Rights Reserved • For more information visit our website: www.hubbelloutdoor.com • Printed in USA FLL-SPEC SEPTEMBER 20, 2017 10:28 AM

ACCESSORIES & REPLACEMENT PARTS - Order Separately

Catalog Number	Description
FLL-VISOR-DB	Bronze top visor (Tap holes in lens frame for field installation)
93053186	FLL28, 95w, 120-277V Dimming driver, 1050mA (1 Qty)
93053187	FLL140, 95w, 120-277V Dimming driver, 700mA (1 Qty)
FLL-LOUVER-BL	Black adjustable louver
ARF-SPC	Polycarbonate vandal shield
4024C	Steel slipfitter for 2" pipe, 2 3/8" OD yoke mount, bronze finish
4040	Heavy-duty steel wall/pole bracket, bronze Lektrocote®



FLL-LOUVER-BL



ARF-SPC



FLL-VISOR-XX

PERFORMANCE DATA - Stock

# OF LEDS	DRIVE CURRENT (MILLIAMPS)	SYSTEM WATTS	DISTRIBUTION TYPE	4K (4000K nominal)				5K (5000K nominal)			
				NEMA	LUMENS	LPW	MAX BEAM CANDLEPOWER	LUMENS	LPW	MAX BEAM CANDLEPOWER	
28	1050mA	95W	W	6 x 6	8992	94.5	6805	9557	100.6	6935	
140	158mA	150W	W	7 x 7	14665	98	5627	14764	98.4	5731	

Lumen values are from photometric tests performed in accordance with IESNA LM-79-08. Data is considered to be representative of the configurations shown. Actual performance may differ as a result of end-user environment, application and inherent performance tolerances of the electrical components.

PERFORMANCE DATA - MTO

# OF LEDS	DRIVE CURRENT	SYSTEM WATTS	DIST. TYPE	NEMA	FIELD ANGLE H° X V°	5K (5000K nominal, 70 CRI)			4K (4000K nominal, 70 CRI)			3K (3000K nominal, 80 CRI)		
						LUMENS	LPW ¹	MAX BEAM CANDLEPOWER	LUMENS	LPW ¹	MAX BEAM CANDLEPOWER	LUMENS	LPW ¹	MAX BEAM CANDLEPOWER
28	1050mA	95W	W	6 x 6	107° x 107°	9557	100.6	6935	-	-	-	-	-	-
42	700mA	97W	N	3 x 3	32° x 32°	10860	114	91770	10263	108	85000	7473	80	63093
			M	4 x 4	53° x 53°	11400	119	46836	10335	108	33566	7654	81	26201
			RM	5 x 5	84° x 86°	9806	102	17388	8889	93	14733	6702	71	11395
			W	6 x 6	107° x 107°	10967	113	8024	10173	105	7265	7694	79	5475

Lumen values are from photometric tests performed in accordance with IESNA LM-79-08. Data is considered to be representative of the configurations shown. Actual performance may differ as a result of end-user environment and application.

PROJECTED LUMEN MAINTENANCE

AMBIENT TEMP.	OPERATING HOURS - FLL-28L					
	0	25,000	50,000	¹ TM-21-11 60,000	100,000	Calculated L70 (HOURS)
25°C / 77°F	1.00	0.94	0.91	0.88	0.79	>149,000
40°C / 104°F	1.00	0.92	0.90	0.87	0.76	>132,000

Nichia 219B, 1080mA, 85°C

AMBIENT TEMP.	OPERATING HOURS - FLL-42L					
	0	25,000	50,000	¹ TM-21-11 60,000	100,000	Calculated L70 (HOURS)
25°C / 77°F	1.00	0.98	0.96	0.96	0.94	>625,000
40°C / 104°F	1.00	0.96	0.94	0.93	0.90	>435,000

AMBIENT TEMP.	OPERATING HOURS - FLL-150					
	0	25,000	50,000	¹ TM-21-11 60,000	100,000	Calculated L70 (HOURS)
25°C / 77°F	1.00	0.96	0.94	0.93	0.89	>331,000
40°C / 104°F	1.00	0.95	0.92	0.90	0.85	>237,000

Nichia NFSL757DT-V1, 150mA, 85°C

ELECTRICAL DATA

# OF LEDS	NUMBER OF DRIVERS	DRIVE CURRENT (mA)	INPUT VOLTAGE (V)	CURRENT (Amps)	SYSTEM POWER (W)
28	1	1050mA	120	0.82	95
			277	0.36	95
42	1	700mA	120	.80	96
			277	.35	96
140	1	158mA	120	1.25	150
			277	0.54	150

LUMINAIRE AMBIENT TEMPERATURE FACTOR (LATF)

AMBIENT TEMPERATURE	LUMEN MULTIPLIER
0°C	1.02
10°C	1.01
20°C	1.00
25°C	1.00
30°C	1.00
40°C	0.99

Use these factors to determine relative lumen output for average ambient temperatures from 0-40°C (32-104°F).