



PHD

Pipe Hangers & Devices Strut Products & Accessories

Pictorial Brochure

PHD Manufacturing, Inc.

44018 Columbiana-Waterford Road
Columbiana, Ohio 44408

Phone: (800) 321-2736 • (330) 482-9256
Fax: (330) 482-2763 • www.phd-mfg.com



Pride

Honesty

Dedication

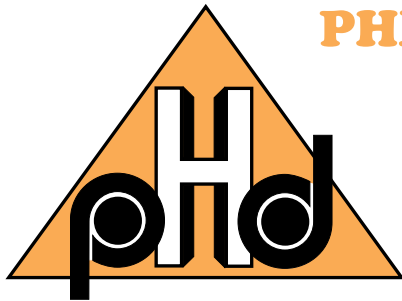

PHD Manufacturing, Inc.

44018 Columbiana-Waterford Road
Columbiana, Ohio 44408

Phone: (800) 321-2736 • (330) 482-9256
Fax: (330) 482-2763 • www.phd-mfg.com

YOUR LOCAL PHD REPRESENTATIVE IS:

PHD Manufacturing, Inc. was founded in 1972 by a group of industry veterans with strong management, financial, sales and manufacturing backgrounds. The entrepreneurial vision of this close group used the talents they acquired over the years to forge something special in a business that needed a different purpose. This core group continues to manage PHD today, ensuring the original commitment to quality and excellence.

Our 33 professional sales representatives supporting the plumbing, mechanical and electrical industries are ready to serve your needs. Our manufacturing plant in Columbiana, Ohio, together with our 24 stocking warehouses throughout the United States, gives us one of the largest inventories in the industry.

Many of our products are Underwriter's Laboratories listed and Factory Mutual approved. All PHD products are manufactured to meet or exceed industry standards set for their design and manufacture.

If you need a product not listed in this catalog, please call the factory or your local PHD representative to check availability and pricing.

PHD Plumbing & Mechanical Stock Locations PHD Electrical Stock Locations

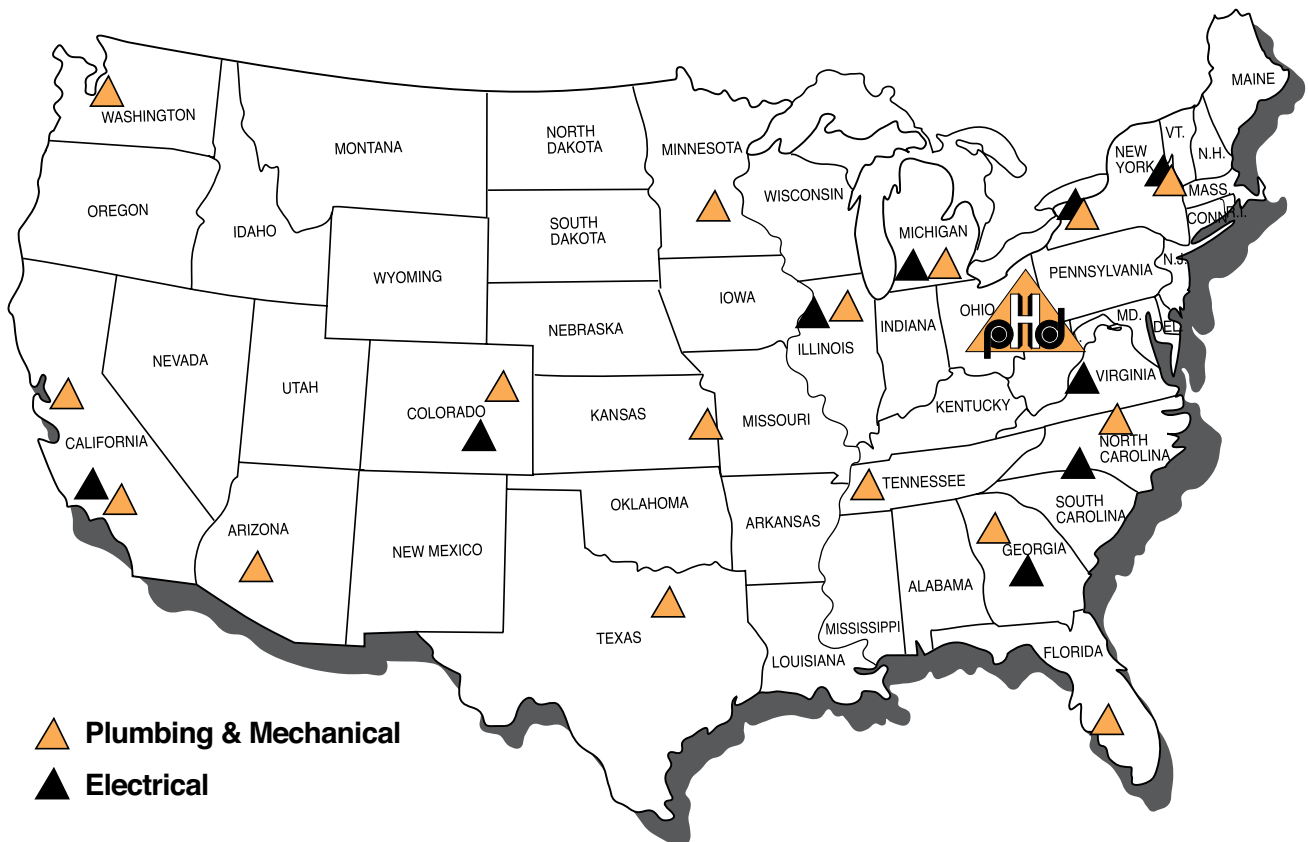



THREADED ACCESSORIES



Fig. 020
Rod Swivel
Attachment



Fig. 10
Threaded
Thread Rod

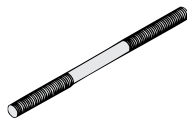

Fig. 15
Machine
Threaded Rod



Fig. 20 & 21
Continuous
Threaded Rod



Fig. 25
Extension Piece



Fig. 30
Eye Socket
Eye Nut



Fig. 35
Weldless



Fig. 37
Steel Eye
Socket

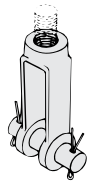

Fig. 38
Forged Steel
Clevis



Fig. 40
Coach Screw
Rod

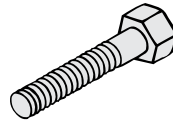

Fig. 41
Hex Head Bolt

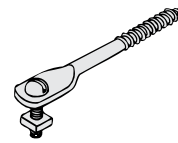

Fig. 43
Flattened End
Lag Screw



Fig. 44
Turnbuckle
Adjuster

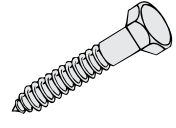

Fig. 45
Lag Screw

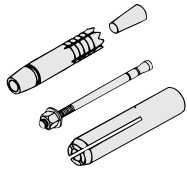

Fig. 47
Concrete
Anchors

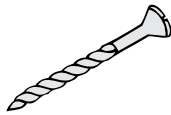

Fig. 48
Wood Drive
Screw

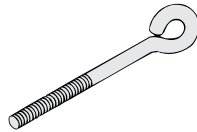

Fig. 50-55L
Eye Rod

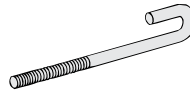

Fig. 60
J-Beam Bolt

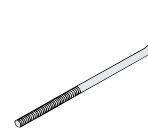

Fig. 70
Anchor Bolt

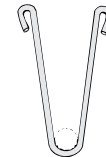

Fig. 80
U-Hook

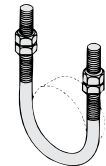

Fig. 90-95
U-Bolt

ROD COUPLINGS, HEX NUTS & WASHERS

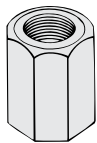

Fig. 100, 104, & 105
Rod Coupling

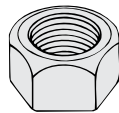

Fig. 110 & 110H
Hex Nut

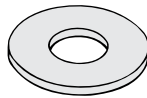

Fig. 130
Flat Washer

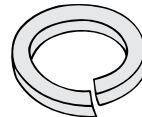

Fig. 134
Lock Washer

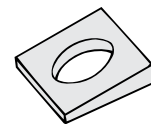

Fig. 135
Bevel Washer

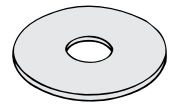

Fig. 136
Fender Washer

HANGERS, SHIELDS & INSULATION



Fig. 055
Surge
Restraint

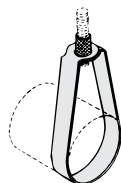

Fig. 141 & 151
Swivel Ring
Hanger

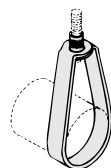

Fig. 143, 152 & 154
Copper Tubing Ring
Hanger
PVC Ring Hanger

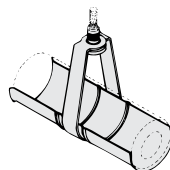

Fig. 145 & 155
Ring Hanger
With Shield

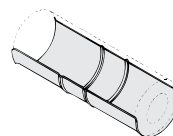

Fig. 160
Self Centering
Insulation Shield

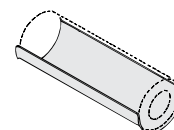

Fig. 170
Insulation
Shield

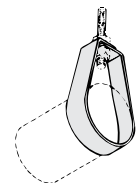
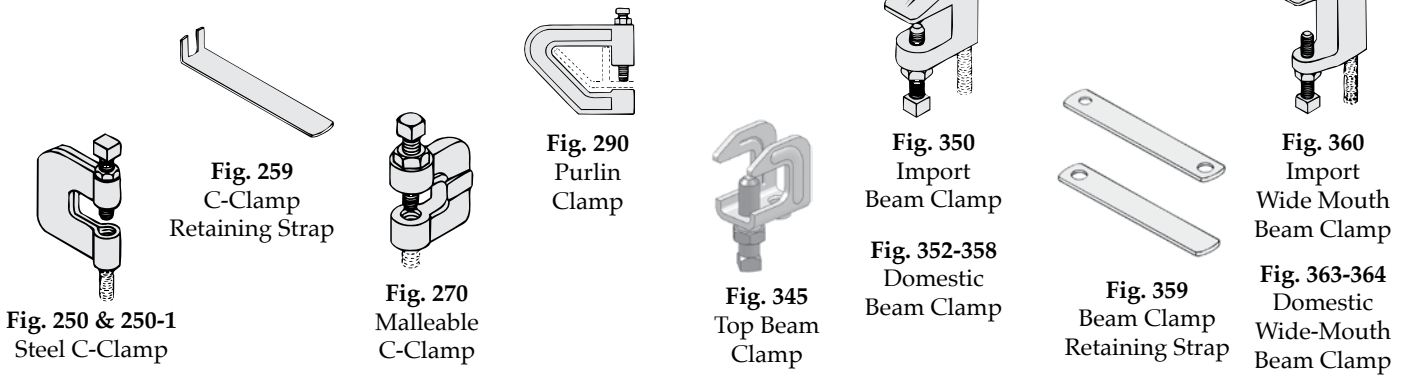

Fig. 180-183
Band Hanger

PIPE HANGERS & DEVICES



BEAM CLAMPS



CLEVIS HANGERS

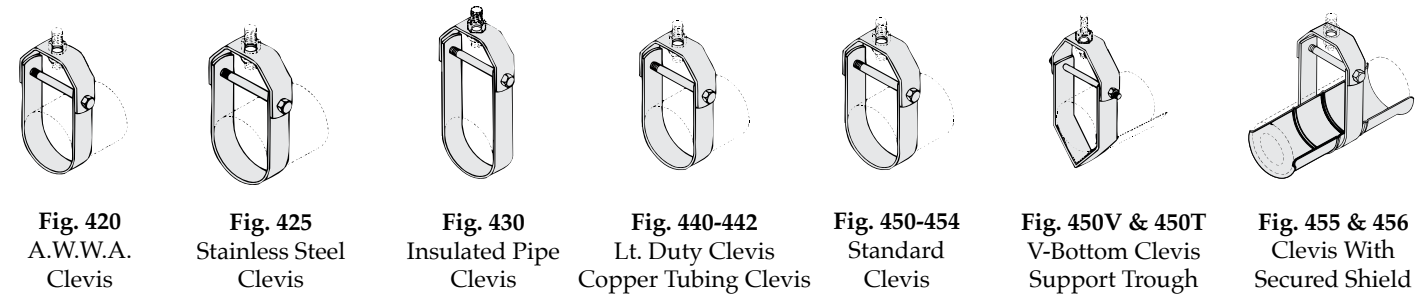

PIPE ROLLER SUPPORTS

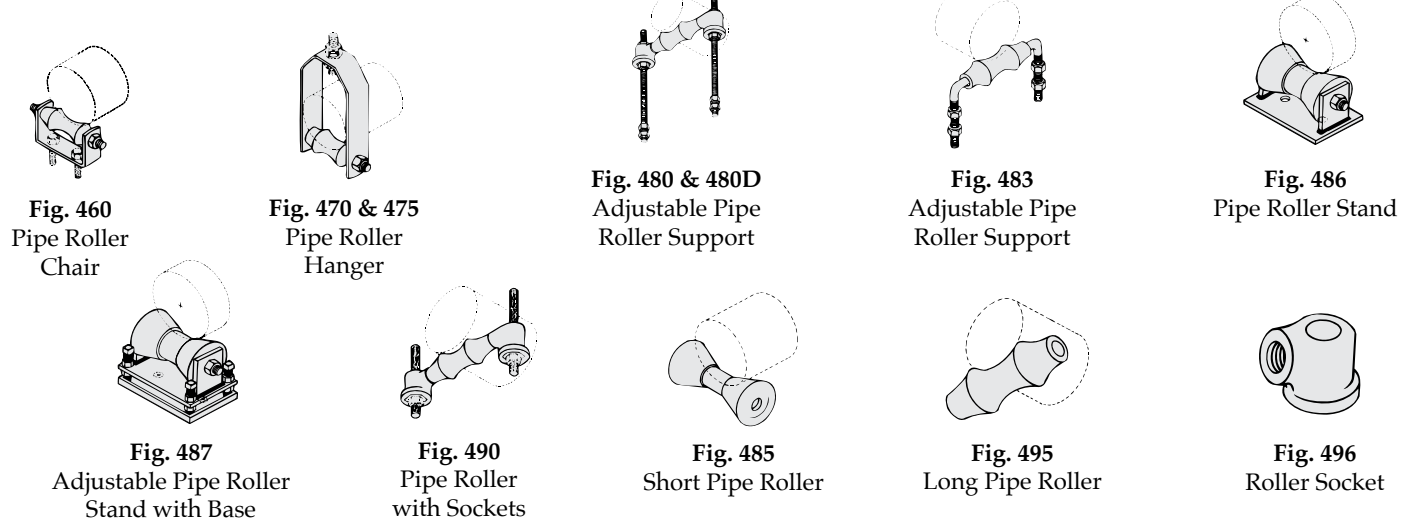

SPLIT RING HANGERS





PIPE CLAMPS

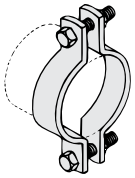

Fig. 520 & 521
Standard Pipe
Clamp

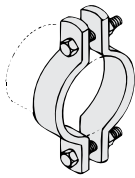

Fig. 522
Heavy Duty
Pipe Clamp

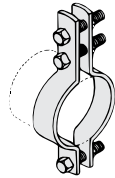

Fig. 525
Double Bolt
Pipe Clamp

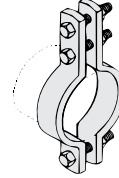

Fig. 526
Heavy Duty Double
Bolt Pipe Clamp

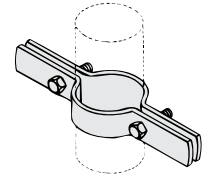

Fig. 550, 551 & 553
Riser Clamp

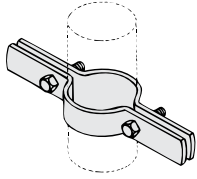

Fig. 552 & 554
Copper Tubing
Riser Clamp

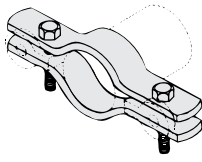

Fig. 580
Two Bolt Underground
Pipe Clamp

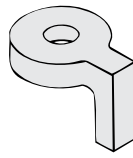

Fig. 585
Washer for
Fig. 580

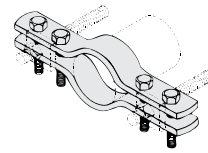

Fig. 590
Four Bolt Underground
Pipe Clamp

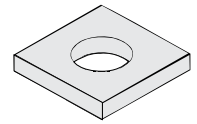

Fig. 595
Washer
for Fig. 590

CENTER LOAD CLAMPS

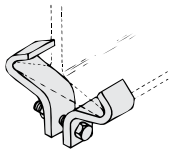

Fig. 610 & 620
Steel Center Load
Beam Clamp

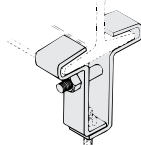

Fig. 625
Steel Center Load
Beam Clamp

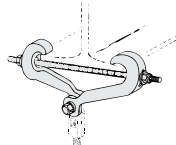

Fig. 630
Malleable Center Load
Beam Clamp



Fig. 632 & 633
Steel Center Load-
Beam Clamp

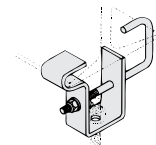

Fig. 635
Adjustable Steel
Beam Clamp

PIPE SADDLES, GUIDES & SLIDES



Fig. 651 & 653
Pipe Saddle

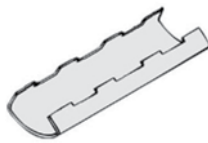

Fig. 654 & 655
Pipe Saddle



Fig. 656 & 658
Pipe Saddle

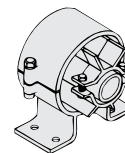

Fig. 670-678
Pipe Alignment Guide

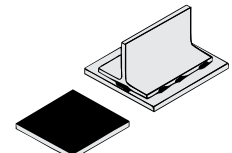

Fig. 690
Pipe Slide

J-HOOKS, STRAPS & CLAMPS

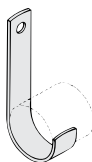

Fig. 810
Return Line
J-Hook

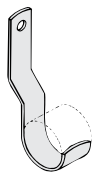

Fig. 820
Offset J-Hook

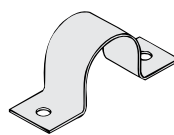

Fig. 825
Two Hole
Pipe Strap

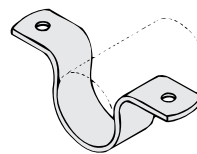

Fig. 830
Short Pipe
Strap

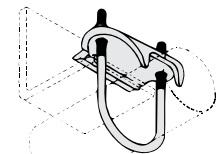

Fig. 840
Right Angle
Clamp

WALL BRACKETS

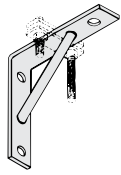

Fig. 850
Light Duty
Wall Bracket

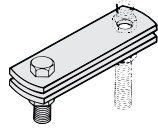

Fig. 850C
Clip for Fig. 850
Wall Bracket

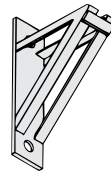

Fig. 855
Medium Duty
Wall Bracket

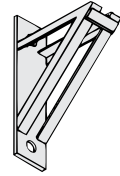

Fig. 860
Heavy Duty
Wall Bracket

PIPE SUPPORTS

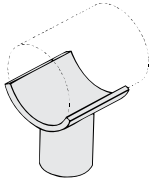

Fig. 870
Pipe Saddle Support
with Coupling

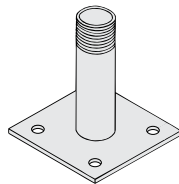

Fig. 871
Threaded Base
Stand



Fig. 874
Pipe Saddle Support
with Stud

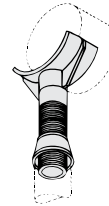

Fig. 875
Adjustable Pipe
Saddle Support

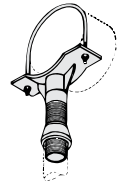

Fig. 876
Adjustable Pipe Saddle
Support with U-Bolt

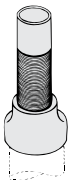

Fig. 877
Pipe Support
Adjuster

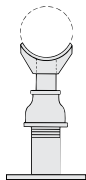

Fig. 878
Pipe Support
Adjuster

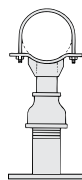

Fig. 879
Pipe Support
Adjuster

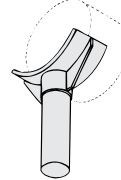

Fig. 880
Pipe Saddle
Support

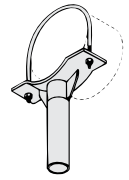

Fig. 882
Pipe Saddle
Support with U-Bolt

MISCELLANEOUS



Fig. 885
Adjustable
Q-Deck Insert

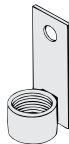

Fig. 890
Seismic Brace

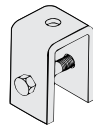

Fig. 900 & 900-1
Welded Beam
Attachment

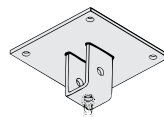

Fig. 903
Concrete Rod
Attachment Plate

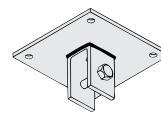

Fig. 904
Concrete
Clevis Plate

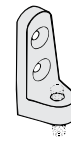

Fig. 905
Side Beam
Connector



Fig. 906
Steel Side
Beam Connector

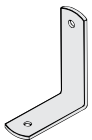

Fig. 910
Reversible
Angle Bracket

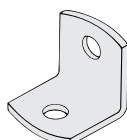

Fig. 920
Side Beam
Angle Bracket

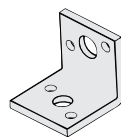

Fig. 925
Reversible Side
Beam Angle Bracket

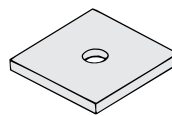

Fig. 930
Square Plate
Washer

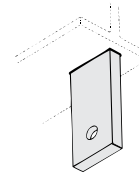

Fig. 935 & 936
Welding Lug

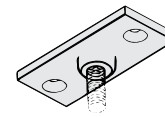

Fig. 940-942
Ceiling Flange

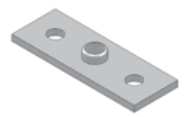

Fig. 945 & 946
Steel Ceiling Plate

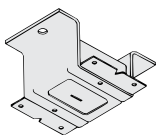

Fig. 950-951N
Concrete Insert



Fig. 960
Turnbuckle

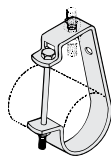

Fig. 970-973
J-Hanger

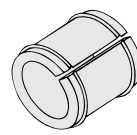

Fig. 980 & 982
Felt Isolator

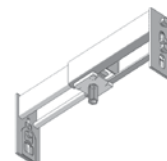

Fig. 990
Adjustable In-Rack
Flue Hanger

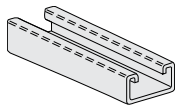

Fig. 995
Single In-Rack
Flue Hanger



STRUT PRODUCTS & ACCESSORIES

CHANNEL



1201-1242
1⁵/₈" X 1³/₁₆" X 12 Ga.

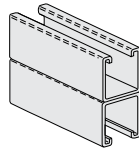

1001A-1722A
Welded
Back to Back

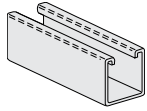

1301-1342
1⁵/₈" X 1³/₁₆" X 14 Ga.

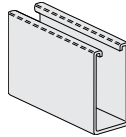

1401-1442
1⁵/₈" X 1" X 12 Ga.

1001-1042
1⁵/₈" X 1⁵/₈" X 12 Ga.

1101-1142
1⁵/₈" X 1⁵/₈" X 14 Ga.

1701-1742
1⁵/₈" X 1³/₈" X 12 Ga.

1501-1542
1⁵/₈" X 3¹/₄" X 12 Ga.

1601-1642
1⁵/₈" X 2⁷/₁₆" X 12 Ga.

STRUT CLAMPS

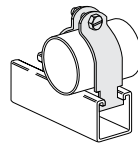

2001-2016
I.P. Pipe Clamp

2101-2107
Universal Pipe
Clamp for
EMT, IMC & GRC

2201-2207
EMT Conduit Clamp



2501-2587
Clamp With
Cushion

2301-2314
Copper Tubing
Clamp

2401-2496
O.D. Tube
Clamp

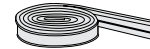

2600
Cushion
Material



723025-729312
7 Series Klo-Sure
Clamp for Elasto-
meric Insulation

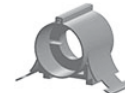

824050-828262
8 Series Klo-Shure
Clamp for Elasto-
meric Insulation



924062-929190
9 Series Klo-Shure
Clamp for Fiberglass
Insulation

STRUT NUTS

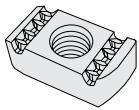

3001-3011
Strut Nut
without Spring
(Shown)

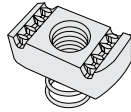

3201-3210
Strut Nut
with Short
Spring

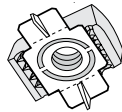

3404-3408
Squeeze
Nut

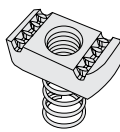

3351-3353
Shallow Strut
Nut without
Spring

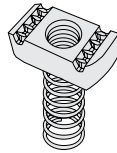

3101-3111
Strut Nut
with Spring

3301-3311
Strut Nut
with Long Spring

CONTINUOUS CONCRETE INSERT

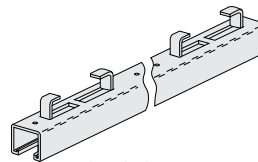

4001-4002
1⁵/₈" X 1³/₈" X 12
Gauge (Shown)

4101-4102
1⁵/₈" X 1³/₁₆" X 12
Gauge

4201-4202
1⁵/₈" X 1" X 12
Gauge

4301-4302
1⁵/₈" X 1⁵/₈" X 12
Gauge

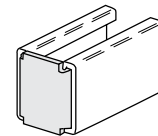

4405-4420
Type A End Caps

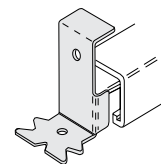

4440-4470
Type B
End Caps

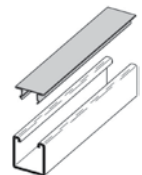

4500-4506
Closure Strip

FLAT PLATE FITTINGS

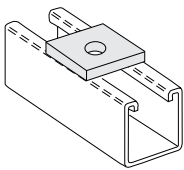

5000-5004
Square Washer

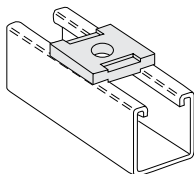

5005-5009
No Turn Square Washer

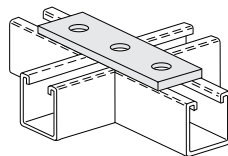

SPLICE PLATE
5010-5012 2-Hole
5013-5014 3-Hole (Shown)
5015 4-Hole
5019 5-Hole

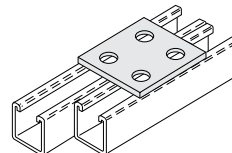

5017
4-Hole Splice Plate

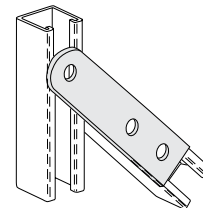

SWIVEL PLATE
5020 2-Hole
5023 3-Hole (Shown)

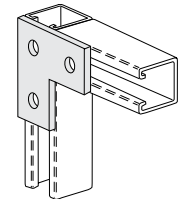

CORNER PLATE
5025 3-Hole (Shown)
5030 4-Hole

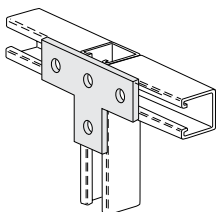

5035
4-Hole Tee Plate

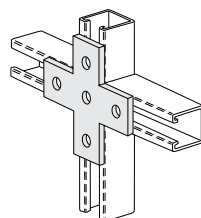

5040
5-Hole Cross Plate

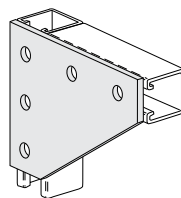

**CORNER GUSSET
PLATE**
5045 3-Hole
5050 4-Hole
5060 5-Hole (Shown)

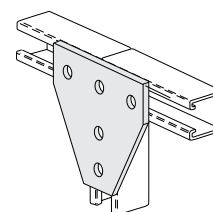

TEE GUSSET PLATE
5065 3-Hole
5075 4-Hole
5080 5-Hole (Shown)
5085 6-Hole

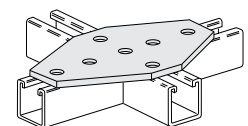

CROSS GUSSET PLATE
5090 6-Hole
5095 7-Hole (Shown)

90° FITTINGS

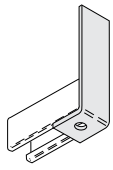

5101-5107
1-Hole
Angle

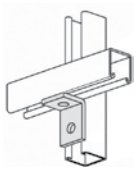

5110 & 5112
2-Hole
Corner Angle

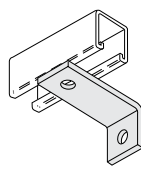

5115-5118
2-Hole
Corner Angle

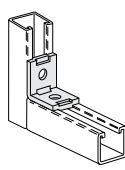

5119
"No-Turn"
2-Hole
Corner Angle

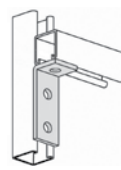

CORNER ANGLE
5120-5123 3-Hole
5130-5131 4-Hole
(Shown)

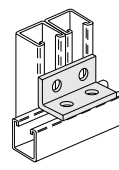

5135
4-Hole
Corner Angle

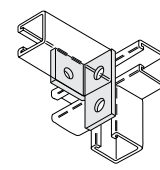

5140-5146
3-Hole Offset
Bent Angle
5140 & 5145
(Shown)

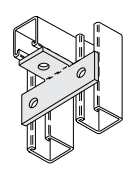

5148
3-Hole Offset
Bent Tee

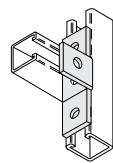

5150
4-Hole Offset
Bent Tee

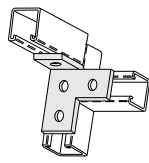

5155 & 5156
4-Hole Offset
Bent Tee

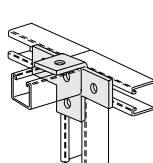

5160
5-Hole Offset
Bent Tee

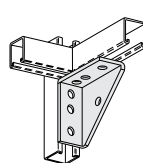

**UNIVERSAL SHELF
BRACKET**
5165 (Shown)
5166 Welded

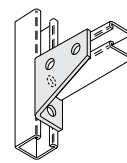

5170 - 5176
4-Hole Corner
Gusset

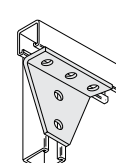

**GUSSETED SHELF
ANGLE**
5180 3-Hole
5185 & 5186 4-Hole
5190 5-Hole (Shown)

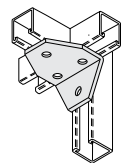

**JOINT ANGLE
CONNECTOR**
5200 4-Hole
(Shown)
5205 5-Hole

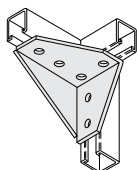

5210 & 5211
6-Hole
Gusseted
Corner
Connector

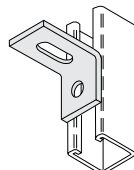

5220-5226
2-Hole Adjustable
Corner Angle
5221 (Shown)

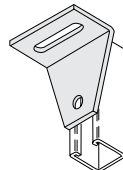

5228
2-Hole Adjustable
Corner Angle

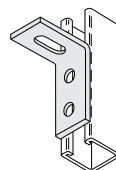

5230
3-Hole Adjustable
Corner Angle

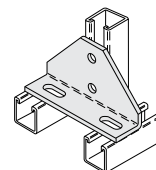

5250 & 5255
4-Hole Adjustable
Corner Angle
5250 (Shown)

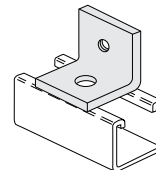

5260
2-Hole Tapped
Corner Angle

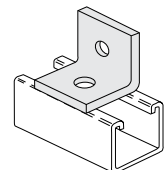

5270
2-Hole Bus
Duct Angle

ANGLE FITTINGS

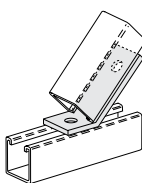

5301-5315
2-Hole Open
Angle Connector

5340-5350
4-Hole Open
Angle Connector

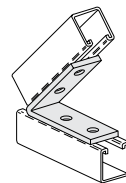

5360-5366
2-Hole Closed
Angle Connector

5370-5376
4-Hole Closed
Angle Connector
(Shown)

BRACES

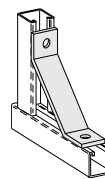

5410-5412
2-Hole 45°
Knee Brace

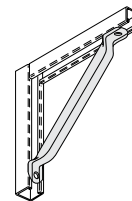

5420-5427
2-Hole 45° Tubing
Knee Brace

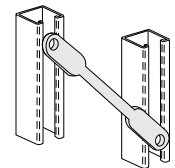

5430-5440
2-Hole Straight
Tubing Brace

"U" FITTINGS

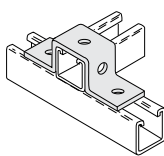

"U" SUPPORT
5501 3-Hole - $13/16$ " tall
5503 5-Hole - $1 5/8$ " tall
(Shown)
5505 3-Hole - $2 7/16$ " tall
5507 3-Hole - $3 1/4$ " tall

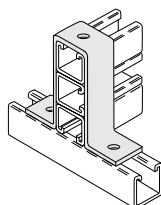

5509
3-Hole "U"
Support
 $4 7/8$ " tall

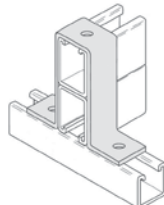

5511
3-Hole "U"
Support
 $6 1/2$ " tall

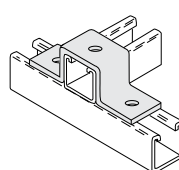

5513
3-Hole
"U" Support
 $1 7/8$ " tall

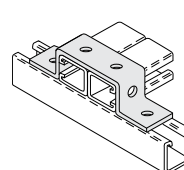

5521
6-Hole
"U" Support

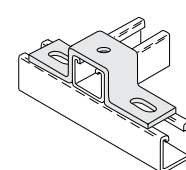

5530-5532
Slotted 3-Hole
"U" Support

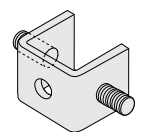

**STUD RING
CONNECTOR**
5541 1 Stud
5542 2 Stud
5543 2 Stud
(Shown)



STRUT PRODUCTS & ACCESSORIES

"Z" FITTINGS

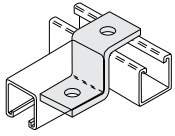

5550
2-Hole Offset "Z" Support

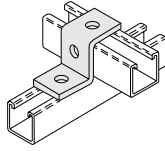

"Z" SUPPORT
5551 2-Hole for #1200 Strut
5552 3-Hole for #1500 Strut
5553 2-Hole for #1600 Strut
5554 3-Hole for #1000 Strut (Shown)

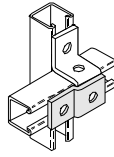

5556
2-Hole Offset "Z" Support

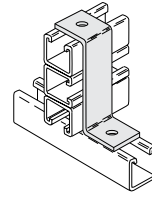

5558
2-Hole "Z" Support

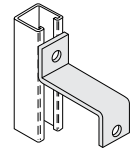

5560-5562
2-Hole "Z" Bus Duct Connection

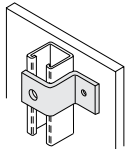

5565
Tapped "Z" Support

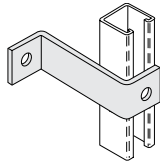

5570-5574
2-Hole "Z" Support

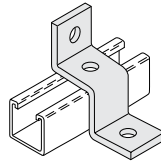

5575
3-Hole Sheath Corner Connection

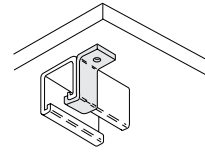

CHANNEL HANGER
5580 For #1000 Strut (Shown)
5581 For #1200 Strut
5582 For #1500 Strut
5583 For #1600 Strut

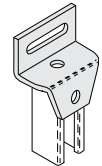

5590
Adjustable Offset Gussetted "Z" Support

WING FITTINGS

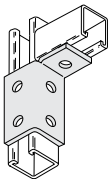

CORNER CONNECTOR
5600 & 5601 3-Hole
5605 & 5606 4-Hole
5610 & 5611 5-Hole (Shown)
5615 & 5616 6-Hole

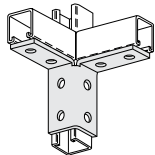

DOUBLE CORNER CONNECTOR
5620 4-Hole
5625 6-Hole
5630 8-Hole (Shown)

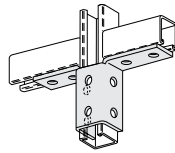

DOUBLE WING CONNECTOR
5635 5-Hole
5640 8-Hole
5645 10-Hole (Shown)

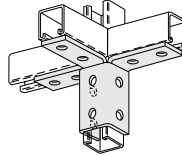

TRIPLE WING CONNECTOR
5650 6-Hole
5655 12-Hole (Shown)
5660 9-Hole

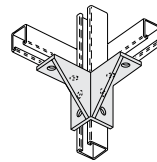

5665
8-Hole Gussetted Double Corner Connector

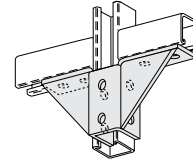

5675
10-Hole Gussetted Double Corner Connector

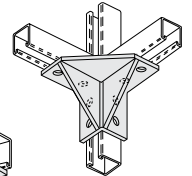

5685
8-Hole Gussetted Double Corner Connector

CLEVIS FITTINGS

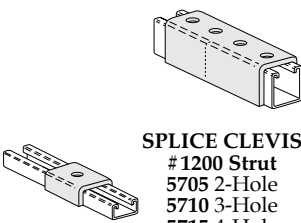

5700-5704
1-Hole "U" Washer

SPLICE CLEVIS
#1200 Strut
5705 2-Hole
5710 3-Hole
5715 4-Hole
#1000 Strut
5720 2-Hole
5730 4-Hole

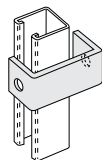

5750-5764
2-Hole Clevis

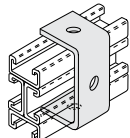

5770
3-Hole Clevis

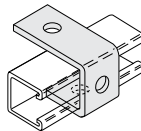

5775
3-Hole Suspension Clevis

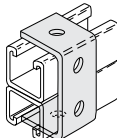

5780
4-Hole Suspension Clevis

MISC. FITTINGS

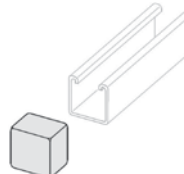

4475-4489
Safety End Caps

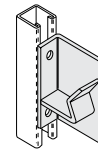

SINGLE PIPE AXLE SUPPORT
5801 & 5802 for 1/4" Pipe
5803 & 5804 for 2" Pipe (Shown)

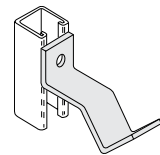

5821
Pipe Support Bracket

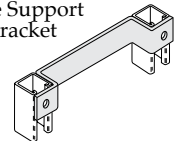

5825-5827
Series Ladder Rungs

BRACKETS & TROLLEYS

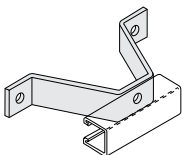

5830-5834
Wall Ladder Brackets

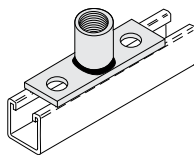

5835-5837
Pipe Coupling Fitting

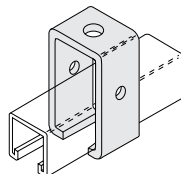

5840
Trolley Beam Support

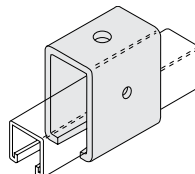

5845
Trolley Beam Joint Support

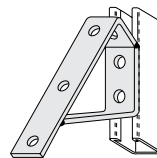

STAIR SUPPORT
5860 45° (Shown)
5861 37 1/2°

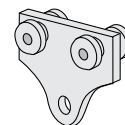

TROLLEY ASSEMBLY
5870 4-Bearing

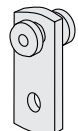

TROLLEY ASSEMBLY
5875 2-Bearing

STRUT PRODUCTS & ACCESSORIES



POST BASES

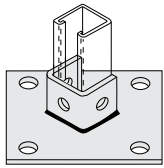

6005
Post Base
for 1⁵/₈ Strut

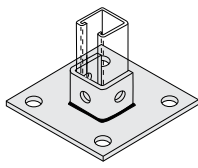

6010
Post Base
for 1⁵/₈ Struts

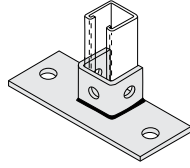

6015
Post Base
for 1⁵/₈ Struts

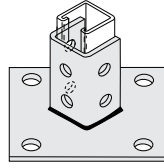

6020
Post Base
for 1⁵/₈ Struts

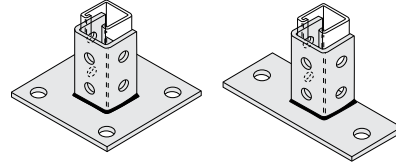

6025
Post Base
for 1⁵/₈ Struts

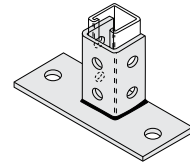

6030
Post Base
for 1⁵/₈ Struts

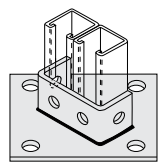

6035
Post Base
for Double
1⁵/₈ Struts

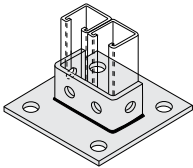

6040
Post Base
for Double 1⁵/₈
Struts

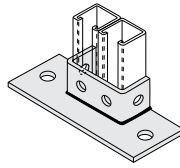

6045
Post Base
for Double 1⁵/₈ Struts

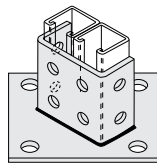

6050
Post Base
for Double 1⁵/₈
Struts

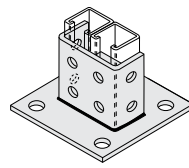

6060
Post Base
for Double 1⁵/₈
Struts

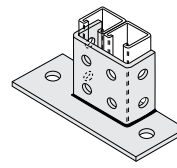

6065
Post Base
for Double 1⁵/₈
Struts

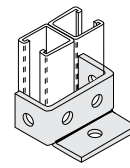

6080
Post Base
for 1⁵/₈ Back
to Back Struts

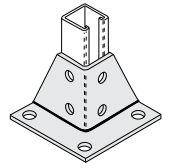

6095
Post Base
for 1⁵/₈ Struts

BRACKETS

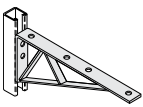

6101-6125
Shelf
Bracket

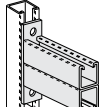

6140-6144
Double Chan-
nel Bracket

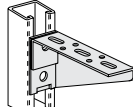

6160-6172
Braced Single
Bracket

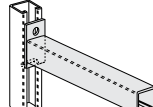

6212-6218
Interlocking
Channel
Bracket (Slot
Down)

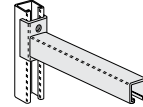

6232 & 6234
Wrap-Around
Channel Bracket
(Slot Down)

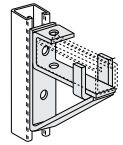

**CHANNEL
BRACKET SUPPT.**
6305 Single for
1001 & 1101 Strut
(Shown)
6310 Double for
1001A & 1101A
Struts

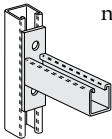

6130-6135
Single Channel
Bracket

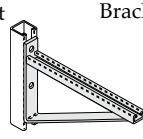

6150-6152
Braced Single
Bracket

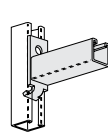

6202-6208
Interlocking
Channel Bracket
(Slot Up)

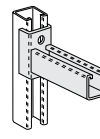

6222 & 6224
Wrap-Around
Channel Bracket
(Slot Up)

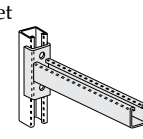

6246 & 6248
Wrap-Around
Channel Bracket
(Slot Up)

BEAM CLAMPS

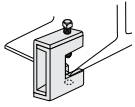

7001 & 7002
Heavy Duty
Beam Clamp

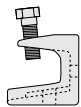

7005 - 7008
Beam Clamp

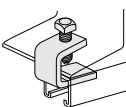

7011 & 7012
"I" Beam
Clamp

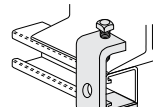

7020 & 7025
"I" Beam
Clamp

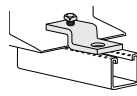

7030
"Z" Beam
Clamp

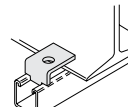

7040
Beam Clamp

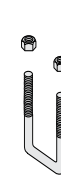

7050 & 7051
Square U-Bolt

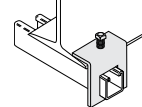

7060
Beam Clamp
For use with
1⁵/₈ Struts

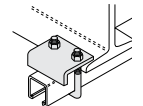

BEAM CLAMP
7070
For use with 1⁵/₈" Struts
(Shown)
7075
For use with 3/4" Struts
7076
For use with
1500A Series Struts

PIPE CLAMPS, ROLLERS, & HARDWARE

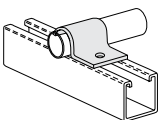

7231-7238
One Hole
Clamp for
O.D. Tubing

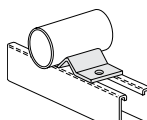

7370
Pipe Stop

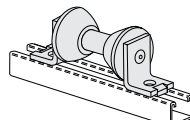

7501-7506
Pipe Roller
with Axle

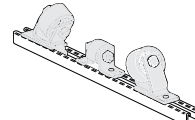

7560
60° Rollers with
Center Roller

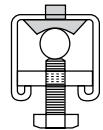

7600
Cradle
Clip

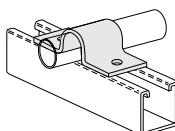

7251-7263
Standard Pipe
Strap

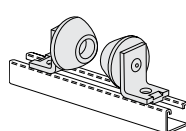

7400
Separate
Rollers

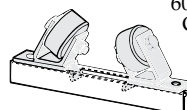

7530
60° Separate
Rollers

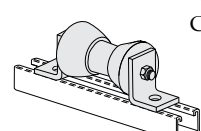

7581-7585
Roller
Support



PHD Manufacturing, Inc.

44018 Columbiana-Waterford Road
Columbiana, Ohio 44408

Phone: (800) 321-2736 • (330) 482-9256
Fax: (330) 482-2763 • www.phd-mfg.com