

# MultiChoice® Universal Thermostatic Tub and Shower

**TECK®**  
COMMERCIAL



**Specification: (example)**

- R10000-UNWS** ROUGH-IN only
  - Concealed in-wall MultiChoice® Universal valve
  - Back-to-back capability, Integral screwdriver stops
  - **Heavy Duty forged brass** valve body
  - 1/2" Universal inlets to accept 1/2" copper, 1/2" iron pipe, PEX or CPVC adaptors
  - 1/2" Male thread inlets/outlets
- T17TH** \_\_\_\_\_ **FINISH TRIM ONLY:**
  - TempAssure® 17T Thermostatic cartridge
  - Polished chrome plated finish
  - ADA compliant handle
  - Lever volume control; temperature adjustment dial
  - Non-removeable red/blue temperature markings and ... with ... (add product variation) with ... (add shower)



**T17TH155**

**Engineer/Architect Approval**







Model Specified:

Approval:

Date:

TUB AND SHOWER DESCRIPTION	PRODUCT NO.		
<b>ROUGH-IN Valve</b>	<b>R10000-UNWS</b>		
<b>FINISH TRIM only</b>	<b>T17TH</b>		<b>5</b>



PRODUCT VARIATION	SHOWER	HANDLE
<b>0</b> <input type="checkbox"/>	<b>0</b> Specify "0" When No Shower Outlet Required (1) <input type="checkbox"/>	<b>0</b> <input type="checkbox"/>
<b>1</b> Shower Valve Only  <input type="checkbox"/>	<b>1</b> <input type="checkbox"/>	<b>1</b> <input type="checkbox"/>
<b>2</b> Tub and Shower  <input type="checkbox"/>	<b>2</b> 3-Function Touch-Clean® Showerhead, Arm & Set Screw Flange 2.0 gpm (7.6 L/min)  <input type="checkbox"/>	<b>2</b> <input type="checkbox"/>
<b>3</b> <input type="checkbox"/>	<b>3</b> Touch-Clean® Showerhead, Arm & Set Screw Flange 2.0 gpm (7.6 L/min)  <input type="checkbox"/>	<b>3</b> <input type="checkbox"/>
<b>4</b> <input type="checkbox"/>	<b>4</b> <input type="checkbox"/>	<b>4</b> <input type="checkbox"/>
<b>5</b> <input type="checkbox"/>	<b>5</b> Handshower with 2 Check Valves, 610mm (24") S/S Bar with ADA Slide 2.5 gpm (9.5 L/min)  <input type="checkbox"/>	<b>5</b> Vandal Resistant Metal Lever Volume Control Handle w/ Temperature Adjustment  <input checked="" type="checkbox"/>
<b>6</b> <input type="checkbox"/>	<b>6</b> <input type="checkbox"/>	<b>6</b> <input type="checkbox"/>
<b>7</b> <input type="checkbox"/>	<b>7</b> <input type="checkbox"/>	<b>7</b> <input type="checkbox"/>
<b>8</b> <input type="checkbox"/>	<b>8</b> <input type="checkbox"/>	<b>8</b> <input type="checkbox"/>
<b>9</b> <input type="checkbox"/>	<b>9</b> <input type="checkbox"/>	<b>9</b> <input type="checkbox"/>

See **DSP-B-R10000-HDF** for additional Rough-In options.  
1) Valve rated minimum 1.7 gpm @ 45 psi (6.4 L/min @ 310 kPa).

Note: Use this page front and back as a product submittal sheet.  
Refer to [www.specselect.com](http://www.specselect.com) for individual models.  
Stated flow rate for showerheads @ 80 psi (552 kPa) maximum.

Delta reserves the right (1) to make changes in specifications and materials, and (2) to change or discontinue models, both without notice or obligation. Dimensions are for reference only. See current full-line price book or [www.specselect.com](http://www.specselect.com) for finish options and product availability.

**DSP-T17TH1 Rev. H**



**TECK<sup>®</sup>**  
COMMERCIAL

# MultiChoice<sup>®</sup> Universal Thermostatic Tub and Shower

**Approvals:**

- ASME A112.18.1/CSA B125.1
- Indicates compliance to ICC/ANSI A117.1
- Thermostatic Valve complies with ASSE 1016
- Handshower back flow protection provided by two integral certified check valves in series, which operate independently, ASME A112.18.3

(Contact Delta Representative for State and/or Local Approvals.)



**FLOW RATE vs PRESSURE**

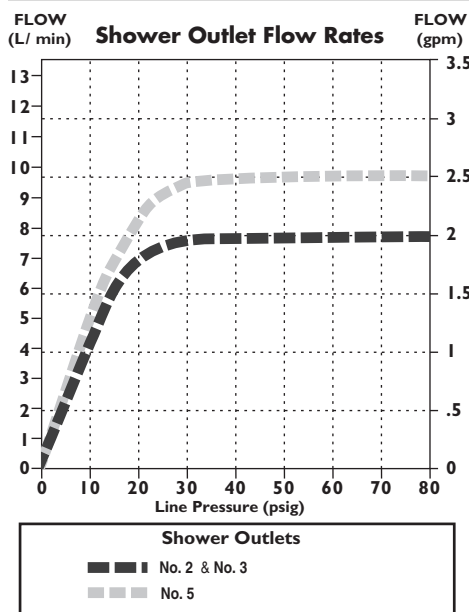

**FLOW RATE vs PRESSURE**

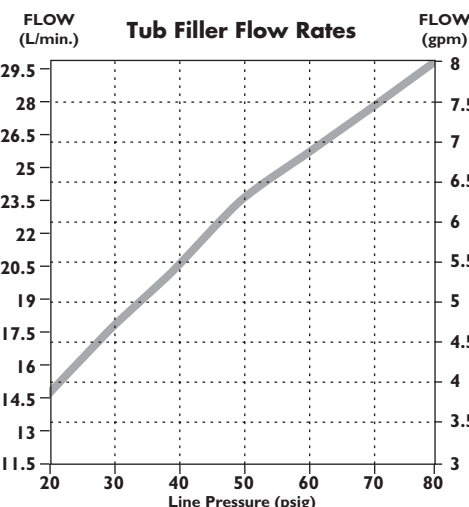

**R10000-UNWS Rough-In  
with  
T17TH135 Trim**

**FRONT VIEW**

**SIDE VIEW**

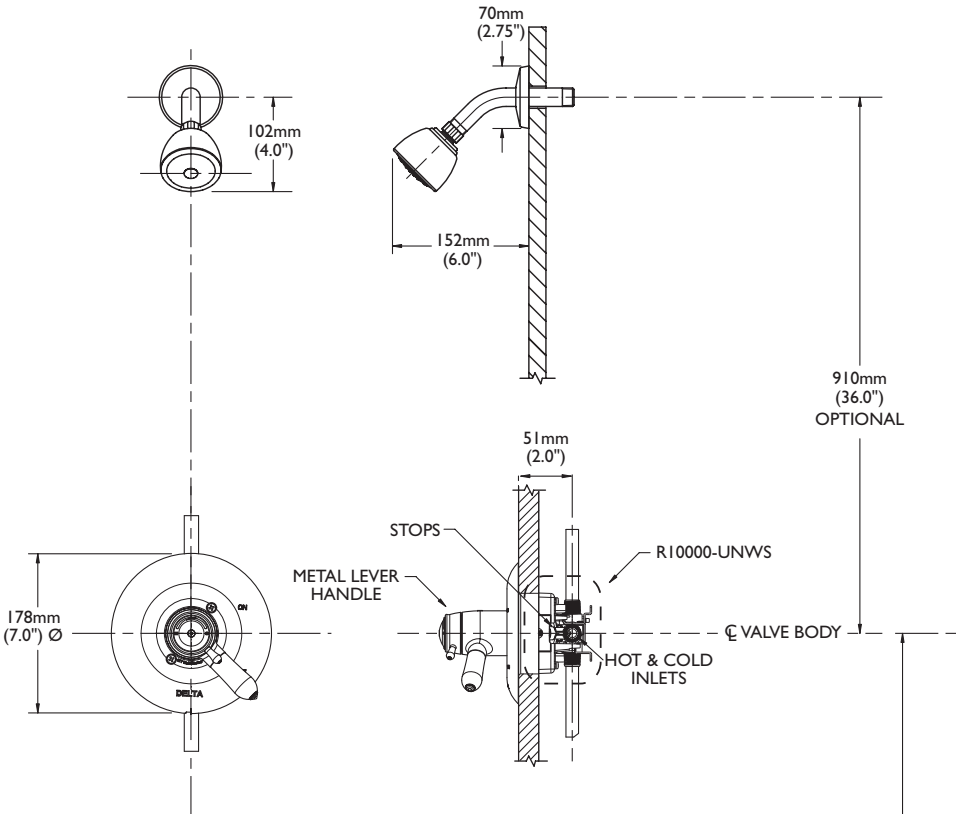

**P/B VALVE INLETS:**  
1/2" Universal inlets accept 1/2" copper,  
1/2" Iron pipe, PEX or CPVC adaptors  
1/2" Male thread inlets/outlets

**PAUSE WARNING FOR SHOWER #5**

Plumbing Codes require that showerheads and handshowers provide a small but continuous flow of water (trickle) when in "PAUSE" mode. Because of this continuous flow, in certain circumstances pressure variations in the water line and/or changes in the position of the shower temperature control handle while in "PAUSE" mode could result in dramatic changes to the temperature of the water when the shower head or hand shower is returned to the "ON" position.

ALWAYS point the shower head away from yourself when returning to the "ON" position and feel the water with your hand before resuming your shower to ensure the water flow is not too hot or too cold. DO NOT allow children or others who might not understand this warning to use the "PAUSE" function.

Note: Measurements may vary ± 6mm (0.25")

Refer to [www.specselect.com](http://www.specselect.com) for individual models.

Note: Use this page front and back as a product submittal sheet.



# T17TH Series Tub and Shower Add-On Options

**TECK<sup>®</sup>**  
COMMERCIAL



DESCRIPTION	ADD-ON NUMBER		
T17TH Tub/Shower Add-On Options	-		

(A number from each option column must be used for a **complete Product Add-On**)

HOSE		SLIDE BAR	
<b>0</b>	Always use "0" if <b>NO</b> selection is required from this column	<input type="checkbox"/>	<input type="checkbox"/>
<b>1</b>		<input type="checkbox"/>	<input type="checkbox"/>
<b>2</b>	1753 mm (69") Long CP Stainless Steel Hose – Stretches to 92" (2337 mm) (See Note 1)	 <input type="checkbox"/>	<input type="checkbox"/>
<b>3</b>		<input type="checkbox"/>	<input type="checkbox"/>
<b>4</b>		<input type="checkbox"/>	<input type="checkbox"/>
<b>5</b>	914 mm (36") S/S Slide Bar (See Note 2)	 <input type="checkbox"/>	<input type="checkbox"/> 

**Note:**

- (1) **Base Product** for the **HOSE, ETC.** option must include **SHOWER** option **No. 5**
- (2) **Base Product** for S/S Slide Bar must include **SHOWER** option **No. 5**