

W 23533C48
D48"X4.5 H6.25" L10



We are dedicated to providing our finest quality crystal luminaires for our customers. Our master craftsmen and designers pride themselves on their attention to detail. Prompt, efficient service is always our priority.

Enclosed herein are detailed instructions on how to properly install your chandelier. Please read all instructions carefully and thoroughly.

If you have any questions please feel free to call our Toll Free hotline at:

1-855-411-8999

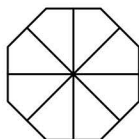

Crystal Dressing Instructions

When dressing the chandelier with the crystals please remember to wear either rubber or cotton gloves. So as to prevent any damage or smudging on the crystals.



A



53 strings

B

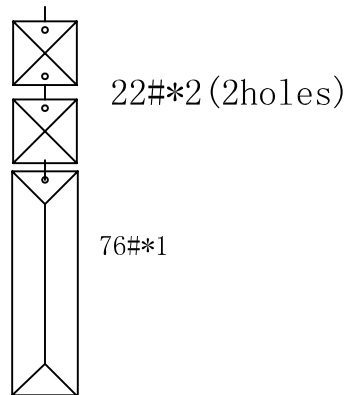

53 strings

C

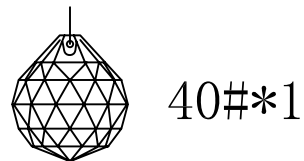

56 strings

CANOPY PARTS LIST

Existing Electrical Box

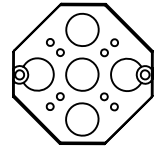

Crossbar Screws x 2 (not supplied)



Crossbar Screws



Wire Connector

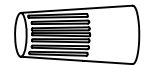

Shrinkable tube



Cable tie



Ground Wire



CANOPY INSTALLATION DIAGRAM

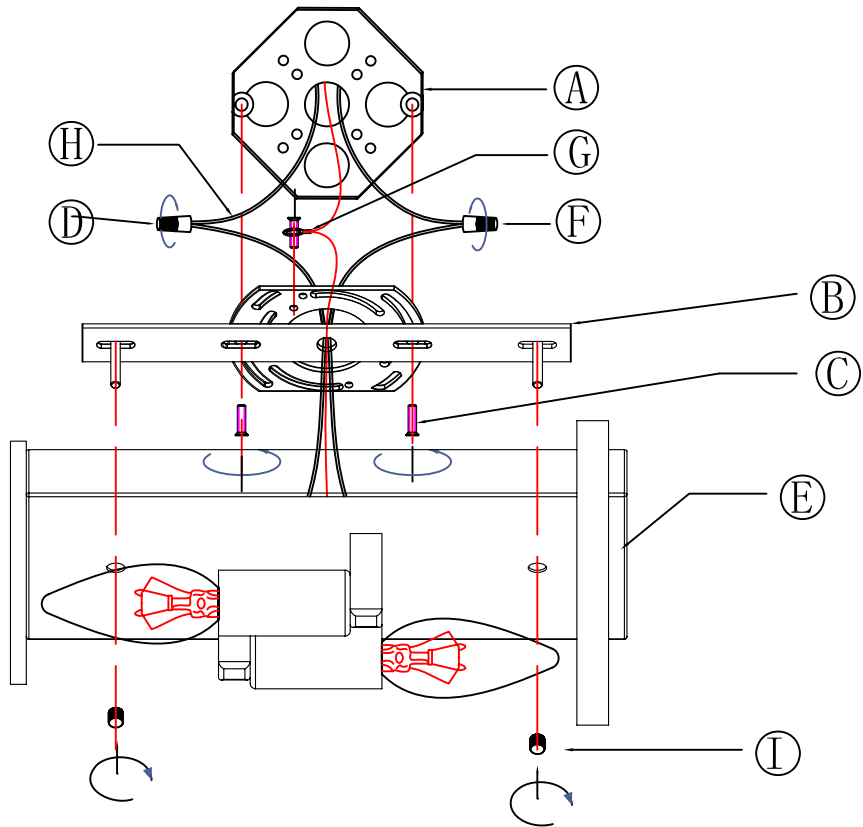

07

Frame Parts List

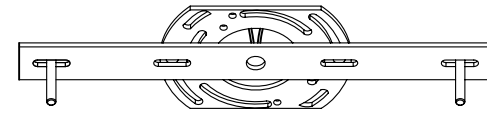

01-Crossbar

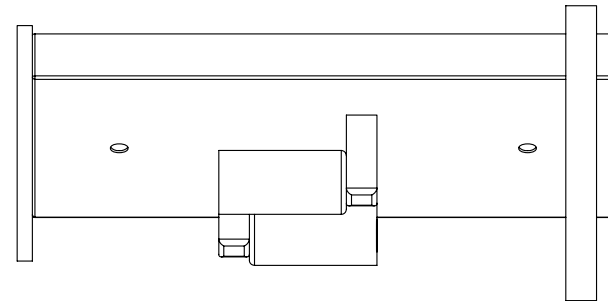

02-Lamp Body



03-Crossbar Bracket

04

WARNING!!!

CONTENTS ARE FRAGILE
HANDLE WITH CARE

The metal frame and crystal components of this chandelier are very delicate. Please exercise extreme Caution during unpacking and installation.

WARNING!!!

After passing the main electrical wire through the 10mm pipe and connecting the pipe to the main body top connector, place all remaining pieces as shown in numerical order and in the orientation depicted. Refer to the parts list to avoid confusion between parts. The part Numbers coincide

CAUTION

1. Rated 110v-130v/60Hz, bulb E12/40W maximum.
2. Care Should be taken to avoid damage to the surface of lighting and wire, wearing gloves is recommended when installing
3. Connect black or red wire of the lighting to live wire and white or blue wire to neutral wire and double colored (or bare copper) wire to ground wire.
4. Never install lighting on damp ceiling, the room should be dry and well ventilated.
5. Keep lighting away from acid, alkali and other corrosive chemical or gas, clean the lighting with Clean soft cloth only.
6. Installation must be carried out by qualified electrician only.
7. Disconnect the power before installing, cleaning and replacing lighting.
8. Never cover the lighting when power is connected.
9. When installing ceiling tube, chain, pipe or other parts make sure it is connected on a firm, secure part of ceiling.
10. Care should be taken to avoid damage when installing glass parts.
11. All electrical components must be installed by a licensed electrician and in accordance with the National Electrical Code and the appropriate local electrical codes. Make sure that the electrical supply to the chandelier is turned off at the main fuse or circuit breaker before doing any installation Worldwide lighting shall not be responsible for unprofessional wiring.

01

Crystal Dressing Diagram



When dressing the chandelier with the crystals please remember to wear either rubber or cotton gloves. So as to prevent any damage or smudging on the crystals.

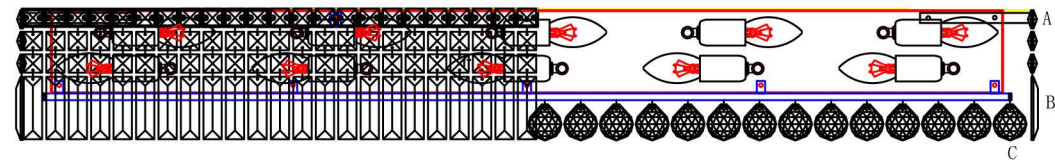

10

Frame Assembly Diagram

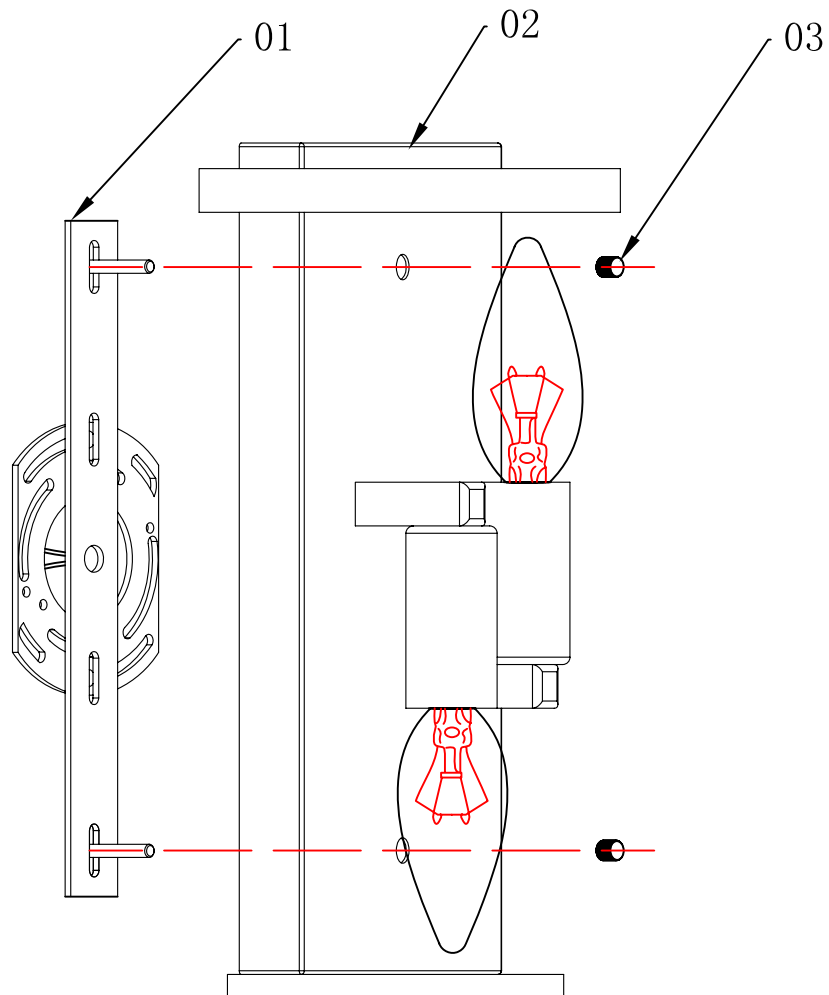

03

CANOPY INSTALLATION INSTRUCTIONS

Please read all instructions carefully. Before you proceed to install, make sure that the power supply is turned off and off until installation is complete. Please note that each part has been assigned a letter. Please proceed in an alphabetical order.

- A. Existing Electrical Box
- B. Crossbar
- C. Crossbar Screws
- D. Junction Caps
- E. Metal Base
- F. Neutral Conductor
- G. Ground Wire
- H. Hot Wire
- I. Crossbar Bracket

1. Fasten Crossbar (B) into the Existing Electrical Box (A) with screws (C).
2. Connect and hot wire (H), neutral wire (F) and ground wire (G) correctly and tighten them with cap (D)
3. Fix the Metal Base and tighten it with (I).

08

WARNING!!!

CONTENTS ARE FRAGILE
HANDLE WITH CARE

The metal frame and crystal components of this chandelier are very delicate. Please exercise extreme Caution during unpacking and installation.

WARNING!!!

After passing the main electrical wire through the 10mm pipe and connecting the pipe to the main body top connector, place all remaining pieces as shown in numerical order and in the orientation depicted. Refer to the parts list to avoid confusion between parts. The part Numbers coincide

CAUTION

1. Rated 110v-130v/60Hz, bulb E12/40W maximum.
2. Care Should be taken to avoid damage to the surface of lighting and wire, wearing gloves is recommended when installing
3. Connect black or red wire of the lighting to live wire and white or blue wire to neutral wire and double colored (or bare copper) wire to ground wire.
4. Never install lighting on damp ceiling, the room should be dry and well ventilated.
5. Keep lighting away from acid, alkali and other corrosive chemical or gas, clean the lighting with Clean soft cloth only.
6. Installation must be carried out by qualified electrician only.
7. Disconnect the power before installing, cleaning and replacing lighting.
8. Never cover the lighting when power is connected.
9. When installing ceiling tube, chain, pipe or other parts make sure it is connected on a firm, secure part of ceiling.
10. Care should be taken to avoid damage when installing glass parts.
11. All electrical components must be installed by a licensed electrician and in accordance with the National Electrical Code and the appropriate local electrical codes. Make sure that the electrical supply to the chandelier is turned off at the main fuse or circuit breaker before doing any installation. Worldwide lighting shall not be responsible for unprofessional wiring.

Frame Assembly Instructions

Installation:

Please read all instructions carefully.
Before you proceed to install, make sure that the power supply is turned off and remains off until installation is complete.
Please note that each part has been assigned a number.
Please proceed in a numerical order.

1. Fix the crossbar (01) on junction box.
2. Make sure the positive and negative charges of wire and lamp body match correctly, screw the connect point with the junction cap.
3. Make sure the main wire is enough long and keep the rest wire in the 4" j-box.
4. Screw the lamp body (02) on Crossbar (01) With Crossbar Bracket
5. As the crystal pressing instruction, hang the crystal parts.

The end!