

# SCHONBEK®

## TRILLIANE 5875A TRIM DIAGRAM

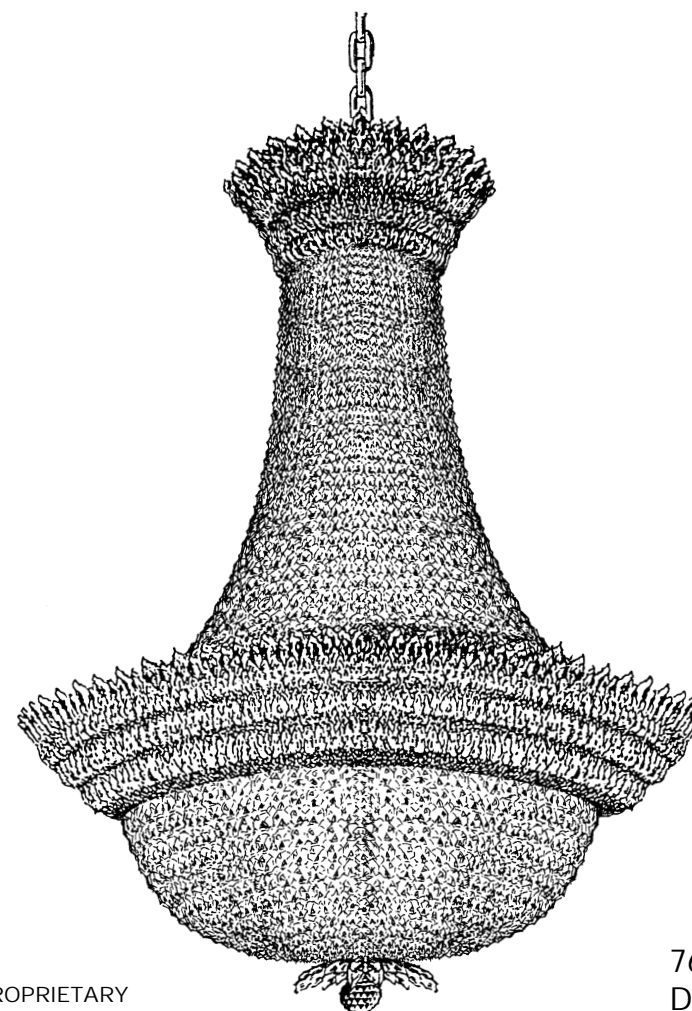

**T**HIS DESIGN IS THE PROPRIETARY TRADE DRESS/TRADEMARK OF SCHONBEK WORLDWIDE LIGHTING INC.

76 Lights  
Diameter: 48"  
Body Length: 56"

# SCHONBEK®

This fixture was designed and manufactured in Plattsburgh, N.Y. Our high-quality crystal fixtures are made with state-of-the-art manufacturing equipment. If you have any questions about this or any of our more than 450 crystal products, contact your nearest authorized Schonbek distributor.

**CAUTION... RISK OF ELECTRICAL SHOCK.** Make sure the electrical supply to the chandelier is turned off at the main fuse or circuit breaker before doing any installation. All electrical components must be installed by a licensed electrician in accordance with the National Electric Code and the appropriate local electrical codes.

**HANGING WEIGHT:** 156 pounds.

**BULBS:** (75) Candle shaped candelabra base C10 bulbs, recommend 25 watts for best appearance.

(1) Globe shaped candelabra base G16-1/2 bulbs, recommend 25 watts for best appearance.

60 - Watts Maximum

**WARNING:** This chandelier meets UL/CSA requirements. Any tampering will void UL/CSA certification.

### IMPORTANT

Please record the following information for future service.

CODE # \_\_\_\_\_ Four-digit number on outside of carton.  
PACKER # \_\_\_\_\_ See crystal package label.  
ORDER # \_\_\_\_\_ See crystal package label.

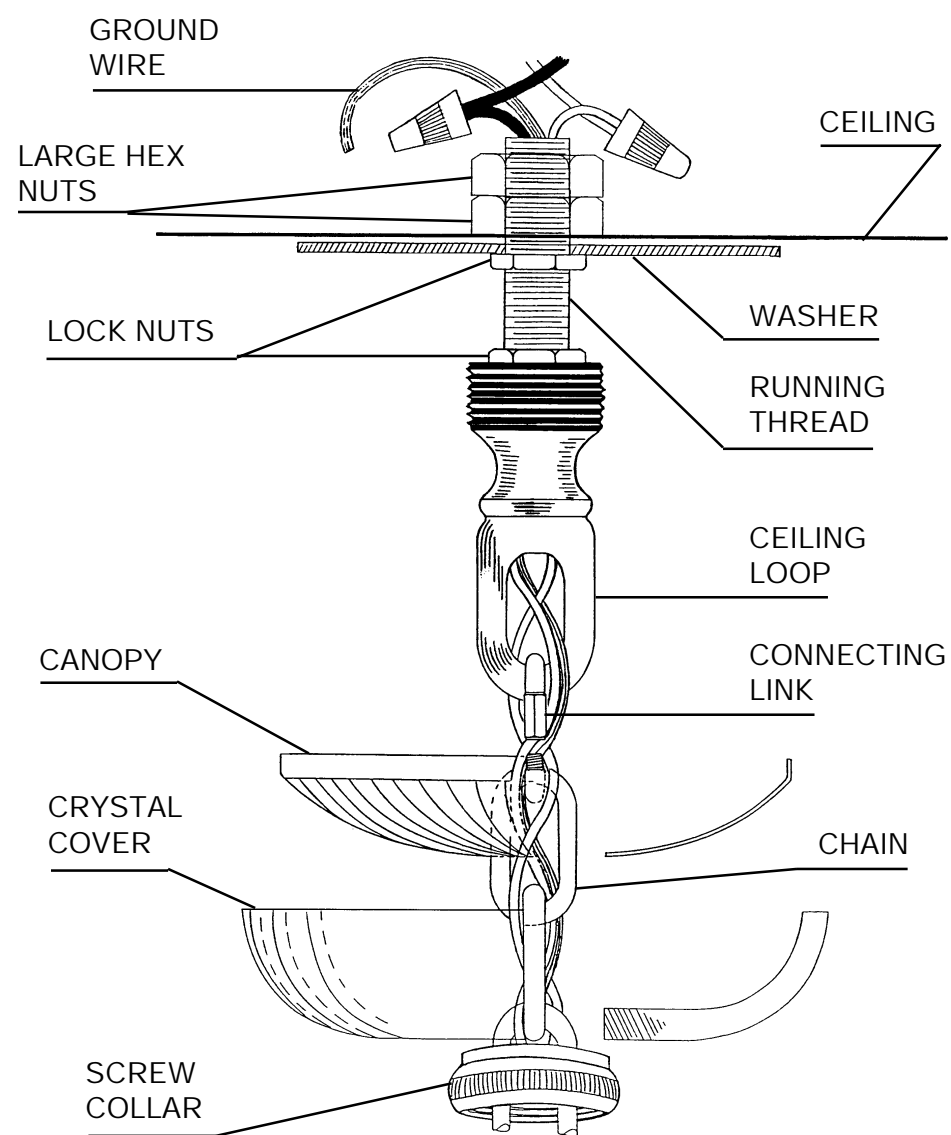

- 1 MAKE SURE POWER IS DISCONNECTED!!
- 2 Attach washer to supporting member in ceiling sufficient to support weight of fixture.
- 3 Slip screw collar, crystal cover and metal canopy over chain. Determine the suspension length of the fixture and cut chain, if necessary. Use two connecting links to attach chain to chandelier loop and ceiling loop.
- 4 Insert stem wire through chain and ceiling loop. Connect wires. Fixture MUST be grounded.
- 5 Check distance from ceiling to loop to assure canopy assembly will be flush against ceiling.
- 6 Attach canopy to ceiling with screw collar.

## MAINTENANCE:

Use a soft, lint - free cloth to clean the metal frame.

**UNDER NO CIRCUMSTANCES SHOULD METAL POLISHES, CLEANERS, ABRASIVES OR AEROSOL SPRAYS BE USED.**

While the latest finishing techniques have been used on the metal frame, such finish cannot be unconditionally guaranteed. The main cause of deterioration, apart from certain atmospheric conditions, is improper cleaning.

To clean the crystals, polish with a damp chamois.

You are cleaning delicate jewelry... Take the greatest care.

## IMPORTANT:

Do not clean crystals in a dishwasher. The finish of the metal clips and hangers will be ruined and the crystals may be damaged.

### Installation of Crystal "C"

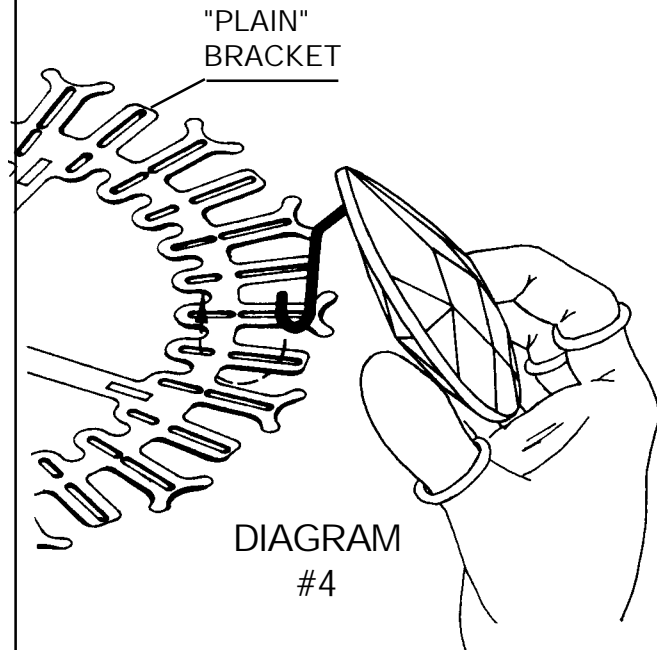

Position the crystal above the "plain" bracket so that the end of the hook enters the slot, gently push toward the center of the fixture and raise the crystal making sure that the end of the hook comes up through the inner slot, in line with the outer slot.

With the hook in the bracket, as shown, pivot the crystal downwards so that the hook rests in the end of the outer slot.



DIAGRAM #5

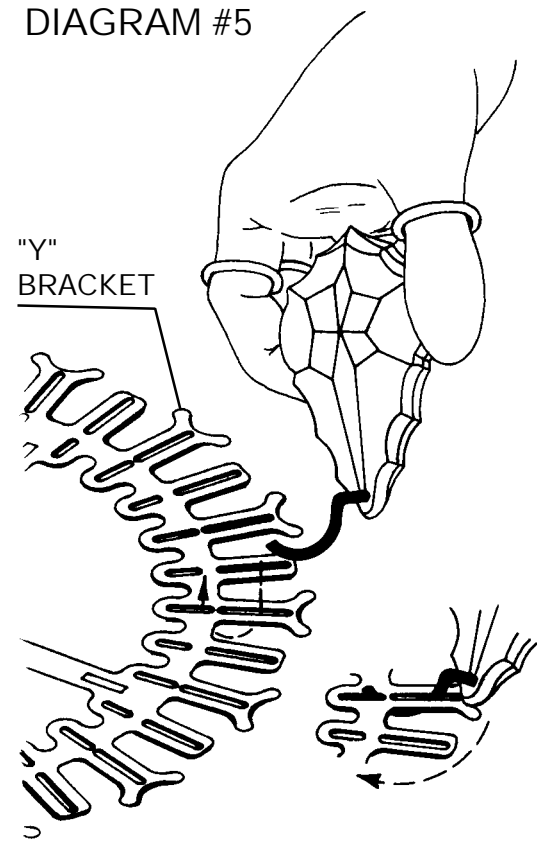

### Installation of Crystal "D" and "E"

Position the crystal above the "Y" bracket so that the end of the hook enters the long slot, gently push toward the center of the fixture and raise the crystal making sure that the end of the hook comes up through the short slot, in line with the long slot.

With the hook in the bracket, as shown, pivot the crystal downwards so that the hook rests in the end of the long slot.

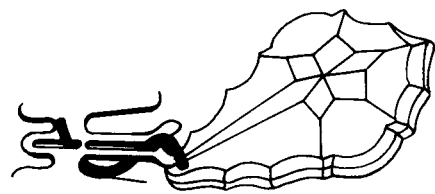

## TRIM ID SHEET FOR ORDERING SPARE PARTS. PLEASE SAVE FOR CLEANING FIXTURE!

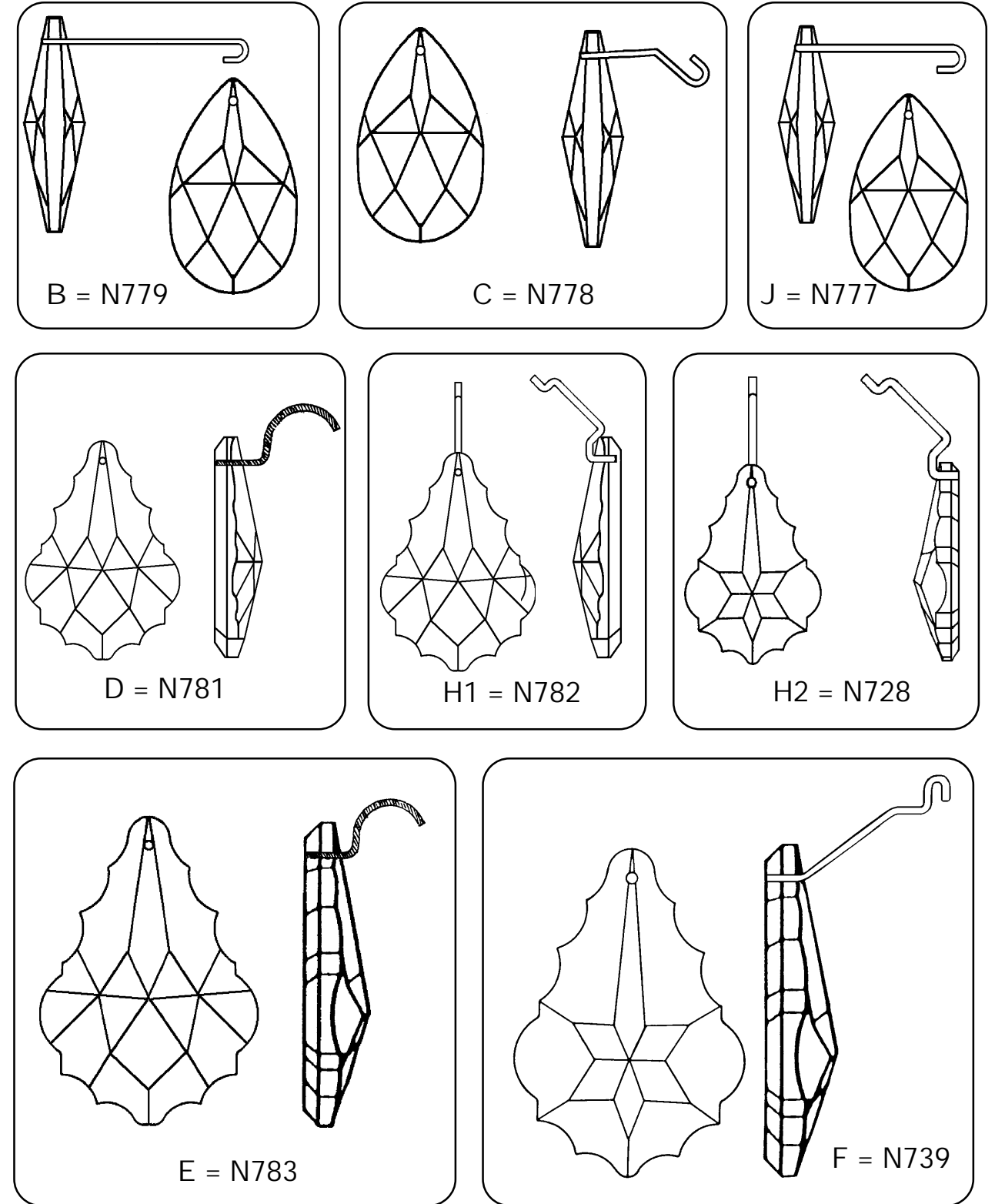

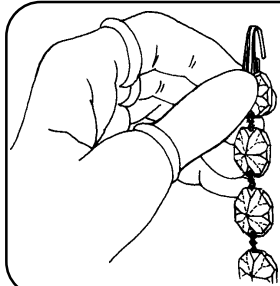

**7** Perspiration or oil from fingers will smear the crystals, causing a loss of brilliance. ALWAYS USE FINGER COTS PROVIDED WHEN HANDLING CRYSTALS. Cots should be used on thumb, index and middle fingers of each hand.

**8** Hook Crystal Chain "A1" (small crystal at top) into ring #3 pin hole and hook the bottom of the crystal chain into ring #4 leg. See diagram #1 for detailed instructions. Hook Crystal Chain "A2" (small crystal at top) into the ring #3 leg and hook the bottom of the crystal chain into ring #4 pin hole. See diagram #1 for detailed instructions. NOTE: Crystal Chain "A2" overlaps Crystal Chain "A1".

**9** Hook Crystal "B" into the back slot of the "Y" bracket of ring #2. See diagram #3 for detailed instructions. Hook Crystal "C" into the "plain" bracket of ring #2. See diagram #4 on page 6. Hook small Crystal "D" into every second "Y" bracket of ring #2. NOTE: Line-up with Ring #1 bracket. Crystal "D" and Crystal "F" line-up with one another. See diagram #5 on page 6. Hook large Crystal "E" into the remaining "Y" brackets on the ring #2. See diagram #5 on page 6.

**10** Hook large Crystal "F" into the leg bracket of ring #1. NOTE: Crystal "F" should line-up with Crystal "D".

**11** Attach horse shoe bracket with finial into holes in down light. HINT: Take out round bulb for easier installation of the horse shoe bracket. Hook Crystal Chain "G" (large crystal at top) into the ring #8. ALTERNATE hooking Crystal "H1" and Crystal "H2" into the lexan washer on the finial assembly. See diagram #2 for detailed instructions.

**12** Hook the bottom of Chains "G" into the lexan washer. Close bottom hook after inserting into washer.

**13** Hook Crystal "J" into the back slot (the "Y" is cut off) of ring #7. See diagram #3 for detailed instructions. Hook Crystal "C" into the "plain" bracket of ring #7. See diagram #4 on page 6.

**14** Hook Crystal "B" into the back slot (the "Y" is cut off) of ring #6. See diagram #3 for detailed instructions. Hook Crystal "C" into the "plain" bracket of ring #6. See diagram #4 on page 6.

**15** Hook Crystal "B" into the back slot of the "Y" bracket of ring #5. See diagram #3 for detailed instructions. Hook Crystal "C" into the "plain" bracket of ring #5. See diagram #4 on page 6. Hook small Crystal "D" into every second "Y" bracket of ring #5. See diagram #5 on page 6. Hook large Crystal "E" into the remaining "Y" brackets of ring #5. See diagram #5 on page 6.

