

# TOMCAT<sup>®</sup>

Handmade in U.S.A. - Est 1986

Premium Rider Scrubbers **v2.0**

PRO

CRZ

EX



*Family-Owned & Operated*



Burnisher

Scrubbers

Sweepers

# Choose Your Chassis



## PRO v2.0 Specs

- Up to 140,000 sqft/Charge
- 22 / 23 Gallons
- 25 - 29 inch decks

## Applications

- Education
- Healthcare
- Hospitality



## CRZ v2.0 Specs

- Up to 282,000 sqft/Charge
- 33 / 36 Gallons
- 25 - 34 inch decks

## Applications

- Retail
- Grocery
- Distribution



## EX v2.0 Specs

- Up to 280,000 sqft/Charge
- 46 / 49 Gallons
- 29 - 37 inch decks

## Applications

- Warehouses
- Sports Arenas
- Aviation

# Choose Your Deck

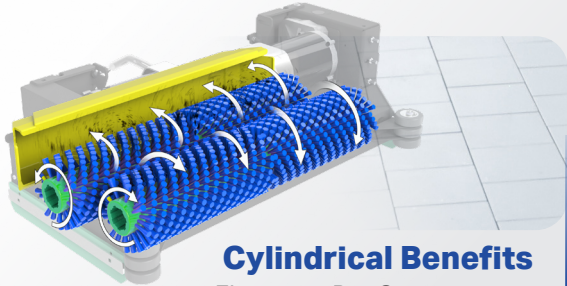

## Cylindrical Benefits

- Eliminates Pre-Sweeping
- Scrub & Sweep Simultaneously
- Superior Tile & Grout Cleaning
- Great for Indoor Track Fields

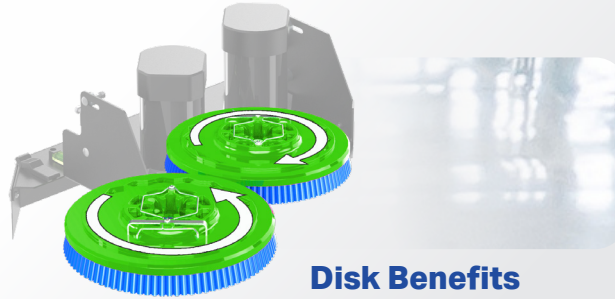

## Disk Benefits

- Largest Brush/ Pad Selection
- Lowest Maintenance Cost
- Best Performance on Irregular Floors
- Brushes Individually driven

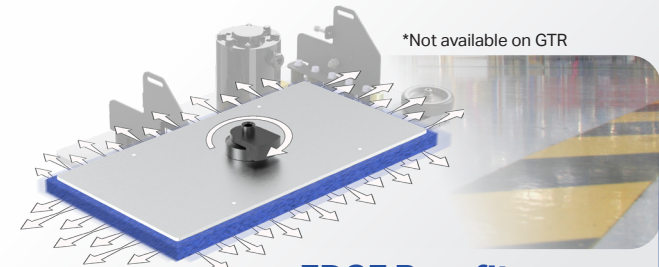

\*Not available on GTR

## EDGE Benefits

- Chemical Free Stripping
- Reduce Slip & Fall Potential
- 70% Reduction in Water Usage
- VCT Prep & Recoat

# Choose Your Controller

## Military Grade

(Year 1970 Technology)



## Legacy

(Year 2000 Technology)



## Touch Screen

(Year 2010 Technology)

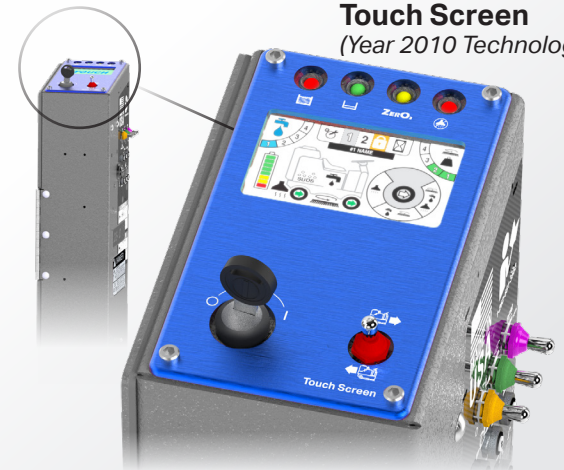

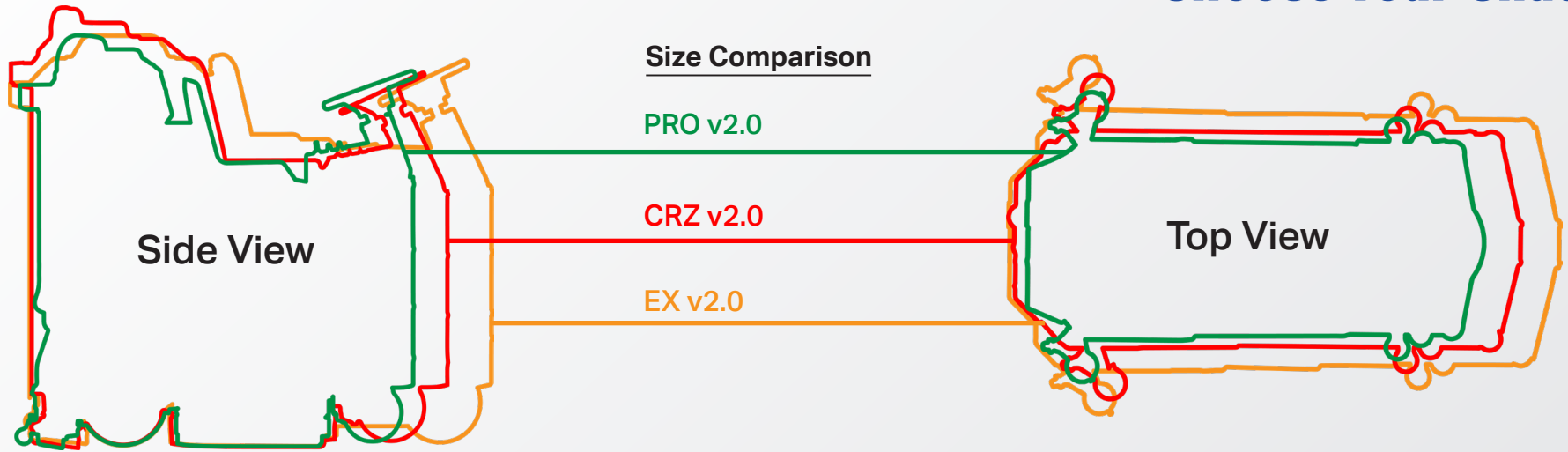

- ①\* Polypropylene: Black / Medium - Light
- ② Nylon: White / Light - Soft
- ③ Tampico: Tan / Soft
- ④\* Tufted Pad Driver: Red / Variety Pads
- ⑤\* Neoprene Pad Driver: Black / Variety Diamond Pucks
- ⑥\* Super Grit: Orange / Extreme Rough
- ⑦ Tough Grit: Black / Very Rough
- ⑧ Midi Grit: Blue / Rough
- ⑨ Light Grit: Grey / Medium

\*Not offered on Cylindrical Brushes

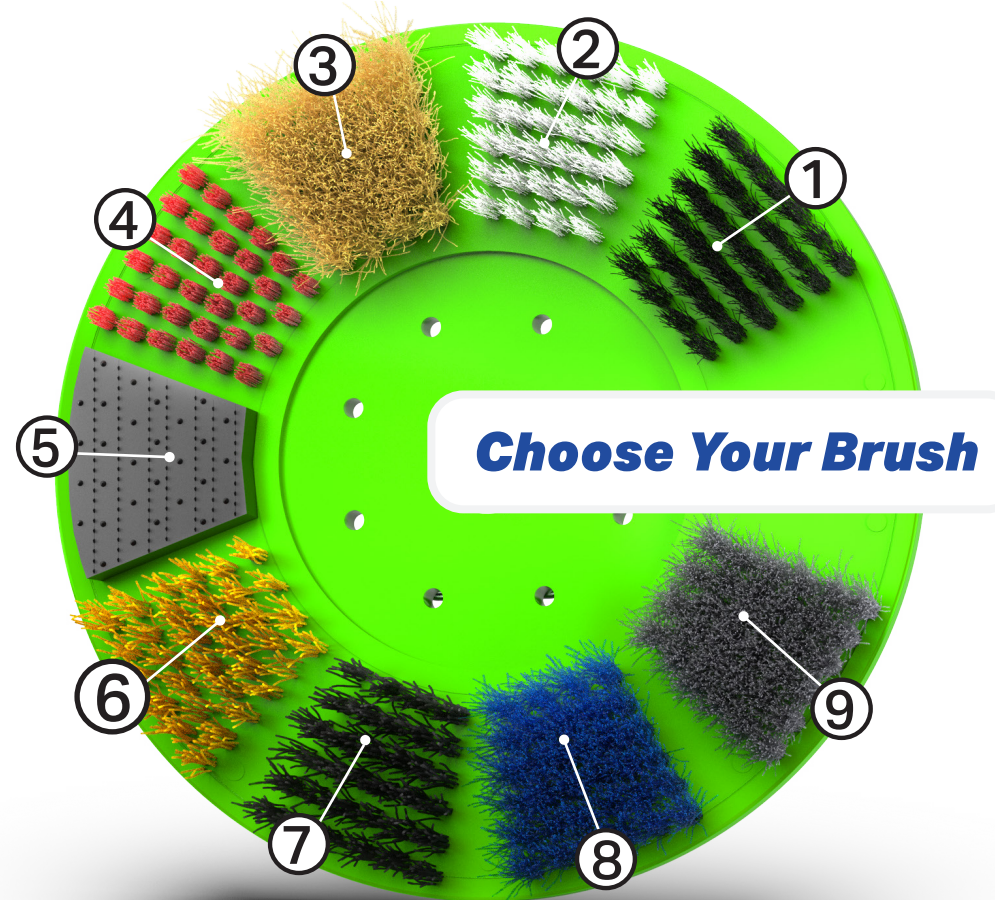

# View Inside

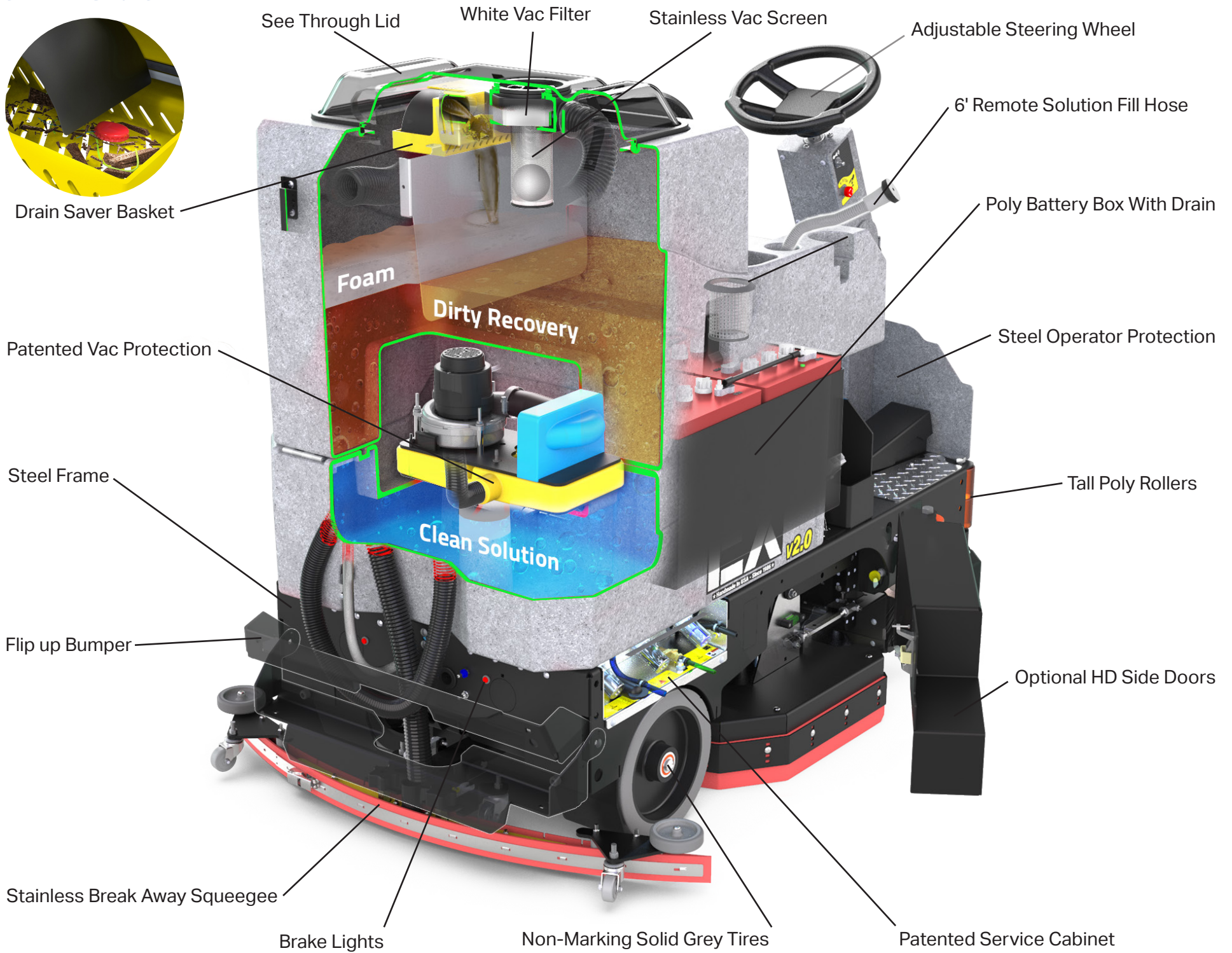
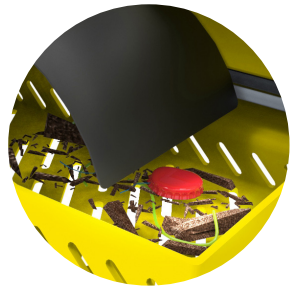

## Choose Your Options



### Green Antimicrobial Tanks

Special plastic formula inhibits growth of bacteria and other harmful contaminants inside tanks. The vac motor on all scrubbers suck air through the recovery tank and therefore will dispense odors or contaminants back into the air everyone inhales inside the building.

- Almost 6,000 cubic feet/hour of airflow (size average classroom).



### Scrub And Vac Wand / Spray Jet

- Brush side for floor scrubbing
- Squeegee side for water pickup
- Clean restrooms and under tables
- Pre-soak the floor before scrubbing
- Rinse out the Recovery Tank

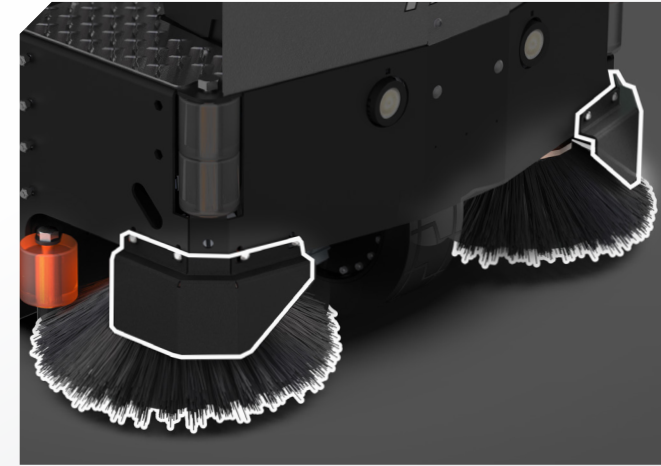

### Dual Side Brooms And Guards

Extends the cleaning path up to walls and racking pallets. Moving small debris to center of path reduces squeegee streaking and hose clogs.

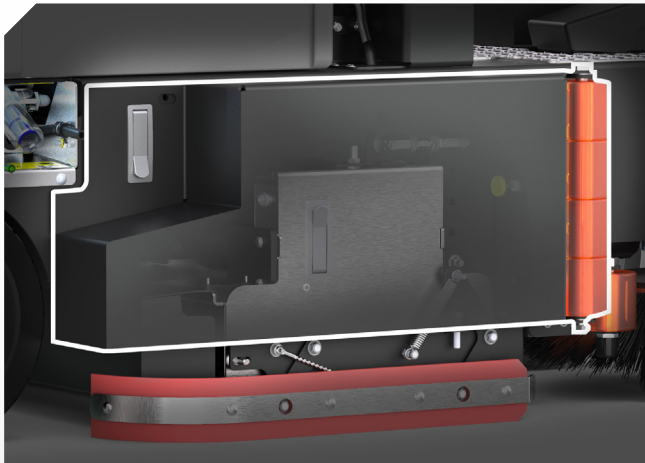

### Heavy Duty Side Doors

Thick Steel with leading rollers offers protection of critical scrub deck, reducing equipment damage and down time for repairs.

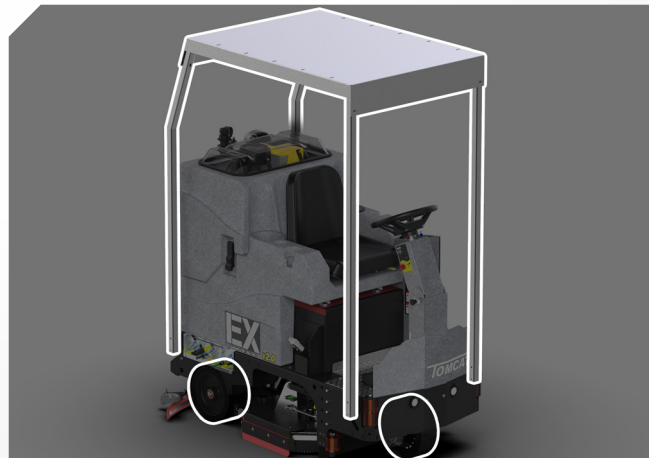

### Overhead Guard / Black Tires

- Protects operator from falling objects\*  
*\*Not available on all riders*
- Optional Black Tires for harsh applications

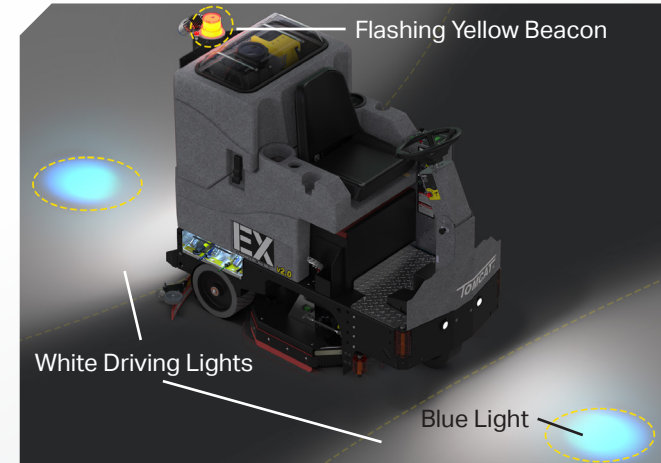

### Lights

- Traditional white flood lights ahead and behind increase visibility for the operator and oncoming traffic
- Blue spotlight warns oncoming traffic and pedestrians in congested and noisy applications.
- Flashing Yellow Beacon

# You Be The Judge

Easy Access to key components:

- Vac Motor
- Batteries
- Deck Actuator
- Solution Valve
- Filters-Screens
- Soap Drain
- Battery Box Drain
- Unloader Valve
- Vac Switch
- Pumps

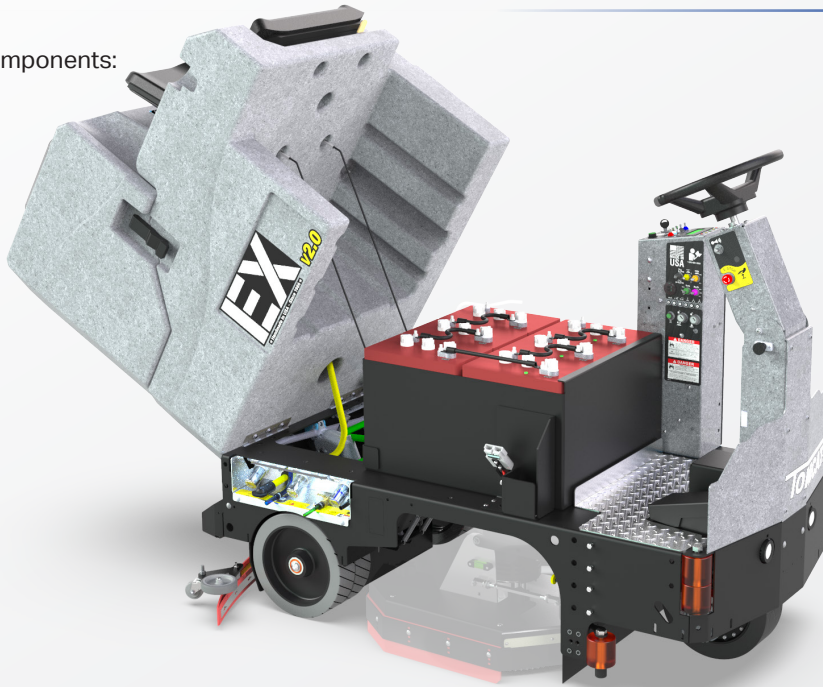

## Tip Back Tank

Our designers and engineers have 25+ years of experience and recognize cleaning equipment will eventually require service.

- Tanks tip back without tools, providing easy top side access to all important service items.
- Quick access allows the technician to trouble shoot from their feet and make repairs in less time, with less chance of creating unintended problems from disassembling multiple items to get to the single part that failed.



## Large Clear Lid

Any customer who has previously owned and operated cleaning equipment will appreciate the value of full time viewing of the dirty water recovery tank.

- This provides the operator with a real time view of the dirty water level, foam, debris tray, the vacuum's white vac filter and more.
- The fully accessible recovery tank is perhaps our most significant feature for cost reduction. Open the lid to clean out the recovery tank, eliminating odors and other contaminants which can become airborne and inhaled by employees.

## Steel Frame

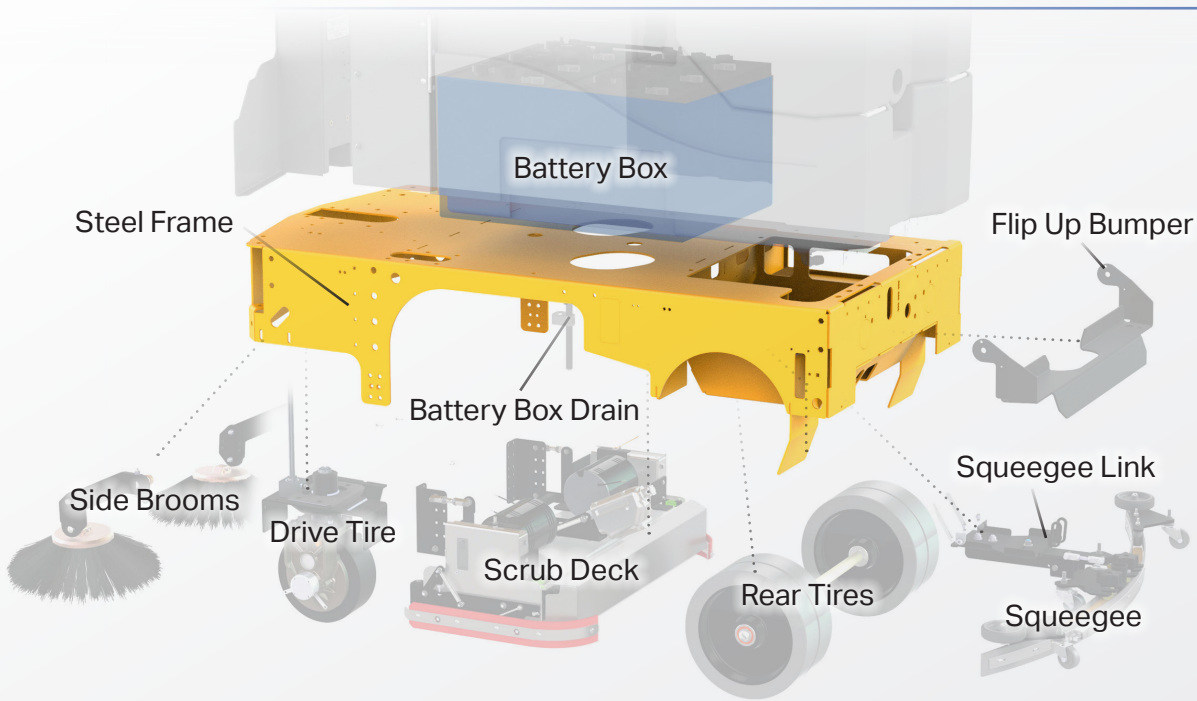

We spend the extra time and money to through-bolt with stainless fasteners for longevity and service ease in the future. Some of our larger rider scrubbers have 750-lbs in batteries in a full height poly liner, supported by the steel frame.

- All assemblies mount directly to the 7-ga (3/16" thick) steel frame, instead of plastic parts that will fatigue in time.
- Accidental damage to bumpers, decks, wheels, or over tensioning the frame during transport will not damage our tanks since we don't bolt collision points to the poly tank.

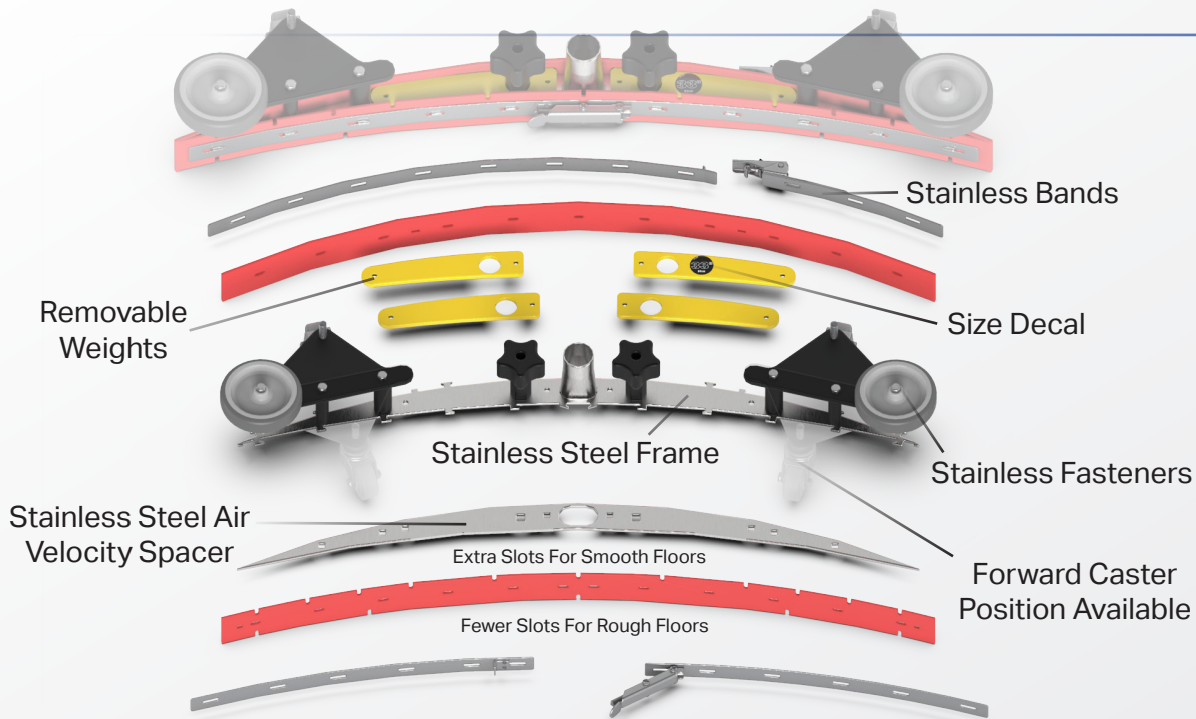

## Stainless Squeegee

- Parts exposed to recovery water are stainless steel
- Locking latches front and rear
- Range of material for different applications
- Smooth and Rough floor hole patterns

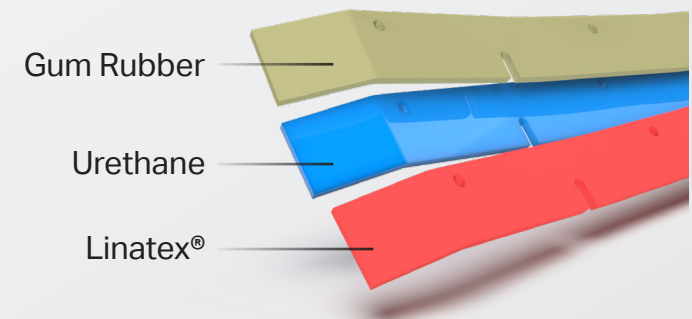

## You Be The Judge



## Baffle System

- The dirty water passes into our drain saver basket, and then fills up the rear side of the baffle such that the foam doesn't migrate to the front where the stainless screen and float ball operates.
- The stainless screen and white vacuum filter offer protection and ensure good airflow (squeegee performance).

## Patented Vac Box System

- This invention earned a US Patent. The Yellow Vac Box is vacuumized and safely stores up to 1-gallon of foam or dirty water away from the vac motor's intake.
- Dirty water drains out of the Yellow Vac Box via Unloader Valve as soon as vacuum is turned OFF.
- The Blue Muffler Box reduces the noise and directs moisture out to the bowls, alerting the operator of a problem.

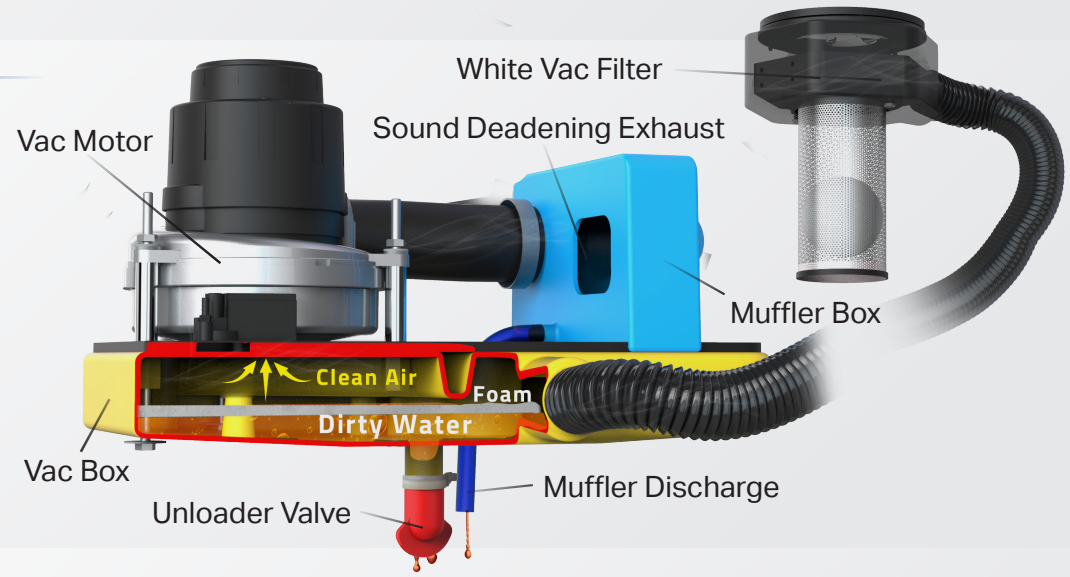

## Patented Service Cabinet

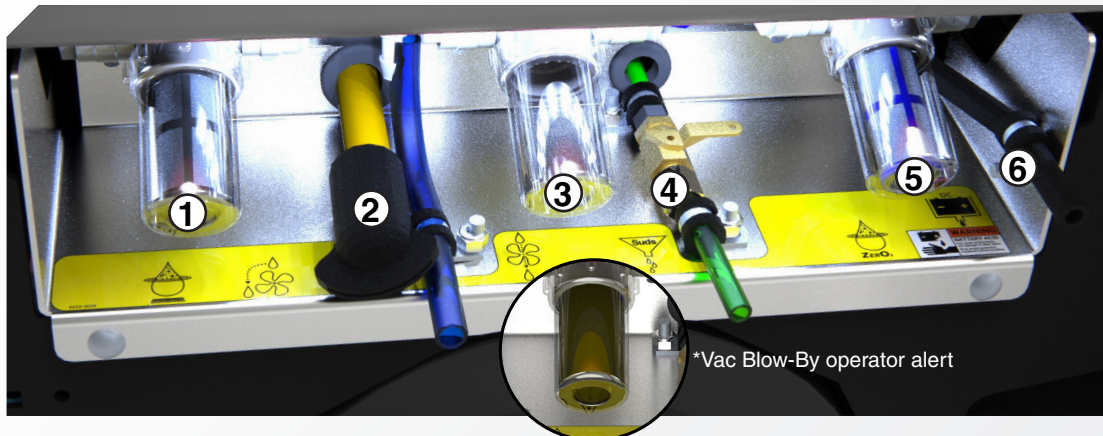

- ① Solution Filter: Screen fresh water to scrub deck
- ② Unloader Valve: Auto drains dirty water protecting Vac
- ③ Vac Blow-By: Collects vac moisture to alert operator
- ④ Suds Valve: Drain soap from Suds Reservoir
- ⑤ ZERO3 Filter: Screen Aqueous Ozone solution
- ⑥ Battery Box Valve: Drain excess electrolyte safely





## Education

Schools frequently value the maneuverability of our designs for those congested areas and small elevators. Both K through 12 and universities utilize the superior productivity from our large tank capacities and run time. Onboard ozone (ZER03) and our EDGE Orbital technology greatly reduce the use of chemicals and afford meaningful cost savings.



## Healthcare

Low noise and optimized water control are key features our healthcare customers require. Our patented vacuum protection and muffler system allow for high performance motors to operate at unmatched levels. These scrubbers combine heavy duty cleaning and drying with noise levels suitable for facilities that operate around the clock.



## Gymnasium

Our products are used extensively on wood, vct, rubber running tracks, concrete, artificial turf and other surfaces that are unique to athletics departments. The wide range of scrub head types and sizes, combined with the assortment of brushes and pads allow for the greatest flexibility.



## Hotels - Hospitality

Food and guests services require a high level of cleaning and frequency. Equipment that can cut through heavy grease, navigate commercial kitchens and public lobbies alike. Hotel and resort casinos understand the cleaning equipment must be available to operate 24/7 and often perform housecleaning role in close proximity to customers.



## Retail - Grocery

Many in this category are moving away from the cheap imported products to our American made equipment that affords them better cleaning performance and less downtime for repairs. Shopping malls, large retail box stores and grocery stores have high daily traffic and often need to clean up product spills promptly in the presence of customers. A quiet and quality cleaning machine sends a good message to the clients that the organization values sanitation.



## Distribution - Warehouse

Our company "industrial equipment" origins result in the most durable equipment offered to the "commercial" sector. Warehouse and distribution centers utilize powerful material handling equipment and steel racking. The cleaning equipment needs to be built to pick up heavy soil, broken pallets, nails and also survive the inevitable collisions with fork trucks and racking.



## PRO v2.0

<b>Chassis Construction:</b>	1/8" Steel (3.1 mm) Powder Coated
<b>Front Wheels (Ø x Width):</b>	8" x 3" (20 x 7 cm) - Solid Grey, Non-Marking
<b>Rear Wheels (Ø x Width):</b>	(2x) 12" x 3" ((2x) 30 x 7 cm) - Solid Black
<b>Size (L x W x H):</b>	53" x 31" x 57" (134 x 78 x 144 cm)
<b>Weight (w/o Batteries):</b>	525 - 575 lbs (238 - 261 kg)
<b>Weight (w/ Batteries):</b>	825 - 875 lbs (374 - 397 kg)
<b>BRUSH / PAD SYSTEM</b>	
<b>Disk Dimensions:</b>	26" - (2x) 13" Ø (66 - [2x] 33 cm) 28" - (2x) 14" Ø (71 - [2x] 35 cm)
<b>Disk Motor:</b>	(2x) 0.75 hp ((2x) 551 watts)
<b>Disk Brush Speed:</b>	270 rpm
<b>Cylindrical Dimensions:</b>	25" - (2x) 6" Ø x 23" (64 - [2x] 15 x 58 cm) 29" - (2x) 6" Ø x 27" (73 - [2x] 15 x 68 cm)
<b>Cylindrical Motor:</b>	(2x) 0.75 hp (2x) 551 watts
<b>Cylindrical Brush Speed:</b>	650 rpm Standard - 825 optional rpm
<b>EDGE Dimensions:</b>	24" x 14" (60 x 35 cm) 28" x 14" (71 x 35 cm)
<b>EDGE Motor:</b>	1.2 hp (882 watts) 2,500 rpm
<b>Brush Down Pressure:</b>	Up to 150 lbs (68 kg) / 500 lbs (227 kg) Actuator Rating
<b>POWER SYSTEM</b>	
<b>System Voltage/Amps</b>	36 VDC / 175 ah WET
<b>Optional Battery:</b>	Up to 225 ah WET / 200 ah AGM*
*Includes Onboard Charger	
<b>Run Time:</b>	Up to 3.5 Hours**
**Based on continuous scrubbing run times.	
<b>DRIVE SYSTEM</b>	
<b>Power:</b>	0.75 hp - All Gear / Sealed (559 watts)
<b>Forward Speed:</b>	0 - 320 ft/min / 0 - 3.6 mph (0 - 98 m/min / 0 - 6 km/h)
<b>Scrubbing Speed:</b>	0 - 256 ft/min / 0 - 2.9 mph (0 - 78 m/min / 0 - 5 km/h)
<b>Reverse Speed:</b>	0 - 230 ft/min / 0 - 2.6 mph (0 - 70 m/min / 0 - 4 km/h)
<b>SOLUTION / RECOVERY SYSTEMS</b>	
<b>Solution Tank Capacity:</b>	22 Gallons (83 liters) - w/ Graduated Site Tube
<b>Solution Flow / Filter:</b>	0 - 0.5 GPM / Stainless Inline (0 - 2 LPM)
<b>Recovery Tank Capacity:</b>	23 Gallons (87 liters) - 1.5" Ø Drain Hose
<b>Demisting Chamber:</b>	1.25 Gallons (4.7 liters)
<b>Drain Saver:</b>	130 cubic inches (2,130 cubic cm)
<b>Vacuum Power</b>	1.0 hp / 2 Stage / 6.6" Ø (551 watts)
<b>(Water Lift / Airflow):</b>	73" / 96 cfm (185 cm / 2.7 cm/m)
<b>GENERAL</b>	
<b>Productivity - Theoretical:</b>	Up to 40,000 sqft/hr (3,716 sqm)***
***Based off of ISSA 2010 Cleaning Times	
<b>Productivity - Practical:</b>	Up to 18,518 sqft/hr (1,720 sqm)***
***Based off of ISSA 2010 Cleaning Times	



## CRZ v2.0

<b>BODY CONSTRUCTION / DIMENSIONS</b>	
<b>Chassis Construction:</b>	3/16" Steel (4.8 mm) Powder Coated
<b>Front Wheels (Ø x Width):</b>	10" x 3" (25 x 7 cm) - Solid Black
<b>Rear Wheels (Ø x Width):</b>	(2x) 12" x 3" ((2x) 30 x 7 cm) - Solid Black
<b>Size (L x W x H):</b>	66" x 34" x 64" (167 x 86 x 162 cm)
<b>Weight (w/o Batteries):</b>	725 lbs - 850 lbs (328 - 385 kg)
<b>Weight (w/ Batteries):</b>	1,195 - 1,325 lbs (542 - 601 kg)
<b>BRUSH / PAD SYSTEM</b>	
<b>Disk Dimensions:</b>	26" - (2x) 13" Ø (66 - [2x] 33 cm) 28" - (2x) 14" Ø (71 - [2x] 35 cm) 30" - (2x) 15" Ø (76 - [2x] 38 cm) 34" - (2x) 17" Ø (86 - [2x] 43 cm)
<b>Disk Motor:</b>	(2x) 0.75 hp ((2x) 551 watts)
<b>Disk Brush Speed:</b>	270 rpm
<b>Optional Motor Upgrade:</b>	(2x) 1.5 hp 350 rpm ((2x) 1,103 watts)
<b>Cylindrical Dimensions:</b>	25" - (2x) 6" Ø x 23" (63 - [2x] 15 x 58 cm) 29" - (2x) 6" Ø x 27" (73 - [2x] 15 x 68 cm) 33" - (2x) 6" Ø x 31" (83 - [2x] 15 x 78 cm)
<b>Cylindrical Motor:</b>	(2x) 0.75 hp ((2x) 551 watts)
<b>Cylindrical Brush Speed:</b>	650 rpm Standard - 825 optional rpm
<b>EDGE Dimensions:</b>	28" x 14" (71 x 35 cm) 32" x 14" (81 x 35 cm)
<b>EDGE Motor:</b>	1.2 hp (882 watts) 2,500 rpm
<b>Brush Down Pressure:</b>	Up to 200 lbs (90 kg) / 500 lbs (227 kg) Actuator Rating
<b>POWER SYSTEM</b>	
<b>System Voltage/Amps</b>	36 VDC / 210 ah WET
<b>Optional Battery:</b>	Up to 360 ah WET / 335 ah AGM*
*Includes Onboard Charger	
<b>Run Time:</b>	Up to 6 Hours**
**Based on continuous scrubbing run times.	
<b>DRIVE SYSTEM</b>	
<b>Power:</b>	0.75 hp - All Gear / Sealed (559 watts)
<b>Forward Speed:</b>	0 - 320 ft/min / 0 - 3.6 mph (0 - 98 m/min / 0 - 6 km/h)
<b>Scrubbing Speed:</b>	0 - 256 ft/min / 0 - 2.9 mph (0 - 78 m/min / 0 - 5 km/h)
<b>Reverse Speed:</b>	0 - 230 ft/min / 0 - 2.6 mph (0 - 70 m/min / 0 - 4 km/h)
<b>SOLUTION / RECOVERY SYSTEMS</b>	
<b>Solution Capacity:</b>	33 Gallons (125 liters) - w/ Graduated Site Tube
<b>Solution Flow / Filter:</b>	0 - 0.7 GPM / Stainless Inline (0 - 2 LPM)
<b>Recovery Capacity:</b>	36 Gallons (136 liters) - 1.5" Ø Drain Hose
<b>Demisting Chamber:</b>	1.25 Gallons (4.7 liters)
<b>Drain Saver:</b>	130 cubic inches (2,130 cubic cm)
<b>Vacuum Power</b>	1.0 hp / 2 Stage / 6.6" Ø (551 watts)
<b>(Water Lift / Airflow):</b>	73" / 96 cfm (185 cm / 2.7 cm/m)
<b>GENERAL</b>	
<b>Productivity - Theoretical:</b>	Up to 47,000 sqft/hr (4,366 sqm)***
***Based off of ISSA 2010 Cleaning Times	
<b>Productivity - Practical:</b>	Up to 21,661 sqft/hr (2,012 sqm)***
***Based off of ISSA 2010 Cleaning Times	



## EX v2.0

<b>BODY CONSTRUCTION / DIMENSIONS</b>	
<b>Chassis Construction:</b>	3/16" Steel (4.8 mm) Powder Coated
<b>Front Wheels (Ø x Width):</b>	10" x 3" (25 x 7 cm) - Solid Black
<b>Rear Wheels (Ø x Width):</b>	(4x) 12" x 3" ((2x) 30 x 7 cm) - Solid Black
<b>Size (L x W x H):</b>	70" x 37" x 57" (177 x 93 x 144 cm)
<b>Weight (w/o Batteries):</b>	790 lbs - 914 lbs (358 - 414 kg)
<b>Weight (w/ Batteries):</b>	1,260 - 1,436 lbs (571 - 651 kg)
<b>BRUSH / PAD SYSTEM</b>	
<b>Disk Dimensions:</b>	30" - (2x) 15" Ø (76 - [2x] 38 cm) 34" - (2x) 17" Ø (86 - [2x] 43 cm) 36" - (2x) 18" Ø (91 - [2x] 45 cm)
<b>Disk Motor:</b>	(2x) 1.5 hp 350 rpm ((2x) 1,103 watts)
<b>Disk Brush Speed:</b>	350 rpm
<b>Cylindrical Dimensions:</b>	29" - (2x) 6" Ø x 27" (73 - [2x] 15 x 68 cm) 33" - (2x) 6" Ø x 31" (83 - [2x] 15 x 78 cm) 37" - (2x) 6" Ø x 35" (94 - [2x] 15 x 89 cm)
<b>Cylindrical Motor:</b>	(2x) 1.5 hp 350 rpm ((2x) 1,103 watts)
<b>Cylindrical Brush Speed:</b>	825 rpm
<b>EDGE Dimensions:</b>	N/A
<b>EDGE Motor:</b>	N/A
<b>Brush Down Pressure:</b>	Up to 225 lbs (102 kg) / 500 lbs (227 kg) Actuator Rating
<b>POWER SYSTEM</b>	
<b>System Voltage/Amps</b>	36 VDC / 245 ah WET
<b>Optional Battery:</b>	Up to 360 ah WET / 335 ah AGM*
*Includes Onboard Charger	
<b>Run Time:</b>	Up to 5.5 Hours**
**Based on continuous scrubbing run times.	
<b>DRIVE SYSTEM</b>	
<b>Power:</b>	1.0 hp - All Gear / Sealed (551 watts)
<b>Forward Speed:</b>	0 - 320 ft/min / 0 - 3.6 mph (0 - 98 m/min / 0 - 6 km/h)
<b>Scrubbing Speed:</b>	0 - 256 ft/min / 0 - 2.9 mph (0 - 78 m/min / 0 - 5 km/h)
<b>Reverse Speed:</b>	0 - 230 ft/min / 0 - 2.6 mph (0 - 70 m/min / 0 - 4 km/h)
<b>SOLUTION / RECOVERY SYSTEMS</b>	
<b>Solution Capacity:</b>	46 Gallons (174 liters) - w/ Graduated Site Tube
<b>Solution Flow / Filter:</b>	0 - 0.7 GPM / Stainless Inline (0 - 2 LPM)
<b>Recovery Capacity:</b>	49 Gallons (185 liters) - 1.5" Ø Drain Hose
<b>Demisting Chamber:</b>	1.25 Gallons (4.7 liters)
<b>Drain Saver:</b>	130 cubic inches (2,130 cubic cm)
<b>Vacuum Power</b>	1.0 hp / 2 Stage / 6.6" Ø (551 watts)
<b>(Water Lift / Airflow):</b>	73" / 96 cfm (185 cm / 2.7 cm/m)
<b>GENERAL</b>	
<b>Productivity - Theoretical:</b>	Up to 51,000 sqft/hr (4,738 sqm)***
***Based off of ISSA 2010 Cleaning Times	
<b>Productivity - Practical:</b>	Up to 23,627 sqft/hr (2,195 sqm)***
***Based off of ISSA 2010 Cleaning Times	

# Our Family's American Dream

RPS has been family owned from its inception in 1986, and proudly builds in Wisconsin (USA). The company has grown over the last 35-years with a strong group of executives including the 2nd generation of family owners who started in the shop as youngsters.

Authorized Distributor



## Assembled By Hand

Our American workforce hand builds each machine with components sourced over 95% from American suppliers. We routinely pay more for these domestically supplied components required to build a superior product. All design, prototyping, production and testing is done in-house where we can best control quality.



## Steel Fabrication

We produce heavy duty equipment and require a good amount of thick steel in the construction. We use a combination of Stainless 304 (Austenitic 18/8) and mild steel with e-coating + powder paint for corrosion resistance. Steel fabrication is done in-house or from local suppliers with specialty equipment.



## Rotational Molding

Complex shapes that allow for our "tank-in-tank" design are best achieved with in-house equipment. We own multiple dual station rotational molding machines that allow us to produce finished parts from raw plastic. Producing consistently higher quality parts, and respond quickly to sales spikes.

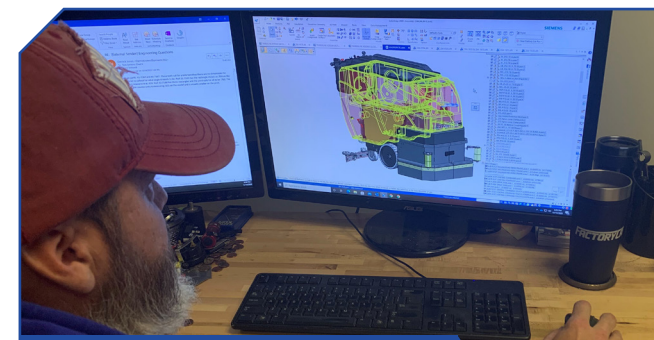

## Product Design

Our team has designed and engineered over 100 unique machines. Each new generation of machines evolve from prior designs to retain the strengths and correct any weakness. From the first pencil sketch we focus on durability, serviceability, performance, productivity, specifications, and value.