



Heartland LABEL PRINTERS

2020 SUPERMARKET WEIGH SCALE CATALOG

For Wholesalers and Resellers





www.hrtlp.com

WEIGH SCALE LABELS

Same day shipment and specialty services.

Heartland has more than 1,300 stock and custom label selections for nearly all the leading thermal weigh scale printers available today (call for a complete list).

We offer a number of in-house services to help you including:

- ✓ Same-Day Shipment of In-Stock Labels
- ✓ Rapid Turnaround on Custom Orders
- ✓ Drop Shipments & Blind Labeling
- ✓ Just-In-Time Delivery
- ✓ Stocking/Warehousing Programs
- ✓ Specialized Delivery Programs
- ✓ No Plate Charge for Existing Copy
- ✓ In-House Art & Graphic Design Services



Whatever you need, Heartland is committed to helping you meet your delivery requirements ... time after time.



Heartland

LABEL PRINTERS

The listing of brand names does not constitute endorsement of the products of Heartland Label Printers, LLC.

HEARTLAND LABEL PRINTERS, LLC TERMS AND CONDITIONS

ORDERS:

Please provide the Heartland part number, case quantity, shipping requirement, and any other pertinent information when placing all orders.

PAYMENT TERMS:

Net 30 days from the date of the invoice. Terms are based upon completion of a credit application and approval by Heartland. No subsequent orders will be processed for accounts over 30 days. Interest charges may apply after the 31st day.

Visa, MasterCard, and Discovery cards are accepted. A handling fee will be added for all credit card transactions.

FREIGHT:

All prices are F.O.B Little Chute, WI. Freight charges may include a small handling fee.

DELIVERY CLAIMS:

Title to goods is passed to purchaser upon transfer of the Bill of Lading to the carrier. All discrepancies must be noted by the customer on the Bill of Lading at the time of delivery. Heartland will not make adjustments without delivery receipt verification.

COMBINING ORDERS:

Stock labels may only be combined with each other for column pricing. Custom labels may not be combined with stock labels for column pricing.

ARTWORK:

Adobe Illustrator Vector Images or Adobe Acrobat Reader files are required for all artwork. If artwork is not provided then scan and redraw charges will apply. Price estimates will be provided upon request for art and redraw charges. Labor for art work is invoiced at \$50/hour.

PROOF ACCEPTANCE:

Heartland requires a customer signature for every proof provided. This is the customer's acknowledgement and acceptance that the label is accurate in layout and copy and is ready for production.

PLATE CHARGES:

A one-time plate charge applies for first time orders and when changes are requested by the customer on existing labels:

# of Colors	Charge	# of Colors	Charge
1 Color	\$ 62.50	2 Color	\$ 79.50
3 Color	\$ 94.50	4 Color	\$ 115.00
5 Color	Please call for pricing	6 Color	Please call for pricing

CUSTOM PRINTING:

Heartland recommends print areas of labels to be ink free. The customer is fully responsible for all print-head damage caused by the customer's request for ink coverage in the machine print areas.

CUSTOM INK CHARGE:

A \$25.00 charge per part number per order will apply for non-standard colors or color matching. A standard ink color page follows the Terms and Conditions section. This charge is waived for orders of 25 cases or more.

STOCK LABELS:

To meet customer demands, Heartland carries many of the popular stock labels in inventory and continually evaluates these levels. Please contact Heartland to verify stock label availability.

CREDITS AND RETURNS:

Defective Product Returns:

Defective product credits and returns apply only to product less than one (1) year from the invoice date. Customer must provide Heartland with the original invoice number for all credit and return requests. Heartland will issue a Return Request number for each customer request for credit. Defective product returns may require the customer to ship the product, at Heartland's expense, back to Heartland for analysis. Heartland will investigate the situation and either approve or deny the credit request. Full credit will be issued for all approved requests.

Non-Defective Product Returns:

Non-defective product credits and returns apply only to product less than six (6) months from the invoice date, are in their original packaging, and in the same condition as when sold. Customer must provide Heartland with the original invoice number for all credit and return requests. Heartland will issue a Return Request number for each customer request for credit. Non-defective product will be shipped back to Heartland at the customer's expense. Heartland will investigate the situation and either approve or deny the credit request. For approved requests, a credit will be issued for the invoice amount minus a 25% restock fee and minus any freight charges that were originally paid by Heartland.

The Return Request number must be clearly marked on all documentation and product shipped back to Heartland.

Denied Requests:

Should a Return Request be denied, product will be shipped back to the customer and no credit will be issued.

PRODUCT ILLUSTRATIONS:

Label illustrations are for general reference only.

WARRANTY TO OUR CUSTOMERS:

Heartland Label Printers, LLC offers technical data, provides samples, and makes recommendations based upon tests and research, which are believed to be reliable, but do not constitute a warranty or guarantee. Whenever product is sold or a sample provided, it is with the understanding that the purchaser and/or end-user has determined the product to be suitable for applications under its own operating conditions.

Due to the ability of many different weigh scale/printers to use other than their own specified sizes any errors in label materials resulting from incorrect information or custom adjustments to printers is not the responsibility of Heartland Label Printers, LLC.

Heartland Label Printers, LLC warrants our products to be free of material and/or workmanship defects. Should any product be determined as defective within one year after the date of shipment, we will replace the product or issue a credit based upon the cost of the defective product. Heartland Label Printers, LLC liability shall be limited to replacement of the defective product or a credit based upon the cost of the defective product. In no event will Heartland Label Printers, LLC be liable for customer's loss of profits or any other consequential damages.

Further, all products sold are without any warranty as to merchantability or fitness for a particular purpose, or any other warranty expressed or implied. No representative or agent of Heartland Label Printers, LLC is authorized to give any warranty, guarantee, or make any representation in addition to or contrary to the foregoing provisions.

RIGHT TO CHANGES:

Heartland reserves the right to make changes to this catalog and to these Terms and Conditions with or without notice.

UNWIND CHART

OUTSIDE WINDS

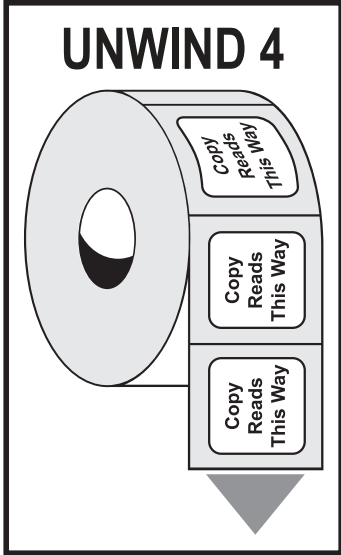
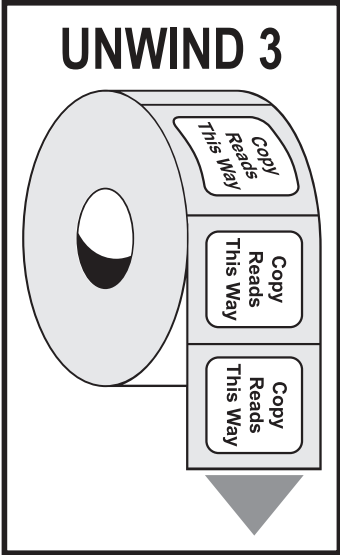
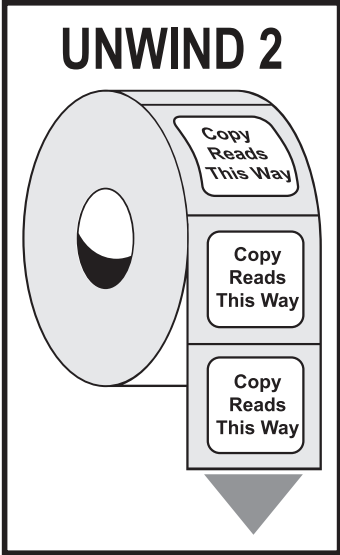
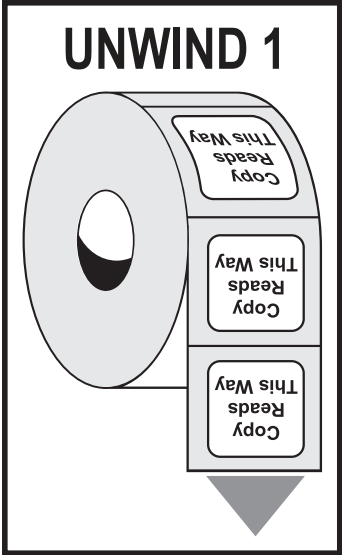

INSIDE WINDS

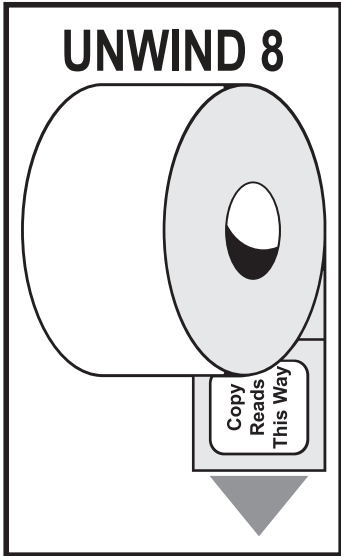
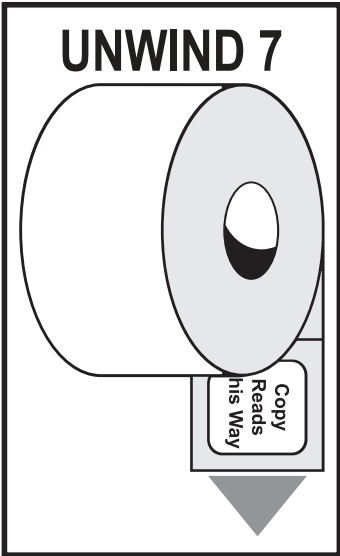
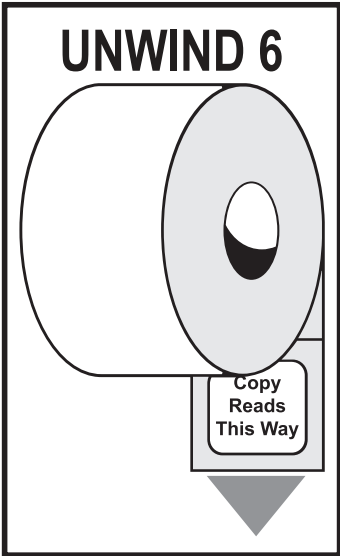
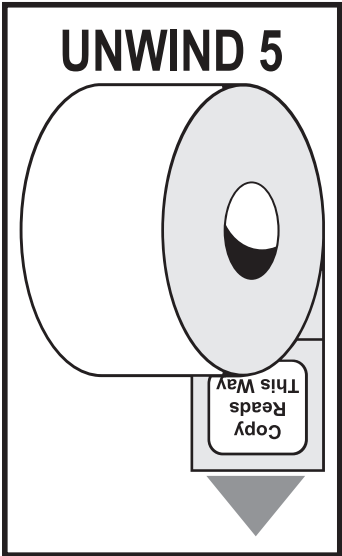

Table of Contents

Berkel	1845	29	1723	53
1432	7	1881	29	1724
1433	7	1907	29	1725
1434	7	1909	30	1726
1435	8	1910	30	1727
1437	8	1911	31	1728
1454	9	1912	31	1729
1465	9	1913	32	1730
1472	10	1914	32	1731
1481	10	1916	33	1732
1482	11	1918	33	1733
1483	11	1919	33	1739
1487	11	1946	34	1740
1488	12			1742
		Ishida		1755
Bizerba	1813	35	1756	60
1850	13	1814	35	1760
1851	13	1815	35	1766
1853	13	1819	36	1769
1855	14	1820	36	1776
5865	14	1821	37	1777
		1822	37	1779
Cas	1824	38	1780	63
1396	15	1828	38	1782
1398	15	1831	38	1783
1399	15	1834	39	1784
1477	16	1837	39	1785
1478	16	1838	39	1790
1479	17	1839	40	
1493	17	1842	40	Tor-Rey
		1843	40	1378
		1844	41	1393
		1848	41	
		1856	42	
Digi				
1502	18	Safe Handling		
1504	18	1000	43	
1516	18			
1518	19	Tec		
1523	19	1600	44	
1524	19	1612	44	
1525	20	1640	45	
1526	20	1663	45	
1531	21	1673	46	
1534	21	1676	46	
1536	22	1680	47	
1537	22	1681	47	
1538	23	1682	48	
1539	23	1683	48	
1541	23	1685	49	
1542	24			
1546	24	Toledo		
1547	24	1100	50	
1548	25	1120	50	
Globe		1710	50	
1587	26	1711	51	
		1714	51	
Hobart		1715	51	
1800	27	1716	52	
1801	27	1718	52	
1802	28	1719	52	
1827	28	1721	53	

Berkel IX/IM Series 40mm

Heartland Product Family: 1432

Recommended for use on these units: Berkel IX/IM Series 40mm

Width	Length	Labels / roll	Rolls / case	Core ID	Roll OD	Weight / case	Cases / pallet
58 mm	40 mm	950	12	1.63 in	3.9 in	12 lbs	100

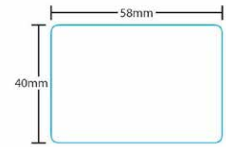

Stock Labels

Item #	Colors	Features	5-24 CS	25-49 CS	50+ CS
1432-B	Blank				

Custom Labels

Item #	Colors	Features	5-24 CS	25-49 CS	50+ CS
1432-1	1-Color				
1432-2	2-Color				
1432-3	3-Color				

Berkel IX/IM Series 65mm

Heartland Product Family: 1433

Recommended for use on these units: Berkel IX/IM Series 65mm

Width	Length	Labels / roll	Rolls / case	Core ID	Roll OD	Weight / case	Cases / pallet
58 mm	65 mm	580	12	1.63 in	3.9 in	12 lbs	100

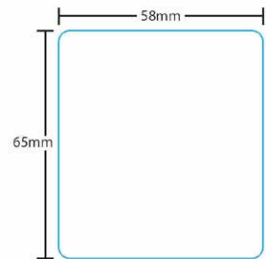

Stock Labels

Item #	Colors	Features	5-24 CS	25-49 CS	50+ CS
1433-B	Blank				

Custom Labels

Item #	Colors	Features	5-24 CS	25-49 CS	50+ CS
1433-1	1-Color				
1433-2	2-Color				
1433-3	3-Color				

Berkel IX/IM Series 75mm

Heartland Product Family: 1434

Recommended for use on these units: Berkel IX/IM Series 75mm

Width	Length	Labels / roll	Rolls / case	Core ID	Roll OD	Weight / case	Cases / pallet
58 mm	75 mm	510	12	1.63 in	3.9 in	12 lbs	100

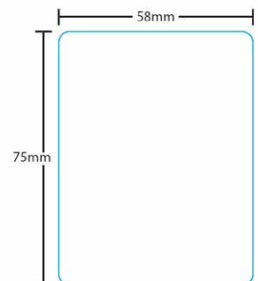

Stock Labels

Item #	Colors	Features	5-24 CS	25-49 CS	50+ CS
1434-B	Blank				

Custom Labels

Item #	Colors	Features	5-24 CS	25-49 CS	50+ CS
1434-1	1-Color				
1434-2	2-Color				
1434-3	3-Color				

Berkel IX/IM Series 100mm

Heartland Product Family: 1435

Recommended for use on these units: Berkel IX/IM Series 100mm

Width	Length	Labels / roll	Rolls / case	Core ID	Roll OD	Weight / case	Cases / pallet
58 mm	100 mm	380	12	1.63 in	3.9 in	11 lbs	100

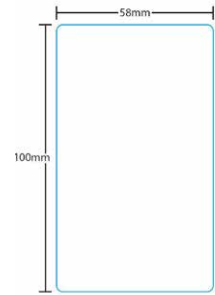

Stock Labels

Item #	Colors	Features	5-24 CS	25-49 CS	50+ CS
1435-B	Blank				

Custom Labels

Item #	Colors	Features	5-24 CS	25-49 CS	50+ CS
1435-1	1-Color				
1435-2	2-Color				
1435-3	3-Color				

Berkel IX/IM Series Edge to Edge Continuous Strip

Heartland Product Family: 1437

Recommended for use on these units: Berkel IX/IM Series Edge to Edge Continuous Strip

Width	Length	Labels / roll	Rolls / case	Core ID	Roll OD	Weight / case	Cases / pallet
58 mm	1570 in	1570	12	1.63 in	3.9 in	12 lbs	100

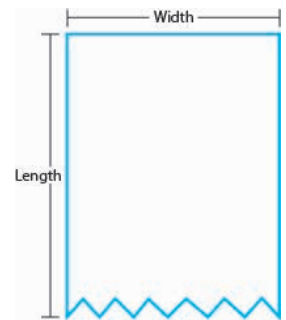

Stock Labels

Item #	Colors	Features	5-24 CS	25-49 CS	50+ CS
1437-B	Blank				

Custom Labels

Item #	Colors	Features	5-24 CS	25-49 CS	50+ CS
1437-1	1-Color				
1437-2	2-Color				
1437-3	3-Color				

Berkel GX250 58mm x 75mm

Heartland Product Family: 1454

Recommended for use on these units: Berkel GX250 58mm x 75mm

Width	Length	Labels / roll	Rolls / case	Core ID	Roll OD	Weight / case	Cases / pallet
58 mm	75 mm	410	12	1.63 in	3.5 in	10 lbs	160

Stock Labels

Item #	Colors	Features	5-24 CS	25-49 CS	50+ CS
1454-B	Blank				
1454-S/H	Black SH Only	Safe Handling			

Custom Labels

Item #	Colors	Features	5-24 CS	25-49 CS	50+ CS
1454	Red/Yellow				
1454-1	1-Color				
1454-2	2-Color				
1454-3	3-Color				

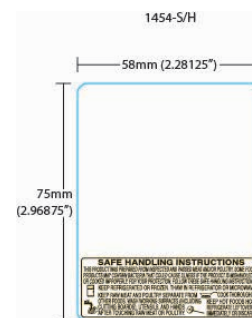

Berkel CX-17 76mm Safe Handling

Heartland Product Family: 1465

Recommended for use on these units: Berkel CX-17 76mm Safe Handling

Width	Length	Labels / roll	Rolls / case	Core ID	Roll OD	Weight / case	Cases / pallet
49 mm	76 mm	525	12	1.63 in	3.9 in	10 lbs	120

Custom Labels

Item #	Colors	Features	5-24 CS	25-49 CS	50+ CS
1465-1	1-Color				
1465-2	2-Color				
1465-3	3-Color				
1465-B	Blank				
1465-S/H	Black SH Only	Safe Handling			

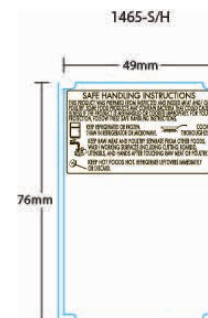

Berkel CX-20/30 65mm

Heartland Product Family: 1472

Recommended for use on these units: Berkel CX-20/30 65mm

Width	Length	Labels / roll	Rolls / case	Core ID	Roll OD	Weight / case	Cases / pallet
49 mm	65 mm	625	12	1.63 in	4.0 in	11 lbs	120

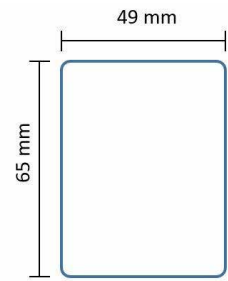

Stock Labels

Item #	Colors	Features	5-24 CS	25-49 CS	50+ CS
1472-B	Blank				

Custom Labels

Item #	Colors	Features	5-24 CS	25-49 CS	50+ CS
1472	Red/Yellow				
1472-1	1-Color				
1472-1P	1-Color	Perforated			
1472-2	2-Color				
1472-2P	2-Color	Perforated			
1472-3	3-Color				
1472-3P	3-Color	Perforated			
1472-BP	Blank	Perforated			
1472-P	Red/Yellow	Perforated			

Berkel M/MP/GM Series 65mm

Heartland Product Family: 1481

Recommended for use on these units: Berkel M/MP/GM Series 65mm

Width	Length	Labels / roll	Rolls / case	Core ID	Roll OD	Weight / case	Cases / pallet
58 mm	65 mm	900	12	1.63 in	4.7 in	17 lbs	96

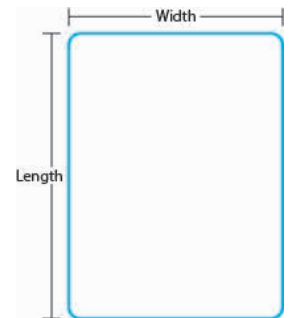

Stock Labels

Item #	Colors	Features	5-24 CS	25-49 CS	50+ CS
1481-B	Blank				

Custom Labels

Item #	Colors	Features	5-24 CS	25-49 CS	50+ CS
1481-1	1-Color				
1481-1P	1-Color	Perforated			
1481-2	2-Color				
1481-2P	2-Color	Perforated			
1481-3	3-Color				
1481-3P	3-Color	Perforated			
1481-BP	Blank	Perforated			

Berkel M/MP/GM Series 100mm

Heartland Product Family: 1482

Recommended for use on these units: Berkel M/MP/GM Series 100mm

Width	Length	Labels / roll	Rolls / case	Core ID	Roll OD	Weight / case	Cases / pallet
58 mm	100 mm	590	12	1.63 in	4.6 in	17 lbs	96

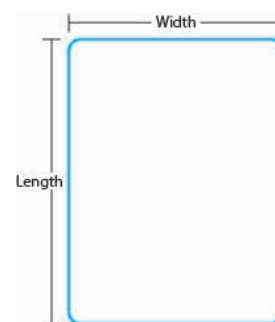

Stock Labels

Item #	Colors	Features	5-24 CS	25-49 CS	50+ CS
1482-B	Blank				

Custom Labels

Item #	Colors	Features	5-24 CS	25-49 CS	50+ CS
1482-1	1-Color				
1482-1P	1-Color	Perforated			
1482-2	2-Color				
1482-2P	2-Color	Perforated			
1482-3	3-Color				
1482-3P	3-Color	Perforated			
1482-BP	Blank	Perforated			

Berkel M/MP/GM Series Edge to Edge Continuous Strip

Heartland Product Family: 1483

Recommended for use on these units: Berkel M/MP/GM Series Edge to Edge Continuous Strip

Width	Length	Labels / roll	Rolls / case	Core ID	Roll OD	Weight / case	Cases / pallet
60 mm	2400 in	2400	12	1.63 in	4.6 in	18 lbs	96

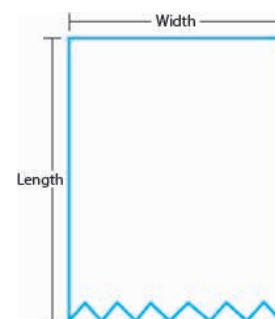

Stock Labels

Item #	Colors	Features	5-24 CS	25-49 CS	50+ CS
1483-B	Blank				

Custom Labels

Item #	Colors	Features	5-24 CS	25-49 CS	50+ CS
1483-1	1-Color				
1483-2	2-Color				
1483-3	3-Color				

Berkel M/MP/GM Series 40mm

Heartland Product Family: 1487

Recommended for use on these units: Berkel M/MP/GM Series 40mm

Width	Length	Labels / roll	Rolls / case	Core ID	Roll OD	Weight / case	Cases / pallet
58 mm	40 mm	1420	12	1.63 in	4.7 in	17 lbs	96

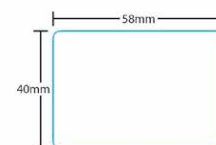

Custom Labels

Item #	Colors	Features	5-24 CS	25-49 CS	50+ CS
1487-1	1-Color				
1487-2	2-Color				
1487-3	3-Color				
1487-B	Blank				

Berkel M/MP/GM Series 75mm

Heartland Product Family: 1488

Recommended for use on these units: Berkel M/MP/GM Series 75mm

Width	Length	Labels / roll	Rolls / case	Core ID	Roll OD	Weight / case	Cases / pallet
58 mm	75 mm	780	12	1.63 in	4.6 in	17 lbs	96

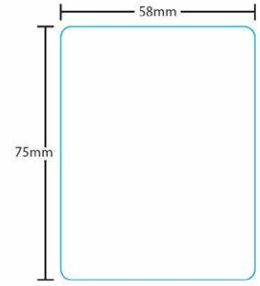

Stock Labels

Item #	Colors	Features	5-24 CS	25-49 CS	50+ CS
1488-B	Blank				

Custom Labels

Item #	Colors	Features	5-24 CS	25-49 CS	50+ CS
1488-1	1-Color				
1488-2	2-Color				
1488-3	3-Color				

Bizerba 58mm x 60mm

Heartland Product Family: 1850

Recommended for use on these units: Bizerba 58mm x 60mm

Width	Length	Labels / roll	Rolls / case	Core ID	Roll OD	Weight / case	Cases / pallet
58 mm	60 mm	725	12	1.63 in	4.1 in	13 lbs	100

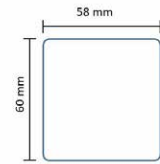

Stock Labels

Item #	Colors	Features	5-24 CS	25-49 CS	50+ CS
1850-B	Blank				

Custom Labels

Item #	Colors	Features	5-24 CS	25-49 CS	50+ CS
1850-1	1-Color				
1850-2	2-Color				
1850-3	3-Color				

Bizerba 58mm x 93mm

Heartland Product Family: 1851

Recommended for use on these units: Bizerba 58mm x 93mm

Width	Length	Labels / roll	Rolls / case	Core ID	Roll OD	Weight / case	Cases / pallet
58 mm	93 mm	480	12	1.63 in	4.1 in	13 lbs	100

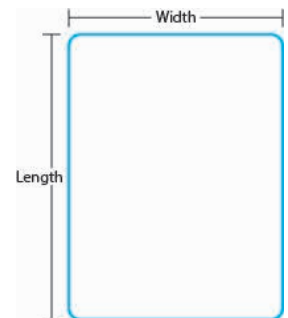

Stock Labels

Item #	Colors	Features	5-24 CS	25-49 CS	50+ CS
1851-B	Blank				

Custom Labels

Item #	Colors	Features	5-24 CS	25-49 CS	50+ CS
1851-1	1-Color				
1851-2	2-Color				
1851-3	3-Color				

Bizerba 58mm x 43mm

Heartland Product Family: 1853

Recommended for use on these units: Bizerba 58mm x 43mm

Width	Length	Labels / roll	Rolls / case	Core ID	Roll OD	Weight / case	Cases / pallet
58 mm	43 mm	1000	12	1.63 in	4.1 in	13 lbs	100

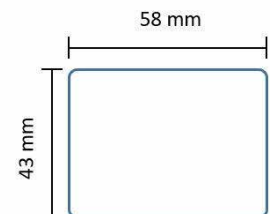

Stock Labels

Item #	Colors	Features	5-24 CS	25-49 CS	50+ CS
1853-B	Blank				

Custom Labels

Item #	Colors	Features	5-24 CS	25-49 CS	50+ CS
1853-1	1-Color				
1853-2	2-Color				
1853-3	3-Color				

Bizerba Edge to Edge Continuous Strip

Heartland Product Family: 1855

Recommended for use on these units: Bizerba Edge to Edge Continuous Strip

Width	Length	Labels / roll	Rolls / case	Core ID	Roll OD	Weight / case	Cases / pallet
60 mm	1704 in	1704	12	1.63 in	4.0 in	13 lbs	100

Custom Labels

Item #	Colors	Features	5-24 CS	25-49 CS	50+ CS
1855-1	1-Color				
1855-2	2-Color				
1855-3	3-Color				
1855-B	Blank				

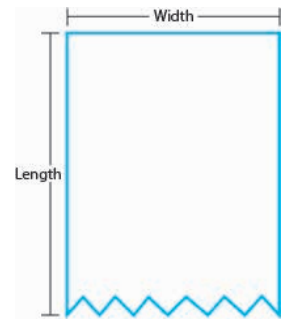

Bizerba Liner Free - Continuous Strip

Heartland Product Family: 5865

Recommended for use on these units: Bizerba Liner Free - Continuous Strip

Width	Length	Labels / roll	Rolls / case	Core ID	Roll OD	Weight / case	Cases / pallet
58 mm	2,559 in	2559	30	1.56 in	4.8 in	33 lbs	48

Custom Labels

Item #	Colors	Features	5-24 CS	25-49 CS	50+ CS
E-L-WS5865	Blank	Linerless			

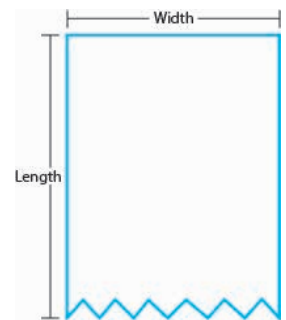

Cas LP-1000 Non-UPC

Heartland Product Family: 1396

Recommended for use on these units: Cas LP-1000 Non-UPC

Width	Length	Labels / roll	Rolls / case	Core ID	Roll OD	Weight / case	Cases / pallet
58 mm	30 mm	1000	12	1.63 in	3.6 in	10 lbs	160

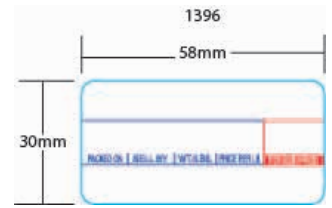

Stock Labels

Item #	Colors	Features	5-24 CS	25-49 CS	50+ CS
1396	Red/Blue				

Custom Labels

Item #	Colors	Features	5-24 CS	25-49 CS	50+ CS
1396-1	1-Color				
1396-2	2-Color				
1396-3	3-Color				

Cas CL-5000

Heartland Product Family: 1398

Recommended for use on these units: Cas CL-5000

Width	Length	Labels / roll	Rolls / case	Core ID	Roll OD	Weight / case	Cases / pallet
60 mm	120 mm	200	12	1.63 in	3.2 in	8 lbs	160

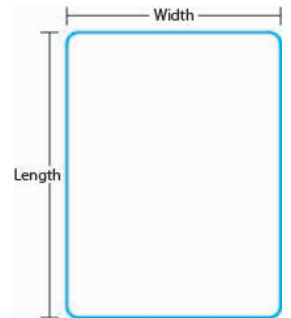

Custom Labels

Item #	Colors	Features	5-24 CS	25-49 CS	50+ CS
1398-1	1-Color				
1398-2	2-Color				
1398-3	3-Color				
1398-B	Blank				

Cas CL5000 100' Continuous Strip

Heartland Product Family: 1399

Recommended for use on these units: Cas CL5000 100' Continuous Strip

Width	Length	Labels / roll	Rolls / case	Core ID	Roll OD	Weight / case	Cases / pallet
60 mm	1200 in	1200	12	1.63 in	3.5 in	9 lbs	160

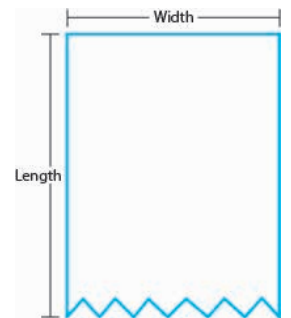

Stock Labels

Item #	Colors	Features	5-24 CS	25-49 CS	50+ CS
1399-B	Blank				

Custom Labels

Item #	Colors	Features	5-24 CS	25-49 CS	50+ CS
1399-1	1-Color				
1399-2	2-Color				
1399-3	3-Color				

Cas LP-1000 UPC Ingredient

Heartland Product Family: 1477

Recommended for use on these units: Cas LP-1000 UPC Ingredient

Width	Length	Labels / roll	Rolls / case	Core ID	Roll OD	Weight / case	Cases / pallet
58 mm	60 mm	500	12	1.63 in	3.5 in	9 lbs	160

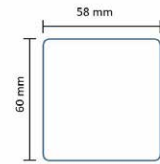

Stock Labels

Item #	Colors	Features	5-24 CS	25-49 CS	50+ CS
1477	Red/Blue				

Custom Labels

Item #	Colors	Features	5-24 CS	25-49 CS	50+ CS
1477-1	1-Color				
1477-2	2-Color				
1477-3	3-Color				
1477-B	Blank				

Cas LP-1000 UPC Safe Handling

Heartland Product Family: 1478

Recommended for use on these units: Cas LP-1000 UPC Safe Handling

Width	Length	Labels / roll	Rolls / case	Core ID	Roll OD	Weight / case	Cases / pallet
58 mm	60 mm	500	12	1.63 in	3.5 in	9 lbs	160

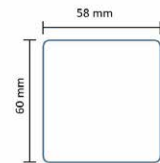

Stock Labels

Item #	Colors	Features	5-24 CS	25-49 CS	50+ CS
1478-S/H	Red/Blue	Safe Handling			

Custom Labels

Item #	Colors	Features	5-24 CS	25-49 CS	50+ CS
1478-1	1-Color				
1478-2	2-Color				
1478-3	3-Color				

Cas LP-1000 Non-UPC Safe Handling

Heartland Product Family: 1479

Recommended for use on these units: Cas LP-1000 Non-UPC Safe Handling

Width	Length	Labels / roll	Rolls / case	Core ID	Roll OD	Weight / case	Cases / pallet
58 mm	50 mm	600	12	1.63 in	3.5 in	10 lbs	160

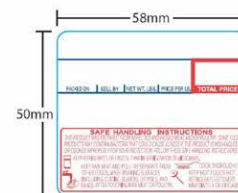

Stock Labels

Item #	Colors	Features	5-24 CS	25-49 CS	50+ CS
1479-S/H	Red/Blue	Safe Handling			

Custom Labels

Item #	Colors	Features	5-24 CS	25-49 CS	50+ CS
1479-1	1-Color				
1479-2	2-Color				
1479-3	3-Color				
1479-B	Blank				

Cas LP-1000 UPC

Heartland Product Family: 1493

Recommended for use on these units: Cas LP-1000 UPC

Width	Length	Labels / roll	Rolls / case	Core ID	Roll OD	Weight / case	Cases / pallet
58 mm	40 mm	700	12	1.63 in	3.5 in	9 lbs	160

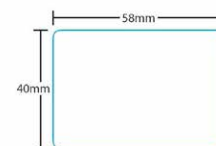

Stock Labels

Item #	Colors	Features	5-24 CS	25-49 CS	50+ CS
1493	Red/Blue				

Custom Labels

Item #	Colors	Features	5-24 CS	25-49 CS	50+ CS
1493-1	1-Color				
1493-2	2-Color				
1493-3	3-Color				
1493-B	Blank				

Digi SM-15 UPC Thank You & w/o Thank You

Heartland Product Family: 1502

Recommended for use on these units: Digi SM-15 UPC Thank You & w/o Thank You

Width	Length	Labels / roll	Rolls / case	Core ID	Roll OD	Weight / case	Cases / pallet
40 mm	62 mm	500	30	1.63 in	3.6 in	16 lbs	160

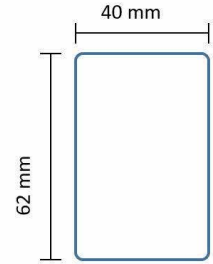

Custom Labels

Item #	Colors	Features	5-24 CS	25-49 CS	50+ CS
1502	Red				

Digi DPS-2600/DPS-6000/DPS-7000 80mm 3" Core

Heartland Product Family: 1504

Recommended for use on these units: Digi DPS-2600/DPS-6000/DPS-7000 80mm 3" Core

Width	Length	Labels / roll	Rolls / case	Core ID	Roll OD	Weight / case	Cases / pallet
60 mm	80 mm	1800	3	3.00 in	7.5 in	11 lbs	150

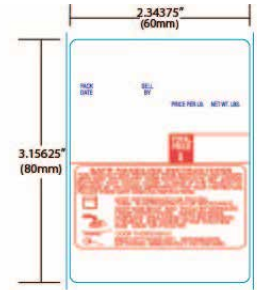

Stock Labels

Item #	Colors	Features	5-24 CS	25-49 CS	50+ CS
1504-S/H	Red/Blue OW	Safe Handling			

Digi DPS-2600/DPS-6000/DPS-7000 95mm 3" Core

Heartland Product Family: 1516

Recommended for use on these units: Digi DPS-2600/DPS-6000/DPS-7000 95mm 3" Core

Width	Length	Labels / roll	Rolls / case	Core ID	Roll OD	Weight / case	Cases / pallet
60 mm	95 mm	1500	3	3.00 in	7.4 in	11 lbs	150



Stock Labels

Item #	Colors	Features	5-24 CS	25-49 CS	50+ CS
1516-BO	Blank Wound Out				

Custom Labels

Item #	Colors	Features	5-24 CS	25-49 CS	50+ CS
1516	Red/Blue				
1516-1	1-Color				
1516-2	2-Color				
1516-3	3-Color				
1516-B	Blank				
1516-S/H	Red/Blue	Safe Handling			

Digi DPS-2600/DPS-6000/DPS-7000 80mm 3" Core

Heartland Product Family: 1518

Recommended for use on these units: Digi DPS-2600/DPS-6000/DPS-7000 80mm 3" Core

Width	Length	Labels / roll	Rolls / case	Core ID	Roll OD	Weight / case	Cases / pallet
60 mm	80 mm	1800	3	3.00 in	7.5 in	11 lbs	150

Stock Labels

Item #	Colors	Features	5-24 CS	25-49 CS	50+ CS
1518-B	Blank				
1518-BO	Blank Wound Out				
1518-S/H	Red/Blue	Safe Handling			

Custom Labels

Item #	Colors	Features	5-24 CS	25-49 CS	50+ CS
1518	Red/Blue				
1518-1	1-Color				
1518-2	2-Color				
1518-3	3-Color				

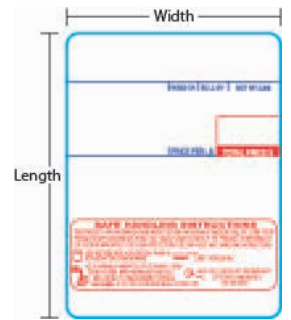

Digi DP-120/121 SM-90/SM-300B 125mm

Heartland Product Family: 1523

Recommended for use on these units: Digi DP-120/121 SM-90/SM-300B 125mm

Width	Length	Labels / roll	Rolls / case	Core ID	Roll OD	Weight / case	Cases / pallet
60 mm	125 mm	375	15	1.63 in	4.2 in	18 lbs	100

Custom Labels

Item #	Colors	Features	5-24 CS	25-49 CS	50+ CS
1523-1	1-Color				
1523-2	2-Color				
1523-3	3-Color				
1523-B	Blank				

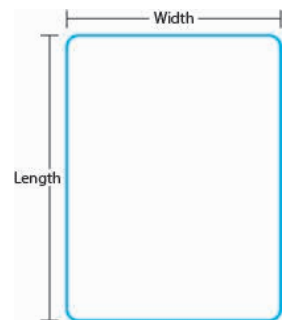

Digi DP-120/121 SM-90/SM-300B 120mm

Heartland Product Family: 1524

Recommended for use on these units: Digi DP-120/121 SM-90/SM-300B 120mm

Width	Length	Labels / roll	Rolls / case	Core ID	Roll OD	Weight / case	Cases / pallet
60 mm	120 mm	400	15	1.63 in	4.2 in	18 lbs	80

Custom Labels

Item #	Colors	Features	5-24 CS	25-49 CS	50+ CS
1524-1	1-Color				
1524-2	2-Color				
1524-3	3-Color				
1524-B	Blank				

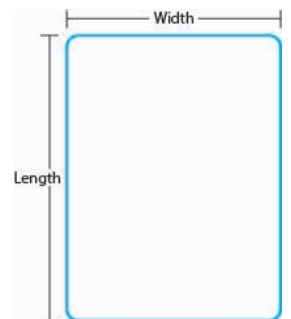

Digi DP-120/121 SM-70/SM-25 95mm 1.5” Core

Heartland Product Family: 1525

Recommended for use on these units: Digi DP-120/121 SM-70/SM-25 95mm 1.5” Core

Width	Length	Labels / roll	Rolls / case	Core ID	Roll OD	Weight / case	Cases / pallet
60 mm	95 mm	665	15	1.63 in	4.8 in	24 lbs	80

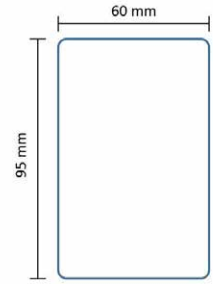

Custom Labels

Item #	Colors	Features	5-24 CS	25-49 CS	50+ CS
1525	Red/Blue				
1525-1	1-Color				
1525-1P	1-Color	Perforated			
1525-1TP	1-Color	Perforated			
1525-2	2-Color				
1525-2P	2-Color	Perforated			
1525-2TP	2-Color	Perforated			
1525-3	3-Color				
1525-3P	3-Color	Perforated			
1525-3TP	3-Color	Perforated			
1525-BI	Blank Wound In				
1525-BO	Blank Wound Out				
1525-BPI	Blank Wound In	Perforated			
1525-BPO	Blank Wound Out	Perforated			
1525-BTP	Blank	Perforated			
1525-S/H	Red/Blue	Safe Handling			

Digi DP-120/121 SM-70/SM-25 133mm

Heartland Product Family: 1526

Recommended for use on these units: Digi DP-120/121 SM-70/SM-25 133mm

Width	Length	Labels / roll	Rolls / case	Core ID	Roll OD	Weight / case	Cases / pallet
60 mm	133 mm	475	15	1.63 in	4.8 in	23 lbs	80

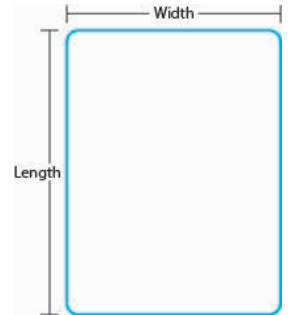

Custom Labels

Item #	Colors	Features	5-24 CS	25-49 CS	50+ CS
1526-1	1-Color				
1526-2	2-Color				
1526-3	3-Color				
1526-B	Blank				

Digi DP-120/121 SM-70/SM-25 110mm

Heartland Product Family: 1531

Recommended for use on these units: Digi DP-120/121 SM-70/SM-25 110mm

Width	Length	Labels / roll	Rolls / case	Core ID	Roll OD	Weight / case	Cases / pallet
60 mm	110 mm	575	15	1.63 in	4.8 in	23 lbs	80

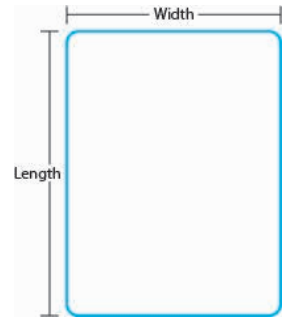

Custom Labels

Item #	Colors	Features	5-24 CS	25-49 CS	50+ CS
1531-1	1-Color				
1531-1P	1-Color	Perforated			
1531-2	2-Color				
1531-2P	2-Color	Perforated			
1531-3	3-Color				
1531-3P	3-Color	Perforated			
1531-B	Blank				
1531-BP	Blank	Perforated			

Digi DP-120/121 SM-90/SM-300B 110mm

Heartland Product Family: 1534

Recommended for use on these units: Digi DP-120/121 SM-90/SM-300B 110mm

Width	Length	Labels / roll	Rolls / case	Core ID	Roll OD	Weight / case	Cases / pallet
60 mm	110 mm	425	15	1.63 in	4.2 in	18 lbs	80

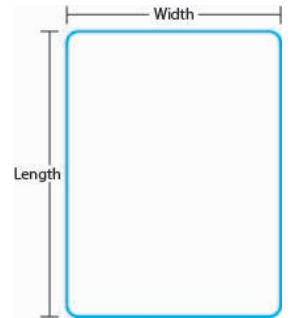

Stock Labels

Item #	Colors	Features	5-24 CS	25-49 CS	50+ CS
1534-B	Blank				

Custom Labels

Item #	Colors	Features	5-24 CS	25-49 CS	50+ CS
1534-1	1-Color				
1534-1TP	1-Color	Perforated			
1534-2	2-Color				
1534-2TP	2-Color	Perforated			
1534-3	3-Color				
1534-3TP	3-Color	Perforated			
1534-BTP	Blank	Perforated			

Digi DP-120/121 SM-90/SM-300B 95mm

Heartland Product Family: 1536

Recommended for use on these units: Digi DP-120/121 SM-90/SM-300B 95mm

Width	Length	Labels / roll	Rolls / case	Core ID	Roll OD	Weight / case	Cases / pallet
60 mm	95 mm	500	15	1.63 in	4.2 in	18 lbs	80

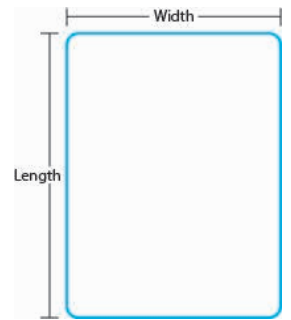

Stock Labels

Item #	Colors	Features	5-24 CS	25-49 CS	50+ CS
1536-B	Blank				
1536-BTP	Blank	Perforated			

Custom Labels

Item #	Colors	Features	5-24 CS	25-49 CS	50+ CS
1536	Red/Blue				
1536-1	1-Color				
1536-1P	1-Color	Perforated			
1536-1TP	1-Color	Perforated			
1536-2	2-Color				
1536-2P	2-Color	Perforated			
1536-2TP	2-Color	Perforated			
1536-3	3-Color				
1536-3P	3-Color	Perforated			
1536-3TP	3-Color	Perforated			
1536-BP	Blank	Perforated			
1536-S/H	Red/Blue	Safe Handling			

Digi DP-120/SM-90/SM-300B 80mm

Heartland Product Family: 1537

Recommended for use on these units: Digi DP-120/SM-90/SM-300B 80mm

Width	Length	Labels / roll	Rolls / case	Core ID	Roll OD	Weight / case	Cases / pallet
60 mm	80 mm	580	15	1.63 in	4.2 in	18 lbs	80

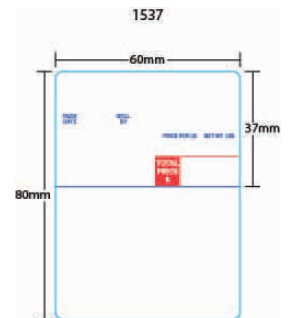

Stock Labels

Item #	Colors	Features	5-24 CS	25-49 CS	50+ CS
1537-B	Blank				
1537-S/H	Red/Blue	Safe Handling			

Custom Labels

Item #	Colors	Features	5-24 CS	25-49 CS	50+ CS
1537	Red/Blue				
1537-1	1-Color				
1537-2	2-Color				
1537-3	3-Color				

Digi DP-120/SM-90/SM-300B 43mm

Heartland Product Family: 1538

Recommended for use on these units: Digi DP-120/SM-90/SM-300B 43mm

Width	Length	Labels / roll	Rolls / case	Core ID	Roll OD	Weight / case	Cases / pallet
60 mm	43 mm	1050	15	1.63 in	4.2 in	18 lbs	80

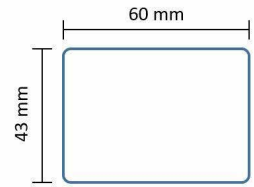

Stock Labels

Item #	Colors	Features	5-24 CS	25-49 CS	50+ CS
1538	Red/Blue				

Custom Labels

Item #	Colors	Features	5-24 CS	25-49 CS	50+ CS
1538-1	1-Color				
1538-2	2-Color				
1538-3	3-Color				
1538-B	Blank				

Digi DP-120/SM-90/SM-300B 55mm

Heartland Product Family: 1539

Recommended for use on these units: Digi DP-120/SM-90/SM-300B 55mm

Width	Length	Labels / roll	Rolls / case	Core ID	Roll OD	Weight / case	Cases / pallet
60 mm	55 mm	830	15	1.63 in	4.2 in	18 lbs	80

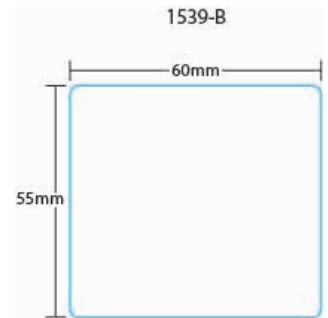

Stock Labels

Item #	Colors	Features	5-24 CS	25-49 CS	50+ CS
1539	Red/Blue				
1539-B	Blank				

Custom Labels

Item #	Colors	Features	5-24 CS	25-49 CS	50+ CS
1539-1	1-Color				
1539-2	2-Color				
1539-3	3-Color				

Digi DPS-6000/DPS-6084/DPS-7000 UPC 43mm 3" Core

Heartland Product Family: 1541

Recommended for use on these units: Digi DPS-6000/DPS-6084/DPS-7000 UPC 43mm 3" Core

Width	Length	Labels / roll	Rolls / case	Core ID	Roll OD	Weight / case	Cases / pallet
60 mm	43 mm	3240	3	3.00 in	7.4 in	11 lbs	150

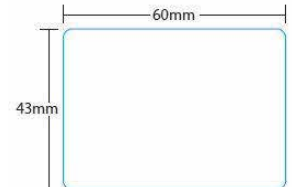

Custom Labels

Item #	Colors	Features	5-24 CS	25-49 CS	50+ CS
1541	Red/Blue				
1541-1	1-Color				
1541-2	2-Color				
1541-3	3-Color				
1541-B	Blank				

Digi BP-82

Heartland Product Family: 1542

Recommended for use on these units: Digi BP-82

Width	Length	Labels / roll	Rolls / case	Core ID	Roll OD	Weight / case	Cases / pallet
40 mm	39 mm	5000	5	3.00 in	8.6 in	18 lbs	48

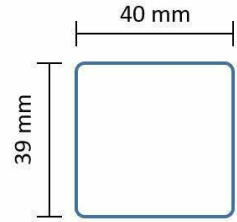

Custom Labels

Item #	Colors	Features	5-24 CS	25-49 CS	50+ CS
1542-B	Blank				

Digi BL-8000 175mm

Heartland Product Family: 1546

Recommended for use on these units: Digi BL-8000 175mm

Width	Length	Labels / roll	Rolls / case	Core ID	Roll OD	Weight / case	Cases / pallet
60 mm	175 mm	757	6	1.63 in	6.7 in	20 lbs	48

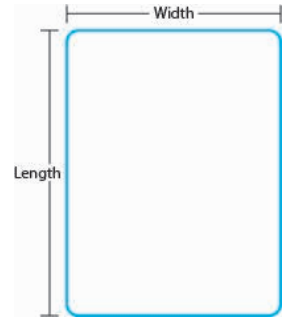

Custom Labels

Item #	Colors	Features	5-24 CS	25-49 CS	50+ CS
1546-B	Blank				

Digi SM-90/SM-300B UPC Thank You & w/o Thank You

Heartland Product Family: 1547

Recommended for use on these units: Digi SM-90/SM-300B UPC Thank You & w/o Thank You

Width	Length	Labels / roll	Rolls / case	Core ID	Roll OD	Weight / case	Cases / pallet
40 mm	62 mm	725	30	1.63 in	4.2 in	23 lbs	75

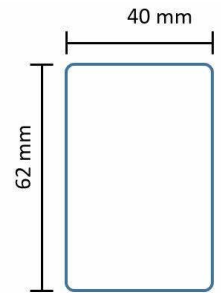

Custom Labels

Item #	Colors	Features	5-24 CS	25-49 CS	50+ CS
1547-1	1-Color				
1547-2	2-Color				
1547-3	3-Color				
1547-B	Blank				
1547-GREEN	Green				
1547-RED	Red				

Digi SM-90/SM-300B UPC Thank You & w/o Thank You

Heartland Product Family: 1548

Recommended for use on these units: Digi SM-90/SM-300B UPC Thank You & w/o Thank You

Width	Length	Labels / roll	Rolls / case	Core ID	Roll OD	Weight / case	Cases / pallet
40 mm	62 mm	725	30	1.63 in	4.2 in	23 lbs	48



Custom Labels

Item #	Colors	Features	5-24 CS	25-49 CS	50+ CS
1548-GREEN	Green				
1548-RED	Red				

Globe GSP30A

Heartland Product Family: 1587

Recommended for use on these units: Globe GSP30A

Width	Length	Labels / roll	Rolls / case	Core ID	Roll OD	Weight / case	Cases / pallet
60 mm	43 mm	835	12	1.63 in	3.8 in	12 lbs	100

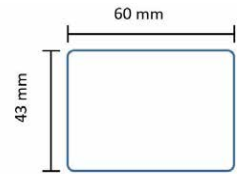

Stock Labels

Item #	Colors	Features	5-24 CS	25-49 CS	50+ CS
1587-B	Blank				

Custom Labels

Item #	Colors	Features	5-24 CS	25-49 CS	50+ CS
1587-1	1-Color				
1587-2	2-Color				
1587-3	3-Color				

Hobart SP-80/SP-1500 Style 1 (Formerly Style J)

Heartland Product Family: 1800

Recommended for use on these units: Hobart SP-80/SP-1500 Style 1 (Formerly Style J)

Width	Length	Labels / roll	Rolls / case	Core ID	Roll OD	Weight / case	Cases / pallet
2.25 in	1.75 in	1275	16	2.00 in	4.8 in	22 lbs	80

Stock Labels

Item #	Colors	Features	5-24 CS	25-49 CS	50+ CS
1800	Red/Blue				

Custom Labels

Item #	Colors	Features	5-24 CS	25-49 CS	50+ CS
1800-1	1-Color				
1800-2	2-Color				
1800-3	3-Color				
1800-B	Blank				

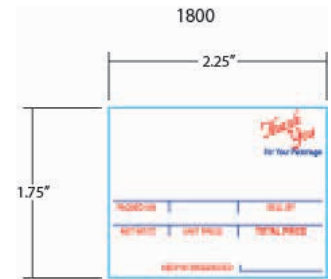

Hobart SP-80/SP-1500 Style 1 (Formerly Style K)

Heartland Product Family: 1801

Recommended for use on these units: Hobart SP-80/SP-1500 Style 1 (Formerly Style K)

Width	Length	Labels / roll	Rolls / case	Core ID	Roll OD	Weight / case	Cases / pallet
2.25 in	3 in	750	16	2.00 in	4.7 in	22 lbs	80

Stock Labels

Item #	Colors	Features	5-24 CS	25-49 CS	50+ CS
1801	Red/Blue				
1801-S/H	Red/Blue	Safe Handling			

Custom Labels

Item #	Colors	Features	5-24 CS	25-49 CS	50+ CS
1801-1	1-Color				
1801-1P	1-Color	Perforated			
1801-2	2-Color				
1801-2P	2-Color	Perforated			
1801-3	3-Color				
1801-3P	3-Color	Perforated			
1801-B	Blank				
1801-BP	Blank	Perforated			
1801-P	Red/Blue	Perforated			
1801-S/HP	Red/Blue	Safe Handling			

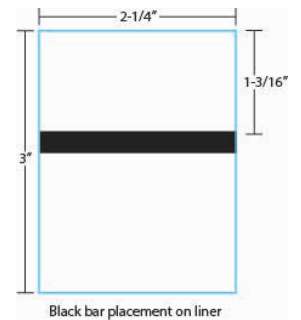

Hobart

Hobart SP-80/SP-1500 Style 1 (Formerly Style L)

Heartland Product Family: 1802

Recommended for use on these units: Hobart SP-80/SP-1500 Style 1 (Formerly Style L)

Width	Length	Labels / roll	Rolls / case	Core ID	Roll OD	Weight / case	Cases / pallet
2.25 in	4.5 in	500	16	2.00 in	4.7 in	22 lbs	80

Custom Labels

Item #	Colors	Features	5-24 CS	25-49 CS	50+ CS
1802	Red/Blue				
1802-1	1-Color				
1802-1P	1-Color	Perforated			
1802-2	2-Color				
1802-2P	2-Color	Perforated			
1802-3	3-Color				
1802-3P	3-Color	Perforated			
1802-B	Blank				
1802-BP	Blank	Perforated			
1802-P	Red/Blue	Perforated			

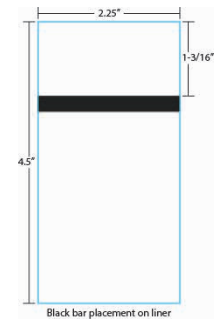

Hobart Ultima 2000 3.0''

Heartland Product Family: 1827

Recommended for use on these units: Hobart Ultima 2000 3.0''

Width	Length	Labels / roll	Rolls / case	Core ID	Roll OD	Weight / case	Cases / pallet
2.25 in	3 in	2800	5	2.75 in	8.8 in	25 lbs	60

Stock Labels

Item #	Colors	Features	5-24 CS	25-49 CS	50+ CS
1827-B	Blank				

Custom Labels

Item #	Colors	Features	5-24 CS	25-49 CS	50+ CS
1827	Red/Blue				
1827-1	1-Color				
1827-2	2-Color				
1827-3	3-Color				
1827-BTP	Blank	Perforated			
1827-S/H	Red/Blue	Safe Handling			

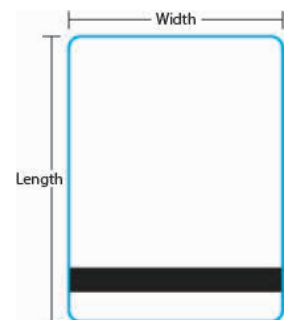

Hobart Ultima 2000 3.5”

Heartland Product Family: 1845

Recommended for use on these units: Hobart Ultima 2000 3.5”

Width	Length	Labels / roll	Rolls / case	Core ID	Roll OD	Weight / case	Cases / pallet
2.25 in	3.5 in	2400	5	2.75 in	8.7 in	25 lbs	60

Stock Labels

Item #	Colors	Features	5-24 CS	25-49 CS	50+ CS
1845-B	Blank				

Custom Labels

Item #	Colors	Features	5-24 CS	25-49 CS	50+ CS
1845-1	1-Color				
1845-2	2-Color				
1845-3	3-Color				

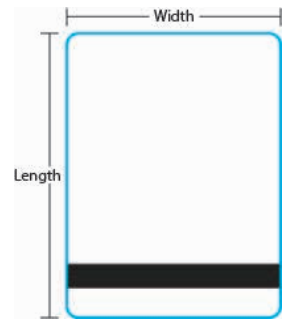

Hobart Ultima 2000 4.0”

Heartland Product Family: 1881

Recommended for use on these units: Hobart Ultima 2000 4.0”

Width	Length	Labels / roll	Rolls / case	Core ID	Roll OD	Weight / case	Cases / pallet
2.25 in	4 in	2100	5	2.75 in	8.7 in	25 lbs	60

Stock Labels

Item #	Colors	Features	5-24 CS	25-49 CS	50+ CS
1881-B	Blank				

Custom Labels

Item #	Colors	Features	5-24 CS	25-49 CS	50+ CS
1881-1	1-Color				
1881-2	2-Color				
1881-3	3-Color				

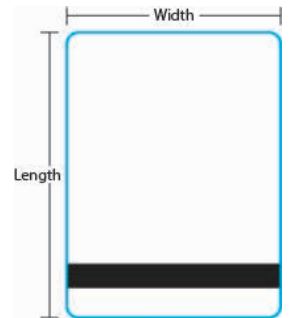

Hobart Quantum/HLX/HTi 4.0”

Heartland Product Family: 1907

Recommended for use on these units: Hobart Quantum/HLX/HTi 4.0”

Width	Length	Labels / roll	Rolls / case	Core ID	Roll OD	Weight / case	Cases / pallet
2.25 in	4 in	750	16	2.75 in	5.7 in	29 lbs	48

Stock Labels

Item #	Colors	Features	5-24 CS	25-49 CS	50+ CS
1907-B	Blank				

Custom Labels

Item #	Colors	Features	5-24 CS	25-49 CS	50+ CS
1907-1	1-Color				
1907-2	2-Color				
1907-3	3-Color				

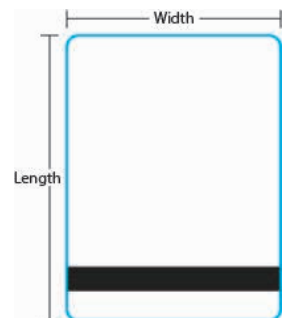

Hobart Quantum/HLX/HTi 1.75”

Heartland Product Family: 1909

Recommended for use on these units: Hobart Quantum/HLX/HTi 1.75”

Width	Length	Labels / roll	Rolls / case	Core ID	Roll OD	Weight / case	Cases / pallet
2.25 in	1.75 in	1600	16	2.75 in	5.6 in	28 lbs	48

Stock Labels

Item #	Colors	Features	5-24 CS	25-49 CS	50+ CS
1909-B	Blank				

Custom Labels

Item #	Colors	Features	5-24 CS	25-49 CS	50+ CS
1909-1	1-Color				
1909-2	2-Color				
1909-3	3-Color				

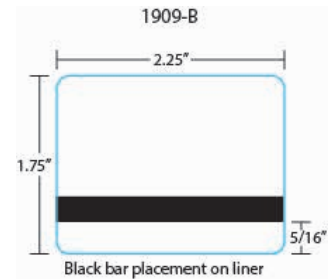

Hobart Quantum/HLX/HTi 2.375”

Heartland Product Family: 1910

Recommended for use on these units: Hobart Quantum/HLX/HTi 2.375”

Width	Length	Labels / roll	Rolls / case	Core ID	Roll OD	Weight / case	Cases / pallet
2.25 in	2.375 in	1200	16	2.75 in	5.6 in	28 lbs	48

Stock Labels

Item #	Colors	Features	5-24 CS	25-49 CS	50+ CS
1910-B	Blank				

Custom Labels

Item #	Colors	Features	5-24 CS	25-49 CS	50+ CS
1910-1	1-Color				
1910-2	2-Color				
1910-3	3-Color				

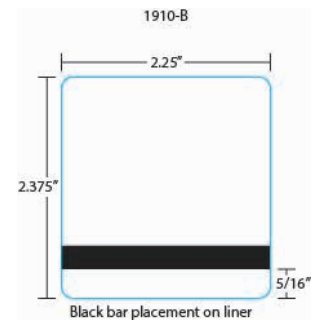

Hobart Quantum/HLX/HTi 3.0”

Heartland Product Family: 1911

Recommended for use on these units: Hobart Quantum/HLX/HTi 3.0”

Width	Length	Labels / roll	Rolls / case	Core ID	Roll OD	Weight / case	Cases / pallet
2.25 in	3 in	1000	16	2.75 in	5.7 in	29 lbs	48

Stock Labels

Item #	Colors	Features	5-24 CS	25-49 CS	50+ CS
1911-B	Blank				
1911-BTP	Blank	Perforated			

Custom Labels

Item #	Colors	Features	5-24 CS	25-49 CS	50+ CS
1911	Red/Blue				
1911-1	1-Color				
1911-1TP	1-Color	Perforated			
1911-2	2-Color				
1911-2TP	2-Color	Perforated			
1911-3	3-Color				
1911-3TP	3-Color	Perforated			

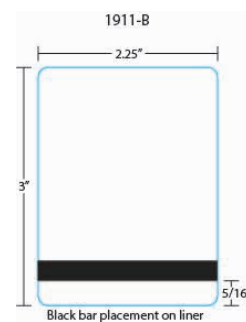

Hobart Quantum/HLX/HTi 3.5”

Heartland Product Family: 1912

Recommended for use on these units: Hobart Quantum/HLX/HTi 3.5”

Width	Length	Labels / roll	Rolls / case	Core ID	Roll OD	Weight / case	Cases / pallet
2.25 in	3.5 in	850	16	2.75 in	5.6 in	29 lbs	48

Stock Labels

Item #	Colors	Features	5-24 CS	25-49 CS	50+ CS
1912-B	Blank				

Custom Labels

Item #	Colors	Features	5-24 CS	25-49 CS	50+ CS
1912-1	1-Color				
1912-2	2-Color				
1912-3	3-Color				
1912-BP	Blank	Perforated			
1912-BTP	Blank	Perforated			

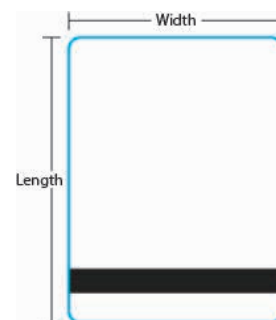

Hobart Quantum/HLX/HTi 4.5”

Heartland Product Family: 1913

Recommended for use on these units: Hobart Quantum/HLX/HTi 4.5”

Width	Length	Labels / roll	Rolls / case	Core ID	Roll OD	Weight / case	Cases / pallet
2.25 in	4.5 in	700	16	2.75 in	5.8 in	30 lbs	48

Stock Labels

Item #	Colors	Features	5-24 CS	25-49 CS	50+ CS
1913-B	Blank				
1913-BTP	Blank	Perforated			

Custom Labels

Item #	Colors	Features	5-24 CS	25-49 CS	50+ CS
1913-1	1-Color				
1913-1TP	1-Color	Perforated			
1913-2	2-Color				
1913-2TP	2-Color	Perforated			
1913-3	3-Color				
1913-3TP	3-Color	Perforated			

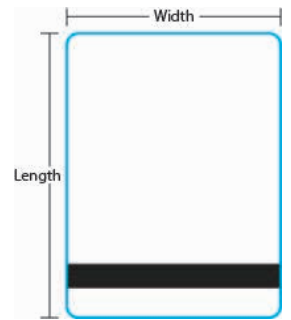

Hobart Quantum HTi Edge to Edge Continuous Strip

Heartland Product Family: 1914

Recommended for use on these units: Hobart Quantum HTi Edge to Edge Continuous Strip

Width	Length	Labels / roll	Rolls / case	Core ID	Roll OD	Weight / case	Cases / pallet
2.5 in	3240 in	3240	16	2.75 in	5.8 in	33 lbs	48

Stock Labels

Item #	Colors	Features	5-24 CS	25-49 CS	50+ CS
1914-B	Blank				

Custom Labels

Item #	Colors	Features	5-24 CS	25-49 CS	50+ CS
1914-1	1-Color				
1914-2	2-Color				
1914-3	3-Color				

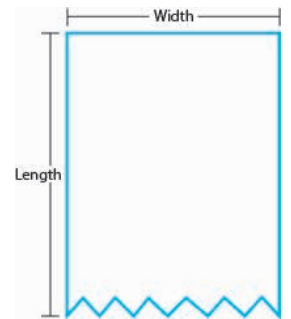

Hobart Quantum/HLX/HTi 6.0”

Heartland Product Family: 1916

Recommended for use on these units: Hobart Quantum/HLX/HTi 6.0”

Width	Length	Labels / roll	Rolls / case	Core ID	Roll OD	Weight / case	Cases / pallet
2.25 in	6 in	525	16	2.75 in	5.7 in	30 lbs	48

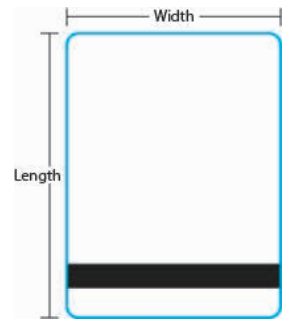

Stock Labels

Item #	Colors	Features	5-24 CS	25-49 CS	50+ CS
1916-B	Blank				

Custom Labels

Item #	Colors	Features	5-24 CS	25-49 CS	50+ CS
1916-1	1-Color				
1916-2	2-Color				
1916-3	3-Color				

Hobart Quantum HTi 4.5” Dome

Heartland Product Family: 1918

Recommended for use on these units: Hobart Quantum HTi 4.5” Dome

Width	Length	Labels / roll	Rolls / case	Core ID	Roll OD	Weight / case	Cases / pallet
2.25 in	4.5 in	700	16	2.75 in	5.8 in	30 lbs	48

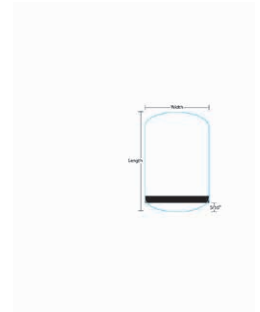

Custom Labels

Item #	Colors	Features	5-24 CS	25-49 CS	50+ CS
1918-1	1-Color				
1918-2	2-Color				
1918-3	3-Color				
1918-B	Blank				

Hobart Quantum HTi 3.5” Dome

Heartland Product Family: 1919

Recommended for use on these units: Hobart Quantum HTi 3.5” Dome

Width	Length	Labels / roll	Rolls / case	Core ID	Roll OD	Weight / case	Cases / pallet
2.25 in	3.5 in	850	16	2.75 in	5.6 in	29 lbs	48



Custom Labels

Item #	Colors	Features	5-24 CS	25-49 CS	50+ CS
1919-1	1-Color				
1919-2	2-Color				
1919-3	3-Color				
1919-B	Blank				

Hobart SD100/SL100 Continuous Strip

Heartland Product Family: 1946

Recommended for use on these units: Hobart SD100/SL100 Continuous Strip

Width	Length	Labels / roll	Rolls / case	Core ID	Roll OD	Weight / case	Cases / pallet
2.28125 in	1536 in	1536	15	1.63 in	3.8 in	14 lbs	48

Custom Labels

Item #	Colors	Features	5-24 CS	25-49 CS	50+ CS
1946-1	1-Color				
1946-2	2-Color				
1946-3	3-Color				
1946-B	Blank				

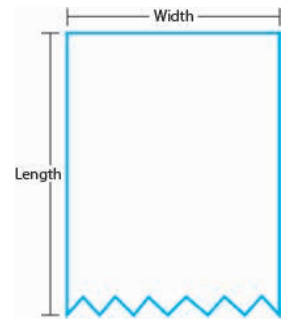

Ishida AC-Series UPC 44mm Narrow

Heartland Product Family: 1813

Recommended for use on these units: Ishida AC-Series UPC 44mm Narrow

Width	Length	Labels / roll	Rolls / case	Core ID	Roll OD	Weight / case	Cases / pallet
60 mm	44 mm	800	12	1.63 in	3.8 in	11 lbs	100

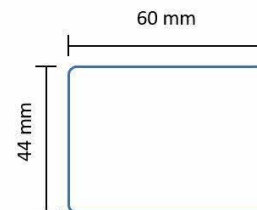

Stock Labels

Item #	Colors	Features	5-24 CS	25-49 CS	50+ CS
1813	Red/Blue				

Custom Labels

Item #	Colors	Features	5-24 CS	25-49 CS	50+ CS
1813-1	1-Color				
1813-2	2-Color				
1813-3	3-Color				
1813-B	Blank				

Ishida Alpha Cosmic UPC 47mm

Heartland Product Family: 1814

Recommended for use on these units: Ishida Alpha Cosmic UPC 47mm

Width	Length	Labels / roll	Rolls / case	Core ID	Roll OD	Weight / case	Cases / pallet
64 mm	47 mm	800	12	1.63 in	3.9 in	13 lbs	100

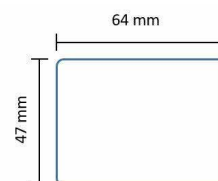

Stock Labels

Item #	Colors	Features	5-24 CS	25-49 CS	50+ CS
1814	Red				

Ishida Alpha Cosmic Non-UPC 37mm

Heartland Product Family: 1815

Recommended for use on these units: Ishida Alpha Cosmic Non-UPC 37mm

Width	Length	Labels / roll	Rolls / case	Core ID	Roll OD	Weight / case	Cases / pallet
64 mm	37 mm	1000	12	1.63 in	3.9 in	13 lbs	100

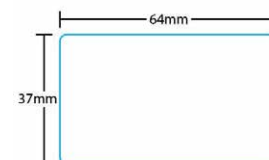

Custom Labels

Item #	Colors	Features	5-24 CS	25-49 CS	50+ CS
1815	Red/Yellow				
1815-1	1-Color				
1815-2	2-Color				
1815-3	3-Color				
1815-B	Blank				

Ishida Alpha Cosmic UPC 47mm

Heartland Product Family: 1819

Recommended for use on these units: Ishida Alpha Cosmic UPC 47mm

Width	Length	Labels / roll	Rolls / case	Core ID	Roll OD	Weight / case	Cases / pallet
64 mm	47 mm	800	12	1.63 in	3.9 in	13 lbs	100

Stock Labels

Item #	Colors	Features	5-24 CS	25-49 CS	50+ CS
1819	Red/Yellow				
1819-B	Blank				

Custom Labels

Item #	Colors	Features	5-24 CS	25-49 CS	50+ CS
1819-1	1-Color				
1819-2	2-Color				
1819-3	3-Color				
1819-GREEN	Green/Yellow				

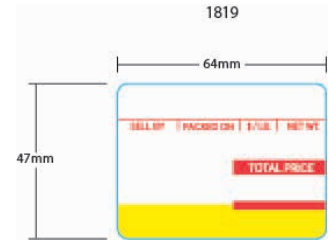

Ishida AC-Series, BC-3000, Astra UPC 85mm

Heartland Product Family: 1820

Recommended for use on these units: Ishida AC-Series, BC-3000, Astra UPC 85mm

Width	Length	Labels / roll	Rolls / case	Core ID	Roll OD	Weight / case	Cases / pallet
64 mm	85 mm	450	12	1.63 in	3.9 in	13 lbs	100

Stock Labels

Item #	Colors	Features	5-24 CS	25-49 CS	50+ CS
1820	Red/Yellow				
1820-B	Blank	Replaced 1839-B			
1820-S/H	Red/Yellow	Safe Handling			

Custom Labels

Item #	Colors	Features	5-24 CS	25-49 CS	50+ CS
1820-1	1-Color				
1820-2	2-Color				
1820-3	3-Color				

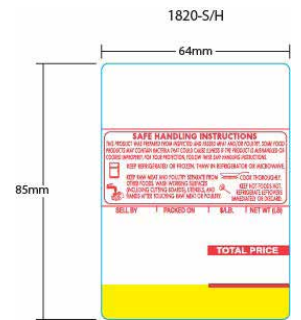

Ishida AC-Series, BC-3000, Astra Continuous Strip 64mm

Heartland Product Family: 1821

Recommended for use on these units: Ishida AC-Series, BC-3000, Astra Continuous Strip 64mm

Width	Length	Labels / roll	Rolls / case	Core ID	Roll OD	Weight / case	Cases / pallet
64 mm	1560 in	1560	12	1.63 in	3.9 in	13 lbs	54

Stock Labels

Item #	Colors	Features	5-24 CS	25-49 CS	50+ CS
1821-B	Blank				

Custom Labels

Item #	Colors	Features	5-24 CS	25-49 CS	50+ CS
1821-1	1-Color				
1821-2	2-Color				
1821-3	3-Color				

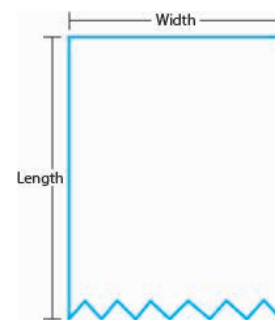

Ishida AC-Series, BC-3000, Astra Continuous Strip 60mm

Heartland Product Family: 1822

Recommended for use on these units: Ishida AC-Series, BC-3000, Astra Continuous Strip 60mm

Width	Length	Labels / roll	Rolls / case	Core ID	Roll OD	Weight / case	Cases / pallet
60 mm	1560 in	1560	12	1.63 in	3.9 in	12 lbs	100

Stock Labels

Item #	Colors	Features	5-24 CS	25-49 CS	50+ CS
1822-B	Blank				

Custom Labels

Item #	Colors	Features	5-24 CS	25-49 CS	50+ CS
1822-1	1-Color				
1822-2	2-Color				
1822-3	3-Color				

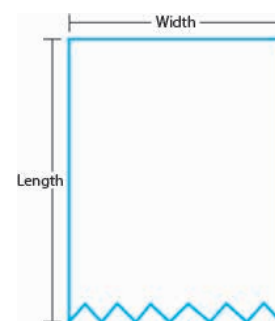

Ishida Omni-3000, Mark II, DP-3000/4000, WPL-3000/4000

Heartland Product Family: 1824

Recommended for use on these units: Ishida Omni-3000, Mark II, DP-3000/4000, WPL-3000/4000

Width	Length	Labels / roll	Rolls / case	Core ID	Roll OD	Weight / case	Cases / pallet
64 mm	85 mm	2500	5	3.00 in	8.8 in	28 lbs	60

Stock Labels

Item #	Colors	Features	5-24 CS	25-49 CS	50+ CS
1824-B	Blank				

Custom Labels

Item #	Colors	Features	5-24 CS	25-49 CS	50+ CS
1824	Red/Yellow				
1824-1	1-Color				
1824-2	2-Color				
1824-3	3-Color				
1824-S/H	Red/Yellow	Safe Handling			

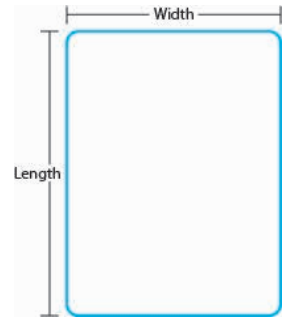

Ishida AC-Series, BC-3000, Astra UPC 59mm

Heartland Product Family: 1828

Recommended for use on these units: Ishida AC-Series, BC-3000, Astra UPC 59mm

Width	Length	Labels / roll	Rolls / case	Core ID	Roll OD	Weight / case	Cases / pallet
64 mm	59 mm	625	12	1.63 in	3.8 in	12 lbs	100

Stock Labels

Item #	Colors	Features	5-24 CS	25-49 CS	50+ CS
1828	Red/Yellow				
1828-B	Blank				

Custom Labels

Item #	Colors	Features	5-24 CS	25-49 CS	50+ CS
1828-1	1-Color				
1828-2	2-Color				
1828-3	3-Color				

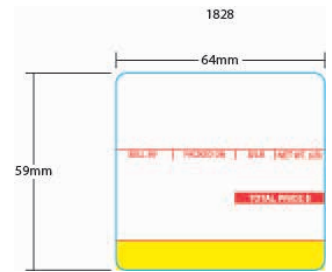

Ishida AC-Series, BC-3000, Astra UPC 73mm

Heartland Product Family: 1831

Recommended for use on these units: Ishida AC-Series, BC-3000, Astra UPC 73mm

Width	Length	Labels / roll	Rolls / case	Core ID	Roll OD	Weight / case	Cases / pallet
64 mm	73 mm	500	12	1.63 in	3.8 in	12 lbs	100

Stock Labels

Item #	Colors	Features	5-24 CS	25-49 CS	50+ CS
1831-S/H	Red/Blue	Safe Handling			

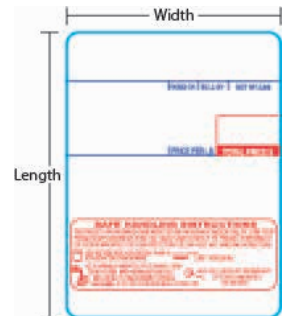

Ishida AC-300 60mm x 85mm

Heartland Product Family: 1834

Recommended for use on these units: Ishida AC-300 60mm x 85mm

Width	Length	Labels / roll	Rolls / case	Core ID	Roll OD	Weight / case	Cases / pallet
60 mm	85 mm	450	12	1.63 in	3.9 in	12 lbs	100

Stock Labels

Item #	Colors	Features	5-24 CS	25-49 CS	50+ CS
1834-B	Blank				

Custom Labels

Item #	Colors	Features	5-24 CS	25-49 CS	50+ CS
1834-1	1-Color				
1834-2	2-Color				
1834-3	3-Color				

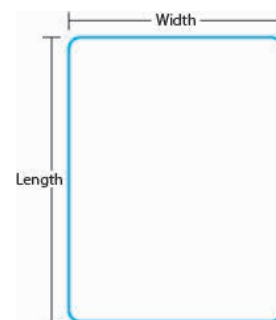

Ishida AC-Series, BC-3000, Astra UPC 73mm

Heartland Product Family: 1837

Recommended for use on these units: Ishida AC-Series, BC-3000, Astra UPC 73mm

Width	Length	Labels / roll	Rolls / case	Core ID	Roll OD	Weight / case	Cases / pallet
64 mm	73 mm	500	12	1.63 in	3.8 in	12 lbs	100

Stock Labels

Item #	Colors	Features	5-24 CS	25-49 CS	50+ CS
1837-B	Blank				
1837-S/H	Red/Yellow	Safe Handling			

Custom Labels

Item #	Colors	Features	5-24 CS	25-49 CS	50+ CS
1837	Red/Yellow				
1837-1	1-Color				
1837-2	2-Color				
1837-3	3-Color				

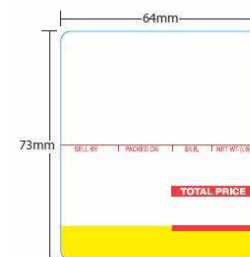

Ishida DP-4000 73mm

Heartland Product Family: 1838

Recommended for use on these units: Ishida DP-4000 73mm

Width	Length	Labels / roll	Rolls / case	Core ID	Roll OD	Weight / case	Cases / pallet
64 mm	73 mm	2900	5	3.00 in	8.8 in	28 lbs	60

Custom Labels

Item #	Colors	Features	5-24 CS	25-49 CS	50+ CS
1838	Red/Yellow				
1838-1	1-Color				
1838-2	2-Color				
1838-3	3-Color				
1838-B	Blank				
1838-S/H	Red/Yellow	Safe Handling			

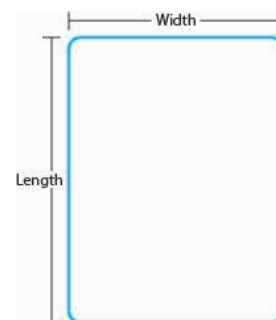

Ishida AC-Series, Astra, BC-3000, UPC 85mm

Heartland Product Family: 1839

Recommended for use on these units: Ishida AC-Series, Astra, BC-3000, UPC 85mm

Width	Length	Labels / roll	Rolls / case	Core ID	Roll OD	Weight / case	Cases / pallet
64 mm	85 mm	450	12	1.63 in	3.9 in	13 lbs	100

Custom Labels

Item #	Colors	Features	5-24 CS	25-49 CS	50+ CS
1839-1	1-Color				
1839-2	2-Color				
1839-3	3-Color				
1839-S/H	Red/Blue	Safe Handling			

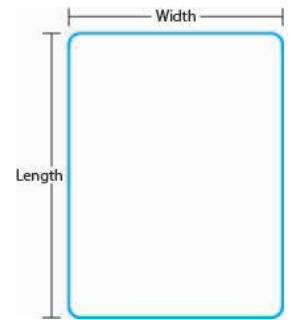

Ishida AC-Series, BC-3000, Astra 85mm Narrow

Heartland Product Family: 1842

Recommended for use on these units: Ishida AC-Series, BC-3000, Astra 85mm Narrow

Width	Length	Labels / roll	Rolls / case	Core ID	Roll OD	Weight / case	Cases / pallet
60 mm	85 mm	425	12	1.63 in	3.8 in	11 lbs	100

Stock Labels

Item #	Colors	Features	5-24 CS	25-49 CS	50+ CS
1842-B	Blank				

Custom Labels

Item #	Colors	Features	5-24 CS	25-49 CS	50+ CS
1842-1	1-Color				
1842-2	2-Color				
1842-3	3-Color				

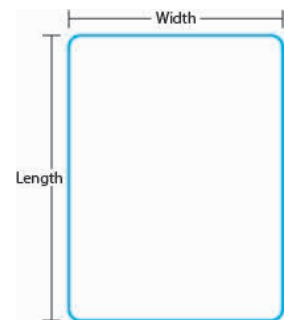

Ishida AC-Series, BC-3000, Astra 110mm Narrow

Heartland Product Family: 1843

Recommended for use on these units: Ishida AC-Series, BC-3000, Astra 110mm Narrow

Width	Length	Labels / roll	Rolls / case	Core ID	Roll OD	Weight / case	Cases / pallet
60 mm	110 mm	330	12	1.63 in	3.8 in	11 lbs	100

Stock Labels

Item #	Colors	Features	5-24 CS	25-49 CS	50+ CS
1843-BP	Blank	Perforated			

Custom Labels

Item #	Colors	Features	5-24 CS	25-49 CS	50+ CS
1843-1	1-Color				
1843-1P	1-Color	Perforated			
1843-2	2-Color				
1843-2P	2-Color	Perforated			
1843-3	3-Color				
1843-3P	3-Color	Perforated			
1843-B	Blank				

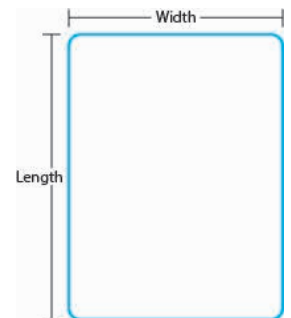

Ishida AC-Series, BC-3000, Astra 110mm

Heartland Product Family: 1844

Recommended for use on these units: Ishida AC-Series, BC-3000, Astra 110mm

Width	Length	Labels / roll	Rolls / case	Core ID	Roll OD	Weight / case	Cases / pallet
64 mm	110 mm	330	12	1.63 in	3.8 in	12 lbs	100

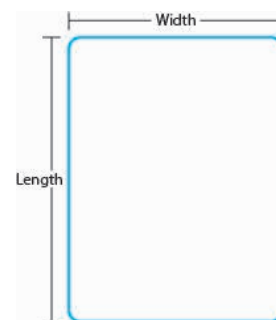

Custom Labels

Item #	Colors	Features	5-24 CS	25-49 CS	50+ CS
1844-1	1-Color				
1844-1P	1-Color	Perforated			
1844-2	2-Color				
1844-2P	2-Color	Perforated			
1844-3	3-Color				
1844-3P	3-Color	Perforated			
1844-B	Blank				
1844-BP	Blank	Perforated			

Ishida AC-Series, BC-3000 Astra UPC 59mm

Heartland Product Family: 1848

Recommended for use on these units: Ishida AC-Series, BC-3000 Astra UPC 59mm

Width	Length	Labels / roll	Rolls / case	Core ID	Roll OD	Weight / case	Cases / pallet
64 mm	59 mm	625	12	1.63 in	3.8 in	12 lbs	100

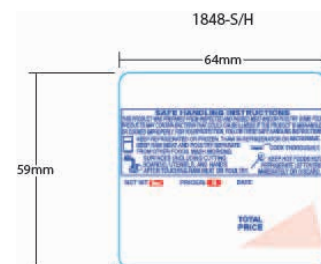

Stock Labels

Item #	Colors	Features	5-24 CS	25-49 CS	50+ CS
1848-S/H	Red/Blue	Safe Handling			

Custom Labels

Item #	Colors	Features	5-24 CS	25-49 CS	50+ CS
1848-1	1-Color				
1848-2	2-Color				
1848-3	3-Color				
1848-B	Blank				

Ishida AC-Series 130mm

Heartland Product Family: 1856

Recommended for use on these units: Ishida AC-Series 130mm

Width	Length	Labels / roll	Rolls / case	Core ID	Roll OD	Weight / case	Cases / pallet
64 mm	130 mm	280	12	1.63 in	3.8 in	12 lbs	100

Custom Labels

Item #	Colors	Features	5-24 CS	25-49 CS	50+ CS
1856-1	1-Color				
1856-1P	1-Color	Perforated			
1856-2	2-Color				
1856-2P	2-Color	Perforated			
1856-3	3-Color				
1856-3P	3-Color	Perforated			
1856-B	Blank				
1856-BP	Blank	Perforated			

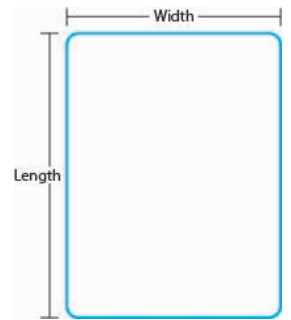

Safe Handling 2.25" x 1.25" Hand Applied

Heartland Product Family: 1000

Recommended for use on these units: Safe Handling 2.25" x 1.25" Hand Applied

Width	Length	Labels / roll	Rolls / case	Core ID	Roll OD	Weight / case	Cases / pallet
2.25 in	1.25 in	1000	20	1.63 in	3.7 in	16 lbs	90

Stock Labels

Item #	Colors	Features	5-24 CS	25-49 CS	50+ CS
1000-BLACK-S/H	Black	Safe Handling			
1000-RED-S/H	Red	Safe Handling			

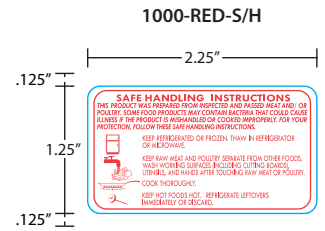

Tec SL-66-30/SL-6600 22 Line Center Code No Net Wt.

Heartland Product Family: 1600

Recommended for use on these units: Tec SL-66-30/SL-6600 22 Line Center Code No Net Wt.

Width	Length	Labels / roll	Rolls / case	Core ID	Roll OD	Weight / case	Cases / pallet
48 mm	92 mm	300	16	1.63 in	3.4 in	10 lbs	135

Stock Labels

Item #	Colors	Features	5-24 CS	25-49 CS	50+ CS
1600-S/H	Blue/Yellow	Safe Handling			

Custom Labels

Item #	Colors	Features	5-24 CS	25-49 CS	50+ CS
1600	Blue/Yellow				
1600-1	1-Color				
1600-2	2-Color				
1600-3	3-Color				
1600-B	Blank				

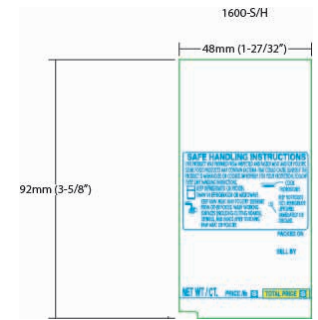

Tec SL-9000 Edge to Edge Continuous Strip 60mm

Heartland Product Family: 1612

Recommended for use on these units: Tec SL-9000 Edge to Edge Continuous Strip 60mm

Width	Length	Labels / roll	Rolls / case	Core ID	Roll OD	Weight / case	Cases / pallet
60 mm	1296 in	1296	16	1.63 in	3.6 in	13 lbs	120

Stock Labels

Item #	Colors	Features	5-24 CS	25-49 CS	50+ CS
1612-B	Blank				

Custom Labels

Item #	Colors	Features	5-24 CS	25-49 CS	50+ CS
1612-1	1-Color				
1612-2	2-Color				
1612-3	3-Color				

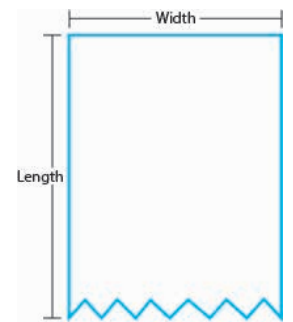

Tec SL-66-30/SL-6600 Non-UPC 30mm

Heartland Product Family: 1640

Recommended for use on these units: Tec SL-66-30/SL-6600 Non-UPC 30mm

Width	Length	Labels / roll	Rolls / case	Core ID	Roll OD	Weight / case	Cases / pallet
48 mm	30 mm	900	16	1.63 in	3.5 in	10 lbs	135



Stock Labels

Item #	Colors	Features	5-24 CS	25-49 CS	50+ CS
1640	Blue/Yellow				

Custom Labels

Item #	Colors	Features	5-24 CS	25-49 CS	50+ CS
1640-1	1-Color				
1640-2	2-Color				
1640-3	3-Color				
1640-B	Blank				

Tec SL-66-30/SL-6600 6 Line Center Code No Net Wt.

Heartland Product Family: 1663

Recommended for use on these units: Tec SL-66-30/SL-6600 6 Line Center Code No Net Wt.

Width	Length	Labels / roll	Rolls / case	Core ID	Roll OD	Weight / case	Cases / pallet
48 mm	54.8 mm	500	16	1.63 in	3.4 in	10 lbs	135



Stock Labels

Item #	Colors	Features	5-24 CS	25-49 CS	50+ CS
1663-BLUE	Blue/Yellow				

Custom Labels

Item #	Colors	Features	5-24 CS	25-49 CS	50+ CS
1663-1	1-Color				
1663-2	2-Color				
1663-3	3-Color				
1663-B	Blank				
1663-RED	Red/Yellow				

Tec SL-66-30/SL-6600 12 Line Center Code No Net Wt.

Heartland Product Family: 1673

Recommended for use on these units: Tec SL-66-30/SL-6600 12 Line Center Code No Net Wt.

Width	Length	Labels / roll	Rolls / case	Core ID	Roll OD	Weight / case	Cases / pallet
48 mm	68.8 mm	400	16	1.63 in	3.4 in	10 lbs	135

Stock Labels

Item #	Colors	Features	5-24 CS	25-49 CS	50+ CS
1673-BLACK-S/H	Black/Blue/ Yellow	Safe Handling			
1673-S/H-BLUE	Blue/Yellow	Safe Handling			
1673-S/H-RED	Red/Yellow	Safe Handling			

Custom Labels

Item #	Colors	Features	5-24 CS	25-49 CS	50+ CS
1673-1	1-Color				
1673-2	2-Color				
1673-3	3-Color				
1673-B	Blank				
1673-BLUE	Blue/Yellow				
1673-RED	Red/Yellow				

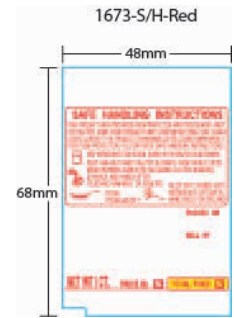

Tec SL-66-30/SL-6600 6 Line Bar Code & Net Wt.

Heartland Product Family: 1676

Recommended for use on these units: Tec SL-66-30/SL-6600 6 Line Bar Code & Net Wt.

Width	Length	Labels / roll	Rolls / case	Core ID	Roll OD	Weight / case	Cases / pallet
48 mm	68.8 mm	400	16	1.63 in	3.4 in	10 lbs	135

Stock Labels

Item #	Colors	Features	5-24 CS	25-49 CS	50+ CS
1676	Blue/Yellow				

Custom Labels

Item #	Colors	Features	5-24 CS	25-49 CS	50+ CS
1676-1	1-Color				
1676-2	2-Color				
1676-3	3-Color				
1676-B	Blank				

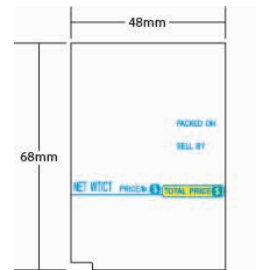

Total Price box prints Pantone Yellow;
Balance of label prints Process Blue

Tec SL-66-30/SL-6600 22 Line Ingredient w/Perf

Heartland Product Family: 1680

Recommended for use on these units: Tec SL-66-30/SL-6600 22 Line Ingredient w/Perf

Width	Length	Labels / roll	Rolls / case	Core ID	Roll OD	Weight / case	Cases / pallet
48 mm	112.7 mm	225	16	1.63 in	3.3 in	9 lbs	135

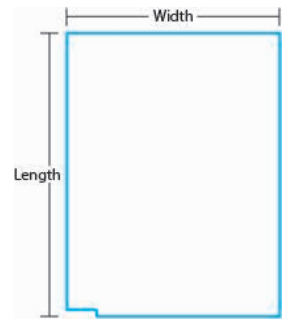

Stock Labels

Item #	Colors	Features	5-24 CS	25-49 CS	50+ CS
1680-P	Blue/Yellow	Perforated			

Custom Labels

Item #	Colors	Features	5-24 CS	25-49 CS	50+ CS
1680-1P	1-Color	Perforated			
1680-2P	2-Color	Perforated			
1680-3P	3-Color	Perforated			
1680-BP	Blank	Perforated			
1680-S/HP	Blue/Yellow	Safe Handling			

Tec SL-9000 UPC 49.2mm

Heartland Product Family: 1681

Recommended for use on these units: Tec SL-9000 UPC 49.2mm

Width	Length	Labels / roll	Rolls / case	Core ID	Roll OD	Weight / case	Cases / pallet
57 mm	49.2 mm	600	16	1.63 in	3.5 in	12 lbs	120

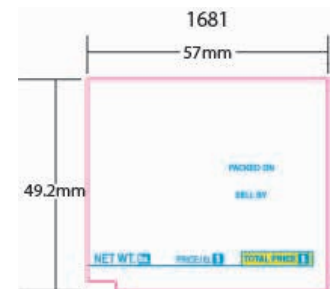

Stock Labels

Item #	Colors	Features	5-24 CS	25-49 CS	50+ CS
1681	Blue/Yellow				

Custom Labels

Item #	Colors	Features	5-24 CS	25-49 CS	50+ CS
1681-1	1-Color				
1681-2	2-Color				
1681-3	3-Color				
1681-B	Blank				

Tec SL-9000 UPC 63.5mm

Heartland Product Family: 1682

Recommended for use on these units: Tec SL-9000 UPC 63.5mm

Width	Length	Labels / roll	Rolls / case	Core ID	Roll OD	Weight / case	Cases / pallet
57 mm	63.5 mm	450	16	1.63 in	3.5 in	12 lbs	120

Stock Labels

Item #	Colors	Features	5-24 CS	25-49 CS	50+ CS
1682	Blue/Yellow				
1682-BLACK-S/H	Black/Blue/Yellow	Safe Handling			
1682-S/H	Blue/Yellow	Safe Handling			

Custom Labels

Item #	Colors	Features	5-24 CS	25-49 CS	50+ CS
1682-1	1-Color				
1682-2	2-Color				
1682-3	3-Color				
1682-B	Blank				

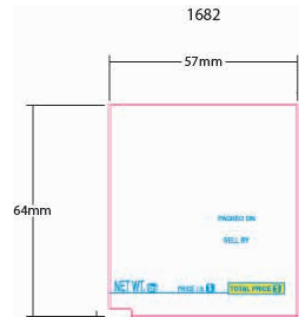

Tec SL-9000 UPC 92.8mm

Heartland Product Family: 1683

Recommended for use on these units: Tec SL-9000 UPC 92.8mm

Width	Length	Labels / roll	Rolls / case	Core ID	Roll OD	Weight / case	Cases / pallet
57 mm	92.8 mm	300	16	1.63 in	3.4 in	11 lbs	120

Stock Labels

Item #	Colors	Features	5-24 CS	25-49 CS	50+ CS
1683	Blue/Yellow				
1683-BLACK-S/H	Black/Blue/Yellow	Safe Handling			

Custom Labels

Item #	Colors	Features	5-24 CS	25-49 CS	50+ CS
1683-1	1-Color				
1683-2	2-Color				
1683-3	3-Color				
1683-B	Blank				
1683-S/H	Blue/Yellow	Safe Handling			

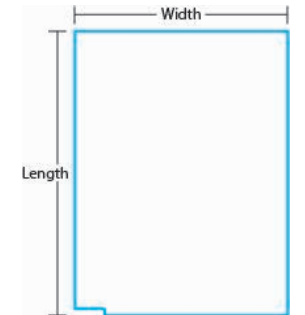

Tec SL-9000 UPC 112.7mm

Heartland Product Family: 1685

Recommended for use on these units: Tec SL-9000 UPC 112.7mm

Width	Length	Labels / roll	Rolls / case	Core ID	Roll OD	Weight / case	Cases / pallet
57 mm	112.7 mm	250	16	1.63 in	3.4 in	11 lbs	120

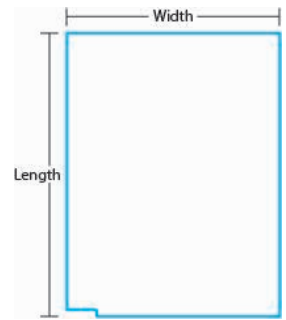

Stock Labels

Item #	Colors	Features	5-24 CS	25-49 CS	50+ CS
1685	Blue/Yellow				

Custom Labels

Item #	Colors	Features	5-24 CS	25-49 CS	50+ CS
1685-1	1-Color				
1685-2	2-Color				
1685-3	3-Color				
1685-B	Blank				
1685-S/H	Black/Blue/ Yellow	Safe Handling			

Toledo

Toledo Impact UPC

Heartland Product Family: 1100

Recommended for use on these units: Toledo Impact UPC

Width	Length	Labels / roll	Rolls / case	Core ID	Roll OD	Weight / case	Cases / pallet
2.625 in	1.9375 in	1900	10	1.63 in	5.8 in	26 lbs	48

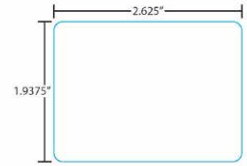

Custom Labels

Item #	Colors	Features	5-24 CS	25-49 CS	50+ CS
1100	Red/Yellow				
1100-1	1-Color				
1100-2	2-Color				
1100-3	3-Color				
1100-B	Blank				

Toledo 8442 et 2.4

Heartland Product Family: 1120

Recommended for use on these units: Toledo 8442 et 2.4

Width	Length	Labels / roll	Rolls / case	Core ID	Roll OD	Weight / case	Cases / pallet
2.3125 in	2.375 in	925	20	1.63 in	4.6 in	27 lbs	60

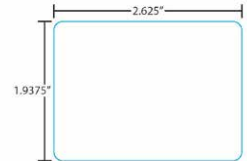

Custom Labels

Item #	Colors	Features	5-24 CS	25-49 CS	50+ CS
1120	Red/Yellow				

Toledo 325/UCST UL

Heartland Product Family: 1710

Recommended for use on these units: Toledo 325/UCST UL

Width	Length	Labels / roll	Rolls / case	Core ID	Roll OD	Weight / case	Cases / pallet
2.625 in	2.0625 in	500	30	1.56 in	3.3 in	22 lbs	56



Stock Labels

Item #	Colors	Features	5-24 CS	25-49 CS	50+ CS
1710	Red/Yellow				
1710-B	Blank				

Custom Labels

Item #	Colors	Features	5-24 CS	25-49 CS	50+ CS
1710-1	1-Color				
1710-2	2-Color				
1710-3	3-Color				

Toledo 325/UCST UPC

Heartland Product Family: 1711

Recommended for use on these units: Toledo 325/UCST UPC

Width	Length	Labels / roll	Rolls / case	Core ID	Roll OD	Weight / case	Cases / pallet
2.625 in	1.9375 in	500	30	1.56 in	3.3 in	21 lbs	56

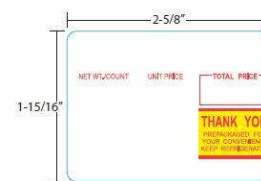

Stock Labels

Item #	Colors	Features	5-24 CS	25-49 CS	50+ CS
1711	Red/Yellow				

Custom Labels

Item #	Colors	Features	5-24 CS	25-49 CS	50+ CS
1711-1	1-Color				
1711-2	2-Color				
1711-3	3-Color				
1711-B	Blank				

Toledo 325/8425/UCST Continuous Strip No Side Liner 10 rls/cs

Heartland Product Family: 1714

Recommended for use on these units: Toledo 325/8425/UCST Continuous Strip No Side Liner 10 rls/cs

Width	Length	Labels / roll	Rolls / case	Core ID	Roll OD	Weight / case	Cases / pallet
2.71875 in	1020 in	1020	10	1.56 in	3.2 in	8 lbs	200

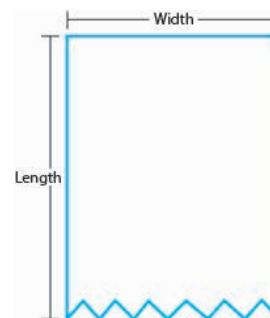

Custom Labels

Item #	Colors	Features	5-24 CS	25-49 CS	50+ CS
1714-1	1-Color				
1714-2	2-Color				
1714-3	3-Color				
1714-B	Blank				

Toledo 350/8450/bPro Continuous Strip Edge to Edge

Heartland Product Family: 1715

Recommended for use on these units: Toledo 350/8450/bPro Continuous Strip Edge to Edge

Width	Length	Labels / roll	Rolls / case	Core ID	Roll OD	Weight / case	Cases / pallet
2.71875 in	2520 in	2520	20	1.56 in	4.7 in	35 lbs	60

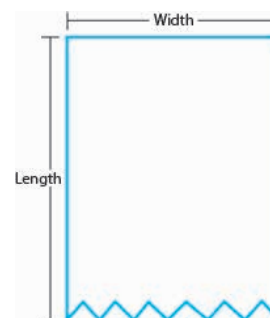

Stock Labels

Item #	Colors	Features	5-24 CS	25-49 CS	50+ CS
1715-B	Blank				

Custom Labels

Item #	Colors	Features	5-24 CS	25-49 CS	50+ CS
1715-1	1-Color				
1715-2	2-Color				
1715-3	3-Color				

Toledo

Toledo 350/8450/bPro UPC et 2.4

Heartland Product Family: 1716

Recommended for use on these units: Toledo 350/8450/bPro UPC et 2.4

Width	Length	Labels / roll	Rolls / case	Core ID	Roll OD	Weight / case	Cases / pallet
2.625 in	2.375 in	1000	20	1.56 in	4.7 in	33 lbs	60

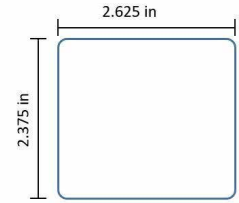

Custom Labels

Item #	Colors	Features	5-24 CS	25-49 CS	50+ CS
1716	Brown				
1716-1	1-Color				
1716-1P	1-Color	Perforated			
1716-2	2-Color				
1716-2P	2-Color	Perforated			
1716-3	3-Color				
1716-3P	3-Color	Perforated			
1716-B	Blank				
1716-BP	Blank	Perforated			
1716-P	Brown	Perforated			

Toledo Hi-Liter Direct Thermal

Heartland Product Family: 1718

Recommended for use on these units: Toledo Hi-Liter Direct Thermal

Width	Length	Labels / roll	Rolls / case	Core ID	Roll OD	Weight / case	Cases / pallet
1.56 in	0.9687 in	3000	10	1.56 in	5.3 in	14 lbs	120

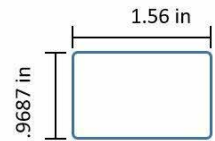

Stock Labels

Item #	Colors	Features	5-24 CS	25-49 CS	50+ CS
1718-B	Blank-Fluorescent				

Toledo 325/8425/UCST Continuous Strip No Side Liner 30 rls/cs

Heartland Product Family: 1719

Recommended for use on these units: Toledo 325/8425/UCST Continuous Strip No Side Liner 30 rls/cs

Width	Length	Labels / roll	Rolls / case	Core ID	Roll OD	Weight / case	Cases / pallet
2.71875 in	1020 in	1020	30	1.56 in	3.2 in	21 lbs	56

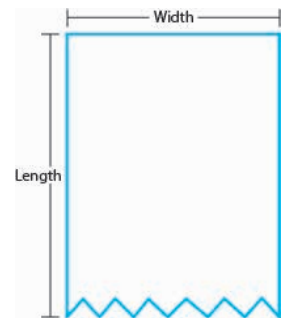

Stock Labels

Item #	Colors	Features	5-24 CS	25-49 CS	50+ CS
1719-B	Blank				

Custom Labels

Item #	Colors	Features	5-24 CS	25-49 CS	50+ CS
1719-1	1-Color				
1719-2	2-Color				
1719-3	3-Color				

Toledo 325/8425/UCST Continuous Strip with Side Liner 10 rls/cs

Heartland Product Family: 1721

Recommended for use on these units: Toledo 325/8425/UCST Continuous Strip with Side Liner 10 rls/cs

Width	Length	Labels / roll	Rolls / case	Core ID	Roll OD	Weight / case	Cases / pallet
2.625 in	1020 in	1020	10	1.56 in	3.2 in	8 lbs	200

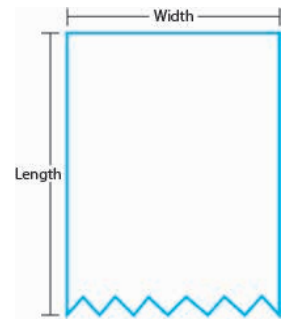

Stock Labels

Item #	Colors	Features	5-24 CS	25-49 CS	50+ CS
1721-B	Blank				

Custom Labels

Item #	Colors	Features	5-24 CS	25-49 CS	50+ CS
1721-1	1-Color				
1721-2	2-Color				
1721-3	3-Color				

Toledo 325/8460/UCST et 2.4

Heartland Product Family: 1723

Recommended for use on these units: Toledo 325/8460/UCST et 2.4

Width	Length	Labels / roll	Rolls / case	Core ID	Roll OD	Weight / case	Cases / pallet
2.625 in	2.375 in	500	30	1.56 in	3.5 in	25 lbs	56

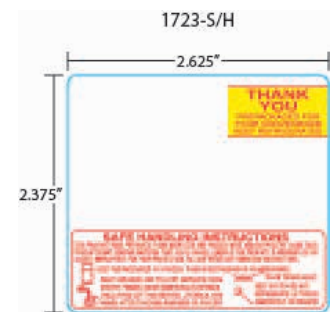

Stock Labels

Item #	Colors	Features	5-24 CS	25-49 CS	50+ CS
1723	Red/Yellow				
1723-B	Blank				
1723-BP	Blank	Perforated			
1723-P	Red/Yellow	Perforated			
1723-S/H	Red/Yellow	Safe Handling			
1723-S/H-BLACK	Red/Yellow/ Black	Safe Handling			

Custom Labels

Item #	Colors	Features	5-24 CS	25-49 CS	50+ CS
1723-1	1-Color				
1723-1P	1-Color	Perforated			
1723-2	2-Color				
1723-2P	2-Color	Perforated			
1723-3	3-Color				
1723-3P	3-Color	Perforated			

Toledo

Toledo 325/8460/UCST et 3.7

Heartland Product Family: 1724

Recommended for use on these units: Toledo 325/8460/UCST et 3.7

Width	Length	Labels / roll	Rolls / case	Core ID	Roll OD	Weight / case	Cases / pallet
2.625 in	3.75 in	325	30	1.56 in	3.5 in	25 lbs	56

Stock Labels

Item #	Colors	Features	5-24 CS	25-49 CS	50+ CS
1724	Red/Yellow				
1724-B	Blank				
1724-P	Red/Yellow	Perforated			

Custom Labels

Item #	Colors	Features	5-24 CS	25-49 CS	50+ CS
1724-1	1-Color				
1724-1P	1-Color	Perforated			
1724-2	2-Color				
1724-2P	2-Color	Perforated			
1724-3	3-Color				
1724-3P	3-Color	Perforated			
1724-BP	Blank	Perforated			
1724-S/H	Red/Yellow	Safe Handling			

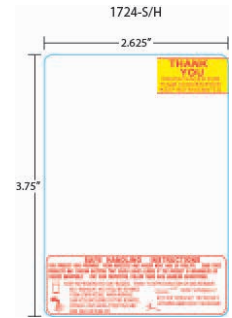

Toledo 350/8450/bPro UPC et 3.7

Heartland Product Family: 1725

Recommended for use on these units: Toledo 350/8450/bPro UPC et 3.7

Width	Length	Labels / roll	Rolls / case	Core ID	Roll OD	Weight / case	Cases / pallet
2.625 in	3.75 in	650	20	1.56 in	4.7 in	34 lbs	60

Custom Labels

Item #	Colors	Features	5-24 CS	25-49 CS	50+ CS
1725	Brown				
1725-1	1-Color				
1725-1P	1-Color	Perforated			
1725-2	2-Color				
1725-2P	2-Color	Perforated			
1725-3	3-Color				
1725-3P	3-Color	Perforated			
1725-B	Blank				
1725-BP	Blank	Perforated			
1725-P	Brown	Perforated			

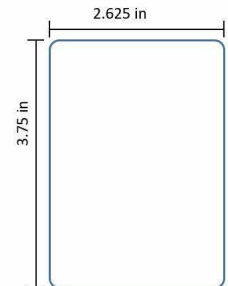

Toledo 350/8450/bPro UPC et 3.3

Heartland Product Family: 1726

Recommended for use on these units: Toledo 350/8450/bPro UPC et 3.3

Width	Length	Labels / roll	Rolls / case	Core ID	Roll OD	Weight / case	Cases / pallet
2.625 in	3.3125 in	725	20	1.56 in	4.7 in	33 lbs	60

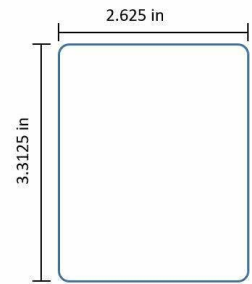

Stock Labels

Item #	Colors	Features	5-24 CS	25-49 CS	50+ CS
1726-B	Blank				

Custom Labels

Item #	Colors	Features	5-24 CS	25-49 CS	50+ CS
1726	Brown				
1726-1	1-Color				
1726-1P	1-Color	Perforated			
1726-2	2-Color				
1726-2P	2-Color	Perforated			
1726-3	3-Color				
1726-3P	3-Color	Perforated			
1726-BP	Blank	Perforated			
1726-P	Brown	Perforated			

Toledo 325/8460/UCST et 3.3

Heartland Product Family: 1727

Recommended for use on these units: Toledo 325/8460/UCST et 3.3

Width	Length	Labels / roll	Rolls / case	Core ID	Roll OD	Weight / case	Cases / pallet
2.625 in	3.3125 in	375	30	1.56 in	3.6 in	26 lbs	56

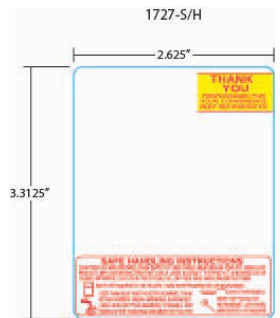

Stock Labels

Item #	Colors	Features	5-24 CS	25-49 CS	50+ CS
1727	Red/Yellow				
1727-B	Blank				
1727-BP	Blank	Perforated			
1727-P	Red/Yellow	Perforated			
1727-S/H	Red/Yellow	Safe Handling			

Custom Labels

Item #	Colors	Features	5-24 CS	25-49 CS	50+ CS
1727-1	1-Color				
1727-1P	1-Color	Perforated			
1727-2	2-Color				
1727-2P	2-Color	Perforated			
1727-3	3-Color				
1727-3P	3-Color	Perforated			

Toledo

Toledo 325/8460/UCST et 4.2

Heartland Product Family: 1728

Recommended for use on these units: Toledo 325/8460/UCST et 4.2

Width	Length	Labels / roll	Rolls / case	Core ID	Roll OD	Weight / case	Cases / pallet
2.625 in	4.25 in	300	30	1.56 in	3.6 in	26 lbs	56

Stock Labels

Item #	Colors	Features	5-24 CS	25-49 CS	50+ CS
1728-B	Blank				

Custom Labels

Item #	Colors	Features	5-24 CS	25-49 CS	50+ CS
1728	Red/Yellow				
1728-1	1-Color				
1728-1P	1-Color	Perforated			
1728-2	2-Color				
1728-2P	2-Color	Perforated			
1728-3	3-Color				
1728-3P	3-Color	Perforated			
1728-BP	Blank	Perforated			
1728-P	Red/Yellow	Perforated			
1728-S/H	Red/Yellow	Safe Handling			

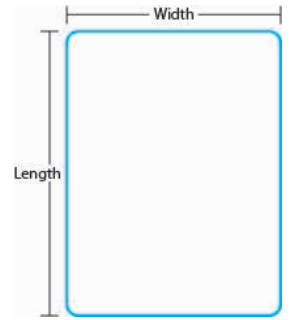

Toledo 325/8460/UCST et 5.1

Heartland Product Family: 1729

Recommended for use on these units: Toledo 325/8460/UCST et 5.1

Width	Length	Labels / roll	Rolls / case	Core ID	Roll OD	Weight / case	Cases / pallet
2.625 in	5.125 in	250	30	1.56 in	3.6 in	26 lbs	56

Stock Labels

Item #	Colors	Features	5-24 CS	25-49 CS	50+ CS
1729-P	Red/Yellow	Perforated			

Custom Labels

Item #	Colors	Features	5-24 CS	25-49 CS	50+ CS
1729	Red/Yellow				
1729-1	1-Color				
1729-1P	1-Color	Perforated			
1729-2	2-Color				
1729-2P	2-Color	Perforated			
1729-3	3-Color				
1729-3P	3-Color	Perforated			
1729-B	Blank				
1729-BP	Blank	Perforated			
1729-S/H	Red/Yellow	Safe Handling			

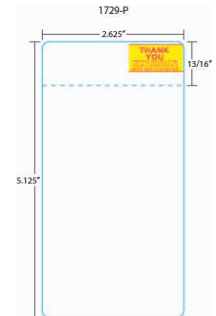

Toledo 315/317/355 et 2.4

Heartland Product Family: 1730

Recommended for use on these units: Toledo 315/317/355 et 2.4

Width	Length	Labels / roll	Rolls / case	Core ID	Roll OD	Weight / case	Cases / pallet
2.625 in	2.375 in	3800	5	4.00 in	9.5 in	32 lbs	60

Stock Labels

Item #	Colors	Features	5-24 CS	25-49 CS	50+ CS
1730-S/H	Red/Yellow	Safe Handling			
1730-S/H-BLACK	Red/Yellow/ Black	Safe Handling			

Custom Labels

Item #	Colors	Features	5-24 CS	25-49 CS	50+ CS
1730	Red/Yellow				
1730-1	1-Color				
1730-1P	1-Color	Perforated			
1730-2	2-Color				
1730-2P	2-Color	Perforated			
1730-3	3-Color				
1730-3P	3-Color	Perforated			
1730-B	Blank				
1730-BP	Blank	Perforated			
1730-P	Red/Yellow	Perforated			

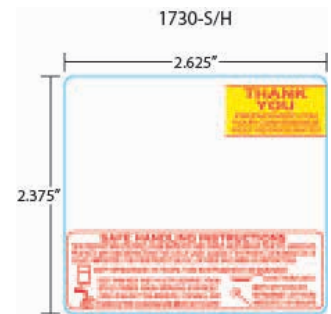

Toledo 315/317/355 et 3.3

Heartland Product Family: 1731

Recommended for use on these units: Toledo 315/317/355 et 3.3

Width	Length	Labels / roll	Rolls / case	Core ID	Roll OD	Weight / case	Cases / pallet
2.625 in	3.3125 in	2700	5	4.00 in	9.4 in	31 lbs	60

Stock Labels

Item #	Colors	Features	5-24 CS	25-49 CS	50+ CS
1731-S/H	Red/Yellow	Safe Handling			

Custom Labels

Item #	Colors	Features	5-24 CS	25-49 CS	50+ CS
1731	Red/Yellow				
1731-1	1-Color				
1731-1P	1-Color	Perforated			
1731-2	2-Color				
1731-2P	2-Color	Perforated			
1731-3	3-Color				
1731-3P	3-Color	Perforated			
1731-B	Blank				
1731-BP	Blank	Perforated			
1731-P	Red/Yellow	Perforated			

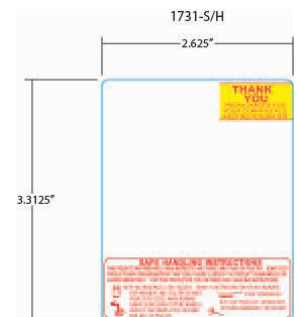

Toledo

Toledo 315/317/355 et 3.7

Heartland Product Family: 1732

Recommended for use on these units: Toledo 315/317/355 et 3.7

Width	Length	Labels / roll	Rolls / case	Core ID	Roll OD	Weight / case	Cases / pallet
2.625 in	3.75 in	2400	5	4.00 in	9.5 in	31 lbs	60

Stock Labels

Item #	Colors	Features	5-24 CS	25-49 CS	50+ CS
1732-B	Blank				

Custom Labels

Item #	Colors	Features	5-24 CS	25-49 CS	50+ CS
1732	Red/Yellow				
1732-1	1-Color				
1732-1P	1-Color	Perforated			
1732-2	2-Color				
1732-2P	2-Color	Perforated			
1732-3	3-Color				
1732-3P	3-Color	Perforated			
1732-BP	Blank	Perforated			
1732-P	Red/Yellow	Perforated			
1732-S/H	Red/Yellow	Safe Handling			

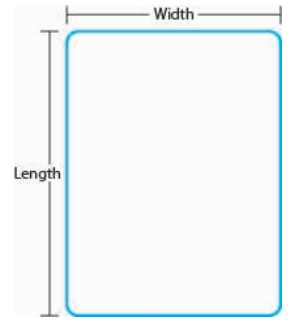

Toledo 315/317/355 et 4.2

Heartland Product Family: 1733

Recommended for use on these units: Toledo 315/317/355 et 4.2

Width	Length	Labels / roll	Rolls / case	Core ID	Roll OD	Weight / case	Cases / pallet
2.625 in	4.25 in	2100	5	4.00 in	9.4 in	31 lbs	60

Custom Labels

Item #	Colors	Features	5-24 CS	25-49 CS	50+ CS
1733	Red/Yellow				
1733-1	1-Color				
1733-1P	1-Color	Perforated			
1733-2	2-Color				
1733-2P	2-Color	Perforated			
1733-3	3-Color				
1733-3P	3-Color	Perforated			
1733-B	Blank				
1733-BP	Blank	Perforated			
1733-P	Red/Yellow	Perforated			
1733-S/H	Red/Yellow	Safe Handling			

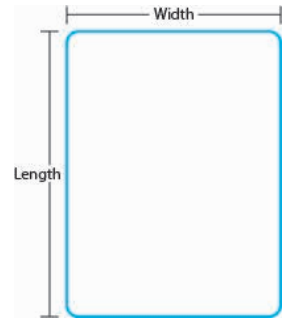

Toledo 350/8450/bPro Continuous Strip with Side Liner

Heartland Product Family: 1739

Recommended for use on these units: Toledo 350/8450/bPro Continuous Strip with Side Liner

Width	Length	Labels / roll	Rolls / case	Core ID	Roll OD	Weight / case	Cases / pallet
2.625 in	2520 in	2520	20	1.56 in	4.7 in	34 lbs	60

Stock Labels

Item #	Colors	Features	5-24 CS	25-49 CS	50+ CS
1739-B	Blank				

Custom Labels

Item #	Colors	Features	5-24 CS	25-49 CS	50+ CS
1739-1	1-Color				
1739-2	2-Color				
1739-3	3-Color				

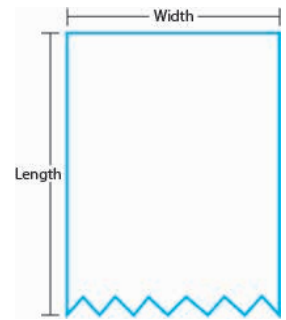

Toledo 350/8450/bPro UPC et 4.2

Heartland Product Family: 1740

Recommended for use on these units: Toledo 350/8450/bPro UPC et 4.2

Width	Length	Labels / roll	Rolls / case	Core ID	Roll OD	Weight / case	Cases / pallet
2.625 in	4.25 in	600	20	1.56 in	4.8 in	35 lbs	60

Stock Labels

Item #	Colors	Features	5-24 CS	25-49 CS	50+ CS
1740-B	Blank				
1740-P	Brown	Perforated			

Custom Labels

Item #	Colors	Features	5-24 CS	25-49 CS	50+ CS
1740	Brown				
1740-1	1-Color				
1740-1P	1-Color	Perforated			
1740-2	2-Color				
1740-2P	2-Color	Perforated			
1740-3	3-Color				
1740-3P	3-Color	Perforated			
1740-BP	Blank	Perforated			

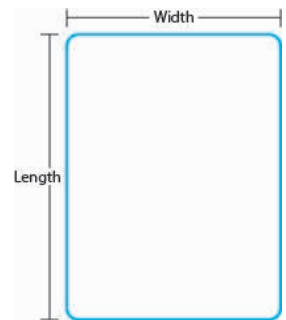

Toledo

Toledo 350/8450/bPro UPC et 5.1

Heartland Product Family: 1742

Recommended for use on these units: Toledo 350/8450/bPro UPC et 5.1

Width	Length	Labels / roll	Rolls / case	Core ID	Roll OD	Weight / case	Cases / pallet
2.625 in	5.125 in	500	20	1.56 in	4.8 in	35 lbs	48

Custom Labels

Item #	Colors	Features	5-24 CS	25-49 CS	50+ CS
1742	Brown				
1742-1	1-Color				
1742-1P	1-Color	Perforated			
1742-2	2-Color				
1742-2P	2-Color	Perforated			
1742-3	3-Color				
1742-3P	3-Color	Perforated			
1742-B	Blank				
1742-BP	Blank	Perforated			
1742-P	Brown	Perforated			

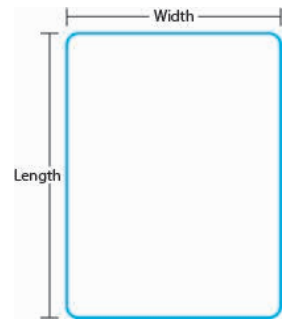

Toledo 8423 Floral

Heartland Product Family: 1755

Recommended for use on these units: Toledo 8423 Floral

Width	Length	Labels / roll	Rolls / case	Core ID	Roll OD	Weight / case	Cases / pallet
1.5625 in	1.53125 in	750	10	1.63 in	3.5 in	6 lbs	200

Custom Labels

Item #	Colors	Features	5-24 CS	25-49 CS	50+ CS
1755-B	Blank				

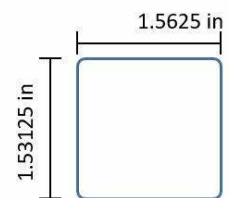

Toledo 325/8425/UCST Continuous Strip with Side Liner 30 rls/cs

Heartland Product Family: 1756

Recommended for use on these units: Toledo 325/8425/UCST Continuous Strip with Side Liner 30 rls/cs

Width	Length	Labels / roll	Rolls / case	Core ID	Roll OD	Weight / case	Cases / pallet
2.625 in	1020 in	1020	30	3.00 in	4.1 in	21 lbs	56

Stock Labels

Item #	Colors	Features	5-24 CS	25-49 CS	50+ CS
1756-B	Blank				

Custom Labels

Item #	Colors	Features	5-24 CS	25-49 CS	50+ CS
1756-1	1-Color				
1756-2	2-Color				
1756-3	3-Color				

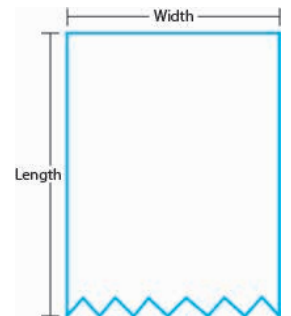

Toledo 8442 UPC

Heartland Product Family: 1760

Recommended for use on these units: Toledo 8442 UPC

Width	Length	Labels / roll	Rolls / case	Core ID	Roll OD	Weight / case	Cases / pallet
2.3125 in	1.9 in	1140	20	1.56 in	4.5 in	27 lbs	60

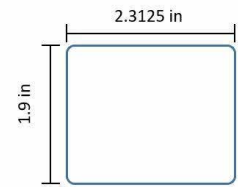

Stock Labels

Item #	Colors	Features	5-24 CS	25-49 CS	50+ CS
1760-B	Blank				

Custom Labels

Item #	Colors	Features	5-24 CS	25-49 CS	50+ CS
1760-1	1-Color				
1760-2	2-Color				
1760-3	3-Color				

Toledo 8442 et 2.4

Heartland Product Family: 1766

Recommended for use on these units: Toledo 8442 et 2.4

Width	Length	Labels / roll	Rolls / case	Core ID	Roll OD	Weight / case	Cases / pallet
2.3125 in	2.375 in	925	20	1.56 in	4.5 in	27 lbs	60

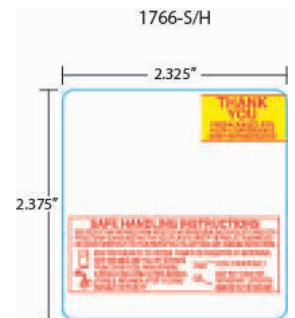

Stock Labels

Item #	Colors	Features	5-24 CS	25-49 CS	50+ CS
1766	Red/Yellow				
1766-B	Blank				
1766-S/H	Red/Yellow	Safe Handling			

Custom Labels

Item #	Colors	Features	5-24 CS	25-49 CS	50+ CS
1766-1	1-Color				
1766-1P	1-Color	Perforated			
1766-2	2-Color				
1766-2P	2-Color	Perforated			
1766-3	3-Color				
1766-3P	3-Color	Perforated			
1766-BP	Blank	Perforated			
1766-P	Red/Yellow	Perforated			

Toledo

Toledo 8442 et 3.3

Heartland Product Family: 1769

Recommended for use on these units: Toledo 8442 et 3.3

Width	Length	Labels / roll	Rolls / case	Core ID	Roll OD	Weight / case	Cases / pallet
2.3125 in	3.3125 in	675	20	1.56 in	4.6 in	28 lbs	60

Stock Labels

Item #	Colors	Features	5-24 CS	25-49 CS	50+ CS
1769	Red/Yellow				
1769-S/H	Red/Yellow	Safe Handling			

Custom Labels

Item #	Colors	Features	5-24 CS	25-49 CS	50+ CS
1769-1	1-Color				
1769-1P	1-Color	Perforated			
1769-2	2-Color				
1769-2P	2-Color	Perforated			
1769-3	3-Color				
1769-3P	3-Color	Perforated			
1769-B	Blank				
1769-BP	Blank	Perforated			
1769-P	Red/Yellow	Perforated			



Toledo 8860-A .97

Heartland Product Family: 1776

Recommended for use on these units: Toledo 8860-A .97

Width	Length	Labels / roll	Rolls / case	Core ID	Roll OD	Weight / case	Cases / pallet
2.625 in	0.96875 in	900	10	1.56 in	3.2 in	7 lbs	200



Custom Labels

Item #	Colors	Features	5-24 CS	25-49 CS	50+ CS
1776-1	1-Color				
1776-2	2-Color				
1776-3	3-Color				
1776-B	Blank				

Toledo 8860-B 1.7

Heartland Product Family: 1777

Recommended for use on these units: Toledo 8860-B 1.7

Width	Length	Labels / roll	Rolls / case	Core ID	Roll OD	Weight / case	Cases / pallet
2.625 in	1.71875 in	550	10	1.56 in	3.2 in	8 lbs	200

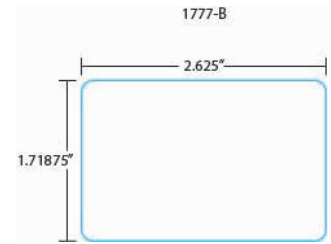

Stock Labels

Item #	Colors	Features	5-24 CS	25-49 CS	50+ CS
1777-B	Blank				

Custom Labels

Item #	Colors	Features	5-24 CS	25-49 CS	50+ CS
1777-1	1-Color				
1777-2	2-Color				
1777-3	3-Color				

Toledo 8860-C-LC 2.65

Heartland Product Family: 1779

Recommended for use on these units: Toledo 8860-C-LC 2.65

Width	Length	Labels / roll	Rolls / case	Core ID	Roll OD	Weight / case	Cases / pallet
2.625 in	2.65625 in	3000	5	4.00 in	9.0 in	28 lbs	100

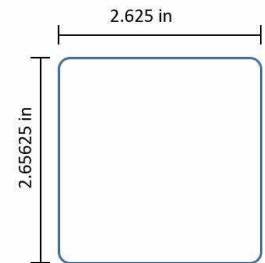

Custom Labels

Item #	Colors	Features	5-24 CS	25-49 CS	50+ CS
1779-1	1-Color				
1779-2	2-Color				
1779-3	3-Color				
1779-B	Blank				

Toledo 8860-C 2.65

Heartland Product Family: 1780

Recommended for use on these units: Toledo 8860-C 2.65

Width	Length	Labels / roll	Rolls / case	Core ID	Roll OD	Weight / case	Cases / pallet
2.625 in	2.65625 in	350	10	1.56 in	3.2 in	7 lbs	200

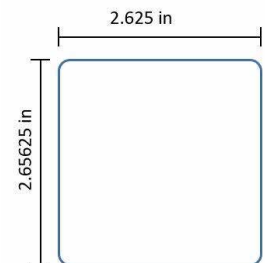

Stock Labels

Item #	Colors	Features	5-24 CS	25-49 CS	50+ CS
1780-B	Blank				

Custom Labels

Item #	Colors	Features	5-24 CS	25-49 CS	50+ CS
1780-1	1-Color				
1780-2	2-Color				
1780-3	3-Color				

Toledo

Toledo 880

Heartland Product Family: 1782

Recommended for use on these units: Toledo 880

Width	Length	Labels / roll	Rolls / case	Core ID	Roll OD	Weight / case	Cases / pallet
2.625 in	3.75 in	2250	5	3.00 in	8.8 in	29 lbs	60

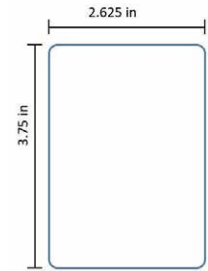

Custom Labels

Item #	Colors	Features	5-24 CS	25-49 CS	50+ CS
1782-B	Blank				
1782-1	1-Color				
1782-2	2-Color				
1782-3	3-Color				

Toledo 880

Heartland Product Family: 1783

Recommended for use on these units: Toledo 880

Width	Length	Labels / roll	Rolls / case	Core ID	Roll OD	Weight / case	Cases / pallet
2.625 in	3.313 in	2550	5	3.00 in	8.8 in	29 lbs	60

Custom Labels

Item #	Colors	Features	5-24 CS	25-49 CS	50+ CS
1783-B	Blank				
1783-1	1-Color				
1783-2	2-Color				
1783-3	3-Color				

Toledo 880

Heartland Product Family: 1784

Recommended for use on these units: Toledo 880

Width	Length	Labels / roll	Rolls / case	Core ID	Roll OD	Weight / case	Cases / pallet
2.265 in	4 in	2100	5	3.00 in	8.8 in	25 lbs	60

Custom Labels

Item #	Colors	Features	5-24 CS	25-49 CS	50+ CS
1784-B	Blank				
1784-1	1-Color				
1784-2	2-Color				
1784-3	3-Color				

Toledo 880

Heartland Product Family: 1785

Recommended for use on these units: Toledo 880

Width	Length	Labels / roll	Rolls / case	Core ID	Roll OD	Weight / case	Cases / pallet
2.265 in	2.375 in	3500	5	3.00 in	8.8 in	26 lbs	60

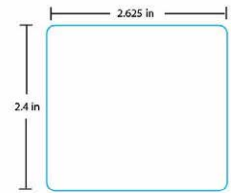

Custom Labels

Item #	Colors	Features	5-24 CS	25-49 CS	50+ CS
1785-B	Blank				
1785-1	1-Color				
1785-2	2-Color				
1785-3	3-Color				

Toledo 8860-D 3.87

Heartland Product Family: 1790

Recommended for use on these units: Toledo 8860-D 3.87

Width	Length	Labels / roll	Rolls / case	Core ID	Roll OD	Weight / case	Cases / pallet
2.625 in	3.875 in	250	10	1.56 in	3.2 in	7 lbs	200

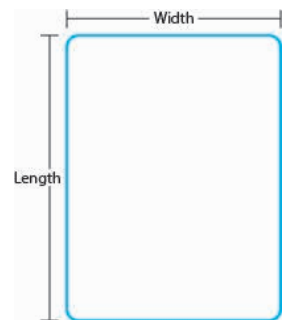

Stock Labels

Item #	Colors	Features	5-24 CS	25-49 CS	50+ CS
1790-B	Blank				

Custom Labels

Item #	Colors	Features	5-24 CS	25-49 CS	50+ CS
1790-1	1-Color				
1790-2	2-Color				
1790-3	3-Color				

Tor-Rey

Tor-Rey PLS-40L, LSQ-40L, TLS-40L 60mm

Heartland Product Family: 1378

Recommended for use on these units: Tor-Rey PLS-40L, LSQ-40L, TLS-40L 60mm

Width	Length	Labels / roll	Rolls / case	Core ID	Roll OD	Weight / case	Cases / pallet
58 mm	60 mm	1000	12	1.63 in	4.7 in	18 lbs	96

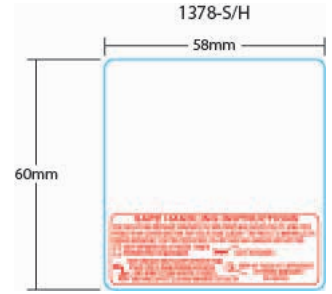

Stock Labels

Item #	Colors	Features	5-24 CS	25-49 CS	50+ CS
1378-S/H	Red	Safe Handling			

Custom Labels

Item #	Colors	Features	5-24 CS	25-49 CS	50+ CS
1378-1	1-Color				
1378-2	2-Color				
1378-3	3-Color				
1378-B	Blank				

Tor-Rey PLS-40L, LSQ-40L, TLS-40L 40mm

Heartland Product Family: 1393

Recommended for use on these units: Tor-Rey PLS-40L, LSQ-40L, TLS-40L 40mm

Width	Length	Labels / roll	Rolls / case	Core ID	Roll OD	Weight / case	Cases / pallet
58 mm	40 mm	1500	12	1.63 in	4.8 in	18 lbs	96

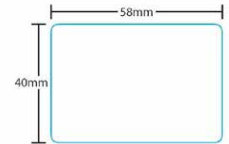

Stock Labels

Item #	Colors	Features	5-24 CS	25-49 CS	50+ CS
1393-B	Blank				

Custom Labels

Item #	Colors	Features	5-24 CS	25-49 CS	50+ CS
1393-1	1-Color				
1393-2	2-Color				
1393-3	3-Color				

STANDARD INK COLORS

Heartland recommends print areas of the label to be ink free. Heartland will not be responsible for print head damage, when customers request ink coverage in machine print areas.

CUSTOM INK COLOR: A \$25.00 charge will apply for non-standard colors or color matching. This charge will be waived for orders of 25 cases or more.



PANTONE
YELLOW



PANTONE
101 M



PANTONE
121 M



PANTONE
123 M



PANTONE
131 M



PANTONE
144 M



PANTONE
021 M



WARM
RED



PANTONE
032 M



PANTONE
185 M



RUBINE
RED



PANTONE
199 M



PANTONE
485 M



PANTONE
201 M



PANTONE
208 M



PANTONE
221 M



PANTONE
GREEN



PANTONE
320 M



PANTONE
348 M



PANTONE
355 M



PANTONE
357 M

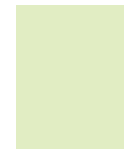

PANTONE
365 M



PANTONE
375 M



PROCESS
BLUE



REFLEX
BLUE



PANTONE
281 M



PANTONE
293 M



PANTONE
297 M



PANTONE
2975 M



PANTONE
300 M



PANTONE
PURPLE



PANTONE
224 M



PANTONE
259 M



PANTONE
2597 M



PANTONE
VIOLET



PANTONE
263 M



PANTONE
465 M



PANTONE
469 M



PANTONE
470 M



PANTONE
155 M



PANTONE
172 M



PANTONE
BLACK

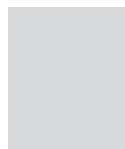

PANTONE
COOL GRAY 3



PANTONE
COOL GRAY 6



PANTONE
182 M

Sample colors shown are a close representation of Pantone colors. Paper grades and finishes may cause color variations. We cannot guarantee exact color matches.



HEARTLAND, winners of the Manufacturing Excellence Award for Innovation in the Fox Valley and chosen by Inc. Magazines fastest growing list of private companies in America, is your first choice for all your label and receipt paper needs. We cover customer demands as small as 5 cases to over 10,000.

LABELS

Materials

- Direct Thermal
 - High speed
 - IR/Near IR
- Thermal transfer
- Film
- Tag
- Piggy back
- Black out

Adhesives

- Permanent
- Cold temp
- Removable
- Freezer grade
- Patterned
- Deadened

Finishing

- Roll OD from 1" to 24"
- Core ID .75" to 4"
- Fanfolded

Capabilities

- Width from .25" to 20"
- Up to 6 colors
- Printing front and back
- Heat resistant inks
- Multiple die cuts
- Under slitting

Specialty

- UV Varnish
- Matte Varnish
- Delam/relam
- Couponing
- Security slits
- Perforations

Applications

- Bar coding
- Product identification
- Shipping labels
- RFID tags
- File folders
- Medical labeling
- Compliance labeling
- Weigh scale labels
- USDA food grade labels

