



# STAIRMASTER® CLUBTRACK® TREADMILLS

USER'S GUIDE FOR THE:

510 TREADMILL

510 PLUS TREADMILL

612 TREADMILL

612 PLUS TREADMILL



**StairMaster.**  
THE RESULTS YOU WANT™

**(This page blank)**



# StairMaster®



## Corporate Headquarters

12421 Willows Road N.E., Suite 100  
Kirkland, WA 98034

(800) 635-2936

(425) 823-1825

Fax (425) 823-9490

[www.stairmaster.com](http://www.stairmaster.com)

Printed in the United States.

© 2002 StairMaster® Health & Fitness Products, Inc.

All rights reserved.



This is the CE marking of conformity indicating that the device having this symbol on its immediate label meets the applicable requirements of the EMC, Low Voltage, and Machinery Directives.

**P/N 00501-841 Rev New**

© 2002 StairMaster Health & Fitness Products, Inc. StairMaster and ClubTrack are registered trademarks or trademarks of StairMaster Health & Fitness Products, Inc. in the United States and/or other countries. All other trademarks are trademarks of their respective companies.

# WARRANTY

This is to certify that the StairMaster® ClubTrack® 510/612 treadmills and the ClubTrack 510/612 Plus treadmills are warranted by StairMaster Health & Fitness Products, Inc. to be free of all defects in materials and workmanship. This warranty does not apply to any defect caused by negligence, misuse, accident, alteration, improper maintenance, or an "act of God." This warranty is non-transferable from the original owner.

If, within two years from the date of purchase, any part of the StairMaster ClubTrack treadmill should fail to operate properly contact our Customer Service Department to report the problem. When calling, please be prepared to provide the customer service representative with the following information:

- Your name, customer number, shipping address, and telephone number
- The model and serial number of the inoperable machine
- The date(s) of purchase for the inoperable machine(s)
- Your billing address

This information will ensure that you are the only one ordering parts under your warranty protection. If warranty replacement parts are shipped to you, you may be required to return the inoperable parts. To facilitate this process, the following policy has been established:

- Please call our Customer Service Department to receive a Return Material Authorization (RMA) number prior to shipment.
- StairMaster Health & Fitness Products, Inc. will incur all freight charges for warranty parts ordered for a machine that is less than 45 days old. The parts will be shipped to you via an overnight courier.\*
- You are responsible for freight charges on warranty parts for machines that are more than 45 days old. You will not be responsible for the return shipment of the inoperable parts.
- Some inoperable warranty parts must be promptly returned to our Customer Service Department. We will pay the shipping cost for the inoperable warranty parts. Detailed instructions are included with each warranty replacement part.

StairMaster Health & Fitness Products, Inc. neither makes, assumes, nor authorizes any representative or other person to make or assume for us, any other warranty whatsoever, whether expressed or implied, in connection with the sale, service, or shipment of our products. We reserve the right to make changes and improvements in our products without incurring any obligation to similarly alter products previously purchased. In order to maintain your product warranty and to ensure the safe and efficient operation of your machine, only authorized replacement parts can be used. This warranty is void if parts other than those provided by StairMaster Health & Fitness Products, Inc. are used.

\* Note: Aerosol products cannot be transported via air.

Regular use of the StairMaster® ClubTrack® treadmill is a safe and effective way to develop aerobic fitness while conditioning the major muscles of the lower body. To get the best results, and to keep your machine in peak operating condition, you should carefully read and follow the guidelines presented in this manual.

### **WHAT IS IN THIS MANUAL?**

This manual contains operating instructions and maintenance requirements for the StairMaster ClubTrack 510, ClubTrack 612, ClubTrack 510 Plus, and ClubTrack 612 Plus treadmills. The manual is designed for use by club owners and fitness trainers. It is expected that owners and trainers will instruct the client in the proper user of the treadmill and its accessories. Please read the manual carefully, noting the Safety Requirements before using the treadmill.

Throughout this manual, console keypad keystrokes are enclosed in brackets [ ]. The names of the keys and special console operational modes are shown in capital letters. For example, your machine is ready to use when the console displays "SELECT WORKOUT." Press [MANUAL] to start the MANUAL exercise program.

Upon request, StairMaster will provide a technical document containing block-level theory of operation, troubleshooting, removal and replacement instructions (by module), maintenance, and other information that will assist appropriately-trained personnel in repairing those parts of the equipment designated by StairMaster as repairable.



# CONTENTS

<b>SAFETY REQUIREMENTS .....</b>	<b>1</b>
<b>INSTALLATION INSTRUCTIONS .....</b>	<b>4</b>
Site Requirements .....	4
Installation Instructions .....	5
Testing the Treadmill and Controller .....	9
Accessories and Options .....	10
How to reach us .....	10
<b>GUIDELINES FOR GETTING ON AND OFF THE TREADMILL .....</b>	<b>11</b>
<b>LIMITED-ACCESS CONTROL .....</b>	<b>12</b>
Activation .....	12
Deactivation .....	12
Magnetic Key as Emergency Stop .....	13
<b>HEART RATE MONITORING .....</b>	<b>14</b>
Telemetry Heart Rate .....	14
Using the Transmitter Belt .....	14
Maintaining the Transmitter Belt .....	16
Contact Heart Rate .....	17
Using Contact Heart Rate .....	17
<b>EXERCISE INTENSITY, FREQUENCY, &amp; DURATION .....</b>	<b>18</b>
Exercising .....	18
Intensity .....	18
Frequency and Duration .....	19
<b>OPERATING THE CLUBTRACK® 510/612 TREADMILL .....</b>	<b>21</b>
Turning on the Power .....	21
Understanding the Controller .....	21
Controller Keys .....	22
Exercise Program Keypad .....	26
The Quick Start Program .....	27
The Manual Program .....	28
The Fat Burner Program .....	30
The Aerobic Training Program .....	33
The Speed Intervals Program .....	35
The Constant Heart Rate Program .....	38

# CONTENTS

The StairMaster® Submaximal Fitness Test .....	41
Fitness Rating Norms ( $VO_{2max}$ ) .....	44
Heart Rate Input on the ClubTrack 510/612 Treadmills .....	45
Locked/Non-Locked Heart Rate Signal Options .....	45
Error Codes .....	47
1-minute Auto Reset .....	47
Viewing Maintenance Information .....	47
Customizing the ClubTrack 510/612 Treadmill .....	48
Instruction Page .....	49
Using the ClubTrack 510/612 Treadmill .....	50
<b>OPERATING THE CLUBTRACK® 510/612 PLUS TREADMILL .....</b>	<b>51</b>
Turning on the Power .....	51
Understanding the Controller .....	51
Controller Keys .....	52
Displays and Indicators .....	55
Exercise Parameters .....	56
Time .....	56
Distance .....	57
Calories .....	57
Exercise Workout Options.....	58
Manual Workout .....	58
Pre-Programmed Workouts.....	59
Editing a Pre-Programmed Workout .....	63
Interval Workouts .....	65
Heart Rate Control Workout .....	68
Status Screens For All Workouts.....	72
Speed and Grade Graph View .....	72
Manual Mode .....	72
Programmed Workout Mode.....	72
Workout Status View .....	73
Manual and Heart Rate Modes .....	73
Programmed and Interval Modes .....	73
Heart Rate Graph View .....	74
Scanning All Views .....	74
Entering An ID Number .....	74
Error Codes .....	75
5-Minute Auto Reset.....	75
Customizing The ClubTrack 510/612 Plus Treadmill .....	75

# CONTENTS

Entering Custom Mode .....	75
Setting a Custom Greeting .....	76
Viewing Maintenance Information .....	77
Adjusting Screen Contrast .....	78
Setting a User Time Limit .....	78
Setting a Maximum Speed .....	79
Setting US or Metric Units .....	80
Instruction Page .....	80
Using the ClubTrack 510/612 Plus Treadmill .....	81

## **MAINTENANCE ..... 83**

Cleaning .....	83
Treadmill and Controller .....	83
Daily .....	83
Weekly .....	84
Treadmill Interior .....	84
Transmitter Belt .....	84
Transmitter Battery .....	84
Transmitter Storage .....	84
Treadmill Belt Adjustments .....	85
Belt Tension .....	85
Belt Tracking .....	87
Belt Replacement .....	87
Moving and Storing the Treadmill .....	87
Using After Storage Period .....	88

## **TROUBLESHOOTING ..... 89**

Error Codes .....	89
The ClubTrack 510/612 Treadmill .....	89
Self-Test Errors .....	90
Operation Error Codes .....	90
The ClubTrack 510/612 Plus Treadmill .....	92
Self-Test Errors .....	93
Operation Errors .....	93
Transmitter Belt .....	95
Troubleshooting the Treadmill .....	96





## CONTENTS

<b>SPECIFICATIONS .....</b>	<b>98</b>
Treadmill Frame .....	98
Performance .....	98
Physical .....	98
Environmental .....	98
Power Requirements .....	99
Fuse Ratings .....	100
Controller Specifications .....	100
The ClubTrack 510/612 Treadmill .....	100
The ClubTrack 510/612 Plus Treadmill .....	102
Symbols and Labels .....	104
 <b>IMPORTANT PHONE NUMBERS .....</b>	 <b>106</b>



**(This page blank)**

# SAFETY REQUIREMENTS

WHEN USING ELECTRICAL EQUIPMENT, ALWAYS FOLLOW THESE BASIC PRECAUTIONS:

## IMPORTANT SAFETY INSTRUCTIONS



This symbol appearing throughout this manual means Attention! Be Alert! Your safety is involved.

The following definitions apply to the words "Danger" and "Warning" found throughout this manual:

**DANGER** - Used to call attention to IMMEDIATE hazards which, if not avoided, will result in immediate, serious personal injury or loss of life.

**WARNING** - Used to call attention to POTENTIAL hazards that could result in personal injury or loss of life.

### READ ALL INSTRUCTIONS BEFORE USING THE MACHINE.



#### **DANGER**

To reduce the risk of electrical shock, always unplug the external power supply from the electrical outlet before cleaning, maintaining, or repairing.



#### **WARNING**

To reduce the risk of burns, electric shock, or injury to persons:

Read this manual in full before operating the treadmill. Failure to follow these guidelines can produce a serious or possibly fatal electrical shock hazard or other serious injury. Consult a qualified electrician as required.

1. The controller Power key does not turn off the electrical current to the treadmill. The treadmill continues to draw power, even when the controller is off. To avoid electric shock, do not remove treadmill hood or place hands beneath the treadmill while the treadmill is plugged into a power source.
2. Do not start the treadmill when someone else is standing on the belt.



## SAFETY REQUIREMENTS

3. Keep speed and grade at the lowest settings when someone is getting on and off the treadmill.
4. Keep the area underneath and around the treadmill clear.
5. Before each use of this equipment, check the power receptacle for signs of damage. Do not operate the equipment if the integrity of this item is in question.
6. To avoid potential safety and electrical problems, use parts and accessories that meet StairMaster specifications.
7. This equipment is classified Class I, Type B, ordinary equipment. Not protected against fluid ingress. Rated for continuous operation. Do not operate this equipment in the presence of flammable anesthetic mixtures.
8. Do not let liquid enter the controller. If it does, the controller must be inspected and tested for safety by an approved technician before it can be used again.
10. Increased risk due to leakage current can result if this equipment is not grounded properly.
11. The treadmill must be on an appropriate, dedicated electrical circuit. Nothing else should be connected to the circuit.
12. Incorrect installation by unauthorized personnel can lead to equipment damage and may void the warranty.
13. Do not stand on treadmill hood or front trim cover.
14. Close supervision is necessary whenever the machine is used by or near children, invalids, or disabled persons.



## **SAFETY REQUIREMENTS**

Failure to follow the conditions set forth below shall limit, to the extent allowed by law, StairMaster Health & Fitness Products, Inc. Company's responsibility for the safety, reliability, and performance of this equipment.

- The operator manual must be read in full by each owner and trainer before the product is first used. Each user must be instructed in the proper use of the treadmill and its accessories.
- Assembly operations, extensions, readjustments, modifications, or repairs must be carried out only by StairMaster-trained or StairMaster-authorized personnel.
- The electrical wiring within the treadmill setting and the electrical installation of the treadmill must comply with the applicable local or provincial requirements.
- The equipment must be used in accordance with the instructions for use.

## **SAVE THESE INSTRUCTIONS**

# INSTALLATION INSTRUCTIONS

When the carrier delivers your order, verify that the number of items received equals the number listed on the freight bill or express receipt. Inspect the containers for damage. Itemize discrepancies and damage on the waybill and have the agent sign it. Failure to adequately describe external evidence of loss may result in the carrier refusing to honor your claim. Do not discard the packing materials until you have verified physical condition and proper operation.

The treadmill and controller must be installed correctly before being used. StairMaster® recommends that you contact your treadmill dealer or sales representative when your equipment arrives. The representative will help unpack, install, and demonstrate it, to ensure that:

- The equipment is free from shipping damage
- The treadmill is connected correctly to the appropriate AC power source
- Installation and operation are in accordance with StairMaster standards

Incorrect installation by unauthorized personnel can lead to equipment damage and may void the warranty.



## WARNING

THE TREADMILL MUST BE ON A DEDICATED BRANCH CIRCUIT.  
NO OTHER DEVICE SHOULD BE CONNECTED TO THAT CIRCUIT.  
EXCESSIVE RISK CURRENT (LEAKAGE) CAN RESULT IF THE  
EQUIPMENT IS NOT PROPERLY GROUNDED.  
FAILURE TO FOLLOW THESE GUIDELINES WILL PRODUCE A SERIOUS  
OR POSSIBLY FATAL ELECTRICAL SHOCK HAZARD.  
CONSULT A QUALIFIED ELECTRICIAN AS REQUIRED.

## Site Requirements

The treadmill requires a dedicated AC power line. To ensure electrical safety, the treadmill is equipped with a three-wire power cord and three-pronged plug. To maintain ground reliability, the plug must be connected to an equivalent

# INSTALLATION INSTRUCTIONS

grounded receptacle. The treadmill is designed to operate in a typical exercise environment with adequate heat dissipation (1850 Watts maximum). Place the treadmill on a flat surface, free of moisture and debris. Maintain a minimum clearance of 1.5 feet on each side and 6 feet at the rear.

## Installation Instructions

If you choose to install your treadmill without the assistance of your StairMaster representative, follow the procedure given below:

### Tools:

- Flat blade screwdriver
  - 4-mm Hex key (allen wrench, provided)
  - 13-mm Hex socket wrench
  - Torque wrench, *if available*
1. Grasp the controller uprights and pull the upright tube ends over the brackets. Lift the controller, pivoting the uprights until the upright tubes slide down the brackets. **Note: Gently pull slack from the controller cable down to the bottom of the upright to keep from damaging any wires.**

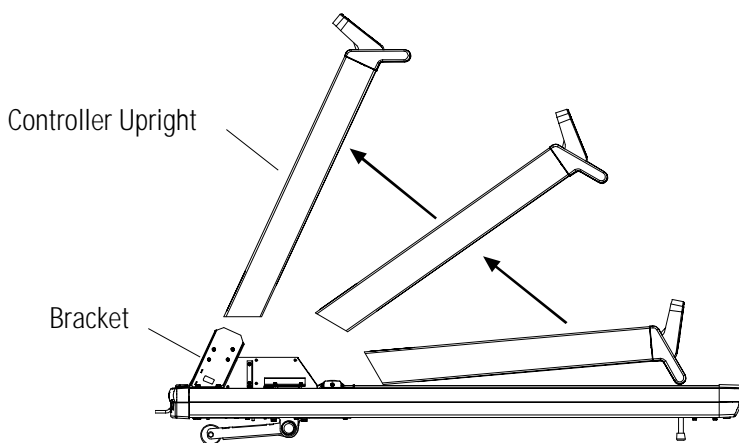

## INSTALLATION INSTRUCTIONS

2. Align the holes in the base of the uprights with the holes in the upright brackets; there are four holes in each bracket. Fasten the uprights into place with the hardware supplied with the treadmill: M8 bolt, M8 lock washer, and M8 flat washer (all black).

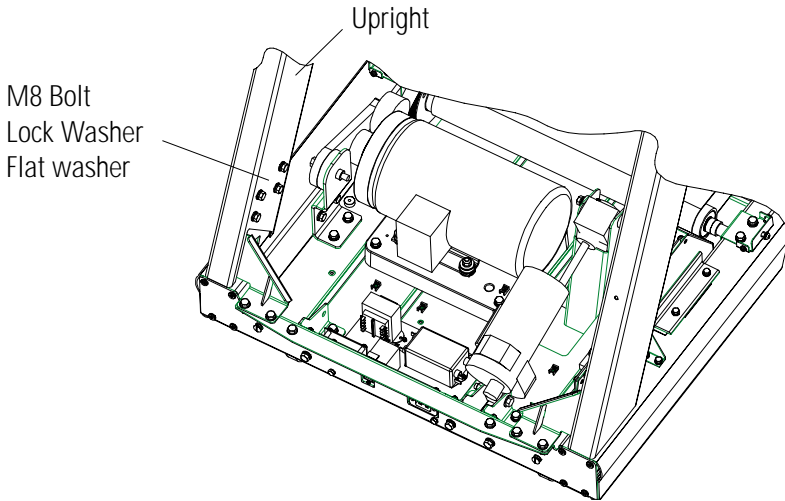

3. Tighten each bolt securely with a 13-mm socket wrench. If available, use a torque wrench to tighten each bolt to 200 in/lb. Do not over tighten.
4. Loop the controller cable slack and secure in the clamp provided. Clamp the EMI suppressor provided over the controller cable.
5. Remove the treadmill hood and trim cover from the packaging.
6. Install the hood between the uprights and align the holes at the front and sides.
7. Install the M8 bolts, flat washers, lock washers, and hex nuts at the front of hood. Install M6 button head screw and lock washer.



# INSTALLATION INSTRUCTIONS

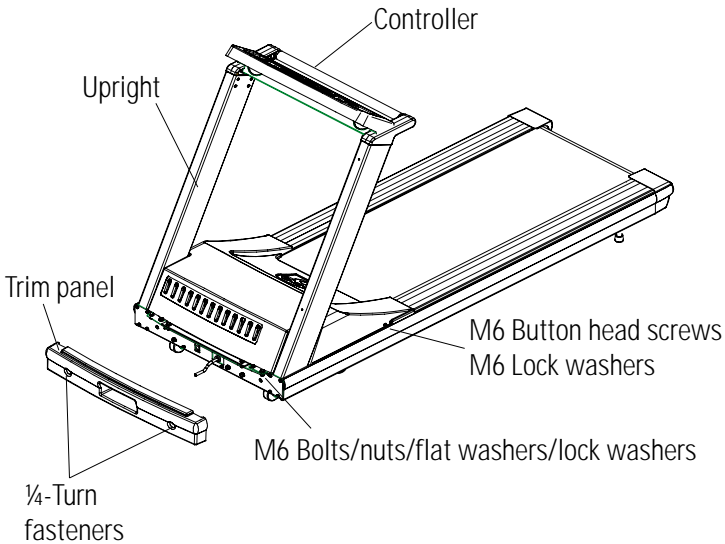

8. Feed the power cord through the hole in the trim panel, position the trim panel on front of the treadmill, and fasten the two ¼-turn fasteners by pushing and turning clockwise a ¼-turn.
9. Verify that the voltage for the power source matches the voltage on the nameplate on the front of the treadmill hood, then plug in the power cord.
10. Be sure the circuit breaker switch on the treadmill hood is set to ON. The circuit breaker on the rear of the treadmill controls the power to the treadmill. The circuit breaker must be set to ON for the treadmill to run. Turn off the treadmill circuit breaker before connecting or disconnecting the treadmill to the wall outlet.

# INSTALLATION INSTRUCTIONS

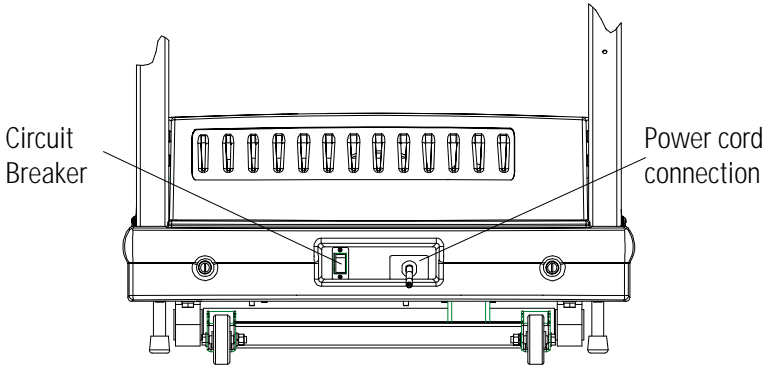

Power Cord Connection (USA)

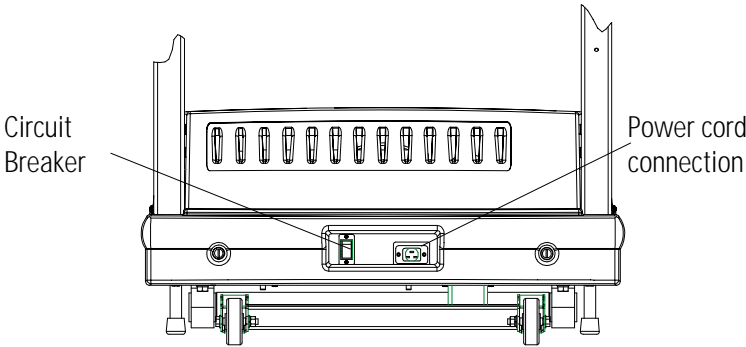

Power Cord Connection (International)



## WARNING

THE POWER KEY ON THE CLUBTRACK 510/612 PLUS CONTROLLERS DO NOT TURN OFF THE ELECTRICAL CURRENT TO THE TREADMILL. THE TREADMILL CONTINUES TO DRAW POWER, EVEN WHEN THE CONTROLLER IS OFF.

TO AVOID ELECTRIC SHOCK, DO NOT REMOVE THE TREADMILL HOOD OR PLACE YOUR HANDS BENEATH THE TREADMILL WHILE THE TREADMILL IS PLUGGED INTO A POWER SOURCE.

11. Test all operational functions, including speed, grade, timer, parameters, and all limit controls.



# INSTALLATION INSTRUCTIONS

## Testing the Treadmill and Controller

1. Turn on power to the controller.
  - ClubTrack 510/612 - turn the circuit breaker switch to "ON." Within seconds, the blue LCD screen should light up and the "SELECT WORKOUT" message should flash in the center display.
  - ClubTrack 510/612 Plus - turn the circuit breaker to "ON" and press [Power]. After a second, the heart symbol should flash in the LCD screen.
2. Press [START BELT]. Verify that the treadmill accelerates gradually to minimum speed.
3. Press and hold [Grade: √] until the treadmill reaches zero grade.
4. Press [Grade: ^] and [Speed: +] until the treadmill is running at maximum speed and grade.
5. Let the treadmill run for 15 minutes.
6. Watch the walking belt carefully to ensure that it does not drift left or right. Listen for unusual noises, such as squeals or squeaks.
7. Return the grade to 0 and slow the belt down. Walk on the moving belt and verify proper operation at representative speeds and grades. If the walk belt slips, but the front roller turns, adjust the walk belt tension (see Troubleshooting).
8. Check menu displays and functionality.
9. When the test is finished:
  - a. Press [Grade: √] until the treadmill is at zero grade.
  - b. Press [STOP BELT].
  - c. Press [POWER], or turn off the circuit breaker to turn off the controller.



## INSTALLATION INSTRUCTIONS

If the treadmill does not run smoothly, contact your StairMaster service representative before using it.

### Accessories and Options

An operator manual (P/N 00501-841) is shipped with each treadmill. The following options are available:

Part No.	Description
36147-001	Left Handrail Kit
36147-002	Right Handrail Kit
36147-003	Left and Right Handrails
34198-003	Transmitter Belt with strap (HRM)
00501-831	Service Manual (English language only)

- To avoid potential safety and electrical problems, use parts and accessories that meet StairMaster specifications.

### How to Reach Us

For Technical Assistance/ Parts:

In the United States: 800/331-3578

Outside the U.S.A.: 425/823-1825

See addresses and phone numbers listed at the end of this manual.



# **GUIDELINES FOR GETTING ON AND OFF THE TREADMILL**

## **Guidelines For Getting on and off the Treadmill**

Instruct each user in the following guidelines for getting on and off the treadmill.

- The walking belt should be moving at minimum speed before the user steps onto the treadmill.
1. Stand next to the treadmill and place both hands on the front handrail.
  2. Straddle the walking belt or step onto the side of the deck. Step onto the moving belt and begin walking.
  3. (Optional) To get the feel of the moving belt, place the foot nearest the treadmill on the walking belt and let it move backwards. Lift it and repeat several times until comfortable with the treadmill speed.
  4. When walking comfortably on the treadmill, let go of the handrail.
  5. While walking on the treadmill:
    - Face forward. Avoid looking down at the walk belt.
    - Maintain speed by keeping a consistent distance from the handrail.
    - Adjust the speed and grade as required. Hold the handrail as the speed and grade change.
  6. Before stepping off the treadmill, place one hand on the handrail, wait for the belt to stop, then step off.

# LIMITED-ACCESS CONTROL

## LIMITED-ACCESS CONTROL

Limited-access control lets you restrict treadmill use to authorized personnel. It also lets you stop the treadmill in an emergency. The magnetically-activated control is located under the StairMaster trademark "S" logo on the controller. The limited-access control is deactivated on machines shipped from the factory.

### Activation

To activate the limited-access control and restrict access, place the back of the magnetic key supplied with the treadmill precisely over the StairMaster trademark "S" logo on the front panel of the controller.

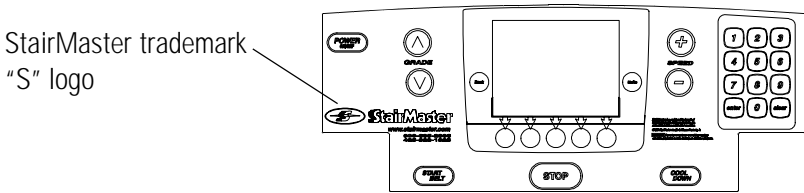

The magnet will activate the control. If you remove the key, the treadmill belt will stop and the controller will not respond to any key presses. Accumulated values will remain on display until you turn off the power, or press [CLEAR].

The 510/612 treadmill controllers will display "MAGNETIC KEY STOP / REPLACE MAGNET" when you remove the key from the StairMaster logo. You must replace the key or deactivate the control to start the walk belt.

The 510/612 Plus treadmill controllers will display "MAGNETIC KEY STOP! PLACE MAGNETIC KEY OVER STAIRMASTER LOGO!" when you remove the key. You must replace the key or deactivate the control to start the walk belt.

### Deactivation

To deactivate the limit control and permit unlimited access on the 510/612 treadmill:

## LIMITED-ACCESS CONTROL

1. Remove the magnet key and press [Speed: +], [3], [8], [ENTER].
2. Press [Speed: +] or [Speed: -] to toggle between "ON" and "OFF." Press [ENTER] to select "OFF."
3. The LCD display will show "CUSTOMIZE." Press [ENTER]. The LCD display will flash the machine configuration and then return to the "SELECT WORKOUT" screen.
4. The limited access control remains inactive, granting unrestricted access, until you turn the magnetic key option back on, or place the magnet over the StairMaster logo.

To deactivate the limit control and permit unlimited access on the 510/612 Plus Treadmill:

1. Remove the magnetic key and press the [POWER] key off.
2. Press and hold the key shown below, then press [POWER].

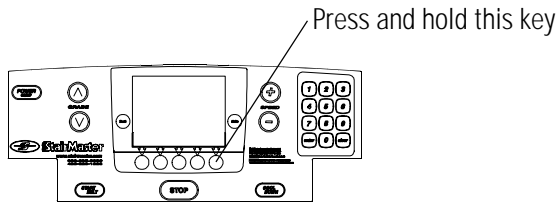

3. Release all keys. The limited access control remains inactive, granting unrestricted access, until you turn the magnetic key option back on, or place the magnet over the StairMaster logo.

### Magnetic Key as Emergency Stop

The magnetic key has a string with a clip that you can attach to the user's wrist or belt during exercise. If the user moves too far from the controller, the cord will pull the key off the controller and stop the walk belt.

# HEART RATE MONITORING

## Heart Rate Monitoring

Heart rate monitoring helps users monitor their levels of exertion by displaying the heart rate during exercise. There are two methods of monitoring heart rate on all treadmills:

- Telemetry (e.g., Polar®) belt. A Polar-compatible heart rate chest belt transmits the heart beat signal to the receiver in the controller. The controller displays the heart rate in beats per minute and uses the heart rate value in heart rate control mode.
- Contact heart rate (handgrip). Sensors on the handgrip detect heart rate and display it on the controller.

### Telemetry Heart Rate

The telemetry heart rate monitoring system consists of the receiver, located in the controller, and a transmitter belt (purchased separately) worn across your chest. The monitoring function is activated as soon as you strap on the chest belt and step within range of the receiver in the machine. Two electrodes on the underside of the chest belt sense the heart rate signal and send it to the receiver. The heart symbol on the controller pulses to indicate that the controller is receiving a valid signal. A microprocessor in the controller calculates the heart rate and displays it, in beats per minute, on the controller.

### Using the Transmitter Belt



#### **WARNING**

PACEMAKER USERS SHOULD NOT USE THE POLAR TRANSMITTER BEFORE CONSULTING THEIR DOCTOR.



## HEART RATE MONITORING

Before you put the transmitter belt on, wet the two electrode patches (the grooved rectangles on the reverse side of the belt). Secure the transmitter belt as high under the pectoral muscles (chest) as is comfortable (at the level of the xyphoid process). The transmitter belt should fit snugly and comfortably, and allow normal breathing. When the controller detects a heart rate signal, heart rate is shown in the display automatically. Your heart rate in beats per minute and a pulsing heart icon are displayed on the controller.

After the initial belt signal is detected, the controller will enter a validation phase in which four good heart beat signals lasting four seconds are required before locking on telemetry heart rate signals for the duration of the workout session. During the validation phase the controller will not recognize contact heart rate signals. If you do not see a heart rate on the controller, try one of the following:

- Move closer to the controller.
- Tighten the elastic part of the chest belt.
- Adjust the belt higher or lower on your chest.
- Remoisten the electrodes.
- Test your chest strap with a machine that you know is working, or with a heart rate watch that you know is working.
- ClubTrack 510/612 only: check the heart rate input setup (see pg. 45)

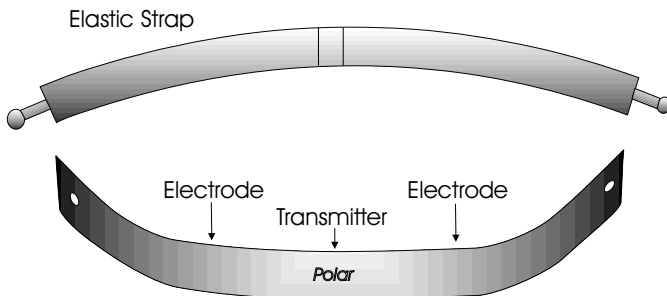

**Transmitter Belt**

# HEART RATE MONITORING

PROBLEM	POSSIBLE CAUSE	REMEDY
Heart rate reading is erratic or absent	Poor electrode contact.	<ol style="list-style-type: none"> <li>1. Be sure logo on belt is facing out and that electrodes are flat against the skin.</li> <li>2. Moisten the electrodes again.</li> <li>3. Be sure the receiver is within range (32 in./81 cm).</li> <li>4. Wash belt.</li> </ol>
Heart rate is erratic or above 200	<ol style="list-style-type: none"> <li>1. Treadmills are too close together and are receiving signals from two users.</li> <li>2. Interference from other electromagnetic signals (T.V., computers, other belt transmitters, motors, etc.).</li> </ol>	<ol style="list-style-type: none"> <li>1. Move treadmills at least 18 in. (46 cm) apart.</li> <li>2. Move the treadmill away from the source of interference.</li> </ol>
No signal on controller	<ol style="list-style-type: none"> <li>1. No electrode contact.</li> <li>2. Faulty chest belt.</li> <li>3. Transmitter battery worn out.</li> <li>4. Faulty controller.</li> </ol>	<ol style="list-style-type: none"> <li>1. Reposition chest belt, re-wet electrodes.</li> <li>2. Test signal using different belt transmitter. Replace old belt if faulty.</li> <li>3. Replace transmitter.</li> <li>4. Test belt transmitter with a different treadmill. If the belt transmitter is working correctly, replace controller.</li> </ol>

## Maintaining the Transmitter Belt

Clean the chest belt regularly with mild soap and water, then dry thoroughly – residual sweat and moisture keep the transmitter active and drain the battery in the transmitter. Do not use abrasives or chemicals such as steel wool or alcohol for cleaning, as they can damage the electrodes permanently. You can order replacement belts from StairMaster, Polar Electro, Inc., or your local fitness store:

StairMaster      800-331-3578      P/N 34198-003  
Polar Electro, Inc. 800-227-1314

### Contact Heart Rate

The StairMaster® Treadmill exercise system features a digitized contact heart rate monitoring system. Through the use of stainless steel sensors built into the handlebar, and sophisticated software, heart rate can be checked at any time during a workout. The heart rate is displayed on the controller.

The contact heart rate system's ability to detect a heart rate signal is influenced by several factors. Movement of the muscles of the upper body produces an electrical signal (muscle artifact) that will interfere with the detection of the heart rate signal by the sensors. Movement of the hands while they are in contact with the sensors also produces interference. Calluses and hand lotion act as an insulating layer to reduce the signal strength. Also, the EKG signal generated by some individuals is not strong enough to be detected by the sensors. These individuals should opt for the telemetry method of heart rate monitoring.

### Using Contact Heart Rate

Contact heart rate input signals are acquired only during contact between your hands and the stainless steel sensors on the handrails. To use the contact heart rate feature, place your hands around the handles so that your hands touch both the top and the bottom of the sensors. After the initial contact heart rate signal is detected, the controller will enter a validation phase requiring a good heart beat signal within 10 to 15 seconds, or until the system acquires a valid signal. During the validation phase the controller will not recognize telemetry heart rate signals. The controller will display a heart icon. If, during exercise, the heart rate displayed is erratic, it may be helpful to remove your hands from the handles, wipe them and place them back on the handles. In all programs, the heart rate is shown automatically in the display window the first time the sensors are touched.

# EXERCISE INTENSITY, FREQUENCY, & DURATION

## Exercising

No single fitness program is suitable for all. All fitness programs should be designed by fitness professionals who are trained to tailor the program to the individual goals and fitness levels of each client. The following information on exercise intensity, duration, and frequency is based on averages and is included here only as a guideline for use by fitness professionals. Programs should be altered for comfort and safety when necessary.



### WARNING

DO NOT BEGIN AN EXERCISE PROGRAM  
WITHOUT CONSULTING A PHYSICIAN.

## Intensity

Exercise intensity depends upon the capacity of the individual to do the specific type of exercise. The exercise should exceed mild demand, but should not produce fatigue, breathlessness, or mental confusion. Choose a target zone according to personal fitness goals.

- A typical conditioning intensity for a healthy adult is from 50 to 80 percent of functional capacity, which is equivalent to 55 to 85 percent of maximal heart rate. For clients wanting to reduce body fat, who have been sedentary, who are in poor physical condition, or who are just starting an exercise program, an exercise intensity at 50 to 65 percent of functional capacity or 55 to 70 percent of maximal heart rate is recommended. For healthy, active clients wanting to improve their cardiovascular condition, and intensity from 65 to 80 percent of functional capacity or 70 to 85 percent maximal heart rate is recommended. Begin exercise at low intensity, especially for sedentary persons. As fitness improves, vary the exercise within the target zone. <sup>1</sup>

## EXERCISE INTENSITY, FREQUENCY, & DURATION

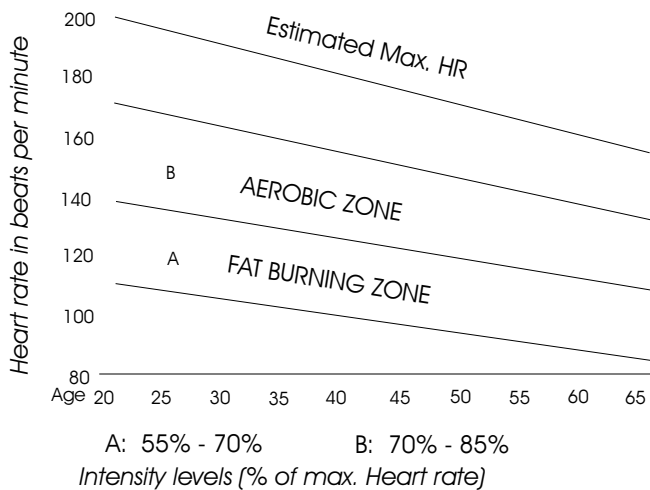

### Intensity Levels (% of max. heart rate)

### Frequency and Duration

Fitness experts recommend that exercise be done at least three times a week and should last between 15 and 60 minutes. Spread workouts throughout the week to let the body recover properly. Begin each workout slowly and let the body warm up for at least five minutes below the target zone. Gradually increase the intensity until the client is in the target zone. Maintain the target zone for 15 to 20 minutes (15 to 60 minutes as fitness increase). Gradually reduce the intensity to let the heart rate fall below the target zone with a five minute cool-down period (see graph on next page).<sup>1</sup>

<sup>1</sup>. The American College of Sports Medicine, Guidelines for Exercise Testing and Prescription, 4th Edition, Lea & Febiger, Philadelphia, PA, 1991, pp. 93-120.



# EXERCISE INTENSITY, FREQUENCY, & DURATION

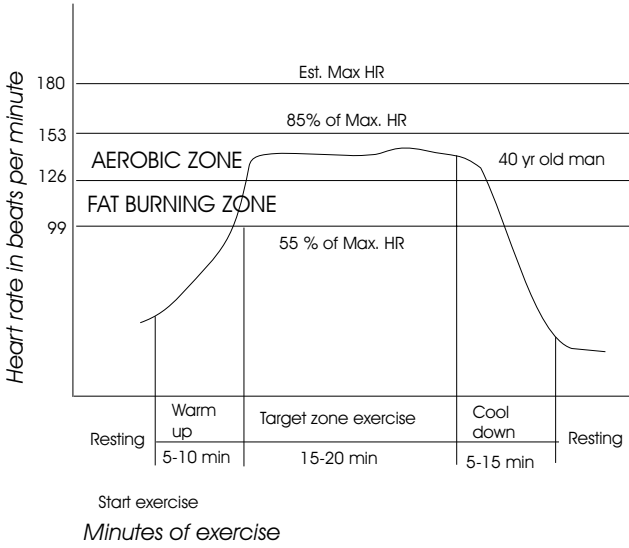

# OPERATING THE CLUBTRACK 510/612 TREADMILL

Follow the safety guidelines for using the treadmill given in the Introduction. If using the telemetry heart rate monitor, strap on the Polar® transmitter as described.

## TURNING ON THE POWER

Turn on the circuit breaker switch on the bottom front panel of the treadmill to power on the treadmill controller. If the limited-access control is on, place the magnetic key over the StairMaster trademark “S” logo on the controller. Attach the cord of the key to the user’s wrist or belt if desired. The screen displays “SELECT WORKOUT” after the system runs a self-test.

## UNDERSTANDING THE CONTROLLER

The treadmill controller, which is mounted above the front handrail, is a computerized panel used to operate the treadmill. All commands are entered by pressing a soft-touch key on the panel. Visual indicators and displays show the operational status and exercise results. The controller is divided into the following sections: the display window, the workout options, the entertainment keypad, the Grade keys, the Start Belt key, the Cool Down key, the Stop key, the workout statistic (Stats) keys, the Speed keys, and the numeric keypad.

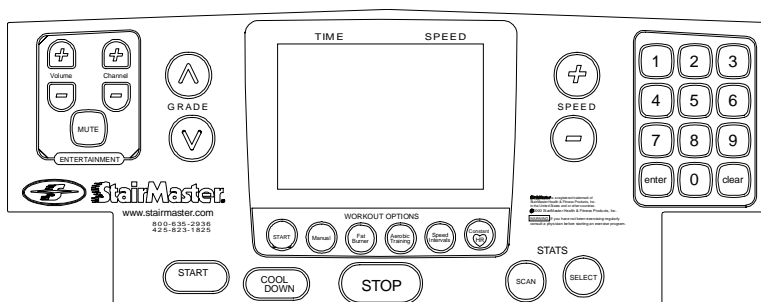

ClubTrack 510/612 Control Panel

# OPERATING THE CLUBTRACK 510/612 TREADMILL

## CONTROLLER KEYS

The following describes the controller keys and their function on the ClubTrack 510 and ClubTrack 612 treadmills:

### Display Window

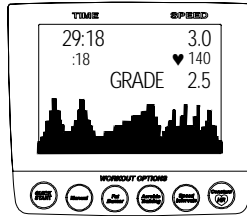

**Time** - The selected workout time is displayed in the upper left section of the display window. The timer will count down, in minutes and seconds, until the workout is finished or stopped. If [0] is entered in [MANUAL] or [CONSTANT HEART RATE] the timer will count up. The timer will also count up if [START BELT] is pressed. If [QUICK START] is pressed, the timer will count down from 20 minutes.

**Speed** - The treadmill speed is displayed in miles per hour (or kilometers per hour). The ClubTrack 510 has a speed range of 1.0 to 10.0 mph, and the ClubTrack 612 has a speed range of 1.0 to 12.0 mph.

**Interval Timer** - The interval timer is displayed below the Time. The interval timer counts down remaining time within each interval.

**Heart Rate** - Current heart rate is displayed next to the heart icon.

**Text Line** - Message prompts and statistics are displayed in the text line that is located below the interval timer and the heart rate.

**Workout Option Profile** - A profile of the selected exercise program appears in the lower section of the display window during a workout. The taller the column, the higher the intensity (METs) for that interval. The flashing column shows your current interval. The flashing column moves from left to right across the display as you complete each interval.



# OPERATING THE CLUBTRACK 510/612 TREADMILL

## Numeric keypad

The numeric keypad is located on the right side of the controller. Before the exercise program begins, the numbers are used to enter data in response to the controller prompts. After the workout starts, the numbers are used to enter the desired speed or target heart rate.

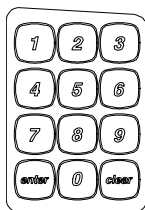

- **Enter** - Confirms workout selections and stores the information used by the controller to calculate workout statistics.
- **Clear** - During data entry, erases information from the controller memory if pressed before [ENTER].

## Entertainment Keypad

The entertainment keypad is used to facilitate the use of commercial entertainment systems. Using any of these keys will send an output signal through the Communication Specification for Fitness Equipment (C.S.A.F.E.) port to a connected C.S.A.F.E. or compatible system. *If a system is not connected, pressing these keys will have no effect.*

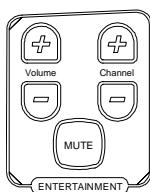

- **Volume Up/Down** - Increases or decreases the volume level of the audio source.
- **Mute** - Removes the audio sound from the headphones.
- **Channel Up/Down** - Changes the channel of the commercial entertainment system.

## Grade Keys



The treadmill grade may be changed at any time during a workout. Pressing the [Grade: ^] key increases the grade and pressing the [Grade: v] key decreases the grade. After the first press during the initial screen, or during a workout, the text

# OPERATING THE CLUBTRACK 510/612 TREADMILL

line will show the target grade. Further presses will increase or decrease the deck angle by one increment, or 0.5%, depending on the workout option selected.

## Speed Keys



The treadmill belt speed may be changed at any time during a workout. Pressing the [Speed: -] key decreases the belt speed and pressing the [Speed: +] key increases the belt speed. The belt speed increases or decrease by 0.1 MPH (0.15 KM/H).

## Start Belt Key

The start belt key starts the walk belt with a gradual increase to the default start speed. Fat Burner, Aerobic Training, or Constant Heart Rate: 3.0 mph, Manual: 1.0 mph



- You can also use this key for an immediate start to a quick-start workout session. The timer will count up from 0:00 to 99:59, then repeat from 0.

## Cool Down Key



The cool down key will cause the exercise program to end. The deck grade returns to 0% and the speed decreases to 1.0 MPH if prior speed is less than 2.0 MPH. If the prior speed was greater than 2.0 MPH the speed decreases to 2.0 MPH. You can adjust the grade and speed at any time during the cool down.

## Stop Key



Press the [STOP] key any time you want to pause the exercise program for up to one minute. If the [STOP] key is pressed a second time (or the [1] key), the workout statistics will be displayed, then the controller will return to the "SELECT WORKOUT" prompt.

# OPERATING THE CLUBTRACK 510/612 TREADMILL

## Workout Statistics



During the exercise program, the Stats keys are used to track workout statistics which are shown in the display window. Press the [SELECT] key turns off the scanning feature and shows the current statistic in the display window. Use the [SELECT] key to scroll through the different statistics. Press the [SCAN] key to prompt the controller to cycle through the following statistics:

- **Grade** - Provides the percent grade of the treadmill during a workout session. The grade is calculated by the rise divided by the run:

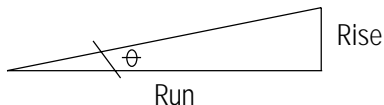

$$\text{Grade} = \frac{\text{Rise}}{\text{Run}}$$

$$\tan \theta = \frac{\text{Rise}}{\text{Run}}$$

$$\text{Grade} = \tan \theta$$

$$\theta = \arctan(\text{Grade})$$

For example, for a 12% grade, every 12 feet of horizontal travel = 1 foot of vertical distance climbed.

- **Distance** - Provides a cumulative total of the equivalent distance, in miles (or kilometers if your controller is set to metric units), you have traveled.
- **Calories** - Provides a current total of the number of Calories burned during a workout.
- **Calories/Hour** - Provides the rate at which calories are burned per hour at the current speed and grade.
- **Pace** - Displays the walking/running pace in minutes per mile (or minutes per kilometer).

## OPERATING THE CLUBTRACK 510/612 TREADMILL

- **Watts** - During a workout, this statistic displays the power output at the current speed and grade, displayed in watts (746 watts = 1 hp). Average power is shown during the workout summary.
- **METs** - Gives you the relative energy cost of exercise. MET stands for multiples of the resting metabolic rate. While you are sitting quietly, your body consumes oxygen at the rate of about 3.5 milliliters per kilogram of body mass per minute. When you exercise, your body needs more oxygen in order to function. For example, exercising at 10 METs requires ten times the resting rate of oxygen consumption, or about 35 milliliters per kilogram per minute. During a workout, this key shows the current MET level. During the workout summary, the average MET level is displayed.
- **Vertical feet (meters) Climbed** - Provides the number of vertical feet (meters) climbed.
- **Target Heart Rate** - Available only during the Constant Heart Rate program. Shows the selected target heart rate.

## EXERCISE PROGRAM KEYPAD

The exercise keypad is located below the display and to the left of the function keypad. While the controller is in the "SELECT WORKOUT" mode, press one of the exercise program keys to preview the desired workout. There are six workout programs with standard default values. Pressing [ENTER] without data first will set up the controller with the following default data:

- **Weight** - 175 lbs.
- **Speed** - Fat Burner, Aerobic Training, or Constant Heart Rate: 3.0 mph, Manual: 1.0 mph
- **Intensity Level** (Fat Burner, Aerobic Training, and Speed Intervals program only) - 1
- **Age** (Constant Heart Rate program only) - 40 years
- **Workout Time** - The default time in the programmed workouts and Quick Start is 20 minutes. The Manual and Constant Heart Rate programs do not have a specified default time. In

# OPERATING THE CLUBTRACK 510/612 TREADMILL

these programs, the controller timer will count up to the maximum time of 99 minutes, return to 0, and count up again.

Once you have selected a program, follow the controller prompts.

- **"ENTER BODY WEIGHT"** -- type in your body weight in pounds (or kilograms if your controller is set to metric units).
- **"ENTER SPEED"** - select your desired speed. The ClubTrack 510 treadmills have a speed range of 1.0 to 10.0 mph, in 0.1 mph increments. The ClubTrack 612 treadmills have a speed range of 1.0 to 12.0 mph, in 0.1 mph increments.
- **"ENTER LEVEL 1 - 20"** (Fat Burner, Aerobic Training, and Speed Intervals only)-- select your intensity level with level 1 being the easiest and level 20 the hardest.
- **"ENTER TIME 5 - 99"** -- select the workout duration in one minute increments from five to 99. Press [0] during the [MANUAL] and [CONSTANT HEART RATE] programs for an unspecified duration, and the controller timer will count up from 0.

## The Quick Start Program

Provides an immediate start, without having to enter any user information. This program uses the standard default settings to calculate calories burned during a workout session.

To use the Quick Start program:

1. Press the [QUICK START] key. A screen similar to the following will be displayed:

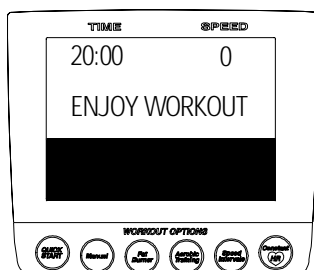

## OPERATING THE CLUBTRACK 510/612 TREADMILL

2. Begin the workout.
  - The speed may be changed at any time during the workout by pressing the [Speed: +] key to increase the speed, or the [Speed: -] key to decrease the speed. Or, use the numeric keypad to enter the desired speed.
  - The grade may be changed at any time during the workout by pressing the [Grade: ^] key to increase the grade, or by pressing the [Grade: v] key to decrease the grade.
3. Press [COOL DOWN] to return the grade to 0%, and the speed to 1.0 mph if the workout speed was less than 2.0 mph. If the prior speed was greater than 2.0 mph, the speed decreases to 2.0 mph.
  - The speed may be changed at any time during the cool down by pressing the [Speed: +] key to increase the speed, or the [Speed: -] key to decrease the speed. Or, use the numeric keypad to enter the desired speed.
  - The grade may be changed at any time during the workout by pressing the [Grade: ^] key to increase the grade, or by pressing the [Grade: v] key to decrease the grade.
4. Press [STOP] to end the workout. The workout statistics will be displayed, and then the controller will revert back to the "SELECT WORKOUT" mode.

### The Manual Program

The default speed is 1.0 mph unless changed during the data entry mode. The default grade is 0%. The profile in the display window is divided into 15 equal intervals within the selected workout time. The profile is based on the MET level, with every 2 METs equating to one

## OPERATING THE CLUBTRACK 510/612 TREADMILL

vertical bar. MET level is based on a combination of grade and speed.

To use the Manual program:

1. Press the [MANUAL] key. A screen similar to following will be displayed:

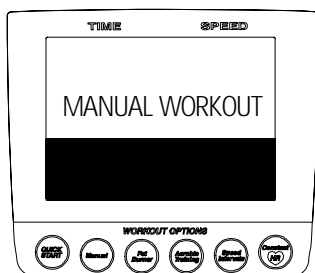

2. The controller will display "ENTER WEIGHT - LBS" (or "ENTER WEIGHT - KG" if in Metric mode). Enter your weight using the numeric key keypad and press [ENTER].  
Or  
Press [ENTER] to accept the default value.
  - Your weight is used to calculate the number of calories burned for each minute of exercise and the total number of calories burned for the exercise session.
3. The controller will display "SPEED MPH" (or "SPEED KM/H if in Metric mode). Enter the desired speed using the numeric keypad and press [ENTER].  
Or  
Press [ENTER] to accept the default value.
4. The controller will display "ENTER TIME 5-99." Enter the desired time and press [ENTER].  
Or  
Press [ENTER] to start the timer counting up from 0.
5. The controller will display "PRESS START BELT." Press [START BELT] to begin your workout.

## OPERATING THE CLUBTRACK 510/612 TREADMILL

- The speed may be changed at any time during the workout by pressing the [Speed: +] key to increase the speed, or the [Speed: -] key to decrease the speed. Or, use the numeric keypad to enter the desired speed.
  - The grade may be changed at any time during the workout by pressing the [Grade: ^] key to increase the grade, or by pressing the [Grade: v] key to decrease the grade.
6. Press [COOL DOWN] to return the grade to 0%, and the speed to 1.0 mph if the workout speed was less than 2.0 mph. If the prior speed was greater than 2.0 mph, the speed decreases to 2.0 mph.
- The speed may be changed at any time during the cool down by pressing the [Speed: +] key to increase the speed, or the [Speed: -] key to decrease the speed. Or, use the numeric keypad to enter the desired speed.
  - The grade may be changed at any time during the workout by pressing the [Grade: ^] key to increase the grade, or by pressing the [Grade: v] key to decrease the grade.
7. Press [STOP] to end the workout. The workout statistics will be displayed, and then the controller will revert back to the "SELECT WORKOUT" mode.

### The Fat Burner Program

The Fat Burner program is a 60 interval workout designed for people just starting a weight control program. The intensity of the intervals is alternated to tax the body's system and burn fat. The profile shown in the LCD display is divided into 15 equal intervals within the selected workout time. The *relative* intensity level is indicated on the profile. Any changes to the intensity level will not change the look of the remaining



## OPERATING THE CLUBTRACK 510/612 TREADMILL

profile; however, the new intensity level will continue through the remaining profile.

- The default speed is 3.0 mph unless changed during the data entry mode and the grade adjusts to the selected intensity level. The “intensity level” directly corresponds to the grade level. The maximum intensity level is 20.

To use the Fat Burner program:

1. Press the [FAT BURNER] key. A screen similar to following will be displayed:

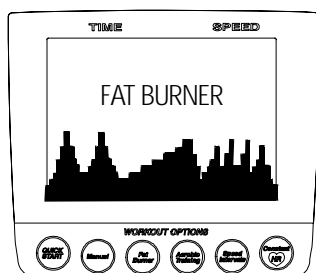

2. The controller will display “ENTER WEIGHT - LBS” (or “ENTER WEIGHT - KG” if in Metric mode). Enter your weight using the numeric key keypad and press [ENTER].

Or

Press [ENTER] to accept the default value.

- Your weight is used to calculate the number of calories burned for each minute of exercise and the total number of calories burned for the exercise session.

3. The controller will display “SPEED MPH” (or “SPEED KM/H if in Metric mode). Enter the desired speed using the numeric keypad and press [ENTER].

Or

Press [ENTER] to accept the default value of 3 mph.

## OPERATING THE CLUBTRACK 510/612 TREADMILL

4. The controller will display "ENTER LEVEL 1-20." Enter the desired intensity level using the numeric keypad and press [ENTER].  
Or  
Press [ENTER] to accept the default value of 1.
5. The controller will display "ENTER TIME 5-99." Enter the desired time and press [ENTER].  
Or  
Press [ENTER] to accept the default value of 20 minutes.
6. The controller will display "PRESS START BELT." Press [START BELT] to begin your workout.
  - The speed may be changed at any time during the workout by pressing the [Speed: +] key to increase the speed, or the [Speed: -] key to decrease the speed. Or, use the numeric keypad to enter the desired speed.
  - The grade may be changed at any time during the workout by pressing the [Grade: ^] key to increase the grade, or by pressing the [Grade: v] key to decrease the grade.
7. Press [COOL DOWN] to return the grade to 0%, and the speed to 1.0 mph if the workout speed was less than 2.0 mph. If the prior speed was greater than 2.0 mph, the speed decreases to 2.0 mph.
  - The speed may be changed at any time during the cool down by pressing the [Speed: +] key to increase the speed, or the [Speed: -] key to decrease the speed. Or, use the numeric keypad to enter the desired speed.
  - The grade may be changed at any time during the workout by pressing the [Grade: ^] key to increase the grade, or by pressing the [Grade: v] key to decrease the grade.

## OPERATING THE CLUBTRACK 510/612 TREADMILL

8. Press [STOP] to end the workout. The workout statistics will be displayed, and then the controller will revert back to the "SELECT WORKOUT" mode.

### The Aerobic Training Program

The Aerobic Training program is a 60 interval workout designed for people wanting to increase their aerobic capacity. The changes of the intensity in the intervals is greater than the intervals in the Fat Burner program, and designed specifically to tax the cardiorespiratory system. The profile shown in the LCD display is divided into 15 equal intervals within the selected workout time. The *relative* intensity level is indicated on the profile. Any changes to the intensity level will not change the look of the remaining profile; however, the new intensity level will continue through the remaining profile.

- The default speed is 3.0 mph unless changed during the data entry mode and the grade adjusts to the selected intensity level. The "intensity level" corresponds to a pre-programmed speed and grade setting. The maximum intensity level is 20.

To use the Aerobic Training program:

1. Press the [AEROBIC TRAINING] key. A screen similar to the following will be displayed:

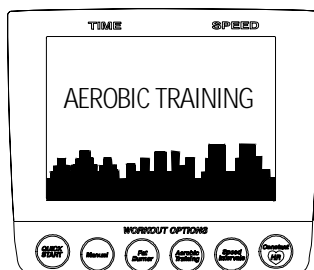

2. The controller will display "ENTER WEIGHT - LBS" (or "ENTER WEIGHT - KG" if in Metric mode). Enter your weight using the numeric key keypad and press [ENTER].  
Or  
Press [ENTER] to accept the default value.

## OPERATING THE CLUBTRACK 510/612 TREADMILL

- Your weight is used to calculate the number of calories burned for each minute of exercise and the total number of calories burned for the exercise session.
3. The controller will display "SPEED MPH" (or "SPEED KM/H if in Metric mode). Enter the desired speed using the numeric keypad and press [ENTER].  
Or  
Press [ENTER] to accept the default value of 3 mph.
  4. The controller will display "ENTER LEVEL 1-20." Enter the desired intensity level using the numeric keypad and press [ENTER].  
Or  
Press [ENTER] to accept the default value of 1.
  5. The controller will display "ENTER TIME 5-99." Enter the desired time and press [ENTER].  
Or  
Press [ENTER] to accept the default value of 20 minutes.
  6. The controller will display "PRESS START BELT." Press [START BELT] to begin your workout.
    - The speed may be changed at any time during the workout by pressing the [Speed: +] key to increase the speed, or the [Speed: -] key to decrease the speed. Or, use the numeric keypad to enter the desired speed.
    - The grade may be changed at any time during the workout by pressing the [Grade: ^] key to increase the grade, or by pressing the [Grade: v] key to decrease the grade.
  7. Press [COOL DOWN] to return the grade to 0%, and the speed to 1.0 mph if the workout speed was less than 2.0 mph. If the

## OPERATING THE CLUBTRACK 510/612 TREADMILL

prior speed was greater than 2.0 mph, the speed decreases to 2.0 mph.

- The speed may be changed at any time during the cool down by pressing the [Speed: +] key to increase the speed, or the [Speed: -] key to decrease the speed. Or, use the numeric keypad to enter the desired speed.
  - The grade may be changed at any time during the workout by pressing the [Grade: ^] key to increase the grade, or by pressing the [Grade: v] key to decrease the grade.
8. Press [STOP] to end the workout. The workout statistics will be displayed, and then the controller will revert back to the "SELECT WORKOUT" mode.

### The Speed Intervals Program

The Speed Intervals program is an interval workout. An interval cycle consists of an exercise phase and a recovery phase. An interval workout consists of a series of interval cycles. The Speed Intervals program consists of 7 interval cycles. You may scale the recovery phase speed and the exercise phase speed independently - which is saved for remainder of workout. For example, if you decrease the speed during a recovery phase then subsequent recovery phases will be the same speed. However, the exercise phase remains unchanged, at the same speed that you started with. To change the speed of the exercise phase, you must change the speed during an exercise phase. The two phases are independent of each other in regard to speed levels. The *relative* intensity level is indicated on the profile and any changes to the intensity level will not change the look of the remaining profile.

- The exercise and recovery phase speed is set by the selected intensity level. The grade is initially set at 0%, and must be changed manually by the user as desired. Recovery and exercise speeds are listed in the table on pg. 36:

# OPERATING THE CLUBTRACK 510/612 TREADMILL

Level	Recovery Speed	Exercise Speed	Level	Recovery Speed	Exercise Speed
1	2.0	3.5	11	3.3	6.9
2	2.1	3.8	12	3.4	7.3
3	2.3	4.2	13	3.6	7.6
4	2.4	4.5	14	3.7	7.9
5	2.5	4.9	15	3.8	8.3
6	2.7	5.2	16	4.0	8.6
7	2.8	5.6	17	4.1	9.0
8	2.9	5.9	18	4.2	9.3
9	3.1	6.2	19	4.4	9.7
10	3.2	6.6	20	4.5	10.0

To use the Speed Intervals program:

1. Press the [SPEED INTERVALS] key. A screen similar to the following will be displayed:

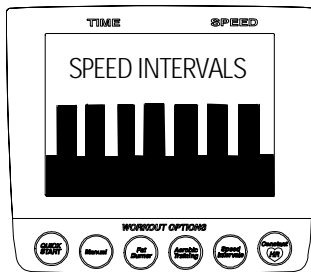

2. The controller will display "ENTER WEIGHT - LBS" (or "ENTER WEIGHT - KG" if in Metric mode). Enter your weight using the numeric key keypad and press [ENTER].  
Or  
Press [ENTER] to accept the default value of 175 lbs.

## OPERATING THE CLUBTRACK 510/612 TREADMILL

- Your weight is used to calculate the number of calories burned for each minute of exercise and the total number of calories burned for the exercise session.
3. The controller will display "ENTER LEVEL 1-20." Enter the desired intensity level using the numeric keypad and press [ENTER].  
Or  
Press [ENTER] to accept the default value of 1.
  4. The controller will display "ENTER TIME 5-99." Enter the desired time and press [ENTER].  
Or  
Press [ENTER] to accept the default value of 20 minutes.
  5. The controller will display "PRESS START BELT." Press [START BELT] to begin your workout.
    - The speed may be changed at any time during the workout by pressing the [Speed: +] key to increase the speed, or the [Speed: -] key to decrease the speed. Or, use the numeric keypad to enter the desired speed.
    - The grade may be changed at any time during the workout by pressing the [Grade: ^] key to increase the grade, or by pressing the [Grade: v] key to decrease the grade.
  6. Press [COOL DOWN] to return the grade to 0%, and the speed to 1.0 mph if the workout speed was less than 2.0 mph. If the prior speed was greater than 2.0 mph, the speed decreases to 2.0 mph.
    - The speed may be changed at any time during the cool down by pressing the [Speed: +] key to increase the speed, or the [Speed: -] key to decrease the

## OPERATING THE CLUBTRACK 510/612 TREADMILL

speed. Or, use the numeric keypad to enter the desired speed.

- The grade may be changed at any time during the workout by pressing the [Grade: ^] key to increase the grade, or by pressing the [Grade: v] key to decrease the grade.
7. Press [STOP] to end the workout. The workout statistics will be displayed, and then the controller will revert back to the "SELECT WORKOUT" mode.

### **The Constant Heart Rate Program (requires chest strap)**

The Constant Heart Rate program allows you to exercise at a selected target heart rate. Once a heart rate control method is selected (speed or grade), the controller adjusts the treadmill's speed or grade to maintain that target heart rate. You must use a transmitter belt (chest strap) to send a heart rate signal to the controller. This program does not work with contact heart rate.

- If the heart rate control "Grade" method is chosen, the controller will adjust the grade to maintain the selected target heart rate. If the target heart rate has not been met at the maximum grade, you can use the [Speed: +] key to increase the belt speed to reach the target heart rate.

If the actual heart rate exceeds the target heart rate, the controller will reduce the grade to slow your heart rate down. If the actual heart rate is still higher than the target heart rate once the minimum grade has been reached, the controller will then reduce the belt speed to slow your heart rate down.

- If the heart rate control "Speed" method is chosen, the controller will change the belt speed from the initial starting speed selected to maintain your target heart rate. Grade can be changed manually.



## OPERATING THE CLUBTRACK 510/612 TREADMILL

To use the Constant Heart Rate program:

1. Put the chest strap on. Remember to wet the electrodes underneath the chest strap. The controller must detect a heart rate signal to allow selection of the Constant Heart Rate program.
2. Press the [CONSTANT HEART RATE] key. A screen similar to following will be displayed:

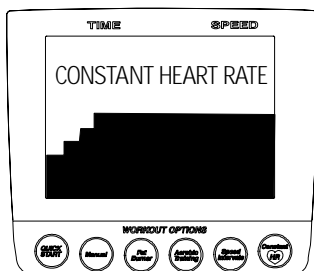

3. The controller will display "ENTER WEIGHT - LBS" (or "ENTER WEIGHT - KG" if in Metric mode). Enter your weight using the numeric key keypad and press [ENTER].  
Or  
Press [ENTER] to accept the default value of 175 lbs.
  - Your weight is used to calculate the number of calories burned for each minute of exercise and the total number of calories burned for the exercise session.
4. The controller will display "SPEED MPH" (or "SPEED KM/H" if in Metric mode). Enter the desired starting speed using the numeric keypad and press [ENTER].  
Or  
Press [ENTER] to accept the default value of 3.0 mph.
5. The controller will display "ENTER AGE 10 -99." Enter your age using the numeric keypad and press [ENTER].  
Or  
Press [ENTER] to accept the default value of 40 years old.

## OPERATING THE CLUBTRACK 510/612 TREADMILL

6. The controller will display "TARGET HR." To the right of the text message a suggested target heart rate, based on your age, is displayed. Press [ENTER] to accept the calculated target heart rate, or enter a different target heart rate using the numeric keypad and then press [ENTER].  
Or  
Press [ENTER] to accept the default value of 126 beats per minute.
  - The target heart rate selected by the controller is based on age, and is equal to 70% of your maximum heart rate which is calculated by the following equation:  $(220 - \text{Age}) \times .70$ . If desired, change the target heart rate at this point by using the numeric keypad to enter the new target heart rate, and then press [ENTER].
  - Change to a new target heart rate that is between 80 and 180 beats per minute at any time during a workout by using the numeric keypad to enter the new target heart rate, and then pressing [ENTER]. A change in target heart rate does not reset any speed or grade overrides made prior to the target change.
7. The controller will display "SELECT HR MODE / TYPE 1 - SPEED / TYPE 2 - GRADE." Select the type of heart rate control - either speed [1] or grade [2] - and press [ENTER].  
Or  
Press [ENTER] to accept the default heart rate control of speed.
8. The controller will display "ENTER TIME 5-99." Enter the desired time and press [ENTER].  
Or  
Press [ENTER] to accept the default value.
9. The controller will display "PRESS START BELT." Press [START BELT] to begin your workout.

The following messages may be displayed during a workout:

## OPERATING THE CLUBTRACK 510/612 TREADMILL

- **“CHECK BELT”** - Indicates that the heart rate signal has been missing for the last 30 seconds.
  - **“HR BELT NEEDED”** - No telemetry belt signal been sensed during the initial setup time.
10. Press [COOL DOWN] to return the grade to 0%, and the speed to 1.0 mph if the workout speed was less than 2.0 mph. If the prior speed was greater than 2.0 mph, the speed decreases to 2.0 mph.
- The speed may be changed at any time during the cool down by pressing the [Speed: +] key to increase the speed, or the [Speed: -] key to decrease the speed. Or, use the numeric keypad to enter the desired speed.
  - The grade may be changed at any time during the workout by pressing the [Grade: ^] key to increase the grade, or by pressing the [Grade: v] key to decrease the grade.
11. Press [STOP] to end the workout. The workout statistics will be displayed, and then the controller will revert back to the “SELECT WORKOUT” mode.

### The StairMaster Submaximal Fitness Test

The StairMaster fitness test is a program that estimates maximal aerobic capacity based on heart-rate response to sub-maximal exercise.

The StairMaster branching protocol is a series of 3-minute stages of continuous exercise at increasing intensity. The first stage is a warm-up at approximately 4 METs. The intensity of the remaining stages is based on the heart rate response to the warm-up. The test is designed to raise the steady state heart rate of the subject to at least 115 beats/minute. It is important to remember that two consecutive heart rate measurements must be obtained above 115 beats/minute to predict

## OPERATING THE CLUBTRACK 510/612 TREADMILL

$VO_{2max}$ . The test typically lasts from 6 to 15 minutes. The test will terminate if the heart rate does not continue to rise each minute.

In the StairMaster protocol, each work rate is performed for 3 minutes, with heart rates recorded during the final 4 seconds of the second and third minutes of each stage. If the heart rates are within 5 beats/min, then the heart rate during the last minute is plotted against the work rate, and the program advances to the next 3-minute stage. The program continues for two to four stages until two steady state heart rates above 115 beats/min are obtained in two consecutive stages. The line generated from the plotted points is then extended to the age-predicted maximal heart rate. A corresponding maximal work rate and  $VO_{2max}$  can then be calculated.

At the end of the 3<sup>rd</sup> minute of each stage, if the heart rates at the end of the 2<sup>nd</sup> and 3<sup>rd</sup> minute are not within 5 beats/min of each other, then that work rate is maintained for an additional minute. At the end of the 4<sup>th</sup> minute, the heart rate is compared to the heart rate at the end of the 3<sup>rd</sup> minute. If the heart rates are within 5 beats/min, then the heart rate during the 4<sup>th</sup> minute is plotted against the work rate. If the heart rate at the end of the 3<sup>rd</sup> and 4<sup>th</sup> minute are not within 5 beats/min, then the work rate is maintained for one more additional minute. If the heart rate at the end of the 4<sup>th</sup> and 5<sup>th</sup> minutes are within 5 beats/min, then the heart rate at the end of the 5<sup>th</sup> minute is plotted against the work rate. If the heart rate at the end of the 4<sup>th</sup> and 5<sup>th</sup> minutes are not within 5 beats/min, then the test failed.

Once two consecutive heart rate measurements are obtained above 115 beats/min range, then the test ends successfully and the results are displayed. Estimated maximum aerobic capacity is shown in ml/kg/min and METs. Next, the results are compared to normative values for others of the same age range and gender. Results are stored in the controller until the next person starts an exercise program. Press [Stats: SCAN] to review the results in addition to being displayed at the end of the test.

To use the Fitness Test program:

## OPERATING THE CLUBTRACK 510/612 TREADMILL

1. Put the chest strap on. Remember to wet the underneath of the chest strap, over the electrodes.
2. Press [Speed:+], [9], [0]. The controller will display "FIT TEST."
3. The controller will then display "ENTER WEIGHT - LBS" (or "ENTER WEIGHT - KG" if in Metric mode). Enter your weight using the numeric key keypad.
4. The controller will display "ENTER AGE 10 -99." Enter your age using the numeric keypad.
5. The controller will display "ENTER GENDER / 1 - MALE / 2 - FEMALE. Enter your gender code using the numeric keypad.
6. The controller will display "PRESS START BELT." Press the [START BELT] key to begin the test. Follow the onscreen prompts. The following messages may be displayed during a fitness test:
  - **"CHECK BELT"** - Indicates that the heart rate signal has been missing for the last 30 seconds.
  - **"HR BELT NEEDED"** - No telemetry belt signal been sensed during the initial setup time.
7. The test will be terminated early, and the messages "TEST TERMINATED / TRY AGAIN LATER" will be displayed if:
  - The user stops exercising at any point during the test.
  - The [STOP] key is pressed.
  - The heart rate response to each work level is the same or less than the previous work level.
  - The heart rate never reaches 115 beats/minute.
  - The heart rate continues to rise after the fifth minute.

## OPERATING THE CLUBTRACK 510/612 TREADMILL

8. The test is complete when two consecutive steady-state heart rates are obtained above 115 beats/minute. The test can be as short as 6 minutes, or as long as 15 minutes.
  - No cool down is done at the end of the test.
  
9. The estimated maximal aerobic capacity is displayed in METs, and  $VO_{2max}$ . The results are compared to normative values of the same age and gender<sup>1</sup> (see below), and given a fitness rating of "Low", "Fair", "Average", "Good", or "High."

### Fitness Rating Norms ( $VO_{2max}$ )

<u>MEN</u>					
Age	High	Good	Average	Fair	Low
20 – 29	>51	51 – 47	47 – 43	42 – 40	<39
30 – 39	>50	50 – 45	45 – 41	41 – 37	<37
40 – 49	>48	48 – 42	42 – 38	38 – 35	<35
50 – 59	>45	45 – 39	38 – 35	35 – 32	<32
60+	>43	42 – 35	35 – 32	32 – 29	<29
<u>WOMEN</u>					
Age	High	Good	Average	Fair	Low
20 – 29	>44	44 – 38	38 – 35	35 – 32	<32
30 – 39	>41	41 – 37	37 – 34	34 – 31	<30
40 – 49	>40	39 – 34	34 – 31	31 – 28	<28
50 – 59	>35	35 – 31	31 – 28	28 – 26	<25
60+	>35	35 – 39	29 – 26	26 – 24	<24

<sup>1</sup> The American College of Sports Medicine, Guidelines for Exercise Testing and Prescription, 6th Edition, Lippincott Williams & Wilkins, Philadelphia, PA, 2000, pp. 77.

# OPERATING THE CLUBTRACK 510/612 TREADMILL

## HEART RATE INPUT ON THE CLUBTRACK 510/612 TREADMILLS

Both contact heart rate and telemetry (e.g., Polar®) heart rate signal detection is available. The default priority of heart rate input is "LOCKED INPUT." If a telemetry signal is detected first, contact heart rate signals are inhibited from being detected throughout the rest of the workout session and vice-versa. There is also a short "lock out" period at the beginning of each workout session during which the controller first detects a signal and then validates the signal type. The duration of this shorter, initial "lock out" period differs between telemetry and contact heart rate.

- Telemetry heart rate - after the initial belt signal is detected, the controller will enter a validation phase in which four good heart beat signals within four seconds are required before locking on telemetry heart rate signals for the duration of the workout session. During the validation phase the controller will not recognize contact heart rate signals.
- Contact heart rate - after the initial contact sensor signal is detected, the controller will enter a validation phase requiring a good heart beat signal within 10 to 15 seconds, or until the system acquires a valid signal. During the validation phase the controller will not recognize telemetry heart rate signals. The Contact heart rate feature is not available during the Constant Heart Rate and Fitness Test programs.

### Locked/Non-Locked Heart Rate Signal Options

When the "EITHER INPUT" option is selected the heart rate source signal is not fixed during the workout session (if the signal is lost either input will be valid) . If the "LOCKED INPUTS" option is selected then the heart rate source signal is locked on the first detected signal during the workout. To set a heart rate signal input, or to turn off the heart rate option all together, perform the following steps:

1. On the controller keypad, press [SPEED: +], [3], [2]. At this point the screen will display "HR INPUTS." Press [ENTER] to select this option.

## OPERATING THE CLUBTRACK 510/612 TREADMILL

2. There are five options to handle heart rate input signals. Press the [SPEED: +] and [SPEED: -] keys to scroll through the options until you find the option that you want. Press the [ENTER] key to select that option.

**“ LOCKED INPUTS ”** - allows either telemetry or contact heart rate signals to be detected. Once the controller has detected a valid input signal it will lock out the opposite type of signal for the duration of the workout session. For example, if you start out using contact heart rate then you are limited to using only contact heart rate during your workout session, even if the signal is lost while performing the workout, and vice-versa.

**“ EITHER INPUT ”** - allows either telemetry or contact heart rate signals to be detected. Does not lock out a particular input signal for the entire workout. This option will detect either input signal during a workout session, but only one at a time, and only until the other signal terminates.

**“ TELEMETRY ONLY ”** - locks out contact heart rate signals and will only detect telemetry signals.

**“ HAND ONLY ”** - locks out telemetry signals and will only detect contact heart rate signals.

**“ BOTH HR OFF ”** - turns off the ability to detect any heart rate signal. Used in rare situations where there is excessive interference with the heart rate signals.

- During workouts where heart rate is necessary, such as the Constant Heart Rate program and the Fitness Test, the controller will pick up telemetry heart rate signals so that the programs are not disabled.



# OPERATING THE CLUBTRACK 510/612 TREADMILL

## ERROR CODES

If the controller finds a fault in the system, it displays an error code (example: "CONFIG REQD"). If an error code appears, turn the circuit breaker off, and then back on to restart the system. If the error code appears again, record the code, then turn off the treadmill and call a StairMaster-trained service representative (see section "Troubleshooting").

To see the error log:

1. Press [Speed:+], [7], [0], [ENTER]. The number of the logged error is shown in the upper right corner of the screen. The error code is shown in the middle of the screen
2. Press [Speed: +], or [Speed: -] to scan through individual error codes.
3. Press [CLEAR] to exit the error log.

## 1-MINUTE AUTO RESET

An automatic reset feature ensures the treadmill is ready for the next user. If you do not start the walk belt within one minute after entering exercise values or after pressing Stop Belt, the controller automatically resets the elapsed time and distance to zero and displays the opening screen.

## VIEWING MAINTENANCE INFORMATION

The total time and distance the treadmill has been used can be viewed under Maintenance Information. This information can help you schedule treadmill maintenance and check treadmill usage.

To view maintenance information:

1. Press [Speed: +], [4], [0], [ENTER]. The controller will display the machine run time in hours since last cleared.

## OPERATING THE CLUBTRACK 510/612 TREADMILL

2. Press [Speed: +], or [Speed: -] to scan through the number of workouts, the run distance, software revision, machine type, drive board revision, and maintenance hours.  
Or  
Press the code of the statistic you want to view.  
[Speed: +] [4] [0] Machine run time  
[Speed: +] [4] [1] Total number of workouts  
[Speed: +] [4] [2] Total distance based on cumulative workouts  
[Speed: +] [4] [3] Controller software revision  
[Speed: +] [4] [4] Machine type  
[Speed: +] [4] [5] Drive board revision  
[Speed: +] [4] [6] Machine run time since last serviced
  - Reset the maintenance timer after servicing by pressing [Speed: +], [7], [1], [ENTER].
3. Press [CLEAR] to exit.

## CUSTOMIZING THE CLUBTRACK 510/612 TREADMILL

You can customize several parameters on the 510/612 to conform to your individual requirements, including setting time limits, speed limits, changing screen contrast, changing language, and changing units.

To customize the controller:

1. Press [Speed: +], [3], [ENTER]. The controller will display "CUSTOMIZE."
2. Press [Speed: +], or [Speed: -] to scan through the workout time limit, units, heart rate input, language, contrast, speed limit, or magnetic key. Select your option by pressing [ENTER].  
Or  
Press the code of the option you want to view, followed by [ENTER].  
[Speed: +] [3] [0] Max time limit
  - For no time limit, press [0], [ENTER]. The screen will display "TIME LIMIT OFF."

## OPERATING THE CLUBTRACK 510/612 TREADMILL

- Use the numeric keypad to enter the desired time limit. Press [ENTER], [ENTER] to accept the new time limit.
- [Speed: +] [3] [1] Change units
- Use the [Speed: +] and [Speed: -] keys to toggle between USA units and Metric units. Press [ENTER] to select your option.
- [Speed: +] [3] [2] Choose the type of heart rate input (see page 45).
- [Speed: +] [3] [3] N/A
- [Speed: +] [3] [4] Choose language
- Use the [Speed: +] and [Speed: -] keys to scan through English, Spanish, German, French, Italian, Swedish, and Dutch. Press [ENTER] to select your option.
- [Speed: +] [3] [5] Adjust screen contrast
- Use the [Speed: +] and [Speed: -] keys to increase or decrease the contrast level. Press [ENTER] to select your option.
- [Speed: +] [3] [6] Max speed
- Use the numeric keypad to enter the treadmill speed limit. Press [ENTER], [ENTER], to accept the new speed.
- [Speed: +] [3] [7] N/A
- [Speed: +] [3] [8] Enable magnet key
- Use the [Speed: +] and [Speed: -] keys to toggle between "ON" and "OFF." Press [ENTER] to select your option.
- [Speed: +] [3] [9] Set Defaults
- This code will reset all exercise parameters to the factory defaults. Press [ENTER], [ENTER], to accept the default values.

### INSTRUCTION PAGE

For the convenience of all treadmill users, we strongly encourage you to copy the information on the next page and place the copy near the treadmill. These brief instructions will assist the user with basic operating steps.

# OPERATING THE CLUBTRACK 510/612 TREADMILL

## USING THE CLUBTRACK® 510/612 TREADMILL

This page is a summary only. Each first-time treadmill user must be instructed in the proper use of the treadmill, as described in the ClubTrack User's Guide.

1. Follow the Safety Guidelines listed below.
2. Step on the deck, and straddle the belt. If the limited-access control is on, place the magnetic key on the controller. If using the optional heart rate monitor or controller, strap on the chest belt and transmitter.
3. Select your workout option (Quick Start, Manual, Fat Burner, Aerobic Training, Speed Intervals, Constant Heart Rate, or just press [START BELT]).
4. Use the numeric keypad to enter your weight. Press [ENTER].
5. If you have selected Manual, Fat Burner, Aerobic Training, or Constant Heart Rate, use the numeric keypad to enter the speed (ClubTrack 510: 1.0 - 10 / ClubTrack 612: 1.0 - 12.0) desired. Press [ENTER].
6. If you have selected Fat Burner, Aerobic Training, or Speed Intervals, use the numeric keypad to enter the intensity level (1-20) desired. Press [ENTER].
7. If you have selected Constant Heart Rate, use the numeric keypad to enter your age. Press [ENTER].
8. If you have selected Constant Heart Rate, use the numeric keypad to enter your target heart rate (80 - 180 beats per minute). Press [ENTER].
9. If you have selected Constant Heart Rate, use the numeric keypad to enter the heart rate control method - either speed [1] or grade [2]. Press [ENTER].
10. Use the numeric keypad to enter the time (5-99) desired, or [0] for no time limit. Press [ENTER].
11. Press [START BELT].
12. Grasp the handrail and step onto the moving belt.
13. Use the [Speed: +] and [Speed: -] keys to adjust the speed. Use the [Grade: ^] and the [Grade: v] keys to adjust the grade.
14. When finished exercising, press [COOL DOWN] or [STOP].

## SAFETY GUIDELINES

- Secure long hair and loose clothing before use.
- Keep treadmill set to minimum speed and grade, or stopped when anyone is getting on or off.
- Keep the treadmill area clear, keep the rear clear of objects.

# OPERATING THE CLUBTRACK 510/612 PLUS TREADMILL

Follow the safety guidelines for using the treadmill given in the Introduction. If using the heart rate monitor, strap on the Polar transmitter as described.

## TURNING ON THE POWER

If the limited-access control is on, place the magnetic key over the StairMaster logo on the controller. Attach the cord of the key to the user's wrist or belt if desired. Press [POWER] to turn on the treadmill controller. The screen displays a greeting after the system runs a self-test. The grade display shows the current grade and the speed display shows zero.

## UNDERSTANDING THE CONTROLLER

The treadmill controller, which is mounted above the front handrail, is a computerized panel used to operate the treadmill. All commands are entered by pressing a soft-touch key on the panel. Visual indicators and displays show the operational status and exercise results. The controller provides 15 pre-programmed exercise routines and 5 exercise routines that you can customize.

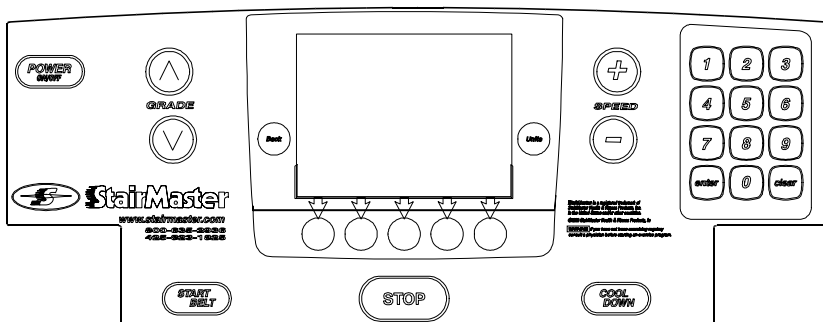

ClubTrack 510/612 Plus Control Panel

# OPERATING THE CLUBTRACK 510/612 PLUS TREADMILL

## CONTROLLER KEYS

The following describes the controller keys on the ClubTrack 510 Plus and ClubTrack 612 Plus treadmills:

### Display Window



**Grade** - Displays elevation grade in percent. The ClubTrack 510 Plus has an elevation range of 0 to 12.0%, and the ClubTrack 612 Plus has an elevation range of 0 to 15.0%.

**Speed** - The treadmill speed is displayed in miles per hour (or kilometers per hour). The ClubTrack 510 Plus has a speed range of 1.0 to 10.0 mph, and the ClubTrack 612 Plus has a speed range of 1.0 to 12.0 mph.

Exercise Workout Options:

**Manual** User controls speed and grade of treadmill.

**Workout Program** Select from 15 pre-programmed or 5 user-programmed workouts. You can scale the speed or grade of the workout before starting or during the workout.

**Intervals** Select speed, grade, and time for exercise and recovery phases of an interval cycle,

# OPERATING THE CLUBTRACK 510/612 PLUS TREADMILL

then select the number of intervals to perform during the workout.

## Heart Rate Control

System controls the speed or grade of the treadmill to keep the user at a selected target heart rate. You can modify the speed, grade, and target heart rate during the workout.

- To select a workout option, press the appropriate key. Press Back at any time to return to the previous screen.
- If you press [START BELT] before selecting a workout, the treadmill will run in manual mode. If you press [START BELT] before entering a weight or exercise time, the controller will use the default value of 150 lbs. (68 kg) for calorie calculations and the exercise timer will begin counting up from 00:00.

## Numeric keypad

The numeric keypad is located on the right side of the controller. Before the exercise program begins, the numbers are used to enter data in response to the controller prompts.

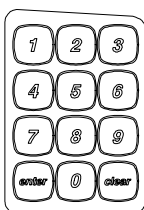

- **Enter** - Confirms workout selections and stores the information used by the controller to calculate workout statistics.
- **Clear** - During data entry, erases information from the controller memory if pressed before [ENTER].

## Grade Keys



GRADE



The treadmill grade may be changed at any time during a workout. Pressing the [Grade: ^] key increases the grade and pressing the [Grade: v] key decreases the grade.

# OPERATING THE CLUBTRACK 510/612 PLUS TREADMILL

## Speed Keys



*SPEED*



The treadmill belt speed may be changed at any time during a workout. Pressing the [Speed: +] key decreases the belt speed and pressing the [Speed: -] key increases the belt speed. The belt speed increases or decrease by 0.1 MPH (KPH).

## Start Belt Key



The start belt key starts the walk belt with a gradual increase to the default start speed.

## Cool Down Key



The cool down key will cause the exercise program to end. The deck grade returns to 0% and the speed decreases to 1.0 MPH.

## Stop Key



Stops the walking belt gradually. The [STOP] key can be used at any time during exercise.

## Power On/Off Key



The power on/off key activates and deactivates the control panel.

## Back key



Returns to the previous screen.

## Units Key



Changes the unit of measurement used for calculations and displays. Choose U.S. or metric units.



# OPERATING THE CLUBTRACK 510/612 PLUS TREADMILL

## Multi-function keys



5 multi-function keys perform the function defined by the icon or text displayed on the LCD screen immediately above the key.

## DISPLAYS AND INDICATORS

The following displays appear in the center screen once a workout option has been selected.



Displays the speed/grade graph, workout status, and (if Polar belt is active) heart rate graph sequentially for 10 seconds each.



Displays the speed/grade graph.



Displays the workout status screen, including time/stage time, distance, vertical feet, pace, power, METs, calories, and calories/min.



Displays the heart rate graph.

The following indicators appear in the center screen once a workout option has been selected.

**MPH** The system is set to U.S. units - Miles per Hour.

**KM/H** The system is set to metric units - Kilometers per Hour.

# OPERATING THE CLUBTRACK 510/612 PLUS TREADMILL

## EXERCISE PARAMETERS

You can select one of the following parameters on which to base your workout: time, distance, or calories. After you have chosen an exercise mode, the following screen appears (unless Interval Mode is selected):

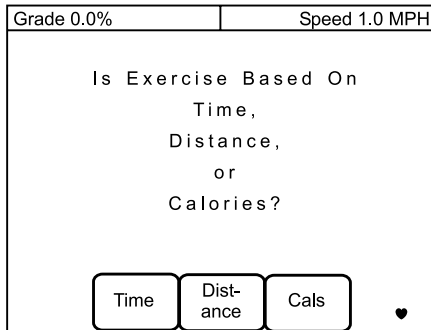

### Time

This is the total workout time. If you have selected a pre-programmed workout, the treadmill will scale the stages to fit the total time you select.

For example, a pre-programmed workout consists of 16 stages. If you select a total workout time of 32 minutes, each stage will be 2 minutes long.

- If a maximum exercise time has been preset, you cannot exceed that limit.
- If you do not enter a time or if you press [START BELT] before entering a time, the timer will count up from 00:00.
- If you select an exercise time, the timer counts down from your selected value.
- When the treadmill reaches its time limit (0 in countdown mode or a preset limit in count-up mode), it

# OPERATING THE CLUBTRACK 510/612 PLUS TREADMILL

goes to cool down mode and the timer continues counting total elapsed time.

- If you do not use the treadmill within five minutes of entering weight and exercise time or starting the walk belt, the controller automatically resets to its default values.
- In Interval mode, the duration of time, distance, or calories may be monitored in the Setup screen.

## Distance

The total distance covered in the workout. If you have selected a pre-programmed workout, the total time of the workout will be adjusted to cover the distance you selected.

For example, if you select a total workout distance of 3 miles, the treadmill will use the programmed speeds for each stage, calculate the total time required to reach 3 miles, and divide the total time by the number of stages so that each stage is the same time. During the workout, as you manually change speed the time will be automatically adjusted to a predicted time when the selected distance will be covered.

## Calories

The total calories expended in the workout. If you have selected a pre-programmed workout, the total time of the workout will be adjusted to achieve the number of calories you have selected.

For example, if you want to expend 200 calories, the treadmill will use the default speeds and grades for each stage, calculate the total time required to expend 200 calories, and divide the total time by the number of stages so that each stage is an equal time. Additionally, as you manually change speed or grade the time will be automatically adjusted to a predicted time when the amount of selected calories will be burned.

# OPERATING THE CLUBTRACK 510/612 PLUS TREADMILL

## EXERCISE WORKOUT OPTIONS

### Manual Workout

In manual mode, you control the workout. You can change the speed and grade at any time using the speed and grade keys.

To select a manual workout:

1. Select [MANUAL]. The following screen appears:

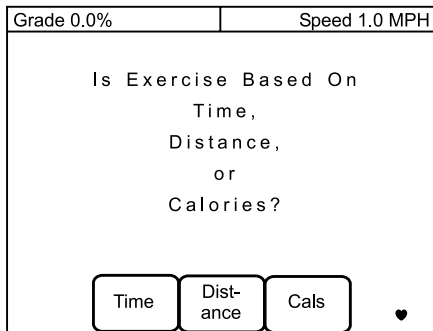

2. Select the appropriate key that matches the parameter on which you want your workout to be based: time, distance, or calories.
3. Enter the desired value for the selected parameter, and press [ENTER].
4. Enter your weight using the numeric keypad and press [ENTER].  
OR  
Press [ENTER] to accept the default value of 150 lbs.
5. To end your workout at any time:
  - Press [COOL DOWN].

# OPERATING THE CLUBTRACK 510/612 PLUS TREADMILL

- When grade is zero, press [STOP BELT].
- When the belt stops moving, step off the treadmill.
- Press [POWER] to turn off the controller.

## Pre-Programmed Workouts

In pre-programmed mode, you can select from 20 pre-programmed workouts. The selected workout appears in graphic form on the controller screen. Each workout is divided into 16 equal time stages. The treadmill operates at the pre-programmed speed and grade for each stage, automatically changing from stage to stage. Select the Workout Status screen to view the remaining stage time, elapsed distance, pace, heart rate, calories, and METs. Remaining exercise time appears in the upper left corner.

- Although the default total workout time is 20 minutes, you can program a time limit between 10 and 95 minutes. You can set a workout time within the pre-selected limits.
- The values listed in the table following this section may vary if somebody else has reprogrammed any of the workouts. Refer to this table only as a general guide.

To select a pre-programmed workout:

1. Select [WORKOUT PROGRAM].
2. Select the appropriate key that matches the parameter on which you want your workout to be based: time, distance, or calories.
3. Enter the desired value for the selected parameter, and press [ENTER].
4. Enter your weight using the numeric keypad and press [ENTER].  
OR  
Press [ENTER] to accept the default value of 150 lbs.



## OPERATING THE CLUBTRACK 510/612 PLUS TREADMILL

A profile of the first preprogrammed workout appears on screen.

- Your weight is used to calculate the number of calories consumed for each minute of exercise and the total number of calories burned during exercise.
5. Cycle through the workouts until you find the workout you want.
- Use “VIEW LAST WORKOUT,” or “VIEW NEXT WORKOUT” to cycle through the programmed workouts.
  - The pre-programmed workout parameters are listed in the table on the following page.

No.	Name	Description	Speed (mph)	Grade (%)	METS (min)	METS(max)	METS (avg)	Dist. (mi)
<b>WALKING COURSES</b>								
1	Boston Walk	light walk	1.7-2.2	2-5	2.7	3.6	3.2	0.64
2	X Country Walk	moderate walk	1.8-2.5	2-7	2.8	4.1	3.8	0.70
3	Tour de USA Walk	moderate walk	2.0-3.0	2-7	3.0	5.1	4.4	0.85
4	Aerobic Walk	hard walk	2.2-3.2	2-7	3.2	6.5	4.7	0.95
5	The Rockies Walk	hard walk	2.4-3.6	2-7	3.4	6.1	4.9	1.06
<b>RUNNING COURSES</b>								
6	Seattle Run	light run	4.4-5.0	2-5	7.0	9.1	8.5	1.57
7	X Country Run	moderate run	4.4-5.2	2-7	7.0	10.1	9.2	1.60
8	Tour de Italy	moderate run	4.8-5.4	1-7	7.9	10.3	9.7	1.66
9	Aerobic Run	hard run	4.7-5.3	2-7	7.9	10.8	9.6	1.67
10	The Alps Run	hard run	4.3-5.6	0-11	7.1	10.8	9.8	1.65
<b>RANDOM COURSES</b>								
11	Random Workout	changing hill walk	3.7	0-6	4.3	6.8	5.2	1.23
12	Calorie Burn	moderate walk	2.9-3.7	1-7	3.6	6.1	5.4	1.07
13	Speed Play (Fartlek)	moderate run	5.4-6.5	0-7	9.2	11.7	10.3	1.90
14	Speed Bump	moderate walk	2.8-6.0	0	3.1	10.1	6.6	1.44
15	Tempo	hard run	6.0-8.0	0	10.1	13.2	12.2	2.45

**CUSTOM COURSES (USER-DEFINED)**

16 - 20 Custom 1- 5

## OPERATING THE CLUBTRACK 510/612 PLUS TREADMILL

6. Press the appropriate key for "SELECT THIS WORKOUT."
7. To skip the warmup and go directly to the workout, press [START BELT]. To do a warmup before you begin the workout, press the appropriate key for "WARMUP FIRST," and then [START BELT].
  - You can increase or decrease a workout's difficulty by adjusting the speed and grade. To modify the scale Follow the directions on the screen to modify the speed and grade.

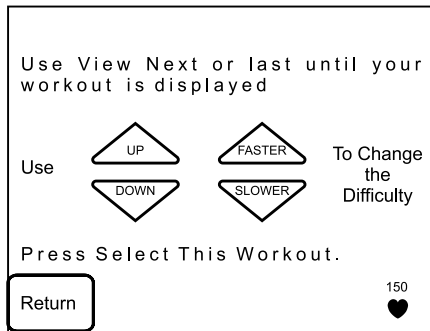

- You can scale a course at any time after the workout begins. However, you cannot override an owner-set maximum. The changes you make apply to all subsequent stages until another change is made.

### Stage Changes

- The current stage is indicated by a blinking pointer below the respective speed and grade graph. Five seconds before a stage change, the current stage bar on the screen blinks. After a stage is finished, the speed and grade graph for that stage become solid bars.
8. To end your workout at any time:
    - Press [COOL DOWN].



## OPERATING THE CLUBTRACK 510/612 PLUS TREADMILL

- When grade is zero, press [STOP BELT].
  - When the belt stops moving, step off the treadmill.
  - Press [POWER] to turn off the controller.
9. Press [COOL DOWN] after your workout to cool down. The deck will return to 0% grade and the speed will slow to 1.0 mph. During "COOL DOWN," The timer continues counting total accumulated time and you can change speed and grade.
- If you press Cool Down during the program, the system enters manual mode, the grade changes to zero, and the speed decreases to the minimum (1.0 mph/1.6 km/h). You can adjust the speed and/or grade at any time.
  - If you press [STOP BELT] during the program, all timers and calculations remain suspended for five minutes. The system presents an option screen letting you resume the workout, display the workout status or heart rate graph, or clear for the next user. If you do not select an option within 5 minutes, the controller displays the opening screen.
  - Press the appropriate key for "NEW WORKOUT" to return to the opening screen.

### Editing a Pre-Programmed Workout

Any of the pre-programmed workouts can be modified and saved. You can also reset the default factory settings of any workout.

To edit a workout:

1. Enter Custom mode (see "Entering Custom Mode").

## OPERATING THE CLUBTRACK 510/612 PLUS TREADMILL

2. Press the appropriate key for "EDIT PROGRAMMED WORKOUTS."
3. Press the appropriate key for "VIEW LAST WORKOUT," or "VIEW NEXT WORKOUT" until the graph of the workout you want to edit appears on screen.
4. Press the appropriate key for "EDIT WORKOUT." A screen similar to the following appears.

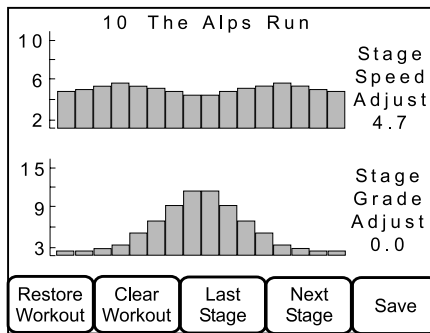

5. Use the [Speed: +], [Speed: -], [Grade: ^], and [Grade: v] keys to adjust the speed and grade for each stage of the workout.
  - The bar for the stage currently being edited blinks.
6. Press the appropriate key for "NEXT STAGE" to move to the next stage.
7. To restore the factory settings, press the appropriate key for "RESTORE WORKOUT." To save the new settings, press the appropriate key for "SAVE."
8. Press the appropriate key for "RETURN" to return to the Custom Options screen.
9. Press the appropriate key for "EXIT" to exit Custom mode.

# OPERATING THE CLUBTRACK 510/612 PLUS TREADMILL

## Interval Workouts

An interval cycle consists of an exercise phase and a recovery phase. An interval workout consists of a series of interval cycles. You can define the number of intervals and the speed, grade, and time of each phase.

- *Number of Intervals* - The default number of intervals is four. You can change this to a maximum of 99 intervals. However, if the owner has programmed a time limit, the maximum number of intervals becomes the number of whole intervals that will fit into the time limit.
- *Display* - The graphics displayed for this mode show the two phases of the interval: exercise and recovery. The system fills in the graphics bars as the phase progresses. The time for each bar is approximately the total cycle time divided by 16. After a complete cycle finishes, the graphics display restarts and the filling process repeats.
- *Speed and Grade* - Once the interval workout is underway, you can scale the speed and/or grade up and down. The scaling applies only to the current interval phase and the new speed and grade selected is retained for the rest of the interval cycles.

To select an Interval workout:

1. To select an interval workout, press [INTERVALS].
2. Enter your weight using the numeric keypad and press [ENTER].  
OR  
Press [ENTER] to accept the default value.
  - Your weight is used to calculate the number of calories consumed for each minute of exercise and the total number of calories burned during exercise.

# OPERATING THE CLUBTRACK 510/612 PLUS TREADMILL

The following screen appears:

Exercise		Recovery	
Time:	3:00	Time:	3:00
Speed:	6.0	Speed:	3.0
Grade:	0.0	Grade:	0.0
Number of Intervals:			4
Total Time:		24:00	
Total Distance:		1.80 MI	
Total Calories:		183	
<input type="button" value="Help"/> <input type="button" value="Select This Workout"/>		♥	

- Default Interval Phase Values:

	Exercise	Recovery
<b>Time</b>	3:00	3:00
<b>Speed</b>	6.0 mph	3.0 mph
<b>Grade</b>	0%	0%
<b>Intervals</b>	4	4

- To enter new values, use the numeric keypad to enter a number, then press [ENTER].
  - Total distance, time, and calories are automatically adjusted as you change the interval parameters.
- To accept the parameters, press the appropriate key for "SELECT THIS WORKOUT."
- To skip the warmup and go directly to the workout, press [START BELT]. To do a warmup before you begin the workout, press the appropriate key for "WARMUP FIRST," and then [START BELT].
  - You can increase or decrease a workout's difficulty by adjusting the speed and grade. To modify the scale

## OPERATING THE CLUBTRACK 510/612 PLUS TREADMILL

Follow the directions on the screen to modify the speed and grade.

- You can scale a course at any time after the workout begins. However, you cannot override an owner-set maximum. The changes you make apply to all subsequent intervals until another change is made.
6. To end your workout at any time:
- Press [COOL DOWN].
  - When grade is zero, press [STOP BELT].
  - When the belt stops moving, step off the treadmill.
  - Press [POWER] to turn off the controller.
7. Press [COOL DOWN] after your workout to cool down. The deck will return to 0% grade and the speed will slow to 1.0 mph. During "COOL DOWN," The timer continues counting total accumulated time and you can change speed and grade.
- If you press Cool Down during the program, the system enters manual mode, the grade changes to zero, and the speed decreases to the minimum (1.0 mph/1.6 km/h). You can adjust the speed and/or grade at any time.
  - If you press [STOP BELT] during the program, all timers and calculations remain suspended for five minutes. The system presents an option screen letting you resume the workout, display the workout status or heart rate graph, or clear for the next user. If you do not select an option within 5 minutes, the controller displays the opening screen.

## OPERATING THE CLUBTRACK 510/612 PLUS TREADMILL

- Press the appropriate key for “NEW WORKOUT” to return to the opening screen.

### Heart Rate Control Workout

The heart rate controller allows you to monitor your level of exertion by setting a target heart rate. The heart rate controller then adjusts the treadmill's speed or grade to maintain that heart rate (within  $\pm 5$  beats per minute). The controller works with any Polar or Polar-compatible chest belt and transmitter to detect heart rate. See the Heart Rate Monitoring section of this manual for instructions on how to use the transmitter belt. *This program does not work with contact heart rate.*

- *Auto Grade Mode* - In this mode, the controller adjusts the grade based on your speed selection. The initial treadmill settings are 3 mph with 0.0% grade. The controller adjusts the grade until your heart rate is within 5 BPM (beats per minute) of your selected target heart rate. You can adjust the speed at any time.

The default maximum grade in this mode is 12% on the ClubTrack 510 Plus, and 15% on the ClubTrack 612 Plus. You can set a lower maximum grade by selecting “ENTER MAX GRADE” on the Start Belt screen.

- *Auto Speed Mode* - In this mode, the controller adjusts the speed based on your grade selection. The controller adjusts the speed until your heart rate is within 5 BPM of your selected target heart rate. You can adjust the grade at any time.

The default maximum speed in this mode is 10 mph on the ClubTrack 510 Plus, and 12 mph on the ClubTrack 612 Plus. You can set a lower maximum speed by selecting “ENTER MAX SPEED” on the Start Belt screen.

- *Exercise Time* - Exercise time is the total time spent during the heart rate control exercise. Once the exercise time has elapsed, the treadmill enters the cool down mode. The

## OPERATING THE CLUBTRACK 510/612 PLUS TREADMILL

maximum selectable exercise time is 99 minutes (less if this limit has been changed).

The heart rate graph displays minutes on the horizontal axis and BPM on the vertical axis.

The time scale begins at a length of 15 minutes. If you exercise longer than 15 minutes, the scale increases by 5 minutes and the graph compresses accordingly. This process continues at 5-minute intervals until you press Stop Belt.

- The controller increases speed or grade to achieve a constant heart rate increase over time. If the user is in poor condition, the controller changes speed slowly because the heart rate changes quickly. If the user is in good condition, the speed changes more quickly because the heart rate changes slowly.

To select a heart rate control workout:

1. To select heart rate control mode, press Heart Rate Control on the opening screen.
2. Select the appropriate key that matches the parameter on which you want your workout to be based: time, distance, or calories.
3. Set your weight using the numeric keypad and press Enter.  
OR  
Press Enter to accept the default value.
  - Your weight is used to calculate the number of calories consumed for each minute of exercise and the total number of calories burned during exercise.

The following screen appears (pg. 70):

# OPERATING THE CLUBTRACK 510/612 PLUS TREADMILL

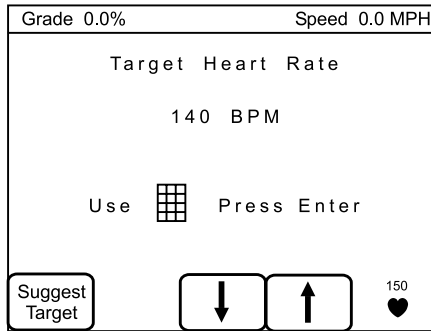

4. Use the numeric keypad to enter your target heart rate or use the arrow buttons on the screen to increase or decrease the rate.
  - To access recommended exercise ranges based on age, press the appropriate key for "SUGGEST TARGET" and follow the instructions on the display.
5. Press [ENTER] to accept the target heart rate.
6. Press either Auto Grade Control or Auto Speed Control.
  - In Auto Grade Control, you can enter a maximum grade by pressing "ENTER MAX GRADE."
  - In Auto Speed Control, you can enter a maximum speed by pressing "ENTER MAX SPEED."
7. Press [START BELT] to begin your workout.
  - You can change speed and grade at any time during heart rate control. By increasing speed or grade, you can shorten your time to target heart rate.
  - You can override automatic speed or grade increases at any time during the heart rate control workout.
  - The treadmill holds the heart rate at  $\pm 5$  BPM of the target setting with small speed changes in both the



# OPERATING THE CLUBTRACK 510/612 PLUS TREADMILL

Speed and Grade HRC modes.

- In Speed HRC mode, the factory limit for speed is 10 mph on the ClubTrack 510 Plus, and 12 mph on the ClubTrack 612 Plus. Any speed below the factory limit may be set by the user. The limit for grade increase in Grade HRC mode is 12% on the ClubTrack 510 Plus, and 15% on the ClubTrack 612 Plus.
  - You can change the target heart rate at any time during the workout. A change in target heart rate does not reset any speed or grade overrides made prior to the target change.
8. To end your workout at any time:
- Press [COOL DOWN].
  - When grade is zero, press [STOP BELT].
  - When the belt stops moving, step off the treadmill.
  - Press [POWER] to turn off the controller.
9. Press [COOL DOWN] after your workout to cool down. The deck will return to 0% grade and the speed will slow to 1.0 mph. During "COOL DOWN," The timer continues counting total accumulated time and you can change speed and grade.
- If you press Cool Down during the program, the system enters manual mode, the grade changes to zero, and the speed decreases to the minimum (1.0 mph/1.6 km/h). You can adjust the speed and/or grade at any time.
  - If you press [STOP BELT] during the program, all timers and calculations remain suspended for five minutes. The system presents an option screen letting you resume the workout, display the workout status or heart rate graph, or clear for the next user. If you do not select an option within 5 minutes, the controller

# OPERATING THE CLUBTRACK 510/612 PLUS TREADMILL

displays the opening screen.

## STATUS SCREENS FOR ALL WORKOUT MODES

All workout modes allow you to view graphs of your progress during your workout.

To view a graph, press the corresponding key to the icon representing the information you want to view.

### Speed and Grade Graph View

Shows changes in grade and speed throughout the workout.

#### Manual Mode

During a manual or heart rate control workout (and after cool down), a speed and grade graph similar to the following appears:

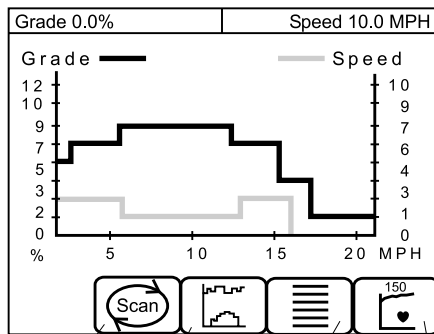

Scans through the graphs and workout status

Speed/Grade Graph

Workout Status

HR Graph

#### Programmed Workout Mode

During a programmed workout, the speed and grade graph view appears similar to the following:

# OPERATING THE CLUBTRACK 510/612 PLUS TREADMILL

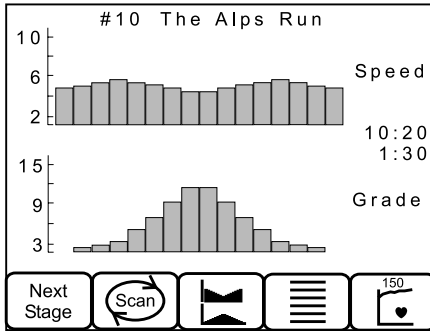

## Workout Status View

### Manual and Heart Rate Modes

Displays the workout status: elapsed time, distance, vertical distance, pace, power, MET rate, calories, calories/minute, and heart rate.

### Programmed and Interval Modes

Displays the remaining time, stage time, distance, vertical distance, pace, power, MET rate, calories, calories/minute, and heart rate.

Grade 0.0%	Speed 1.0 MPH		
Time	9:38	0:08	Stage
Distance	0.002 Miles		
Vertical	254 Feet		
Pace	60:00 Min/Mi		
Power	120 Watts		
MET Rate	1.8 METS		
Calories	20.5	2.0	/Min

Interval or workout mode

# OPERATING THE CLUBTRACK 510/612 PLUS TREADMILL

## Heart Rate Graph View

Depicts heart rate versus time.

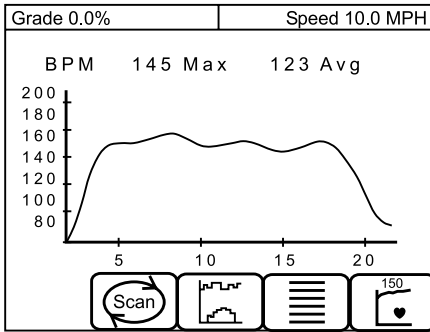

## Scanning All Views

This view continuously scans through the speed/grade, workout status, and heart rate (if a Polar belt is present) views.

## ENTERING AN ID NUMBER

If your treadmill is connected to a computer network, you will be asked for a user ID number after selecting a workout mode. After you enter your ID number, you will be connected to the network.

To enter your ID number:

1. Select Input User ID.
  - To go directly to the workout options menu without connecting to a computer network, press Next.
2. Use the numeric keypad to enter your ID number.
3. When you have entered all five digits, press Enter.
  - If you enter an incorrect number, Invalid ID, not accepted will appear on the screen. Check your ID number and re-enter it.

# OPERATING THE CLUBTRACK 510/612 PLUS TREADMILL

## ERROR CODES

If the controller finds a fault in the system, it displays an error code and description (example: E202, speed check error). If an error code appears, press Power twice to restart the system. If the error code appears again, record the code number, then turn off the treadmill and call a StairMaster-trained service representative (see section, Maintenance and Troubleshooting).

## 5-MINUTE AUTO RESET

An automatic reset feature ensures the treadmill is ready for the next user. If you do not start the walk belt within five minutes after entering exercise values or after pressing Stop Belt, the controller automatically resets the elapsed time and distance to zero and displays the opening screen.

## CUSTOMIZING THE CLUBTRACK 510/612 PLUS TREADMILL

You can customize several parameters on the 510/612 Plus to conform to your individual requirements, including editing pre-programmed workouts, setting time limits, speed limits, changing screen contrast, and setting a custom screen greeting.

### Entering Custom Mode

To enter Custom mode:

1. Make sure the controller power is off.
2. Hold down the key indicated below.

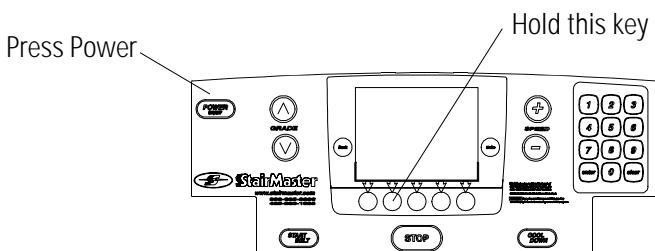

# OPERATING THE CLUBTRACK 510/612 PLUS TREADMILL

3. Press Power.
4. When the power starts, release the Power key, while continuing to hold the indicated key.
5. Keep holding the key until the Custom Options screen appears (approximately 3 seconds). The following screen appears:

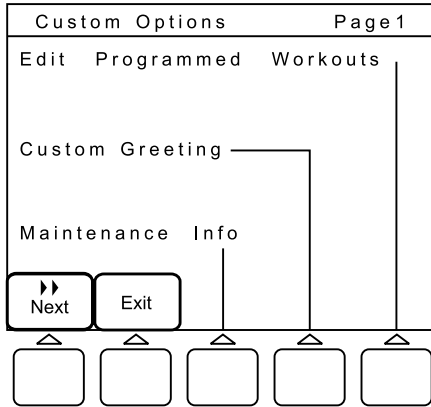

## Setting a Custom Greeting

Your treadmill is delivered with a generic greeting on the opening screen. You can create your own greeting up to 25 characters. To customize this greeting:

1. Enter Custom mode (see "Entering Custom Mode").
2. Press the Custom Greeting key. A screen similar to the following appears:

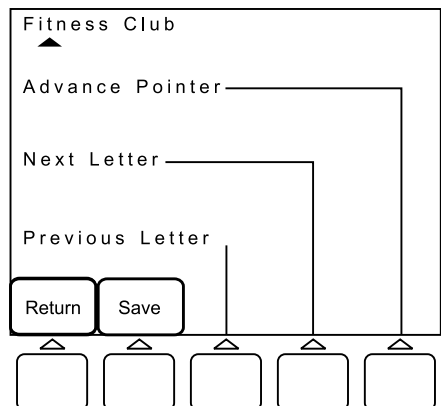

## OPERATING THE CLUBTRACK 510/612 PLUS TREADMILL

3. Edit the existing greeting letter-by-letter. A flashing caret appears beneath the letter being edited. Press Next Letter or Previous Letter until the letter you want appears.
  - Letters appear in the following order: numbers, upper case letters, and then lower case letters.
4. To move to the next letter location, press Advance Pointer.
5. Continue entering letters until your message is complete. Press Save to save the new message.
6. Press Return to return to the Custom Options screen.
7. Press Exit to exit Custom mode.

### VIEWING MAINTENANCE INFORMATION

The total time and distance the treadmill has been used can be viewed under Maintenance Information. This information can help you schedule treadmill maintenance and check treadmill usage.

To view maintenance information:

1. Enter Custom mode (see “Entering Custom Mode”).
2. Press the Maintenance Info key. The total distance is displayed in miles and the total time is displayed in hours.

Maintenance Information	
Total Distance	3.3 MI
Total Time	78 HR

Return

## OPERATING THE CLUBTRACK 510/612 PLUS TREADMILL

3. Press Return to return to the Custom Options screen.
4. Press Exit to exit Custom mode.

### ADJUSTING SCREEN CONTRAST

To adjust the screen contrast:

1. Enter Custom mode (see "Entering Custom Mode").
2. Press Next.
3. Press the Set Screen Contrast key. The following screen appears.

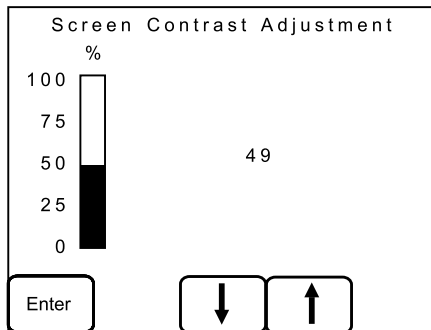

4. Use the arrow keys on the screen to adjust the contrast.
5. When finished, press Enter to return to the Custom Options screen.
6. Press Exit to exit Custom mode.

### SETTING A USER TIME LIMIT

The time limit control lets you set a maximum time for treadmill use, ranging from 7 to 95 minutes. The feature is useful in busy clubs where it is important to ensure treadmill access for everyone.



## OPERATING THE CLUBTRACK 510/612 PLUS TREADMILL

When the time limit is activated, the treadmill runs for the length of time you defined, then automatically changes to minimum speed and grade. The speed and grade controls remain inoperative until you press [STOP BELT].

To set a time limit:

1. Enter Custom mode (see "Entering Custom Mode").
2. Press the appropriate for "NEXT."
3. Press the key corresponding to "USER TIME LIMIT." The following screen appears:

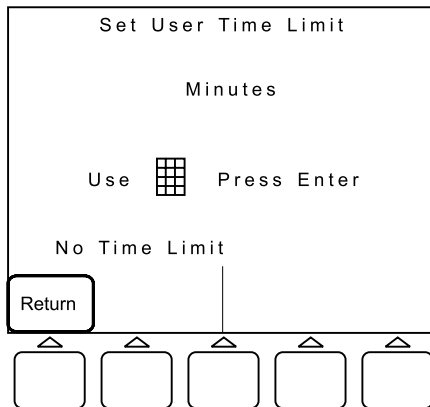

4. Using the numeric keypad, enter a time limit (any number from 7 to 95).
5. Press "RETURN" to return to the Custom Options screen.
6. Press "EXIT" to exit Custom mode.

### SETTING A MAXIMUM SPEED

You can set a maximum speed for the treadmill which is lower than the factory setting (ClubTrack 510 Plus: 10 mph, ClubTrack 612 Plus: 12 mph). This maximum speed applies to all workout modes.

# OPERATING THE CLUBTRACK 510/612 PLUS TREADMILL

To set a maximum speed:

1. Enter Custom mode (see "Entering Custom Mode").
2. Press the appropriate for "NEXT" to access Page 2.
3. Press the appropriate key for "SET MAX SPEED." The following screen appears.

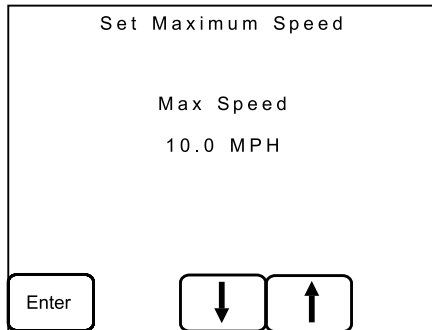

4. Use the arrow keys on the screen to adjust the maximum speed.
5. Press [ENTER].
6. Press [EXIT] to exit Custom mode.

## SETTING US OR METRIC UNITS

Press [UNITS] to toggle between US (miles and pounds) and Metric (kilometers and kilograms) units.

- You can change units at any time.

## Instruction Page

For the convenience of all treadmill users, we strongly encourage you to copy the information on the next page and place the copy near the treadmill. These brief instructions will assist the first time user and remind the experienced user of basic operating steps.

# OPERATING THE CLUBTRACK 510/612 PLUS TREADMILL

## Using the ClubTrack® 510/612 Plus Treadmill

1. Follow the Safety Guidelines listed below.
2. If the limited-access control is on, place the magnetic key on the controller. If using the optional heart rate monitor or controller, strap on the chest belt and transmitter.
3. Press [POWER].
4. Use the [UNITS] key to choose U.S. or metric units.
5. Select your workout option ([MANUAL], [INTERVALS], [PRE-PRO GRAMMED], or [HR CONTROL]).
6. Use the numeric keypad to enter time if desired. Press [ENTER]. Follow the instructions on the display to set up your workout.
7. Use the numeric keypad to enter weight. Press [ENTER].
8. Press [START BELT].
9. Grasp the handrail and step onto the moving belt.
10. Use the [Speed: +] and [Speed: -] keys to adjust the speed. Use the [Grade: ^] and the [Grade: v] keys to adjust the grade.
11. Select the appropriate key to display the desired parameter.



Scans between other modes shown.



In Manual mode, displays Speed/Grade graph



In Preprogrammed Workout mode, displays Speed/Grade graph



Displays Workout Status parameters



Displays Heart Rate graph

12. When finished exercising, press [COOL DOWN] or [STOP BELT].
13. Press [CLEAR], and then [POWER] to turn off the system.

## SAFETY GUIDELINES

- Start walk belt before stepping onto belt.
- Secure long hair and loose clothing before use.
- Keep treadmill set to minimum speed and grade when anyone is getting on or off.
- Keep the treadmill area clear.



(This page blank)

## MAINTENANCE

Visually inspect and clean the treadmill regularly. Daily visual inspection should include:

- Inspect the power cord and walking belt for wear.
- Check the position of the walking belt; be sure it is not rubbing against the frame. The belt should be evenly spaced on the deck within 0.25 inch; adjust if necessary.
- Check optional side handrails to be sure they are fastened securely.
- Remove potential hazards from the treadmill area.

## CLEANING

### Treadmill and Controller

- **Daily:** Keep the treadmill and controller free of dust and debris. Use a damp sponge to wipe the exteriors and walking belt; do not soak surfaces. Dry all surfaces thoroughly.



## WARNING

NEVER WIPE THE DECK UNDER THE BELT, EVEN WHEN REPLACING A BELT. WIPING CAN RUIN THE PROPRIETARY FRICTION-CONTROL SURFACE.

DO NOT USE DETERGENTS OR CLEANING AGENTS ON ANY PART OF THE DECK.

DO NOT LET LIQUID ENTER THE TREADMILL OR CONTROLLER. IF IT DOES, THE EQUIPMENT MUST BE INSPECTED AND TESTED FOR SAFETY BY A STAIRMASTER-APPROVED TECHNICIAN BEFORE IT CAN BE USED AGAIN.

## MAINTENANCE

- **Weekly:** Elevate the treadmill to maximum grade and vacuum the floor under it to prevent excess dust and dirt from interfering with operation.

### Treadmill Interior

Depending upon the treadmill environment, dust and or lint can accumulate under the hood. Periodic internal cleaning should be done by qualified service personnel.



## WARNING

DO NOT REMOVE THE TREADMILL HOOD:  
DANGEROUS VOLTAGES ARE PRESENT. COMPONENTS ARE  
SERVICEABLE ONLY BY QUALIFIED SERVICE PERSONNEL.

### Transmitter Belt

Clean the chest belt regularly with mild soap and water, then dry thoroughly-residual sweat and moisture keep the transmitter active and drain the battery in the transmitter. Do not use abrasives or chemicals such as steel wool or alcohol for cleaning, as they can damage the electrodes permanently.

### Transmitter Battery

The estimated life of the belt transmitter is 2500 hours of use. For a replacement belt and for recycling the old transmitter belt, contact Polar Electro at 800/227-1314. The batteries are not replaceable.

### Transmitter Storage

Store the belt in a warm, dry place away from direct sunlight. Do not store in plastic or other material that can trap moisture. Do not store in soap and water bath-moisture keeps the transmitter active and drains the battery in the transmitter.

## TREADMILL BELT ADJUSTMENTS



### WARNING

SECURE LONG HAIR AND LOOSE CLOTHING BEFORE WORKING NEAR THE TREADMILL WALKING SURFACE OR PULLEYS.

### Belt Tension

Adjust the belt tension whenever the belt slips or moves unsteadily during operation. Start by loosening the belt with the adjustment bolts.

1. Adjust the walking belt to .4% stretch. With the walking belt loose, place two marks 30.0 inches (750 mm) apart on each side of the belt, near each edge of the belt. The belt must be loose enough for you to move it from side to side on the front or rear roller.

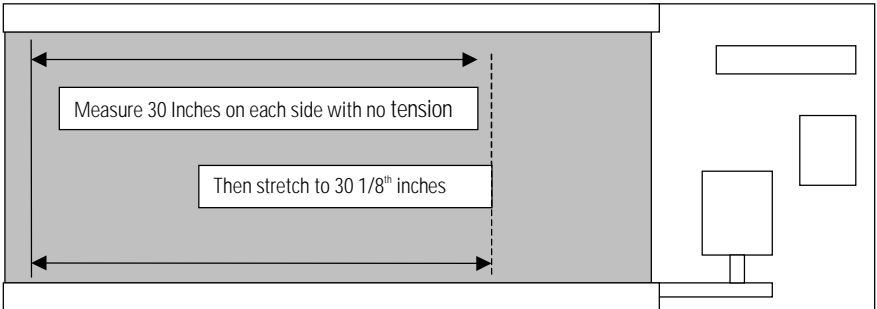

2. Turn the adjusting bolts clockwise by equal amounts until the marks are 30 1/8 inches (753 mm) apart (30.0 in./30 1/8 = .4% stretch). This should be about 6 full turns of each adjusting bolt from the point where the belt begins to stretch.

## MAINTENANCE

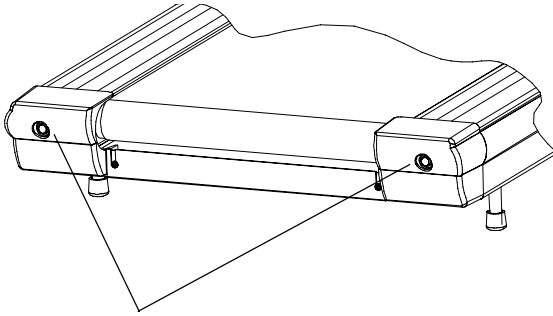

Adjustment Bolts

3. Run the belt at 3 MPH and make any tracking adjustments by loosening the adjusting bolt on the side where the belt is farthest from the adjustment bolt. Make small adjustments (1/4- turn) until the belt is centered on the rollers.
4. Test the belt by running on the belt at about 4 MPH. Hold the handrail lightly and resist the belt movement with your feet.



### WARNING

DO NOT USE ALL YOUR WEIGHT TO RESIST THE BELT MOVEMENT. TOO MUCH RESISTANCE APPLIED TOO LONG (MORE THAN TWO SECONDS) WILL SHUT DOWN THE SYSTEM. (VARIOUS ERROR MESSAGES APPEAR IF THIS OCCURS. PRESS POWER TWICE TO RESUME NORMAL OPERATION.)

5. If you feel the belt slip on the front roller, then increase the tension of each adjusting screw by 1/2 turn and retest. If you feel the belt slip again, check the tensioner adjustment.



### WARNING

DO NOT OVERTIGHTEN THE WALKING BELT. DO NOT TORQUE ADJUSTMENT SCREWS BEYOND 80 IN-LBS (9N-M) MAXIMUM. OVERTIGHTENING THE BELT WILL DAMAGE THE BELT AND ROLLERS.



## Belt Tracking

Perform this procedure whenever the belt moves to one side or the other. Stay off the belt when adjusting the tracking.

1. Start the treadmill at minimum speed and grade.
2. Increase speed to 6 mph (9.5 km/h) and make the following adjustment. The figure above shows the location of the bolts):
  - a. If the belt moves to the right, turn the right tension bolt 1/4-turn clockwise.
  - b. If the belt moves to the left, turn the left tension bolt 1/4-turn clockwise.
3. After making an initial adjustment, run the treadmill for five minutes and observe how the belt tracks. If the belt continues to move away from the center, adjust the appropriate side as in Step 2 until properly centered.



## WARNING

DO NOT OVERTIGHTEN THE WALKING BELT. DO NOT TORQUE ADJUSTMENT SCREWS BEYOND 80 IN-LBS (9N-M) MAXIMUM. OVERTIGHTENING THE BELT WILL DAMAGE THE BELT AND ROLLERS.

4. Stop the treadmill.

## Belt Replacement

If the walking belt becomes worn from heavy usage, it may need to be replaced. Call StairMaster Technical Service if you have a question.

## MOVING AND STORING THE TREADMILL

Moving the treadmill requires two people.

## MAINTENANCE

1. Set the treadmill to 3 to 5% grade.
2. To avoid electrical shock, turn off the circuit breaker on the treadmill hood, then remove the treadmill power cord from the power source before moving the treadmill.



### **WARNING**

AS LONG AS THE TREADMILL IS PLUGGED INTO A POWERED OUTLET AND THE TREADMILL CIRCUIT BREAKER IS ON, THE UNIT IS RECEIVING POWER, EVEN IF THE CONTROLLER IS TURNED OFF.

3. Together, lift the rear of the treadmill, then roll it to the new site using the wheels on the front of the treadmill.

When storing for prolonged periods, cover the treadmill with a dust cover. Do not store in damp areas. Do not store the treadmill on its end as it could fall on someone.

### **Using After Storage Period**

Before using the treadmill again after moving or storage, check the power cord and all attachments to be sure they are undamaged and securely connected, then test the system for proper operation.

## TROUBLESHOOTING

If there is a problem with the treadmill, cycle the power by turning the circuit breaker off and then back on; this may eliminate the fault. If problems persist, refer to the Troubleshooting Guide at the end of this chapter. Problems beyond the scope of this table may require service assistance to isolate and correct. Contact StairMaster Technical Service at 800-331-3578 or 425-823-1825.

- Servicing should be done only by qualified service personnel who should consult the service manual before attempting any in-depth troubleshooting.



### WARNING

DO NOT REMOVE THE TREADMILL HOOD: DANGEROUS VOLTAGES ARE PRESENT. COMPONENTS ARE SERVICEABLE ONLY BY QUALIFIED SERVICE PERSONNEL.

## ERROR CODES

### The ClubTrack 510/612 Treadmill

The controller will report various error messages in the display window. The total amount of errors will be displayed in the upper right window. Note that only the highest priority reported error will be displayed.

Errors are handled in two ways. One as a non-fatal "WARNING" which will display the text message but continue system operation until you press the [CLEAR] key. The second is a fatal "ERROR" which will stop the exercise and return the system to an idle state. The controller will display the error text and not let you restart the program unless power has been turned off and then back on.

# TROUBLESHOOTING

## Self-Test Errors

<u>DISPLAY</u>	<u>EXPLANATION</u>
"ALU ERROR"	Treadmill self-test failure <ul style="list-style-type: none"><li>• Stops operation at start up</li><li>• Replace controller</li></ul>
"TIMER ERROR"	Treadmill self-test failure <ul style="list-style-type: none"><li>• Stops operation at start up</li><li>• Replace controller</li></ul>
"STATIC RAM ERROR"	Treadmill self-test RAM chksum failure <ul style="list-style-type: none"><li>• Stops operation at start up</li><li>• Replace controller</li></ul>
"EEPROM ERROR"	Treadmill self-test EEPROM chksum failure <ul style="list-style-type: none"><li>• Stops operation at start up</li></ul>
"PROGRAM ERROR"	Treadmill self-test Program Memory chksum failure <ul style="list-style-type: none"><li>• Stops operation at start up</li></ul>

## Operation Error Codes

<u>DISPLAY</u>	<u>EXPLANATION</u>
"GRD LIMIT ERROR"	Treadmill grade position outside limits <ul style="list-style-type: none"><li>• Press [CLEAR] to continue workout</li><li>• Same as E201 on the 510/612 Plus treadmills</li></ul>
"GRD MOVE ERROR"	Treadmill grade system detected unrequested response <ul style="list-style-type: none"><li>• Press [CLEAR] to continue workout</li><li>• Same as E211 on the 510/612 Plus treadmills</li></ul>
"SYS OVRLD ERROR" <sup>1</sup>	Treadmill high drive overload <ul style="list-style-type: none"><li>• Treadmill goes to idle and stops slowly</li><li>• Same as E203 on the 510/612 Plus treadmills</li></ul>
"BELT OVRLD ERROR" <sup>2</sup>	Treadmill moderate drive overload <ul style="list-style-type: none"><li>• Press [CLEAR] to continue workout</li><li>• Same as E207 on the 510/612 Plus treadmills</li></ul>

## TROUBLESHOOTING

"CS HW COM ERROR"	C.S.A.F.E. UART hardware link failure <ul style="list-style-type: none"><li>• Stops C.S.A.F.E. , but continues user selection</li><li>• Press [CLEAR] to continue workout</li></ul>
"CS COM ERROR"	C.S.A.F.E. communication failure <ul style="list-style-type: none"><li>• Stops C.S.A.F.E. , but continues program</li><li>• Press [CLEAR] to continue workout</li></ul>
"POWER LOSS"	System shut off while belt was active <ul style="list-style-type: none"><li>• Event logged on power up - no system impact</li></ul>
"TM HW COM ERROR"	UART hardware link failure <ul style="list-style-type: none"><li>• Treadmill goes to idle and slowly stops</li></ul>
"TM COM ERROR"	Drive communication failure <ul style="list-style-type: none"><li>• Treadmill goes to idle and slowly stops</li><li>• Same as E204 on the 510/612 Plus treadmills</li></ul>
"DRIVE ERROR"	Treadmill output switching fault <ul style="list-style-type: none"><li>• Treadmill goes to idle and stops quickly</li><li>• Same as E204 on the 510/612 Plus treadmills</li></ul>
"OUT CUR ERROR"	Treadmill output current too low <ul style="list-style-type: none"><li>• Treadmill goes to idle and stops slowly</li><li>• Same as E208 on the 510/612 Plus treadmills</li></ul>
"DRV MON ERROR"	Treadmill current monitoring circuit failure <ul style="list-style-type: none"><li>• Treadmill goes to idle and stops slowly</li><li>• Same as E210 on the 510/612 Plus treadmills</li></ul>
"DRV RESET"	Treadmill or controller micro-controller received an inadvertent reset <ul style="list-style-type: none"><li>• Treadmill goes to idle and stops quickly</li></ul>

# TROUBLESHOOTING

"CONFIG RORD"	<ul style="list-style-type: none"><li>• Same as E206 on the 510/612 Plus treadmills</li></ul> Treadmill software not configured to current machine type <ul style="list-style-type: none"><li>• Stops operation until the machine is configured</li><li>• Same as E212 on the 510/612 Plus treadmills</li></ul>
"SPD CHANGE ERROR"	Treadmill drive is commanded to change speed, but doesn't <ul style="list-style-type: none"><li>• Treadmill goes to idle and stops slowly</li></ul>
"SPD MON ERROR"	Should not occur, but can be tripped under obscure conditions <ul style="list-style-type: none"><li>• Treadmill goes to idle and stops slowly</li><li>• Same as E202 and E205 on the 510/612 Plus treadmills</li></ul>

---

<sup>1</sup> Remove drive belt and check motor for operation. If motor runs without error code, replace belt and turn over or replace deck.

<sup>2</sup> Non-fatal code (does not stop treadmill) which indicates walkbelt/deck is nearing end of life or a person exceeding treadmill capacity has used it. Frequent observations of this indicate walkbelt/deck should be replaced.

## The ClubTrack 510/612 Plus Treadmill

The controller displays an error message (the letter E followed by three digits) if it detects a problem in the system. If an error occurs during operation, the treadmill decelerates and the walking belt stops.

- The E201 and E207 error codes permit the treadmill to keep running (press [CLEAR] to clear these error codes). For E201 and E211, no further grade movement is allowed until Power is cycled.

The error code remains on the display until the power is turned off. If an error code appears, record the code number, then press [POWER] twice to recycle the power. If the error persists, call StairMaster Technical Service 1-800-331-3578.

### Self-Test Errors

Code	Explanation
E001	Treadmill CPU chip failure
E002	Treadmill CPU EPROM/SRAM failure
E003	Treadmill CPU stuck interrupt
E004	Treadmill CPU A/D failure
E005	Drive communications data error
E101	Controller CPU chip failure
E102	Controller CPU EPROM failure
E103	Controller CPU stuck interrupt
E104	Communications packet error
E105	Controller CPU NVRAM failure
E107	External UART error
CP-	Indicates no configuration code has been programmed into the controller. A configuration code must be programmed into the controller before normal operation can begin.

### Operation Error Codes

Code	Explanation
E201	Grade system over limit error
E202	Speed check error
E203	High motor overload <sup>1</sup>
E204	The two micro-controllers are not communicating
E205	Software tachometer fault
E206	Treadmill or controller micro-controller received an inadvertent reset
E207	Moderate motor overload <sup>2</sup>
E208	Drive Under Current - no motor current detected
E209	Drive Switch Fault - the drive system switching circuitry has failed



## TROUBLESHOOTING

- E210 Current Sense Circuit Fault - the drive current sensing circuitry has failed
- E211 Grade Position Fault - the grade system has not changed after a grade command or has changed without being commanded to
  - E212 Controller and drive micro-controller configurations do not match
  - EPHI Internal motor supply voltage too high
  - EPLO Internal motor supply voltage too low

- 
- <sup>1</sup> Remove drive belt and check motor for operation. If motor runs without error code, replace belt and turn over or replace deck.
  - <sup>2</sup> E207 is a non-fatal code (does not stop treadmill) which indicates walkbelt/deck is nearing end of life or a person exceeding treadmill capacity has used it. Frequent observations of this indicate walkbelt/deck should be replaced.



## TRANSMITTER BELT

The Polar® system for heart rate detection and transmission has been time-tested and shown to be accurate and reliable. However, there is a small percentage of people for whom the system will not work. If all the steps in the following troubleshooting table are performed and the belt and controller are deemed to be operating correctly, the user's heart rate may not be detectable by the system.

### Troubleshooting the Transmitter Belt

PROBLEM	POSSIBLE CAUSE	REMEDY
Heart rate reading is erratic or absent	Poor electrode contact.	<ol style="list-style-type: none"> <li>1. Be sure logo on belt is facing out and that electrodes are flat against the skin.</li> <li>2. Moisten the electrodes again.</li> <li>3. Be sure the receiver is within range (32 in./81 cm).</li> <li>4. Wash belt.</li> </ol>
Heart rate is erratic or above 200	<ol style="list-style-type: none"> <li>1. Treadmills are too close together and are receiving signals from two users.</li> <li>2. Interference from other electromagnetic signals (T.V., computers, other belt transmitters, motors, etc.).</li> </ol>	<ol style="list-style-type: none"> <li>1. Move treadmills at least 18 in. (46 cm) apart.</li> <li>2. Move the treadmill away from the source of interference.</li> </ol>
No signal on controller	<ol style="list-style-type: none"> <li>1. No electrode contact.</li> <li>2. Faulty chest belt.</li> <li>3. Transmitter battery worn out.</li> <li>4. Faulty controller.</li> <li>5. ClubTrack 510/612: check HR input selection.</li> </ol>	<ol style="list-style-type: none"> <li>1. Reposition chest belt, re-wet electrodes.</li> <li>2. Test signal using different belt transmitter. Replace old belt if faulty.</li> <li>3. Replace transmitter.</li> <li>4. Test belt transmitter with a different treadmill. If the belt transmitter is working correctly, replace controller.</li> <li>5. Heart rate signal detection is turned off, turn on "Locked Inputs."</li> </ol>

# TROUBLESHOOTING

## TROUBLESHOOTING THE TREADMILL

PROBLEM	POSSIBLE CAUSE	REMEDY
Treadmill does not run, error message does not appear	Circuit breaker on treadmill hood is OFF	Set treadmill circuit breaker to ON.
	Treadmill power cord not plugged in.	Plug in power cord, then set treadmill circuit breaker to ON.
	Limited-access magnet not in place	Place magnet over StairMaster logo on the controller; or, deactivate the magnetic switch
	No power at wall outlet	Check building circuit breaker.
	Internal problem	Call service representative.
Treadmill does not run, Error message is shown on 510/612 display, "E" appears on 510/612 Plus display.	Problem with electronic circuitry	Record the error message/number and call service representative
Walking belt is too far left or right	Improper belt tracking	Adjust tracking
Walking belt slips, but front roller turns	Improper belt tension	Call service technician
Walking belt hesitates; adjusting walk belt tension is ineffective	Internal drive belt slipping	Call service technician



## TROUBLESHOOTING

<b>PROBLEM</b>	<b>POSSIBLE CAUSE</b>	<b>REMEDY</b>
Treadmill will not change grade	Excess weight on treadmill.	See Appendix for rated load.
	Internal problem	Call service representative.
Treadmill will not reach maximum speed	Speed limit control may be activated	See "Speed Limit Control."
Treadmill will not reach maximum time	Time limit control may be activated	See "Time Limit Control."
Circuit breaker trips during normal operation	Power fault	Call service representative.
Error messages appear on controller	Varied	Call service representative.

# SPECIFICATIONS

## TREADMILL FRAME

### Performance

<u>Maximum Rated Load</u>	400 lb (181.4 kg)
<u>Belt Speed Range ± 0.2 mph (continuously adjustable)</u>	
ClubTrack 510/510 Plus	1.0 to 10.0 mph (1.6 to 16.0 km/h)
ClubTrack 612/612 Plus	1.0 to 12.0 mph (1.6 to 19.0 km/h)
<u>Grade Range ± 0.5%</u>	
ClubTrack 510/510 Plus	0 to 12%
ClubTrack 612/612 Plus	0 to 15%

### Physical

<u>Weight</u>	
ClubTrack 510/510 Plus	345 lb (157 kg)
ClubTrack 612/612 Plus	355 lb (161 kg)
<u>Nominal Walking Surface</u>	
ClubTrack 510/510 Plus	20 in. x 55 in.
ClubTrack 612/612 Plus	20 in. x 60 in.
<u>Dimensions (width x length x height)</u>	
ClubTrack 510/510 Plus	31.5 in. x 83. in. x 51.5 in. (80.0 cm x 210.8 cm x 130.8 cm)
ClubTrack 612/612 Plus	31.5 in. x 88. in. x 51.5 in. (80.0 cm x 223.5 cm x 130.8 cm)
<u>Walking Surface Height from floor</u>	7.75 in. (19.7 cm)
<u>Handrail Ht from walking surface</u>	38.5 in. (97.8 cm)

### Environmental

<u>Temperature</u>	Operating: 50 to 90 ° F (10 to 32 ° C) Storage: -13 to 122 ° F (-25 to 50 ° C)
<u>Humidity (non-condensing)</u>	Operating: 3 to 95% relative Storage: 3 to 95% relative *Limited to 90 ° F maximum dew point
<u>Atmospheric Pressure</u>	Operating: 8.60 to 15.0 psia, 445 to 775 mm Hg absolute Shipping & storage: 8.22 to 15.0 psia, 425 to 775 mm Hg absolute

# SPECIFICATIONS

## Power Requirements

Dash No.	Voltage (Min-max)/Hertz	Current Draw (Amps)	Min. Branch Circuit Amps
-001, -005	99-132 V, 50/60 Hz	16	20
-002	198-264 V, 50/60 Hz	10	15
-003, -004, -006, -007, -008, -011, -012, -013, -014, -015	198-264 V, 50/60 Hz	10	10
-009	90-132 V, 50/60 Hz	20	20
-010	180-264 V, 50/60 Hz	10	10

\* -002 (Domestic 220 V units) must be connected to 240 V 60 Hz center-tapped single phase or 208 V 60 Hz two-line polyphase power.

# SPECIFICATIONS

## Fuse Ratings

Fuse Designation	Used on Dash No.	Fuse Rating and Type
F1	-001, -005, -009	2.5A 250V Time-lag IEC127 Sheet III (5x20mm)
	-002, -003, -004, -006, -007, -008, -010, -011, -012, -013, -014, -015	2A 250V Time-lag IEC127 Sheet III (5x20mm)
F2	-001, -005, -009	2A 250V Time-lag IEC127 Sheet III (5x20mm)
	-002, -003, -004, -006, -007, -008, -010, -011, -012, -013, -014, -015	1.6A 250V Time-lag IEC127 Sheet III (5x20mm)
F3,F4	-001, -005, -009	400mA 250V Time-lag IEC127 Sheet III (5x20mm)
	-002, -003, -004, -006, -007, -008, -010, -011, -012, -013, -014, -015	400mA 250V SuperTime-lag (5x20mm)

## CONTROLLER SPECIFICATIONS

### ClubTrack 510/612 Treadmill

LCD Display (Displays workout mode, exercise parameters, weight, time, and error messages)

#### Speed

Units	Miles per hour (mph) or kilometers per hour (km/h)
Range	ClubTrack 510: 1.0 to 10 mph (1.6 to 16.0 km/h) ClubTrack 612: 1.0 to 12 mph (1.6 to 19.2 km/h)
Increment	0.1 mph, 0.16 km/h
Accuracy	Within $\pm 0.2$ mph (0.32 km/h) of actual speed during unchanging operation. Shows actual speed during speed changes.

# SPECIFICATIONS

## Grade

Units	%
Range	ClubTrack 510: 0 to 12% ClubTrack 612: 0 to 15%
Increment	0.5%
Accuracy	Within $\pm 0.5\%$ actual grade during unchanging operation

## Time

units:	min:sec
range:	00:00 to 99:59

## Elapsed Distance

units:	miles or kilometers
range:	0 to 99.9 miles or kilometers

## Pace

Units:	minutes:seconds per mile or minutes:seconds per kilometer
range:	5:00 to 60:00 min:sec/mile or 3:07 to 37:16 min:sec/kilometer

## Calories<sup>1</sup>

Units	calories or calories/hour
Caloric Rate <sup>1</sup>	range: 1 to 9999

## METs<sup>1</sup>

range:	0.01 to 99.9
--------	--------------

## Heart Rate

50 to 200 BPM (beats per minute) - values above and below these are filtered out

## Vertical Feet

range: 1 to 9999 ft

## Watts

range: 0.1 to 999.9

## Continuous Scan

Cycles through parameters, displaying each sequentially for three seconds.

## Weight

default:	175 lb (80 kg)
minimum:	30 lb (13 kg)
maximum:	400 lb (181 kg)
increment:	1 (lb or kg)

## Target Heart Rate

default:	126 BPM
minimum:	80 BPM
maximum:	200 BPM
increment:	1 BPM

# SPECIFICATIONS

<u>Exercise Time</u>	default: 20 min minimum: 8 min (programs), 1 min (other) maximum: none or owner-set
<u>Serial Interface</u>	RS-232, complies with enhanced CSAFE standard for external computer interface

---

<sup>1</sup>MET and Caloric rate expenditure calculated based on formulas written by the American College of Sports Medicine in Guidelines for Exercise Testing and Prescription, published by Lea & Febiger.

## ClubTrack 510/612 Plus Treadmill

LCD Display (Displays workout mode, exercise parameters, weight, time, and error messages)

### Speed

units:	miles per hour (mph) or kilometers per hour (km/h)
range:	ClubTrack 510 Plus: 1.0 to 10.0 mph (1.6 to 16.0 km/h) ClubTrack 612 Plus: 1.0 to 12 mph (1.6 to 19.2 km/h)
increment:	0.1 mph, 0.16 km/h
accuracy:	Within $\pm 0.2$ mph (0.32 km/h) of actual speed during unchanging operation, 1 mph (1.6 km/h) during speed decrease. Shows target, not actual, speed during speed changes.

### Grade

units:	%
Range	ClubTrack 510 Plus: 0 to 12% ClubTrack 612 Plus: 0 to 15%
increment:	0.5%
accuracy:	Within $\pm 0.5\%$ actual grade during unchanging operation

### Time

units:	hr:min:sec
range:	0:00:00 to 9:59:59



## SPECIFICATIONS

### Elapsed Distance

units: miles or kilometers  
range: 0 to 99.9 miles or kilometers

### Pace

units: min:sec/mile or min:sec/kilometer  
range: 6:00 to 60:00 min:sec/mile (3:43 to 37:16 min:sec/kilometer)

### Calories<sup>1</sup>

units: calories or calories/minute  
range: 0.1 to 9999  
Caloric Rate<sup>1</sup> 0.1 to 99.9 cal/min

### METS<sup>1</sup>

range: 1.0 to 99.9

### Heart Rate

50 to 200 BPM (beats per minute) - values above and below these are filtered out  
range: 1 to 42,949 ft (13,091 m)

### Vertical Feet

### Watts

range: 1 to 9999

### Continuous Scan

Cycles through speed/grade graph, workout graph, heart graph, and exercise parameters  
default: 175 lb (80 kg)

### Weight

minimum: 30 lb (13 kg)  
maximum: 400 lb (181 kg)  
increment: 1 (lb or kg)

### Target Heart Rate

default: 140 BPM  
minimum: 80 BPM  
maximum: 200 BPM  
increment: 1 BPM

### Exercise Time

default: 20 min  
minimum: 8 min (programs), 1 min (other)  
maximum: none or owner-set

### Serial Interface

RS-232, complies with CSAFE standard for external computer interface











---

<sup>1</sup>MET and Caloric rate expenditure calculated based on formulas written by the American College of Sports Medicine in Guidelines for Exercise Testing and Prescription, published by Lea & Febiger.







# SPECIFICATIONS

## SYMBOLS AND LABELS

StairMaster products display one or more of the following symbols and warning labels for your protection. No single product displays all.

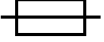
<p><b>Caution</b></p> 	<p>Attention: Consult accompanying documents</p>		<p>Earth ground (protective)</p>
	<p>Off (power disconnected from mains)</p>		<p>Type B equipment - provides adequate protection against electric shock, particularly regarding allowable leakage current; reliability of the protective earth connection (when present)</p>
	<p>On (power connected to mains)</p>		<p>Type BF equipment - contains an F-type isolated patient applied part providing a high degree of protection against electric shock</p>
	<p>Alternating current</p>		<p>Type BF equipment with defibrillation protection</p>
	<p>High voltage</p>		<p>Type CF equipment - contains an F-type isolated patient applied part and provides a degree of protection against electric shock higher than that for type BF equipment regarding allowable leakage currents</p>

# SPECIFICATIONS

	Earth ground (functional)		Type CF equipment with defibrillation protection
	Replace fuse only as marked		Fuse
	Mains power		Equipotentiality
	Warning	<b>T</b>	Timed fuse (slo-blo)
<b>Hz</b>	Hertz	<b>V</b>	Volts
<b>A</b>	Amperes	<b>VA</b>	Volt Amperes



## IMPORTANT PHONE NUMBERS

If you need assistance, please have both the serial number of your machine and the date of purchase available when you contact the appropriate StairMaster® Health & Fitness Products, Inc. office listed below.

### OFFICES IN THE UNITED STATES

#### CORPORATE HEADQUARTERS

12421 Willows Road NE, Suite 100  
Kirkland, WA 98034  
(800) 635-2936 or (425) 823-1825  
FAX: (425) 823-9490  
www.stairmaster.com

#### CUSTOMER SERVICE

12421 Willows Road NE, Suite 100  
Kirkland, WA 98034  
(800) 331-3578 or (425) 823-1825  
FAX: (425) 814-0601  
E-mail: customerservice@  
stairmaster.com

### INTERNATIONAL OFFICES AND DISTRIBUTORS

For technical assistance and a list of distributors in your area, please call or fax one of the following numbers.

#### INTERNATIONAL DIVISION

(425) 823-1825  
FAX: (425) 820-7505  
E-Mail: intlservice@stairmaster.com

#### ASIA PACIFIC HEADQUARTERS

Telephone/Fax: +81-45-590-5686  
E-mail: stairintl@aol.com

#### EUROPE: HEADQUARTERS

+41-91-827-3801  
FAX: +41-91-827-8902  
E-Mail: stairmasterch@swissonline.ch

#### GERMANY: HEADQUARTERS

+49-2204/610-27  
FAX: +49-2204/628-90  
E-Mail: stairmaster.de@t-online.de

#### U.K.: HEADQUARTERS

+44-1908/267-345  
FAX: 44-1908/267-346  
E-mail: stairmasteruk@msn.com