



MANHATTAN
COMFORT

ASSEMBLY INSTRUCTIONS

INSTRUCCIONES DE MONTAJE

NOTICE DE MONTAGE

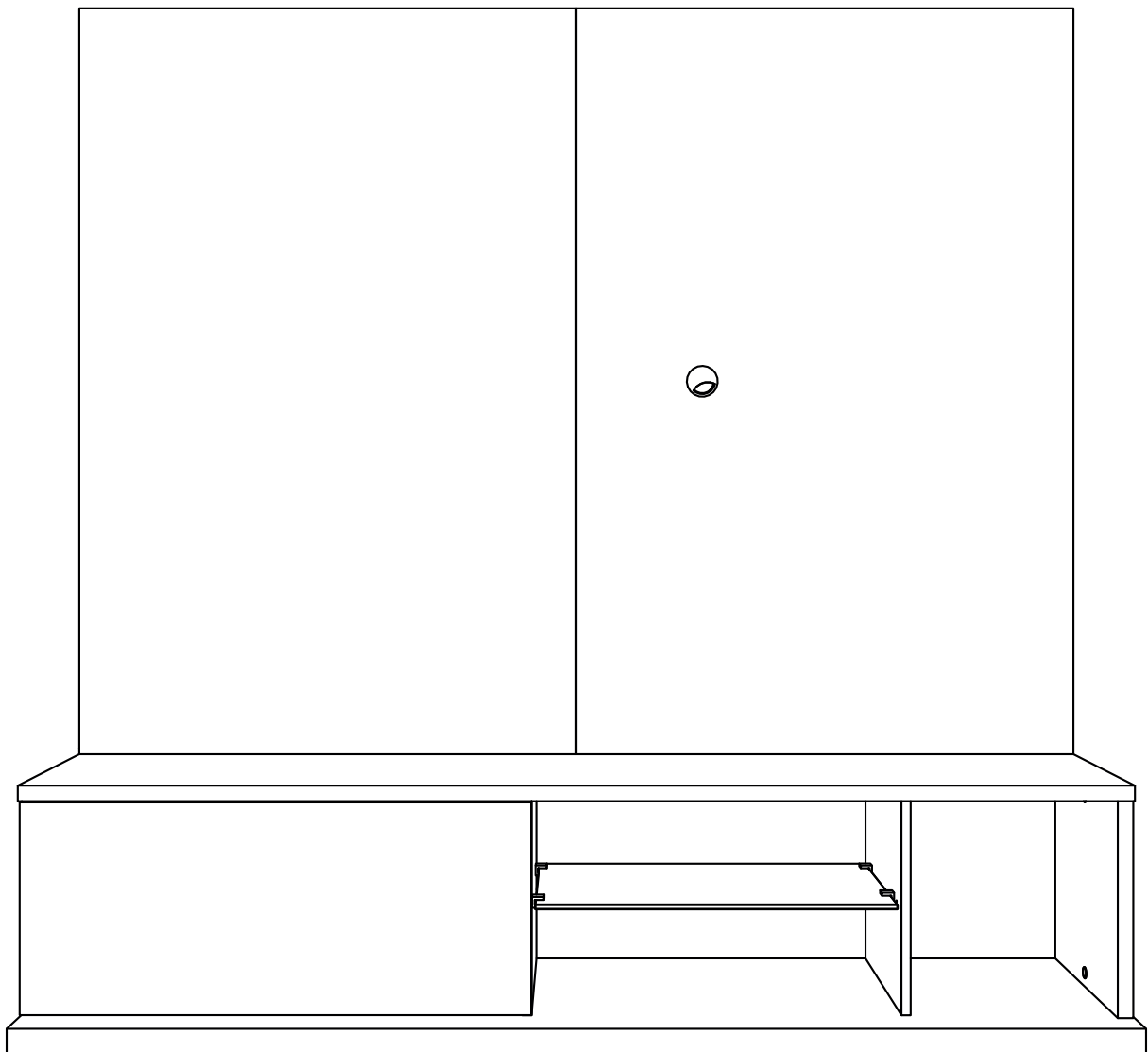

COD BR: 400700

REV. 01 - 02/04/20

STICKER-18x
ADHESIVO-18x
AUTOCOLLANT-18x

COD. 1668-16x



B

COD. 9425-2x

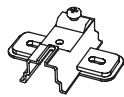

C

COD. 8903-2x

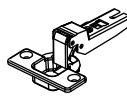

D

COD. 2014-3x

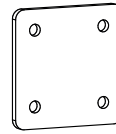

E

COD. 4157-5x

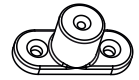

F

A

WIRE CHANNEL - 1x
PASA EL CABLE - 1x
PASSE-CÂBLES - 1x

COD. 0357



G

SUPORT TV - 1x

APOYO DE TV - 1x

SUPPORT MURAL POUR TV-1



H

COD. 0348-1x



J

COD. 2088-10x



K

COD. 0607-8x



L

COD. 9070-5x

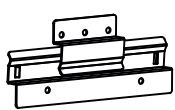

M

COD. 4439-4x

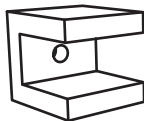

N

COD. 10063-8x



O

COD. 9895-8x

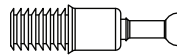

P

COD. 2762-1x

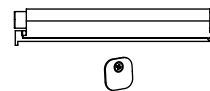

Q

COD. 10084-1x

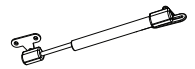

R

COD. 1533-8x



S

COD. 7519-8x



T

COD. 3557-3x

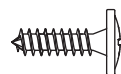

U

COD. 3706-12x

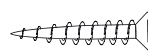

V

COD. 1861-8x



X

COD. 6244-12x



Z

VIDRO
 VIDRIO
 GLASS

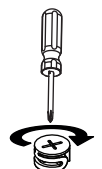
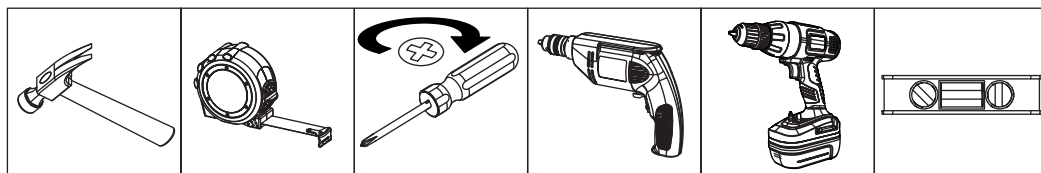

DESCRIPTION

DESCRIPCIÓN

DESCRIPTION

W:70.86 inches H:70.15 inches D: 17.32 inches

L:1800mm A:1782mm P:440mm



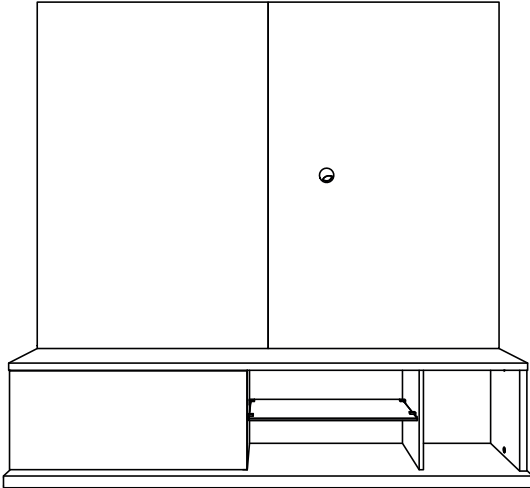



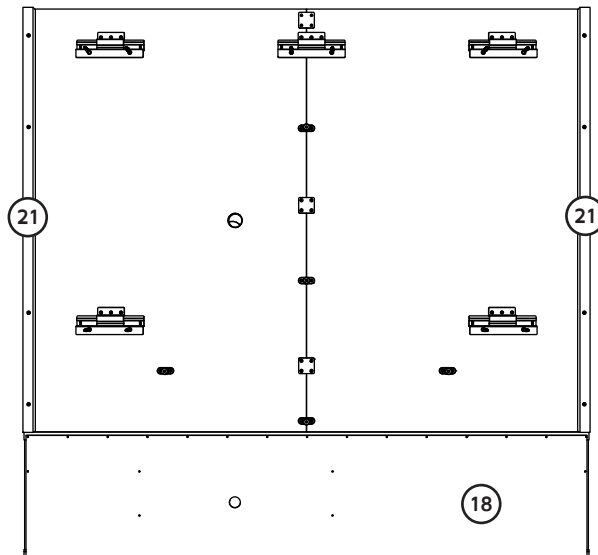
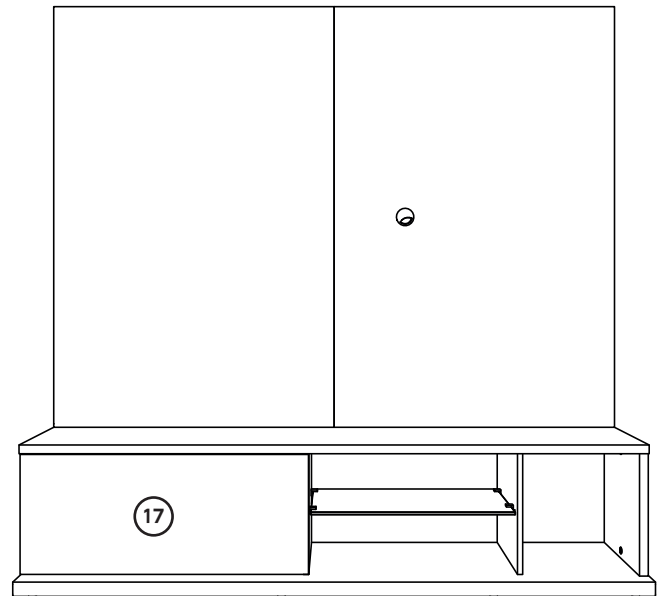
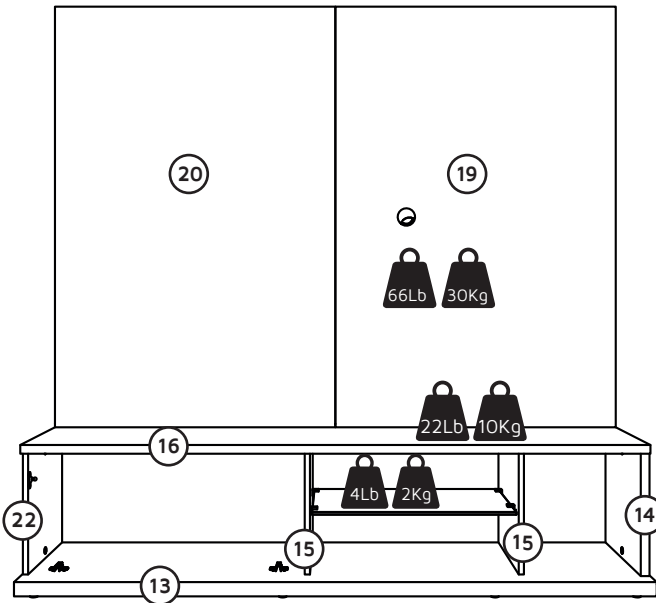



L:1800mm H:1782mm P:440mm



CÓD:400700					
PART PIEZA PIÈCE	QUANTITY CANTIDAD QUANTITÉ	DESCRIPTION	DESCRIPCIÓN	DESCRIPTION	BOX CAJA BOÎTE
13	01	BASE	BASE	BASE	01
14	01	SIDE	LATERAL	CÔTÉ	01
15	02	INTERNAL SIDE	LATERAL INT.	CÔTÉ INTÉRIEUR	01
16	01	TOP BOARD	CUBIERTA	PLATEAU	01
17	01	DOOR	PUERTA	PORTE	01
18	01	BACKPLATE	FONDO	FOND	01
19	01	PANEL RIGHT	PANEL DERECHO	PANNEAU DROIT	02
20	01	PANEL LEFT	PANEL IZQUIERDO	DROIT GAUCHE	02
21	02	SIDE BATTEN	SOPORTE LATERAL	LATTE LATÉRALE	02
22	01	SIDE	LATERAL	LATTES	01



01

COD. 9425 C 	COD. 2014 E 	COD. 4157 F 	COD. 0348 J 	COD. 0607 L 	COD. 9070 M 	COD. 9895 P 	COD. 7519 T 	COD. 3557 U 
COD. 3706 V 	COD. 1861 X 							

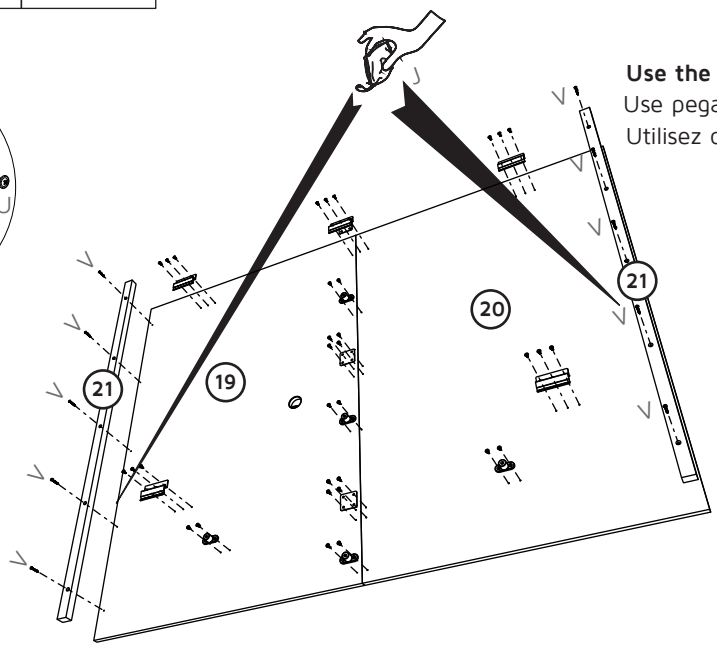
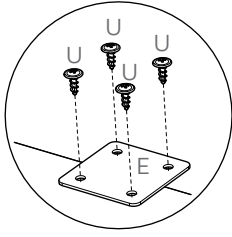
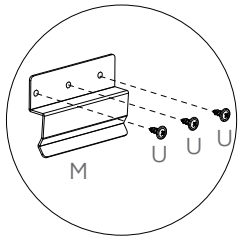

Use the PVA glue before screwing.
 Use pegamento PVA antes de atornillar.
 Utilisez de la colle PVA avant de visser.

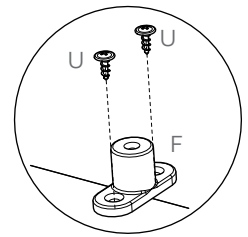

02

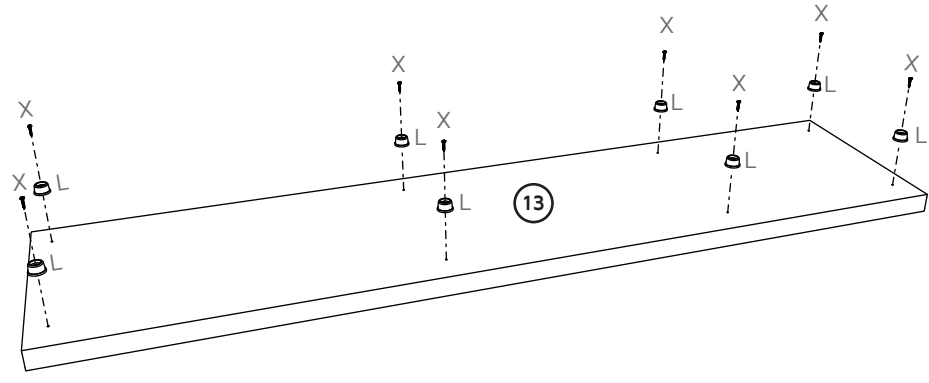

03

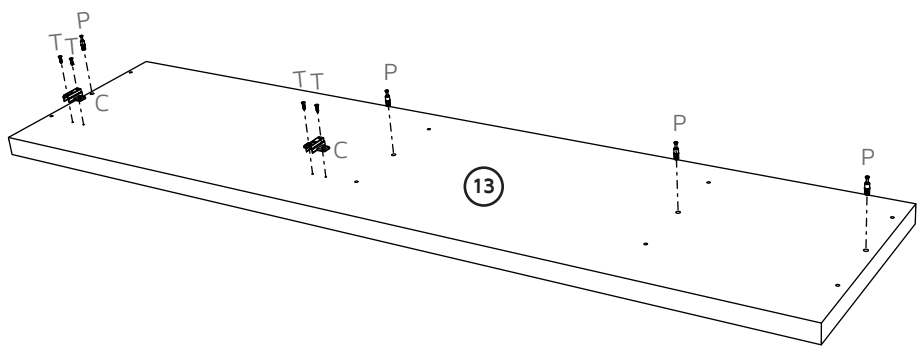

STICKER ADHESIVO AUTOCOLLANT A	COD. 1668 B	COD. 8903 D	COD. 0357 H	COD. 4439 N	COD. 10063 O	COD. 9895 P	COD. 10084 R	COD. 1533 S	COD. 7519 T
--	-----------------------	-----------------------	-----------------------	-----------------------	------------------------	-----------------------	------------------------	-----------------------	-----------------------

04

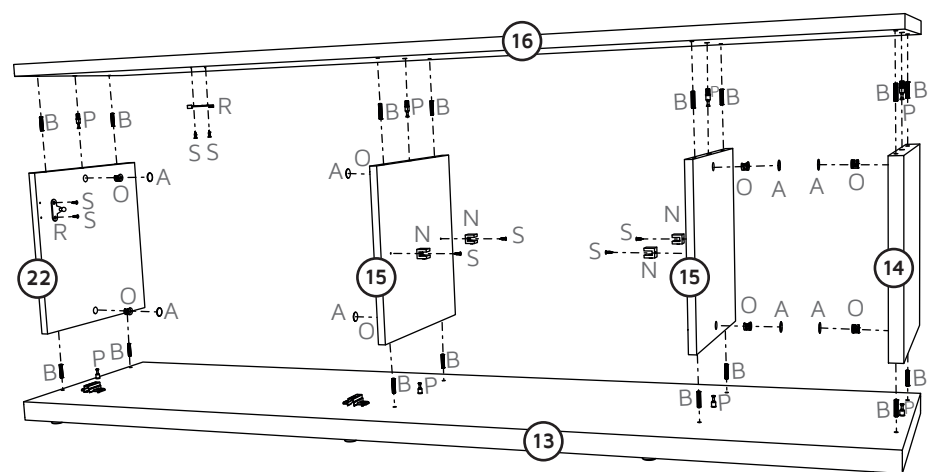

05

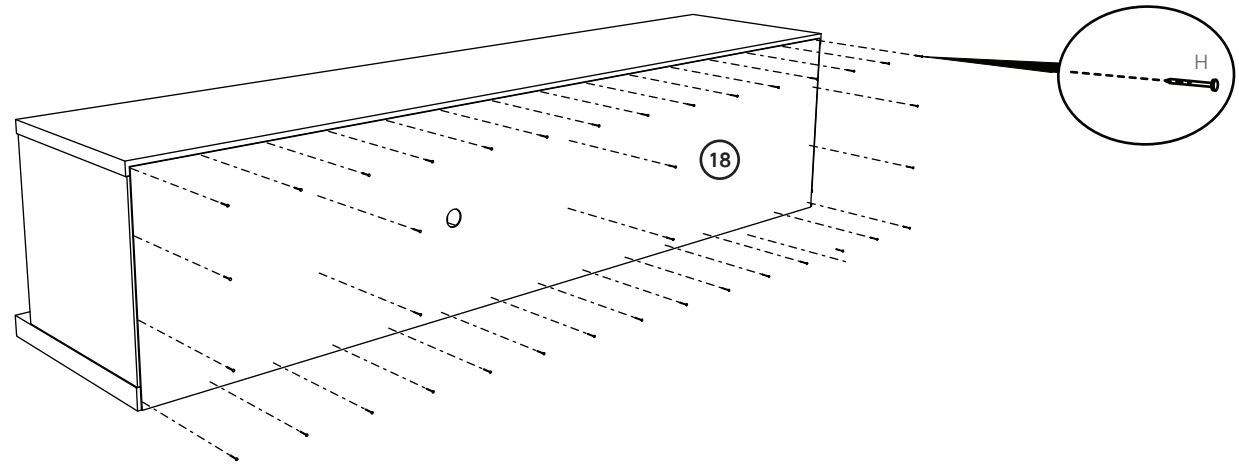

06

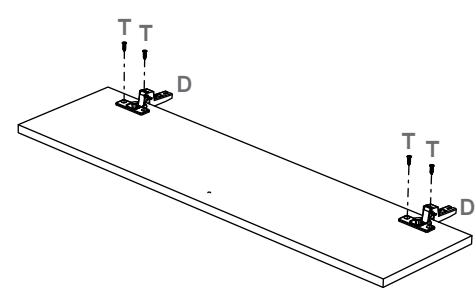
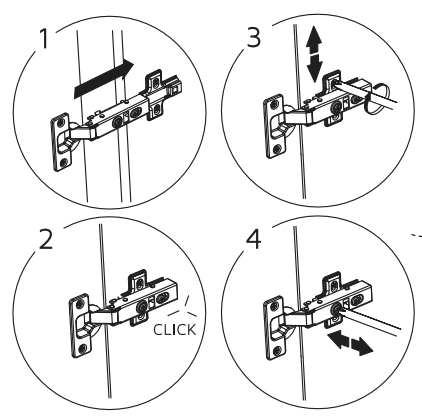
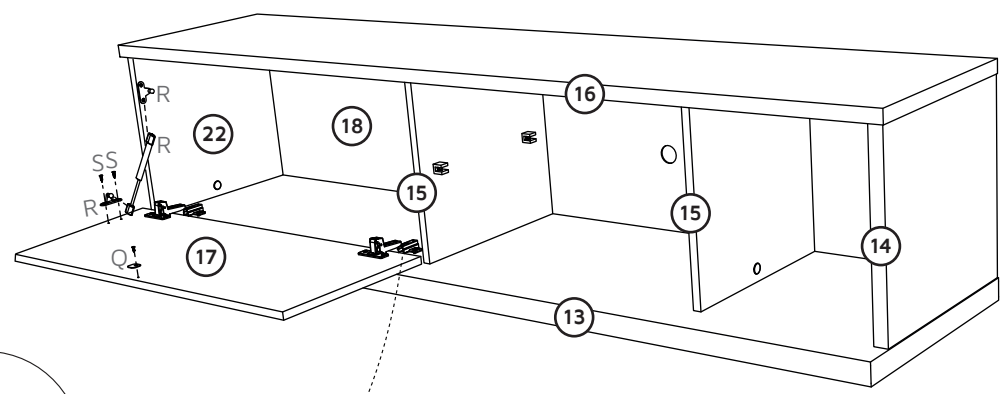

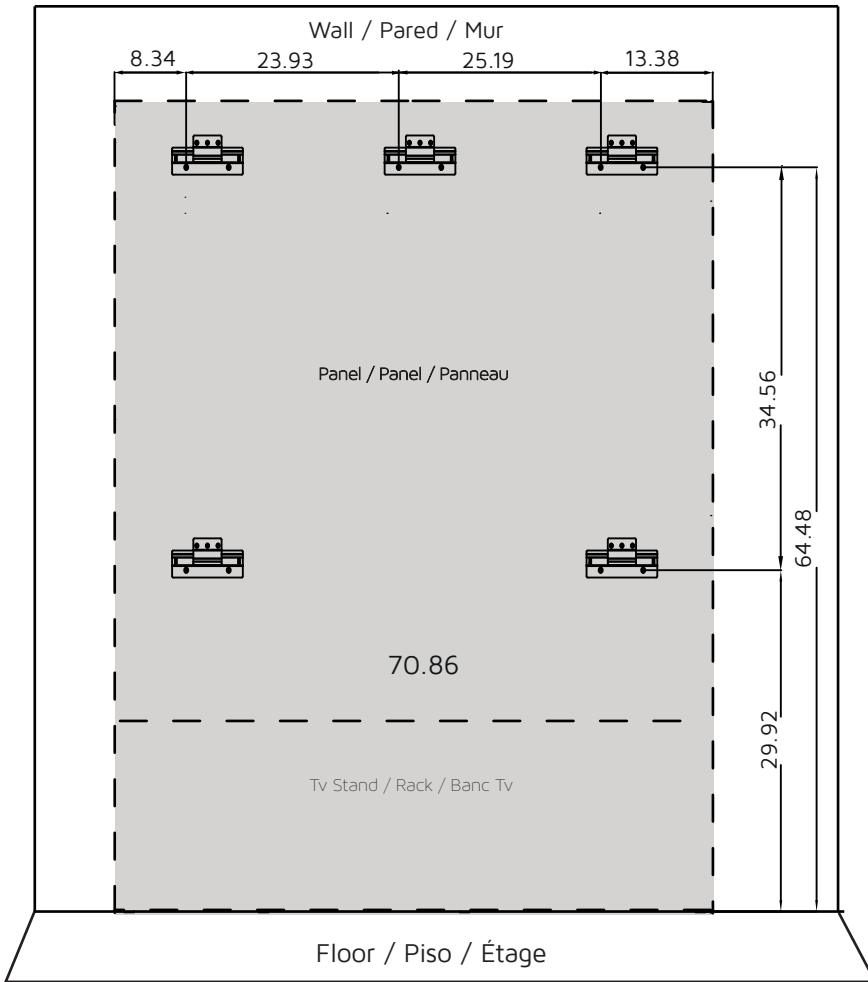
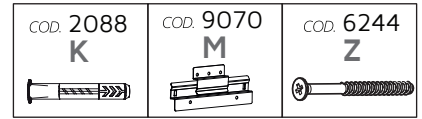

Measurement to drill the wall.
(em inches).

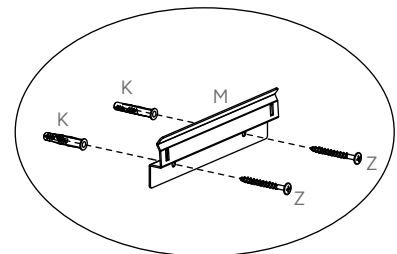
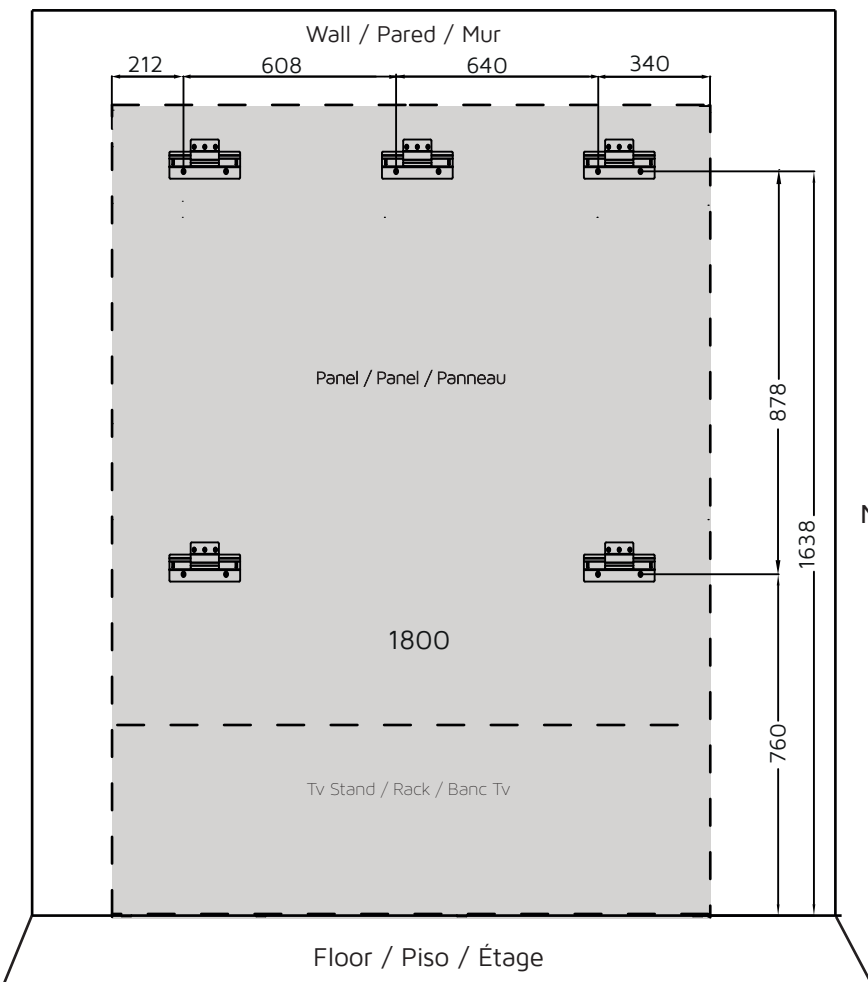
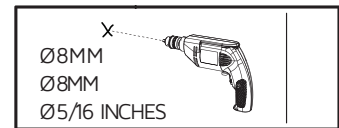
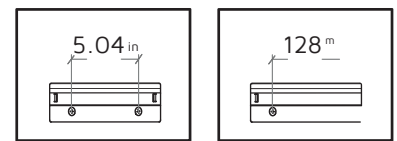

Medidas para realizar la perforación de la pared
(en milímetros).

Mesures pour percer le mur
(en millimètres).

10

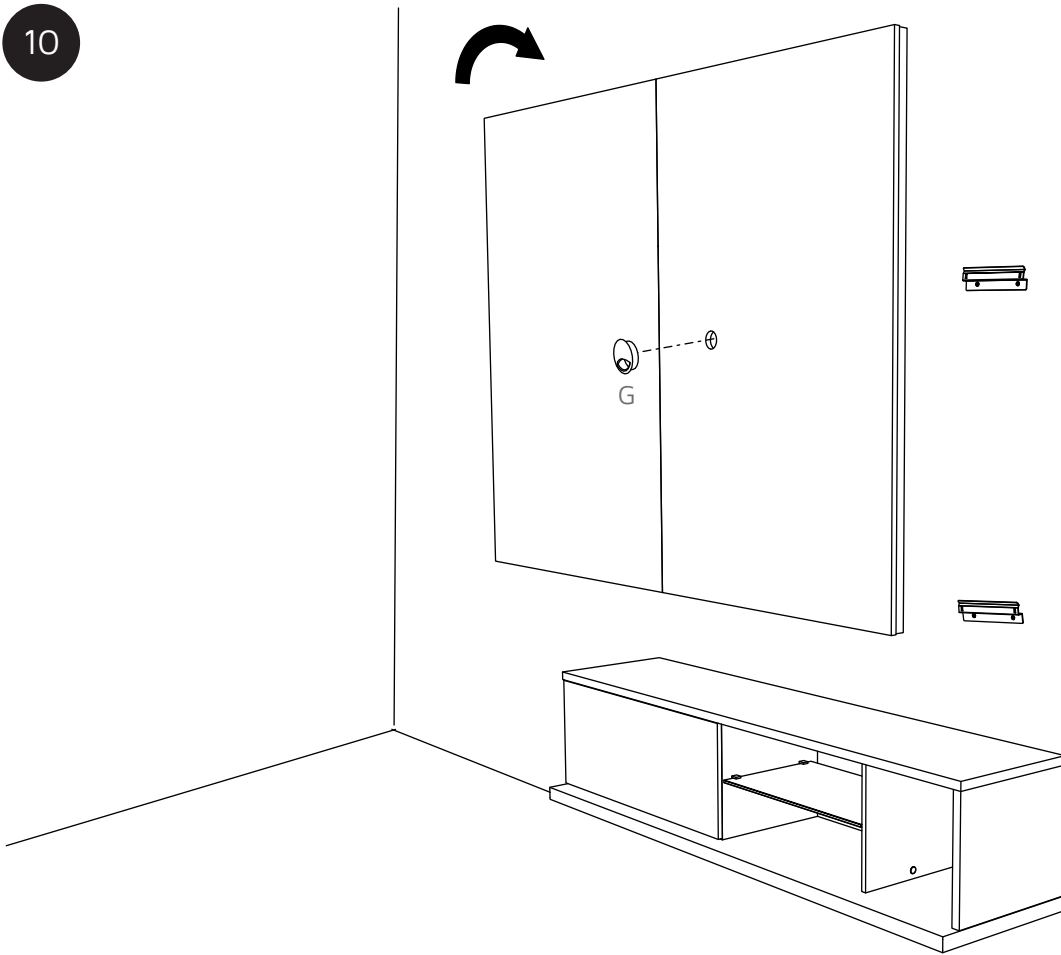

ATTENTION / ATENCIÓN / ATTENTION

Pass the cables through the back before Panel.

Lleve el cables antes de encajar el panel.

Acheminez les câbles avant de fixer le panneau.

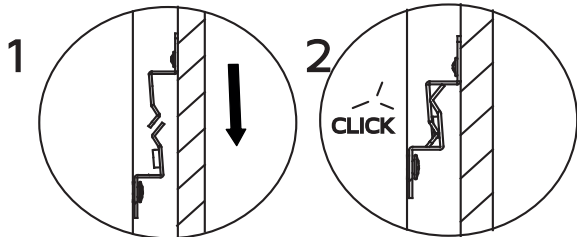



MANHATTAN
COMFORT

ASSEMBLY INSTRUCTIONS

INSTRUCCIONES DE MONTAJE

NOTICE DE MONTAGE

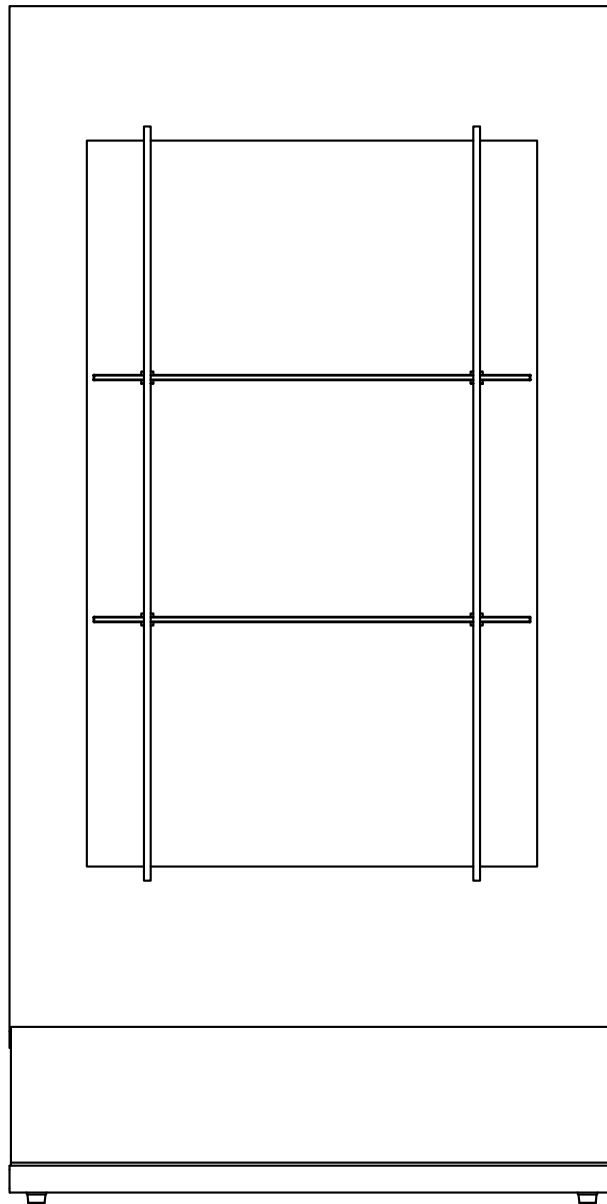

COD: 400600

COD. 1668-16x



B

COD. 2661-1x



C

COD. 0634-4x



D

COD. 2077-4x

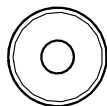

E

COD. 0357



F

LED-1x

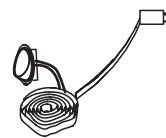

G

COD. 4439-4x

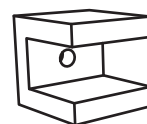

H

COD. 9070-4x

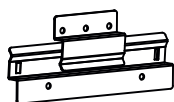

I

COD. 0607-4x



J

COD. 0348-1x



K

COD. 0338-2x



L

COD. 10063-4x



M

COD. 9895-4x



N

COD. 12190-4x



O

COD. 2088-8x



P

COD. 1533-12x



Q

COD. 8056-12x

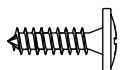

R

COD. 6533-4x



S

COD. 3557-12x



T

COD. 3706-10x

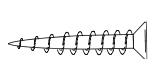

U

COD. 1861-4x



V

COD. 6244-8x



X

COD. 3527-4x

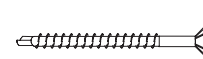

Z

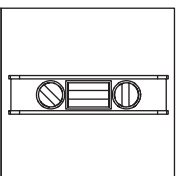
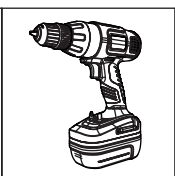
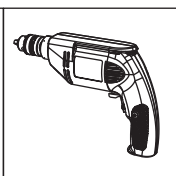
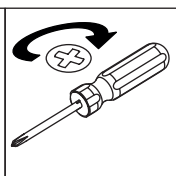
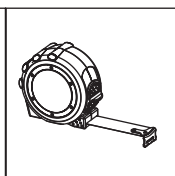
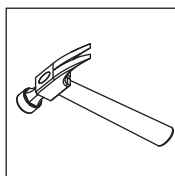



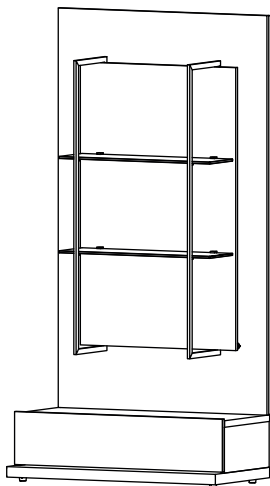

W:35.43 inches H:70.15 inches D: 18.03 inches
 L:900mm A:1782mm P:458mm
 L:900mm H:1782mm P:458mm

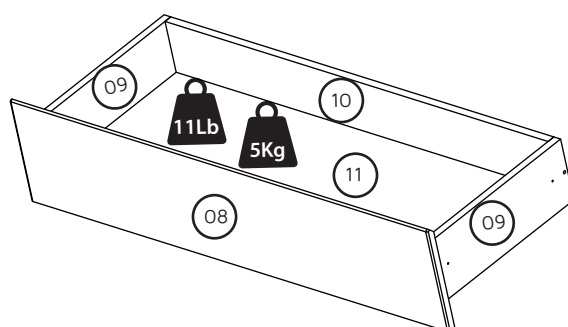
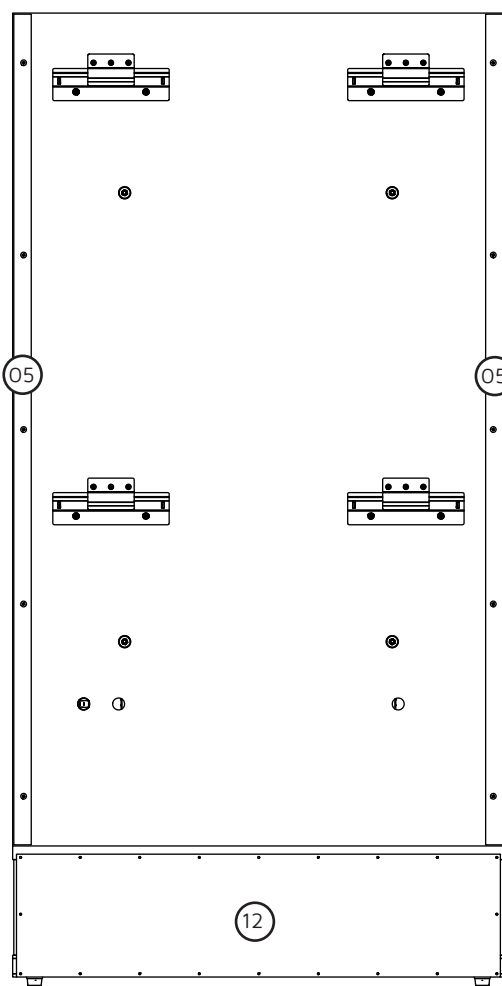
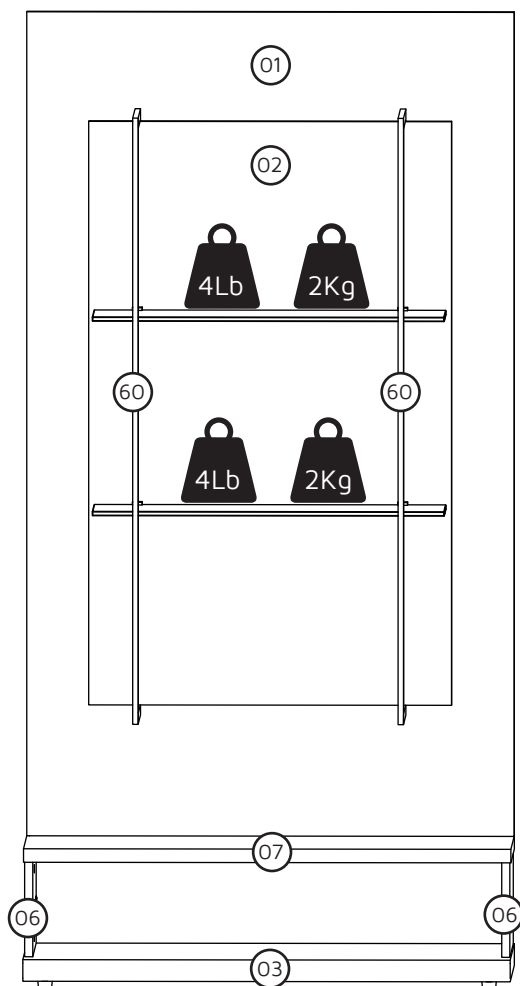

CÓD:400600					
PART PIEZA PIÈCE	QUANTITY CANTIDAD QUANTITÉ	DESCRIPCIÓN	DESCRIPTION	DESCRIPCIÓN	BOX CAJA BOÎTE
01	01	BACK PANEL	PANEL TRASERO	PANNEAU ARRIÈRE	01
02	01	FRONT PANEL	PANEL FRONTAL	PANNEAU AVANT	01
03	01	BASE	BASE	BASE	02
05	02	BACK SIDE BATTEN	SOPORTE LATERAL TRASERO	LATTE LATÉRALE DERRIÈRE	01
06	02	SIDE	LATERAL	CÔTÉ	02
07	01	TOP BOARD	CUBIERTA	PLATEAU	02
08	01	DRAWER FRONT	FRENTE DEL CAJÓN	FAÇADE DE TIROIR	02
09	02	DRAWER SIDE	LATERAL DEL CAJÓN	CÔTÉ DE TIROIR	01
10	02	DRAWER BACK PANEL	CAJÓN INFERIOR	DERRIÈRE DE TIROIR	01
11	01	DRAWER BOTTOM	FONDO DEL CAJÓN	FOND DE TIROIR	02
12	01	BACKPLATE	FONDO	FOND	02
60	02	STEEL BASE	BASE DE ACERO	BASE EN ACIER	03

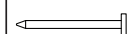

01

COD. 1668 B 	COD. 0357 F 	COD. 0607 J 	COD. 10063 M 	COD. 9895 N 	COD. 1861 V 
---	---	--	--	---	---

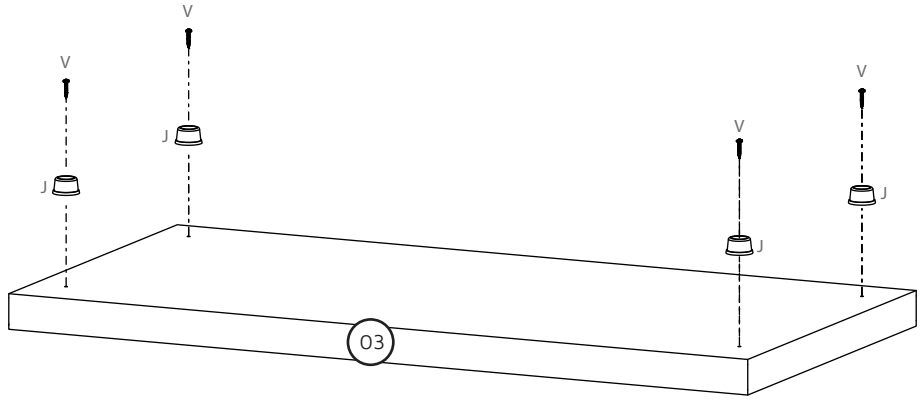



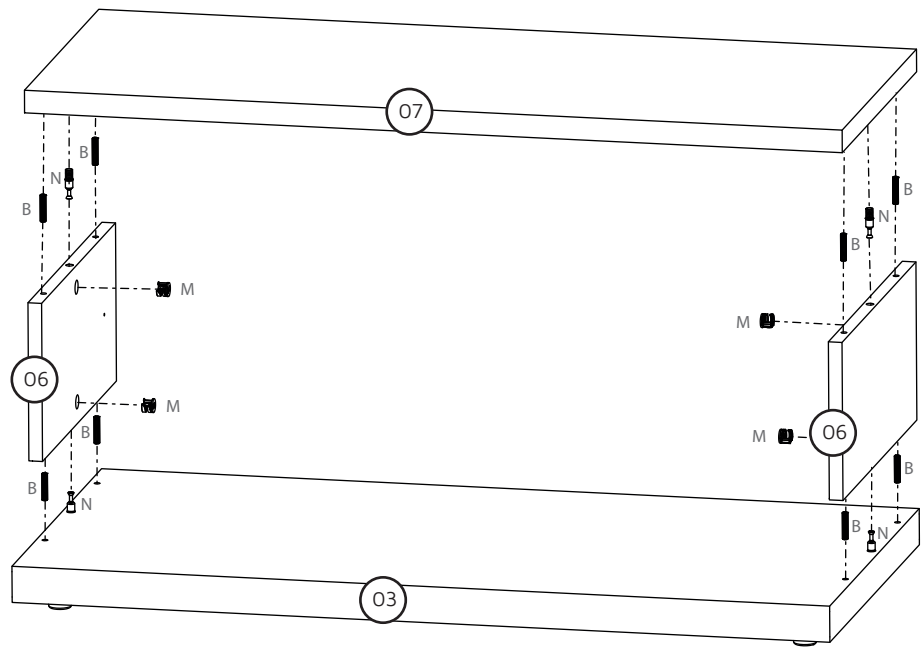

02

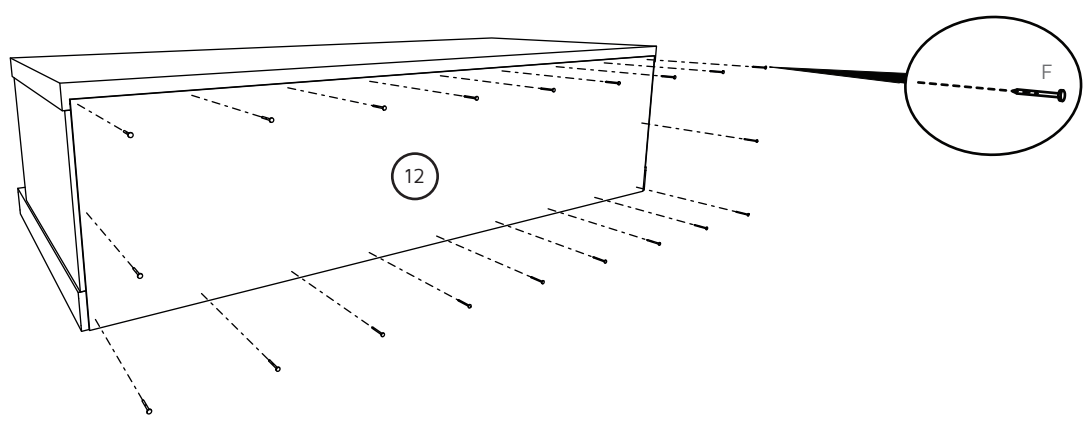

03

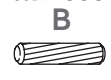

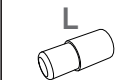
04

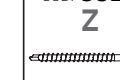
COD. 1668 B 	COD. 2661 C 	COD. 0338 L 	COD. 1533 Q 	COD. 6533 S 	COD. 3527 Z 
---	---	--	---	---	---

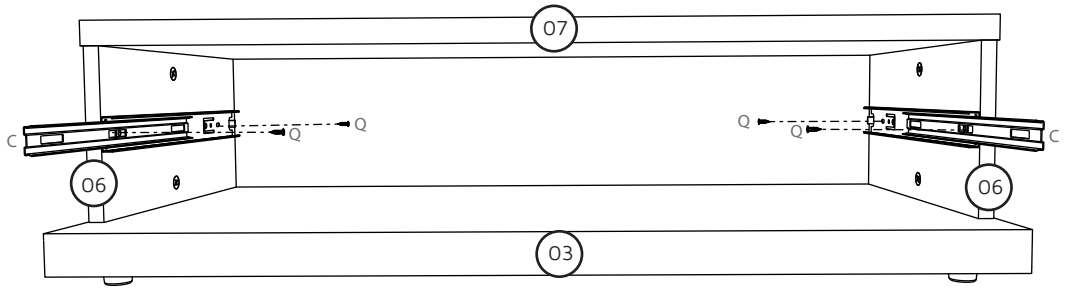

05

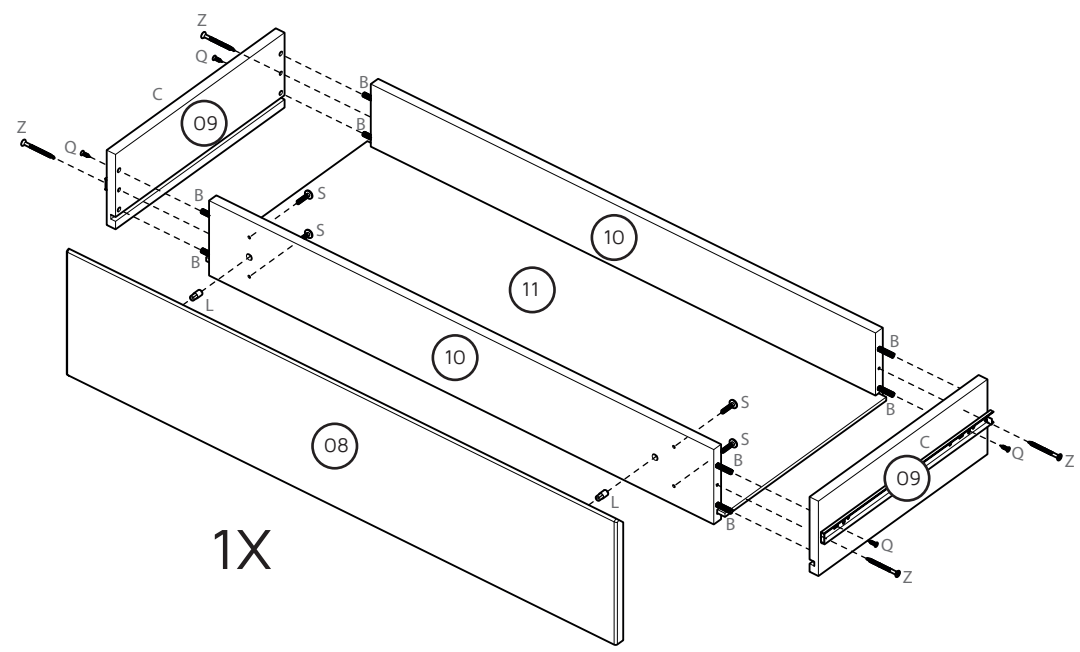



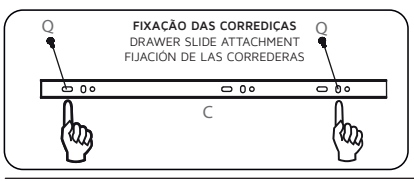

1X

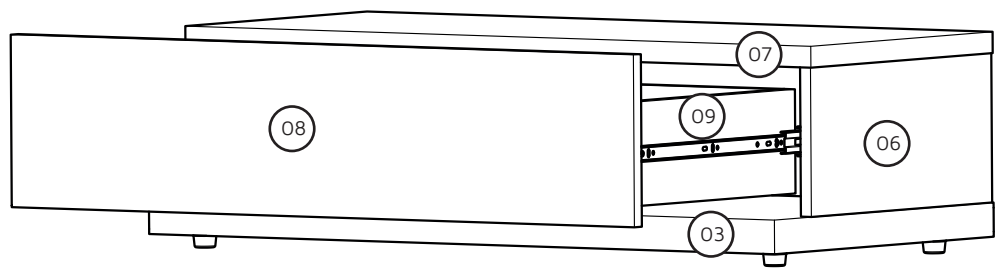

06

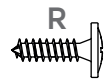
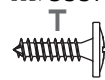

COD. 9070 	COD. 0348 	COD. 8056 	COD. 3557 	COD. 3706 
---	--	---	---	---

07

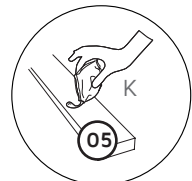
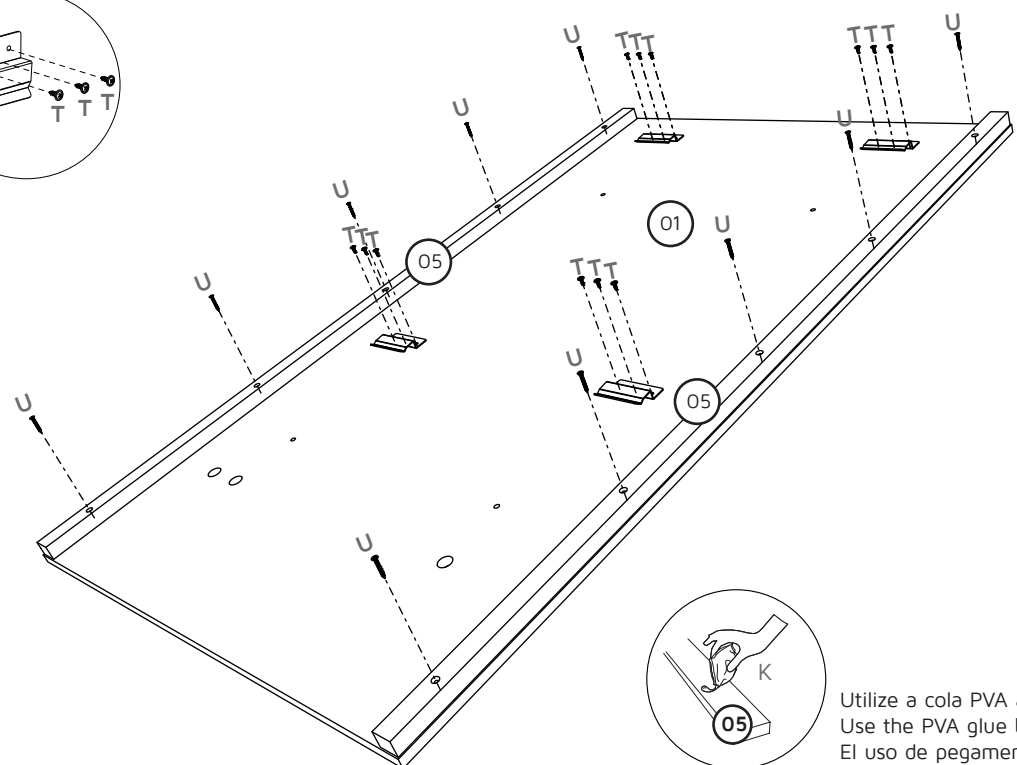
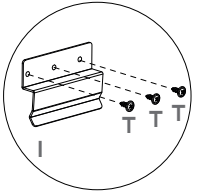

Utilize a cola PVA antes de aparafusar.
Use the PVA glue before screwing.
El uso de pegamento PVA antes de atornillar.

08

! Atenção/Attention/Atención
*FACE COM ACABAMENTO PARA CIMA.
*FINISHED SIDE FACING UP.
*LADO ACABADO HACIA ARRIBA.

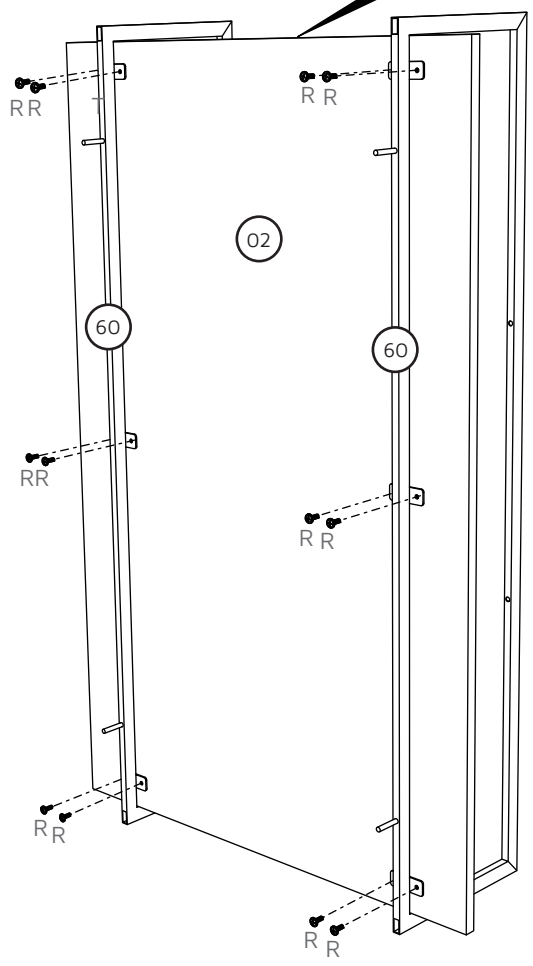

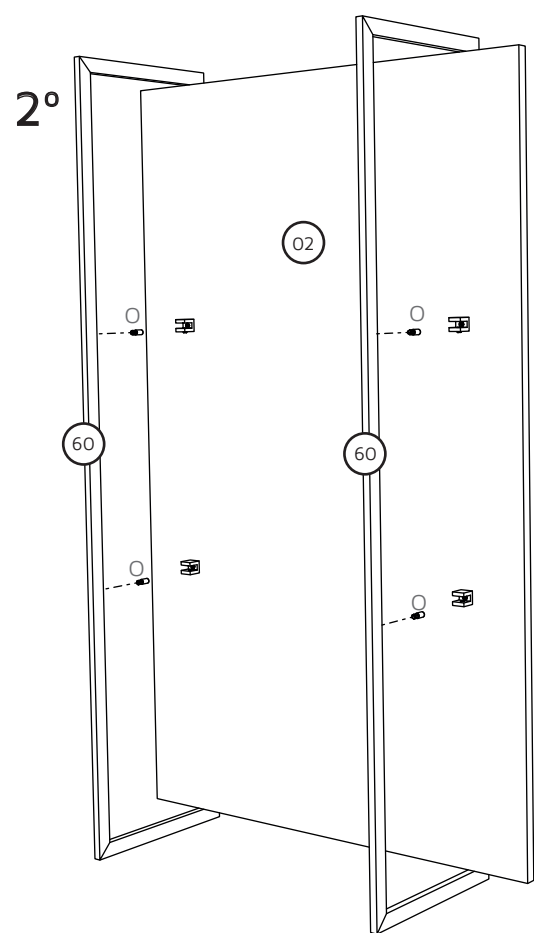
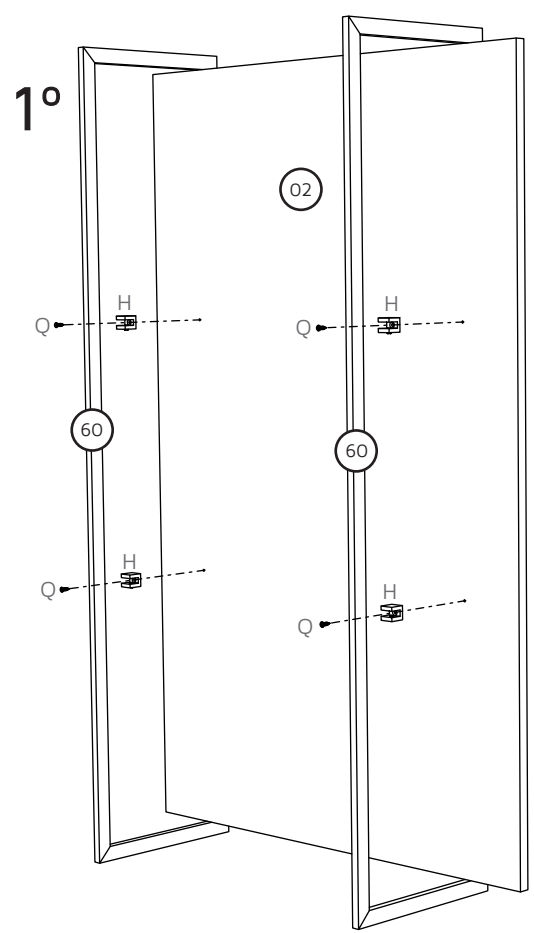
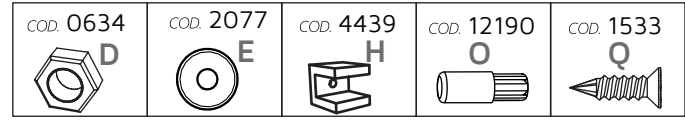

! Atenção / Attention / Atención

*A aplicação do interruptor deve ser feita nesta etapa.

*The Switch must be assembled in this step.

*La instalación del interruptor debe realizarse en este paso.

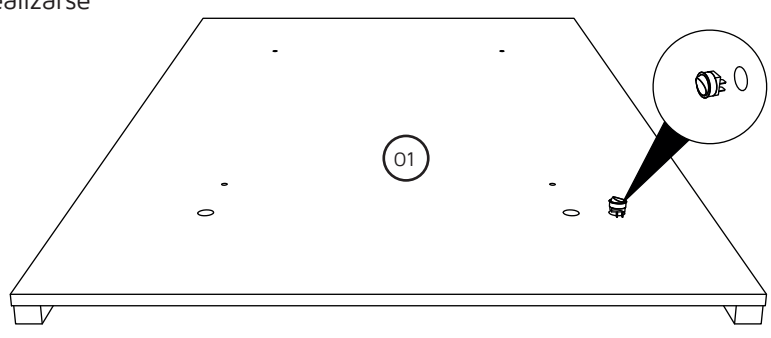
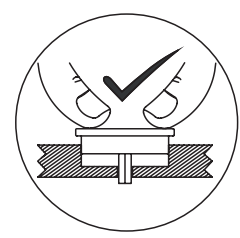
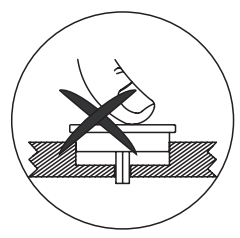

! **Atenção/Attention/Atención**
*FACE COM ACABAMENTO PARA CIMA.
*FINISHED SIDE FACING UP.
*LADO ACABADO HACIA ARRIBA.

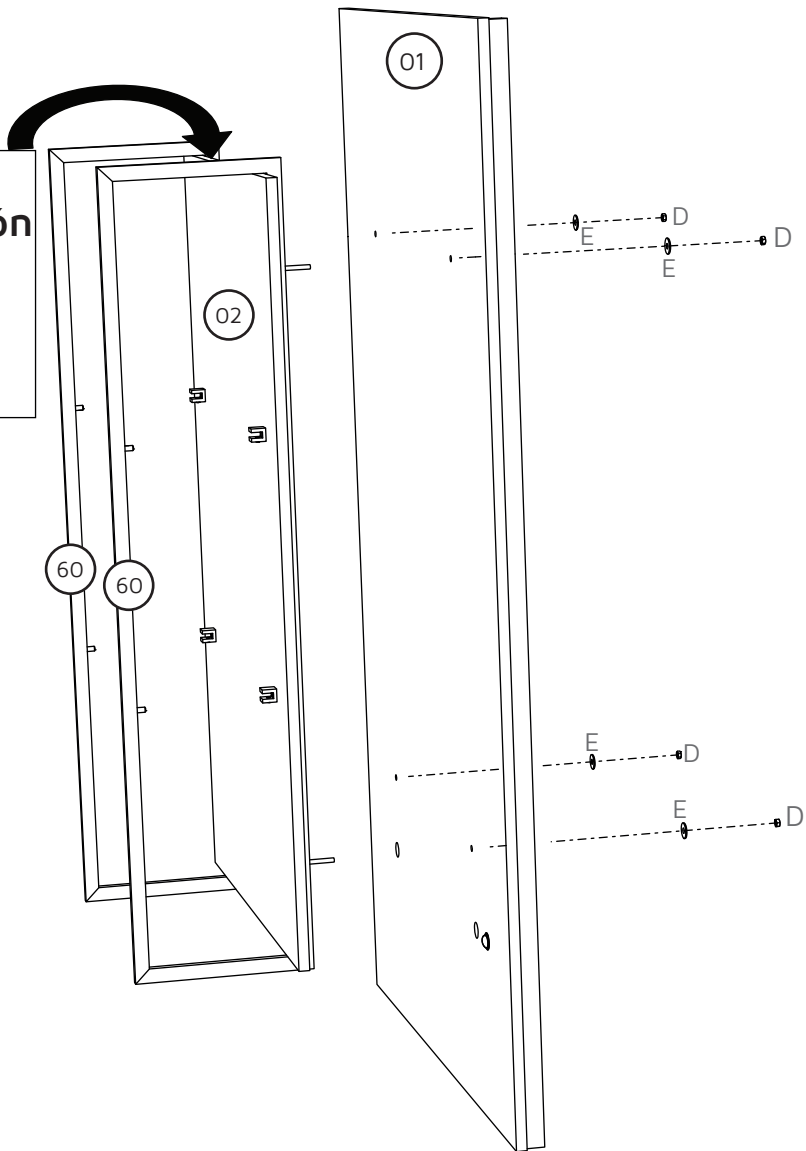

! Atenção / Attention / Atención

*A APLICAÇÃO DO PRODUTO LED DEVE SER FEITA NESTA ETAPA.

*The LED lights must be assembled in this step.

*La instalación del LED debe realizarse en este paso.

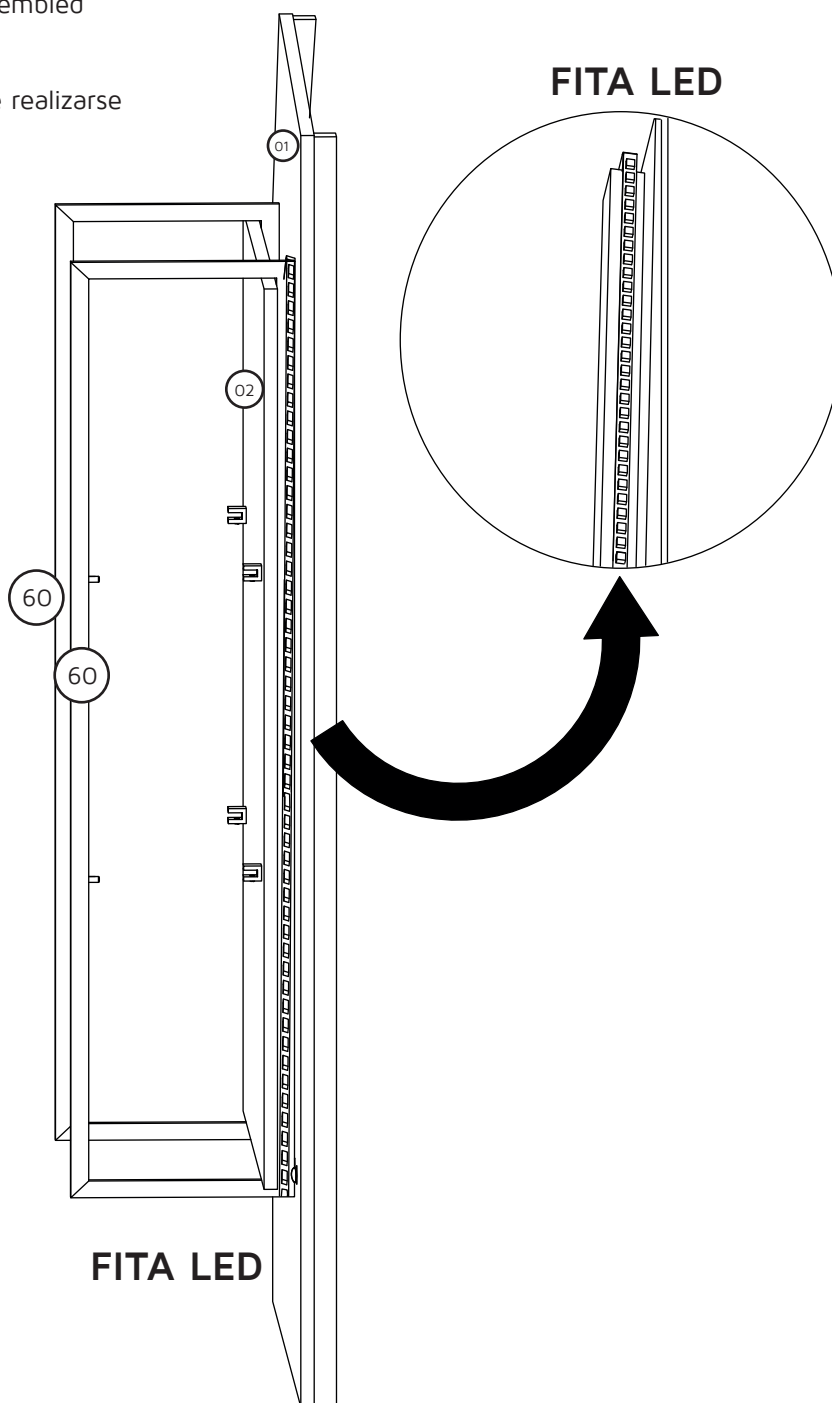

KIT FITA 1050 M
COM INTERRUPTOR
ENTRADA: 100-240Vac 50/60Hz 0,3A
POTÊNCIA: 10W
GRAU DE PROTEÇÃO: IP20

LED LIGHTS SET 1050 m
WITH SWITCH
INPUT: 100 - 240 Vac 50/60Hz 0,3A
POWER: 10W
PROTECTION: IP20.

KIT FITA 1050 M
COM INTERRUPTOR
ENTRADA: 100-240Vac 50/60Hz 0,3A
POTENCIA: 10W
GRADO DE PROTECCIÓN: IP20

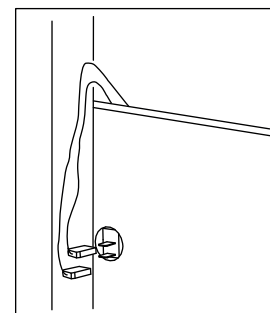

13

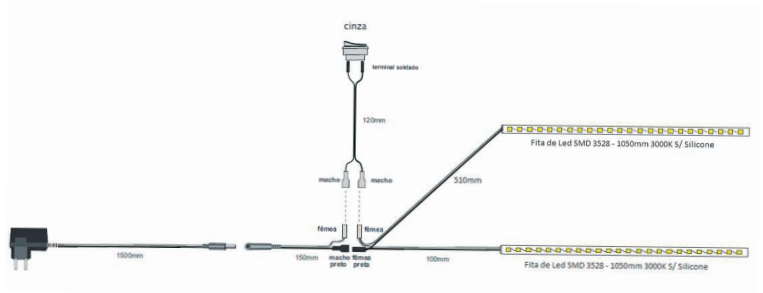
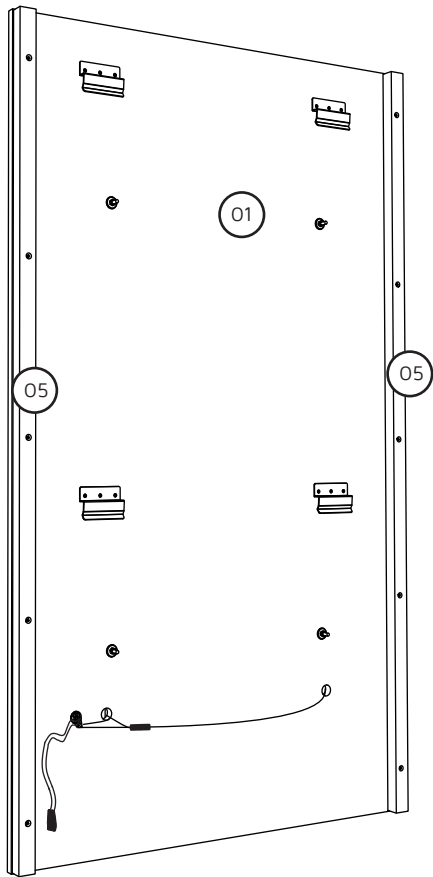

14

Medidas para realizar a furação da parede
(em milímetros).
Measurement to drill the wall
(in millimeters).

Medidas para realizar la perforación de la pared
(en milímetros).

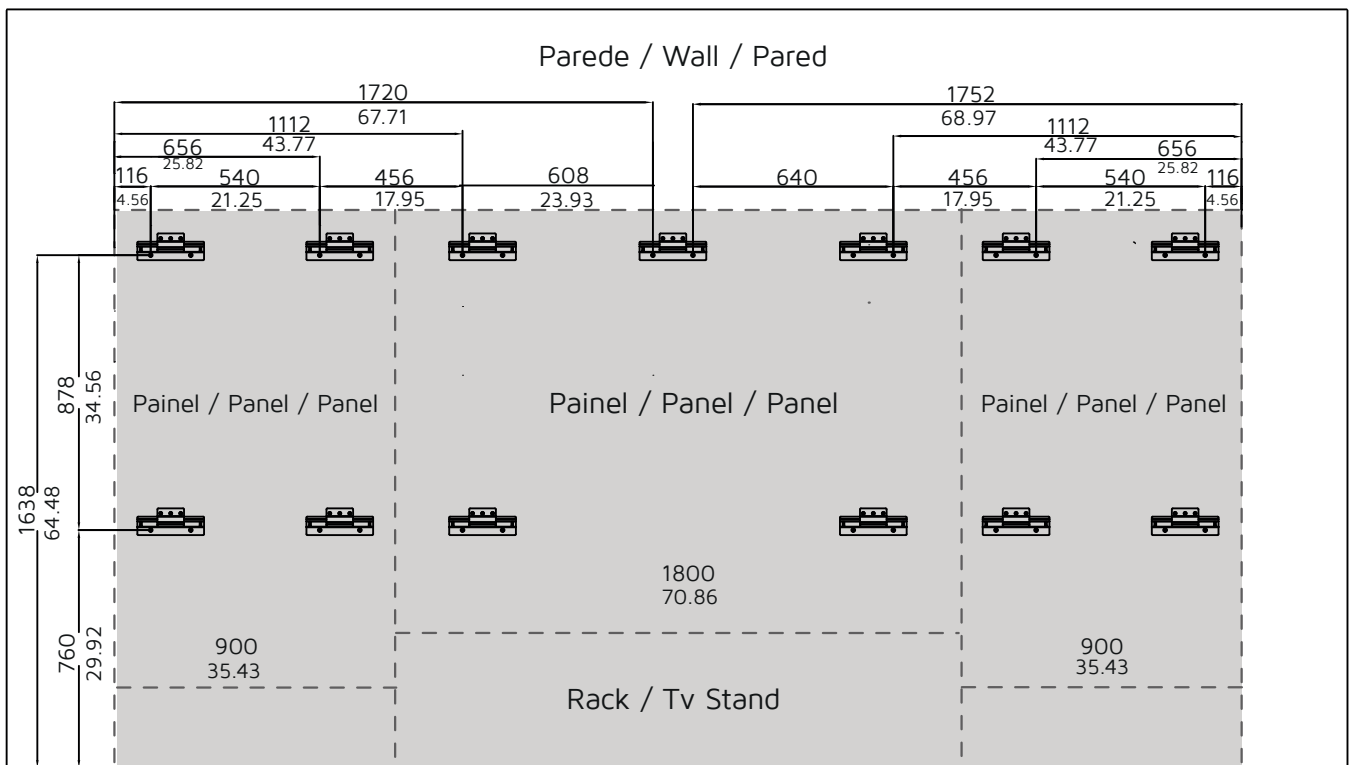
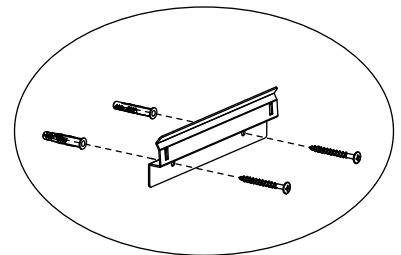
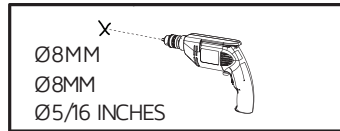
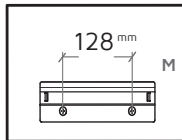

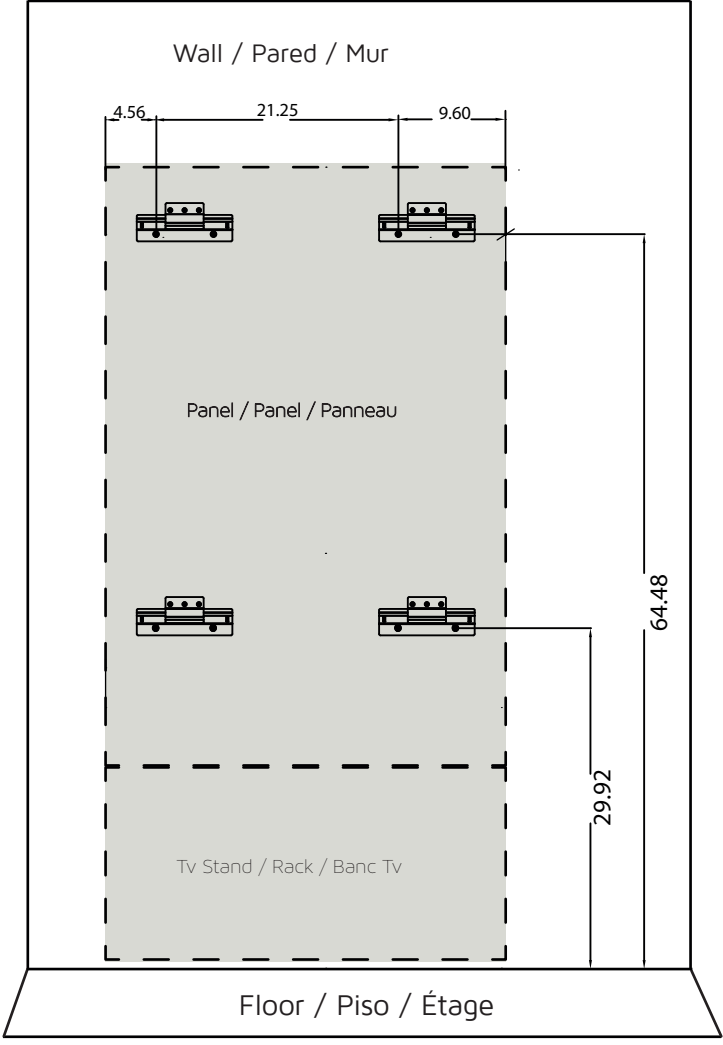
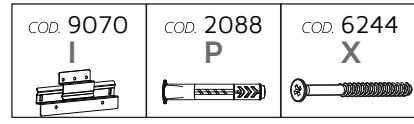

Measurement to drill the wall.
(em inches).

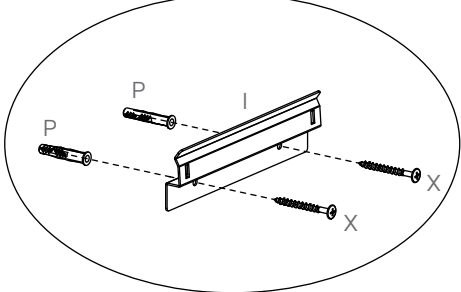
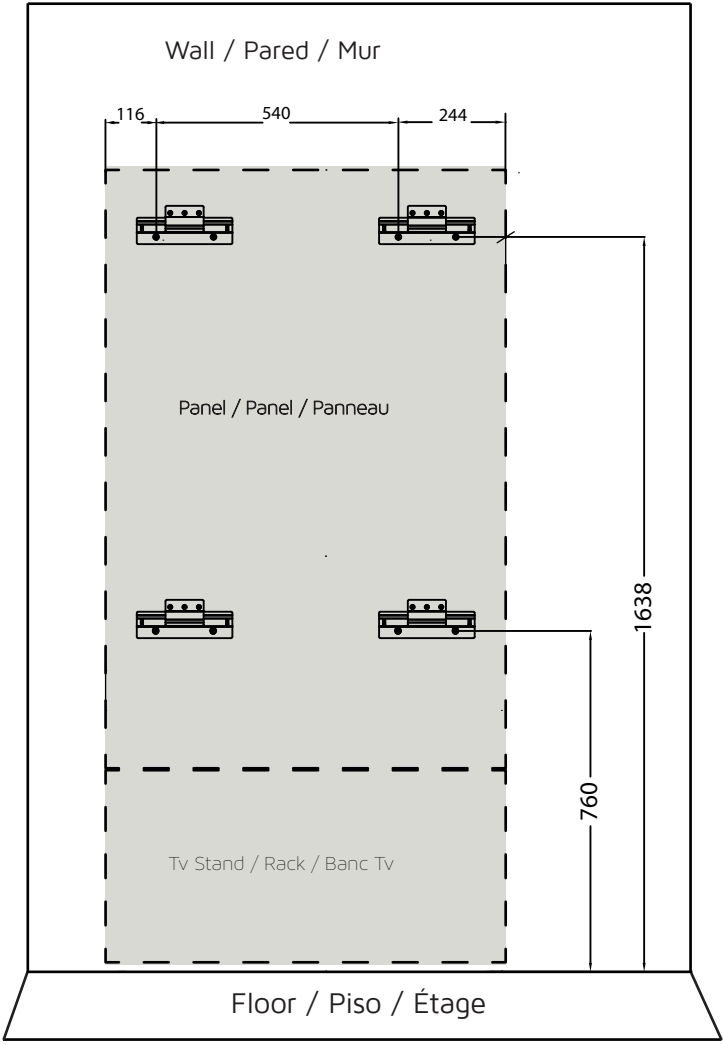
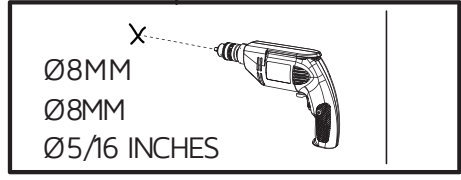
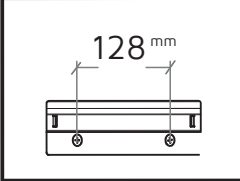
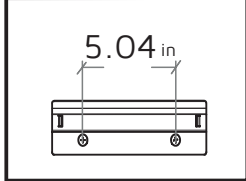

Medidas para realizar la perforación de la pared
(en milímetros).

Mesures pour percer le mur
(en millimètres).

16

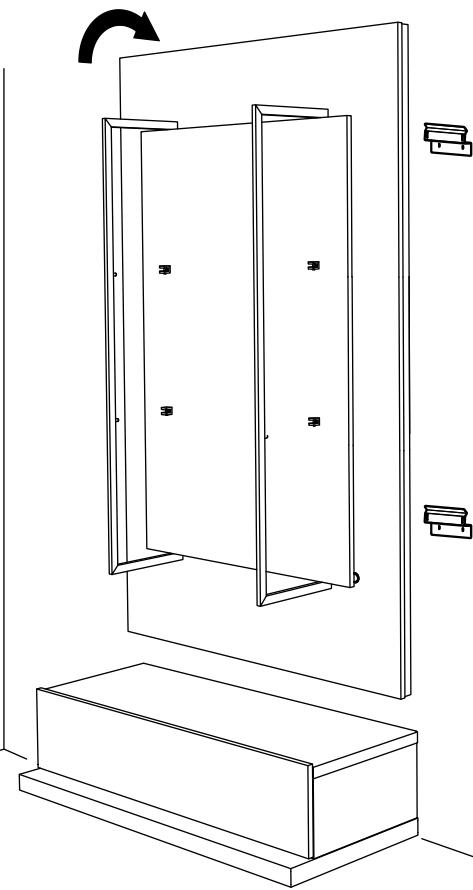
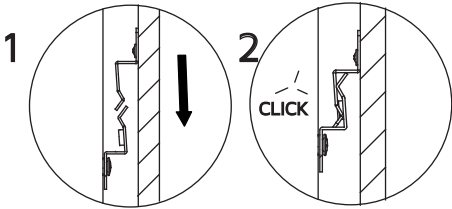

17

