

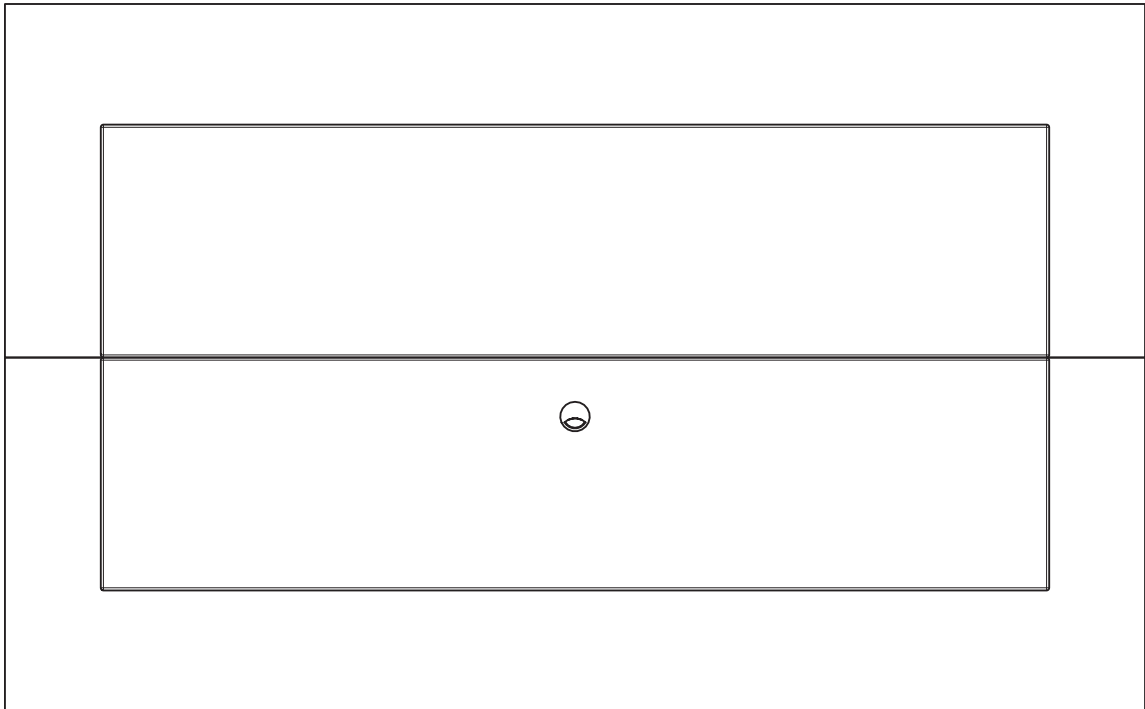

MANHATTAN
COMFORT

ASSEMBLY INSTRUCTIONS



COD: 252400

REV. 00

IMPORTANT REMARKS



Never climb or lean on the furniture. You may suffer serious accidents.

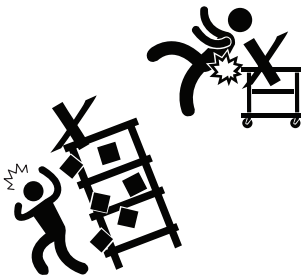

Use the packaging to cover the assembly area and separate all parts.

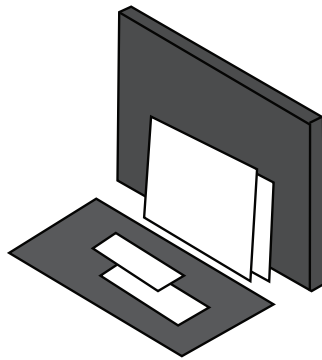

Identify the parts by observing the number printed on their edges.

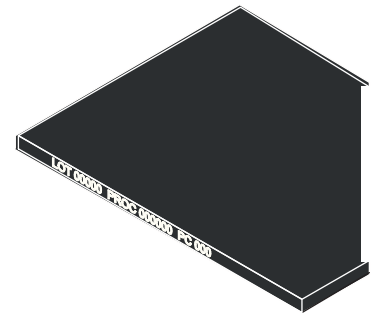

CARE INSTRUCTIONS



Wipe clean using a damp cloth and a mild cleaner. Do not use abrasive and chemical products.



HANDLING

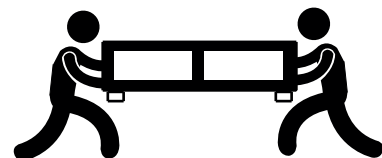

Move the piece carefully, don't drag it. Ask for someone else's help to do so.

HARDWARE



Identify and separate the hardware used in the assembly. There's a label on each package identifying the parts and where to use them.

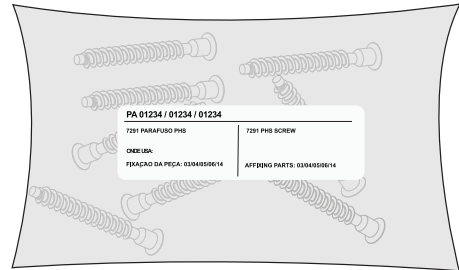

COD. 3557-31x

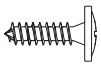

A

COD. 3706-44x



B

COD. 9069-10x



C

COD. 2088-10x

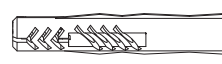

D

COD. 4157-8x



E

WIRE CHANNEL-1x



F

COD. 1668-2x



G

COD. 0348-2x



H

COD. 6024-8x



I

COD. 9070-5x

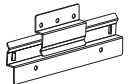

J

SUPPORT - 1x

SUPPORT TV

K

KIT LED-1x

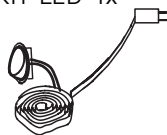

L

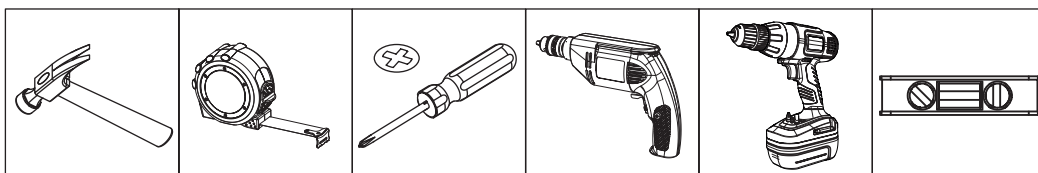





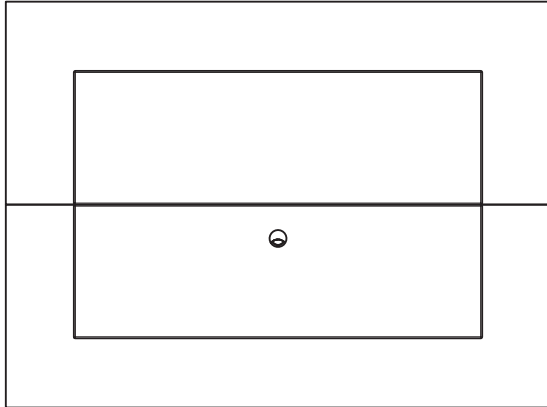

DESCRIPTION

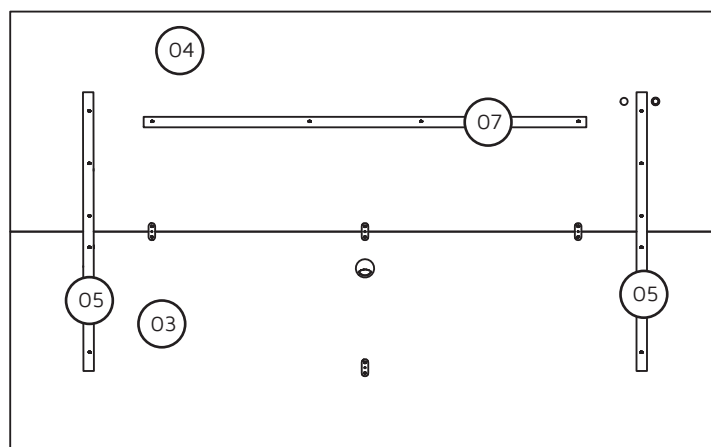
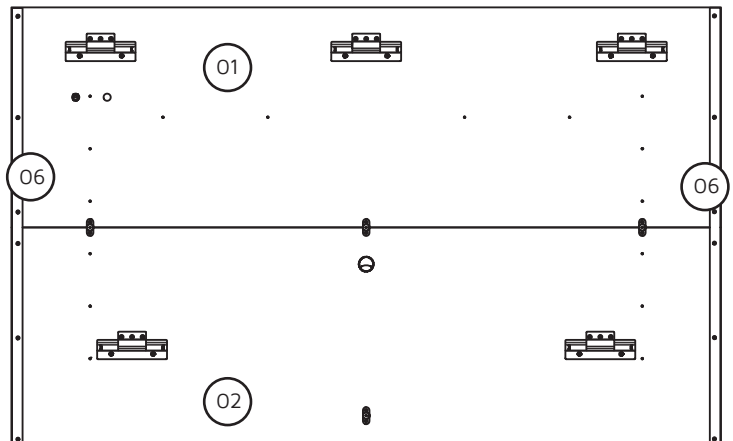
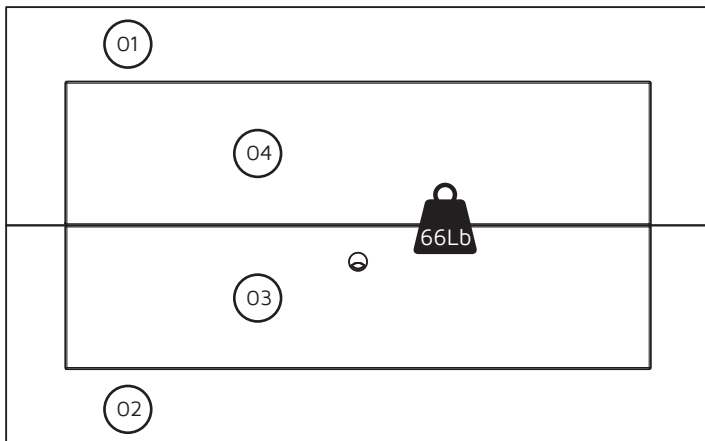
W:70,86 inches H:52,83 inches D:13,15 inches
 L:1800mm A:1342mm P:80mm

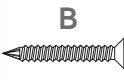

CÓD:252400			
PART	QUANTITY	DESCRIPTION	BOX
01	01	TOP PANEL	01
02	01	BOTTOM PANEL	01
03	01	BOTTOM FRONT PANEL	01
04	01	TOP FRONT PANEL	01
05	02	LED BATTEN	01
06	02	SIDE BATTEN	01
07	01	TOP BATTEN	01

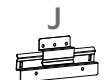

COD. 3557 A 	COD. 3706 B 	COD. 4157 E 	COD. 0348 H 	COD. 9070 J 	KIT LED L 
---	---	---	---	---	---

01

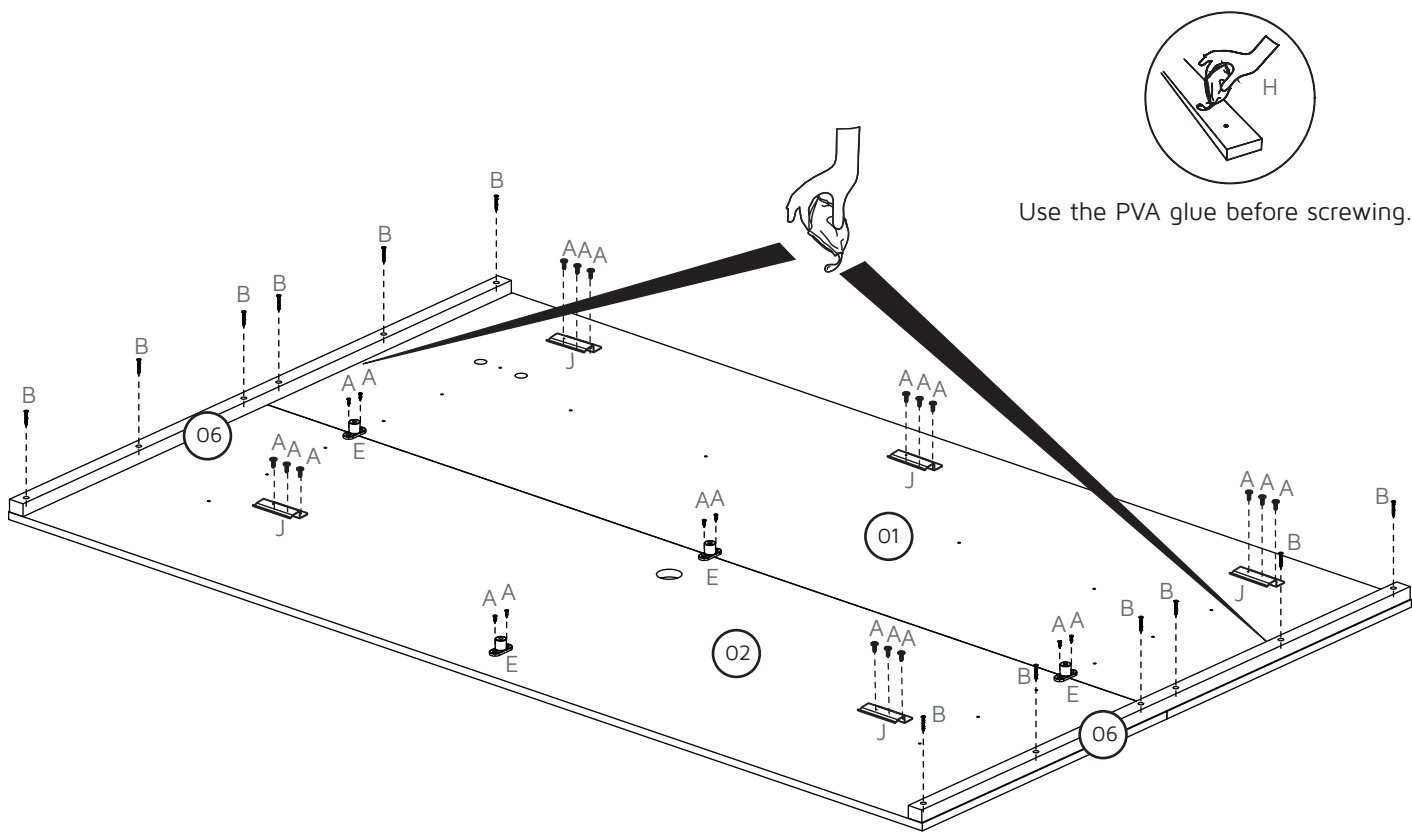

02





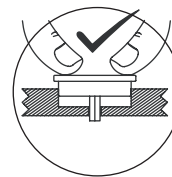
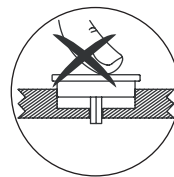
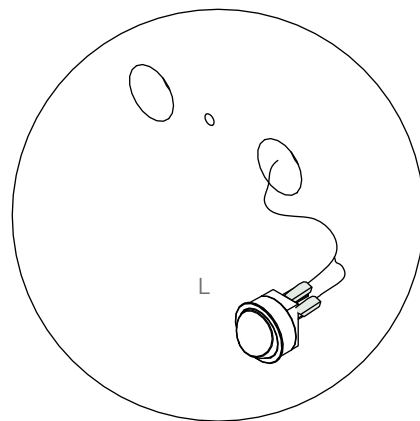
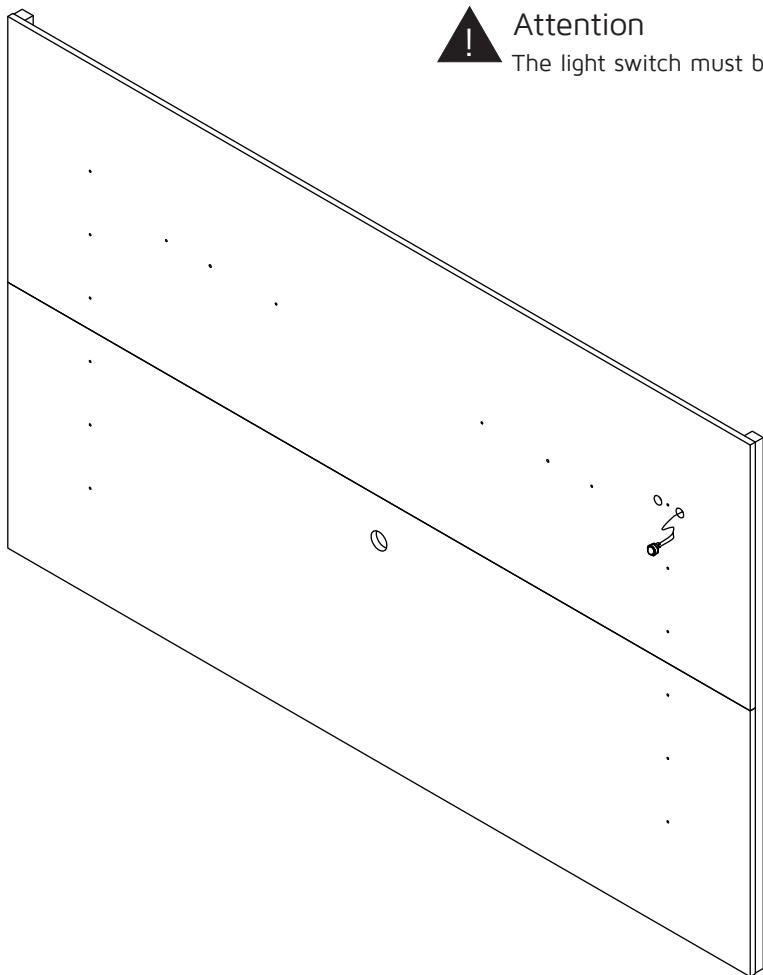

Attention

The light switch must be assembled in this step.

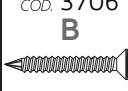

03

COD. 3557 A 	COD. 3706 B 	COD. 4157 E 	COD. 0348 H 	COD. 1668 G 	KIT LED L 
---	---	---	---	---	---

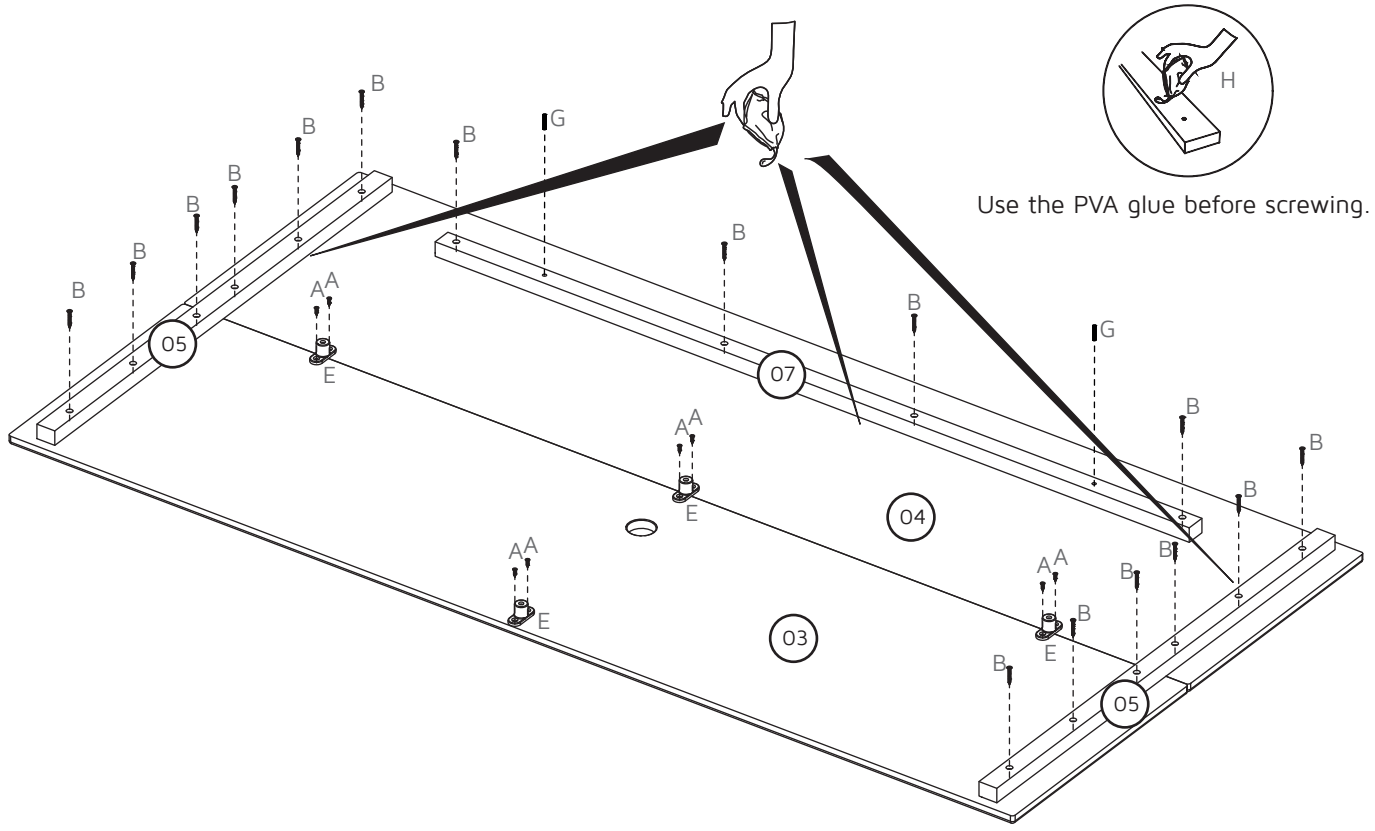

04

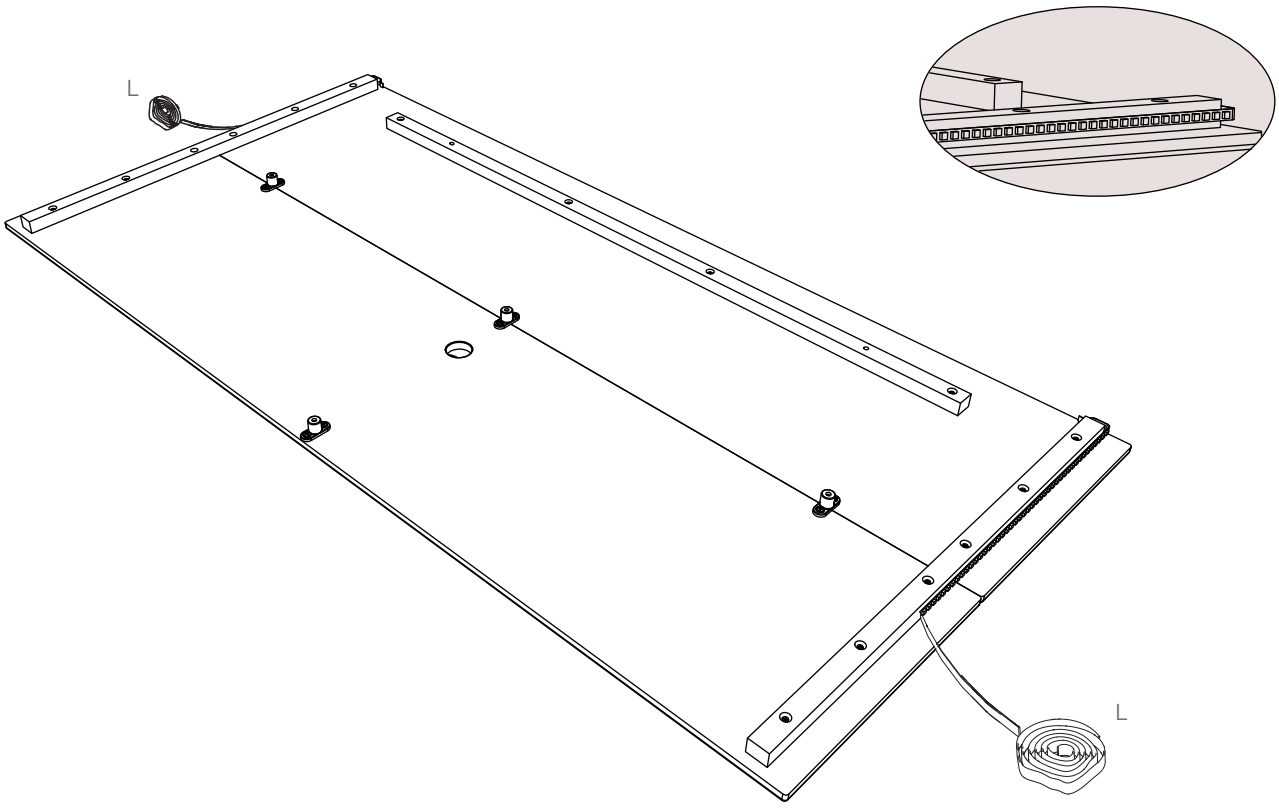

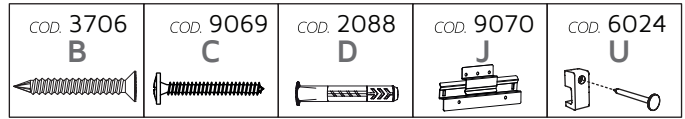

05

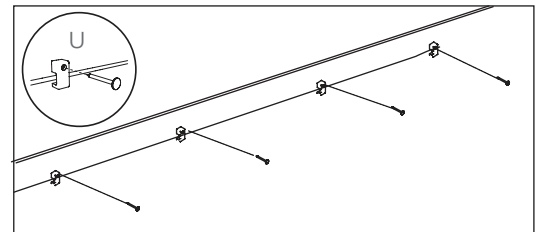
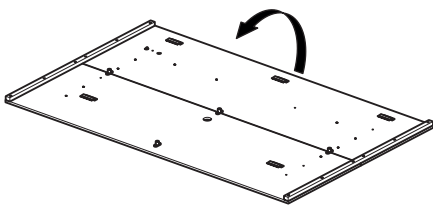
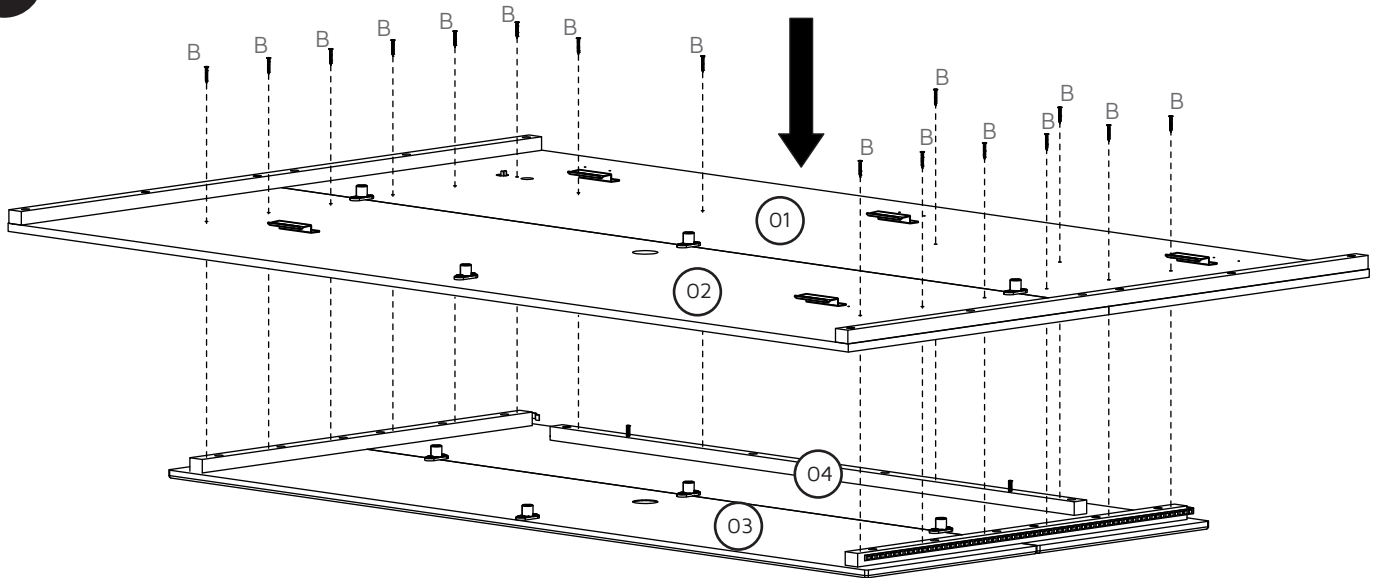

06

Measurement to drill the wall.

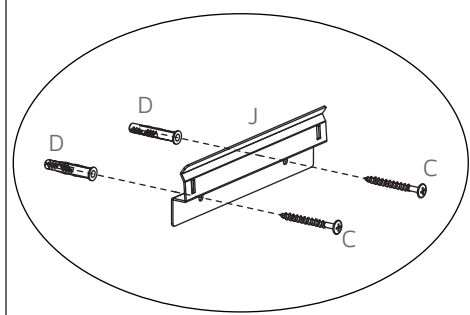
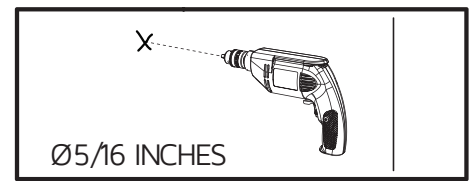
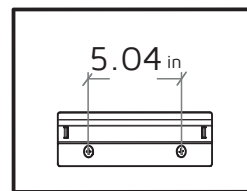
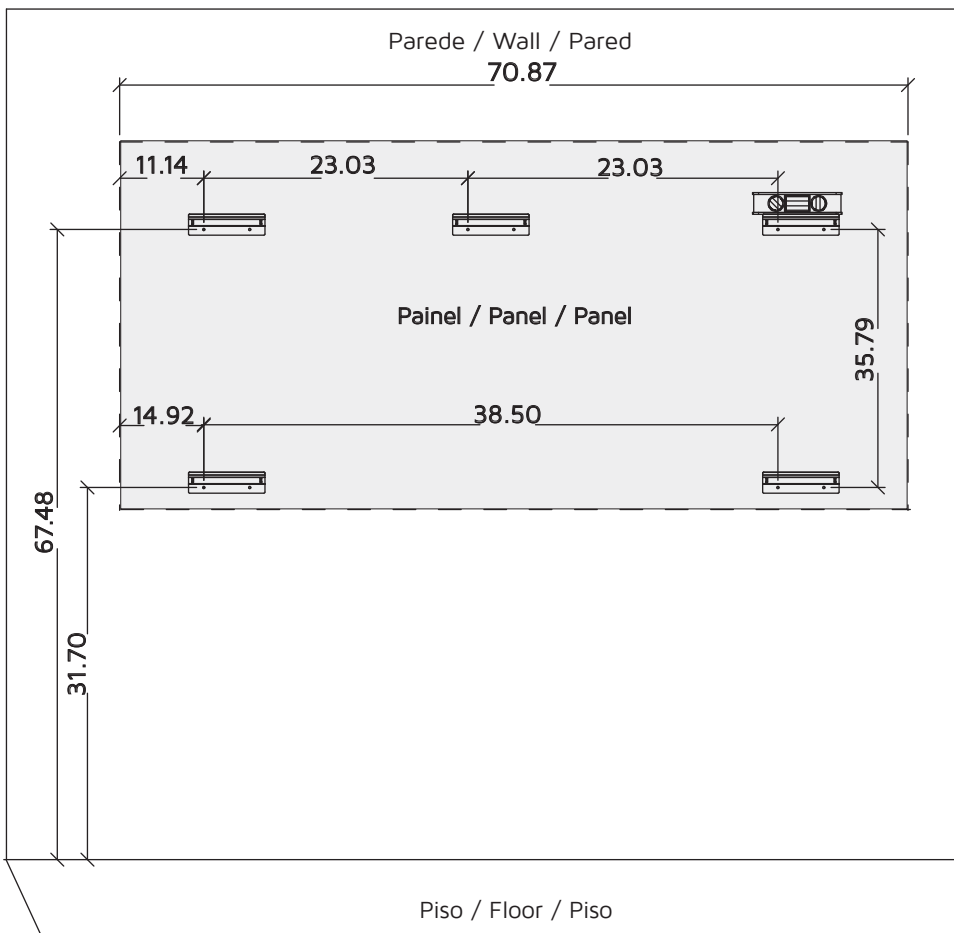

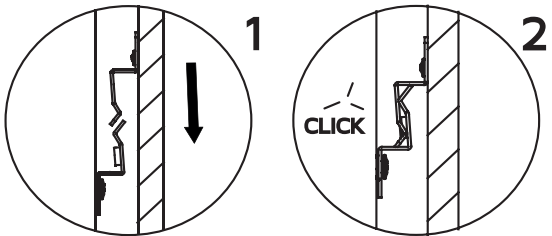

ATTENTION
Pass the cables through the back before Panel.

