

# Jay Bookcase 2.0

Assembly Instructions - Please keep for future reference

CS 340

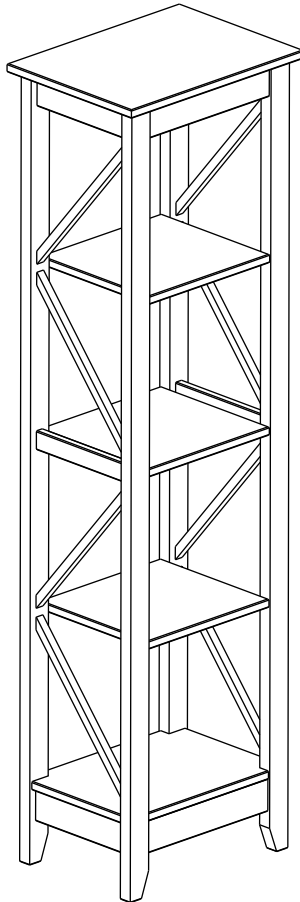

## Safety and Care Advice

**Important** – Please read these instructions fully before starting assembly

- Check you have all the components and tools listed on page 3.
- Remove all fittings from the plastic bags and separate them into their groups.
- Keep children and animals away from the work area, small parts could choke if swallowed.
- Make sure you have enough space to layout the parts before starting.
- Do not stand or put weight on the product, this could cause damage.
- Assemble the item as close to its final position (in the same room) as possible.
- Assemble on a soft level surface to avoid damaging the unit or your floor.

- This product has been produced from natural timber; you may notice some variation in the grain and colour of different component parts which is normal for furniture produced using natural wood and is not the result of any manufacturing fault.
- The product has been treated with a wax and oil finish to prevent dirt ingress and preserve moisture.
- On unpacking the furniture you may notice an odour due to this treatment; this will disappear once the furniture is unpacked and assembled after a period of time.
- This process may leave some staining on the packaging material; please take care to ensure this does not transfer to clothing or carpeted surfaces during assembly.



• We do not recommend the use of power drill/drivers for **inserting screws**, as this could damage the unit. Only use hand screwdrivers.

- Parts of the assembly will be easier with 2 people.
- Dispose of all packaging carefully and responsibly.

## Care and maintenance

- Use an appropriate furniture polish for natural wood furniture and a dry cloth to clean the product.
- Avoid placing the furniture in direct sunlight as this will cause the timber to prematurely age.
- From time to time check that there are no loose screws on this unit.
- This product should not be discarded with household waste. Take to your local authority waste disposal centre.

Dimensions	No. people	Assembly Time
Width - 47cm Depth - 35cm Height - 167cm		30 min (approx.)

**Important**—Please read these instructions fully before starting assembly

**Note:** If required the next page can be cut out and used as reference throughout the assembly. Keep this page with these instructions for future reference.

## Components - Panels

Please check you have all the panels listed below

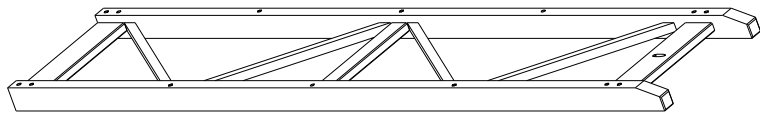

1 Right side (165 x 31 cm) x 1

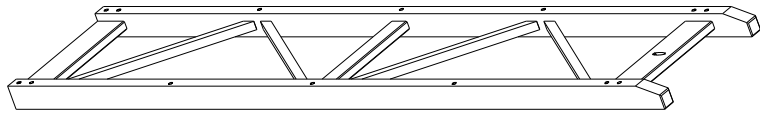

2 Left side (165 x 31 cm) x 1

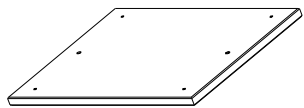

3 Top (47 x 35 cm) x 1

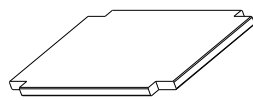

6 Base (38 x 30,5 cm) x 1

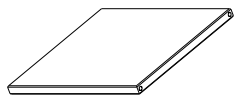

4 Shelf (33 x 30,5 cm) x 2

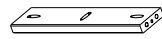

7 Rail (33 x 6,5 cm) x 4

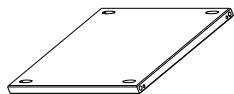

5 Shelf (33 x 30,5 cm) x 1

## Components - Fittings

Please check you have all the fittings listed below

**Note:** The quantities below are the correct amount to complete the assembly. In some cases more fittings may be supplied than are required.

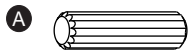

Ø8,0x30mm Wooden dowel x 30



Ø3,5x35mm Screw x 18



Ø4,0x40mm Screw x 4

## Tools required

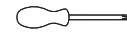

Phillips screwdriver (medium)

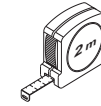

Ruler/tape measure



Small hammer



Eye protection (when using a hammer or glue)

Ruler - Use this ruler to help correctly identify the screws



## Assembly Instructions

### Step 1

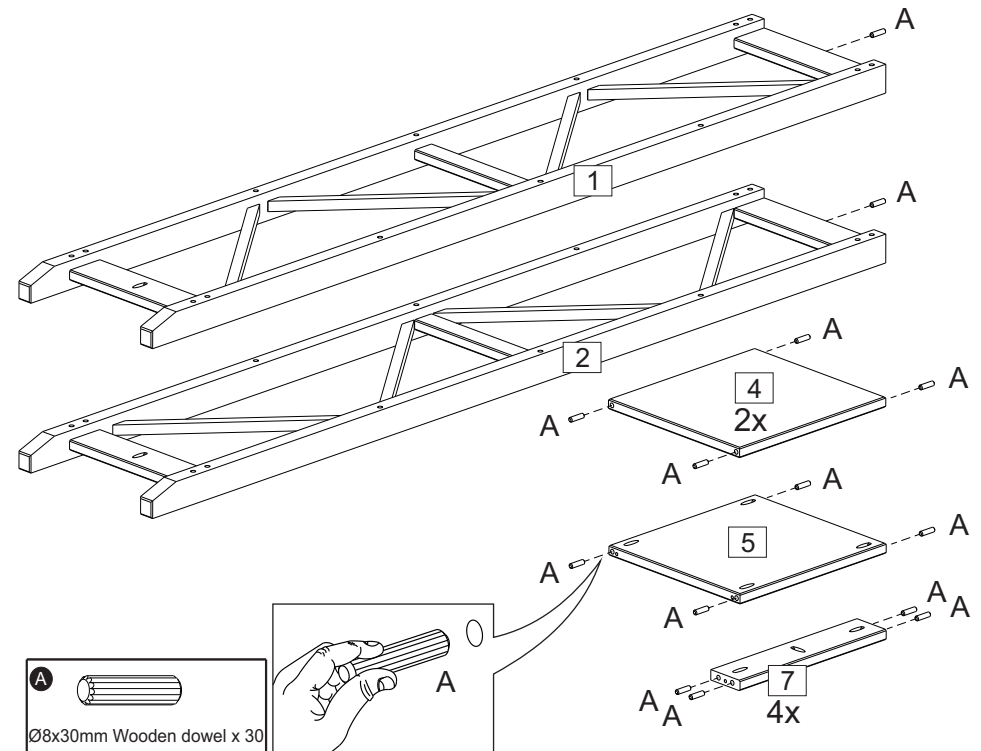

# Assembly Instructions

## Step2

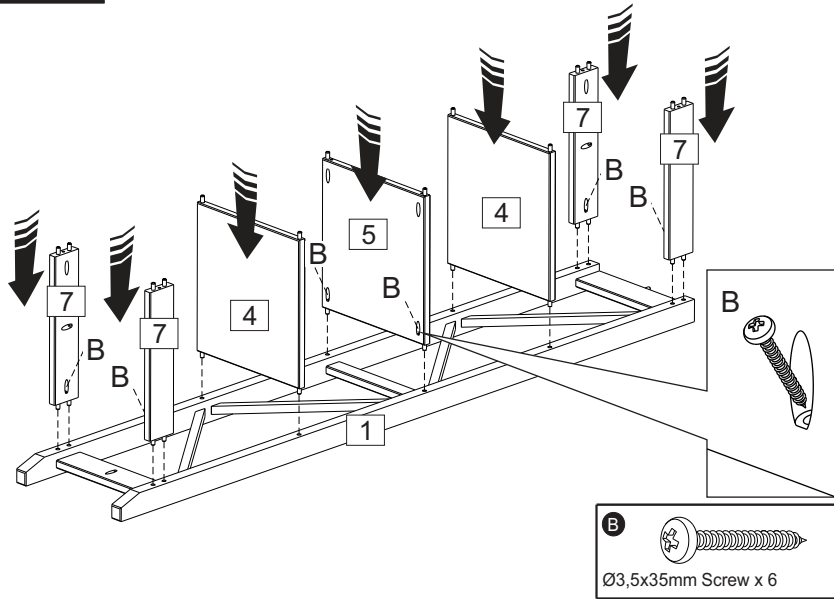

## Step3

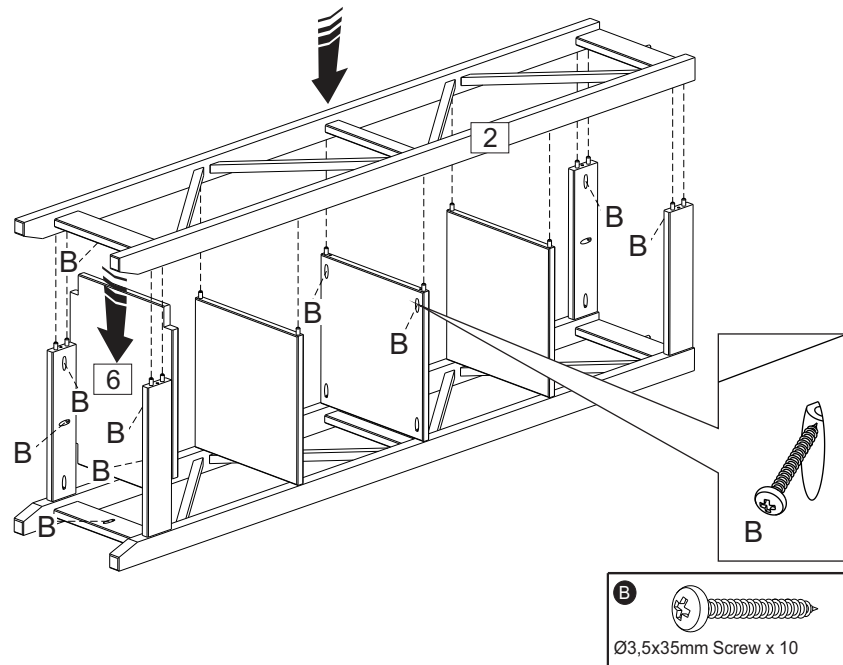

# Assembly Instructions

## Step4

