

# Disguise Platform User Guide

Version - r26

Last updated 15 February 2024





# Contents

## **Disguise Platform User Guide**

### **What is Disguise?**

Pre-production .....	53
Rehearsals and live production .....	54

### **Main Elements**

Timeline level .....	56
Stage level .....	57
Feed level .....	58
Real-time mapping .....	59

### **Designer overview**

System Requirements .....	62
Operating system .....	62
Virtual Machines - Parallels .....	63
Designer software .....	63
Download and Install Designer .....	64
Starting the download installer .....	64
Uninstalling Disguise software .....	68
Licensing .....	70
Overview .....	70
Dongle based license .....	71
Software only based license .....	72
Identifying the version .....	74
Macbook Pro Retina driver issues .....	78
Video capture .....	79
APIs .....	80
Viruses and malware .....	83

Recommended virus scanner .....	83
What's new in r26 .....	84
What's new in r25 .....	102

### **d3manager Overview**

Creating a new project .....	117
Template project .....	118
Starting an existing project .....	121
Re-launching the last active project .....	122
Opening a project from file list .....	123
Opening the Disguise Projects folder .....	124
d3manager - Networked Machines .....	125
d3manager network view .....	125
Install Disguise software remotely .....	125
d3manager network view .....	125
d3manager Accessing project folders on networked machines .....	125
Joining a session from file list .....	126
Assistance mode .....	129
Adding and removing project folders .....	131
Adding a project folder: .....	131
Removing a project folder: .....	131
Expanding and collapsing projects folders .....	132

### **Help Menu Overview**

Project History files .....	134
Restoring an backed up .d3 project file .....	135
Restoring an object after permanently deleting it .....	135
Autosave .....	136
Changing the frequency of autosave .....	136
Manual save .....	136
Checkpointing projects .....	138
What a checkpoint does .....	138
How to create a checkpoint .....	139
Opening a checkpointed project created in an old release .....	140
How to disable a Checkpoint .....	140

Project snapshots .....	141
Console files .....	145
Finding the console. ....	145
Diagnostic archives .....	148

### **Before you get started**

Creating a new project .....	151
Starting and exiting .....	152
How to open a project .....	152
How to quit out from a project .....	152
Scheduled exit .....	152
GUI overview .....	154
Dashboard .....	154
Stage Visualiser .....	158
Timeline .....	159
Navigating the Stage .....	160
Panning the camera .....	161
Camera Position Bookmarks .....	162
Recalling a camera position .....	162
Storing a camera position .....	162
Resetting the camera to its default position .....	162
Camera Bookmarks List .....	162
Keyboard shortcuts .....	165
Shortcuts .....	167
Supported file formats .....	174
Filename Tag Issues .....	174
Premultiplied vs. straight/matted alpha .....	175
Maximum resolutions of video files and still images .....	175
Project Settings .....	182
d3State Options .....	193

### **Objects editor overview**

Overview of objects .....	196
Finding out the name of an object .....	197
Object libraries .....	199

Selecting an object .....	199
Managing Objects .....	204
Editing objects .....	207
Types of object properties .....	207
Editing numerical properties .....	208
Multi-edit .....	214
Object assignment hotkeys .....	218
Object tracking source .....	220
Importing & Exporting Objects .....	222
Transferring objects between projects .....	222
Workflow .....	222

## **Content Management Overview**

Content Version Control .....	233
Proxy Management .....	233
Frame Replacement .....	234
Media Ingestion History Tool .....	234
Content versioning .....	235
Project structure .....	238
Project location .....	240
Where are all of my projects stored? .....	240
Placing media files .....	241
Where do I place the media files for my project? .....	241
How to place media files and access them in your Disguise project .....	243
Media Ingestion History .....	245
Removing media files .....	247
How do I remove media files from my project? .....	247
Manage old media .....	253
Archive unused objects .....	256
Media Distribution .....	258
Adaptive Proxies .....	260
Frame Replacement .....	263
Duplicating video clip instances .....	264
Distinction between VideoFile and VideoClip .....	264
Duplicating a VideoClip .....	264



Image sequences .....	267
10bit content .....	271
Alembic Files .....	272
Slideshows .....	275
Content management and slideshows .....	279
VideoClip object .....	280
Overview .....	280
Video Codec overview .....	284
DXV 2.1.1 codec .....	285
HAP / HAP-Q codec .....	288
HAP Alpha .....	288
Graphics with Gradients usage of HAP-Q .....	288
Transcoding software .....	293
Adding noise in After Effects .....	294
Example .....	294
Colour Management .....	297
Overview .....	297
Colour Management Modes .....	299
Colour profiles .....	301
Overview .....	301
Colour space .....	301
Gamma .....	301
Workflow .....	301
Colour picker .....	305
Colour shifts .....	307
Transforms .....	311
Overview .....	311
Workflow .....	312
Additional Information .....	313
ACES .....	315
Histogram .....	324
LUT files .....	328
Overview .....	328
Workflow .....	329
Example .....	330

Vectorscope .....	331
Waveform .....	335
Rendering media overview .....	340
Stage/Feed movies .....	340
Screenshots .....	340
Video output settings .....	341
Movie Output properties .....	341
Rendering screenshots .....	343
Specifying the screenshot file format .....	344
Rendering Stage movies .....	346
Rendering Feed movies .....	348
How to render Feed movies .....	348
Generate content table .....	350

### **3D fundamentals overview**

3D fundamentals overview .....	354
Exporting 3D models .....	355
Optimising 3D models .....	361
Dividing 3D models into screens and props .....	361
Orientation .....	364
Position .....	366
Pivot points .....	366
Scale .....	369
Understanding .obj files .....	371
3D modelling / UV mapping overview .....	372
Why learn 3D modelling and UV mapping techniques? .....	372

### **UV mapping overview**

UV mapping overview .....	374
What is UV mapping? .....	375
How does d3 sample UV maps? .....	377
Editing UV maps .....	380
Rendering UV maps to content templates .....	384
Useful external link: .....	384
The UV map as the content template .....	389

Example .....	389
The UV map as the hardware output .....	396
Creative and Technical workflow separation .....	396
Re-configure the outputs .....	397

### **Projection Examples Overview**

Projection Examples Overview .....	401
Cylindrical mapping .....	403
How the UV map is generated .....	403
Pelt mapping .....	408
How the UV map is generated .....	408
Perspective Mapping .....	412
How the UV map is generated .....	412
Pixel-perfect mapping .....	418
How the UV map is generated .....	418
Planar mapping .....	426
How the UV map is generated .....	426
Shrink wrapping .....	430
How the UV map is generated .....	430
Spline mapping .....	435
How the UV map is generated .....	435

### **LED screen examples overview**

LED screen examples overview .....	441
Example 1: MiSTRIP star .....	442
How the UV map is generated .....	442
Example 2: OLite column .....	450
How the UV map is generated .....	450
Example 3: DNA Spiral .....	455
How the UV map is generated .....	455
Example 4: Millenia Tower .....	458

### **Stage overview**

What is the Stage? .....	461
Objects within a stage .....	461

Stage overview .....	464
What is the Stage? .....	464
Objects within a stage .....	464
Editing the Stage .....	467
Stage editor .....	467
Manipulators .....	480

### **Screen types overview**

What is a screen? .....	484
Types of screens .....	484
Screen types overview .....	486
What is a screen? .....	486
Types of screens .....	486
Creating screens .....	488
Deleting screens .....	492
Changing the Screen Type .....	494
Removing screens .....	495

### **Screen editor**

Screen editor .....	497
Screen properties .....	498
Offset .....	498
Rotation .....	498
Scale .....	498
Resolution .....	498
Mesh .....	498
Appearance properties .....	500
Pixel mask .....	502
Population mask .....	505
Output properties .....	507
Hierarchy .....	510
Pixel mask .....	513
Population mask .....	516
Single Large Canvas .....	518



## **DMX screens and DMX lights overview**

Background .....	520
Current status .....	520
DMX screens and DMX lights overview .....	522
Background .....	522
Current status .....	522
Global DMX options .....	524
Global DMX properties .....	524
Creating DMX lights .....	526
Creating a DmxLights screen .....	526
DmxLights properties .....	526
Creating DMX lights .....	528
Creating a DmxLights screen .....	528
DmxLights properties .....	528
Creating a fixture .....	530
Fixture properties .....	531
Fixture drivers .....	534
Types of fixture drivers .....	534
Creating a fixture driver .....	535
DmxDriver .....	536
Setting up a grid of fixtures .....	545
DmxLights properties .....	545
Global rotation .....	547
DMX addressing .....	549
Addressing properties .....	549
DmxAssigner .....	550
DmxString properties .....	551
Targeting fixtures .....	553
How to target the fixtures .....	553
Creating DMX screens .....	556
Creating DMX screens .....	560
Editing local channels .....	564
DMX table screens .....	565

## Projector Simulation overview

Projector Simulation as a decision-making tool .....	575
3D models preparation .....	575
Content creation .....	576
How do I learn about preparing a projection-based 3D model for Disguise? ....	576
Projector Simulation overview .....	577
Projector Simulation as a decision-making tool .....	578
3D models preparation .....	578
Content creation .....	579
How do I learn about preparing a projection-based 3D model for Disguise? ....	579
Creating and removing projectors .....	580
Creating a projector for a stage .....	580
Removing a projector from a stage .....	580
Editing projectors .....	582
Settings .....	585
Appearance .....	592
Calibration .....	594
Output .....	596
Outputting to projectors .....	606
Creating an output from a projector .....	606
Projector List Overview .....	608
Features of the Projector List .....	608
Final Adjust .....	609
Multiple Projector Lists .....	609
Manual Calibration - Projectors .....	610
Warping outputs .....	619
Projector Footprints .....	631
Enabling Projector Footprints .....	631
Multi-Pose Projection Calibration Overview .....	633
Multi-Pose Projection Workflow .....	633
Example .....	633
Blending and masking outputs .....	635
Dynamic Blend .....	640
Enabling Dynamic Blend .....	640

Global Dynamic Blend Settings .....	641
Projector Level Dynamic Blend Settings .....	642
Include Exclude list .....	644
Using the Include & Exclude list .....	644
Quick Calibration overview .....	645
QuickCal overview .....	645
3D mesh accuracy .....	645
Using QuickCal .....	645
Tips & tricks .....	646
Quick Calibration overview .....	651
Quick Calibrating - Projectors .....	657
Creating & deleting reference points .....	669

### **Venues and props overview**

What is a venue? .....	673
What is a prop? .....	673
Venues and props overview .....	674
What is a venue? .....	674
What is a prop? .....	674
Creating and removing props .....	675
Editing props .....	680
Prop properties .....	681
Creating and switching venues .....	687
Editing venues .....	689

### **Cameras**

Overview .....	690
Creating a Camera .....	690

### **MR Set**

Overview .....	693
Workflow .....	693
Properties .....	693
Delay calibration .....	695
Tracker Delay .....	697

Spatial calibration .....	697
<b>Visualiser renderer overview</b>	
Schematic .....	698
Lux .....	698
Heatmap .....	698
<b>Visualiser renderer overview</b>	
Schematic .....	700
Lux .....	700
Heatmap .....	700
<b>Schematic</b>	
Overview .....	702
Workflow .....	702
Example .....	703
<b>Lux</b>	
Overview .....	707
Workflow .....	710
Example .....	710
<b>Heatmap</b>	
Overview .....	715
Workflow .....	715
Example .....	715
Heatmap properties .....	719
Projector studies .....	721
<b>Projector Calibration</b>	
Overview .....	727
Manual Calibration - Projectors .....	728
Quick Calibration overview .....	737
QuickCal overview .....	737



3D mesh accuracy .....	737
Using QuickCal .....	737
Tips & tricks .....	738
Creating & deleting reference points .....	743
Quick Calibrating - Projectors .....	747
Multi-Pose Projection Calibration Overview .....	759
Multi-Pose Projection Workflow .....	759
Example .....	759
OmniCal Overview .....	761
Overview .....	761
Workflow .....	762
Features .....	762
Current limitations .....	763
For a trained OmniCal operator .....	763
For an untrained operator (recalibration) .....	765
Hardware .....	765
Tips & tricks .....	767
Troubleshooting .....	770
OmniCal Camera setup .....	772
Overview .....	772
OmniCal Capture .....	782
Overview .....	782
Workflow Example .....	782
 <b>OmniCal Calibration &amp; alignment</b>	
Overview .....	787
Workflow .....	787
Example .....	787
OmniCal Multi-pose alignment .....	791
Prerequisites .....	791
Extract Good Meshes .....	792
Create poses for each moving screen .....	793
 <b>OmniCal Rig-check</b>	
Overview .....	795

Workflow .....	795
Example .....	797

### **Sequencing Overview**

Sequencing Overview .....	801
---------------------------	-----

### **Timeline overview**

What is the Timeline? .....	802
Objects within the Track Player .....	802
Track Anatomy .....	802
Transport controls .....	804
Transport controls .....	804
Tracks overview .....	808
What is a track? .....	808
Using tracks to sequence content to the beat .....	808
The track editor .....	809
Creating and managing tracks .....	814
Adding and removing sections .....	816
Working with Notes .....	819
Cue List .....	823
Jumping track bars .....	828

### **Content mapping Overview**

Types of mappings .....	831
Content mapping Overview .....	833
Types of mappings .....	833
Mapping types overview .....	835
Creating a new mapping .....	838
Process used to create a new mapping .....	838
Common mapping properties .....	840
Mapping types overview .....	842
Direct mapping .....	845
Creating a Direct mapping .....	846
Common Mapping Properties .....	847
Feed Mapping .....	849

Creating a Feed Mapping .....	850
Feed Mapping Properties .....	851
Using the Feed mapping type .....	853
Parallel mapping .....	861
Creating a Parallel Mapping .....	863
Common Mapping Properties .....	864
Parallel Mapping Properties .....	865
Using the Parallel mapping type .....	866
CameraPlate mapping .....	868
Creating a CameraPlate Mapping .....	868
Common Mapping Properties .....	869
Cylindrical mapping .....	871
Creating a Cylindrical mapping .....	871
Common Mapping Properties .....	872
Cylindrical mapping properties .....	874
Using the cylindrical mapping type .....	874
Perspective mapping .....	876
Creating a Perspective Mapping .....	877
Common Mapping Properties .....	878
Perspective Mapping Properties .....	879
PreComp .....	880
Creating a PreComp .....	880
Building the PreComp .....	881
Using the PreComp as a source for an Effect Layer .....	882
Using the PreComp in multiple tracks .....	883
Previewing a PreComp .....	886
Radial mapping .....	887
Creating a Radial Mapping .....	888
Common Mapping Properties .....	889
Radial Mapping Properties .....	890
Spatial mapping .....	891
Creating a Spatial Mapping .....	891
Common Mapping Properties .....	892
Spatial Mapping Properties .....	894
Spherical Mapping .....	895

Creating a Spherical Mapping .....	897
Common Mapping Properties .....	898
Spherical Mapping Properties .....	899

## **Layers overview**

Types of layers .....	900
Controlling layer properties with Artnet .....	900
Controlling layer properties with OSC .....	900
Creating layers .....	901
Editing layers .....	904
What is the Layer editor? .....	904
Opening / closing the Layer editor .....	904
Layer properties .....	904
MultiLayer Editor .....	905
Dynamic Layer Naming .....	908
Dynamic Layer Naming .....	908
Workflow .....	908
Documentation & Utility .....	909
Layer Stack .....	910
Common layer properties .....	912
Preview Thumbnail .....	913
Brightness .....	914
Content .....	915
Mapping .....	916
Blend Mode .....	918
Colour Shift .....	922
Palette .....	925
xCol yCol .....	926
Controlling layers with Art-Net .....	927
How to control layer properties with Art-Net .....	927
How to enable the layer property to work only between the range 0-1 .....	929
Controlling layers with OSC .....	930
Layer Types Overview .....	933
Types of layers .....	933
Audio .....	938



Bitmap .....	941
TestPattern .....	960
Video .....	978
Legacy video .....	998
RenderStream .....	1018
Overview .....	1018
VideoTrigger .....	1020
VirtualLineup .....	1039
Web .....	1042
Control Layers Overview .....	1066
Types of Control layers .....	1066
Control .....	1068
Command Syntax .....	1068
Ascii examples .....	1069
Hex examples .....	1070
CameraControl .....	1071
CameraControl layer properties .....	1071
Creating/sequencing CameraControl commands .....	1071
Editing CameraControl commands .....	1072
CameraCutControl .....	1074
CameraCutControl Layer Properties .....	1074
Creating CameraCutControl commands .....	1075
DMXLightsControl .....	1077
DMXLightsControl layer properties .....	1077
Creating DMXLightsControl commands .....	1078
Editing DMXLightsControl commands .....	1078
DMXShare .....	1079
DMXShare layer properties .....	1079
MatrixControl .....	1080
MatrixControl layer properties .....	1080
Creating & sequencing MatrixControl commands .....	1081
Using the MatrixControl layer .....	1082
HTTPControl .....	1083
HTTPControl Layer Properties .....	1083
IndirectionControl .....	1084

IndirectionControl Layer Properties .....	1084
Sequencing IndirectionController commands .....	1085
TimecodeMode .....	1086
MasterBrightness .....	1087
MasterBrightness layer properties .....	1088
MatrixControl .....	1092
MatrixControl layer properties .....	1092
Creating & sequencing MatrixControl commands .....	1093
Using the MatrixControl layer .....	1094
MDC .....	1095
MidiNote .....	1096
MidiNote layer properties .....	1096
MTC .....	1097
MTC Layer Properties .....	1097
Open .....	1099
OscControl .....	1102
Command Syntax .....	1103
PlayMode .....	1104
PlayMode Properties .....	1104
ProjectorControl .....	1105
ProjectorControl layer properties .....	1105
TimecodeMode .....	1107
TrackJump .....	1108
TrackJump Layer Properties .....	1108
TransportControl .....	1109
TransportBrightnessLocal .....	1111
TransportControl .....	1112
TransportVolumeLocal .....	1114
Effect Layers Overview .....	1115
Types of Effect layers .....	1115
Blur .....	1116
Common Layer Properties .....	1117
Blur layer properties .....	1125
ChannelRouter .....	1126
ColourAdjust .....	1138

Overview .....	1138
Workflow .....	1138
Common layer properties .....	1139
Compose .....	1149
EdgeFilter .....	1164
Fade .....	1176
FilmicGrain .....	1179
Overview .....	1179
Workflow .....	1179
Common layer properties .....	1180
Kaleidoscope .....	1189
Lut .....	1199
Overview .....	1199
Workflow .....	1199
Common layer properties .....	1200
Lut layer properties .....	1208
MotionBlur .....	1211
Noise .....	1223
Pixelate .....	1233
PixelMap .....	1249
Scroll .....	1263
SpinBitmap .....	1275
Strobe .....	1290
Trigger .....	1303
UVLookup Layer .....	1316
Overview .....	1316
Workflow .....	1318
Common layer properties .....	1319
UVLookup layer properties .....	1327
VideoTransition .....	1329
Generative Layers .....	1350
Bugs .....	1351
Chevron .....	1364
Colour .....	1377
Gradient .....	1389

Overview .....	1389
Layer Properties .....	1390
Common Layer properties .....	1391
Notch .....	1402
Overview .....	1402
Workflows .....	1404
Notch layer properties .....	1409
Radar .....	1413
Readout .....	1426
Display property .....	1426
Common layer properties .....	1426
RGBColour .....	1427
Scan .....	1437
Strobe .....	1447
Tennis .....	1460
Options .....	1471
Control .....	1472
Text .....	1473
Overview .....	1473
Text Layer Properties .....	1474
Readout .....	1476
Display property .....	1476
Common layer properties .....	1476
TrackingMarker Module .....	1477
Overview .....	1477
See How It Works .....	1477
Layer Properties .....	1478
Previsualisation Layers Overview .....	1480
Types of Previsualisation layers .....	1480
AnimateCameraControl .....	1481
AnimateCameraPreset .....	1484
Creating a camera position animation .....	1484
AnimateObjectPreset Layer .....	1488
Creating a AnimateObjectPreset animation .....	1489
AnimateObjectPreset Layer .....	1495

Creating a AnimateObjectPreset animation .....	1496
TargetControl .....	1502
TargetObject .....	1505
TargetPreset .....	1507
Targeting/animating fixtures .....	1508
Opening the Fixture Targets editor .....	1509
Keyframing overview .....	1511
What is the Keyframe editor? .....	1511
Opening a Keyframe editor .....	1511
Keyframe toggles .....	1511
Opening multiple Keyframe editors .....	1512
Keyframe editor types .....	1512
Navigating Keyframe editors .....	1513
Common Keyframe properties .....	1513
Keyframe Options .....	1514
Keyframe Toggle .....	1516
Multiple keyframes .....	1518
Numeric keyframes .....	1524
Editing min/max values .....	1525
Object keyframes .....	1529
Option keyframes .....	1531
Compositing layers .....	1533
Arrow-supported layers .....	1535
Copying and pasting layers .....	1536
Deleting multiple layers .....	1538
Deleting layers .....	1539
Duplicating layers .....	1541
Extending layers .....	1542
Grouping layers .....	1543
Save as and importing layers .....	1546
Isolating layers .....	1551
Locking layers .....	1552
Moving layers .....	1554
Muting layers .....	1555
Renaming layers .....	1557

Selecting multiple layers .....	1558
Splitting layers .....	1559

### **Sockpuppet overview**

What is Sockpuppet .....	1560
Compatibility .....	1560
Sockpuppet overview .....	1563
What is Sockpuppet .....	1563
Compatibility .....	1563
Bank Editor .....	1566
What is the bank editor? .....	1566
Preferences .....	1567
Patch assignments .....	1574
Sockpuppet personality editor .....	1587
Sequencing with Sockpuppet .....	1594
Dormant layers .....	1594
RGB colour overview .....	1594
Video playback modes overview .....	1594
Toggle Sockpuppet .....	1596

### **Indirections**

Overview .....	1597
Workflow .....	1598
Examples .....	1599

### **Universal crossfade overview**

What is Universal crossfade? .....	1608
Crossfade duration .....	1608
Setting up a sequenced transition .....	1612
Universal crossfade overview .....	1613
What is Universal crossfade? .....	1613
Crossfade duration .....	1613

### **Generating textures**

Texture types .....	1618
---------------------	------

## Configuring Overview

Configuring Overview .....	1621
----------------------------	------

### API

Overview .....	1622
What is an API? .....	1622
Opening API Documentation .....	1622
What is a UID? .....	1623
API .....	1624

### Audio overview

Quantising a track and sequencing to the beat .....	1626
Outputting high quality audio .....	1626
AudioAnalyser .....	1626
Quantising audio .....	1627
Setup quantising .....	1632
Advanced quantiser settings .....	1634
Setup audio output .....	1638
Output devices .....	1638
Concepts .....	1638
Setup audio output .....	1643
Output professional audio .....	1648
Output multi-channel audio .....	1650
Output audio to DA converters .....	1658
Audio Waveform View .....	1662

### d3Net overview

Setup d3Net .....	1669
The d3Net manager .....	1669
Setup Editors .....	1679
The Director must be running .....	1679
The Director is the authority over show state .....	1679
Edits are first-come, first-serve .....	1679
Director session control .....	1679

Send Transport Commands .....	1680
Editors are allowed .....	1680
Synchronising the project .....	1680
Joining a session .....	1680
Network Adapter .....	1683
Windows network settings .....	1685
General preparation .....	1685
Educational license .....	1700

## **Devices Index**

Devices Index .....	1709
Creating devices .....	1713
Motion control systems .....	1715
Axes .....	1717
Creating Driver Axes .....	1726
Screen Axis Expressions .....	1729
CPS Driver .....	1731
D3SSI Driver .....	1732
DMX Screen Position Driver .....	1733
HMC Driver .....	1734
IPCUSB Driver .....	1735
Kinesys Driver .....	1736
MoSys F4 Driver .....	1739
Movecat Driver .....	1740
Navigator Driver .....	1741
NG360 Driver .....	1743
OSC Driver .....	1744
Posi Stage Net Driver .....	1745
PRG Stage Command Driver .....	1746
PRG Driver .....	1747
Simotion Driver .....	1748
Stage Kinetics MoveCat driver .....	1749
STS Driver .....	1750
Stype Driver .....	1751
Unican Open Cue Driver .....	1752



Visual Act Driver .....	1753
Audio analyser .....	1754
DMX .....	1758
DMXMachineControl Device .....	1765
JSONMachineControl .....	1769
MIDI controllers .....	1773
OSC .....	1780
OSCMachineControl setup .....	1783
OSC tester .....	1786
StringProjectorControl Device .....	1789
Telnet .....	1794
UDP .....	1796
Agile camera setup .....	1797
Visca camera setup .....	1804
Matrix switches overview .....	1809
Direct Matrix Routing .....	1810
Setup Analog Way OPS300 .....	1815
Setup Barco MatrixPro .....	1818
Setup Pure Link Matrix .....	1820
Setup Riedel MediorNet .....	1822
Setup Blackmagic Smart Video Hub .....	1824
Setup Lightware Matrix .....	1826
Setup Telnet Matrix .....	1828
Setup video input .....	1831
4k quad link capture .....	1836
Setting up Quad link 4k Capture .....	1836
CITP .....	1838
Using CITP .....	1838
Device Recording .....	1840
Using Device Recording .....	1840
Expressions .....	1843
Expressions for numeric animations .....	1843
Setting up Expressions .....	1843
	1844
	1844

Expanded Functionality - r21 .....	1844
------------------------------------	------

## **Output Feeds overview**

Rendering Feed movies .....	1846
Output Feeds overview .....	1847
Rendering Feed movies .....	1848
Viewing the Feed level .....	1849
Feed level navigation .....	1852
Selecting Feed rectangles .....	1855
Adding Feed rectangles for screens .....	1856
Editing a Feed Rectangle .....	1859
Using duplicate multiple .....	1875
Number of duplicates .....	1877
Source offset .....	1877
Destination offset .....	1877
Configuring d3Net and feed settings .....	1879
Configuring output settings .....	1880
Configuring VFC card slots .....	1889

## **Setting Project Refresh Rate**

### **10bit displays**

#### **Genlock**

Locking to House Sync within Disguise .....	1901
Configuring Genlock externally to the software (vx 4) .....	1902
Configuring Genlock externally to the software (4x4, 4x2) .....	1902
Configuring Genlock externally (2x4pro, gx machines) .....	1905
Internal Timing Sync .....	1910
Genlock .....	1912
Locking to House Sync within Disguise .....	1913
Configuring Genlock externally to the software (vx 4) .....	1914
Configuring Genlock externally to the software (4x4, 4x2) .....	1914
Configuring Genlock externally (2x4pro, gx machines) .....	1917
Internal Timing Sync .....	1922

## Transports overview

DMX Transports Overview .....	1925
Setup DMX transports .....	1926
Switching tracks with DMX .....	1933
Triggering cues with DMX .....	1935
Midi Transports Overview .....	1937
Midi Transports Overview .....	1937
Mixing MIDI cue types .....	1938
Sending MIDI Timecode .....	1939
Setup MIDI Note .....	1940
Setup MIDI Show Control .....	1946
Troubleshooting MIDI .....	1950
OSC .....	1953
OSC templates .....	1955
OSC syntax library .....	1957
Setup OSC transport .....	1963
Triggering cues with OSC .....	1968
Timecode Transports Overview .....	1973
Transports overview .....	1974
Transport manager .....	1975
Setup LTC .....	1980
Setup MIDI Beat Clock .....	1984
Setup MTC .....	1989
Setup Tap Tempo .....	1991
Timecode Tester .....	1994
Triggering cues with Timecode .....	1995
Troubleshooting LTC .....	1999
Transport manager .....	2001
MultiTransport .....	2006
Cue List .....	2018
Set Lists .....	2023
MultiTransport .....	2025

## Hardware ranges overview

The Disguise Platform .....	2037
Hardware ranges overview .....	2038
Server/ Software Compatibility .....	2039
Plus range overview .....	2043
Solo overview .....	2044
Solo diagrams .....	2046
Powering the system .....	2049
Filter replacement .....	2050
Card Configuration .....	2052
HDMI capture .....	2055
Maximum number of unique inputs .....	2055
Back-Plate layout .....	2055
Technical limitations .....	2055
SDI capture .....	2059
Max Number of Unique Inputs .....	2059
Supported formats .....	2059
Back-Plate Layout .....	2059
10G Ethernet .....	2060
Back-Plate Layout .....	2060
Onboard Audio .....	2061
Pro Audio .....	2062
Update & restore .....	2066
Overview .....	2070
Overview .....	2070
gx 2c Overview .....	2071
gx 2c diagrams .....	2072
gx 2cPerformance .....	2073
Playback .....	2073
Capture Latency .....	2074
Video input .....	2075
Max Number of Unique Inputs .....	2075
Supported formats .....	2075
Back-Plate Layout .....	2076

Unit rear light - gx 2c .....	2077
System Restore - gx 2c .....	2078
gx 3 Overview .....	2089
gx 3 diagrams .....	2090
Front view of gx 3 .....	2090
Front grill down view of gx 3 .....	2090
Rear view of gx 3 .....	2091
gx 3 Specifications .....	2092
4K DCI (4096 x 2160) .....	2092
Quadlink 4K DCI (4096 x 2160 using 4x 2048 x 1080 inputs) .....	2092
UHD (3840 x 2160) .....	2092
Quadlink UHD (3840 x 2160 using 4x 1920 x 1080 inputs) .....	2092
2K DCI (2048 x 1080) .....	2093
Full HD (1920 x 1080) .....	2093
HD (1280 x 720) .....	2093
Hardware .....	2093
gx 3 .....	2095
Playback .....	2095
Capture Latency .....	2097
Video input .....	2098
Max Number of Unique Inputs .....	2098
Supported formats .....	2098
Back-Plate Layout .....	2099
Unit rear light - gx 3 .....	2100
Rear panel LED light .....	2100
Update & restore .....	2101
SMC System Management Controller .....	2105
What is System Management Controller - SMC? .....	2105
Common Operations - gx range .....	2113
Powering the gx range .....	2114
Power input .....	2114
Cabling .....	2114
How to start the unit .....	2115
Starting the Unit .....	2115
Audio input and output .....	2117

Back panel connections .....	2117
Front panel connections .....	2119
Managing EDIDs .....	2120
Video output .....	2125
Pro range overview .....	2126
vx 1 Overview .....	2127
vx 1 diagrams .....	2128
Hard drive configuration - vx 1 .....	2130
Media Drives .....	2130
vx 1 Video input .....	2131
Max Number of Unique Inputs .....	2131
Back-Plate Layout .....	2132
Redisguise vx .....	2133
vx 2 overview .....	2138
vx 2 diagrams .....	2139
Hard drive configuration - vx 2 .....	2141
Media Drives .....	2141
vx 2 Video input .....	2142
Max Number of Unique Inputs .....	2142
Back-Plate Layout .....	2143
Redisguise vx .....	2144
VX 2+ Overview .....	2149
VX 2+ Overview .....	2151
Overview .....	2151
VX 2+ diagrams .....	2153
Front view of VX 2+ .....	2153
Front grill down view of VX 2+ .....	2153
Rear view of VX 2+ .....	2154
VX 2+ Specifications .....	2155
4K DCI (4096 x 2160) .....	2156
Quadlink 4K DCI (4096 x 2160 using 4x 2048 x 1080 inputs) .....	2156
UHD (3840 x 2160) .....	2156
Quadlink UHD (3840 x 2160 using 4x 1920 x 1080 inputs) .....	2156
2K DCI (2048 x 1080) .....	2156
Full HD (1920 x 1080) .....	2156

HD (1280 x 720) .....	2157
VX 2+ Performance .....	2158
Playback .....	2158
Capture Latency .....	2160
VX 2+ Video input .....	2161
Max Number of Unique Inputs .....	2161
Supported formats .....	2161
Back-Plate Layout .....	2162
Update & restore .....	2163
vx 4 overview .....	2167
vx 4 diagrams .....	2170
Hard drive configuration .....	2173
Media drives .....	2173
RAID Configuration .....	2174
vx 4 Video input .....	2186
Max Number of Unique Inputs .....	2186
Back-Plate Layout .....	2187
Redisguise vx .....	2188
You will need .....	2188
Create Bootable USB device .....	2189
Booting into the USB .....	2191
vx 4+ overview .....	2192
vx 4+ diagrams .....	2193
vx 4+ Hard drive configuration .....	2195
Media drives .....	2195
RAID Configuration .....	2196
vx 4+ Video input .....	2208
Max Number of Unique Inputs .....	2208
Back-Plate Layout .....	2209
Update & restore .....	2210
You will need .....	2210
Create a Bootable USB .....	2211
Booting into the USB .....	2212
Common Operations - vx range .....	2213
Powering the pro range .....	2214

How to start the vx .....	2215
Starting the Unit .....	2215
Unit rear light .....	2218
Managing EDIDs .....	2219
Emulating EDIDs .....	2219
Exporting EDIDs .....	2223
Resetting EDIDs .....	2226
Audio input and output - vx .....	2227
Back panel connections .....	2227
Front panel connections .....	2227
Video output .....	2229
4K Output .....	2230
SMC System Management Controller .....	2233
What is System Management Controller - SMC? .....	2233
rx range Overview .....	2241
rx + rx II diagrams .....	2242
Powering the rx .....	2244
How to start the unit .....	2245
Redisguise - rx range .....	2246
EX 3 Overview .....	2252
EX 3 Overview .....	2255
EX 3 diagrams .....	2258
EX 3 Licensing Options .....	2261
EX 3 Performance .....	2263
Update & restore - EX 3 .....	2267
Legacy Machines .....	2272
v2.5 hardware overview .....	2273
4U machine .....	2273
Support .....	2275
v2.5 hardware overview .....	2276
4U machine .....	2276
Support .....	2278
Removable media drives .....	2279
How are the removable drive bays arranged? .....	2279
Flashing an Active Silicon card .....	2281



Overview of SDI input .....	2285
How many inputs can each machine have? .....	2285
Configuring SDI capture .....	2286
Setting up live video input in d3 .....	2292
Windows Updates .....	2293
How to Install the Intel update .....	2293
Identifying the hardware version .....	2296
Locating the serial number .....	2296
Updating the software .....	2297
Factory system restore - v2.5 .....	2298
Restoring your system .....	2300
QuickTime Pro .....	2309
MacDrive 9 .....	2309
Graphics cards configuration .....	2310
What graphics card does my d3 machine have? .....	2310
Managing Displays .....	2313
12HD Playback Configuration .....	2315
Viruses and malware .....	2319
Recommended virus scanner .....	2319
Audio cards .....	2320
What audio card does my machine have? .....	2320
Audio breakout .....	2325
Why do I need a breakout cable? .....	2325
2x2plus overview .....	2327
Plus range diagrams .....	2328
Powering the system .....	2330
Filter replacement .....	2331
Card Configuration .....	2333
DVI Capture .....	2337
Technical limitations .....	2337
Optional SDI Video Capture .....	2341
LED Indicators .....	2341
Onboard Audio .....	2343
Pro Audio .....	2344
Update & restore .....	2348

2x4pro overview .....	2355
2x4pro diagrams .....	2356
Powering the 2x4pro .....	2357
Unit rear light - 2x4pro .....	2360
How to start the unit .....	2361
Update System - 2x4pro .....	2363
Overview .....	2363
Internal Restore .....	2363
REDISGUISE .....	2368
Video input .....	2374
Max Number of Unique Inputs .....	2374
Supported formats .....	2374
Back-Plate Layout .....	2375
Video output .....	2376
4K Output .....	2377
Audio input and output .....	2378
Back panel connections .....	2378
Front panel connections .....	2379
RME card settings .....	2379
4x2pro overview .....	2380
4x2pro diagrams .....	2381
Powering the 4x2pro .....	2386
How to start the unit .....	2389
Unit rear light .....	2391
Update System - 4x2pro .....	2392
Overview .....	2392
Internal Restore .....	2392
REDISGUISE .....	2397
Video output .....	2403
Video input .....	2404
Max Number of Unique Inputs .....	2404
Supported formats .....	2404
Back-Plate Layout .....	2405
Audio input and output .....	2406
Back panel connections .....	2406

Front panel connections .....	2406
RME card settings .....	2407
4x4pro overview .....	2408
4x4pro .....	2408
4x4pro diagrams .....	2410
4x4pro Performance .....	2411
Playback .....	2411
Capture Latency .....	2412
Powering the 4x4pro .....	2413
How to start the unit .....	2416
Unit rear light .....	2418
Update System - 4x4pro .....	2419
Overview .....	2419
Internal Restore .....	2419
REDISGUISE .....	2424
Creating a RAID array .....	2430
Hard drive configuration .....	2432
Media drives .....	2432
Importing RAID from different system .....	2434
Raid Controller .....	2438
Advanced RAID Controller Information .....	2440
MegaRaid LSI Controller .....	2440
Physical View .....	2442
Logical View .....	2443
Shield State .....	2443
Shield State Physical View .....	2444
Logical View Shield State .....	2444
Viewing the Physical Drive Properties .....	2444
Device Icons .....	2445
Configuration .....	2446
Creating a New Configuration .....	2446
Selecting Virtual Drive Settings .....	2446
Creating a Virtual Drive Using Simple Configuration .....	2448
Creating a Virtual Drive Using Advanced Configuration .....	2451
Removing a Drive from a Configuration .....	2457

Replacing a Drive .....	2457
Maintaining and Managing Storage Configurations .....	2458
Upgrading Firmware .....	2459
Unconfigured Bad .....	2462
Restore Unconfigured GOOD state .....	2463
Video input .....	2464
Max Number of Unique Inputs .....	2464
Supported formats .....	2464
Back-Plate Layout .....	2465
Video output .....	2466
4K Output .....	2467
Audio input and output .....	2468
Back panel connections .....	2468
Front panel connections .....	2468
RME card settings .....	2469
gx 1 overview .....	2470
gx1 diagrams .....	2472
Powering the gx range .....	2473
How to start the unit .....	2476
Update System - gx 1 .....	2478
Overview .....	2478
Internal Restore .....	2478
REDISGUISE .....	2483
Unit rear light .....	2489
Video input .....	2490
Max Number of Unique Inputs .....	2490
Supported formats .....	2490
Back-Plate Layout .....	2491
Video output .....	2492
4K Output .....	2493
Audio input and output .....	2494
gx 2 Overview .....	2495
gx range diagrams .....	2496
gx 2 Performance .....	2498
Playback .....	2498

Capture Latency .....	2499
Powering the gx range .....	2500
How to start the unit .....	2503
Update System- gx 2 .....	2505
Overview .....	2505
Internal Restore .....	2505
REDISGUISE .....	2510
Unit rear light .....	2516
Video input .....	2517
Max Number of Unique Inputs .....	2517
Supported formats .....	2517
Back-Plate Layout .....	2518
Video output .....	2519
4K Output .....	2520
Audio input and output .....	2521
Back panel connections .....	2521
Front panel connections .....	2521
RME card settings .....	2522
fabric Overview .....	2523
fabric Quick Start .....	2525
VFC Cards .....	2528
IP-VFC Overview .....	2530
IP-VFC Overview .....	2532
Inroduction to the IP-VFC .....	2532
IP-VFC ST 2110 .....	2534
What is ST 2110? .....	2534
IP-VFC - Ports .....	2536
Ports .....	2536
IP-VFC - PTP .....	2537
What is PTP? .....	2537
IP-VFC - NMOS .....	2538
What is NMOS? .....	2538
IP-VFC - Split Mode .....	2539
Split Mode .....	2539
IP-VFC - Interoperability .....	2540

Interoperability .....	2540
IP-VFC - Backplane upgrade .....	2542
Upgrading your backplane to support IP-VFC .....	2542
IP-VFC .....	2543
Specifications SDI .....	2543
IP-VFC .....	2545
Specifications ST 2110 .....	2545
IP-VFC - System configuration .....	2548
System Configuration .....	2548
25Gb SFP support .....	2549
25Gb SFP support .....	2549
IP-VFC SDI SFP support .....	2550
SDI SFP support .....	2550
IP-VFC Implementation .....	2551
Implementation .....	2551
IP-VFC Workflow .....	2563
IP-VFC Workflow .....	2563
IP-VFC Update .....	2565
Check IP-VFC Firmware .....	2565
Update IP-VFC Firmware .....	2566
IP-VFC FAQs .....	2567
VFC Cards .....	2569
Update VFC Card Firmware .....	2571
VFC card Replacement .....	2575
EDID overview .....	2581
Managing EDIDs .....	2584
DisplayPort FAQs .....	2589
Filter Maintenance .....	2593
Filter Maintenance .....	2601
Machine Performance .....	2609
Machine Monitoring Graphs .....	2611
Machine Performance .....	2628
 <b>Workflows Overview</b>	
VP Workflow Overview .....	2631

2.5D Workflows .....	2633
Cuebric Integration .....	2639
Mesh mapping .....	2643
Shot Recorder .....	2645

### **xR Workflow Overview**

Camera switching .....	2651
Colour calibration .....	2655

### **Observations**

#### **Set extension**

xR Spatial Calibration .....	2668
------------------------------	------

#### **Spatial Tracker Delay**

xR Stage Alignment Overview .....	2680
-----------------------------------	------

#### **Video receive delay**

#### **Virtual Zoom**

#### **xR Project Setup**

xR stage setup .....	2694
RenderStream .....	2696
RenderStream .....	2698
RenderStream Resources .....	2699
RenderStream Layer .....	2705
Inner-Outer Frustum Workflow .....	2720
RenderStream Failover .....	2722
Vicon Emulator .....	2723
Prerequisites .....	2727
Request a license .....	2727
Set up the Vicon Virtual System with Disguise .....	2727
Further reading .....	2730

RenderStream and Notch .....	2731
RenderStream and Unity .....	2734
RenderStream & TouchDesigner .....	2747
RenderStream and Unreal Engine .....	2750
RenderStream and Unreal Engine .....	2751
UE Project Setup .....	2752
3D object transforms .....	2756
Exposed Parameters .....	2760
Level Sequences .....	2762
Remote Texture Sharing .....	2764
Remote Text Parameters .....	2766
Scene Levels and Maps .....	2767
Multi-User Editing .....	2772
Shared DDC setup .....	2774
Scene Optimization .....	2782

## **AR workflow**

3D fundamentals overview .....	2788
Understanding .obj files .....	2789
Exporting 3D models .....	2790
Optimising 3D models .....	2796
Orientation .....	2799
Helpful Resources .....	2800
Position .....	2801
Helpful Resources .....	2803
Scale .....	2804
Helpful Resources .....	2805
UV mapping overview .....	2806
What is UV mapping? .....	2807
Example UV map .....	2807
Helpful Resources .....	2808
How does d3 sample UV maps? .....	2809
Normalising UV maps .....	2810
Helpful Resources .....	2811
Editing UV maps .....	2812



Helpful resources .....	2815
Rendering UV maps to content templates .....	2816
The UV map as the content template .....	2821
Helpful Resources .....	2827
The UV map as the hardware output .....	2828
LED screen examples overview .....	2831
Example 1: MiSTRIP star .....	2832
Example 2: OLite column .....	2840
Example 3: DNA Spiral .....	2845
The UV map of the DNA spiral. ....	2845
Example 4: Millenia Tower .....	2848
How the UV map is generated .....	2848
Projection Examples Overview .....	2851
Cylindrical mapping .....	2852
Helpful resources .....	2856
Pelt mapping .....	2857
For more information: .....	2860
Perspective Mapping .....	2861
Pixel-perfect mapping .....	2867
Helpful resources .....	2873
Planar mapping .....	2875
Helpful Resources .....	2878
Shrink wrapping .....	2879
Helpful Resources .....	2883
Spline mapping .....	2884
Helpful Resources .....	2888
EVO .....	2889
Capture .....	2907
Projector Calibration .....	2909
Overview .....	2909
Manual Calibration - Projectors .....	2910
Multi-Pose Projection Calibration Overview .....	2919
Calibration errors .....	2920
Quick Calibration overview .....	2923
Quick Calibrating - Projectors .....	2929

Remove a reference point from the projector .....	2931
Rotate Controls .....	2931
Lineup output mode .....	2931
Cursor Types .....	2934
Marker Size .....	2936
Reset options .....	2936
Removing reference points .....	2938
Delete unused reference points .....	2938
Delete unparented reference points .....	2938
Delete all reference points .....	2938
Advanced options .....	2939
Creating & deleting reference points .....	2941
To create reference points: .....	2941
To delete a reference point .....	2944
OmniCal Overview .....	2945
Overview .....	2945
Workflow .....	2945
Hardware .....	2949
Tips & tricks .....	2951
Troubleshooting .....	2953
OmniCal Camera setup .....	2955
Network setup .....	2955
Network Adapter Setup .....	2956
Configuring cameras in Vimba .....	2962
Focus, aperture and focal length .....	2963
Further Reading .....	2964
OmniCal Capture .....	2965
Workflow Example .....	2965

## **OmniCal Calibration & alignment**

OmniCal Multi-pose alignment .....	2974
Prerequisites .....	2974
Extract Good Meshes .....	2975
Create poses for each moving screen .....	2976

## OmniCal Rig-check

Accessing rig-check .....	2980
Using rig-check .....	2980
DMX .....	2983
Art-Net .....	2985
sACN .....	2986
Enttec .....	2987
Soundlight .....	2987
EZDMX .....	2987
Kinet V1 and V2 .....	2987
DMX Transports Overview .....	2989
Setup DMX transports .....	2990
Switching tracks with DMX .....	2997
Triggering cues with DMX .....	2999
Sockpuppet overview .....	3001
What is Sockpuppet .....	3001
Compatibility .....	3001
Patch assignments .....	3004
DMX .....	3004
OSC .....	3013
Bank Editor .....	3017
What is the bank editor? .....	3017
Preferences .....	3018
Sockpuppet personality editor .....	3024
Sequencing with Sockpuppet .....	3031
Dormant layers .....	3031
RGB colour overview .....	3031
Video playback modes overview .....	3031
Toggle Sockpuppet .....	3032
EVO .....	3033
ISAAC Bridge .....	3052
Workflow .....	3053

## VR

Opening the virtual reality navigator .....	3057
Using HTC Vive for virtual camera tracking .....	3058

### **disguise cloud**

Overview .....	3060
Cloud Dashboard .....	3060
disguise Drive .....	3060
Previz .....	3061
Mapping Matter .....	3061
disguise cloud .....	3062
Overview .....	3062
Cloud Dashboard .....	3062
disguise Drive .....	3062
Previz .....	3062
Mapping Matter .....	3063
disguise cloud .....	3064
Creating a Cloud account .....	3066
Create a Disguise Cloud account .....	3066
Sign up with Google .....	3066
Join with email .....	3067
Sign in .....	3067
Sign out .....	3067
d3 Manager Cloud Login .....	3068
d3 Manager Cloud Login & Licensing .....	3068
Editing your profile .....	3069
Edit your account details .....	3069
Working with organisations .....	3070
Create a new organisation .....	3070
Member management .....	3071
Invite a new member to an organisation .....	3071
View recent invites .....	3071
Troubleshooting .....	3072
Create a support ticket .....	3072

Known Issues .....	3073
The sign in button has stopped working when the browser was closed during sign-up. ....	3073
Disguise Cloud avatar is cropped. ....	3073
Cloud login on Designer is not yet localised. ....	3073
Using drive .....	3074
Rename a drive .....	3075
Create a folder .....	3075
Rename a folder .....	3075
Delete a folder .....	3076
Using drive .....	3077
Set up a drive .....	3077
Rename a drive .....	3078
Create a folder .....	3078
Rename a folder .....	3079
Delete a folder .....	3079
Working with content .....	3080
Supported file formats .....	3080
Upload content .....	3080
Preview content .....	3081
Leave a comment on an asset .....	3081
View the Metadata of an asset .....	3082
Add timestamped comments on a video .....	3083
Download an asset .....	3084
Delete an asset .....	3085
Access recently deleted files .....	3085
Creating a Previz .....	3086
Uploading Content .....	3087
Guest Accounts .....	3089
Guest Accounts .....	3089
Video Specifications .....	3093
Previz .....	3096
Getting Started .....	3099
Navigating the Viewer .....	3102
Creating a Previz .....	3103

Renaming a Previz .....	3104
View and Open Files .....	3106
View Modes .....	3108
Scenes .....	3111
Editing Scenes .....	3113
Illumination .....	3113
Global Lighting .....	3114
Global Ambient Light .....	3114
Global Hemisphere Light .....	3115
Model Positioning .....	3115
Set to Defaults .....	3117
Camera Bookmarks .....	3118
Preparing Scenes .....	3121
Uploading 3D Models .....	3123
Exporting .glTF files from Blender .....	3125
File Format Variations .....	3125
Include .....	3125
Transform .....	3125
Geometry .....	3125
Animation .....	3125
Default Options .....	3126
Reference Links .....	3127
Creating a Share Link .....	3128
Create a Share Link in View Mode .....	3128
Video Specifications .....	3130
Mapping Matter Introduction .....	3133
Introduction .....	3133
Mapping Matter Introduction .....	3136
Introduction .....	3136
Data .....	3136
Supported Browser .....	3136
OS .....	3136
API .....	3137
Who is it for? .....	3137
Who is it not for? .....	3138

Mapping Matter Getting Started .....	3139
Getting Started .....	3139
Pan .....	3143
Orbit .....	3143
Zoom-in & out .....	3144
Switch to another Point Of View (POV) .....	3144
Create a Primitive .....	3146
Customize a Primitive .....	3146
Select .....	3148
Rename an Object .....	3148
Delete an Object .....	3149
Hide / Show any Object of your Scene .....	3149
Lock the properties of any Object in your Scene .....	3149
Move (or Duplicate) an Object .....	3150
Using the Movement Gizmo in the Viewport .....	3150
Using coordinates in the properties panel .....	3151
Using two reference points .....	3152
Move an Object A in orbit of an Object B .....	3153
Rotate an Object .....	3153
Material .....	3154
Apply Gain .....	3155
Apply Color .....	3156
Apply Base Map .....	3156
Apply a Projection Map (Projection Texture) .....	3157
Use Side to make it transparent .....	3158
Use Wireframe to make it transparent .....	3158
Parent Child Hierarchy .....	3160
Arrays and Symmetries .....	3161
Create a Linear Array .....	3161
Create a Polar Array .....	3162
Create a Symmetry .....	3163
Convert your dummy Objects into regular Objects .....	3164
Annotations and Dimensions .....	3164
Create an Annotation or Dimension Object in your Scene .....	3165
Edit an Annotation or Dimension .....	3166

Mapping Matter Projectors & Cameras .....	3167
Projectors/ Cameras .....	3167
Create (or Swap) a Projector .....	3167
Create a Project in your Scene .....	3167
Swap a Projector from your Scene .....	3167
Cameras .....	3177
Camera Projectors .....	3180
Mapping Matter Viewport & Brightness .....	3183
Viewport/Brightness .....	3183
Viewport Settings .....	3183
shaderlog .....	3183
Show Object Edges .....	3183
Show Projector Infos .....	3183
Show All Projector Beams .....	3184
Viewport Background .....	3184
Global Material Override .....	3185
Show Grid .....	3185
Projection Distance Helper .....	3185
Photometric Analysis .....	3187
Evaluate Illuminance and Luminance .....	3188
Brightness Settings .....	3189
Auto Viewport Range .....	3190
Projection Texture .....	3190
Ambient / Directional Light .....	3190
Mapping Matter Libraries .....	3192
Libraries .....	3192
Use Tags not Folders .....	3192
Select and Import a 3D Asset .....	3193
Organize your 3D Assets .....	3193
Manage all pre-existing Projectors .....	3196
Add a custom Projector to your Library .....	3197
Select and Import an Image / Video .....	3198
Organize your Texture Library .....	3198
Mapping Matter Share .....	3201
Share .....	3201



Share a Projector .....	3202
Share a Texture .....	3202
Share a 3D mesh .....	3203
Share a Viewer Only link .....	3204
Mapping Matter Print & Export .....	3206
Print/Export .....	3206
Save a Snapshot from your Scene .....	3206
Mapping Matter My Account .....	3211
My Account .....	3211
Mapping Matter FAQs .....	3213
FAQs .....	3213
The Reverse Mirror type .....	3214
Porta 2.0 Overview .....	3221
Porta 2.0 Overview .....	3221
Porta Release Notes .....	3222
Porta 2.0 Overview .....	3226
User Roles .....	3227
Designer .....	3227
Operator .....	3227
IT Engineer .....	3227
User Interface .....	3228
Keyboard Shortcuts .....	3235
Default Keyboard Shortcuts .....	3235
Customize keyboard shortcuts .....	3236
Customising Layouts .....	3237
Workspaces .....	3237
Working with Unreal Engine .....	3239
Technical requirements .....	3239
Sample projects .....	3239
Introduction .....	3239
Unreal Engine Workflow .....	3240
Porta Workflow .....	3251
Connect an Unreal Engine project to Porta .....	3251
Log in to Porta .....	3252
Create a project in Porta .....	3252

Introduction to Templates .....	3254
Template Builder .....	3254
Open Template Builder .....	3255
Create an Unreal template using Template Builder .....	3255
Form Components .....	3259
Supported file formats .....	3260
Template Builder buttons .....	3260
Add a form component .....	3261
Remove a form component .....	3261
Add a custom form component .....	3261
Edit a template component .....	3262
Create a new playlist .....	3266
Import playlists .....	3267
Export playlists .....	3267
Create a new page from a playlist .....	3268
Duplicate a page .....	3269
Numeric pages .....	3270
Enable numeric pages .....	3270
Play a graphic .....	3271
Group page items .....	3272
Assign a channel to a project .....	3273
Set a default channel for all projects .....	3273
Loading levels .....	3275
Camera Switching .....	3276
Working with Designer .....	3280
Technical requirements .....	3280
Connect a Designer project to Porta .....	3280
Troubleshooting .....	3283
Help Menu .....	3283
Support Contact Form .....	3283
Porta 2.1 Overview .....	3284
Porta 2.2 Overview .....	3286
px & px+ .....	3287

**Scheduling events**

**Index**

# What is Disguise?

The Disguise software is a real-time 3D simulator & media server that integrates traditional lighting fixtures, LED screens and projection surfaces into one easy to use package.

## Pre-production

Disguise integrates a real-time 3D Stage Visualiser, media playback, and a timeline. It lets you model the stage, view it instantly from any angle, drop video or still content onto the timeline and play it back onto the stage, without time-consuming re-renders. It is therefore a very useful communication tool in the early stages of a project. Showing a real-time simulation of a proposed design is faster, cheaper and more effective than traditional renderings and fly-throughs. In the preproduction stage, it allows designers, clients and artists to quickly visualise content and make artistic decisions, without having to actually build the stage.

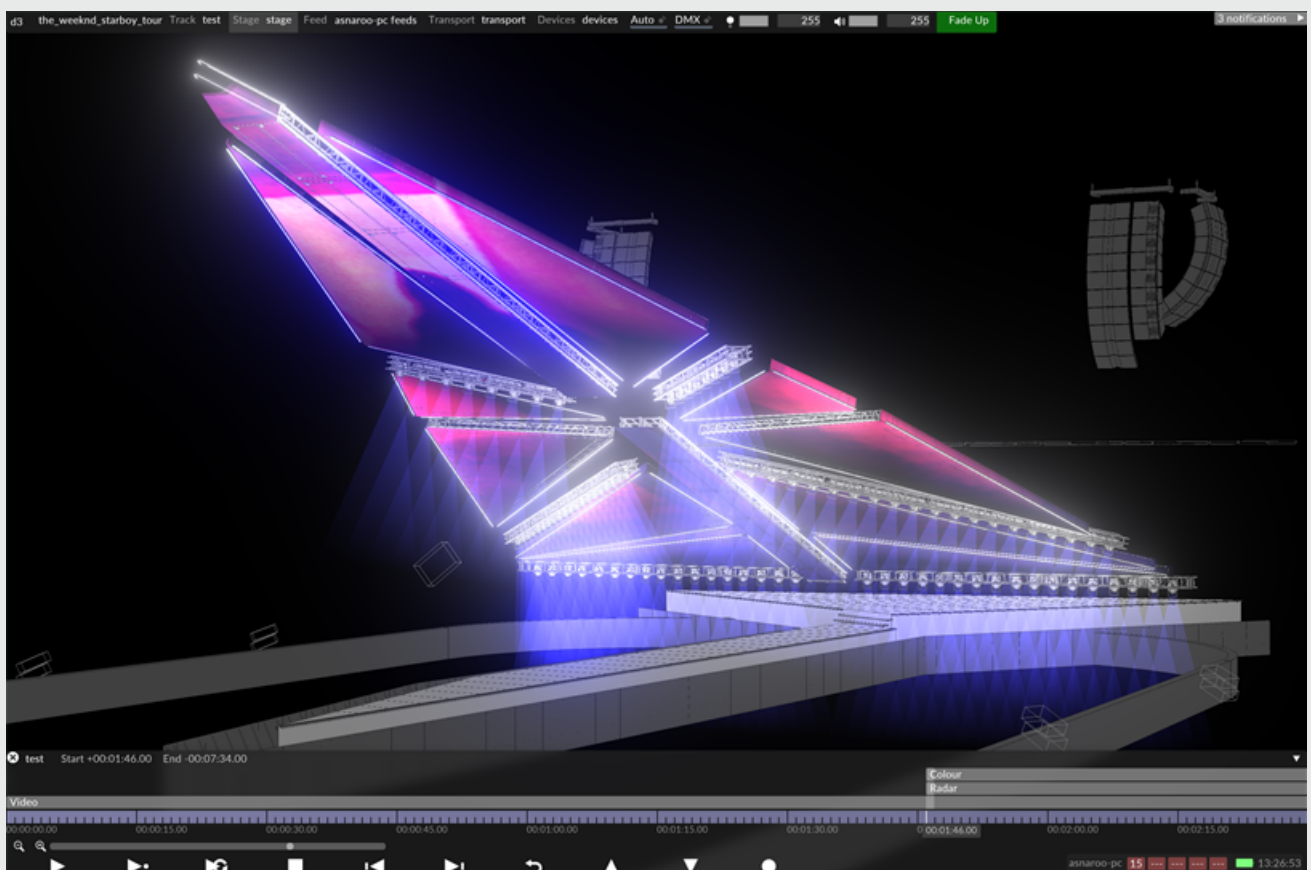

*Stage Visualiser used as an essential 3D visualisation and simulation tool in the pre-production phase.*

## Rehearsals and live production

However, Disguise goes further than mere visualisation; it is designed to integrate with the traditional tools of show delivery (lighting desks, audio and automation systems). The Disguise software contains all the video playback functions you would expect to find in a conventional media server, together with a sophisticated timeline-based show control mechanism. Coupled with the Stage Visualiser, Disguise allows the designer to edit and sequence a complete show, present it to the client and get a sign-off, long before the real stage is built.

Once the real stage is set up, you bring Disguise (with the completely sequenced show) into the production rehearsal, plug it in, and press play. Thanks to the Stage Visualiser, a highly realistic simulation of the actual stage, you are guaranteed that the show will look the same on the real screen as it does in the Stage Visualiser, aside from a bit of tweaking (and we give you an arsenal of tools to do this).



*Disguise being used in the production rehearsals of The Weeknd Tour 2017.*



The added value of this is simple it saves time, and therefore money. Disguise allows you to shift crucial work forward in time, so you can spend time on making the right decisions before you go into production rehearsals and start spending money. Disguise acts as a central focus for the production team, making sure that everyone can review everything so that mistakes are caught early, aesthetic blind avenues are identified and avoided, and content is made to maximise the potential of the stage.



*Disguise used as an essential tool to successfully deliver The Weeknd show onto the stage, on time and on budget*

# Main Elements

The Disguise software comprises three main elements: the Timeline level, the Stage level and the Feed level.

Disguise's key insight is to separate these three levels and to perform the mapping between them in real time. Changes to any level can be made independently of the others; a change in the screen layout or output formatting does not require a change of content.

## Timeline level

The Timeline level consists of a timeline containing a number of content layers. On the timeline, you can create multiple layers of video or generative content and position it on the timeline. By adding keyframes you can control properties such as playback speed, brightness, colour, etc. Multiple layers can be combined onto one single output canvas by using a selection of blending modes. This environment is familiar to users experienced with commercial video editing software tools.

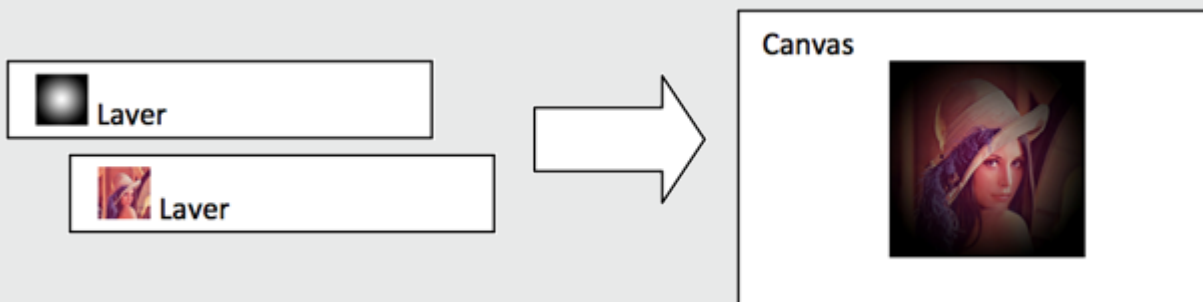

*Timeline Concept*

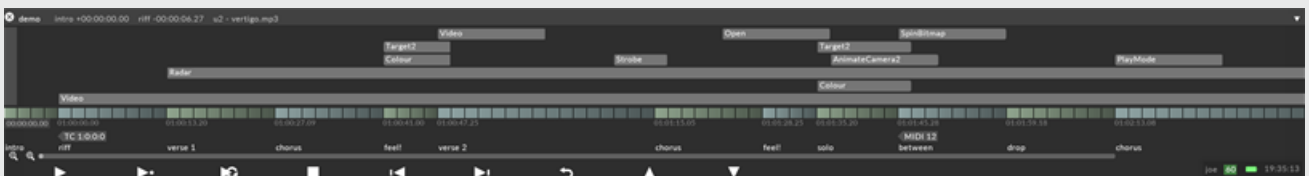

*Timeline level sequencing video and generative content*

# Stage level

The Stage level simulates your stage. It allows you to create any number of screens in all kinds of shapes. Each screen can be placed at any position, orientation, scale and set to any resolution (up to 8k in one direction) within the 3D scene. In addition, each screen has its own target canvas with an adjustable resolution. You can turn anything you want into a screen, even entire 3D buildings, and design your content with projectors, LED screens, or DMX lighting fixtures in mind.

The Stage can be created to precisely simulate the real stage that Disguise will be connected to, with each and every pixel represented. Content generated by the layers in the Timeline is mapped onto the target canvases of the screens, allowing you to visualise the content in 3D from any point of view.

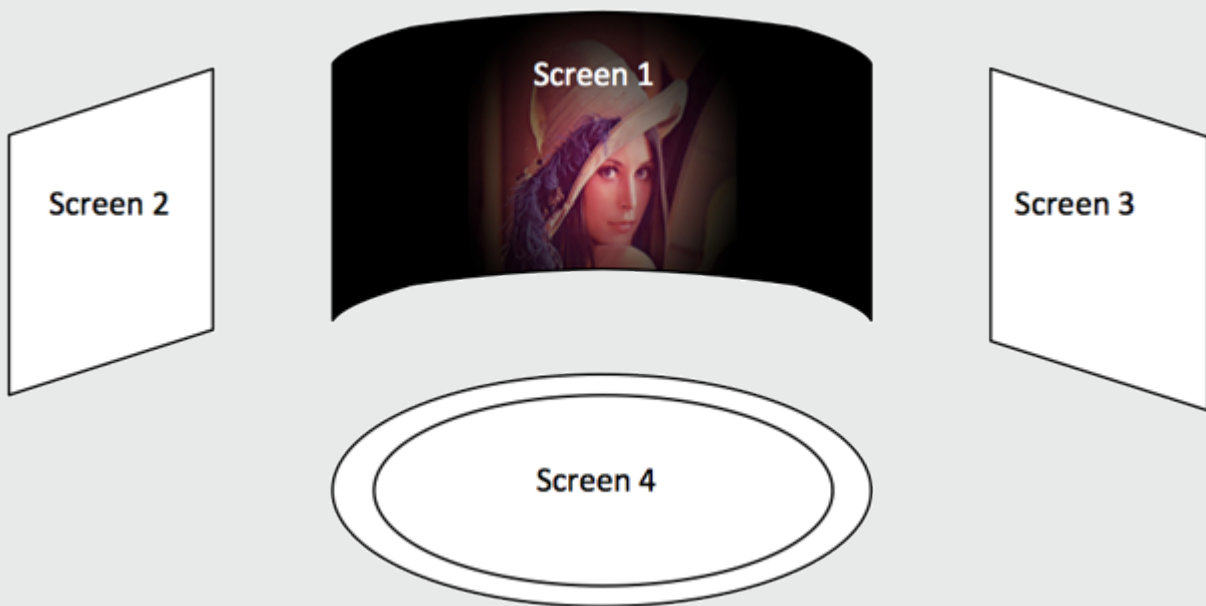

*Stage level conceptual diagram*



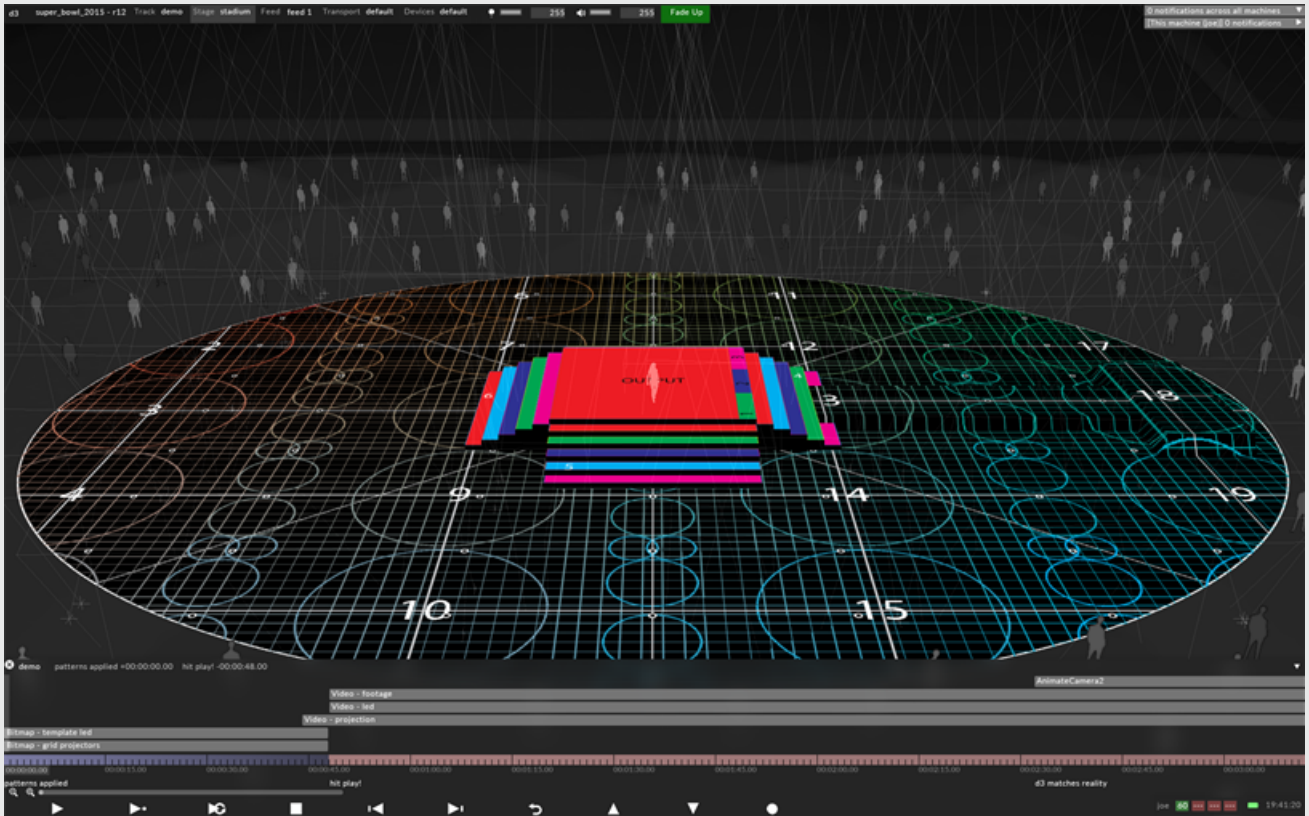

Stage level visualising and simulating the set of the Superbowl.

## Feed level

The lowest level, the Feed level, comes into play when you connect d3 to the real world: the LED screens, projectors, plasma displays, or DMX lights on your stage. It allows for the 2D output screen content to be formatted according to the requirements of the receiving LED processor, projector, or lighting system.

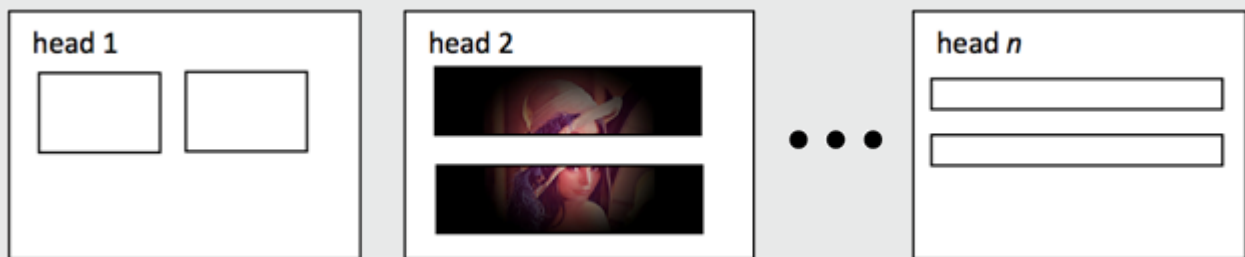

Feed level conceptual diagram

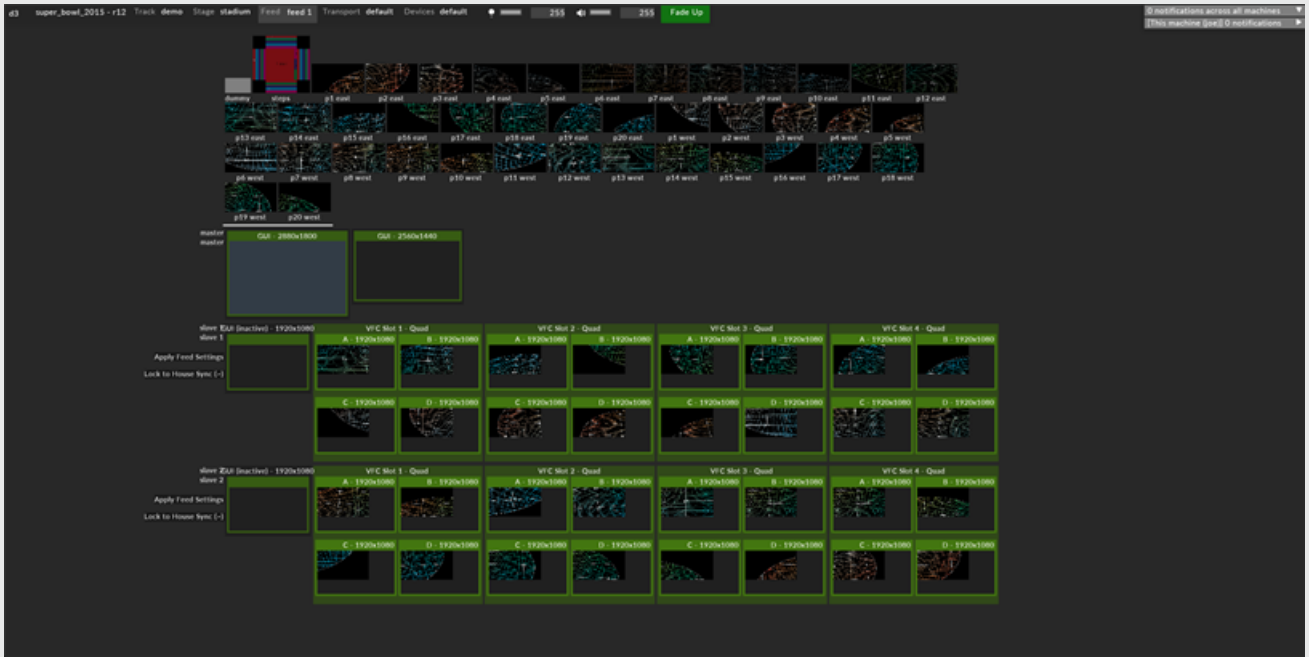

Feed level formatting the screen content to a projector system for the Superbowl.

## Real-time mapping

Disguise's key insight is to separate the Timeline level, Stage level and Feed level and perform the mapping between them in real time. Changes to any level can be made independently of the others; a change in the screen layout or output formatting does not require a change of content.

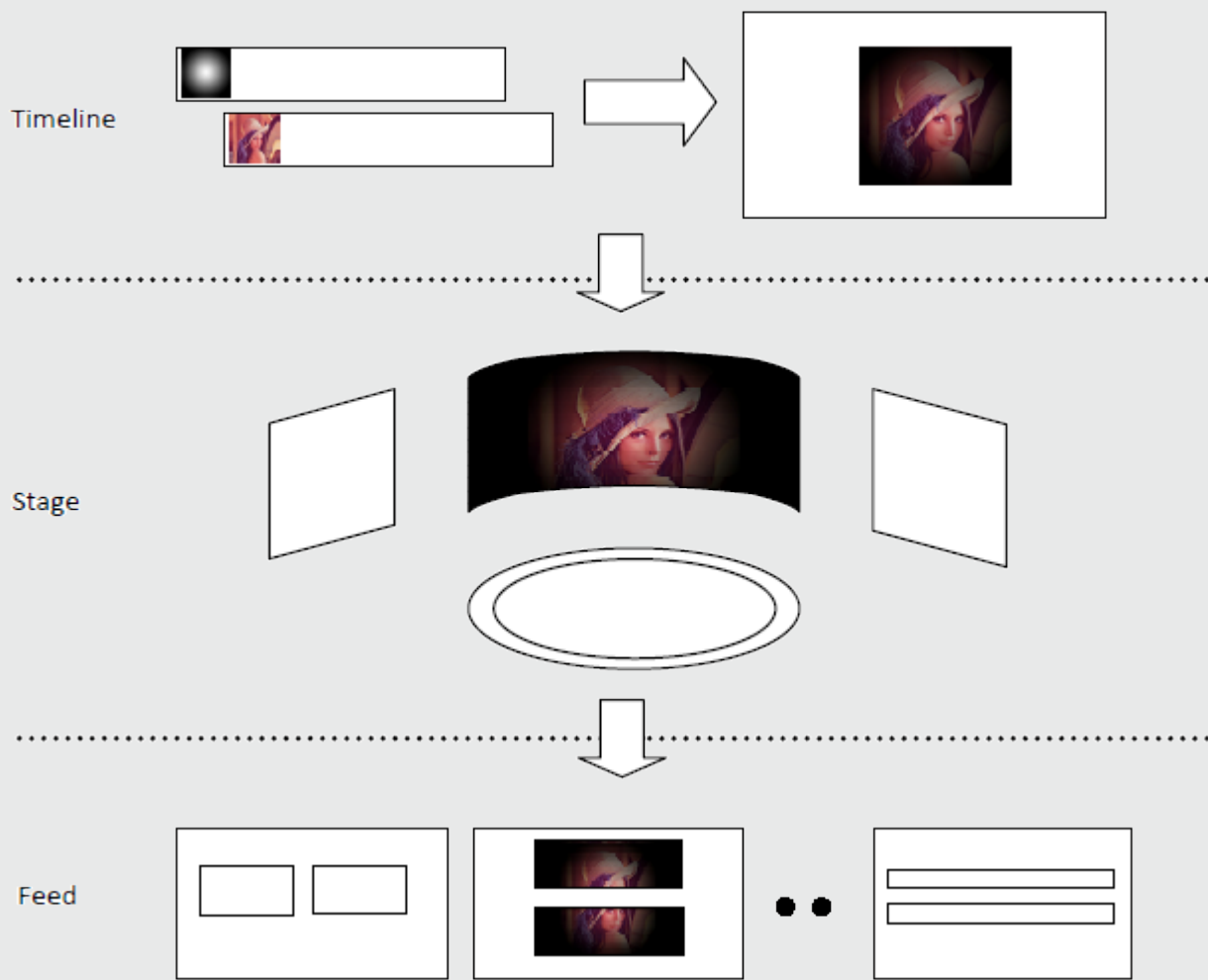

*Real-time mapping between levels conceptual diagram.*

# Designer overview

Designer is a software only version of the Disguise production suite built for designers, project managers and technicians.

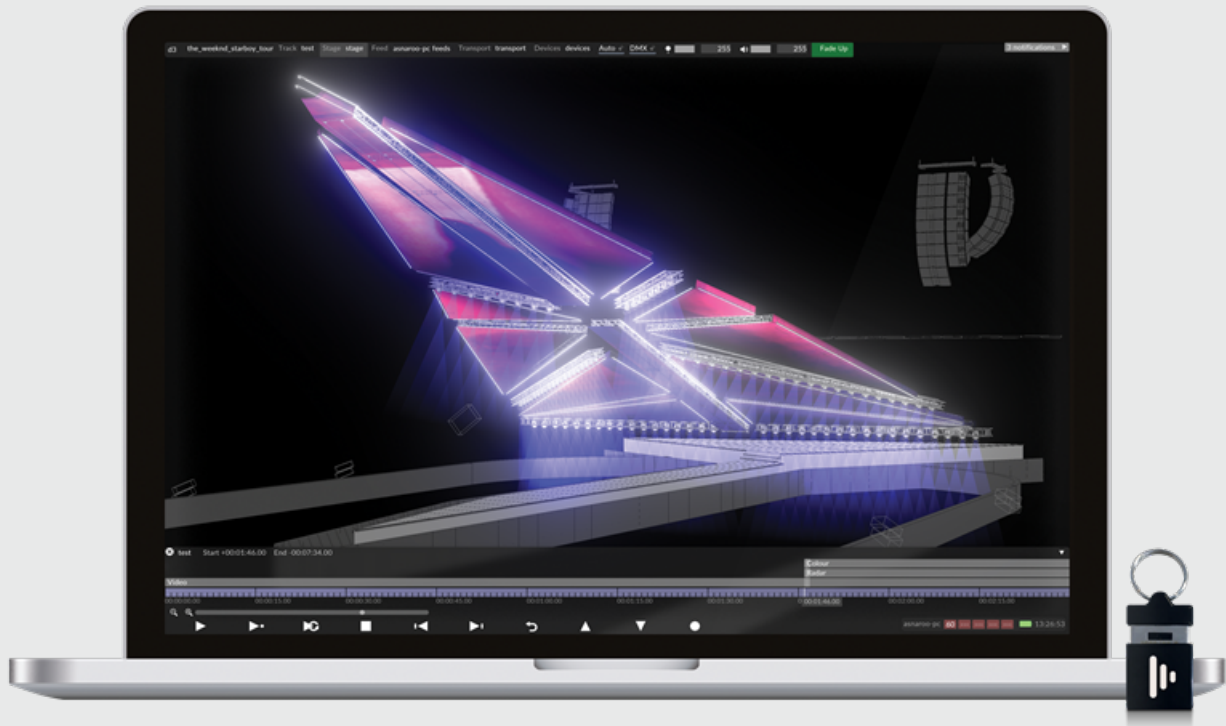

Designer enables you to design, configure, and present your show using your own laptop or desktop computer, and then transfer to a rack-mounted system for showtime. In production rehearsals, Designer also allows you to multi-edit the show from your laptop. For more info about the Designer product see the [Designer page](#) on the [Disguise website](#).

**Please note:** while Designer can remotely edit shows running on Rackmount Machines using the MultiEdit feature, it cannot run shows as a Director.

# System Requirements



**Warning:** Disguise requires a 64-bit operating system.

## Recommended hardware specifications for running Designer

---

Operating System	Windows 10 or 11, 64-bit.
GPU	2GB Video RAM , DX11 compatible (only single graphics cards are supported at present)
CPU	Intel i7 3rd Generation
Memory	4GB RAM (min. 2GB)
Audio	Any permitted
Storage	50+GB (min. 8 GB)

---

## Operating system

To run the latest version of [Designer](#) your system needs to have a Designer license. Licenses can be obtained via the [Disguise Cloud](#), and either installed directly on the machine (dongle-less solution), or they may be installed on a USB Codemeter dongle, available for purchase from the [disguise webstore](#).

# Virtual Machines - Parallels

Virtual Machines like Parallels do not run Disguise software, since Disguise requires DirectX11. Bootcamp may be used, but only if you are working on a pre-M1/M2 Mac platform.

## Designer software

For information on how to install the latest version of Designer please see the sub-chapter [Updating the software](#).

If you encounter any issues with the installation of the Designer software or license, please contact the [Support Team](#) for assistance.

# Download and Install Designer

## Starting the download installer

**Please note:** before updating the software make a manual backup copy of your .d3 project file (not the whole projects folder), which is located in the specific Projects folder. If there is a problem running the new release you will need to revert to the backed up .d3 file.

1. Ensure that your USB license stick (if applicable) is not plugged into your PC.
2. Ensure your PC is connected to the internet.
3. Download the latest executable Designer release from [here](#).

## Installing Disguise software

### Step 1: Install location

On the first screen you will be prompted to select an installation directory for the program files.

1. Open the downloaded executable.
2. Select **Browse** to change your installation directory.
3. Select **OK** to return to the d3 installer window.

4. Select **Next** once you are happy with the installation directory. If you are upgrading an existing installation of Disguise software, the installer will detect and use your current installation directory.

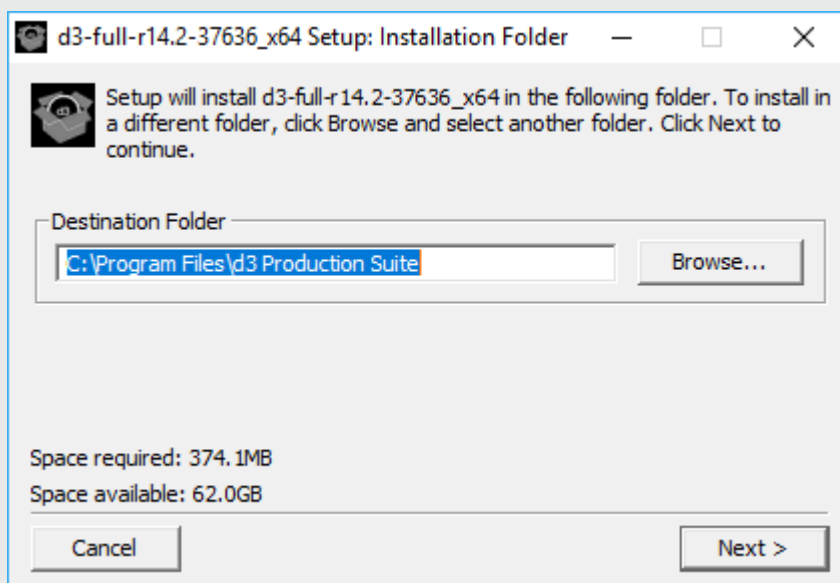

*Selecting an installation directory for the Disguise program files*

## Step 2: End User License Agreement ( EULA )

You will be prompted to read and accept the EULA and all associated licenses.

1. Read the EULA and all associated licenses information.
2. Select **I Agree** to continue.



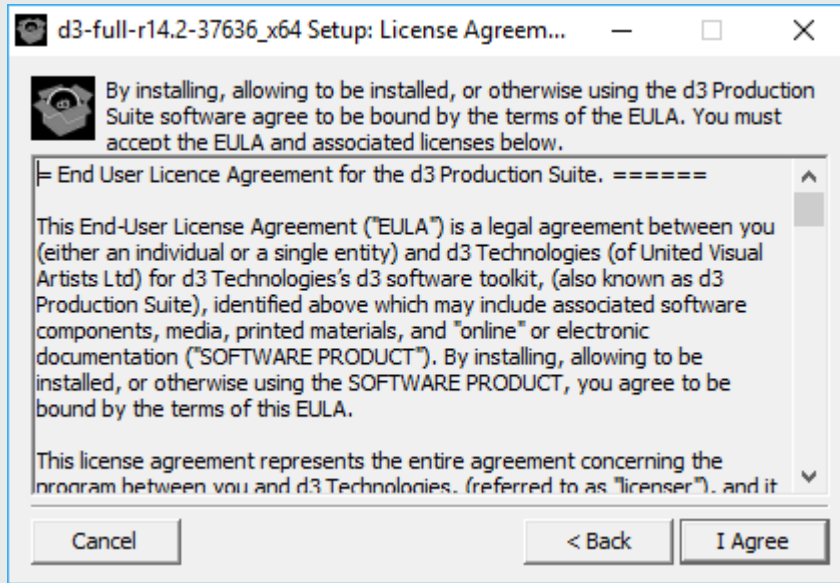

*End User License Agreement for the Disguise Production Suite*

## Step 3: Component selection

Next, you will be prompted to select which components you wish to install.

1. Select the boxes to tick or un-tick components.
2. Select **Next** once you are happy with the selected components.

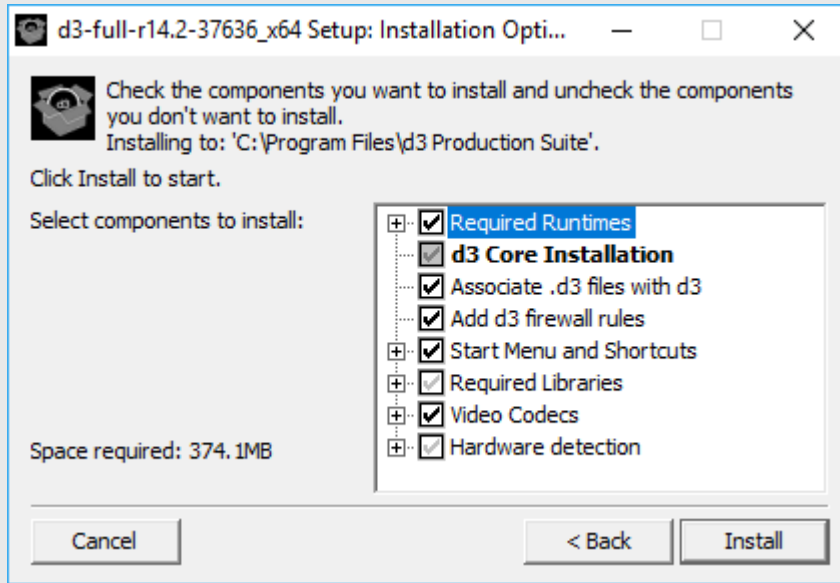

*Selecting components to install*

**Please note:** if the installer detects that you already have a given supporting component installed (e.g. QuickTime or CodeMeter drivers), the installer may deselect that component to avoid unnecessary re-installation.

## Step 4: Projects directory selection

**Installing for the first time:** if you are installing Designer for the first time you will be prompted to choose a directory for your projects. By default this is placed in your Documents folder; however you may wish to place it in another fast storage drive (e.g. SSD drive).

**Upgrading from a previous version:** if you are upgrading from a very old version of Disguise (pre-R10) the system will automatically detect and use the current Projects folder and you will not see the screen where you can change your Project folders directory. From R10 onwards you are free to choose the location of your Projects folder.

## Step 5: Installation

Your files will now install into their appropriate location.

Left-click **Close** once the installation is complete.

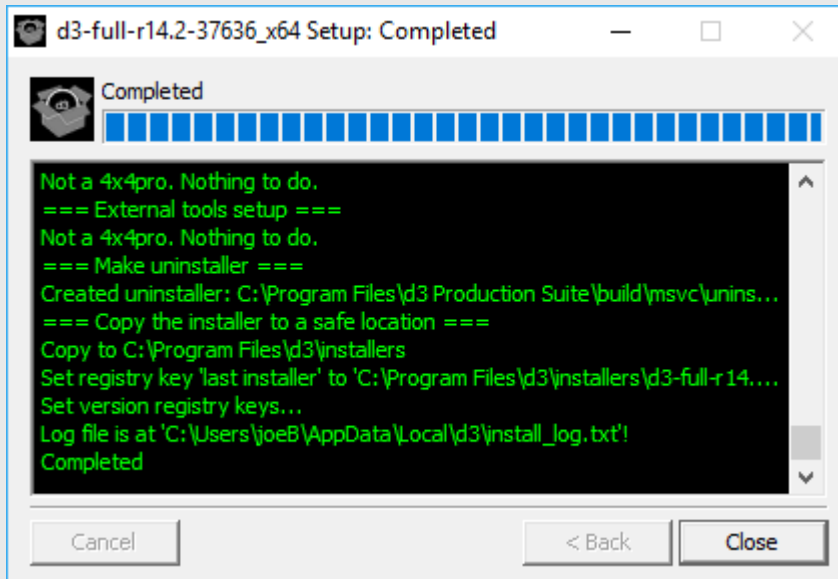

## Uninstalling Disguise software

1. Open the Windows Start menu (bottom left of screen).
2. Navigate to **Control Panel, Programs & Features**
3. Double-click **d3**.
4. Follow the on screen instructions.

**Please note:** if any unpredicted problems arise during installation/uninstallation please send the auto-generated console file to support@disguise.one. For step-by-step instructions on

how to do this please see the chapter [Diagnostics](#).

Additionally, installs supporting libraries for your convenience. These can be uninstalled manually if they are not used by any other software on your PC. These are:

- Select CodeMeter Drivers
- Select QuickTime Player
- Select Java Runtime Environment

# Licensing

## Overview

Designer licenses are available through disguise Cloud, available for free through the dashboard. The Designer license can be stored on your dongle.

Sign up for your free license [here](#).

The physical dongle is USB based and can be used to host other supported licenses such as Notch as well as Designer.

The software based option is tied to your physical machine, and currently cannot be moved between machines. The software based option is ideal for customers who do not often switch machines and are happy to have less portability.



**Warning:** Notch blocks cannot currently be pre-visualised using the software based license. This is due to Notch licensing limitation.

	Dongle	Software based
Portability	Yes	No
Notch pre-visualisation	Yes	No
License activates immediately	No	Yes
Time block licenses	Yes	No
Run Disguise software without a dongle	No	Yes

# Dongle based license

## Obtaining a license

1. Dongle based licenses come in two parts.
  - a. The first part being a physical Codemeter dongle which can either be purchased from Disguise, or users can use another Codemeter dongle. For example, the Notch dongle can also host a Designer license.
  - b. The second part is the license itself, which, after purchase from the Disguise web store, will be emailed to you in the form of a link.
2. Once you have the two items, you can proceed to activate your license.

## Activating a license

1. Ensure you have the latest version of Disguise software downloaded and installed on your machine.
2. Ensure your USB dongle is plugged in
3. Using google chrome, go to the [web depot](#)
4. Enter your ticket ID which was defined in the email confirmation you received from the Disguise web store. the ticket ID format will be **XXXXX-XXXXX-XXXXX-XXXXX-XXXXX**.
5. Click **Retrieve**
6. On the following page click **Activate Licenses**

Your Designer license is now on the USB dongle and will begin counting down usage time when Disguise software is launched for the first time.

# Launching Disguise software

Once your license is installed, you can proceed to [launch](#) or [create](#) a project to load Disguise software.

## Viewing your license information

License information is available in Manager.

**Help > d3 licenses.**

## Software only based license

### Obtaining a license

1. Software based licenses (dongle-less) do not require a physical USB dongle and can be activated on a PC as soon as your web order is completed.
2. Once you have your activation code, you can proceed to activate your license.

### Activating a license

1. Ensure you have the latest version of Disguise software downloaded and installed on your machine.
2. Using google chrome, go to the [web depot](#)
3. Enter your ticket ID which was defined in the email confirmation you received from the Disguise web store. the ticket ID format will be **XXXXXX-XXXXXX-XXXXXX-XXXXXX-XXXXXX**.
4. Click **Retrieve**

5. On the following page click **Activate Licenses**

Your Designer license is now on your local machine and will begin counting down usage time.

## Launching Disguise software

Once your license is installed, you can proceed to launch or create a project to load Disguise software.

## Viewing your license information

License information is available in Manager.

**Help > d3 licenses.**



# Identifying the version

You can identify the version of Designer you are running in a number of ways.

**Please note:** that you may only have one version of Designer installed at a time.

## Option 1

To see what current release you have installed on your system go to the **d3manager > Help > About d3manager**.



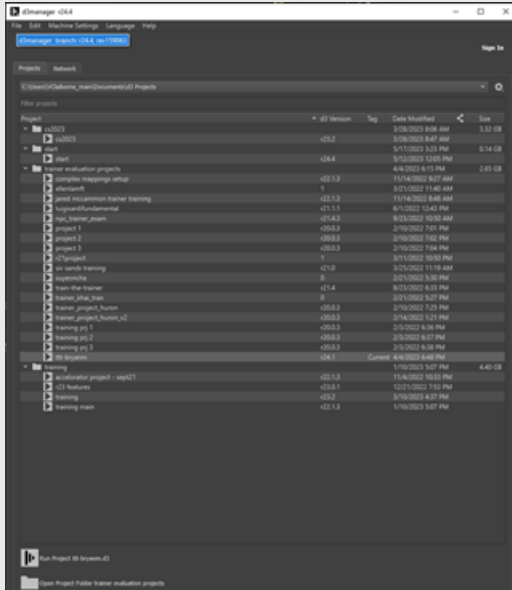

A tooltip box with the version number activated by placing the mouse over the menu bar

### Option 3

Alternatively, when you start Disguise software, it displays a startup screen while loading the project. This consists of the logo at the bottom right of the screen, along with the version identifier. This consists of two numbers: the major release (such as Release 13, 14 and 15 etc) and the build revision (for example revision 35000, 36000, etc).



current release and build revision number displayed whilst project is loading

## Option 4

You can also see which release and build revision you are running in the d3 Options menu.

To open the d3 Options menu:

1. Right-click **d3** from the Dashboard (bar at the top of the screen).
2. Left-click **About d3**.

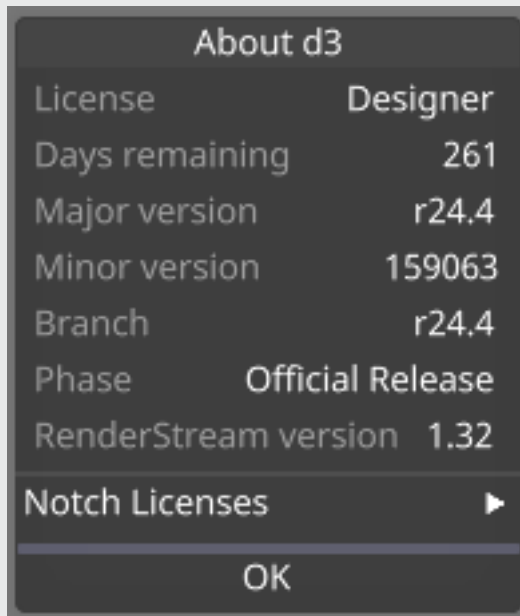

*current release and build revision number displayed in the d3 Options menu.*

# Macbook Pro Retina driver issues

In 2012 Apple released a range of Macbook Pro's with Retina displays containing the NVidia 650M. Apple shipped a set of Bootcamp drivers (used to support Windows on a MBP) with these machines and have since released updates. The Bootcamp drivers that ship with the Macbook Pro present varying screen resolutions to the program as it tries to start. This can cause failure to start issues for Designer.

## Solution

1. Install the latest NVidia Drivers for the 650M from <http://www.nvidia.co.uk/page/drivers.html>
2. Disable Aero Theme
  - a. Right-click on the Windows Desktop
  - b. Click **Personalize**
  - c. Choose the '**Windows 7 Basic**' theme
3. Disable Aero Peek Preview (in Windows 7)
  - a. Right-click the Windows task bar and choose **Properties**
  - b. Disable the check box: **Use Aero Peek to preview the desktop**

Completing these three actions should solve the majority of issues with the Retina Macbook Pro. However, if you are still facing issues, please contact the [Support Team](#).

# Video capture

The Designer software can capture video from any [DirectShow](#) device, such as a webcam or other device.

To read how to set up live video input see [Setting up live video input in Disguise](#).

# APIs

## Developer Portal

### The disguise developer portal

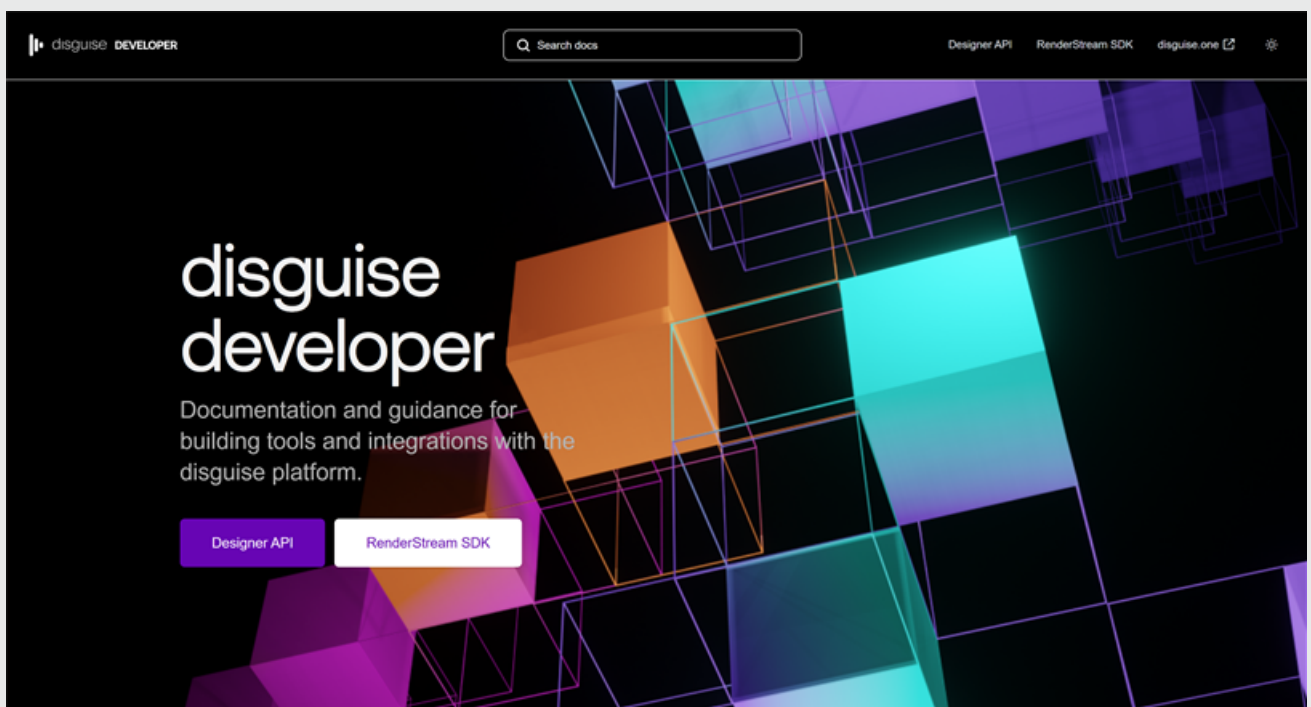

Documentation and guidance for building tools and developing integrations for disguise products

You can find documentation for all of disguise's Designer APIs at the developer portal, [developer.disguise.one](https://developer.disguise.one).

The developer portal supports the control and monitoring of disguise media servers and Designer software using a comprehensive HTTP API.

An HTTP API is an API that uses Hypertext Transfer Protocol as the communication protocol between the two systems. HTTP APIs expose endpoints as API gateways for HTTP requests to have access to a server.

## The disguise approach to APIs

### — **Workflow Centric**

APIs and SDKs designed to compliment and integrate with disguise workflows.

### — **Developer Focused**

The developer portal has been designed with the developer experience in mind.

### — **Integration Support**

We are happy to support integrations with our products. Contact us for integration support and partnerships.

## d3manager OpenAPI Documentation

Documentation for our disguise Designer APIs is also hosted within Designer.

To access API documentation from d3manager navigate to

**Help > Open API Documentation**. Note that this documentation uses the OpenAPI format which means that you can execute APIs from within the documentation.



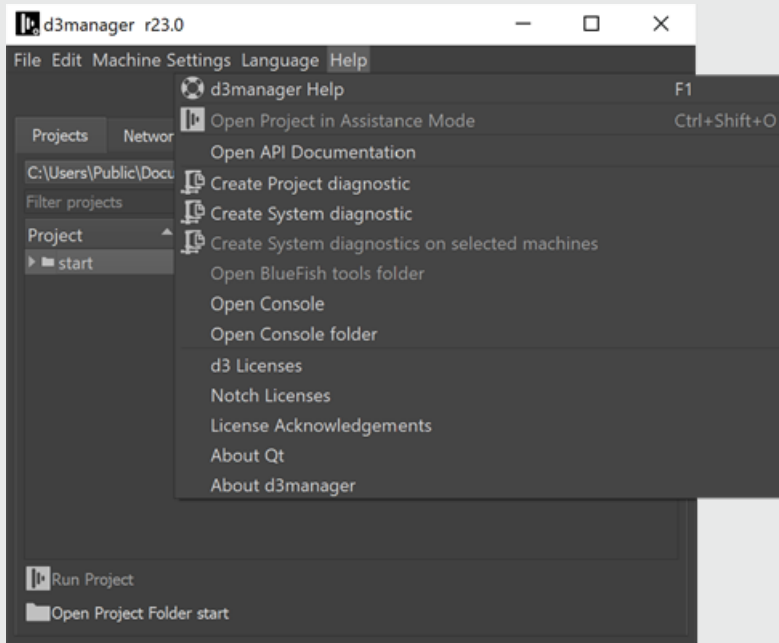

# Viruses and malware

Viruses and other malware are potential problems that should be considered when using any software.

## Recommended virus scanner

One option you can use to scan your machine for viruses and malware without reducing performance is [ClamWin](#). ClamWin is an open source virus scanner that does not have any active background scanning and can be run from a USB pen drive or other. You can also download [ClamWin Portable](#), which is a very handy portable app.

# What's new in r26

## r26 - Battle tested.

New features for an enhanced Designer experience.

**build: 168310 (released September 14 2023)**

Please sign in to your Cloud account to download Designer r26 from [here](#).

Or download all current and previous releases from the [Download centre](#).

## Improvements

- **DSOF-16666** Simple FBX mesh support:

The FBX file format can now be successfully imported into Designer as a single mesh. These can be used in the schematic, lux and heatmap renderers. Any FBX mesh will be imported with global positions, and non-triangulated meshes are triangulated on import. FBX files are imported with UV maps.

It is important to note the following mitigations with this feature:

- Object hierarchies found within the FBX file in Designer are currently not supported
- FBX files imported with up to 3x UV maps are supported. Designer uses the first UV map only and there is currently no way to switch between each UV map.

**FBX file format support can be used with the option switch enabled. To access, right-click on a project folder in d3manager, select 'Advanced project settings' and then select 'enableFbxMeshImport'. Please contact [product-team@disguise.one](mailto:product-team@disguise.one) for feedback on this feature.**

- **DSOF-22271** TransportJumpCommand locations should use time adjusted by timecode tag when using timecode location.

When making a TransportJumpCommand in the TransportControl module, the location value has the option of being set with 'CUE <cue>' or timecode.

In previous releases, when there are timecode tags on the track that a user wants to specify a location on, the timecode displayed in the GUI is based on the timecode tags, but the location that the TransportJumpCommand uses does not take the timecode tags into account.

In r26, the location for TransportJumpCommand now uses the time adjusted by timecode tags when using the timecode location.

- **DSOF-23321** Show RenderStream proxy stream status in the GUI.

We have added RenderStream proxy information in the RenderStream Editor widget.

- **DSOF-23699** Make list/grid view selection for media/texture browsers persistent.

In previous releases, the behaviour of the media and texture browser in Designer was not persistent when a user would switch between grid view and list view. In r26 we have made the selection of grid or list view in the media/texture browser to remain persistent across all machines running in a session.

- **DSOF-23810** Add FBX ASCII format for Shot Recorder export.

Users can now export data from the Shot Recorder to the FBX ASCII format.

- **DSOF-24041** XR: improve usability of Tracker Delay UI.

We have made a number of changes to the Tracker Delay UI. These include changing the overlay colour from magenta to red to signify when no tracking data was captured, or the delay is set to too low or too high. We have also introduced help text in a number of areas of the UI to provide instruction on the Tracker Delay process.

— **DSOF-24066** Alert the user when video lookup times becomes unstable or if errors are high.

We have added a visible notification within the UI to notify users that the video receive delay is set incorrectly during the spatial calibration process when working with MR Sets. The calibration will be highlighted in red, and hovering over the row with a mouse will explain that there is a video receive delay error and to perform the delay calibration again.

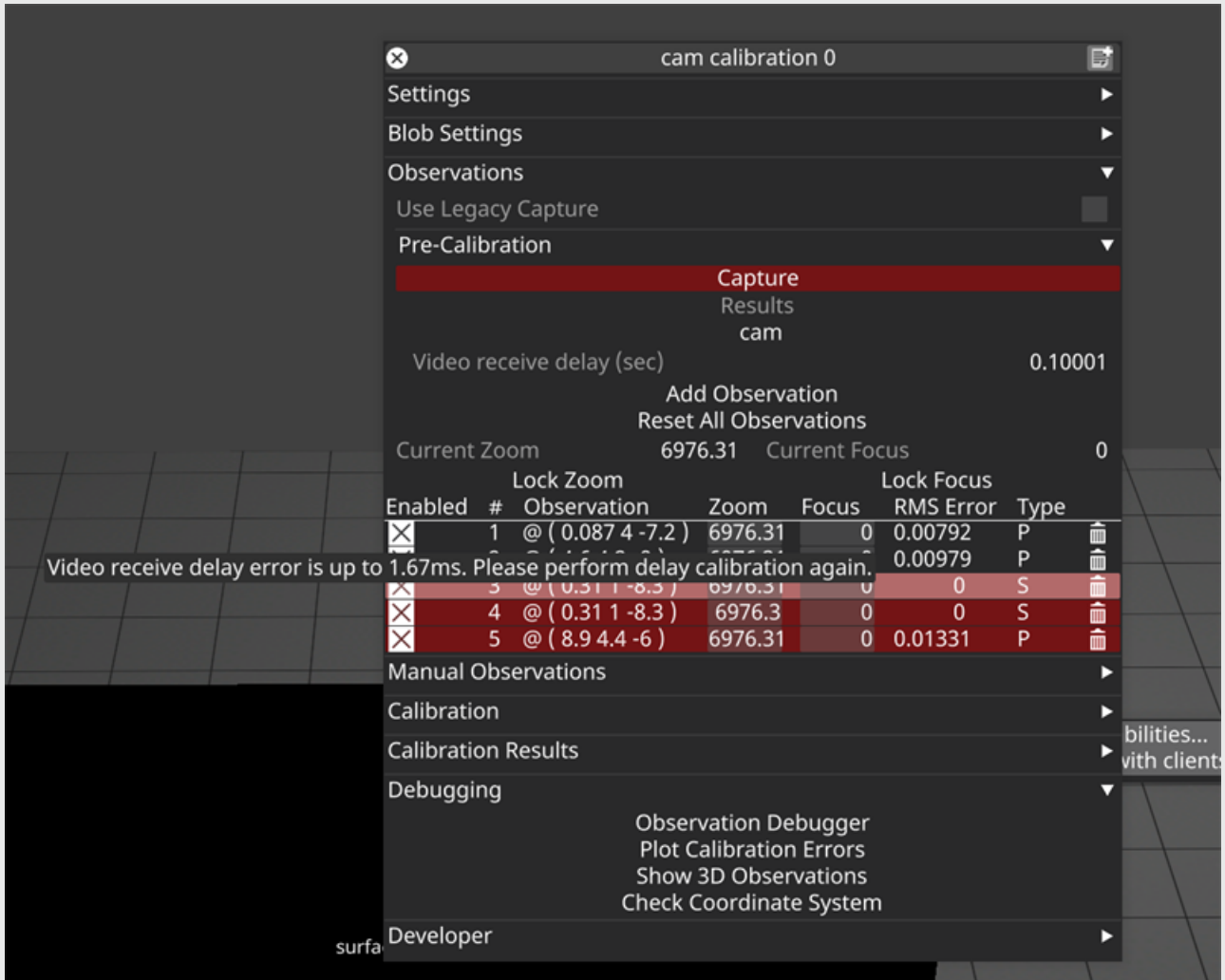

— **DSOF-24089** DSV capture: minor performance optimisations.

— **DSOF-24090** DSV capture: add dropped frames detection.

— **DSOF-24099** Shorten RenderStream workload/stream friendly names for the UI.

In previous releases, RenderStream workloads and streams were identified within the UI through a 64 bit unique ID to enable users to reference each stream. In r26 we have shortened the RenderStream workload names to make it more straightforward for a user to reference each RenderStream workload.

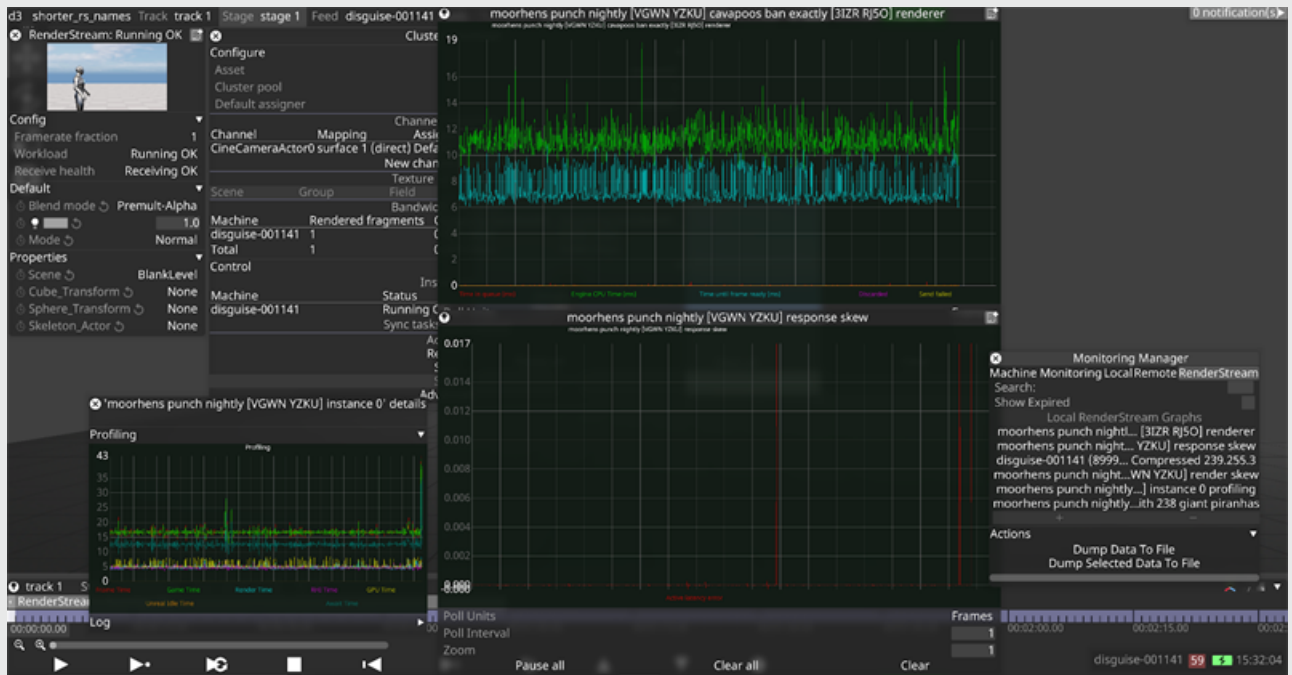

— **DSOF-24153** Expressions: if expressions are broken, the layer they are used in should change colour as well as the parameter.

In previous releases, if an incorrect Expression had been written then this would be flagged to the user by turning the parameter orange in colour.

In r26 we have included the layer that is using the Expression to also change to red in colour so that the user is notified that the Expression is incorrect. If the layer is in a group, then the group will turn red when the layer it contains turns red.

We have also included an error message on the layer via a tooltip. If a user corrects the Expression then the layer will return to its default colour.

- **DSOF-24160** Better texture buffer management for LogicalVideoInDevice.
- **DSOF-24166** Make list editors stickyable.

In r26 we have enabled users to pin ListEditors to the Designer UI by clicking the pin in the top left hand side of each ListEditor as seen in the image below.



- **DSOF-24271** Change default location for d3 Projects to D:Drive after reimaging a disguise media server.

In r26 we have changed the default location for d3 Projects to be in the D:Drive after reimaging a disguise media server. In previous releases, a user would be pointed towards the Documents folder whereas all Designer projects should be located in the D:Drive.

- **DSOF-24375** Include display master brightness in the feed UI.

We have included the master brightness of LED screens and projectors within the feed UI. This can be seen as a percentage underneath the name of each screen, as shown in the screenshot below.

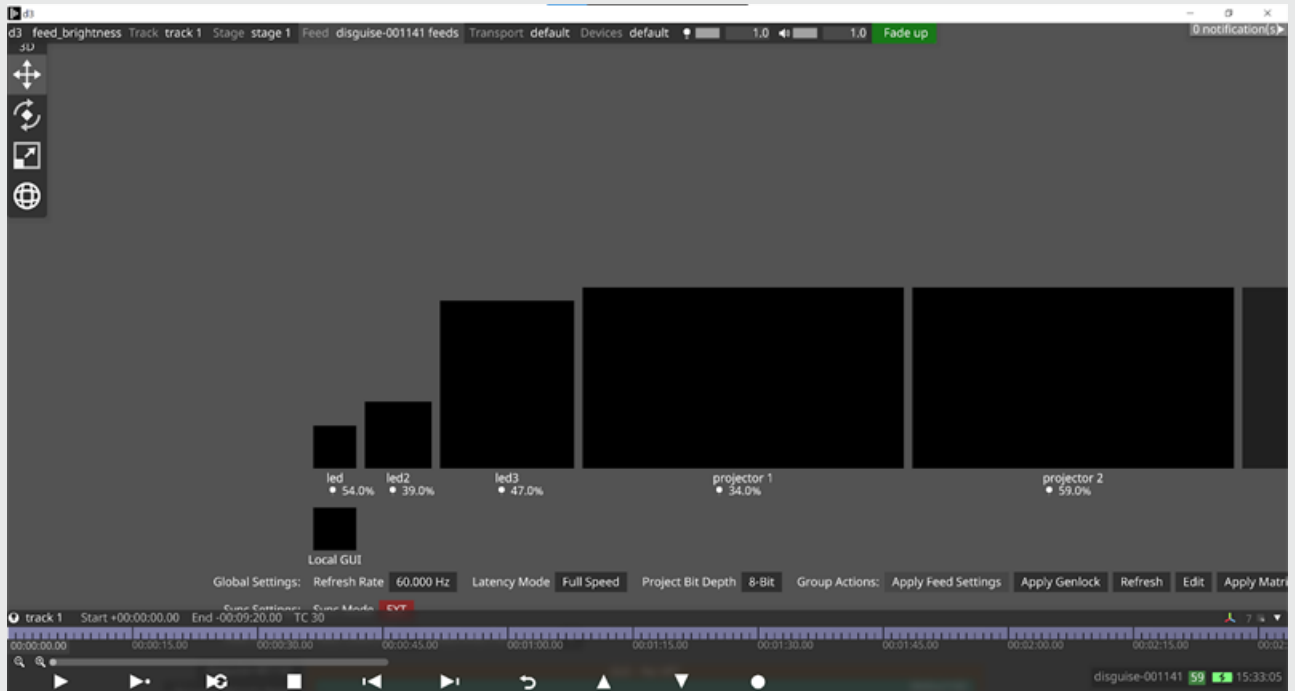

## Fixes

- **DSOF-11028** - Fixed an issue where an embedded audio in a video layer would drift out of sync from the playhead either over time or due to frame drops.
- **DSOF-17926** - Fixed an issue where setting a value with '=' in an expression locked the value to the conditional value.
- **DSOF-21117** - EventTransportMidiNote Personality Train is no longer offset in GUI.
- **DSOF-21827** - MultiTransport Manager: Fixed an issue where Editors would respond to timecode cues when the Director's transport had been disengaged.
- **DSOF-22783** - Clarified active latency mismatch error.



- **DSOF-22876** - RenderStream: Fixed a stall / crash to desktop when modifying ClusterAssigner options while sending remote texture.
- **DSOF-22900** - Fixed an issue where pre-capture in spatial calibration did not work when multiple cameras are using same video input.
- **DSOF-23276** - It is no longer possible to rename a group to an empty name, which then prevented opening group options widget.
- **DSOF-23281** - Fixed an Access Violation in the input manager when using keyframe editor with multi-layer selection.
- **DSOF-23315** - API: Fixed /sequencing/changeindirections only matching classes not subclasses.
- **DSOF-23367** - Fixed the keywidget timeline repositioning to the timeline playhead rather than the time indicator when moving between control parameters, thus losing view of keyframes being edited.
- **DSOF-23645** - Fixed an issue where Actors and Understudies were not showing frame rate at Startup until open the session widget.
- **DSOF-23661** - Fixed an issue where the missing media window could go off screen.
- **DSOF-23710** - Fixed an issue where FBX data from disguise shot recorder doesn't import correctly in 3rd party software (UE, Maya).
- **DSOF-23749** - Fixed being unable to filter by resolution in list editor.
- **DSOF-23841** - Monitoring manager improvements.
- **DSOF-23848** - OmniCal: Fixed an issue where NUL was logged instead of integer value 0 for "projectorSimulationOptions".

- **DSOF-23898** - Fixed an issue where user made video-in resource used in layers would generate content table fails.
- **DSOF-23934** - Fixed an issue where d3 switching between full screen and windowed would sometimes caused a crash to desktop.
- **DSOF-23955** - Inconsistent version tags no longer cause a crash to desktop.
- **DSOF-24036** - Fixed DSE not work with Face Culling.
- **DSOF-24088** - DSV capture: Fixed capture failure leading to shortening of capture buffer.
- **DSOF-24093** - Stop on TC Lost Behaviour is now consistent between director and editor.
- **DSOF-24105** - Fixed an issue where timecode tags where the frame number is the same as the number of frames per second caused the playhead to show the wrong time.
- **DSOF-24116** - Fixed an issue where versioning down a file used in smart group versions down every file used in that smart group, regardless of version number.
- **DSOF-24127** - OmniCal: UI Clarified when Multi-Pose is disabled because of missing cameras.
- **DSOF-24133** - Fixed an Access Violation when attempting to Empty Trash for LED Screen and Projection Surface.
- **DSOF-24168** - Fixed an issue where users could not create string literals in expressions.
- **DSOF-24176** - Fixed an issue where a project with StageAnnotationLabels of size zero can caused font rendering issues in GUI.
- **DSOF-24189** - Fixed an issues where Go To Timecode ( Ctrl + / ) went to timecode plus a frame when used after a timecode tag.
- **DSOF-24204** - Fixed video is not being in sync when an actor rejoined the session.
- **DSOF-24209** - Fixed frame drops when moving between multiple video clips with audio.

- **DSOF-24214** - Fixed remote installs of d3 stalling.
- **DSOF-24269** - Fixed an Access violation when trying to write more than one mpeg-4 feed movie if using an unsupported resolution.
- **DSOF-24278** - Fixed an Access Violation in VideoInSystem::render when GPU driver had crashed.
- **DSOF-24343** - Fixed an issue where sockpuppet changes were not actually being applied to an audio layer.
- **DSOF-24384** - Trial: Fixed an issue where a write compacted package on exit will leave project file empty.
- **DSOF-24385** - Fixed an issue where an unreadable shader source directory could stop shader cache creation.
- **DSOF-24429** - Fixed an issue where audio underran at the start of videoclip with audio.
- **DSOF-24439** - Fixed Text Module failing to update text on project restart.
- **DSOF-24445** - Groups are now red when they are created containing layers which are already red.
- **DSOF-24454** - Installer: Fixed d3 Installer hanging when d3 is running the background.
- **DSOF-24462** - Fixed an issue where every string rendered to screen was copied 1x more than required.
- **DSOF-24466** - Fixed RSCompressedVideoIn not calling shutdown(), bypasses videoInShutDown actions.
- **DSOF-24507** - Fixed an issue where ResourceTransport was blocked on Actor / Understudy machines after FeedRect edits.
- **DSOF-24520** - ResourceManager: search() now includes matching files on disk.

- **DSOF-24521** - ResourceManager: Fixed remove() calling removeResourceAction twice.
- **DSOF-24529** - Fixed an issue where the List View and Grid View highlight icons were reversed.
- **DSOF-24553** - Fixed widget suggestion text being unnecessarily copied.
- **DSOF-24573** - Fixed an issue where ObjectDeformationSettings::remove used single parameter erase call when used with std::remove\_if.
- **DSOF-24588** - Fixed a virtualCam error when starting a RenderStream workload.
- **DSOF-24605** - Fixed an error notification "m\_cameras.front() == cam" being produced during spatial calibration.
- **DSOF-24805** - XR: Fixed being unable to create a Legacy Observation.
- **DSOF-24806** - Fixed an issue when removing feed rectangle on output threw error: 'Machine' object has no attribute 'feeds'.
- **DSOF-24807** - Fixed errors thrown when trying to duplicate a feed rectangle.
- **DSOF-24815** - RenderStream: Fixed Uncompressed workloads failing to start.
- **DSOF-24819** - Fixed an issue where users were unable to duplicate multiple feed rectangles in the feed vie
- **DSOF-24841** - Fixed remote install failing on RX
- **DSOF-24847** - Improved LED Screen List Editor duplicate names handling.
- **DSOF-24956** - Fixed an issue where a combination of Matrox VX2 director and Deltacast VX4 or VXUnderstudy caused "Unable to create video capture stream" error notifications.
- **DSOF-25099** - Fixed an issue d3preview caused an Access Violation on opening file.

## Minor Releases

r26.0.1

[r26.0.2](#)

[r26.0.3](#)

[r26.0.4](#)

[r26.0.5](#)

## r26.1 - Fixes

**build: 171936 (released November 01 2023)**

### Fixes

**DSOF-22666** - Fixed an issue where d3 would hang due to a network security sweep

**DSOF-24346** - Added logging to Live Update option switch

**DSOF-24360** - Fixed an issue where RenderStream Uncompressed only received texture parameters on the first adapter

**DSOF-24786** - Fixed an issue where installing HDMI VFC REV E cards in a system after having QSDIVFC cards installed caused d3 to stall when loading

**DSOF-25156** - Added DCS sensor width manual column

**DSOF-25283** - Fixed an issue where project templates caused an error during install

**DSOF-25440** - MatroxApi now warns the user when there is driver and SDK version are mismatched

**DSOF-25468** - Fixed an issue where Arri LDS device was not parsing raw encoder values for zoom or focus distance

**DSOF-25527** - lenscalibrator.exe is now code-signed

### Minor Releases

[r26.1.1](#)

## r26.2 - Improvements & Fixes

**build:** 173464 (released November 16 2023)

### Improvements

- **DSOF-24937** - Fixed an issue where SaveOnDelete Resource Transport commands shouldn't blocked Resource Transport if a resend failed
- **DSOF-25413** - Default Variable Timecode Implementation

### Fixes

- **DSOF-25050** - Fixed an issue where right clicking a Screen of DMX lights on an editor while in a 2 machine or more session stopped DMX outputting
- **DSOF-25186** - Fixed an issue where remote installation occasionally failed to start d3service with 'Entry Point Not Found' errors on RX servers
- **DSOF-25420** Fixed an issue where the Position Receiver Axis could not use "Set" button for input ranges

#### Minor Releases

[r26.2.1](#)

[r26.2.2](#)

## r26.3 - Improved workflow

**build:** 175110 (released December 6 2023)

### New 2.5D Workflow

The new 2.5D workflow is also covered [here](#) with a new demo video.

## What is 2.5D?

2.5D workflows bridge the gap between traditional 2D video plates and full 3D generative scenes. By building up a scene with layers of images or video plates, with the possibility to add depth or shaping to the plates, users can quickly create a realistic-looking scene with parallax. 2.5D assets can be saved as .2p5d files and shared across projects or created using external integrations such as Cuebric to harness the power of generative AI to optionally create the image or just to speed up the process of image segmentation using AI.

## What has changed?

2.5D has been possible with Designer prior to r26.3, however, it required the manual creation of plates using a projection surface per plate, manually applying specific settings to each plate, and the use of a StageRender layer. With r26.3, 2.5D has been made a first-class citizen in Designer with its own layer type and the concept of a 2.5D asset. This dramatically increases the usability and speeds up the workflow, as well as making it more intuitive and less error-prone. In addition, the Cuebric integration speeds up the pipeline between the creative and volume control stages of the end-to-end workflow.

## Cuebric Integration

Cuebric is a web-based tool for creating 2.5D scenes with the help of AI. For more information visit <https://cuebric.com/>.

With r26.3, 2.5D scenes can be exported from Cuebric and imported into Disguise. At launch, the Cuebric

scene is exported from Cuebric by clicking on **Plug & Play 3D** in the **Segmentation view** under the Depth option. Once

exported, follow the 2p5D workflow to set up a 2.5D asset from an existing .2p5d file.

When the Cuebric export includes AI-generated depth mapping information, Designer will auto-generate a 3D mesh from the depth data to add shape to the plates.

To remove the depth mapping from the plate, you can simply select the standard rectangle mesh instead in the plate properties.

- Read more about 2.5D and the new workflow [here](#) and the Cuebric integration [here](#).
- For a video explanation of the Cuebric to Disguise end-to-end workflow, follow this [link](#).

## Minor Releases

[r26.3.1](#)

## r26.4 - VX 2+ Support

build: 176069 (released January 10 2024)

## New Features

- Added support for VX 2+. Read more about VX 2+ [here](#).

## Fixes

- DSOF-25920 - 2.5D - Fixed an issue where changes in z-offset for plates with depth maps don't get saved to 2p5d file.

## Minor Releases



r26.4.1

r26.4.2

## r26.5 - Improvements & Fixes

**build: 178116 (released January 24 2024)**

### New Features

- DSOF-25410 - Updated the way proxy and non-proxy streams are filtered in health status widget
- DSOF-25448 - Receive Health status in the RenderStream layer editor should no longer report "Frames Dropped Recently" for Proxy streams.

### Fixes

- DSOF-23229 - Fixed an issue where the current status of RenderStream was not shown under 'Network' tab within d3manager
- DSOF-23266 - RenderStream Workload widget does now automatically shrinks
- DSOF-23889 - Fixed an issue where d3manager did not update network share location when changing d3 projects folder
- DSOF-23890 - Fixed an issue where d3manager did not update network shares if not running as admin / elevated
- DSOF-24449 - Fixed an issue where eRenderStream uncompressed streams intermittently only rendered black
- DSOF-24474 - Fixed an issue where Heap corruption in Rivermax cleanup code caused a crash in touchdesigner
- DSOF-24475 - Fixed a CL\_OUT\_OF\_HOST\_MEMORY error on vx using RenderStream

- DSOF-24622 - Fixed an issue where workloads could occasionally get stuck in awaiting requests
- DSOF-24648 - Fixed an intermittent flickering issue when starting RenderStream
- DSOF-24706 - Fixed an issue that occurred when using an uncompressed Unreal RenderStream, some actors showed RECV 0
- DSOF-24707 - Fixed an issue where an exception occurred when trying to remove a channel mapping
- DSOF-24715 - Fixed an issue where actors crashed whilst starting and stopping workload
- DSOF-24838 - Fixed an issue where pool usage was not shown for assets using the default channel name
- DSOF-24855 - Fixed d3 heap corruption and a crash to desktop with RenderStream compressed in LibGpuVideoCodec (AMD 22.Q2)
- DSOF-24918 - Fixed an issue that occurred If the drive that d3manager was pointed at disappeared, launching d3 remotely on that machine would default to another drive
- DSOF-24943 - Improved RenderstreamSystem system speed when updating statistics about many streams
- DSOF-24974 - Fixed an issue where starting and stopping a render stream workload reduce performance of the director
- DSOF-24984 - Fixed an issue where launching d3manager with a missing d3 projects folder would result in the next project folder from the list being launched
- DSOF-25009 - Fixed an issue where adding samples to an uninitialized graph descriptor caused an exception
- DSOF-25023 - Fixed a crash on director when receiving proxy streams

- DSOF-25028 - Fixed an issue where if d3service crashed while RenderStream is running, all renderstream processes on that machine will no longer be controllable via d3net
- DSOF-25039 - Fixed an intermittent issue where streams were occasionally never received
- DSOF-25096 - Fixed an issue where calling an invalid API endpoint can intermittently caused a crash to desktop
- DSOF-25113 - Fixed an issue where 16K or higher screen couldn't use blur layer even using enableSLC switch
- DSOF-25136 - Fixed an Access Violation can occur when moving the playhead out of a RenderStream layer after the GUI had been reloaded during development.
- DSOF-25137 - Fixed an issue where Renderer Graph was not accessible via the Workload details GUI
- DSOF-25183 - Fixed an issue where a video layer missing media highlight no longer updated as frequently to changes in sequencing
- DSOF-25185 - Fixed an issue where a vx occasionally dropped all received frames with RenderStream Uncompressed
- DSOF-25237 - Fixed an issue where missing media scenarios with a Bitmap layer caused notification spam: Corrupt keyframe, please check sequencing
- DSOF-25327 - Fixed an issue where Feed Mapping Editor still opened and is interactable even if the feed mapping is "Locked"
- DSOF-25338 - Reduced active time of "Packets dropped recently"
- DSOF-25556 - Fixed an issue where editing Feed Warps intermittently did not take effect on actor machines in session, but the control points did move

- DSOF-25568 - Fixed an issue where RenderStream failed to initialise due to an exception, rs\_ initialise returns success
- DSOF-25629 - Fixed an error when launching project on actor, "Current d3projects folder not available on machine..."
- DSOF-25631 - When opening d3 manager "Run Project" button is now populated with the "current" project
- DSOF-25765 - Fixed an issue where Understudy takes over but does not indicate on director, sometimes failing to trigger matrix failover
- DSOF-25829 - Fixed RenderStream Failover
- DSOF-25892 - Improved Track widget updates when RenderStream workload status is updating
- DSOF-25893 - Improved receive health widget
- DSOF-25932 - Fixed an issue where workload state intermittently got stuck in "Launching"
- DSOF-26095 - Fixed an issue where some RenderStream uncompressed streams failed to start on the director when using an actor controller to run many streams
- DSOF-24245 - Fixed an indefinite hang/crash due to exhausting video memory
- DSOF-25905 - Fixed an issue where mesh mapping fragments teared when the engine origin is changed in real-time

### **Minor Releases**

[r26.5.1](#)

[r26.5.2](#)

**Download the complete r26 Release notes [here](#)**

# What's new in r25

## r25 - The power of the unseen.

New features for an enhanced Designer experience.

### New Features

#### Camera tracking updates

In r25, we have introduced improvements to the lens tracking source workflows within Designer.

The main changes are:

- Under the hood refactoring to reduce code complexity
- Adding receive time smoothing to object tracking sources, rather than just cameras
- Additional graphs and logging
- Added the ability to disable particular axes in tracking sources
- Added lens focus parameters (focus distance and aperture) for tracking sources which support them
- General UI improvements.

Read more about the improvements [here](#).

Further featured changes include:

— **BlackTrax: Implement BlackTrax Centroid calculations**

We have implemented centroid tracking sources into the RTTrPMDriver within the PositionDriver.

— **Add ARRI LDS as a device driver for receive lens data native from Arri Cameras**

We have added Arri LDS within the PositionReceiver devices so that users can receive metadata from Arri cameras into disguise - that being focal length, aspect ratio, vertical and horizontal field of view, sensor size, aperture, and focus distance.

## Improvements

**r25 improvements include:**

— **DSOF-22279 Ensure Quad-SDI VFC output signal is not interrupted after configuration**

In previous releases, the output from a Quad-SDI VFC card would be interrupted if a project would be restarted within Designer

In r25, if a user was to restart a project within Designer then the output from a Quad-SDI VFC card would be the same resolution as it was before the project was restarted. This prevents the signal being interrupted upon restarting a project within Designer.

The only time that an output will be interrupted from a Quad-SDI VFC will be if a disguise media server was restarted or powered off, or when apply feed settings is executed.

— **DSOF-22410 Support focus and iris data in FBX export from shot recorder**

In r25 we have added both aperture and focus distance to the default parameter collection for newcameras within the Shot Recorder feature. These properties can also be set within the Shot Recorder FBX export.

— **DSOF-22460 Keep last-known camera position if camera tracking drops**

In previous releases, when camera tracking is lost, the camera will revert back to 0,0,0. In r25, the camera tracking will remain at the last tracked camera position.

— DSOF-22672 Make common base project for d3api and d3service

— DSOF-22837 Write functionality to clear up exported glb, movie and metadata files

We have added an improvement to the Previz Link within Designer in r25 to clear up disk space by deleting old export files related to Previz that are no longer being used by any other application. Any export file that is still being used will not be deleted until the next time a clean-up takes place, where again we will only delete export files that are no longer being used by any application.

— DSOF-22937 Move nginx logs to d3 app data directory instead of in program files

In r25, nginx logs have been moved from the program files path to

C:\Users\d3\AppData\Local\d3\nginx

— DSOF-22995 GUI: The layer editor should move to front open keyframe editors when it gains focus

In previous releases, when working on a large timeline that overlaps on-screen with a layer editor, if a user was to click on the layer editor to focus on it, the layer editor widget would be foreground but the keyframe editor would be behind the timeline. In r25, when a user brings a layer editor into focus, the keyframe editor will now foreground with it.

— DSOF-23002 Sequencing: On project upgrade, disable sequencing for all fields which are not sequenced

In previous releases, if a project was upgraded from a version of Designer that did not support the Keyframe Toggle (before r20.0), all fields were set to have Keyframes enabled. This required a significant amount of tidying to be able to benefit from the Keyframe Toggle. In r25, we have enabled any fields that only have 1 frame and therefore no sequencing should have the Keyframe Toggle automatically set to off on project upgrade.

— DSOF-23110 Videoins with placeholder images should have the resolution of the placeholder.

In previous releases, when adding a Videoin for a placeholder image, the video would be set to the last resolution of the video input received by disguise. In r25, if a Videoin is added with a placeholder image, the video will be set to the resolution of the placeholder image that is used. The Videoin will override the placeholder image resolution when it is available.

— DSOF-23245 Optimize DmxScreenRead layer

In previous releases, it was reported that the DmxScreenRead layer was impacting the performance of Designer. We have now optimised the layer.

— DSOF-23336 IP VFC SDP file paths should be discoverable

We have added a 'Copy SDP path to clipboard' button within the IP-VFC settings menu. This includes the SDP path that can be copied and added onto a ST 2110 receiver device, such as the MegapixelHelios.

— DSOF-23646 GET activetransport API should return the selected track for each transport

We have enabled the ActiveTransport API to return the currently selected track for each transport. This can be found within the GET activetransport API, where we have included a currentTrack property that indicates the current selected track of a given transport.

— DSOF-23756 Add double dot RS plugin version to schema JSON

We have added a new RenderStream release naming convention to include double dots for plugin-specific hotfixes. This can now be seen within the Designer GUI.

— DSOF-23808 Implement support for Arri Alexa LogCv4 to ACES workflow

— DSOF-23927 Allow user to copy/paste notifications

Users can now copy and paste notifications from Designer without having to open the console.

## Fixes

**r25 fixes include:**



- DSOF-19735 - Fixed an issue where snapshots failed to create after the snapshot widget was closed
- DSOF-19736 - Fixed: If a snapshot has failed to create, an access violation was displayed if a widget was opened while taking a snapshot
- DSOF-20435 - Fixed an issue where the CPUMonitor did not respect poll unit/interval settings
- DSOF-20791 - Fixed an issue where "Edid port invalid errors" on applied feed settings
- DSOF-21510 - Improved the efficiency of Text Layers
- DSOF-21687 - Fixed an issue where Media Distribution did not report correct size for image sequences
- DSOF-21694 - Fixed an issue that occurred when undoing a creation of a group with the widget open displayed a "not in list" error
- DSOF-21839 - Fixed an issue where projects started with a Masking object appearing until the stage is brought into focus
- DSOF-21988 RenderStream: Fixed an issue where Designer would hang when stopping a workload
- DSOF-22109 - Fixed an issue where list indirections were not triggering multitransport
- DSOF-22756 - Fixed an issue that occurred after deleting a Skeleton object from Stage and its Stick Man was still visible
- DSOF-22780 - Fixed an issue where it was not possible to open the rollback window of 2 objects at the same time
- DSOF-22781 - Fixed an issue where duplicating group with video transition layer
- DSOF-22798 - Video Input Patch Editor: Fixed an issue where the format field was not refreshed upon project startup

- DSOF-22812 - Fixed an unnecessary error continuously being thrown when an empty texture parameter was assigned
- DSOF-22846 - Fixed an issue that occurred when disengaging the Position Receiver, the status didn't work as expected
- DSOF-22916 - Fixed framerate drops on solo with section on the timeline
- DSOF-23030 - Fixed an issue where a new section break was not dropped on the exact frame when zoomed out and using ; ` shortcut to move playhead
- DSOF-23103 - Fixed an Access Violation when using ctrl+z to undo deleting a layer
- DSOF-23107 - Fixed incorrect timestamps on a newly created project within d3manager
- DSOF-23127 - Msys Driver: Fixed an issue where it was possible to edit lens values in the GUI when using Msys GeneratedCameraTrackingSource
- DSOF-23153 - Fixed an issue where Video Inputs was not scrollable
- DSOF-23157 - Fixed an issue where Udp::connect error didn't specify which port it failed to bind to
- DSOF-23159 - Fixed an issue where ObjectView did not expand according to buckets / subdirectories
- DSOF-23179 - Fixed an issue where the VideoIn format field was not serialising correct value with director/actor setup
- DSOF-23180 - Fixed an issue where Layer Stack did not affect placeholders in LogicalVideoInDevice
- DSOF-23215 - Fixed an issue where Movie Output > Output movie size had options for 2K and 4K export on the MPEG-4 drop-down list despite Designer reporting errors that "d3 designer can only export resolutions up to 2160 pixels" and then failed any export attempt

- DSOF-23264 - Fixed an Access Violation when taking a Snapshot after closing Snapshot manager
- DSOF-23287 - Fixed an issue where a calibrated camera with no tracking source silently overwrote lens intrinsics
- DSOF-23303 - Fixed an issue where the console was spammed when Designer was minimised while running in application mode
- DSOF-23319 - Fixed an issue where Designer delayed tracking longer than it needs to when doing receive time smoothing
- DSOF-23328 - Fixed an issue where many (Save) Actions were not unsubscribed at d3 shutdown
- DSOF-23331 - Added detailed logging on shutdown for still subscribed Actions
- DSOF-23332 - Fixed an error at 'MissingMediaDomain: checkMissing'
- DSOF-23333 - Fixed an issue that occurred when changing SLC sizes would result in an error after configuring feed
- DSOF-23342 - Fixed an issue where copying and pasting a layer at the end of the timeline did not extend the track
- DSOF-23358 - Fixed an issue where keyframes outside of the highlighted grouping area were not deselected and not included in the keyframe grouping
- DSOF-23361 - Fixed an issue when assigning empty VideoInTexture caused a parameter size error
- DSOF-23368 - Fixed an issue when selecting a group of keyframes whilst there was already an active group selection in the keywidget added the new selection to the old
- DSOF-23422 - Fixed [XR] Spatial Cal not working as expected

- DSOF-23429 - Fixed an issue where a "'NoneType' object has no attribute '\_\_\_base\_\_\_'" notification was displayed when right clicking on proxy maker with disableProxyMaker option switch enabled
- DSOF-23513 - Fixed iPod 6 showing as an option in OmniCal
- DSOF-23550 - Fixed an issue where the Patch Assignments Widget could not be opened
- DSOF-23558 - Fixed an issue where Telemetry would fail with error "queryLogs failed: Can't find manifest"
- DSOF-23566 - Previz link: Fixed an issue where props didn't handle alpha material and textures properly
- DSOF-23575 - Fixed an issue where Rotational X value flickered between two numbers in Tracking Source Data when Smooth Receive Time unchecked
- DSOF-23581 - Fixed an issue where 'Cannot create a link without a Resource' error was displayed when
  - adding the new depth of field parameters to the shot recorder
- DSOF-23595 - Fixed an issue where the 'enable Depth of Field (DOF)' option check-box in Camera settings has changed to a number field input box
- DSOF-23598 - Fixed mesh fragment artefacts in a mesh mapping
- DSOF-23611 - Fixed an issue where upper and lower-case letters in names of the Camera Settings were mixed up
- DSOF-23613 - Fixed an issue where it was not possible to do secondary observations with trackmen camera tracking system as zoom encoder is always 1.f
- DSOF-23620 - Fixed an issue where the prop mesh could not be assigned 'None'

- DSOF-23629 - Fixed an issue where Mesh Mapping would jump the camera for a few frames to a different position
- DSOF-23666 - Attribute Error: Fixed 'NoneType' object having no attribute 'hidden' when adding aspherical camera
- DSOF-23685 - Fixed the Focus field inside Camera widget not working as expected
- DSOF-23716 - Fixed a VirtualCam notification error when starting RenderStream with MR set mapping
- DSOF-23740 - Fixed an m\_renderPoseHistory.empty() Error Notification upon re-opening a project with RenderStream layer
- DSOF-23751 - Fixed an error spamming whenever opening the Tracking Source widget of a Skeleton
- DSOF-23754 - Fixed an issue where a camera with a tracking source selected and no video in, opening  
the camera widget showed an error
- DSOF-23777 - Fixed Open Tracking Sources widget not working as expected with Skeletons
- DSOF-23783 - Fixed an issue where VariableVideoPlayer: "Invalid frame calculated"/ "start != end" notification was shown on sharp speed changed - check
- DSOF-23811 - Removed Skeleton Scale
- DSOF-23893 - RTTrPM driver - Fixed an issue where centroid positions had Y/ Z positions swapped
- DSOF-23899 - Fixed an issue where the Inner Frustum was not visible when using Backplate and Mesh Mapping
- DSOF-23963 - Fixed NGINX being set to Manual instead of Automatic in Services

- DSOF-23978 API: - Fixed an issue where boolean properties in result of /service/system/detectsystems never returned to 'false'
- DSOF-24042 - Fixed an issue where alembic mesh centroid did not match when mesh is far away from origin
- DSOF-24049 - Fixed a typo on response to http://localhost/api/session/status/health
- DSOF-24083 - Fixed multiple Access Violations and crashes to desktop when trying to stream 3 channels over RenderStream.

## Minor Releases

[r25.0.1](#)

[r25.0.2](#)

[r25.0.3](#)

## r25.1 - Fixes

**build: 162408 (released June 28 2023)**

### Fixes

**DSOF-22915** - Fixed a crash on exit when DxDevice was lost

**DSOF-24500** - d3service no longer crashes on close

**DSOF-24507** - Fixed an issue where ResourceTransport blocked on Actor / Understudy machines after FeedRect edits

**DSOF-24523** - Fixed ACCESS\_VIOLATION 0x280 while renaming the stage from an Editor

**DSOF-24558** - Fixed an issue where Heap Corruptions caused a crash to desktop

**DSOF-24560** - Fixed an Access Violation when using the 'Removing Virtual Head' option in the FeedHead widget

## Minor Releases

[r25.1.1](#)

[r25.1.2](#)

[r25.1.3](#)

[r25.1.4](#)

## r25.2 - Fixes

build: 165620 (released August 9 2023)

### Fixes

**DSOF-24386** - Fixed an issue where an error stating permission was denied [Error13] when opening project from d3Manager

**DSOF-24424** - Fixed a delay when launching a project from d3 Manager and Designer opening

**DSOF-24594** - Improved the speed of NDI source discovery

**DSOF-24758** - Fixed an issue where missing dependencies caused Notch Blocks to not load: "Unable to load error: Error 0x7e: The specified module could not be found"

**DSOF-24808** - Fixed an issue where 12G SDI input limit was reached even using 3G

**DSOF-24814** - Improved audio prefetching limit logging

**DSOF-24816** - RenderStream: Fixed an issue where framerate plummets and/or workload crashes when un/assigning texture parameters

**DSOF-24928** - Fixed a memory leak in RenderStream Uncompressed with Texture Parameters

## Minor Releases

[r25.2.1](#)

[r25.2.2 \[see r25.2.3 release notes\]](#)

[r25.2.3](#)

## r25.3 - Improvements & Fixes

**build: 167949 (released September 06 2023)**

### Improvements

**DSOF-24101** - Unified "dropped frames" counting across all videoin classes

**DSOF-24349** - Implemented IMvVideoConnectorNotification for inputs to receive status updates in console

### Fixes

**DSOF-24301** - Fixed an issue where consecutive timeouts on capture cards would abort the thread and not restart it

**DSOF-24443** - Fixed an issue that occurred when a capture card input was unplugged and replugged, all inputs would freeze for a few seconds before recovering

**DSOF-24549** - Fixed Matrox thread 1A Aborting thread due to repeated time out

**DSOF-24552** Fixed an issue where output would get stuck if the video input signal was lost and recovered

**DSOF-24693** - Fixed an issue where checkInputSignalChanged was causing main thread to hang

**DSOF-25115** - Fixed an issue where the capture thread could occasionally crash with an Access Violation while configuring a quad input

**DSOF-23828** - Fixed an issue where setting EDIDS to unmanaged/force off did not work as intended

**DSOF-25064** - Fixed an issue where Mellanox licence failure was not reported as an error on gx3 servers

### Minor Releases



r25.3.1

Download the complete r25 Release notes here

# d3manager Overview

d3manager runs as a normal windows desktop application.

Manager lets you do the following things:

- see what projects are installed on your machine.
- see what multi-machine sessions are running on the network.
- see which machines on the network are running Disguise software and which version they are running
- remote install d3 on rackmount machines on the network
- navigate quickly to any local project folder.
- run any local project.
- view the projects folder size
- run a local project in assistance mode (for remote diagnostic sessions, for example over Skype).
- join a running session as an editor.
- create a diagnostic archive (containing project, non-media files, consoles and telemetry) to send to support@disguise.one.

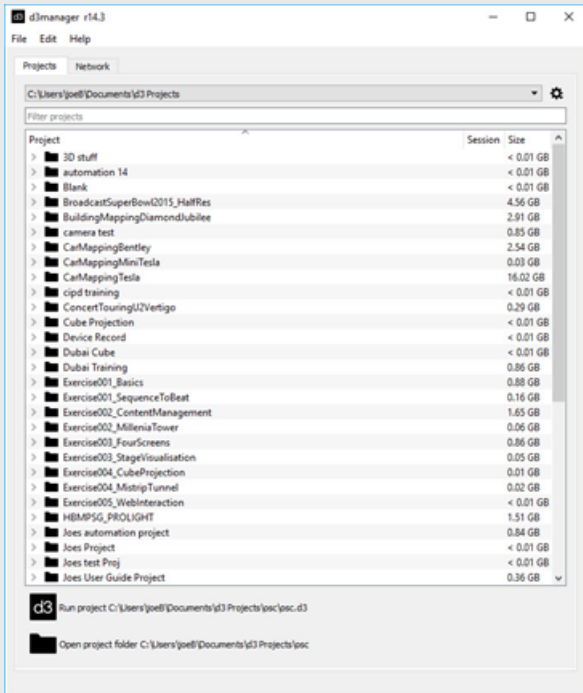

# Creating a new project

You can create a new project either outside disguise in Windows using the d3manager, or within the software itself.

## Create a new project in d3manager

1. Run d3manager.
2. Click **File** followed by **New Project**.  
Or alternatively, use the keyboard shortcut **CTRL+N**.
3. Enter a name for the project and click **Create**.

## Create a new project within Disguise software

1. Run Disguise software.
2. Right-click **d3** from the dashboard (bar at the top of the screen) and left-click **Project Settings...**
3. Type in the name of the new project in the **new project** text field and hit **Enter**.
4. Exit the software, go to the new folder and run the new **.d3** file.

# Template project

You can define a template project that all new projects are created from.

A template project can be any project that you have already created in the d3manager. Whenever you define a template project, next time you create a new project, the template project will be copied. Once you have created the new project, the template is not referenced in any way, and changes in either project will need to be updated manually.

## Define project template

1. Right click a project folder in d3manager
2. Choose the **Set as template for new projects** option

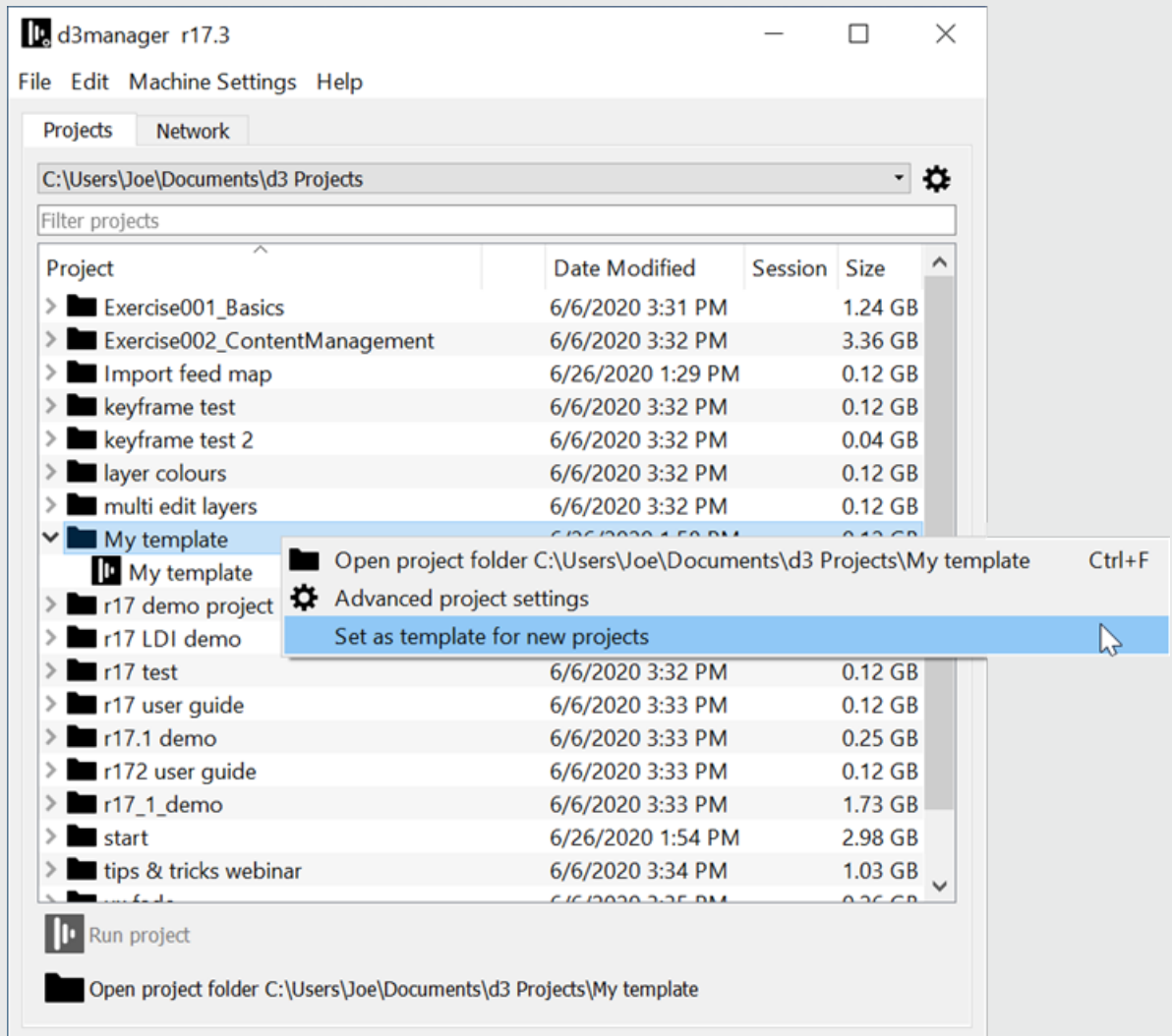

The project will now have a *template* indicator in d3manager.

## Remove template

1. Right click the template project folder in d3manager.
2. Left click the **Clear project template** option.

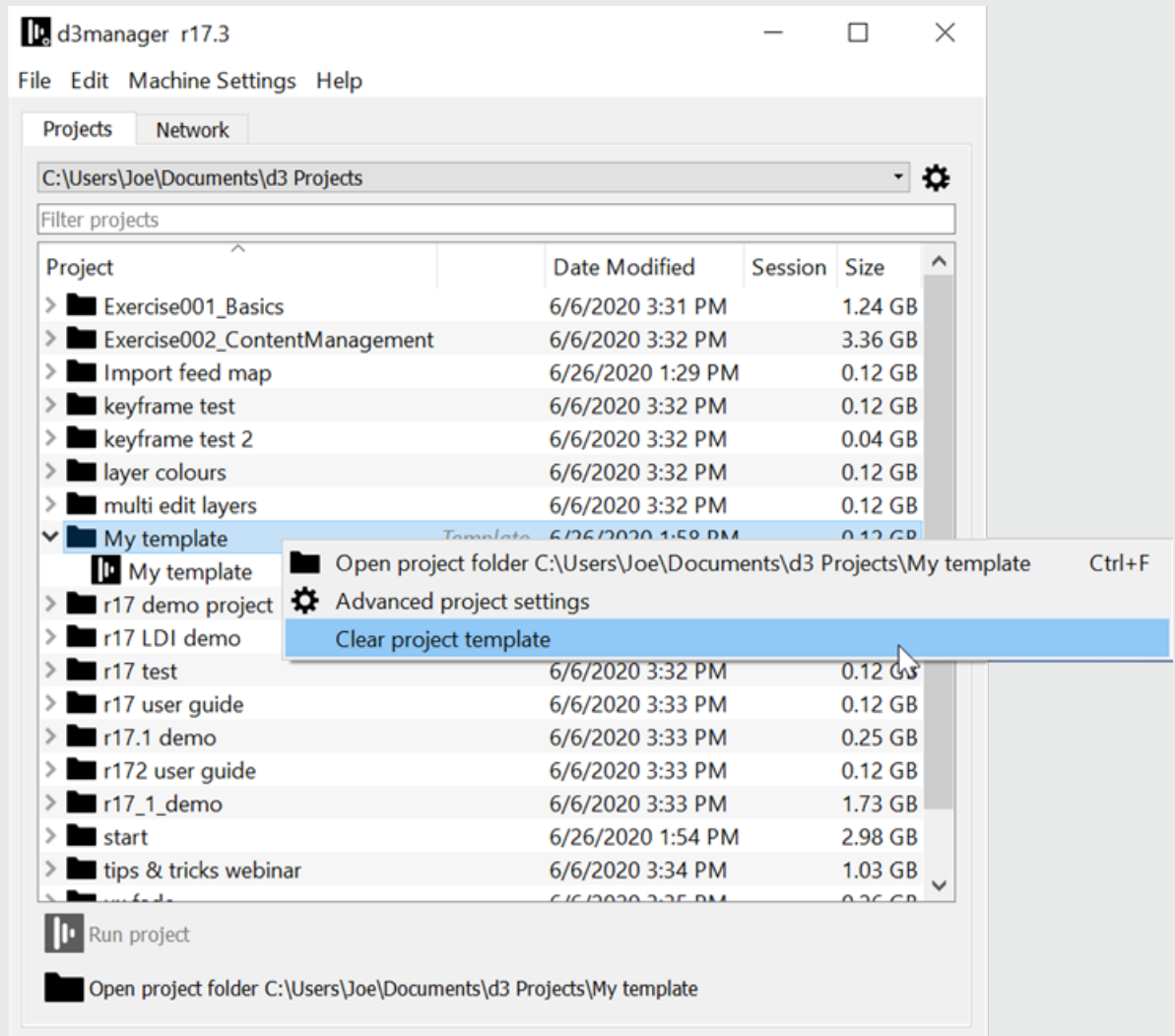

d3manager will no longer use this project as the template for new projects.

# Starting an existing project

## To start an existing project:

1. Select the project name in the projects list.
2. Click the arrow next to the project name to view all the project files inside the projects folder.
3. Double-click a project file to launch the project.

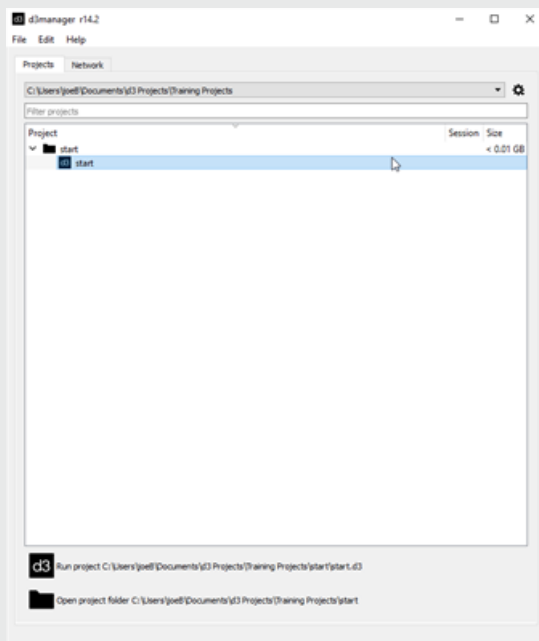

4. Alternatively, select the project and click the **Disguiseicon** at the bottom of d3manager. d3manager will now launch the selected project file.



# Re-launching the last active project

This allows you to re-launch the last active project that was opened.

To open the last active project:

1. Open the d3manager.
2. Click the **Disguise Icon** at the bottom.

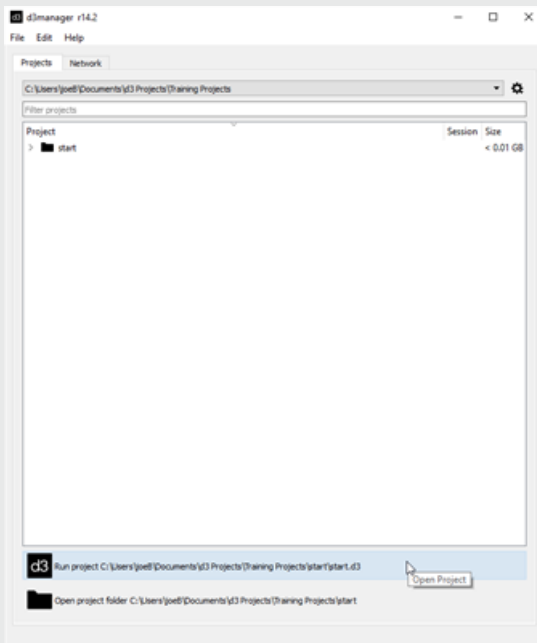

Notice that as soon as you select any project in the list the last active project can no longer be opened using the **Disguise Icon**.

# Opening a project from file list

This opens the project from the file list. If nested expand the project folder by clicking on it or pressing the spacebar.

To open the project from the file list:

1. Double click on the project  
Or alternatively
2. Right-click the project in the file list.
3. Select **Run project** from the drop down selection.

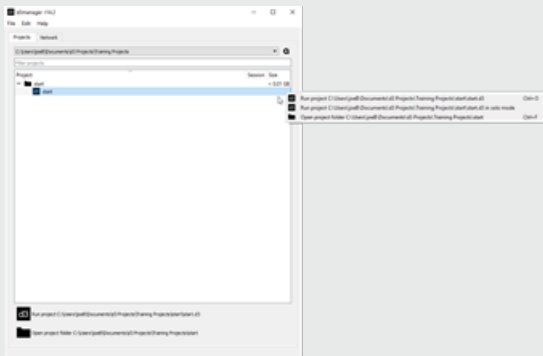

# Opening the Disguise Projects folder

To open the Projects folder:

1. Select **File** from the menu bar.
2. Select **Open projects folder** from the drop down selection.

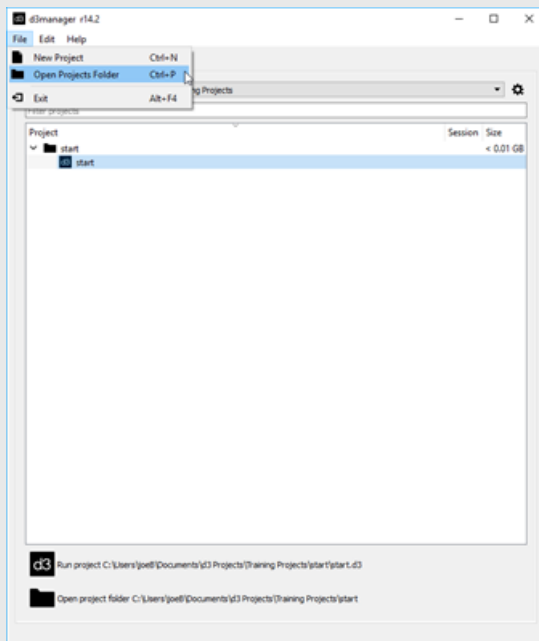

# d3manager - Networked Machines

By clicking on the network tab of the d3manager, you can view machines on the same network that have d3manager installed.

## d3manager network view

You can view: The machines name, the version of software it currently has installed, the type of hardware the machine is, and the status.

## Install Disguise software remotely

It is possible to install the current build you have installed on your machine onto another machine on the network through the d3manager. This can be useful for updating software on slave machines from a Director or editor.

## d3manager network view

You can view: The machines name, the version of software it currently has installed, the type of hardware the machine is, and the status.

1. Select the machine you wish to install Disguise software on.
2. Select the install remotely button

## d3manager Accessing project folders on networked machines

To access the projects folder on a networked machine via the d3Net manager, follow these steps:

1. Navigate to the network tab in the d3Net manager
2. Select the desired active machine
3. Double click on the machine name to open the projects folder

# Joining a session from file list

Join session allows users with Designer to access projects over the network for multi-user editing.

## To join a session from the file list

1. Ensure that the session icon is visible in the session column. If not you may have a networking issue or you haven't set up your Director/ Actor network correctly.
2. Double-click the project in the file list.
3. Select **Join session** from the pop-up selection.

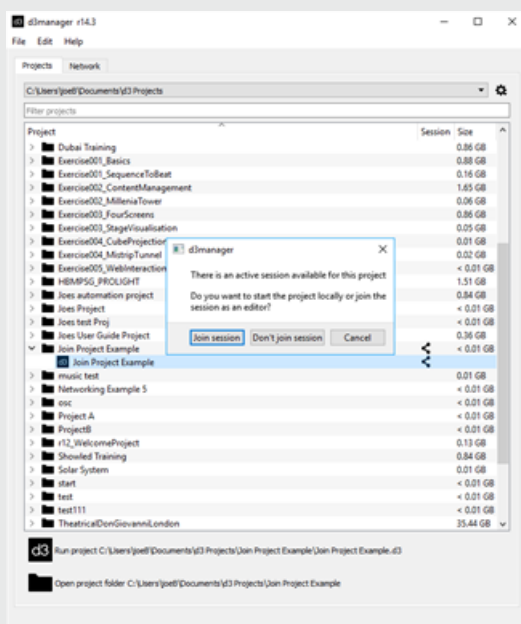

## Viewing machines in a session

It's possible to view which machines are in a session, without joining it.

Hover your mouse over the **.d3** file in **Manager** to see the machine names currently in that session.

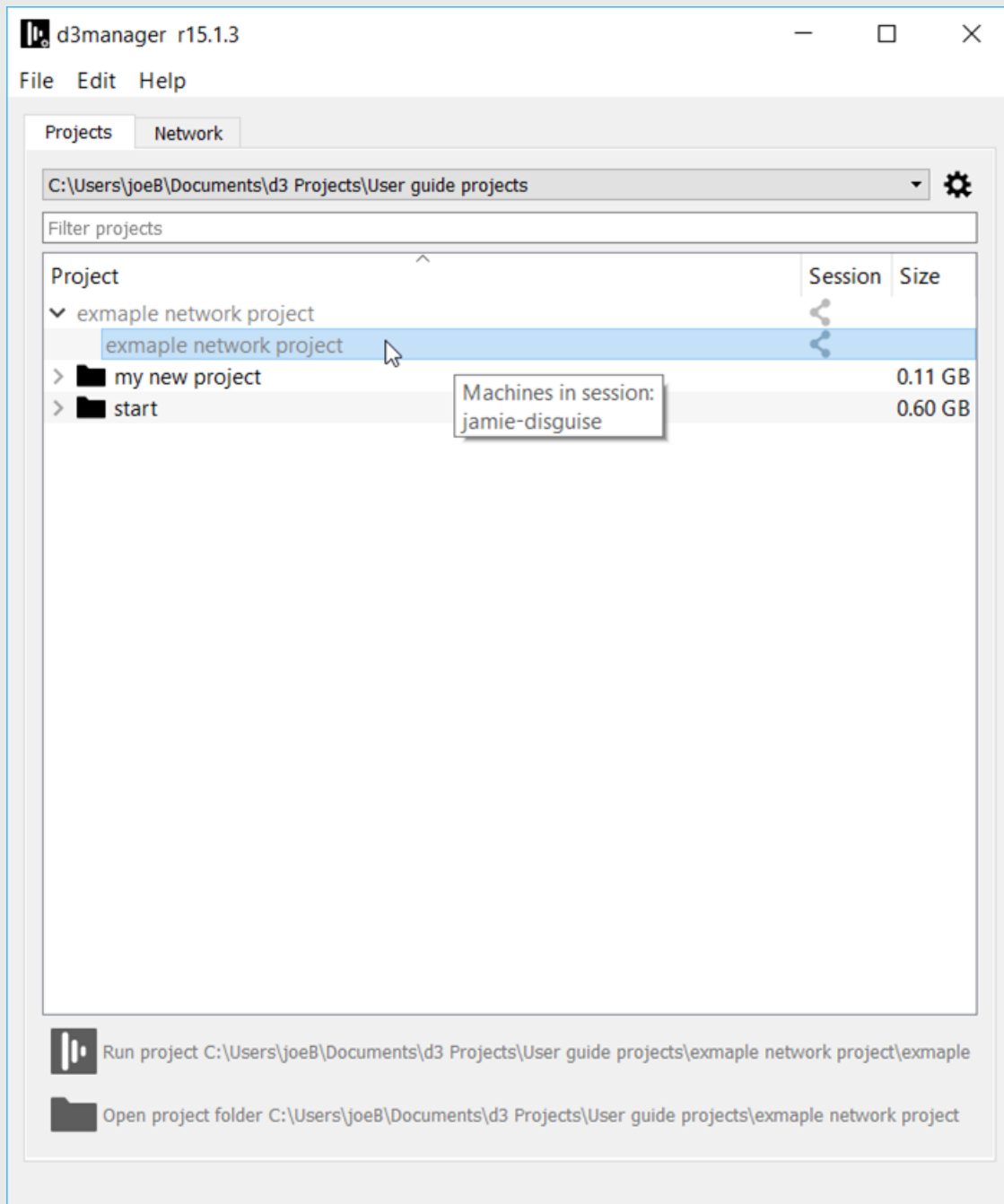

Hovering over the file shows the name of machines in that session.

# Assistance mode

This allows the user to join a network session as an editor and allow remote support for the user if a problem occurs.

## To open a project in assistance mode:

1. In the projects list, first select the project you would like to open.
2. Select **Help** from the menu bar.
3. Select **Open project in assistance mode** from the drop down selection.

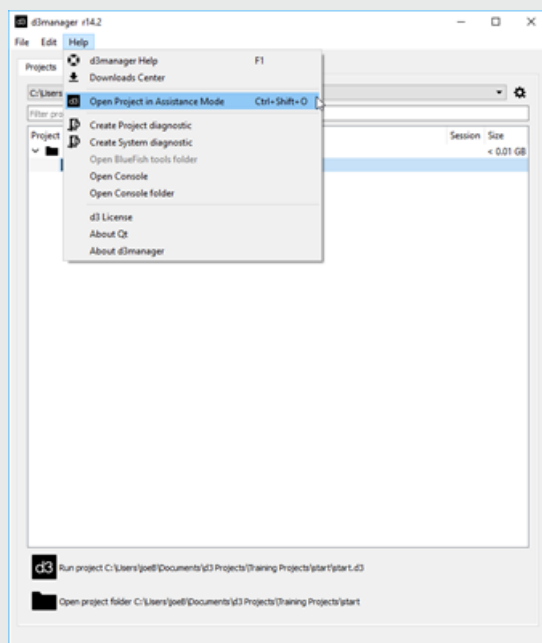

## To join session in assistance:

1. Ensure that the session icon is visible in the session column. If not you may have a networking issue or you haven't set up your Director-Actor network correctly.
2. Select the project name in the project list.



3. Under the **Help** menu select the **Select Join session in assistance mode** from the drop down selection.

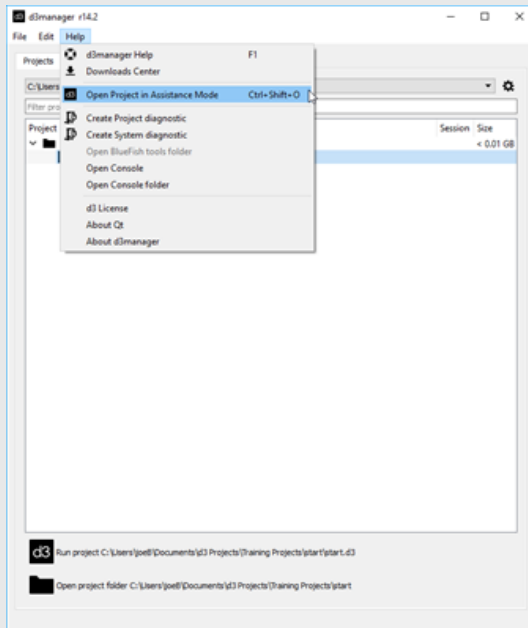

# Adding and removing project folders

This allows you to add or remove multiple project folder locations, enabling you to have multiple project locations simultaneously.

## Adding a project folder:

1. Click the **settings** icon +
2. Click **+ Add Disguise Projects folder** in the drop down selection and select a new folder.

## Removing a project folder:

- Click **- Remove Disguise Projects folder**. Notice that this will not delete the actual content of the folder, it just gets removed from the d3manager.

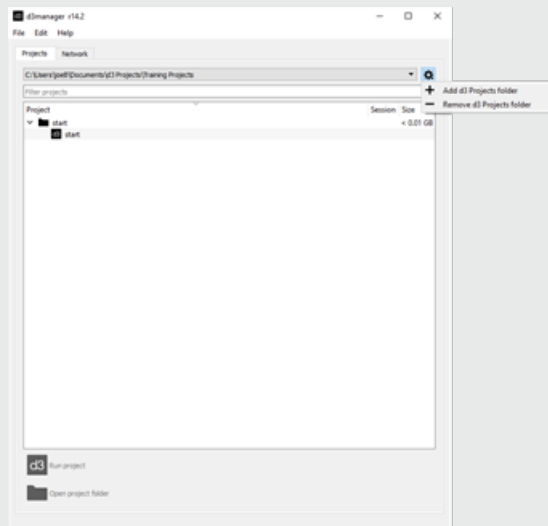

# Expanding and collapsing projects folders

This allows you to expand and collapse your project folder which enables you to see multiple project files within your project

To open the projects folder:

1. Select **Edit** from the menu bar.
2. Select **Expand / Collapse Projects** from the drop down selection.

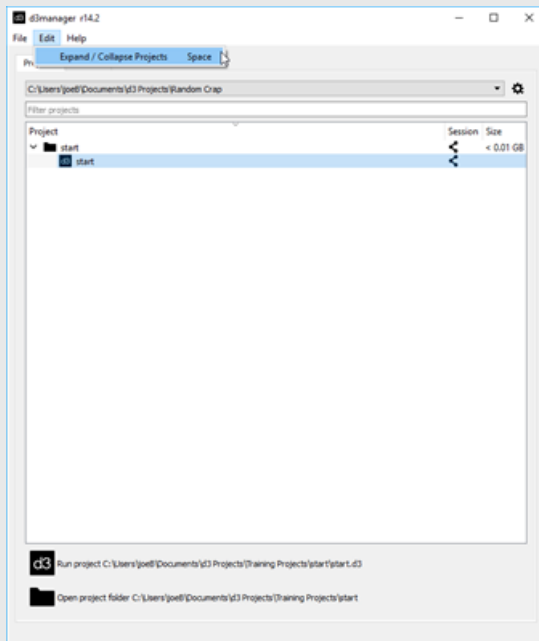

# Help Menu Overview

The Help Menu in Manager can perform a number of functions. It is the go to place for finding out the current information about the install, as well as the license information (for days remaining on Designer dongle).

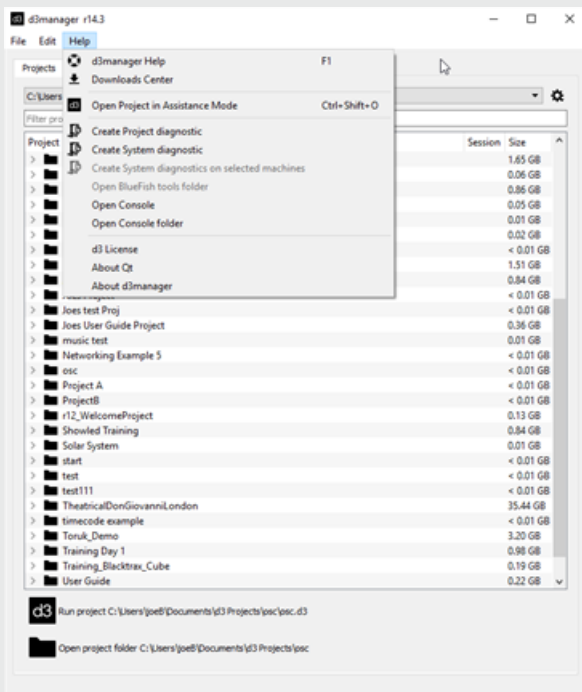

# Project History files

Every time you run Disguise software, the **.d3** project file (for example, **myProject.d3** ) is automatically copied to a folder called **History** in your project folder.

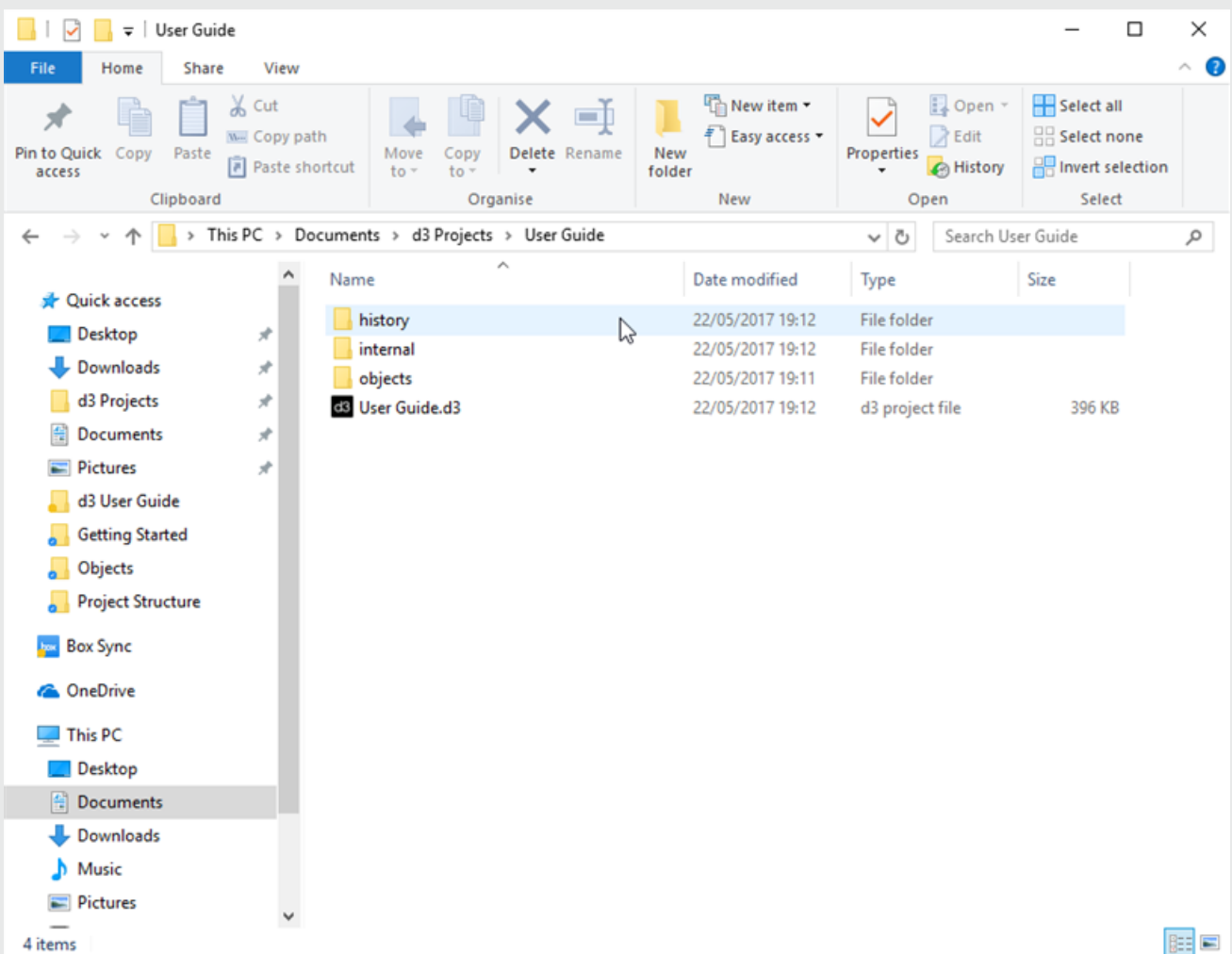

Backup files location for a project, used in case the current .d3 project file becomes corrupted or fails to load

The file name of the backup copy is stamped with the date and time. The software manages the files in your history folder so that you always have ten versions created within the last hour, 24 within the last day, 7 within the last week, 4 within the last month, and 12 within the last year. If you should happen to

lose or corrupt your project file for any reason, therefore, you can always access the project as it was five minutes ago (or whatever your auto save duration is; see the next section on 'configuring auto save').

## Restoring an backed up .d3 project file

To restore a backup version of the project:

1. Copy the **.d3** project file from the **History** folder up into your project folder.
2. Remove the date suffix and double-click it to run it.

**Please note:** if you do not rename the copied **.d3** file without the date suffix the auto-backed up **.d3** file will create two date suffixes after each other.

**Please note:** all timestamps are in UTC and not the current timezone of the machine.

## Restoring an object after permanently deleting it

Objects emptied from the trash-can are permanently deleted in the current **.d3** project file. To retrieve an object, restore a previous **.d3** project file in the **History** folder. It is even possible to rollback an object to a previous version.



**Warning:** automated saves do not make backup copies of media files (audio files, still images, mesh files and video files). You should make regular backup copies of the entire specific Project folder(s) and store them on an external hard drive or network store.

# Autosave

By default, the software saves the complete project every 5 minutes, as long as video is not playing (this is because saving takes time, which interrupts video playback). Autosave also generates a snapshot of the current project in the history folder contained within the project folder.

## Changing the frequency of autosave

1. Right-click the State tab to open up the Program settings menu. Select **Project Settings**
2. Edit the **autosave frequency (min)** property to the number of minutes between saves.

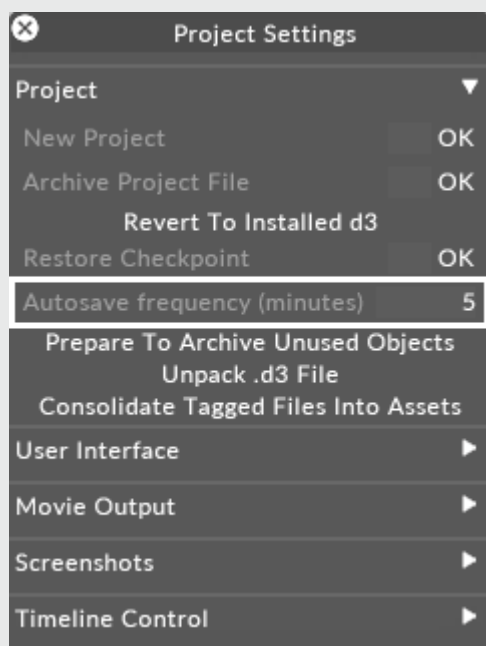

Autosave Frequency (Minutes) property of the Program Settings menu is used to edit the number of minutes between saves.

## Manual save

- To force the software to save all objects, hit **Alt+w**. Only objects that have changed will be saved.



**Warning:** automated saves do not make backup copies of media files (audio files, still images, mesh files and video files). You should make regular backup copies of the entire specific Project folder(s) and store them on an external hard drive or network store. For more information on where your specific Project folder is located please see the sub-chapter [Projects location/structure](#).



# Checkpointing projects

Once you have finalised your show, you can lock it to the version of the software that you built it with, by creating a "checkpoint".

Checkpoints are useful if you want to lock your project to a specific software version for portfolio purposes, to have a known-working state you can go back to, e.g. for demos. We recommend to create checkpoints only after a project has been finished.

Checkpoints are intended for archiving / demonstration purposes, not for running shows.

**Please note:** Checkpoints are not intended for - running shows - they are intended for archiving / demonstration purposes and saving **project file** backups; Disguise software automatically saves your **project file** regularly and on exit.



**Warning:** At present, Director/ Actor operation is not guaranteed to work for projects with active checkpoints. Disable the checkpoint if you encounter issues starting a Director/ Actor session.



**Warning:** generated checkpoints do not make backup copies of media files (audio files, still images, mesh files and video files). You should make regular backup copies of the entire specific Project folder(s) and store them on an external hard drive or network store.

## What a checkpoint does

A checkpoint means that:

- A backup of the .d3 file is stored in the checkpoints folder.
- A backup of the entire software install is stored in the checkpoints folder.

- The project is "locked" to the version of software that you built it in. Instead of the installed version (e.g. r21), the one from the checkpoint (e.g. r18) is executed.
- Therefore you can freely upgrade to the newest version of the software, knowing that the show will continue to run exactly the same way as the day you built it.
- You can still upgrade the show later on (See "How to disable a checkpoint" below).

## How to create a checkpoint

1. Right-click **d3** from the dashboard (bar at the top of the screen). Next select **Project Settings**.
2. Type the name of the new checkpoint into the **new checkpoint** text field and hit **Enter**.

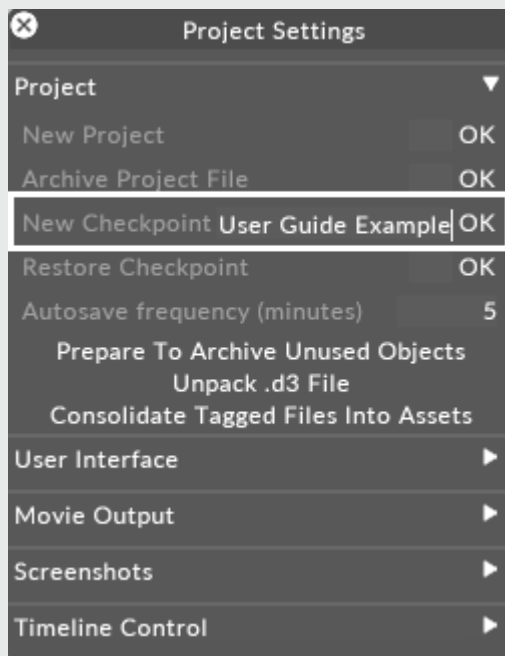

New Checkpoint property is used to create a checkpoint that allows you to open the project file in a later version of Disguise

3. Wait until a label saying **d3 checkpoint complete** pops up. This should not take more than a few seconds but may be longer depending on the size and number of resources of the project.

This will create a new folder called **checkpoint** in the specific Project folder. For information on where the specific Project folder is located please see the sub-chapter [Projects location/structure](#). Assuming that you do not rename this folder the project will now run from this

local folder, rather than the main Disguise installer.

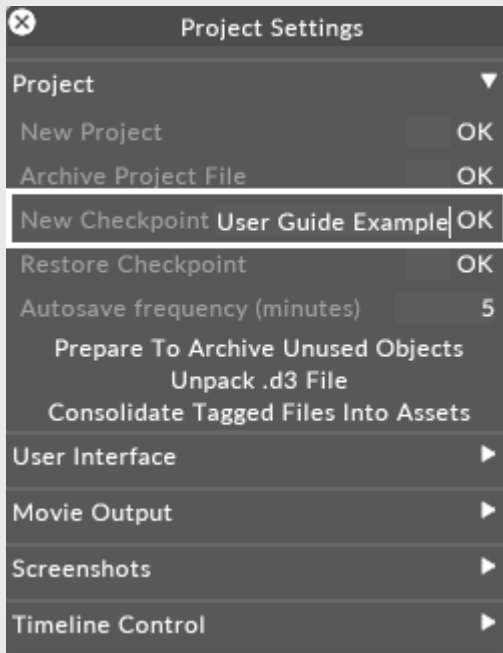

Checkpoint folder created in the specific Projects folder when a checkpoint is saved, the project will now run from this folder.

## Opening a checkpointed project created in an old release

1. All checkpointed projects created in an earlier release than r11 **need** to be copied to `c:/blip/data/d3`
2. Open the project from the d3 Manager but make sure to add a projects folder that links to `c:/blip/data/d3`

## How to disable a Checkpoint

1. Make a copy of the **.d3** file.
2. Rename the **checkpoint** folder, for example **\_checkpoint\_old\_**.

The Disguise project will now run from the main Designer installer on your system.

**Please note:** When you upgrade a .d3 project file, it may become incompatible with older versions of Disguise (such as the checkpointed version). If you want to go back to the checkpoint (by restoring the "checkpoint" folder) you may also need to restore a backup copy of your .d3 project file from your history folder.

# Project snapshots

Project Snapshots allows users the ability to save the state of a project at a time as a Snapshot. Users can then recall these snapshots to compare different points in time within a project.

## Overview

Project snapshots are an advanced saving function of Disguise software. They are intended to allow users to restore a known state of the project in a single action (a snapshot). The use case for this feature was for recording "shots" on a film set, but they can be used for many other functions.

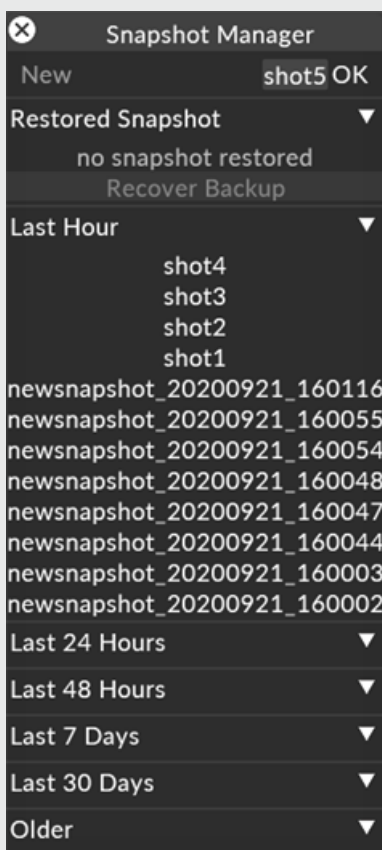

## Workflow

Snapshots are created in a similar way to saving the project

1. Press CTRL S to save a snapshot, or use the Snapshot manager
2. Name the snapshot if needed (this is recommended)
3. Restore the snapshot later to restore the entire project state and revert once you wish to go back to the current state

## Example

# Creating New Snapshots

## Using Shortcut

Snapshots saved with a shortcut are applied with a default name, to save with default names open the snapshot manager.

- To save a Snapshot press [CTRL+S] (Saving a snapshot will save the projects current state and all resources)

## Using Snapshot Manager

Saving a Snapshot with the snapshot manager allows users to give snapshots custom names

- To save a snapshot first open the snapshot manager [CTRL +O]
- Type a name of the snapshot into the snapshot name entry field at the top of the snapshot manager. (Designer will automatically timestamp the saved Snapshot name)
- Press the OK button. (The snapshot will be added the list below)

# Browsing Snapshots

The previously saved Snapshots will be added to the Snapshot List within the Snapshot Manager. Snapshots are filtered by their timestamp of the creation. To browse a Snapshot created at a certain

time simply expand the corresponding separator to view the Snapshots contained. Snapshots are filtered by the following:

**Restored Snapshot** - The last snapshot you restored.

**Restore Backup** - Revert to the state before the last snapshot was restored

**Last Hour** - Snapshots created in the last hour

**Last 24 Hours** - Snapshots created today

**Last 48 hours** - Snapshots created yesterday

**Last 7 Days** - Snapshots created this week

**Last 30 Days** - Snapshots created within the last month

**Older** - Snapshots created older than a month ago

## Restoring a Snapshot

A saved Snapshot can be recalled to return to another state of the project.

- Left-click on a Snapshot within the Snapshot List to restore to that state.
- The Snapshot List will update to show the current restored snapshot.
- Recover Backup
- A backup of the current project state occurs every time a snapshot is restored.
- Left-click on Recover Button to revert to a backup

Backups are overwritten when a new snapshot is restored.

## Renaming a snapshot

- Right-click on a Snapshot within the Snapshot List to open an options widget
- In the rename field type a new name.
- Click OK

## Archiving a snapshot

- Right-click on a Snapshot within the Snapshot List to open an options widget
- Click OK on Archive Snapshot

(Archiving a snapshot will move the snapshot file on disk to an archive folder, archived snapshots will be removed from the archive list)

# Console files

If any unpredicted problems arise during pre-production of your show just send the auto-generated console file, i.e. the "blackbox" data of your session, to the Support team. By reading the console file, the support team can quickly decipher what may have caused the problem and immediately respond with an appropriate solution.

## Finding the console.

1. Open the d3Manager.
2. Open the **help** menu and choose **open console**.



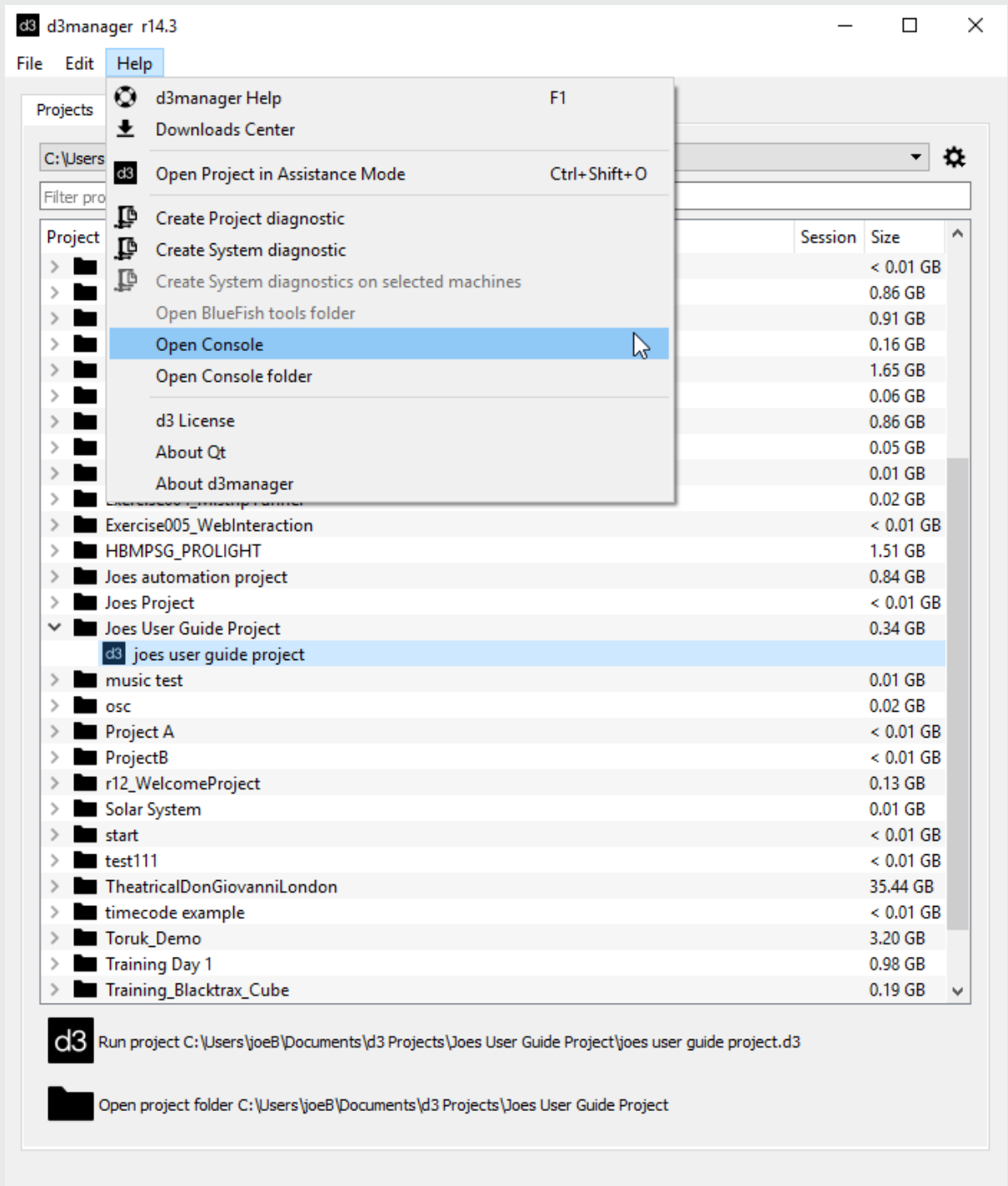

**Please note:** it is also possible to view the console within the software itself. Simply hit **Alt-C** to bring up the console. For other shortcuts please see the [Shortcuts](#) sub-chapter.



**Warning:** The console file gets overwritten every time the software runs! If you experience a problem, quit Disguise software, save the console file to a unique name



and then re-run the project.

# Diagnostic archives

Manager allows you to create diagnostic zips. A diagnostic zip is a zip file containing all relevant files need for diagnosing any issues with the software. When contacting support, we may ask you for this file.

## A project diagnostic zip contains:

- the entire project excluding the VideoFile and the DxTexture folder. Please send these separately in case they might help to debug your issue.
- Console files.

## A system diagnostic zip contains:

- Hardware, system and licensing information about the machine.

## To create a diagnostic zip:

1. Open the Manager.
2. Select the project name.
3. Go to the **Help** menu and choose **Create project/system diagnostic**.

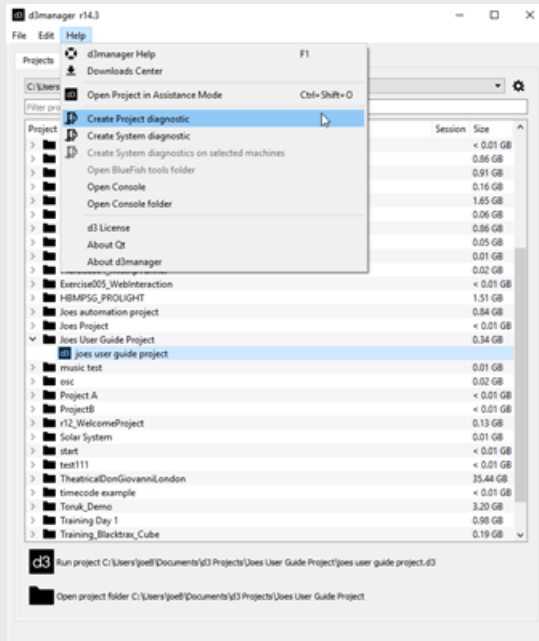

4. The diagnostic zip file will be created in your projects folder.

**Please note:** Take note of the filename and location of the created system diagnostic zip. This will be displayed in the DOS window that opens during the creation process. This will normally be in your local appdata location. To access this, you may need to modify the way that Windows displays files and folders.

# Before you get started

Make sure you've downloaded and installed the latest release (for any Designer or Hardware customers).

# Creating a new project

You can create a new project either outside Disguise software in Windows using the Manager, or within Disguise software.

## Create a new project in Manager

To create a new project see the [Creating a new project](#) page in the Manager section.

# Starting and exiting

## How to open a project

To open an existing project see the Starting an existing project page in the Manager page.

## How to quit out from a project

### Option 1: using keyboard shortcut

— Hold down **Esc** , then hit **Enter**

This will save your project, and exit the software.

### Option 2: using the interface

1. Right-click the d3 icon at the top left to open the Program Settings menu.
2. Left-click **save and exit**.

## Scheduled exit

If you want to schedule exit at a certain time do the following:

1. Right-click the d3 icon at the top left to open up the Program Settings menu.
2. Left-click **scheduled exit** to highlight the text field.
3. Type in the time when you would like Disguise software to close, using the format hh:mm. For example, the below image shows it is scheduled to close at 15:00.

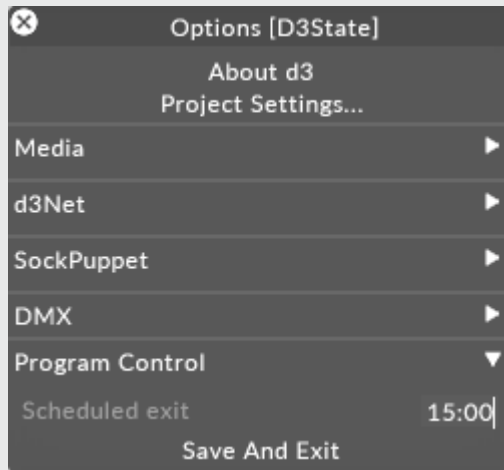

Quitting using the Program Settings menu



# GUI overview

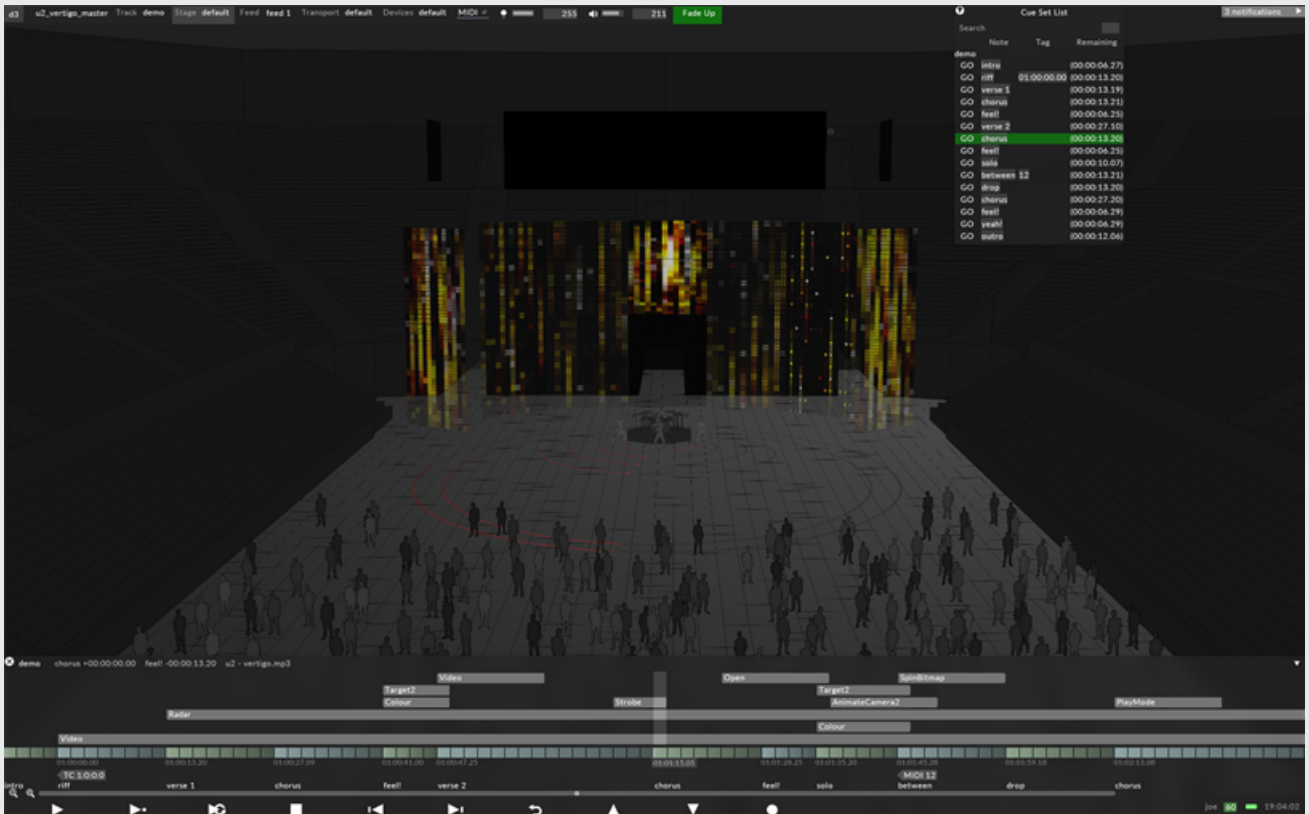

Overview of the Graphical User Interface (GUI): Dashboard, Notifications tab, Stage Visualiser, Timeline.

## Dashboard

This is the main menu of the system where you can access any system function. This is a standard object editor showing you the top level state of the system; hence the name. The menus, from left to right, are:

## State tab

Right-click **d3** in the dashboard to open the Options menu.



## Project name

The name of the project: this is the name of the **.d3** file you are running, not the folder you are running it from.

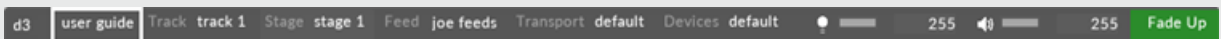

## Track

Left-click **track** to open the Track manager. This shows a list of tracks which you can choose from and edit/play. All sequencing and timeline information is organised into tracks. The entire show may be placed into one track or can be divided into multiple tracks.

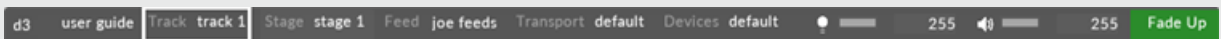

## Stage

Left-click **stage** to open the **Stage level**. The Stage level uses the Stage Visualiser to view your current stage from any angle and play video from the Timeline onto the stage in real-time, avoiding the need for time consuming re-renders.

Right-click **stage** to open the Stage editor. This allows you to choose the venue, add or remove screens, change the floor dimensions, change the number of people, set labeling of objects on/off, set the rendering style of virtual projectors and change the camera point of view. You can then create a completely new stage and use the Stage editor to switch freely between your different stages.



## Feed

Left-click **Feed** to open the **Feed level**. The Feed level uses the Feed Visualiser to view how content is mapped from your virtual screens in the Stage level to the physical output display

heads.

- Right-click **feed** to open the Feed editor. The Feed editor controls how the screen content is configured on the output heads. You can then create a completely new feed and use the Feed editor to switch freely between your different feeds. This is very useful as you can switch to a completely different set of output devices at the click of a button.



## Transport

- Left-click **transports** to open the transport manager. This shows a list of control objects which manage all external show control.
- Right-click **transports** to open the transport editor. This allows you to edit the properties of your show control objects, dictating how Disguise software responds to or generates external control signals. With this menu, you can set up MTC/ SMPTE clock chasing, DMX/ Art-Net transport control, MIDI show control cueing, MIDI transport control, OSC, and a variety of other connection protocols.

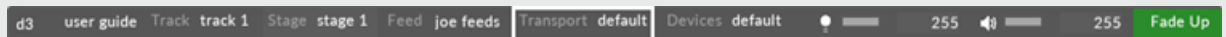

## Devices

- Left-click **Devices** to open the DeviceManager. For more information on this see the Devices chapter.
- Right-click **Devices** to open the Devices menu. The Devices menu shows a list of active devices, from which you can open a Devices manager that lists which internal or external devices are installed. Examples of devices are MIDI control surfaces, DMX managers, video input cards, etc.
- Video Input and Audio Output patching can be done here.



## Brightness

- Left-click the white brightness bar or text field to modify the master output brightness. You can fill in any number between 0 (zero) and 255 (full) in the text field. These are the minimum and maximum values. When brightness is at 0, the bar flashes red.

- Right-click the Brightness control to open the Brightness editor. This allows you to edit the minimum and maximum brightness limits, the unit step of a numerical property, and the damping factor.



**Please note:** Note that this applies to the **output brightness**. The view within the visualizer will not change.

**Please note:** When in a multi transport environment, the Brightness field will not be editable.

## Volume/Mute

- Left-click the white volume bar or text field to modify the master audio volume. You can fill in any number between 0 (mute) and 255 (full) in the text field. These are the minimum and maximum values. When output volume is muted, the indicator flashes red.
- Right-click the Volume control to open the Volume/Mute editor. This allows you to edit the minimum and maximum audio volume limits, the unit step of a numerical property, and the damping factor.



**Please note:** When in a multi transport environment, the Volume field will not be editable.

## Output mode

- Left-click **Fade Up** to open the Output Mode editor.

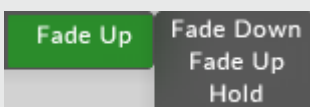

## Fade down (flashing red button)

Does a smooth fade to black from the current master level. When faded down, the indicator turns red to indicate that output is black.

## Fade up (green)

Enables full output levels.

## Hold (flashing red button)

Stores the last active frame and holds that frame in the output device until further notice, enabling you to continue working on the show in the Stage visualiser while for example outputting lineup content to LED processors or projectors.

## Notifications tab

The Notifications tab gives you a list of notifications and error messages, such as missing files or device errors.



## Stage Visualiser

The Stage Visualiser occupies the central portion of the screen. It shows a 3D visualisation of the stage and screens, and allows you to move the virtual camera around the stage. The Stage Visualiser is replaced by the Feed Visualiser when you switch from the Stage level to the Feed level.

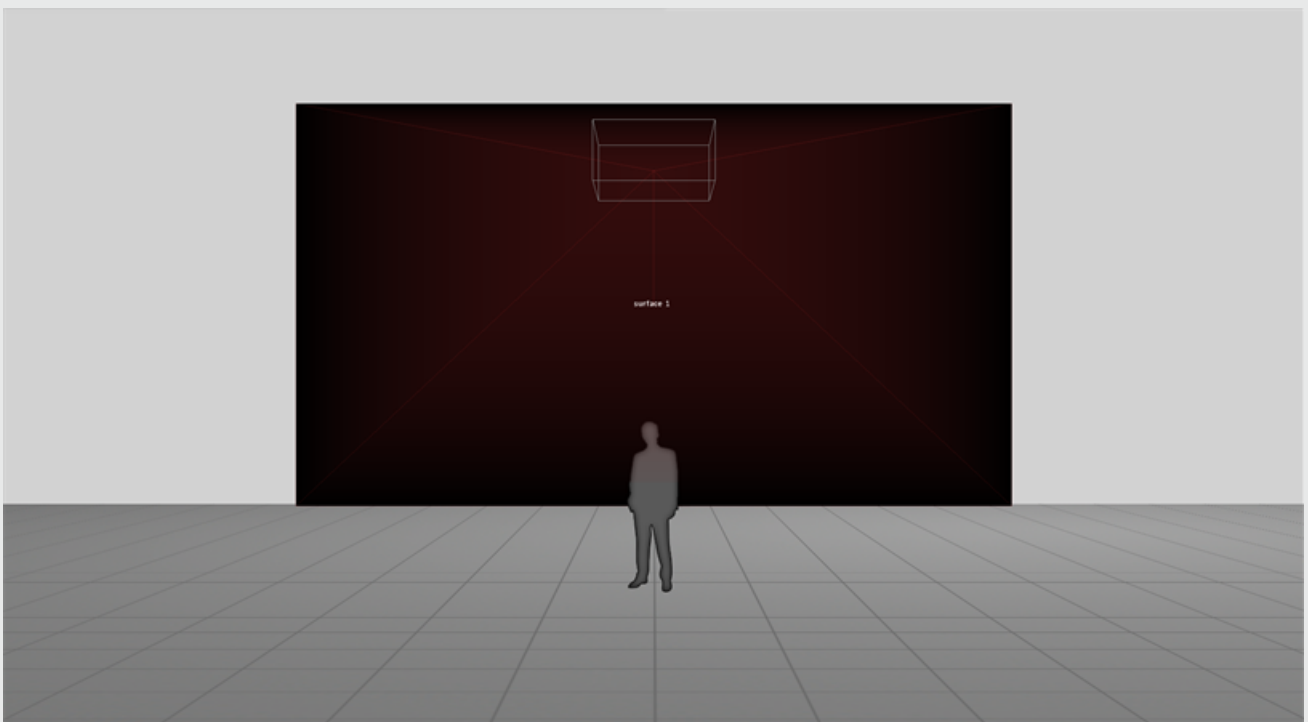

# Timeline

The editor at the bottom of the screen is called the Track Player. The Track Player is used to control the Timeline.

The top bar is called the Title bar, which shows you the track name and gives you a readout of the current time, section and audio guide within the track.

The Layer editor is located just below the Title bar. It shows you which layers are active and where they are on the Timeline.

Next are the Track bars which can be identified by the coloured section blocks. Each section has a different colour and one block equals one bar (by default, one bar is equal to four seconds).

Below the section blocks, you can see the textual Timeline notes, followed by the Transport Control buttons at the bottom of the screen (play, stop, etc).

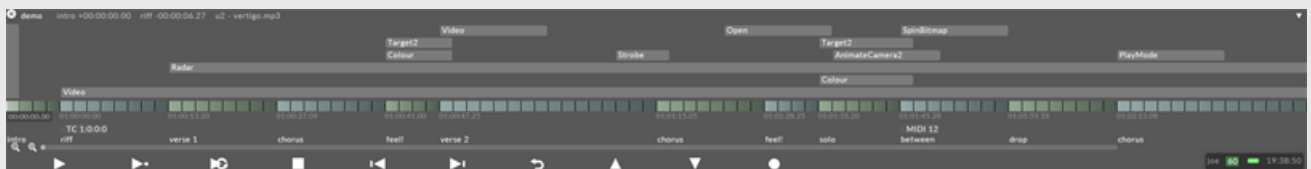

# Navigating the Stage

## Rotating around an object

1. Move the mouse pointer over the object you want to swing around
2. Hold down the left mouse button
3. Drag the mouse left/right or up/down to swing around the object
4. Release the mouse button to end the swing movement

## Option 1

1. Hold down the right mouse button.
2. Drag the mouse back and forth to zoom in and out.

## Option 2

- Use the mouse scroll wheel to zoom in and out.

## Option 3

- Hold down the **Q** key to zoom in.
- Hold down the left **A** key to zoom out.

## Zoom to object

- Left click the object in the stage.
- Press the **F** key to zoom to that object.

**Please note:** these will only work if the Stage level has mousefocus; i.e. you should click the background before these will work.

## Panning the camera

Tracking the camera moves it to the left, right, up or down without changing its orientation.

- Middle-click (click your mouses wheel if it has one) and drag, or
- Hold down the **Tab** key and move the mouse left / right / up / down.



# Camera Position Bookmarks

## Recalling a camera position

- Hit one of the function keys ranging from **F2-F11**.

## Storing a camera position

- Hold down the left **Alt** key, then hit one of the function keys ranging from **F2-F11**. This stores the current camera position on that function key.

## Resetting the camera to its default position

- Hit the function key **F12**. This will make the camera return to its central default position, i.e. south-north facing, 10 meters behind the origin position (0,0,0) in 3D space.

## Camera Bookmarks List

To open the Camera Bookmarks List window

1. Right-click the stage
2. Select the Camera tab
3. Select the Camera Bookmarks List option  
Or alternatively

Press **Ctrl + B**

default		Camera Bookmarks										
		Name	Position			Rotation			FOV	Goto	Store	Lock
Scene	▶	Unnamed	0,	2,	-67.481	0,	0,	0	90	[F2]	[ALT+F2]	🔒
Visualiser	▶	Unnamed	39.006,	30.153	, -65.788	-24.343,	-35.562,	0	90	[F3]	[ALT+F3]	🔒
LED Screens	▶	Unnamed	-0.2636,	7.4089	, -52.879	-6.75,	2.25,	0	90	[F4]	[ALT+F4]	🔒
DMX Screens	▶	Unnamed	39.006,	30.153	, -65.788	-24.343,	-35.562,	0	90	[F5]	[ALT+F5]	🔒
DMX Lights	▶	Unnamed	39.006,	30.153	, -65.788	-24.343,	-35.562,	0	90	[F6]	[ALT+F6]	🔒
Projection Surfaces	▶	Unnamed	39.006,	30.153	, -65.788	-24.343,	-35.562,	0	90	[F7]	[ALT+F7]	🔒
Projectors	▶	Unnamed	39.006,	30.153	, -65.788	-24.343,	-35.562,	0	90	[F8]	[ALT+F8]	🔒
Cameras	▼	Current Camera										▼
Camera Bookmarks List...		Position							4.5399,	99.8854,	-81.674	
Actions	▶	Rotation							-8.4,	-0.75,	0	

## Name

You can enter a custom name for each bookmark.

Left

## Position

You can view or edit the position for each projector bookmark position.

39.006, 30.153 , -65.788

## Rotation

You can view or edit the rotation for each projector bookmark position.

-65.788 -24.343 , -35.562

## Field of View (FOV)

You can view or edit the Field of View for each projector bookmark position.

90

## Goto

Left-click the button to recall a camera position using the Camera Bookmark list.

[F3]

## Store

Left-click the button to store the current visualiser camera position as that camera bookmark

[ALT+F3]

## Lock

Lock the Camera Bookmark from accidental edits.



**Please note:** When using some keyboards such as on a bootcamped Mac, you may need to use the keyboard shortcut **fn.+F2-F11** to recall camera positions and **fn + Alt+F2-F11** to store a camera position.

# Keyboard shortcuts

Many of the functions within the Disguise software are mapped to keyboard shortcuts.

To display a full list of keyboard shortcuts:

Press **F1**. Use the Search field at the top to quickly find the shortcut needed.

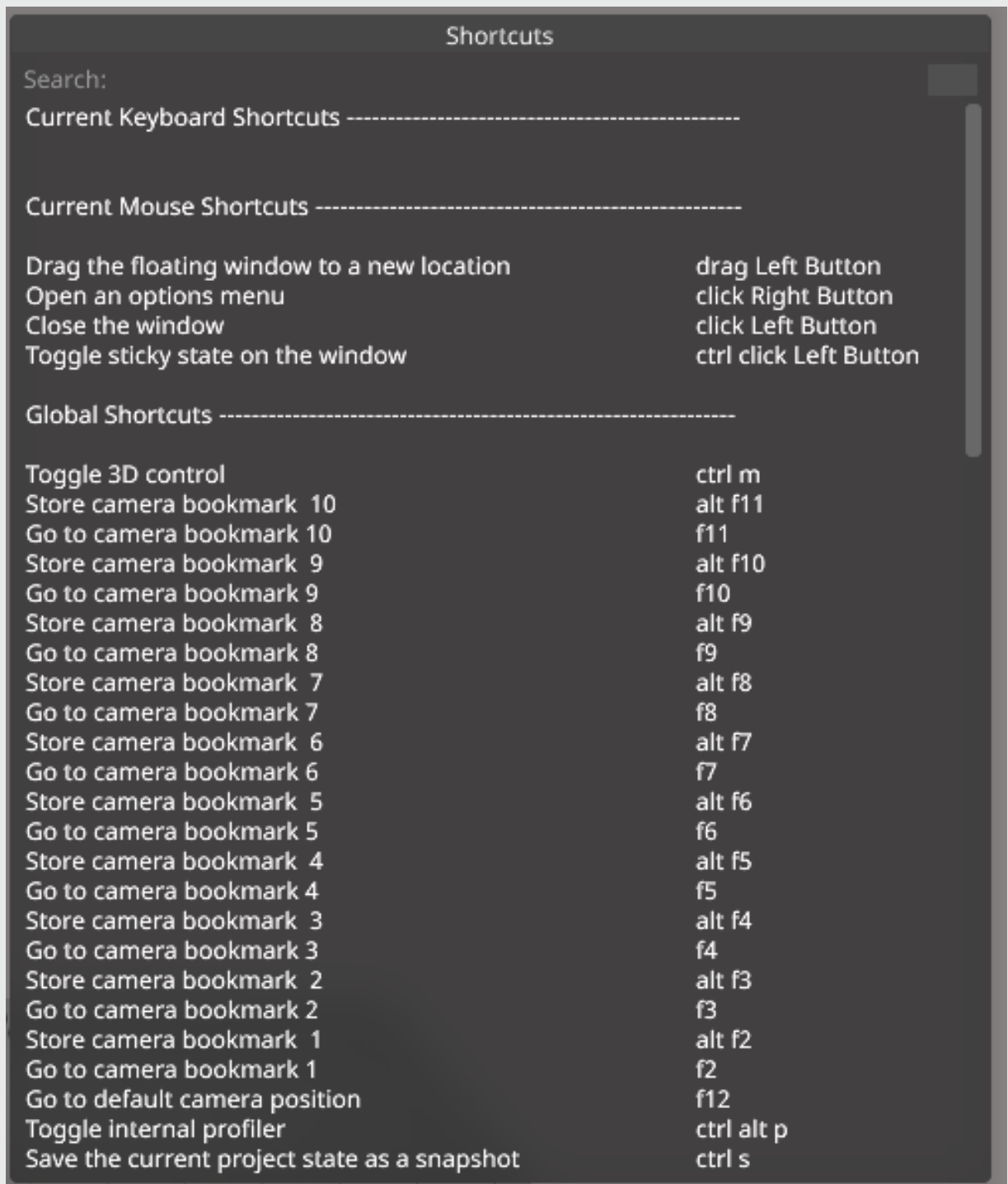

Shortcuts window within the Stage level accessed by hitting F1

Hit **F1** to close the shortcuts window.

**Please note:** The F1 window is context sensitive and will change depending on the currently active level. For example, the Feed level will display a different list than the Stage level.

**Please note:** this is not a definitive list, but is generated to the local machine so may have local and language variants

Pressing **F1** will also enable disguise to display explanations of object properties. For more information on this feature scroll down to the section 'Object property explanations in the [Editing objects](#) sub-chapter.

## Shortcuts

### General

Action	Shortcut
Quit	ESCAPE ENTER
Save	ALT W
Console*	ALT C
Debug Console*	ALT D
Profiler*	CTRL ALT P
Hold/Unhold	ALT P
Sticky Window (pin)**	CTRL + Left Click X on Header
Close Last Window	ESCAPE
Close All Windows (Except pinned)	SHIFT + ESCAPE
Screenshot***	ALT + X
Lock	CTRL ALT L
Unlock	Type (lowercase)- hydrogen

Action	Shortcut
Copy	CTRL C
Cut	CTRL X
Paste	CTRL V
Help Menu	F1
Show Options	Right Click
Force GUI	ALT G
Preview Output Feeds 1:1	ALT F
Undo Last Action	CTRL Z
Redo Last Action	CTRL Y
Fade up/Fade down	BACKSPACE
Measurement Tool	ALT + Drag from vertices of meshes and objects
Undo Measurement Tool	ALT + Right click on the numeric text of the measurement

\* See the [Diagnostics](#) chapter for more information.

\*\* Scroll down to the section 'Making windows sticky in the [Objects/object editor overview](#) sub-chapter for more information.

\*\*\* See the [Making screenshots](#) sub-chapter for more information.

## Editors

Action	Shortcut
Change field value	Scroll or Keypad Up/Down

Action	Shortcut
Change field value by small amount	CTRL + Scroll or Keyboard Up/Down
Change field value by large amount	SHIFT + Scroll or Keyboard Up/Down
Submit entered text	Enter
Select all text	Double left click or CTRL A
Toggle Alpha background	Left Click on Preview Thumbnail in a layer
Add Keyframe node	Left Click
Remove Keyframe node	Right Click
Remove Selected Keyframes	Delete
Select all Keyframes	CTRL A
Select Keyframes	SHIFT + Left Click & Drag
Edit Selected Keyframes	Right Click
Jump to Next Keyframe	]
Jump to Previous Keyframe	[
Adjust the previous and following keyframes at the same time (works when scrolling in the parameter field, not directly in the keyframe editor)	CTRL + SHIFT
Zoom In and Out	ALT + Mouse Scroll
Change to Next Sequence in Field Editor	Keypad Up/Down



Action	Shortcut
Open Multiple Keyframe Editors	CTRL Left Click Parameter

## The Stage level

Action	Shortcut
Rotate around an object	Left Click and drag
Pan Middle	Click or Hold Tab
Zoom In	Scroll Middle Mouse Button In
Zoom Out	Scroll Middle Mouse Button Out
Go to Camera Bookmark	F2 through F12
Store Camera Bookmark	ALT + F2 through F11
Select Object	Left Click
Edit Object	Right Click
Zoom to Object	Left click object and press F
Enable Manipulators	CTRL + M
Toggle world/object space	G
Manipulators Offset mode	E
Manipulators Rotate mode	R
Manipulators Scale mode	T

# The Timeline

Action	Shortcut
Play	Enter
Play to end of section	Spacebar
Play and loop	Right Shift
Jump to next section	>
Jump to previous section	<
Jump forward a quarter beat	'
Jump back a quarter beat	;
Next bar (or time amount)	Keypad Right
Previous bar (or time amount)	Keypad Left
Jump to selected bar	Enter
Split Section	ALTS
Merge Section	ALTM
Add Note	CTRL N
Add Tag	CTRL T
Open Quantiser	ALT Q
Create Layer	CTRL L

Action	Shortcut
Copy/Paste Layer	CTRL C / CTRL V
Split Layer	CTRL K
Isolate Layer	Hold I and click Layer
Rename Layer	CTRL R
Mute Layer	Hold M and click Layer
Select Layers	Hold shift and left click & drag selection box
Open/ Close Groups	G (toggle to open/ close)
Select bars	Hold shift and left click & drag selection box
Minimise/ Maximise track	CTRL - CTRL +
Open Layer Library	CTRL SHIFT L
Scroll to look ahead in Timeline while track is playing	HOLD SHIFT while adjusting SCROLL wheel on mouse

## Quantising

Action	Shortcut
Jump to next marker	]
Jump to previous marker	[
Set beat to be first in bar	Shift and Left Click

## Feed editor

Action	Shortcut
Isolate Selected Feed Rectangle	Hold I and Left Click
Delete Selected Feed Rectangle(s)	Delete
Frame Selection in Viewport	F
Frame all in Viewport	A
Nudge Selection	Keypad Left/Right/Up/Down
Select all Feed Rectangles	CTRL A
Copy Feed Rectangles	CTRL C
Paste Feed Rectangles	CTRL V
Cycle between Feed Outputs	TAB

## Director/Actor

Action	Shortcut
Refresh Actors	ALT R
Restart Actors	CTRL ALT R
Start all Actors	CTRL ALT S
Quit all Machines	CTRL ALT Q
Quit all Machines without Prompt	SHIFT ESC ENTER
Force Quit all Machines	CTRL ALT X

# Supported file formats

The Disguise software supports multiple content formats for Video, Audio, Still image and 3D model files. It is important that these formats are used for optimal performance. Only formats listed here are officially supported.

## Video files

The Disguise software supports Quicktime **.mov** files using the following codecs:

- QuickTime DXV version 2. Download the DXV codec for Mac or Windows from the [downloads centre](#).
- QuickTime HAP, HAP Alpha and HAP-Q. Download the HAP codec for Mac or Windows from the [downloads centre](#)
- QuickTime Animation.



**Warning:** We do not support Delta frames. Videos need to be exported with keyframes at every frame.

- NotchLC.

## Filename Tag Issues

Please note that if you use any of the following filename tags, you may encounter issues in Designer.

- `_region`
- `_v`
- `_frame`
- `_proxy`
- `_region`

## Premultiplied vs. straight/matted alpha

Alpha can be rendered into videos and images with subtle differences which can affect how they appear when composited upon output. Premultiplied vs straight alpha will require different blend modes depending on which is used. There is no preference in Disguise software to either one, but if using content with premultiplied alpha, it should utilize the **Premult Alpha** blend mode, rather than **Alpha**, which should be reserved for straight alpha.

Also note that **Premult Alpha** is usually the only option available when creating fuzzy edges against an alpha background, as the pure alpha workflow requires the colour which is being faded from to be available at full intensity throughout the gradient, while only fading the alpha component. That sort of thing is tricky to create in content creation packages, so falling back on **Premult Alpha** makes more sense in those cases.

## Maximum resolutions of video files and still images

- The Disguise software supports video files and still images up to 16384 pixels in one direction.
- If all heads are genlocked to the same resolution, a 4x4pro server can play up to 32 HD videos simultaneously, when encoded to HAP or DXV (no alpha).

## For audio embedded in video files:

- Uncompressed
- Stereo 16 bit
- 44.1 KHz. Currently d3 **only** supports 44.1 KHz, any other frequency will generate an error.

**Please note:** To read more about supported video loads see the individual product pages on the [disguise website](#).

## Audio files prior to r14.3

### Quantised tracks option 1:

- **.mp3**
- Stereo 16 bit
- 44.1 KHz, constant bitrate. Currently d3 **only** supports 44.1 KHz, any other frequency will generate an error.
- 256 Kb/sec is a recommended balance between quality and file size.

### Quantised tracks option 2:

- **.wav**
- Stereo 16 bit
- 44.1 KHz

## Quantised tracks option 3:

- **.aiff**
- Stereo 16 bit
- 44.1 KHz. Currently d3 **only** supports 44.1 KHz, any other frequency will generate an error.

**Please note:** To read about multi-channel audio support, see the [Output multi-channel audio](#) page.

## Audio files after r14.4

These audio file formats can be used on the [audio layer](#).

### Uncompressed WAV files with the following properties

- Unsigned 8 bit, Signed 16 bit, 24 bit or 32 bit PCM, 32-bit or 64-bit floating point encoding
- Sample rates up to 192 kHz
- 1 or 2 channels

### Uncompressed AIFF files with the following properties

- Unsigned 8 bit, Signed 8 bit, 16 bit, 24 bit or 32 bit PCM, 32-bit or 64-bit floating point encoding
- Sample rates up to 192 kHz
- 1 or 2 channels



## MP3 with the following properties

- CBR up to 320kps (variable bit-rate not supported)
- 8 kHz, 11.025kHz, 12kHz, 16kHz, 22.05kHz, 24kHz, 32kHz, 44.1kHz, 48kHz sample rates
- Stereo, joint stereo or mono

**Please note:** The software internally uses a 32-bit floating point audio pipeline, so best performance can be achieved by using 32-bit uncompressed WAV encoding, at a sample rate that matches your audio output

## Audio files after r15.2

These audio file formats can be used on the [audio layer](#).

### Uncompressed WAV files with the following properties

- Unsigned 8 bit, Signed 16 bit, 24 bit or 32 bit PCM, 32-bit or 64-bit floating point encoding
- Sample rates up to 192 kHz

### Uncompressed AIFF files with the following properties

- Unsigned 8 bit, Signed 8 bit, 16 bit, 24 bit or 32 bit PCM, 32-bit or 64-bit floating point encoding
- Sample rates up to 192 kHz

## MP3 with the following properties

- CBR up to 320kps (variable bit-rate not supported)
- 8 kHz, 11.025kHz, 12kHz, 16kHz, 22.05kHz, 24kHz, 32kHz, 44.1kHz, 48kHz sample rates
- Stereo, joint stereo or mono

## Still images

The still image formats disguise supports in order of preference:

- **.png** (supports alpha-channel)
- **.jpeg** (does not support alpha-channel)
- **.bmp** (supports alpha-channel)
- **.tiff** (supports alpha-channel)
- **.exr** (Still images only; Disguise does not support real-time playback of exr sequences)

**Please note:** The maximum texture size supported is 16k x 16k. Disguise processes very large texture resolutions (4k- 16k) faster if they are converted to HAP / DXV Quicktime movies. If there are many still images transitioning on the Timeline it may be necessary to convert them to HAP / DXV Quicktime movies.

## Image sequences

- TGA
- TIFF

- DPX

8-bit and 10bit is supported where applicable. All formats support the use of alpha channel (with the exception of 10bitDPX), and any framerate.

**Please note:** Although other formats may work, only those listed above have received enough testing to formally support.

For more information, see [Image Sequences](#).

## 3D meshes

- .obj files only.
- .obj files used as the mesh file for video screens need to be UV mapped.
- .obj files used as the mesh file for Props do not need to be UV mapped.

**Please note:** To read more about preparing 3D meshes for Disguise software, see the [3D Fundamentals](#) sub-chapter.

## Alembic files

In order to better support animating meshes, Disguise software supports Alembic (.abc) files. Simply bring the file into the project by placing it in the mesh object folder, and select the file where you would have normally selected an OBJ.

Currently supported:

— Xform

— PolyMesh

#### Not currently supported

— Curves

— Points

— Camera

— SubD

— NuPatches

— FaceSet

— Light

— Material

— Custom data

— Writing Alembic files

— Selecting Alembic objects (e.g meshes) in the stage.

# Project Settings

The Disguise software provides some standard project settings which can be accessed through the state menu.

This topic provides an explanation for each setting in the menu, as well as how to access it.

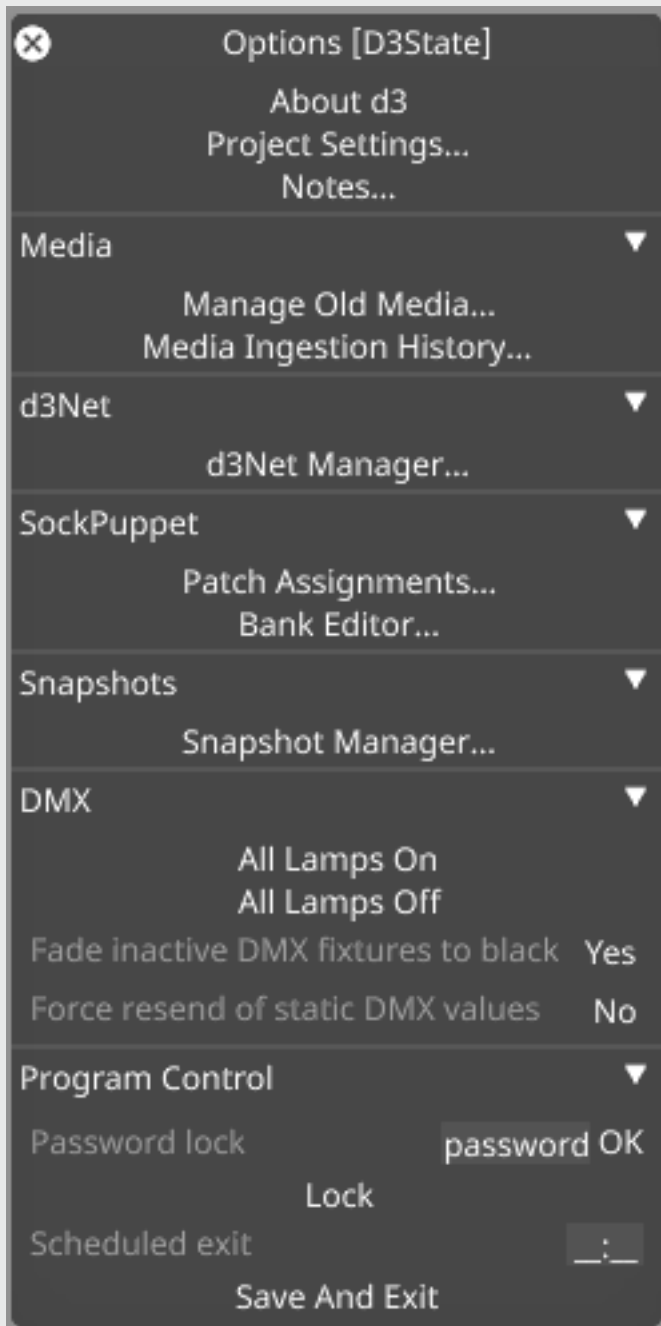

✕
Project Settings

**Project** ▼

New Project  OK

Archive Project File  OK

New Checkpoint  OK

Restore Checkpoint  OK

Autosave frequency (minutes)

Prepare To Archive Unused Objects  
Unpack .d3 File  
Consolidate Tagged Files Into Assets

**User Interface** ▼

Framerate fraction

Tooltips

Persistent key widgets

Disable UI transparency

**Unit Display Settings** ▼

Display brightness value as

Display volume value as

Display colour value as

**Movie Output** ▼

Output movie format

Output movie FPS

Stage movie size

Add head to output movie (seconds)

Add tail to output movie (seconds)

Animation Movie Format

**Screenshots** ▼

Output format

**Timeline Control** ▼

Global latency mode

Global refresh rate

Timeline audio device

Deferred jump

Global crossfade

# Accessing the Project Settings

1. Right click on "d3" in the top left corner of the interface on the dashboard; this will open the d3State Options window.
2. Left click **Project Settings** from the menu to open the Project Settings menu.

## Project tab

### New Project

Creates a new Project

### Archive project file

Essentially a "save as". Type in a name and it creates a project file in the history folder with the name you defined.

### New Checkpoint

Creates a Checkpointed project. Checkpointed projects are frozen in time and locked to a specific Disguise version.

### Restore Checkpoint

Restores a previously made Checkpoint.

### Autosave Frequency

Defines the autosave frequency expressed in minutes. This defaults to 5 minutes.



A new 'Autosaving' indicator with a 5 second countdown has been added in the bottom right hand corner above the timeline.

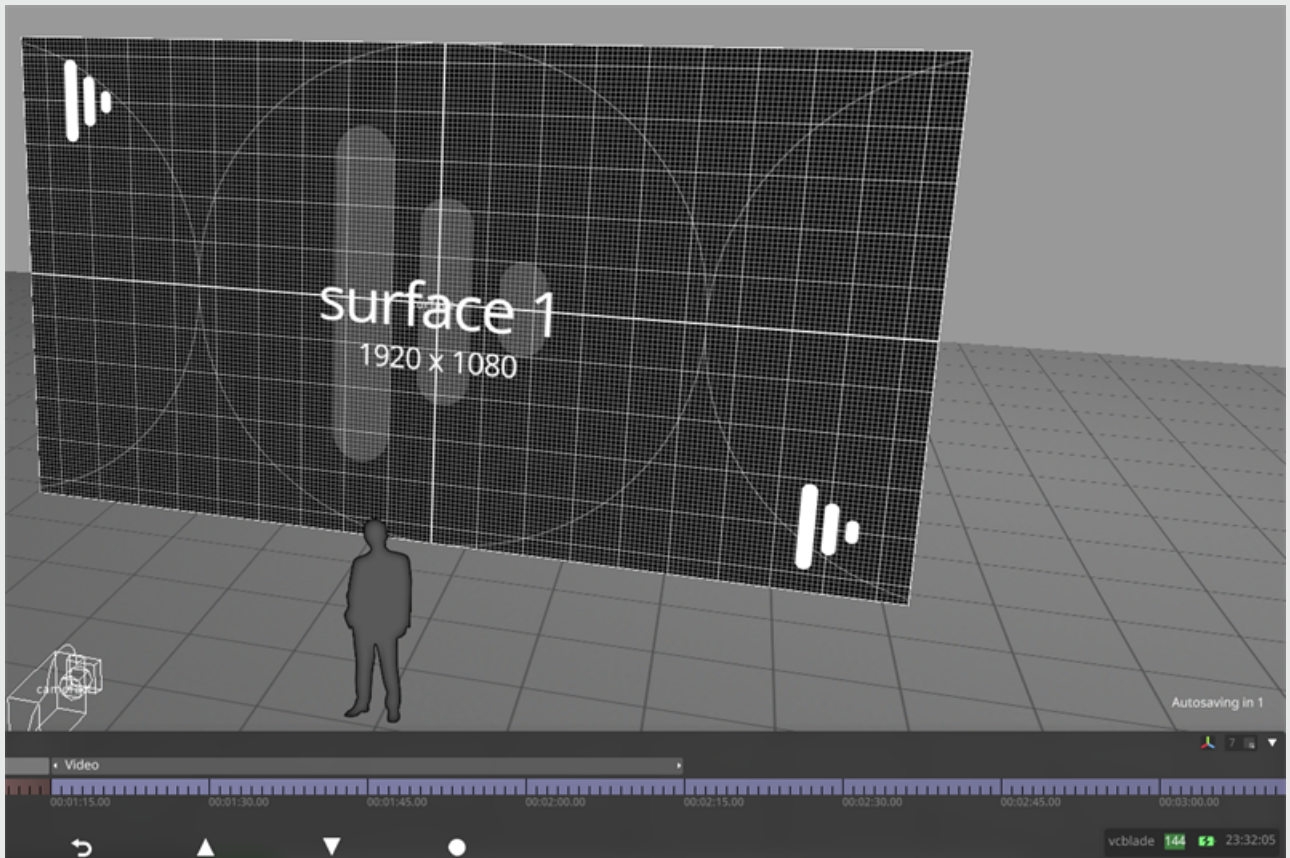

## Prepare to archive unused objects

Generates a batch file for you to then define an archive directory outside of the project file, thus releasing the files from Disguise software. See [Archive old media](#) topic for more information.

## Unpack d3 file

Unpack the contents of the .d3 project file into a new 'unpack' folder, for advanced use cases. For further information, see importing and exporting objects.

## Consolidate tagged files into assets

This is used to upgrade old projects to use versioning.

## User Interface tab

### Framerate fraction

The fraction of the framerate that the GUI renders at. This option is used to sacrifice responsiveness for performance. This option does not help in low latency modes.

**1** represents full framerate

**1/2** represents half framerate

**1/3** represents one third framerate

### Tooltips

Controls when tooltips appear in. Options for this setting are -

- Only when F1 is pressed
- After 1 second (**default**)
- After 2 seconds
- After 3 seconds

## Persistent Key Widgets

When enabled, key widgets will remain open on creation or on selection of a new layer with the same property

## Disable UI Transparency

Untick this setting to turn off transparency for UI windows to save performance

## Unit Display Settings

Defines the way the numerical values are displayed for Brightness, Volume, and Colour.

The options are:

- Normalised (0-1)
- Percentage (0-100%)
- 8-bit (0-255)

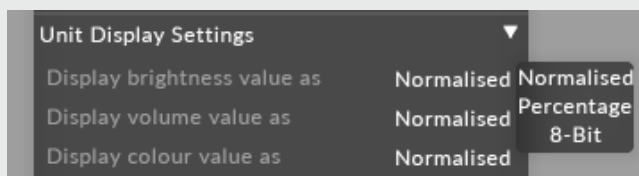

# Movie Output tab

## Output movie format

Defines the output format for Stage & Feed movies. Options for this setting are -

- Photo-JPEG (no audio)
- Animation (no audio)
- MPEG-4 (with audio) **(default)**
- Photo-JPEG mov (OLD QuickTime players)
- HAP (no audio)

## Output movie FPS

Sets the FPS the output movies should be rendered at.

## Stage movie size

Sets the resolution Stage movies should be rendered at.

## Add head to output movie

Adds additional seconds to the start of the output movie.

## Add tail to output movie

Adds additional seconds to the end of an output movie.

## Screenshots tab

### Output format

Defines the output format for Screenshots. Options for this setting are -

- JPEG
- BMP
- PNG (**default**)
- TIF
- DDS

## Timeline Control tab

### Global latency mode

Defines the levels of buffering and the rendering interval of the video output system.

Options are -

- Full speed ultra low latency (no buffering)
- Full speed low latency (one frame buffer)
- Full speed (**default**) (two frame buffers)

- Half speed low latency (halves the frame rate, one frame buffer)
- Half speed (halves the frame rate, two buffers)

Frame buffers are on the video output system, other system processing will add further latency.

## Global refresh rate

Sets the project refresh rate. For more information see the [Setting Project Refresh Rate](#) topic.

## Timeline audio device

Sets the default timeline audio device.

## Deferred jump

With this feature activated, you can now hit the left or right Arrow keys (while playing) to jump Track bars without losing sight of the original bar you jumped from (this bar will also continue to flash).

## Global crossfade duration

Sets the [Universal crossfade](#) mode & duration for the entire project.

## Reset on stop

This defines the behaviour of the Stop button. You can either reset to the start of the bar, or stay where you are. The options are -

- Always
- When Quantised **(default)**
- Never

## Video information overlay

Overlays some information on each screen in the visualiser. Options for this setting are -

- None (**default**)
- Resolution
- Smoothness
- Frame/Time

# d3State Options

The d3State Options menu houses a number of key configuration aspects of Disguise software.

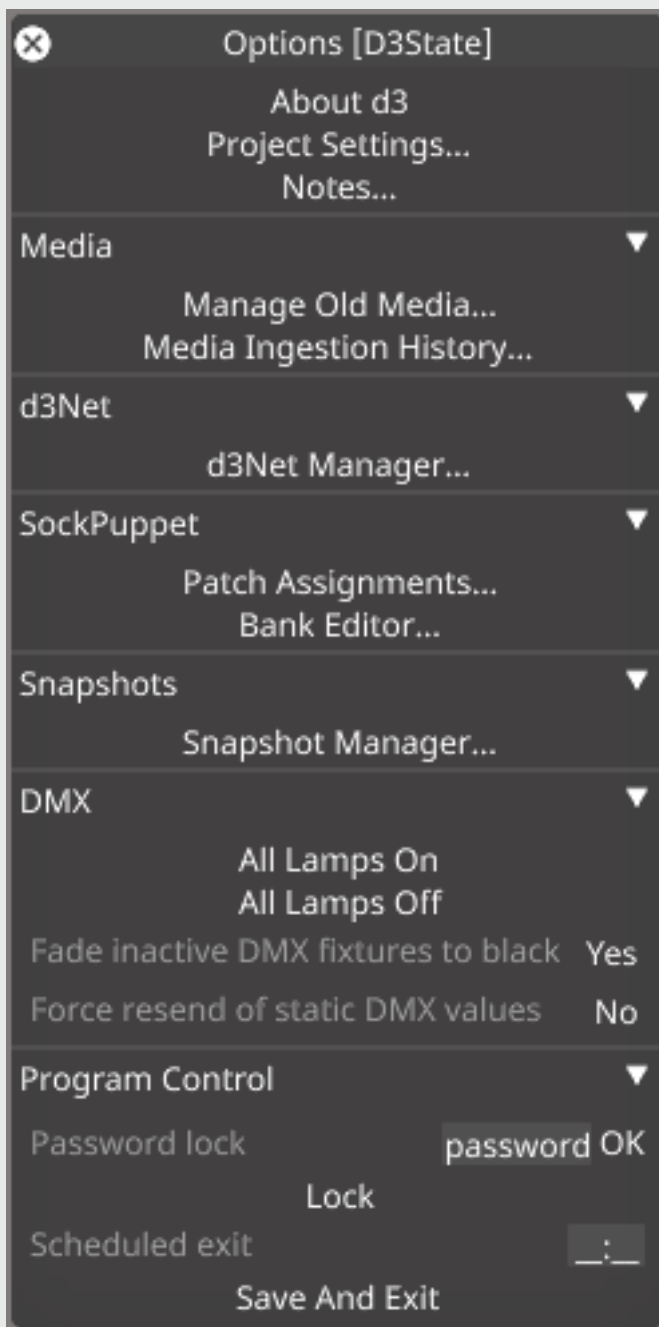

**About d3** - Opens the about d3 dialog which details software version and license information.



**Project settings** - Opens the project settings editor. For more information see [Project Settings](#).

**Notes..** - Use notes to type freeform text that synchronises over the network and is shared in the project. For more information see [Notes](#).

## Media

**Manage old media...** - Opens the manage old media editor. For more information see [manage old media](#).

**Media ingestion history...** - Opens the media ingestion history dialog. For more information see [Media ingestion history](#).

## d3net

**d3net manager...** - Opens the d3net manager for managing multi-machine networks. See [d3net overview](#) for more information.

## Sockpuppet

**Patch Assignments...** - Opens the Patch assignments editor. See [Patch assignments](#) for more information.

**Bank Editor...** - Opens the Bank editor. See [Bank editor](#) for more information.

## Snapshots

**Snapshots manager...** - Opens the Snapshots manager. For more information see [Project Snapshots](#).

## DMX

**All lamps on** - shortcut to lamp on all DMX fixtures.

**All lamps off** - shortcut to lamp off all DMX fixtures.

**Fade all inactive DMX fixtures to black** - setting to fade inactive DMX fixtures to black when they are not displaying content.

**Force resend of static DMX values** - Force the resend of static values.

## Program control

**Password lock** - defines the password to unlock the software. The default is "password" but this can be changed by the user. Emergency password for users who have forgotten the password they set, or

accidentally lock the software is HYDROGEN.

**Lock** - left click this button to lock the software, or use the shortcut CTRL ALT L.

**Scheduled exit** - set a time for the software to automatically save & exit.

**Save & Exit** - Save & exit the software. This can also be done by holding ESC and pressing ENTER. See [running & quitting](#) for more information.

# Objects editor overview

## Overview of objects

### What is an object?

Everything in the Disguise software is an **object**. An object is an entity that has a list of named properties. For example, a Screen object has properties such as Offset, Rotation, Scale, Resolution, Mesh, Pixel Mask, Population Mask etc. These properties can be edited using an **object editor**.

### Types of objects

Every object in the system has a type. For instance, objects in the Stage Visualiser may be of the type Screen, DmxLights, DmxLine, DimmableScreen, Projector and Props.

For more information on how to add screen and prop objects please read the next chapter [The Stage](#). Read more about the different screen types in the [Screen types overview](#) sub-chapter.

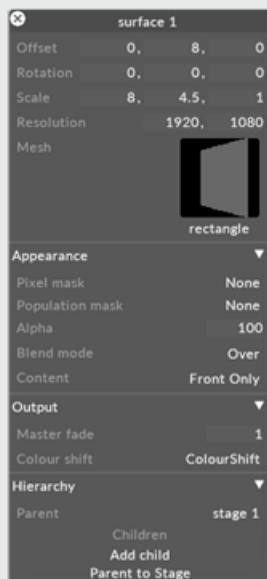

Screen object and its editor, everything in the Disguise software is an object and all properties of an object can be edited using an object editor

## The standard object editor

All properties of an object can be edited using an object editor. For instance, a Screen objects properties can be edited using the **Screen object editor**. In some cases, specialised editors have been created to provide more intuitive user interfaces. For example, the Track Player at the bottom of the screen is a specialised object editor for the Track type.

## Opening an editor for an object

To open an object editor:

- Right-click an object, for example, any 3D object in the Stage Visualiser.

## Making menu windows sticky

It is possible to make menu windows 'sticky'. A menu window is simply a window in the software, such as an object editor. This means that when you close and restart the software, the menus will remain open. This is particularly useful if you are editing objects and you do not want to have to reopen all of the object editors after closing and restarting.

To make a window sticky:

- **Ctrl + left-click** on the close button (x) of the window. You will notice that the close buttons icon changes.

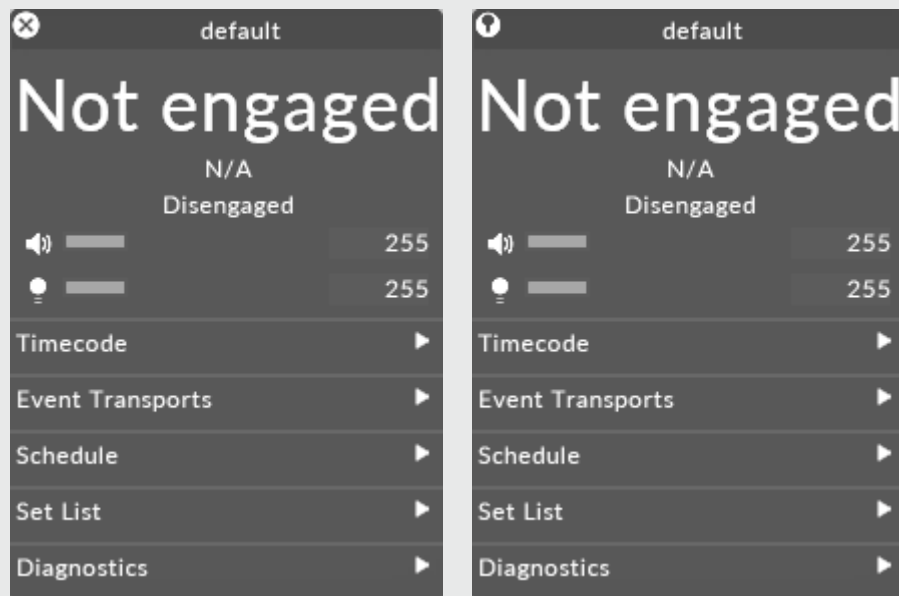

## Finding out the name of an object

Every object has a unique name; this name is displayed in the title bar at the top of a standard object editor.

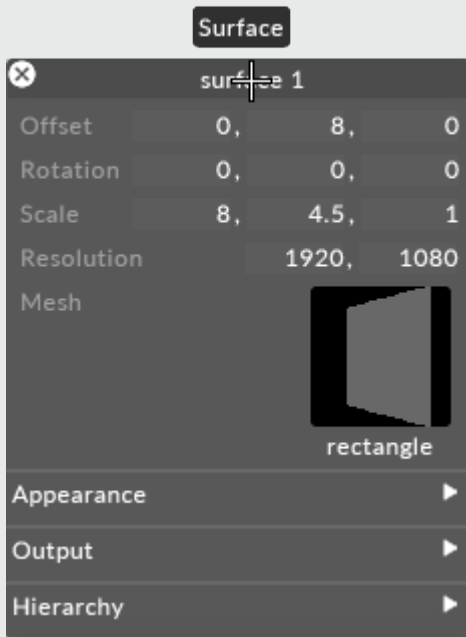

## Finding out the type of an object

To find out the type of an object, hover the cursor over the title bar of an object editor; a popup text box will show you the type of the object.

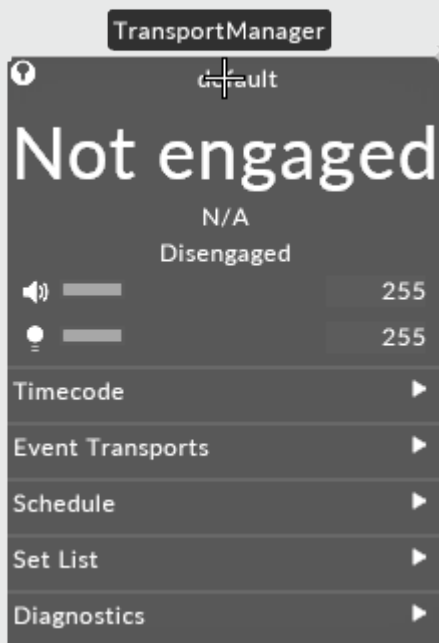

Object type descriptions are displayed by hovering the cursor over the title bar of the objects editor

# Object libraries

The object library is a quick way to access stored objects within the system. Each object type has its own object library.

For example, the Screen uses a bitmap object as one of its properties in the Bitmap object editor. The bitmap property has its own object library where you can select which bitmap you want to project onto a Screen object.

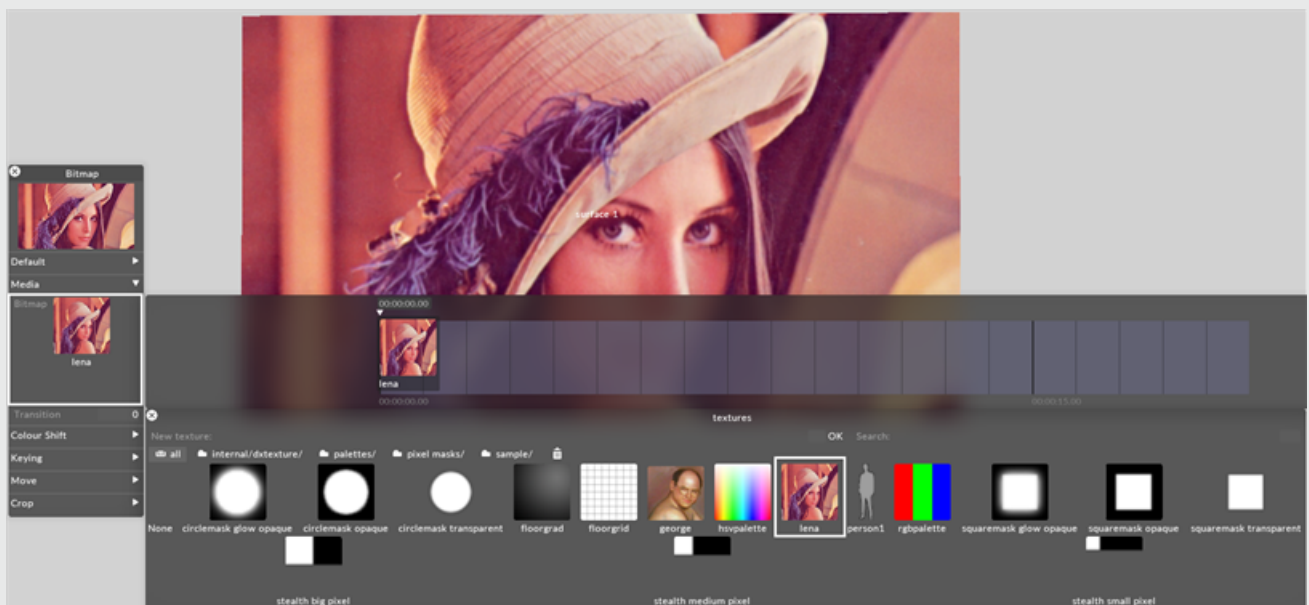

Using the Bitmap object library to select a bitmap to be projected onto a Screen object.

## Selecting an object

You can open an object library by left clicking a property in the standard object editor. Left clicking any object in the library will select that object.



Selecting a bitmap object from the Bitmap object library

## Organising objects in boxes

Objects are stored in named boxes and can be ordered from within those boxes (i.e. each box is like a playlist). One object may also appear in more than one box. Left-clicking a box will show you objects of that particular type only.

These boxes are represented by a list of tabs. Left-clicking a box tab opens up an array of objects below the box tab while highlighting the selected box. For these reasons an object library can also be known as an object box viewer.

Bitmap object boxes used to organise bitmaps by different types within the Bitmap object library

The **all** box contains all objects of that type, sorted either alphabetically or by date of creation (the most recently added objects will come first). The **trash** box (represented by a trash-can icon) contains objects that are no longer required.

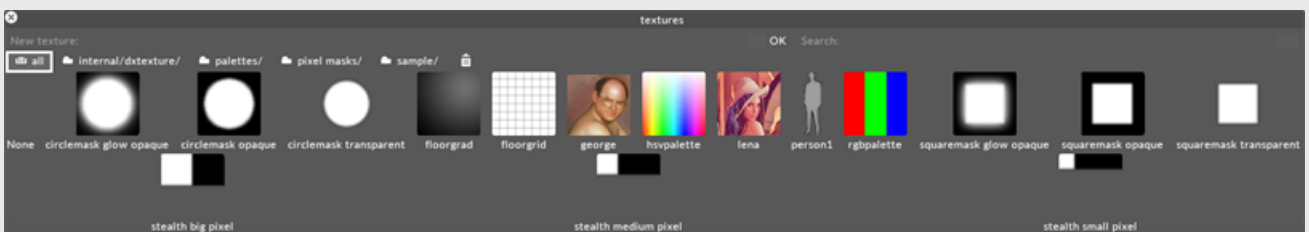

All and Trash boxes used to organise bitmaps within the Bitmap object library

The Object Library's top row contains a New Object field and a **search** text box.

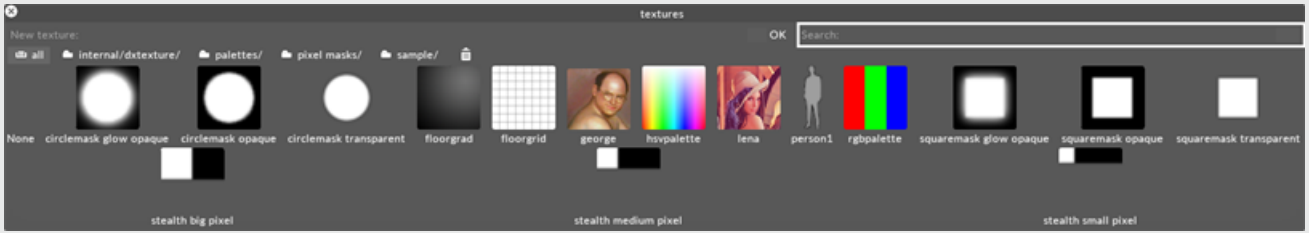

The Search box will help you locate objects more efficiently within the Bitmap object library

## Reordering objects within an object box

Select the object box by left-clicking its tab. When the **sort** button is not highlighted, objects are displayed in the order you choose. In this mode, you can click on any object, drag it left or right and release the mouse button to drop it in its new place in the list.

## Searching for an object

Left-click the **search** textfield at the top right corner of the object library and type in a search term. All object boxes will be filtered to contain only those objects whose names contain the search term (case insensitive). Clearing the search text field restores the view of all available objects.

## Removing an object from the library

Click the **all** box tab and drag the object thumbnail to the **trash** box tab.

## Restoring a deleted object

Click the **trash** box tab. Find the object you want to restore and drag it back to the **all** box tab.

## Emptying the trash

To permanently delete the removed objects, right click the **trash** box tab and select **empty trash**.

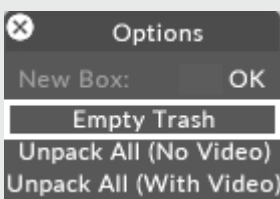

Empty Trash deletes objects permanently from an object library





**Warning:** this operation cannot be undone. The objects in the trash-can are permanently deleted. If you wish to restore an object that has been emptied from the trash, you will need to go to a previous `.d3 Project` file in the `History` folder. Please see the sub-chapter [Auto-backup](#) for more information.

## Moving an object from one box to another

Simply drag the object thumbnail and drop it on top of the tab of the destination box. This will copy the object rather than moving it. By default, the object will be added to the top of the box.

## Removing an object from a box

Drag the object from the box and drop it onto the desktop background.

## Creating a new object box

Right-click any box tab to see an option that says **new box** followed by an editable text field. Left-click the text field, type in the name of the new box and hit **Enter** (or click **ok**). This will create an empty box with that name.

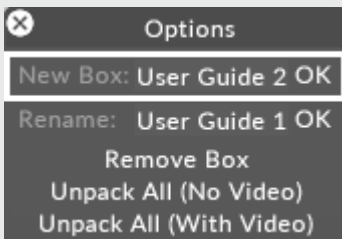

## Renaming an object box

Right-click the object box tab to see an option that says **rename box** followed by a text field. Type in the new name and hit **Enter** or click **ok**.

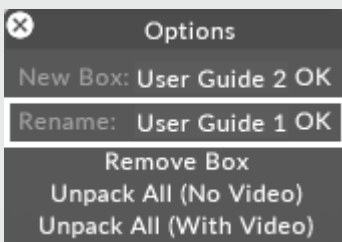

Renaming the User Manual box to User Manual 1

## Removing an object box

Right-click the object box tab and select **remove box** .

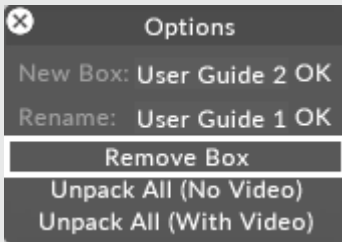

## Organising boxes to reflect folder structure

By default, creating a folder within the **objects** folder on the drive will create a new box with that name.

If the folder contains other folders, then left-clicking this box will show you a second level of boxes, representing the lower level of folders. Boxes that represent folders cannot be removed, reordered or renamed; they are indicated with a small folder icon at the left of the box tab.

# Managing Objects

Right-clicking the title bar of a standard object editor will open the Object options menu.

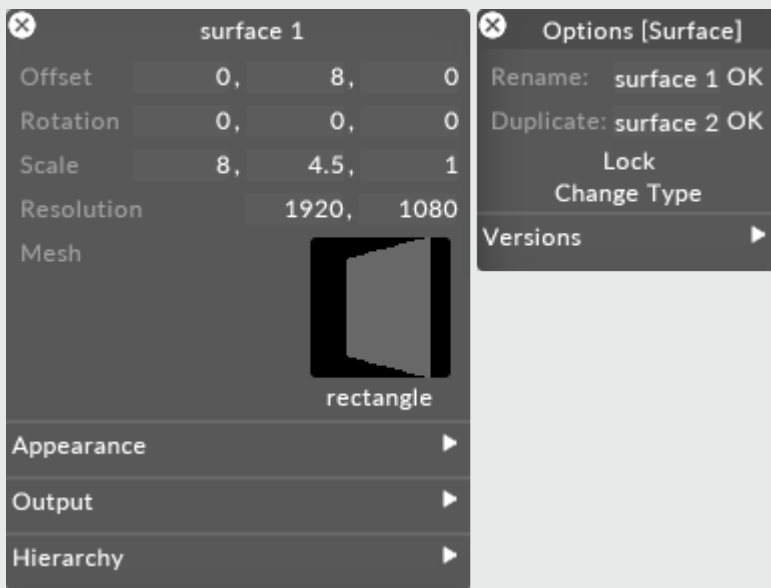

Object options menu for a Screen

## Renaming an object

The first option is **rename**, followed by an editable text field.

To rename an object:

- Type the name of the object in the rename text field and hit **Enter** (or click the **ok** button to the right of the text field). If the new name already exists, a small message will pop up explaining this.

## Duplicating an object

The second option is **duplicate**, followed by an editable text field.

To duplicate an object:

- Type the name of the object in the duplicate text field and hit **Enter**.

# Locking and unlocking an object

Objects can be locked to prevent other users from accidentally editing their contents. A locked object shows a red title bar with the word **[LOCKED]** appearing to the right of the object name.



Locking an object prevents other users from accidentally editing their contents

A locked object can still be edited to test what happens when you edit its properties. However, the modified properties will not be saved when exiting d3. Unlocking the object will cause the values to be saved as normal.

To lock an object:

- Left-click **lock** from the Object options menu.



**Warning:** people sometimes fail to notice the red title bar and make edits to locked objects, expecting them to be saved. Disguise does not warn you that the changes have not been saved when quitting without unlocking. Therefore be careful when you are using this option. A future release will issue a warning if locked objects have been edited and give you the option to save them.

# Unpacking an object

For step-by-step instructions on how to import/export objects and from one project to another, please see the [Importing/Exporting Between projects](#).

# Rolling back an object to a previous version

The final option in the Object options menu, **roll back**, is used to roll back an object to a previous version.

Any time you exit the software, the state of every object is saved. Hitting **Alt-W** will also save the state of every object in the software (only objects that have changed will be saved). Every object stores the previous seven versions, including date-stamps, for when they were created.

To rollback an object to a previous version:

1. Open the objects editor and right click the title bar. This will open the Object options menu.
2. Select **rollback** from the Object options menu, then you will see a list of version date-stamps.
3. Left-click the date-stamp you want to roll the object back to.

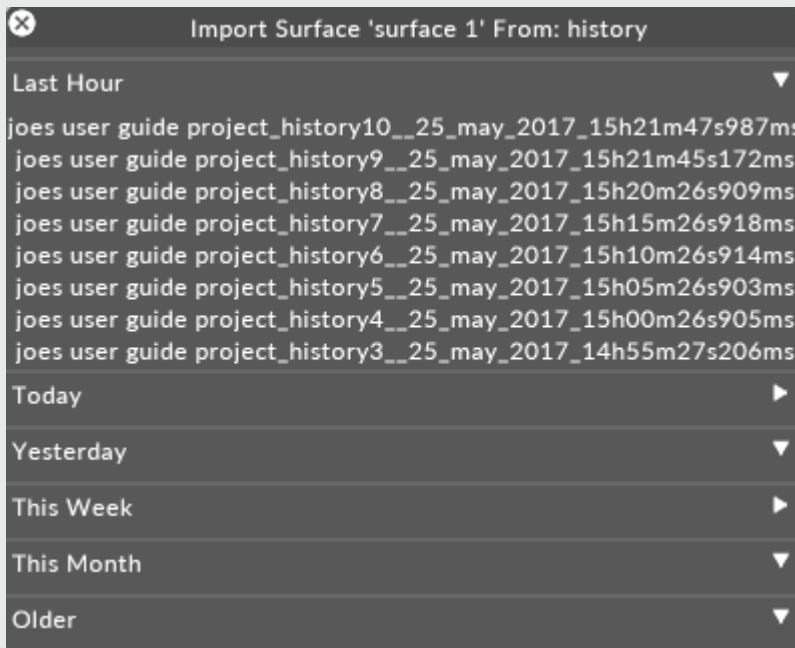

The Disguise software saves the last seven versions of an object with their date-stamps, opened by right-clicking an objects title bar and left-clicking Rollback

If the object cannot be roll-backed because it has been deleted, or the current **.d3** Project file becomes corrupted or otherwise fails to load, it is possible to revert to a previous version of the **.d3** Project file. For information on this feature please see the above sub-chapter [Auto-backup](#).

For information on how to use the other options from the Object options menu please see [editing objects](#) topic.

# Editing objects

## Types of object properties

An objects properties can be categorised into four types. Examples of these four types are described below using the example of a Screen object and its editor.



Properties of an object can be categorised into four types: Numeric, Options, Object, Array.

## Numeric

With a numeric property, you are asked to fill in a numeric value.

## Options

An option property gives you a fixed option list to choose from.

## Object

An object property refers to another object.

The example above highlights **mesh** as an object property. In this instance the **mesh** property is set to a Rectangle mesh.

## Array

An array property is used when an object property points to a list of other objects when you wish to edit it.

In the example above I have left-clicked the **mesh** property to open the Mesh [object library](#). Notice the object library contains further mesh objects such as Concave and Cylinder objects which can be swapped for the Rectangle mesh object. This is an example of an array property because the Rectangle object points to a list of other objects.

The information below provides a detailed overview on how to edit the four types of object properties.

## Editing numerical properties

There are several ways to edit a numerical property:

### Adjust using the scroll wheel

Left-click the property name or text field and use the mouse scroll wheel for adjusting the numerical property. Each step of the wheel will add or subtract a **step** value. Holding down the left **Shift** key will step ten times faster; holding down the left **Ctrl** key will step ten times slower.

### Adjust using the Arrow keys

Left-click the property name or text field and use the **Arrow** keys to adjust the values. Each click of the **Arrow** key will adjust the value by the **step** value.

### Type in the number directly

Left-click the property name or text field and type in a new value to replace the old one.

## Type in a numerical formula

Left-click the property name or text field and type in a formula, for example,  $(1 + 5) * 4$  . Press **Enter** to replace the formula with the result.

surface 1			
Offset	0,	8,	0
Rotation	0,	0,	0
Scale	$(1+5)*4$ ,	4.5,	1
Resolution	1920,	1080	

## Change the minimum and maximum limits of a numerical property

Right-click the object property name; this will open up a small editor with four values: **min** , **max** , **step** and **damping**. By default, when min > max, there are no limits. If min < max, then the numerical property is automatically restricted to the min/max range.

surface 1			
Offset	0,	8,	0
Rotation	0,	0,	0
Scale	8,	4.5,	1
Resolution	1920,	1080	

'Offset'	
Minimum	0
Maximum	-1
Step	0.1
Damping	0

Minimum and maximum limits of a Screen objects Scale property

## Change the Step of a numerical property

The **step** value controls the increment at which a numerical property changes.

surface 1			
Offset	0,	8,	0
Rotation	0,	0,	0
Scale	8,	4.5,	1
Resolution	1920,	1080	

'Offset'	
Minimum	0
Maximum	-1
Step	0.1
Damping	0

Step value of a Screen objects Scale property



## Damping

If a numerical parameter is linked to a MIDI surface control, the **damping** value smoothens the incoming MIDI value to a 0-255 range ( MIDI only ranges between 0-127). The higher you set the damping value, the smoother the conversion will be.

surface 1				'Offset'	
Offset	0,	8,	0	Minimum	0
Rotation	0,	0,	0	Maximum	-1
Scale	8,	4.5,	1	Step	0.1
Resolution	1920,		1080	Damping	0

Damping value of a Screen objects Scale property

To see how to link a MIDI control surface to a numerical parameter in Disguise software, see the [Expressions](#) section.

## Editing an option property

Left-click the option property name or value; this will open up a small menu with available options. Left-click the option you want.

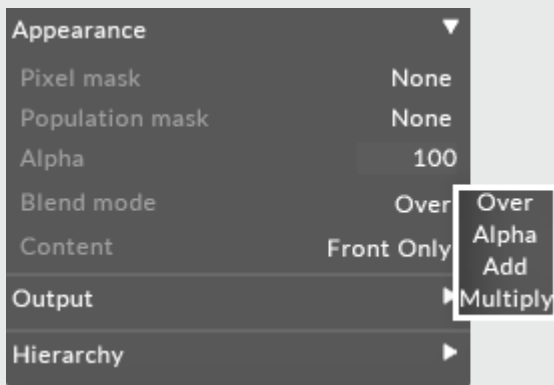

Option properties to decide how content should appear on a Screen object

## Editing an object property

To examine or edit the object that the property refers to, right-click the object property name or thumbnail.

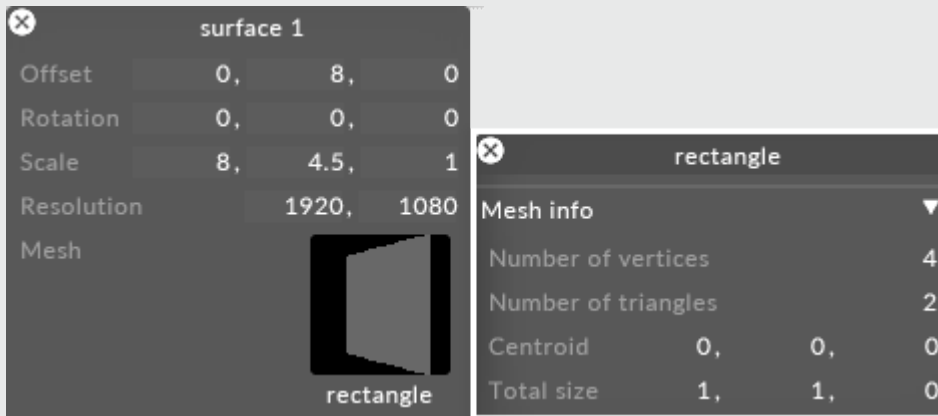

Right-clicking Mesh to access an objects properties, in this example a Rectangle

## Editing an array property

To swap the object for a different object, left-click the object property name or thumbnail. This will open up an object library. Left-click an object thumbnail to select that object.



Left clicking Mesh to access the Mesh object Library where you can swap an object for a different object

## Object property explanations

The Disguise software is able to provide useful explanations on different object properties. To enable Disguise to display explanations of object properties:

- Hit **F1**.
- Hover your mouse cursor over an object. A text box should appear that provides an explanation of that particular object property.

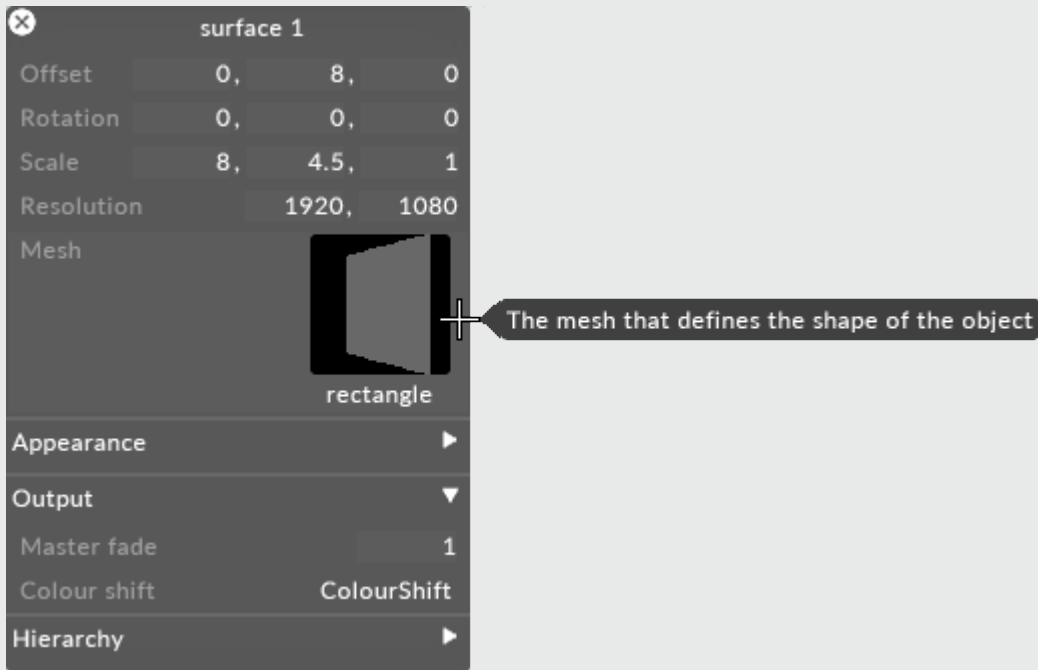

Object properties explained in a useful text box when you hit F1 and hover your mouse cursor over the particular property

— Hit **F1** to exit this mode.

Hitting **F1** will also open a **Shortcuts menu** . For more information on the Shortcuts menu, and to learn all of the shortcuts in Disguise, please see the sub-chapter [Shortcuts](#).

## Separator tabs

Object editors may contain elements called **separator tabs** , which appear as lighter grey bars with a sideways facing triangular arrow (when closed) or downward facing triangular arrow (when open). Separator tabs hide additional editor text fields or command actions, collecting them into sensible groups. Left-click separator tab to open or close it.

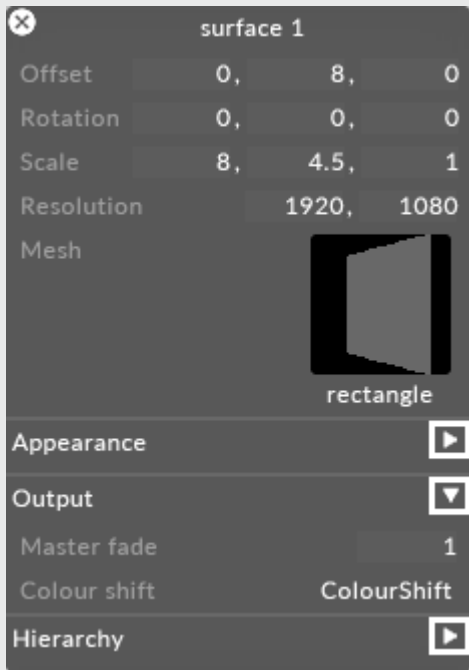

Separator tabs dividing the Screen Object editor into Appearance, Output and Hierarchy

# Multi-edit

As of r16, you can select and edit most user creatable objects in a single editor.

## Selecting multiple objects

Objects can be selected from their manager by holding CTRL and left clicking each individual item, or by holding shift and selecting the first and last object in a range.

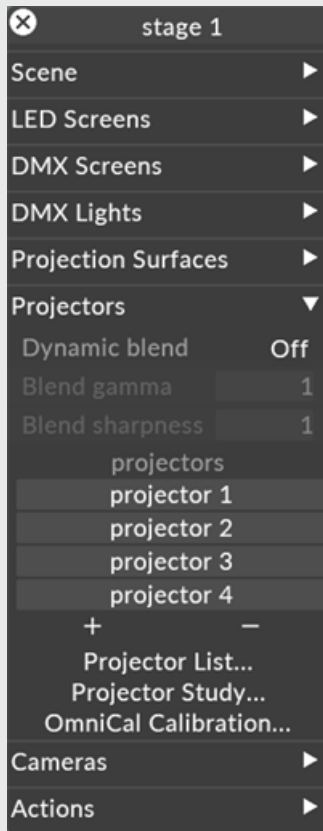

## Editing multiple objects

1. Right click the selected objects from the manager or list.
2. The multi editor opens.
3. Select the items in the editor you wish to edit.
  - To select all, use hold **SHIFT**, left click the first and then last.
  - To select a sub set, hold **CTRL** and left click the desired objects.

4. Enter a new value for the field you are editing, press **enter** to apply that to all other selected items.

**Please note:** Not all objects in Disguise software currently support multi-edit functionality, so occasionally you may find something that does not work with this functionality. If this occurs, please contact [disguise support](#).

## Managing parameters displayed by multi editor

You can show/hide columns in the multi editor by right clicking the header and toggling parameters on and off.

Projectors						
Name	Resolution		Brightness (Lumens)	Feather	Anti-aliasing	Face Cull Mode
projector 1	1920,	900	20000	0	None	None
projector 2	1920,	500	20000	0	None	None
projector 3	1920,	900	20000	0	None	None
projector 4	1920,	500	20000	0	None	None

- ⊗ Show/Hide Columns [Projector]
- Name (visible)
  - Resolution (visible)
  - Colour (hidden)
  - Render mode (hidden)
  - QuickCal reticle (hidden)
  - Brightness (Lumens) (visible)
  - Configuration (hidden)
  - Master fade (hidden)
  - Colour shift (hidden)
  - Feather (visible)
  - Anti-aliasing (visible)
  - Face Cull Mode (visible)
  - Offset (hidden)
  - Rotation (hidden)
  - Tracking source (hidden)
  - Scale (hidden)
  - Mesh (hidden)
  - Pixel mask (hidden)
  - Population mask (hidden)
  - Alpha (hidden)
  - Blend mode (hidden)
  - Content (hidden)
  - Colour Profile (hidden)
  - Colour LUT (hidden)
  - screens (hidden)
  - mask objects (hidden)
  - masking scale (hidden)
  - gridSize (hidden)
  - gridThickness (hidden)



# Object assignment hotkeys

As of r17.3, keyboard shortcuts can be set for user creatable objects, such as mappings, videoClips, Textures etc. These shortcuts are useful for recalling objects stored in Quick Select Slots located in an object's window.

## Assigning hotkeys

Open an Object manager, such as VideoClip or Texture. This can be done from a layer by left clicking the parameter to open the keyframe editor.

1. Left click the small arrow in the titlebar or right click anywhere in title bar.
2. The **Quick Select Slots** editor is displayed.

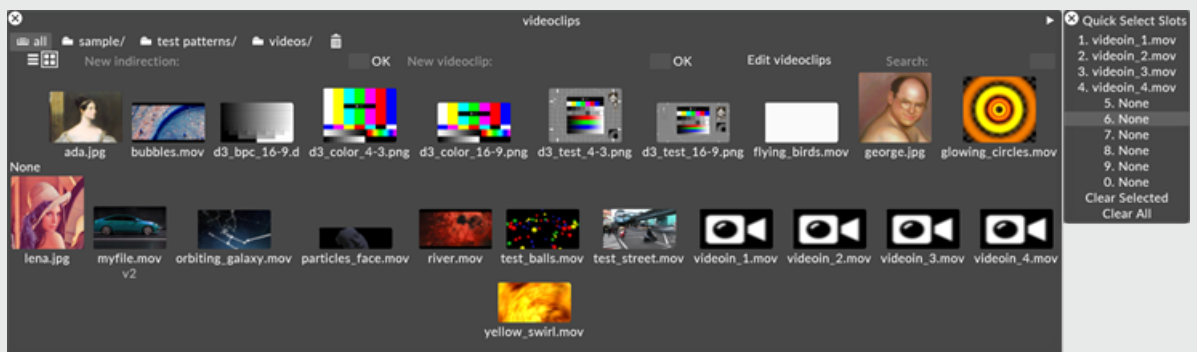

3. Select a slot by left clicking, this highlights the target slot.
4. Select an object from the view by left clicking it.

5. The target slot is populated with the resource (as opposed to adding a keyframe to the keywidget).
6. Close the **Quick Select Slots** editor to re-enable clicking a resource in the object view to target the timeline.

## Using hotkeys

When a keyframe editor is open that has objects that have hotkeys assigned, press the corresponding number on your keyboard to quickly add that object as a keyframe at the current playhead position.

## Removing hotkeys

1. Left click on a number slot
2. Left click **Clear Selected** or **Clear All** to remove all assignments.

The role of None:

By default the rest of the hotkeys (5, 6, 7, 8, 9, 0) are assigned to None. This does not represent empty for properties such as Palette & Media/ Video. The assignment of “None” within these properties to a number slot is of utility as it can be used to cut a video to black. For properties such as Mapping “None” represents the state of being empty.

# Object tracking source

## Overview

Object tracking source, added in r16, allows the user to easily link an object in Disguise software stage to an automation object. This helps to make it clearer, which automation devices are controlling which elements in the stage and enables the user to assign whole sets of axis to an object at a time.

## Workflow

1. Create objects in the stage, such as screens, projectors, props etc.
2. Create an automation device.
3. Configure the automation device.
4. Assign the tracking source of the object to the automation device.

## Example

### Generated workflow

When setting up your automation device, create the axis as normal, but do not set the property field or object field.

1. Right click an object to open its properties.
2. Left click the Tracking Source field.
3. Assign the object to a set of incoming automation axis.

4. Surface should use chosen axis orbit/ position information.
  - Offset and Rotation fields should turn green to indicate that they are being controlled by automation.
5. To clear, click the Tracking Source field and select **None**.

## Per axis workflow

When setting up your automation device, create the axis as normal, but do not set the property field or object field.

1. Right click an object to open its properties.
2. Left click the Tracking Source field.
3. Enter a new **objecttrackingsource** name and click OK.
4. Use the editor to assign each automation axis to a property of the object. I.E. Axis 1 controls X offset.
  - Offset and Rotation fields should turn green to indicate that they are being controlled by automation.
5. To clear, click the Tracking Source field and select **None**.
6. Also try to set and then adjust the frame of reference in order to transform the input positions. E.g. units or stage center.

# Importing & Exporting Objects

## Transferring objects between projects

Disguise allows you to export objects from one project, which can then be imported into different project. For example, you can export a track, stage object or device from one project into another. If an object is dependent other resources in the project (e.g. a track might contain layers which use a number of different mappings), the software automatically bundles all dependent objects into the same export package.

The examples here will show how to transfer a track, surface or screen position receiver from ProjectA into ProjectB. Many other types of objects in Disguise software can be exported and imported by adapting the steps described.

**Please note:** From r14.4 onward, a device with an identical name as the exported object must be created in ProjectB prior to using the import feature. This will be remedied in a future release.

**Please note:** Any assets such as video files, bitmaps or screen meshes need to be manually transferred to the new project's folder in windows

## Workflow

1. Make objects (tracks, layers, devices etc) in Project A.
2. Right click the header of the object editor you wish to export.
3. Click the **export** option. The file is written to a discrete D3EXPORT file in the **output** folder of the project.
4. In the project folder of Project B. Make a **Packages** folder.
5. Copy the D3EXPORT file from the output folder of Project A to the Packages folder of Project B.

6. Create an object with the **exact** same name in Project B.
7. Right click the header of the object editor of your newly created object.
8. Click the import option and choose the file you wish to import from.
9. Left click any items you do not wish to import that may be part of the object.
10. Click the Import select objects button at the top of the editor.

## Examples

### Transferring a track to a different project

To export a track from ProjectA:

1. Run ProjectA, which contains the track you wish to export
2. Right click the track title bar to open the track editor
3. Right click the title of the track editor
4. Left click **Export**

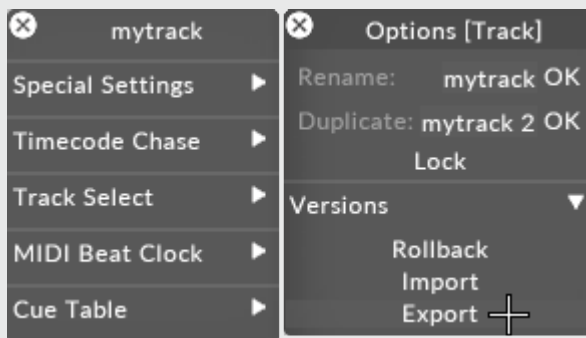

A file will be created in the **output** sub-directory of the project folder. This file contains the contents of the track, its layers as well as any resources the track references (e.g. video files, mappings and audio patches).

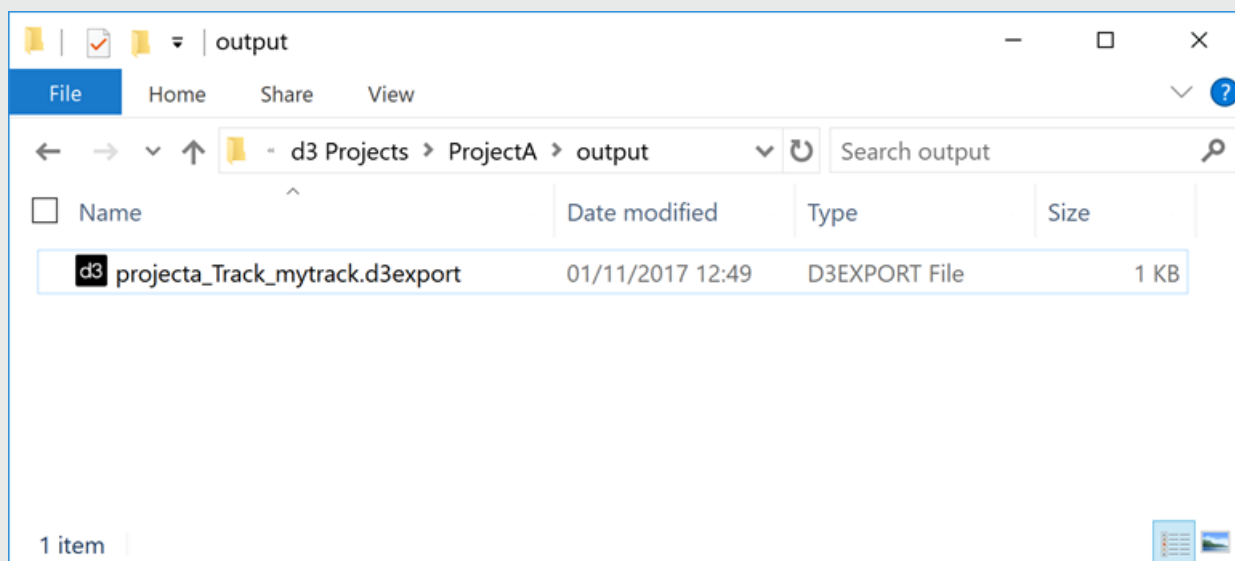

To import a track into ProjectB:

1. In Windows, create a new sub-directory called **packages** inside the project folder

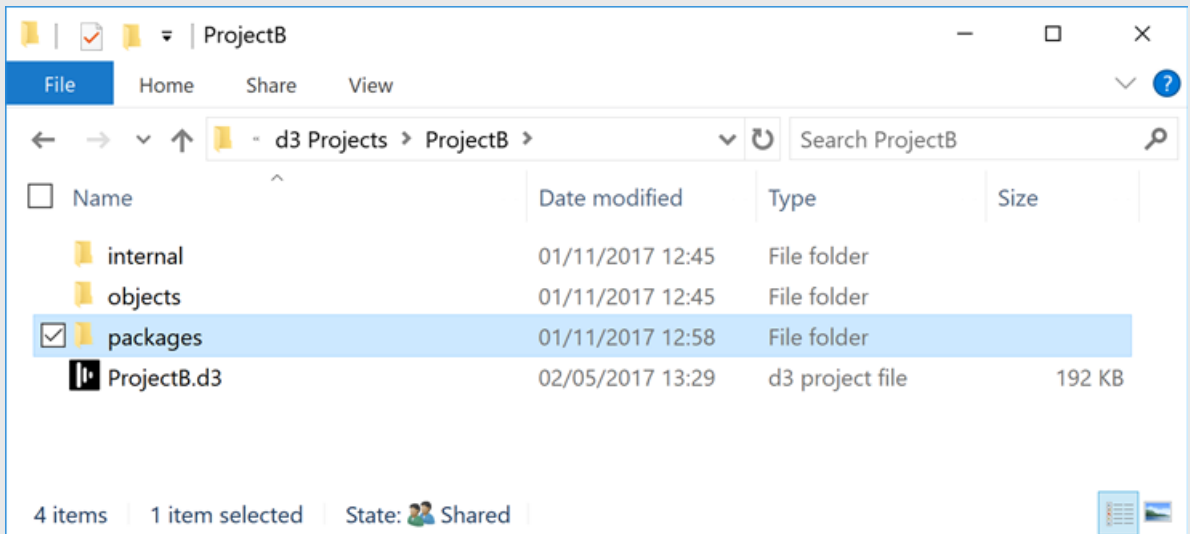

2. Copy the exported file into the new packages folder in ProjectB

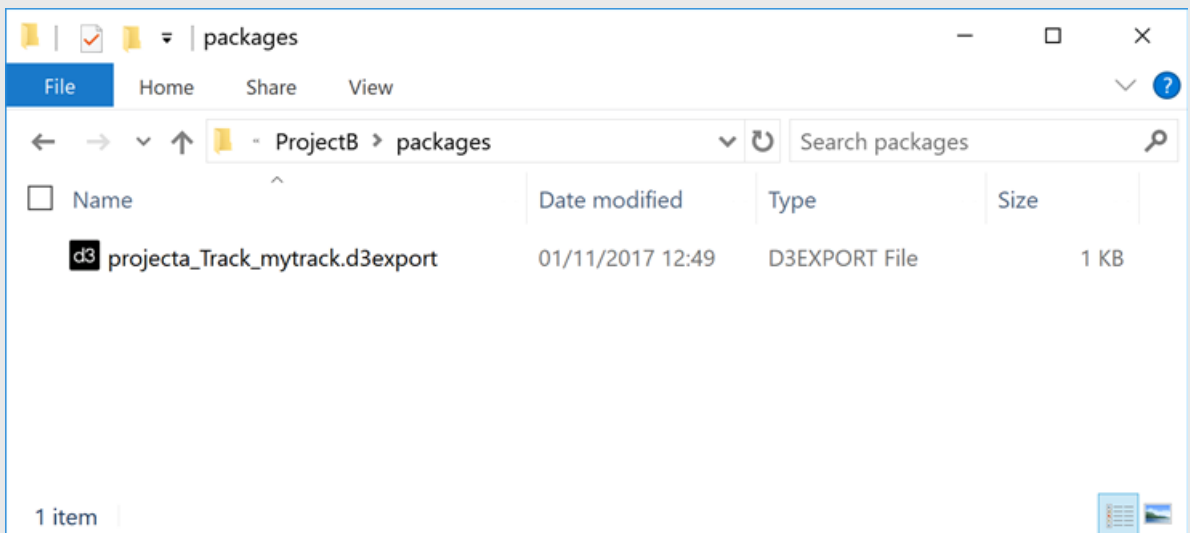

3. Run ProjectB



4. Create a new track called mytrack (must be exactly the same name as the track from which you wish to import).

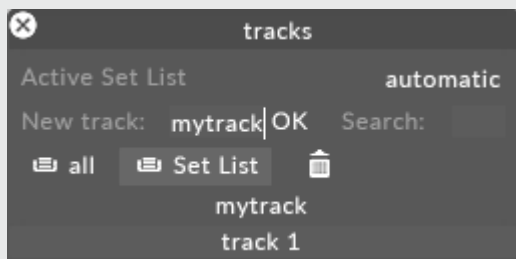

5. Right click the track title bar to open the track editor
6. Right click the title of the track editor
7. Left click **Import**

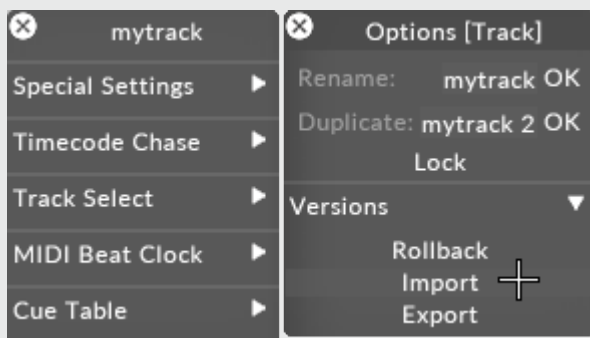

8. Select the file from which you wish to import

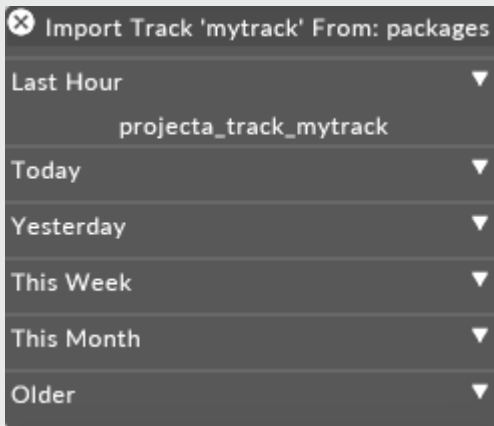

A list is shown, which includes mytrack and also any dependent resources which were exported alongside mytrack. If an object with the same name already exists in ProjectB then you can prevent overwriting it with the version from ProjectA by clicking on it.

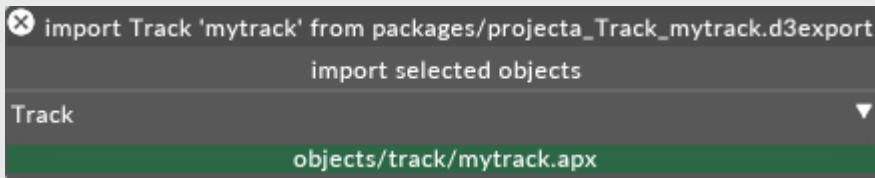

9. Click **import selected objects** to bring the selected objects into ProjectB

## Transferring a surface (or other stage object) to a different project

To export a surface from ProjectA:

1. In ProjectA, right click on the screen
2. Right click on the title of the screen editor

3. Left click **Export**

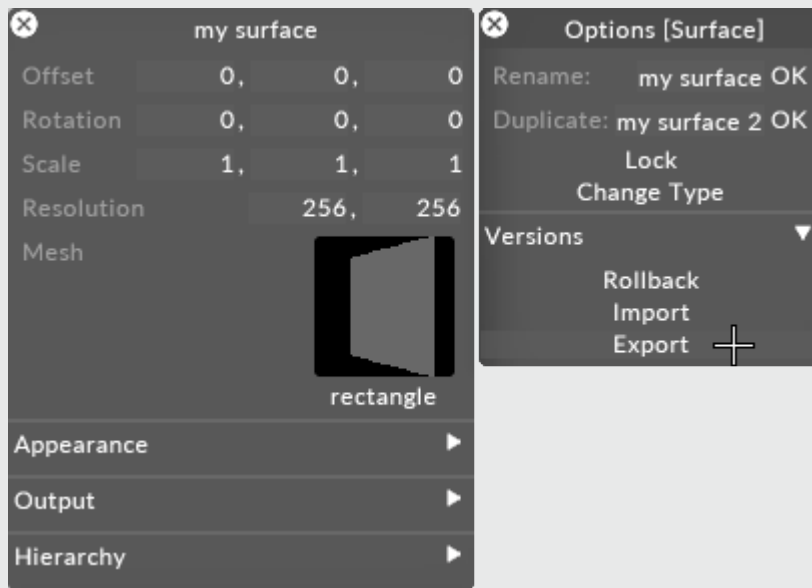

To import a surface into ProjectB:

1. Copy the exported from from **ProjectA/output** to **ProjectB/packages**
2. In ProjectB, create a new surface with the name my surface (must be exactly the same name as the surface from which you wish to import).

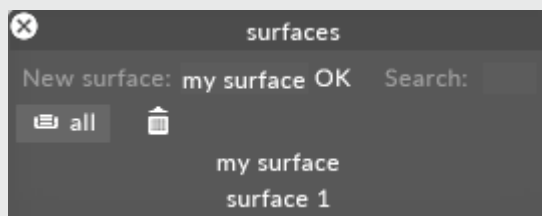

3. Right click on the title of my surface

4. Left click on **Import**

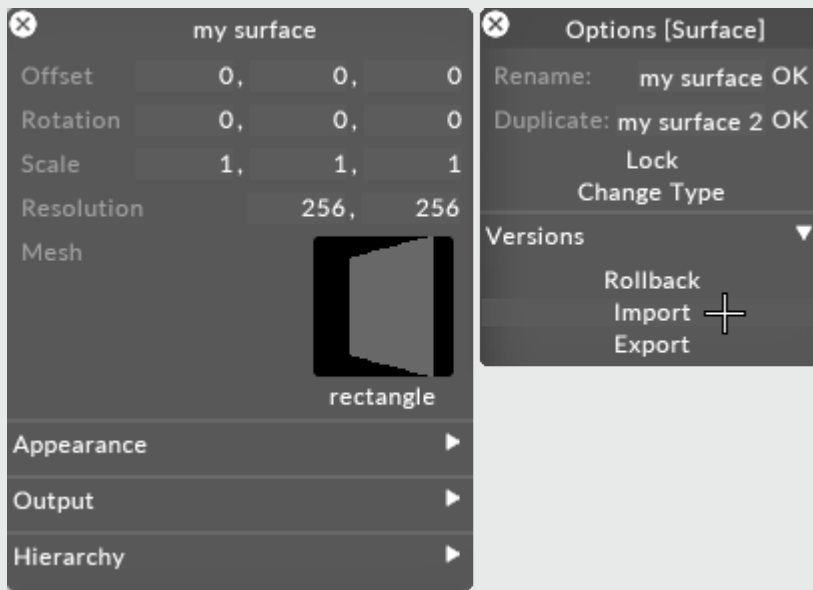

5. Select the file from which you wish to import

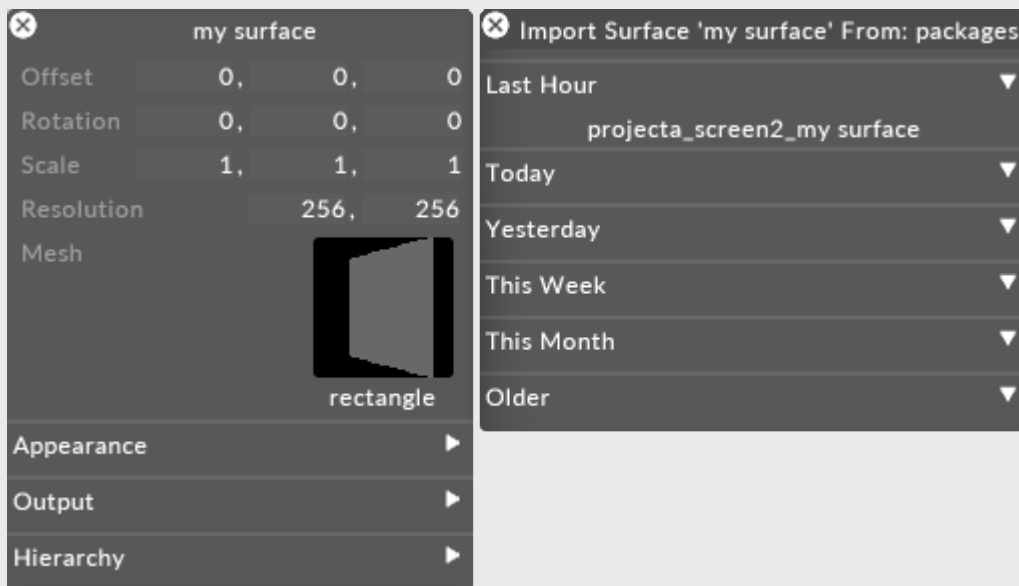

6. Click **import selected objects** to overwrite mysurface's properties which the exported data

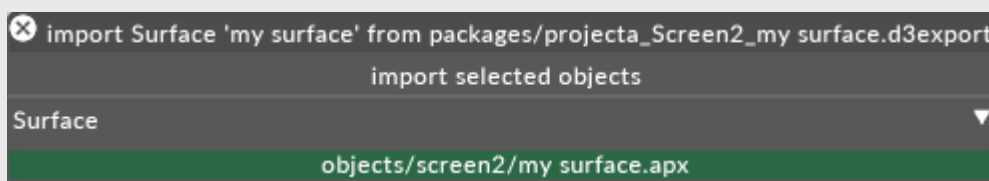

## Transferring a ScreenPositionReceiver (or other device) to another project

To export a ScreenPositionReceiver from ProjectA:

1. In ProjectA, open the device editor
2. Right click on the title of the screen editor
3. Left click **Export**

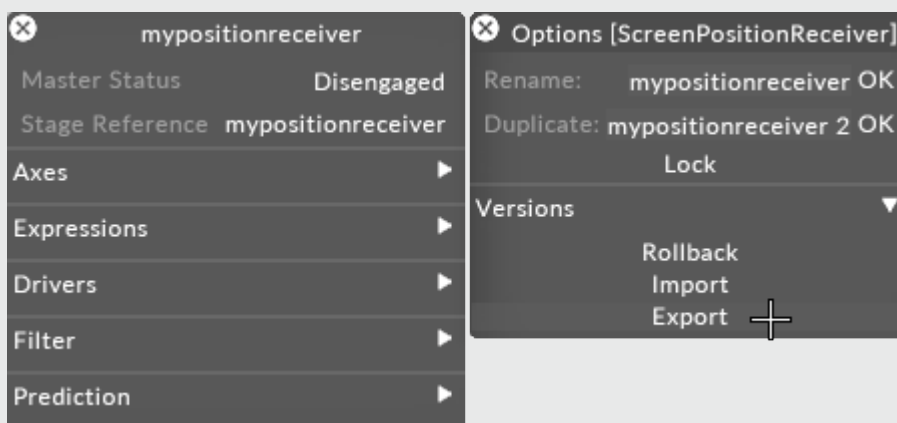

To import a ScreenPositionReceiver into ProjectB:

1. Copy the exported file from from **ProjectA/output** to **ProjectB/packages**
2. In ProjectB, create a new ScreenPositionReceiver with the name mypositionreceiver (must be exactly the same name as the device from which you wish to import).

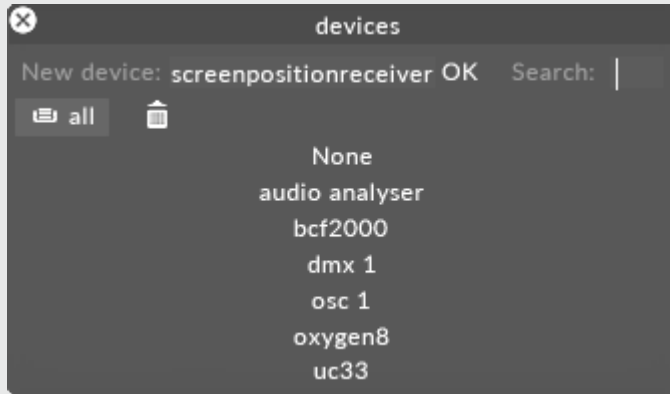

3. Right click on the title of mypositionreceiver

4. Left click on **Import**

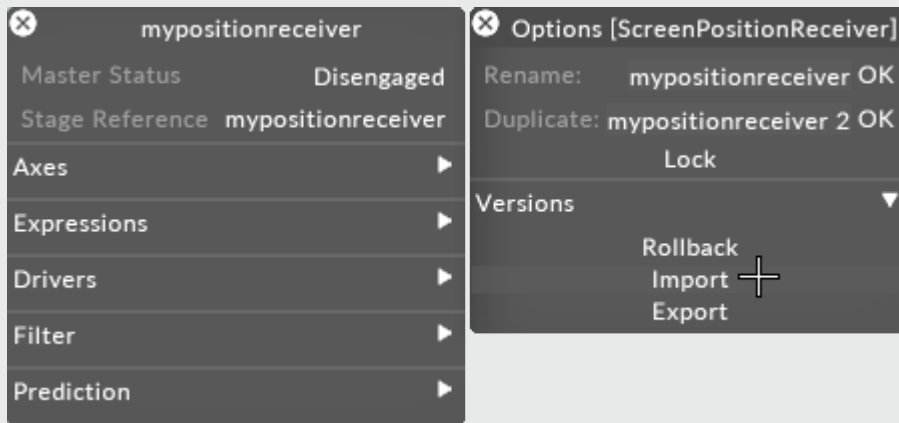

5. Select the file from which you wish to import

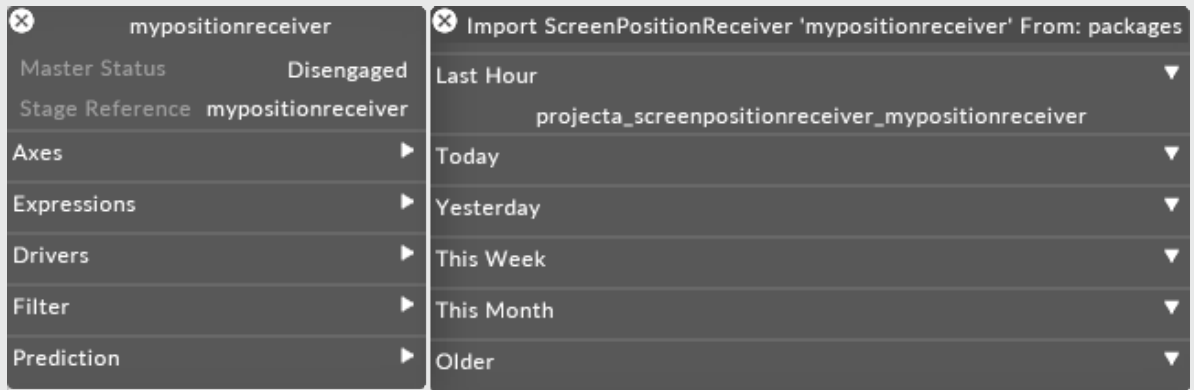

6. Deselect any objects you do not wish to overwrite in ProjectB. Click **import selected objects** to import the selected objects' data

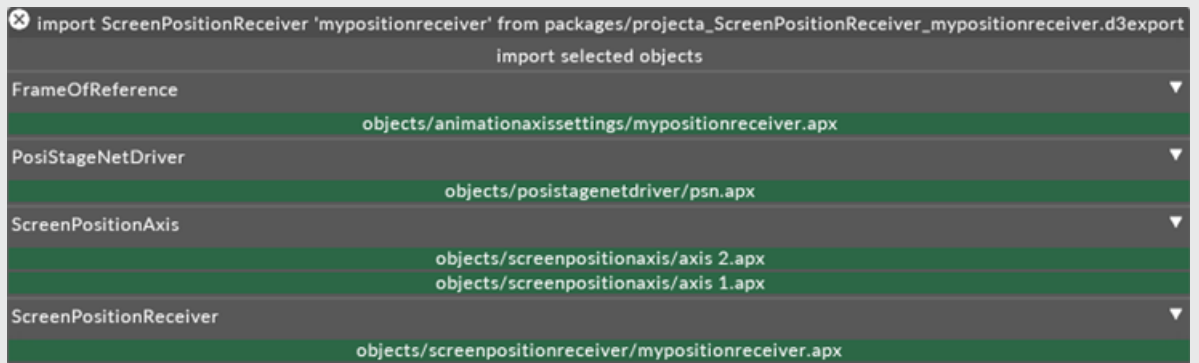

# Content Management Overview

Content management is divided into three broad areas which consist of content version control, proxy management and frame replacement.

## Content Version Control

- The Disguise software understands version tags in video filenames (`_vXXX` where XXX is one or more numerals, optionally followed by a letter)
- You can copy new content versions to actors while the software is running (as long as you're not trying to overwrite a file that's being played)
- When a new version of a file arrives, the software will automatically replace older versions on the timeline wherever they occur
- You can drop any asset back to an older version instantly
- Once new content arrives on a machine, it becomes available instantly, without having to refresh
- If content is unavailable on actors, Disguise will warn you by colouring layers on the timeline (yellow for wrong version, red for no content)

## Proxy Management

- In order to sequence large shows with multiple large video files on a laptop, you can substitute them with low-resolution versions (proxies)
- Proxy files are indicated by adding `'_proxyXYZ'` to the video filename, where XYZ is any number. Higher numbers indicate lower resolutions
- In the visualiser, Disguise uses your camera position (in stage view) or view position and zoom (in feed view) to select which proxy level to display



# Frame Replacement

- A new version of a video file can replace a subset of frames of the overall video file
- Add the tag '\_frameXYZ' after the Version Control tag (XYZ should be a frame number), and Disguise will interpret the video file as a 'patch' to the file
- This saves time when you want to replace single corrupted or erroneous frames in a clip, or short runs



**Warning:** The Frame Replacement feature requires a Version Control tag greater than the file that's being replaced.

For example, to replace content from frame 130 of a file called "Video\_v1.mov" one would need to name their replacement file as follows: "Video\_v2\_frame130.mov".

# Media Ingestion History Tool

- Disguise analyses new content and displays them in the [Media Ingestion History Tool](#)
- This is used to find and fix naming or spelling errors in filenames when they occur

# Content versioning

Content versioning is a powerful feature of Disguise software that allows you to easily version and subsequently replace media files based on their file name. This is useful for shows where content development continues throughout rehearsals and Disguise programmers need a quick way of changing between different versions of an asset.

For more information on where to put media files, including video content see the [placing media files](#) topic.

New files may either contain :

- no version tag (myfile.mov),
- a numeric version tag (myfile\_v2.mov),
- a date version tag (myfile\_v20210602a.mov)

Date version tags should be formatted YYYYMMDDL, where L is a, b, c... and so on.

Date version tags can also be extended to YYYYMMDDHHMM where HH is hour and MM is minute.

Version tags are sorted alphabetically, i.e. \_v20210602b is considered a more recent version than \_v20210602a.

The Disguise software will remove the version tag to create a stem filename, and create a new video clip with the stem name.

There may be more than one occurrence of the version tag in the overall pathname, i.e. it is permissible to create a folder for each version date, if you wish. However please note that this introduces the risk of errors, i.e. if you make a mistake and add a different version tag to the filename, the result will be indeterminate.

To add a new version of a file, simply copy it into the VideoFile folder alongside the older versions. The Disguise software will automatically match the stem filename with the existing clip and load the new version, which will play immediately.

The Disguise software will automatically replace older versions of the file wherever it occurs in the timeline.

# Examples

File Path	Read File Name	Version	Notes
myfile.mov	myfile.mov		No version supplied
myfile_v1.mov	myfile.mov	1	You can prefix the version with either '_v'
myfile.v1.mov	myfile.mov	1	... or '.v'
myfile_1.mov	myfile_1.mov		But without those the version will just be part of the stem
/v1/myfile.mov	myfile.mov	1	Alternatively, you can put the version in a folder (without the '_' or '.')
/v1/myfile_v1.mov	myfile.mov	1	You can even include it multiple times if you wish
/v1/myfile_v2.mov		ERROR	...but if the versions don't match, it will cause an error
/1/myfile.mov	/1/myfile.mov		If you're putting the version into a folder name, but if it doesn't start with 'v' then it will just be part of the stem
myfile_v1b.mov	myfile.mov	1b	Version tags can include letters too

## Viewing an assets version

1. open the videoclip editor (right-click a videoclip in a video layer)
2. select the versions tab and right click on the asset to view a simple graphical view of the file contents

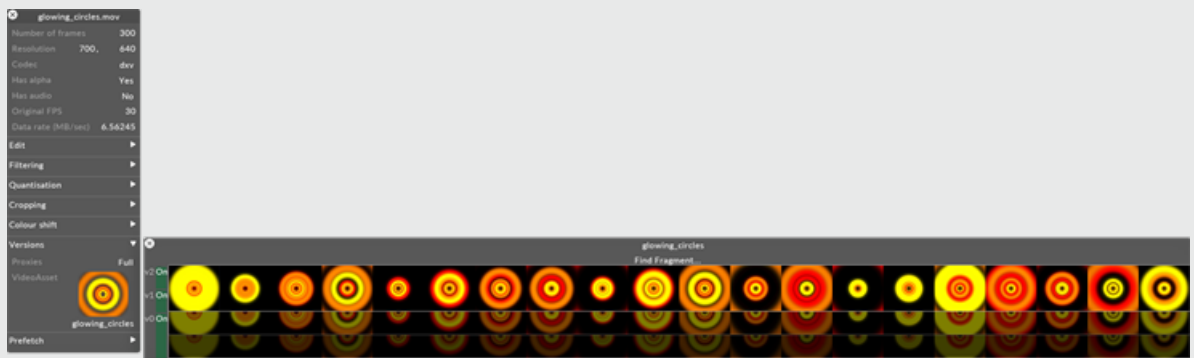

VideoClip and VideoAsset editors for glowing\_circles.mov', after adding 'glowing\_circles\_v2.mov

**Please note:** You can drop back to previous versions of the file by opening the VideoAsset editor and clicking the 'on' label next to each version, and setting it to 'off'.

# Project structure

Each specific Project folder contains the **.d3** project file. For example, if you have a project called **my project**, the Project file will have the name:

**my project.d3**

and a number of sub-folders:

- **History** which contains auto save files and shows after a project has been running long enough for auto save to occur.
- **internal** which contains files internal to the software, such as thumbnails.
- **objects** which contains all media files.
- **Packages** which is used to package data and move it between projects, this is a user created folder and is not present by default.

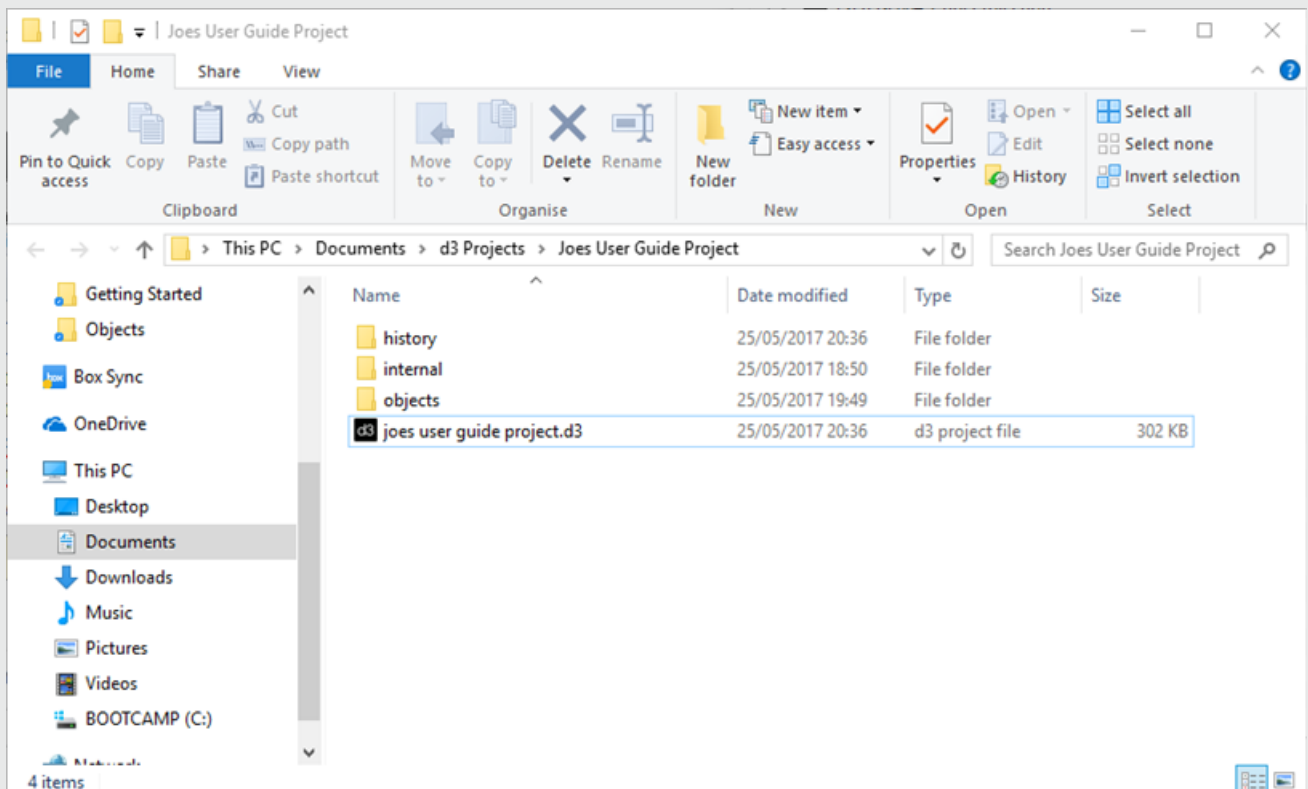

Each specific Project folder contains by default the Project file and two sub-folders called Internal and Objects.

**Please note:** all media files for a project must be stored in the specific Project folder. This ensures that when you copy the specific Project folder from one device to another, all relevant files will be copied as well.

# Project location

## Where are all of my projects stored?

All of the specific project folders are stored in the assigned **d3 Projects** folder which is set during the installation of d3. The default location is **My Documents/d3 Projects**

Alternatively, you assign a project folder in a different location on the server from within the d3Manager window. For more information on how to assign a new project folder location, please visit [this link](#).

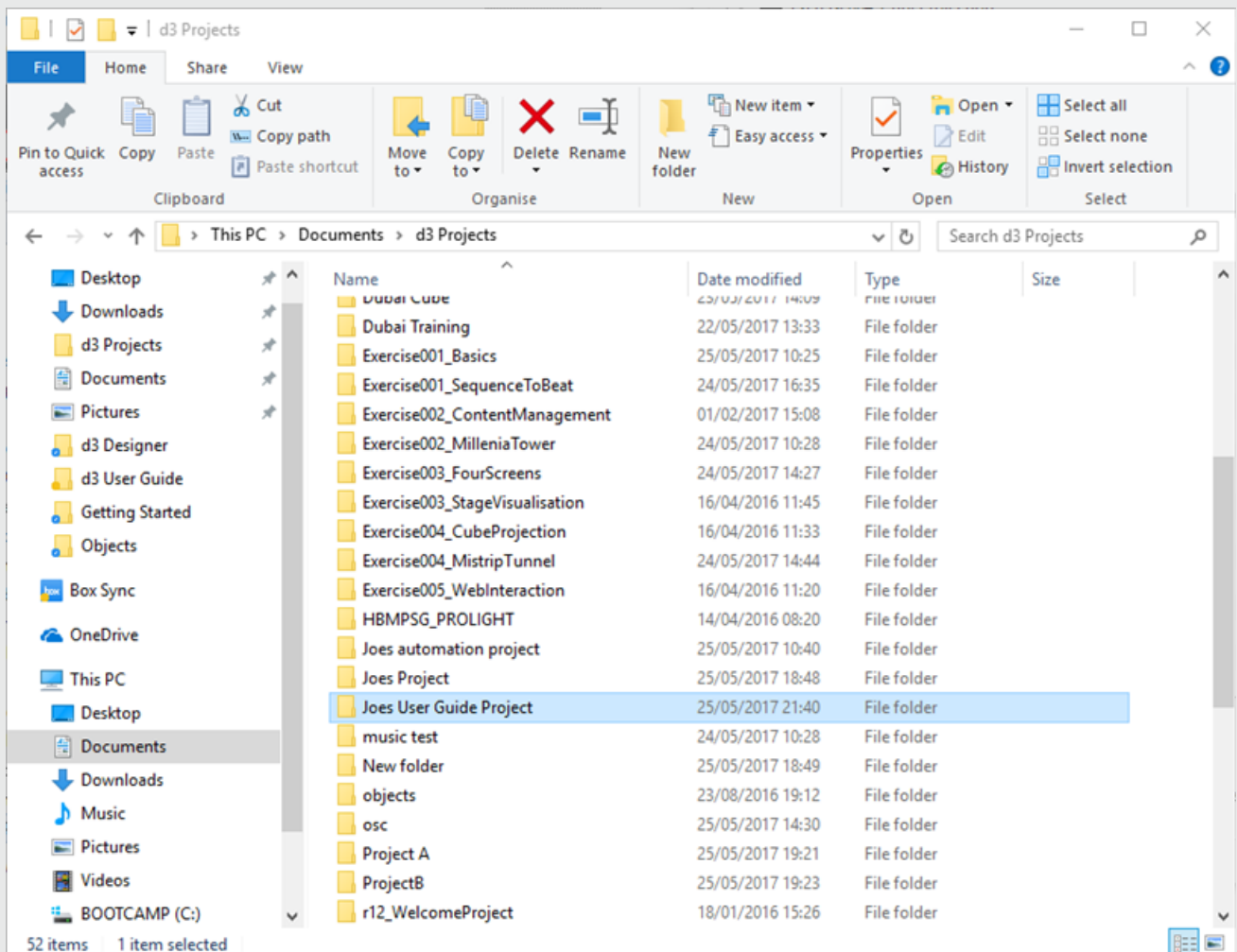

# Placing media files

## Where do I place the media files for my project?

The media files for a project are stored inside the **objects** folder. The **objects** folder is located inside the specific Project folder.

For information on where your specific Project folder is located please see the above sub-chapter [Projects location/structure](#). To read about the exact specification of the media formats read the [Supported file formats](#) page.

Within the **objects** folder are the following sub-folders:

- **AudioFile** which contains all audio files (.mp3 .wav, .aiff). Notice that this audio is just for audio which is to be quantized on the timeline.
- **DxTexture** which contains all texture files (.png .jpeg .bmp .tif) including pixel masks and palette files.
- **LutFile** which contains LUT files used in the project. Visit this link for information on [LUT files](#).
- **Mesh** which contains all 3D object meshes (.obj)
- **Notchfile** which contains notch blocks exported from Notch.
- **RecordingFile** which contains device recording files generated by Disguise's Devices Recording feature.
- **sdpfile** Session Description Protocol; these are network files that are used to send and request information from a network stream
- **textfont** stores all fonts used by the [Text Layer](#).
- **VideoFile** which contains all video files (.mov)
  - » Still images can be placed in the **Objects/VideoFile** folder and they'll work just like video files.



A benefit of this is when you have to work with proxy content while waiting for the real content to arrive; when you ingest the real content into the system, the content manager will make sure it supersedes the proxy.

— **Web** which stores custom html files used by the Web layer.

## Using Stills as Textures on props

Still images intended to be used as textures should be placed in the **Objects/DxTexture** folder.

The maximum texture size supported is 16k x 16k.

**Please note:** Still image files can be stored in either the DxTexture or VideoFile folder. Files stored in the DxTexture folder are available for use only in the Bitmap Layer. Files stored in the VideoFile folder are available for use only in the Video Layers.

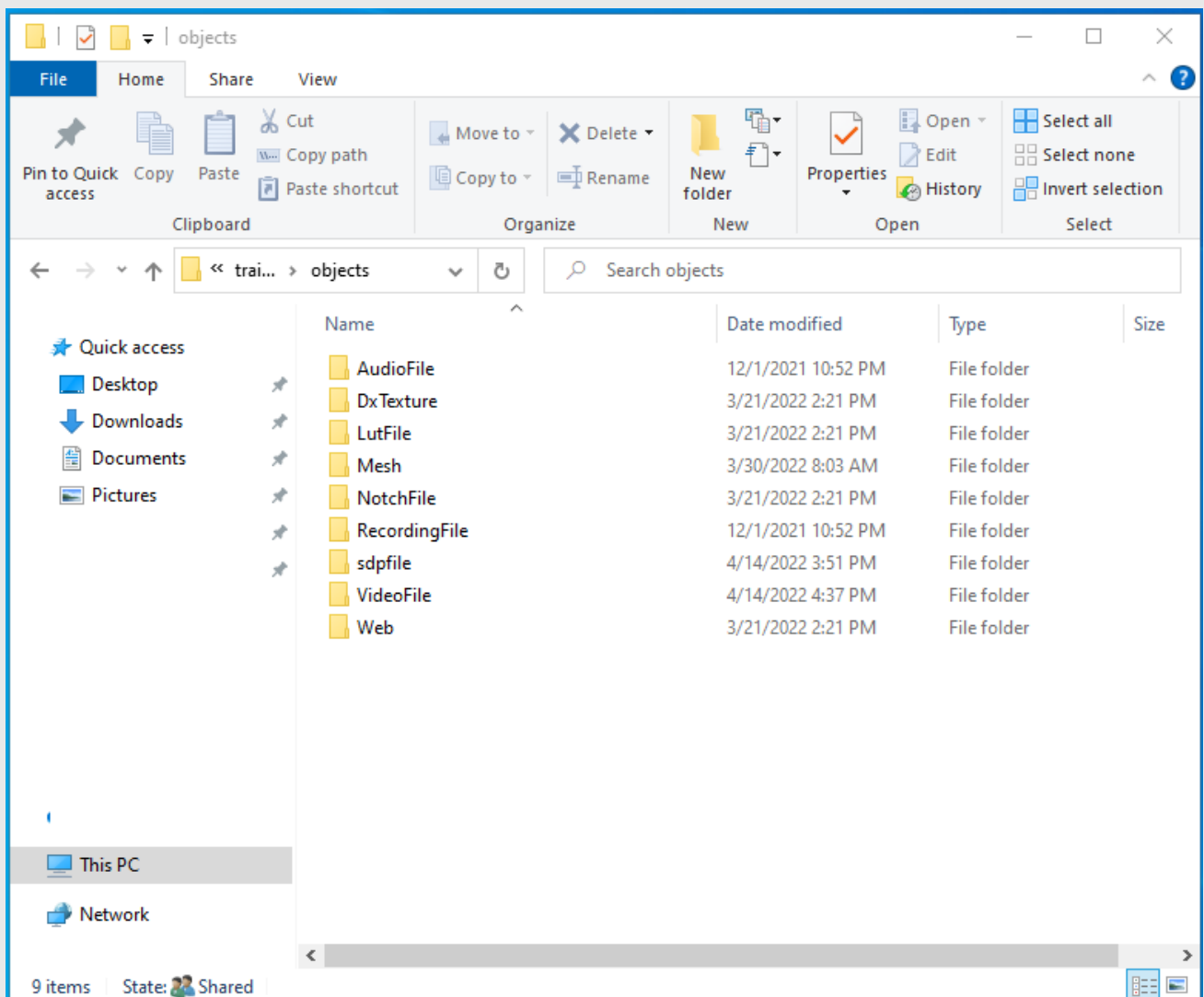

Object folder contains by default sub-folders which are used to store the media files for a specific project.

By default a new project contains a series of media files. For example, the **mesh** folder contains mesh files. For more information on the mesh folder please see the sub-chapter [Venues/props overview](#) .

## How to place media files and access them in your Disguise project

1. Ensure the media file is saved to a supported file format.
2. Open the **objects** folder.
3. Place the media file inside the appropriate sub-folder depending on the media file type. Once the media file has been added to the folder it will be added to the corresponding object library in the software. In this example a custom mesh file called **palace\_screen** has been placed inside the **mesh** folder.

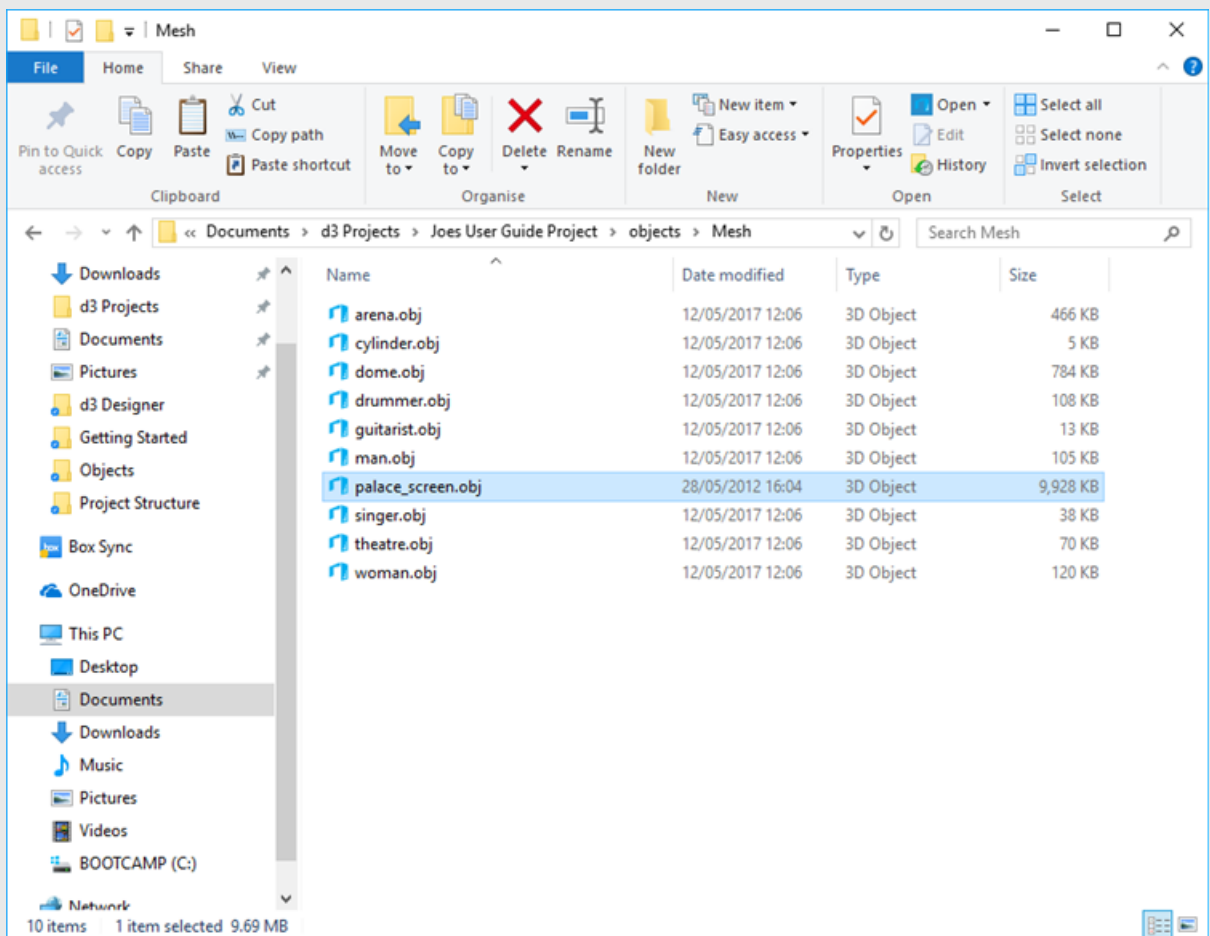

4. Run the software.

5. Select the media file from the appropriate object library.



Palace screen mesh file can now be accessed in the software from the Mesh object library of the specific project.

**Please note:** all media files for a project must be stored in the specific Project folder. This ensures that when you copy the specific Project folder from one device to another, all relevant files will be copied as well.

# Media Ingestion History









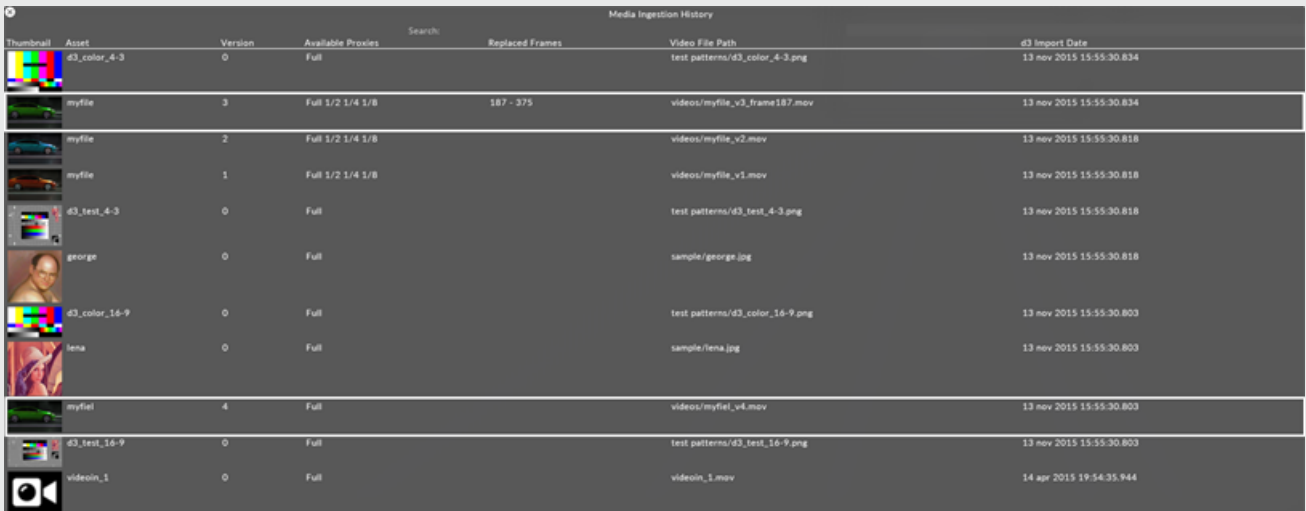

There are two ways to access the Media Ingestion History:

- Right-click the d3 state menu in the dashboard and select Media Ingestion History
- In the VideoAsset editor (by pressing the 'find fragment -' button).

In the latter case, the media import history editor is brought up with the search field pre-populated with the name of the asset.

The Media Ingestion History can highlight any spelling or version number mistakes with the file naming which may affect the Content Version Control.



Thumbnail	Asset	Version	Available Proxies	Search	Replaced Frames	Video File Path	d3 Import Date
	d3_color_4-3	0	Full			test patterns/d3_color_4-3.png	13 nov 2015 15:55:30.834
	myfile	3	Full 1/2 1/4 1/8		187 - 375	videos/myfile_v3_frame187.mov	13 nov 2015 15:55:30.834
	myfile	2	Full 1/2 1/4 1/8			videos/myfile_v2.mov	13 nov 2015 15:55:30.818
	myfile	1	Full 1/2 1/4 1/8			videos/myfile_v1.mov	13 nov 2015 15:55:30.818
	d3_test_4-3	0	Full			test patterns/d3_test_4-3.png	13 nov 2015 15:55:30.818
	george	0	Full			sample/george.jpg	13 nov 2015 15:55:30.818
	d3_color_16-9	0	Full			test patterns/d3_color_16-9.png	13 nov 2015 15:55:30.803
	lena	0	Full			sample/lena.jpg	13 nov 2015 15:55:30.803
	myfiel	4	Full			videos/myfiel_v4.mov	13 nov 2015 15:55:30.803
	d3_test_16-9	0	Full			test patterns/d3_test_16-9.png	13 nov 2015 15:55:30.803
	videoin_1	0	Full			videoin_1.mov	14 apr 2015 19:54:35.944

Media Import History showing misspelled file stem name myfiel instead of myfile

There is a search feature for finding files. The search is fuzzy, so it will find all misspellings as well as correct files.

Errors can be fixed directly in the Media Ingestion History by doing the following:

- Right-click incorrect asset name.
- Select the option 'move to asset' and click the correct asset.

Thumbnail	Asset	Version	Available Proxies	Search:	Replaced Frames	Video File Path	d3 Import Date
	d3_color_4-3	0	Full			test patterns/d3_color_4-3.png	13 nov 2015 15:55:30.834
	myfile	3	Full 1/2 1/4 1/8		187 - 375	videos/myfile_v3_frame187.mov	13 nov 2015 15:55:30.834
	myfile	2	Full 1/2 1/4 1/8			videos/myfile_v2.mov	13 nov 2015 15:55:30.818
	myfile	1	Full 1/2 1/4 1/8			videos/myfile_v1.mov	13 nov 2015 15:55:30.818
	d3_test_4-3	0	Full			test patterns/d3_test_4-3.png	13 nov 2015 15:55:30.818
	george	0	Full			sample/george.jpg	13 nov 2015 15:55:30.818
	d3_color_16-9	0	Full			test patterns/d3_color_16-9.png	13 nov 2015 15:55:30.803
	lena	0	Full			sample/lena.jpg	13 nov 2015 15:55:30.803
	myfile1	4	Full			videos/myfile1_v4.mov	13 nov 2015 15:55:30.803
	d3_test_16-9	0	Full			test patterns/d3_test_16-9.png	13 nov 2015 15:55:30.803
	videoin_1	0	Full			videoin_1.mov	14 apr 2015 19:54:35.944

*Correcting an erroneous import caused by the spelling mistake*

**Please note:** You can clear the media ingestion history from a project prior to running the project; right click on the project file in the d3Manager and select "Clear Ingestion History". This will cause disguise to rescan all media when the project is launched

# Removing media files

## How do I remove media files from my project?

Media can be removed from a project at the Windows level directly from the VideoFiles folder within your Project folder .

**Please note:** While media files can be added to a project while it's running, media files can not be removed while the project is running.

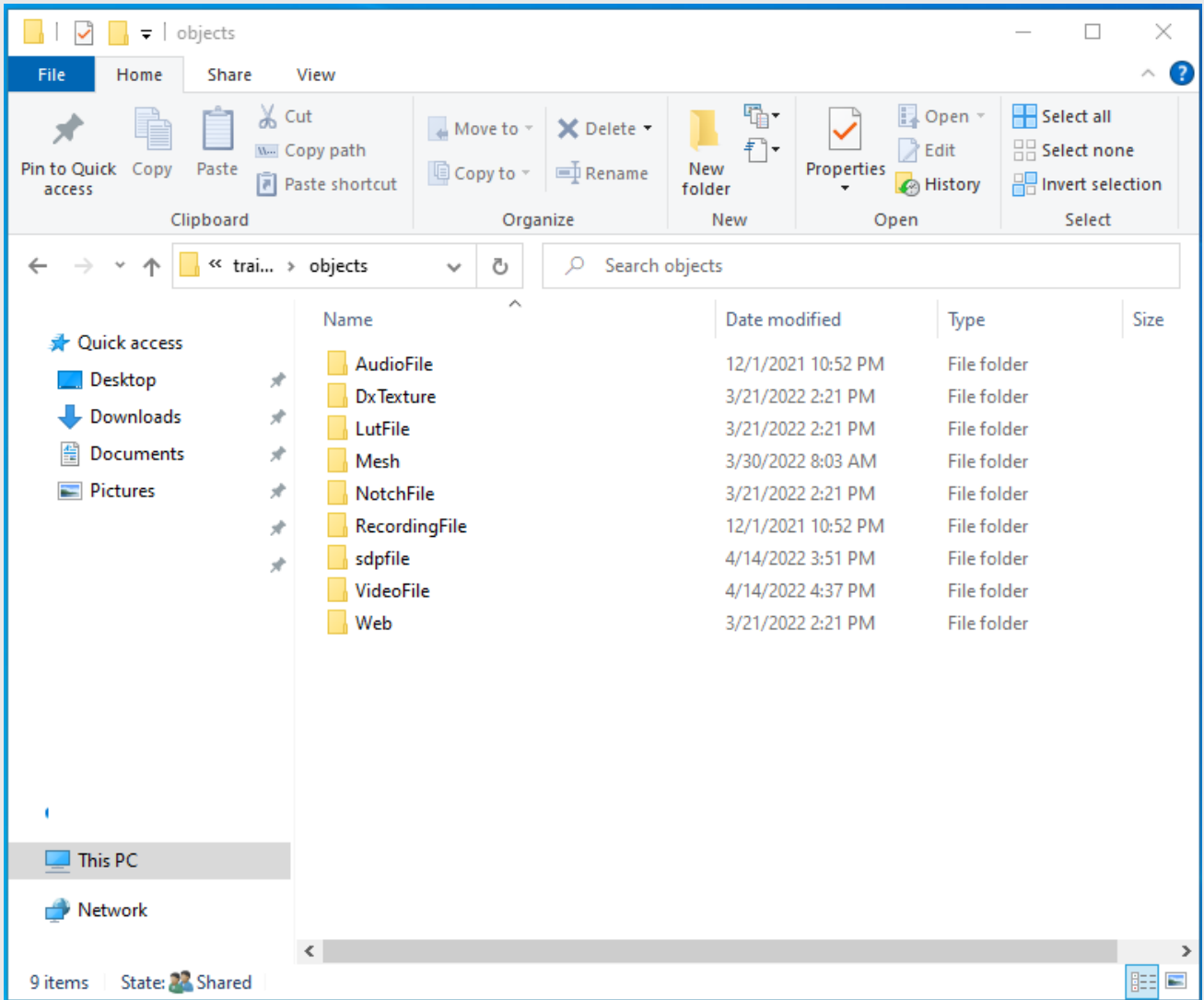

Once media has been removed from a project using this method, any layer within the project that is referencing the content that was removed will now appear red in the timeline:

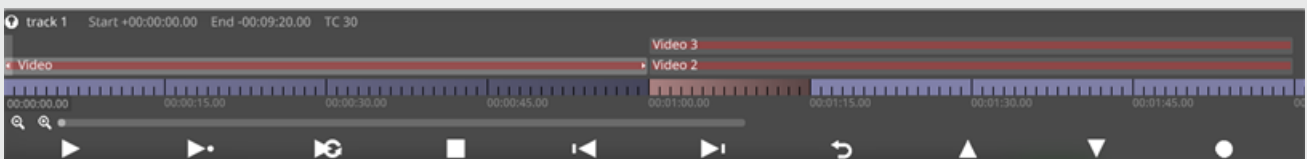

To remove missing media from a project, follow these steps:

1. Open a layer that is referencing missing media



Video [Inactive]

Frame -1

Default

- Blend mode Premult-Alpha
- Opacity 1.0
- Mapping led1 (direct)
- Palette  hsvpalette
- Colour X 0
- Colour Y 0

Media

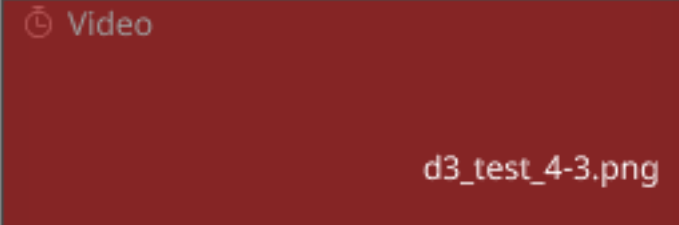
- Video  d3\_test\_4-3.png
- Speed 1
- Mode Normal
- At end point Loop
- Transition time 0

Audio ▶

Colour Shift ▶

Keying ▶

Move ▶

Crop ▶

- Left-click on the Video thumbnail in the Media tab of the layer to open the VideoClip library

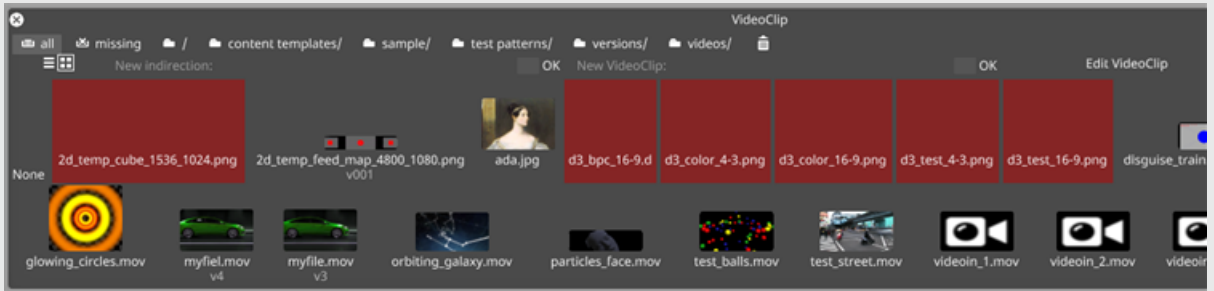

- Right-click on the 'missing' box at the top of the videoclips library window

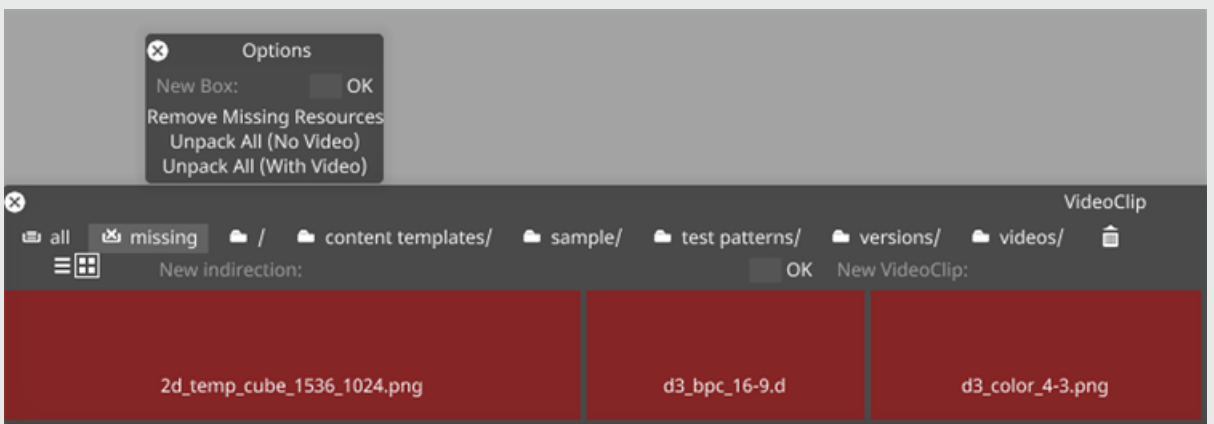

- Left-click on **Remove Missing Resources**.

All missing media that is not referenced in any layer within the project will be removed from the VideoClips library.

- If missing media is not removed from the VideoClips library at this point, this means that the clip is being referenced elsewhere in the project. Right click on the red box for that media, and then left click on **Find Usage** to locate the instances where the media is still being referenced in the project.

The screenshot shows a video player interface with a context menu open for a resource named 'd3\_test\_4-3.png'. The menu items include: Number of frames (1), Resolution (1024, 768), Codec (still\_image:PNG), Bits per channel (8 Bits), Has alpha (Yes), Has audio (No), Original FPS (1), Duration (00:00:01.00), Data rate (MB/sec) (0), Find Usage, Edit, Filtering, Quantisation, Cropping, Colour shift, Versions, and Prefetch.

A 'Resource Usage' dialog box is also visible, containing the following text:

Resource Usage  
Found 2 usages for Resource 'objects/videoclip/test patterns/d3\_test\_4-3.png.apx':  
track 1, Video @ 00:00:00.00  
track 1, Video 3 @ 00:01:00.00  
Usage details saved to:  
'output\objects\_videoclip\_test patterns\_d3\_test\_4-3.png.txt'

# Manage old media

Manage old media is a tool within Disguise software that allows the user to generate a list of unused versioned media within the project and archive it. As this tool only works specifically with versioned content files, it is generally used to cleanup the project and remove 'old' versions of content that are no longer used.

Versioned content uses tags such as "File\_v1" or "File\_20170602a". For more information, please refer to the [content versioning](#) topic.

## Accessing Manage old media

1. Right-click the d3 state menu in the dashboard.
2. Left-click Manage Old Media.

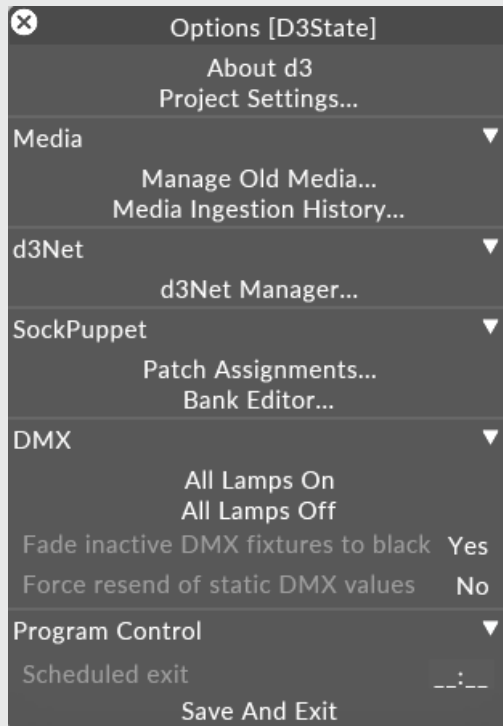

*Manage old media option.*

## Using Manage old media

1. Left-click the **Unlock** button in the Manage Old Media editor.

The button will generate two lists, **in use media** and **unused media**, in the output folder of the project file. These are for manual reference and deletion.

2. Left-click the archive button and an automated process will move unused media to the "Archiver" folder in your project's output folder. This can be deleted or transferred to a new location or external storage location.

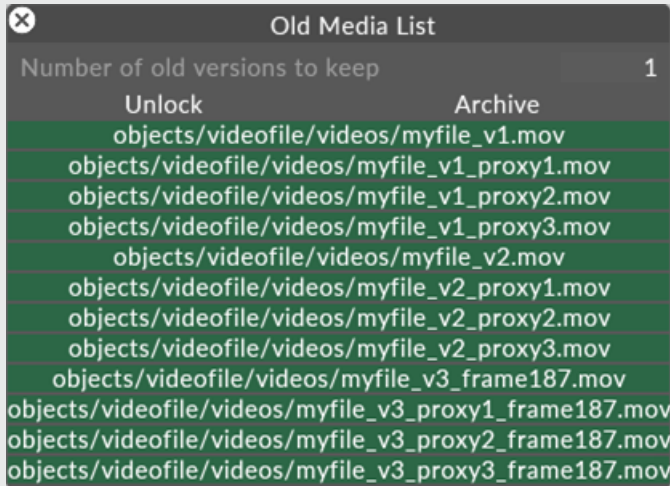

*Manage old media editor, with all files selected.*

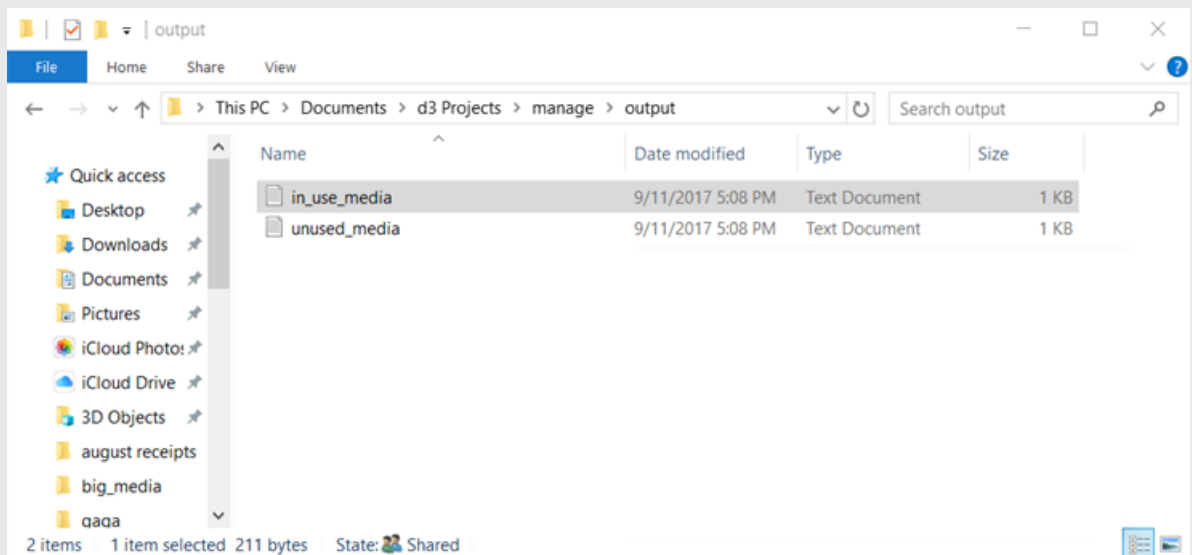

*Text files written to the output folder, following an archive process.*

**Please note:** You can specify a number of old versions to keep in the Manage Old Media editor.

# Archive unused objects

**Archive unused objects** is a tool to remove extraneous, unused files from a project. Similar to [Manage old media](#), this feature refers to objects such as video files, meshes, textures and audio files. This can be useful in the case of low available storage on a machine, or simply making a project more organized.

## Accessing Archive unused objects

1. Right click the d3 state menu in the dashboard.
2. Left click **Project settings**.

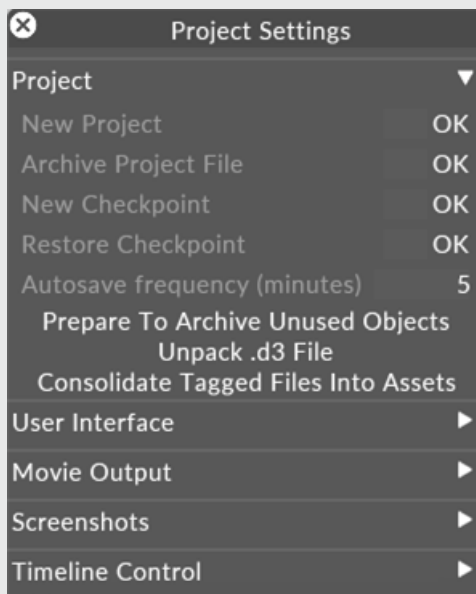

## Using Archive unused objects

Left click **Prepare to Archive unused objects**.

Clicking the Prepare to Archive unused objects will present a pop-up estimating how much free space will be gained.

If you proceed, Disguise software will generate a new folder within the output folder of your project called "Archiver"; this folder contains two text files and two scripts.

The text files ("Used" and "Unused") will create a list of the used and unused files found in the project.

The scripts will automate the process of either moving the unused media to the archiver folder or copying to a folder you're prompted to specify.

**Please note:** This process is different than Archive project file which is a way of saving your file without copying & pasting then renaming the d3 project file.



# Media Distribution

The new Media Distribution feature provides a built-in mechanism to easily ensure that the exact required media files are present on each d3 machine involved in a d3 session. There are two parts to the Distribute system:

1. Sync/copy missing media - copying media used by the d3 project and needed by a machine's feed mapping.
2. Delete unused media - removing media that is not used by the d3 project.

## To use the Media Distribution feature

1. On the Director machine, right-click on the d3 menu and select "Media Distribution..." to open the Media Distribution Widget.
2. Expand both collapsible widgets to see the details of what media files are missing and unused copies.
3. "Include Mobile Editors" is defaulted OFF as they may wish to manage their own files, but the option is available.
4. Either click on "Sync" or "Delete" next to each item to sync or delete individual files on the target machines, or alternatively click "Sync All" or "Delete All" to action all the items in the respective tables.
  - a. For copying large files, it will display the copy progress as a percentage.
  - b. At the end of a copy, it will display the task state as either "Success" or "Failed". For

5. Click on “Clear Finished Tasks” above the sync table to remove syncs that completed successfully and reset the status on syncs that failed.

# Adaptive Proxies

The Disguise software recognises proxy videofiles with a ‘\_proxy’ tag.

**myfile\_proxy1.mov** is ‘proxy 1 (half-resolution) of an asset called myfile.mov’

**myfile\_proxy2.mov** is ‘proxy 2 (quarter-resolution) of an asset called myfile.mov’

**myfile\_proxy3.mov** is ‘proxy 3 (1/8-resolution) of an asset called myfile.mov’

You are free to create any number and mix of proxies for video assets that you wish.

The proxy tag number is optional. Proxies with numbers do not have any stipulations, however we recommend that proxy1 is half resolution, proxy2 is quarter resolution, proxy3 is one-eighth resolution, and so on.

## Example

You have four 4K screens in your project, which you wish to sequence on an HD laptop. Your usual view would be zoomed out so that all four screens fit into your viewport. In this case, Disguise would recognise that each screen is under 500 pixels across in the visualiser, and would therefore step the content down to proxy3 (1/8th resolution).

(Note that you won’t be able to see the difference)

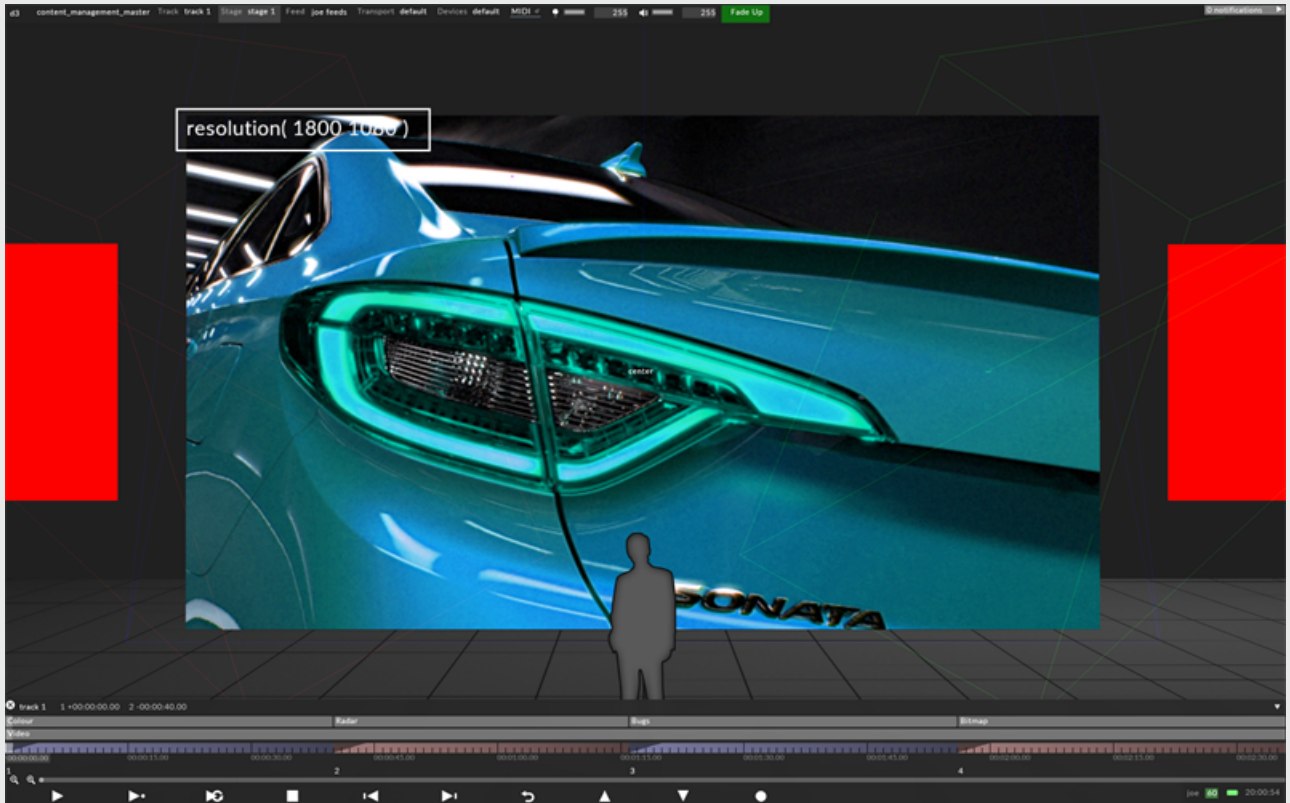

If you zoom in so that only a single screen is in the visualiser, Disguise would increase the resolution being played on that screen, but stop playing content for all off screen surfaces :



Zoomed in view selects higher-resolution proxies, stops rendering other screen.

Proxies will never be played onto any surface that goes out to the stage. If a machine is an Actor or a non-dedicated Director, if a screen or projector appears in any of its feed rectangles, then that machine will only play full-resolution content on that surface.

In time-pressured situations, it may be useful to update to a new proxy version on the editor or Director, so that sequencing can progress while waiting for the full-resolution version to render and copy. The timeline will always warn you when the copy being rendered to stage is different than the one in the visualiser.

**Please note:** proxies are only used on Dedicated Directors or Editors

# Frame Replacement

In Disguise, if you want to replace a range of frames in a piece of content, you can render only those frames that have changed, and tag them with a frame index.

The file that you are replacing frames with needs to have its own version number, so if the original video is "myfile\_v2", then the n in the format:

'myfile\_v3\_frameXXX.mov' where XXX is the first frame number to be replaced. Note that frame 0 is the first possible frame in the clip, not 1.

## For example:

the file 'myfile\_v3\_frame187.mov' replaces frame 187 onwards in 'myfile\_v2.mov'

**Please note:** If you want to replace a set of frames in clip version V, the new clip should have a higher version number (V+1), not the same number.

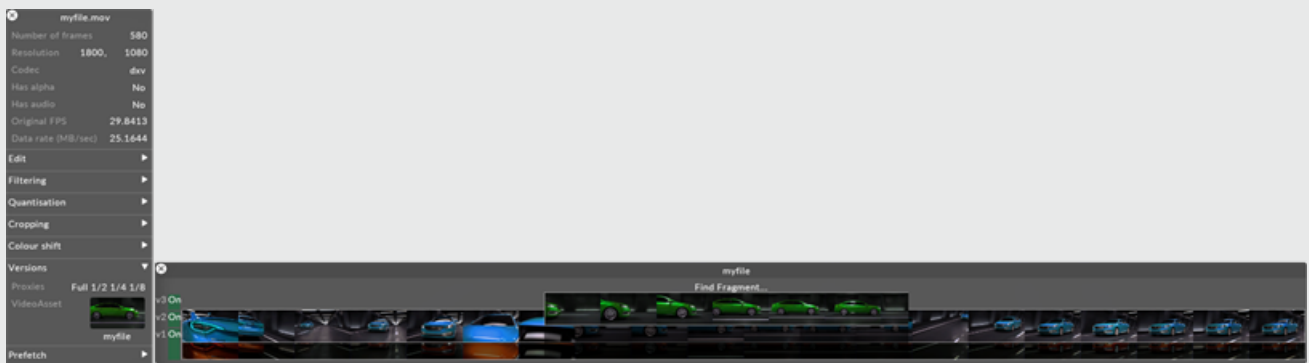

VideoAsset editor for 'myfile.mov' after adding myfile\_v3\_frame187.mov

# Duplicating video clip instances

Video clips can be duplicated just the same as other objects within Disguise software. This proves useful for managing a single piece of content that has multiple sets of properties.

## Distinction between VideoFile and VideoClip

**VideoFile** is the piece of content you place in the VideoFile folder which lives inside your Objects folder in your project file.

**VideoClip** is an object inside Disguise software that contains the VideoFile (or VideoFiles when versioning is being used) as well as properties that you can apply to that file, outside of the normally keyframable parameters. These properties are things such as FPS, In & Out frames and are covered in more detail in the [content properties](#) topic.

## Duplicating a VideoClip

Duplicating video clip assets is extremely useful if you want a piece of content that has different properties, such as in and out frame but is the same VideoFile.

You could simply copy the content in the VideoFile folder, but this creates a hard copy of the file which therefore increases storage space and means that Disguise software has to deal with a whole separate VideoFile, which reduces efficiency.

By duplicating the VideoClip asset, you can have one single piece of media which has different properties applied to it while still being a separate piece of media to choose from the VideoClip editor.

## Example

- Open the Video layer.
- Expand the media tab.
- Open the video object keyframe.

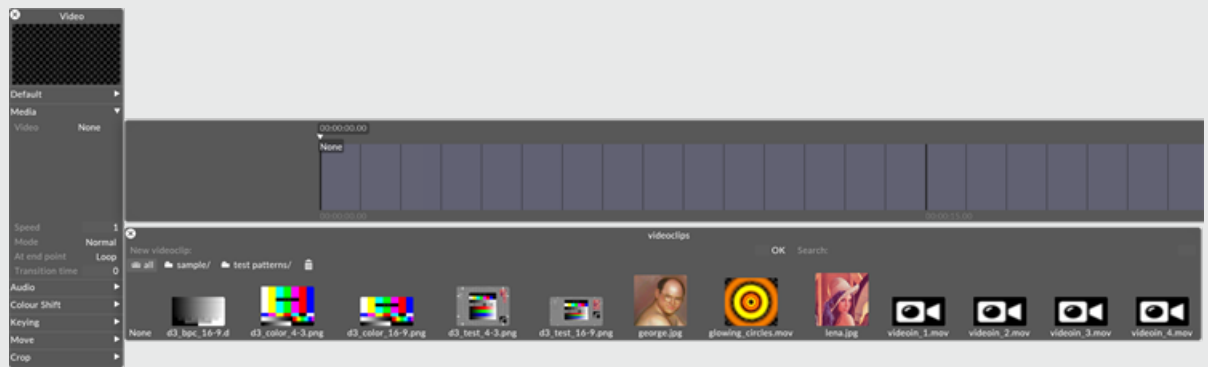

- Right click on an VideoClip from the picker to open it's properties.
- Right click the header of the properties editor.
- Choose **duplicate** .



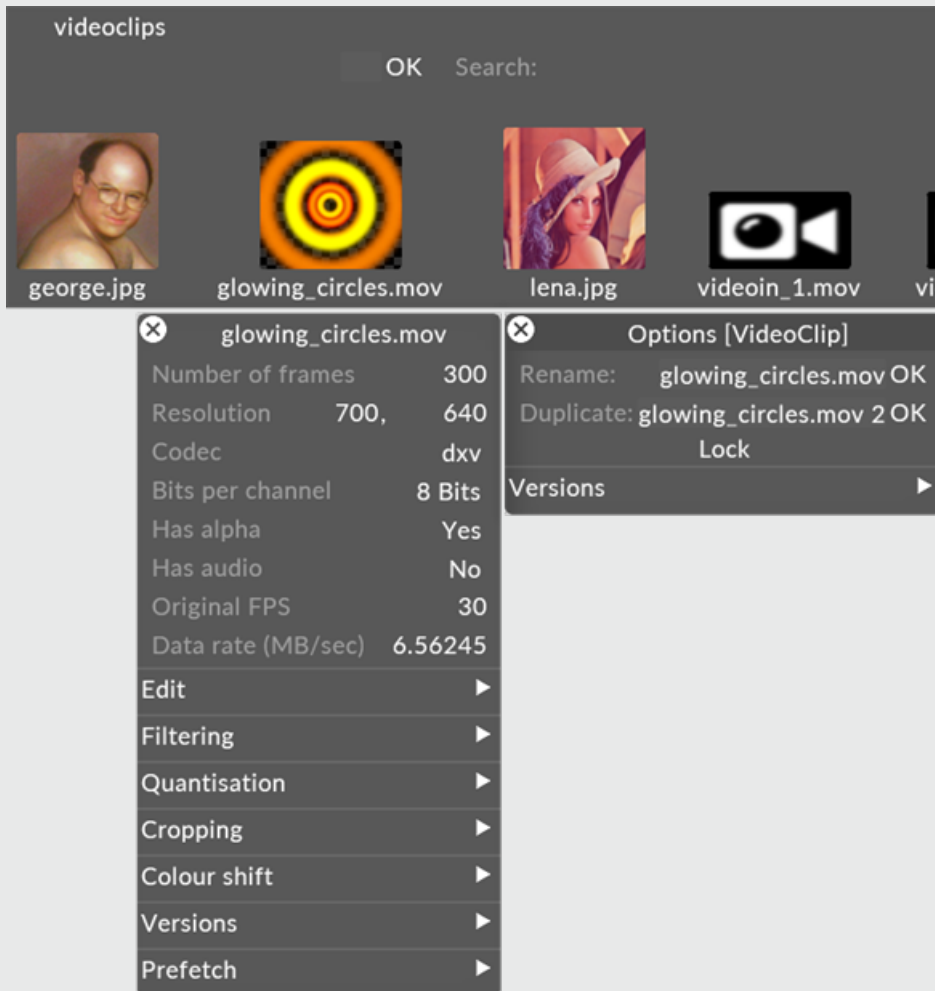

Note how a separate instance of this clip now displays in the video\_clip picker. This clip can have a different set of content properties than the original.

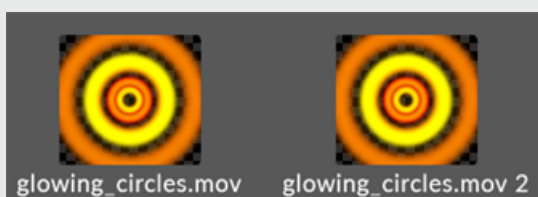

# Image sequences

An Image Sequence enables the playback of a contiguous sequence of images as a video.

## Enabling image sequences

Any folder inside VideoFile with a name ending in **.seq** will be ingested as an image sequence. As long as it matches the requirements described in this topic, it will behave just like a conventional video file.

Supported Formats:

- TGA
- TIFF
- DPX

8-bit and 10-bit is supported where applicable. All formats support the use of alpha channel (with the exception of 10-bit DPX), and any framerate.

**Please note:** Although other formats may work, only those listed above have received enough testing to formally support.

# Sequence Requirements

Alongside supported formats, there are rules that must be followed when creating image sequences for them to be recognised by Disguise software. These rules are in place to ensure reliable and predictable playback performance.

- The name of images within the folder must end with their frame number. For example: My\_video\_00035.tif would be the 36th frame in the sequence.
- As an additional precaution, the name of the images should be prefixed with the folder name.
- Eg: My\_video.seq\My\_video\_00035.tif.
- The numbering must start from 0.
- There must be no gaps in the numbers between frame 0 and the final frame of the sequence.
- File formats cannot be mixed within the same image sequence folder.

## Ingesting image sequences

Image sequences will always be imported at 30fps. The playback fps can be changed in the clip properties.

Additional frames can be added to a sequence while Disguise software is running and will be available for playback immediately. It is not recommended to play back the sequence while receiving extra frames as this will affect playback.

In much the same way, gaps in image sequences can be filled in while Disguise software is running and once complete the sequence will become available.

Frames cannot be removed from a sequence without first exiting the project.

Any errors in image sequence formatting will be announced by a notification.

# Content management

Version, frame replace, and proxy tags behave in the same way as with regular videos, as long as the **.seq** portion of the folder name stays at the end.

For example: My\_video\_v2\_frame150.seq would be a frame replacement for My\_video.seq starting from frame 150. Tags are only ever applied to the .seq folders, never the image files themselves.

The rules for frame numbering are the same for frame replacements - the frames inside My\_video\_v2\_frame150.seq must still be numbered from 0.

If a sequence is accidentally imported without **.seq** at the end of the file name, the several thousand image files ingested can be removed by taking the following steps:

1. Exit the project.
2. Add the missing **.seq** to the folder name.
3. Start the project.
4. Right-click the **missing** tab in the videoeditor and select **Remove Missing**. After a brief pause, the images will be removed.

# Performance

Due to specific performance optimisations, the preferred settings for TGA and TIFF are as follows.

## TGA

- Do not use RLE compression
- Render at 24-bits per pixel. Only include an alpha channel if required.

## TIFF

- Use IBM PC byte order
- Do not use LZW compression

- Segment size should be equal to the height of the frame (this is often the default and not editable).
- Render at 24-bits per pixel. Only include an alpha channel if required.

## DPX

- Render at 8-bits per channel unless working in a fully 10-bit pipeline.

# 10bit content

10bit content is a newly supported feature in r16. This topic aims to show some of the known workflow challenges to be aware of.

- 10bit content is added to Disguise software project just like any other content. See [placing media files](#) for more information.
- 10bit content can be played back regardless of whether Disguise software is in 8-bit or 10bit mode.
- Only 10bit DPX content has received a full performance test.
- 10bit DPX files cannot have alpha channels.
- NotchLC 10bit is supported. This is technically the highest performance 10bit format Disguise software supports.
- Embedded HDR data is not currently supported. Tone maps (LUT file's) must be applied on the output.
- The bit depth of DPX sequences is not given when in 8-bit mode.

16-bit file format support is as follows:

- Files loaded from objects/DxTexture are downgraded to 8-bit in r16, regardless of original bit depth or current bit depth of d3.
- Files loaded from objects/VideoFile are downgraded to the current bit depth of d3.
- PNGs may be subject to some processing during downgrade.

# Alembic Files

Alembic files are animated 3D mesh objects that can be imported and used within disguise.

## Configuring an Alembic file within disguise

1. Open your project folder
2. Copy your working alembic file into the Mesh folder
3. Run your project
4. Right click on the Stage menu
5. Left click on the venue to assign one to the project. If the default 'none' is selected, create a new venue
6. Right click on the venue name and click on the + symbol to add a new prop. A prop can be a regular mesh or alembic file located in the Mesh folder
7. Right click on the name of the newly created prop and under the Mesh property, select the alembic file
8. In the timeline, create an AnimateObjectPreset layer
9. Left click on the layer to open it's layer editor, and open the keyframe editor for the Config tab
10. Create a new screenconfiguration named "off" and hit the + icon to add the alembic prop to the layer. Leave all fields at the default 0
11. Duplicate this configuration and name it "on"
12. Right click on the header bar to open the "on" configuration's properties menu, and set the Animate field to 1.

13. Keyframe these two configurations to have the alembic file animate in the visualizer. The time between the "on" and "off" configurations will determine the speed the animation plays back.
14. Enter a playmode in the timeline to see the file animate.

## Recommended Blender settings for object animation and export

Please note, for questions about the UI or specific animation workflow of Blender, it is best to contact Blender support. This guide is intended only for the specific export settings needed with the disguise workflow.

1. Set the project's units to Meters.
2. Import or create the mesh of your prop object in Blender.
3. Create an empty and animate it with either the keyframe or graphs editor.
4. Attach this null to your object using an object constraint or modifier.
5. Play your animation to ensure that the object is now attached to the null.
6. Select the null and the object.
7. Export the alembic file using the below settings:

- Renderable Objects Only
- UVs
- Pack UV Islands
- Normals

## Important Notes about Alembic Files

Alembic files can only be brought in as prop objects, they cannot be used as UV mapped content screens.



There are some restrictions on the types of alembic files supported in disguise. Please refer to these recommended alembic export settings if your custom alembic file is not rendering within disguise.

The object must not contain:

- Curves
- Points
- Camera
- SubD
- NuPatches
- FaceSet
- Light
- Material
- Custom data

# Slideshows

**Slideshow is a new feature of r14.1 that enables fast and easy output of a sequence of content with a minimum of sequencing time.**

Although these sequences rely on file location and name, they can be edited while the software is running.

They allow an automated slideshow style operation of video or still images within the software. A good example of this is running advertisements pre-show. It would take too long to sequence the adverts individually within Disguise, so utilising a slideshow allows you to place one piece of content within Disguise that may consist of many pieces of content in reality. It also allows you to change the content outside of Disguise without affecting the sequencing.

## Creating slideshows

A slideshow is any folder within VideoFile that ends in “.slideshow”. This functions similarly to the versioning or proxy tags, and tells d3 that the contents of the folder is to work as a single clip made up of multiple files.

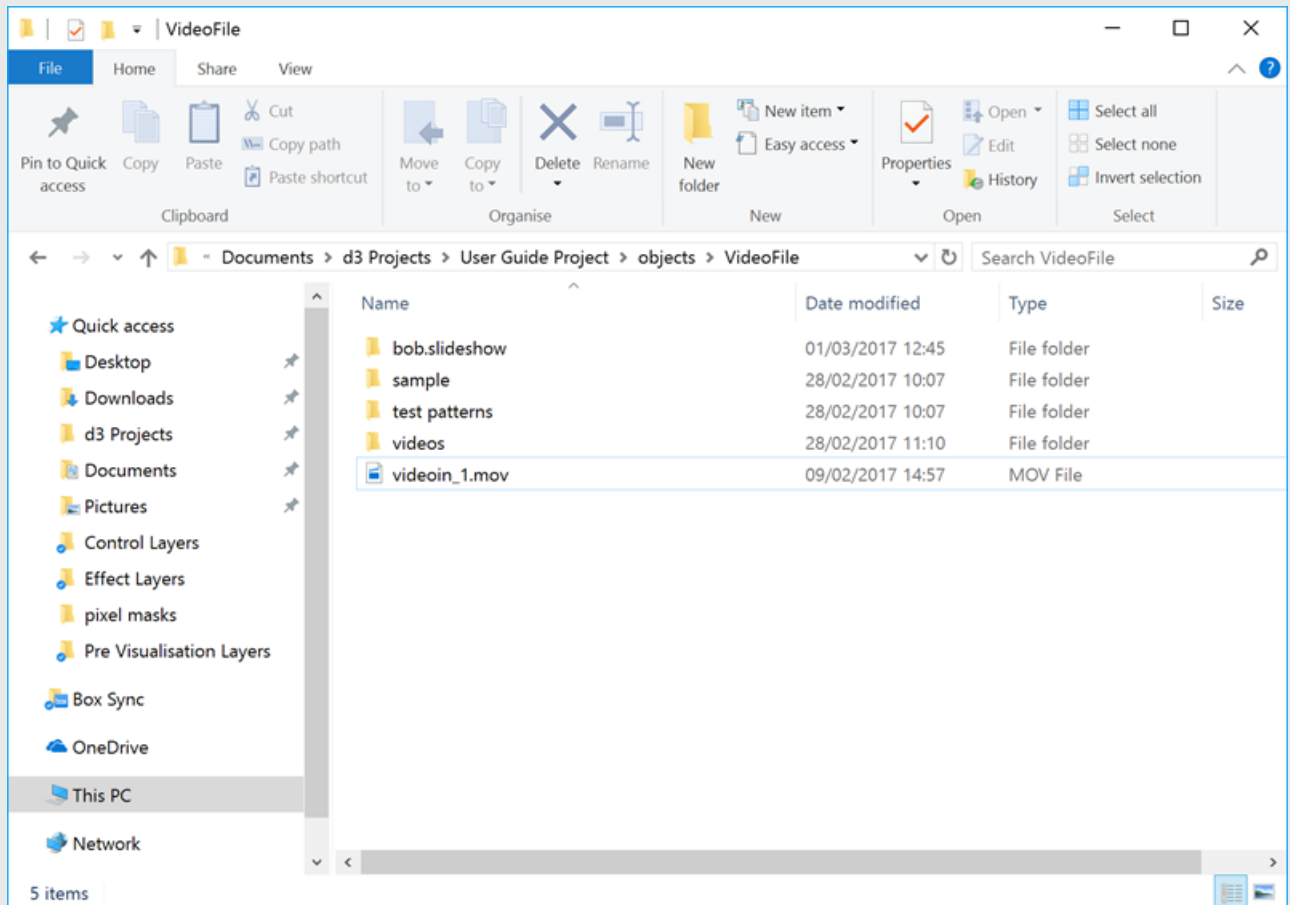

*Video file folder*

Slideshows can be populated with any filetype that could be placed inside the VideoFile folder, in any combination. The order that the slideshow plays back these pieces of content is determined by their filenames - slideshow works in alphabetical order.

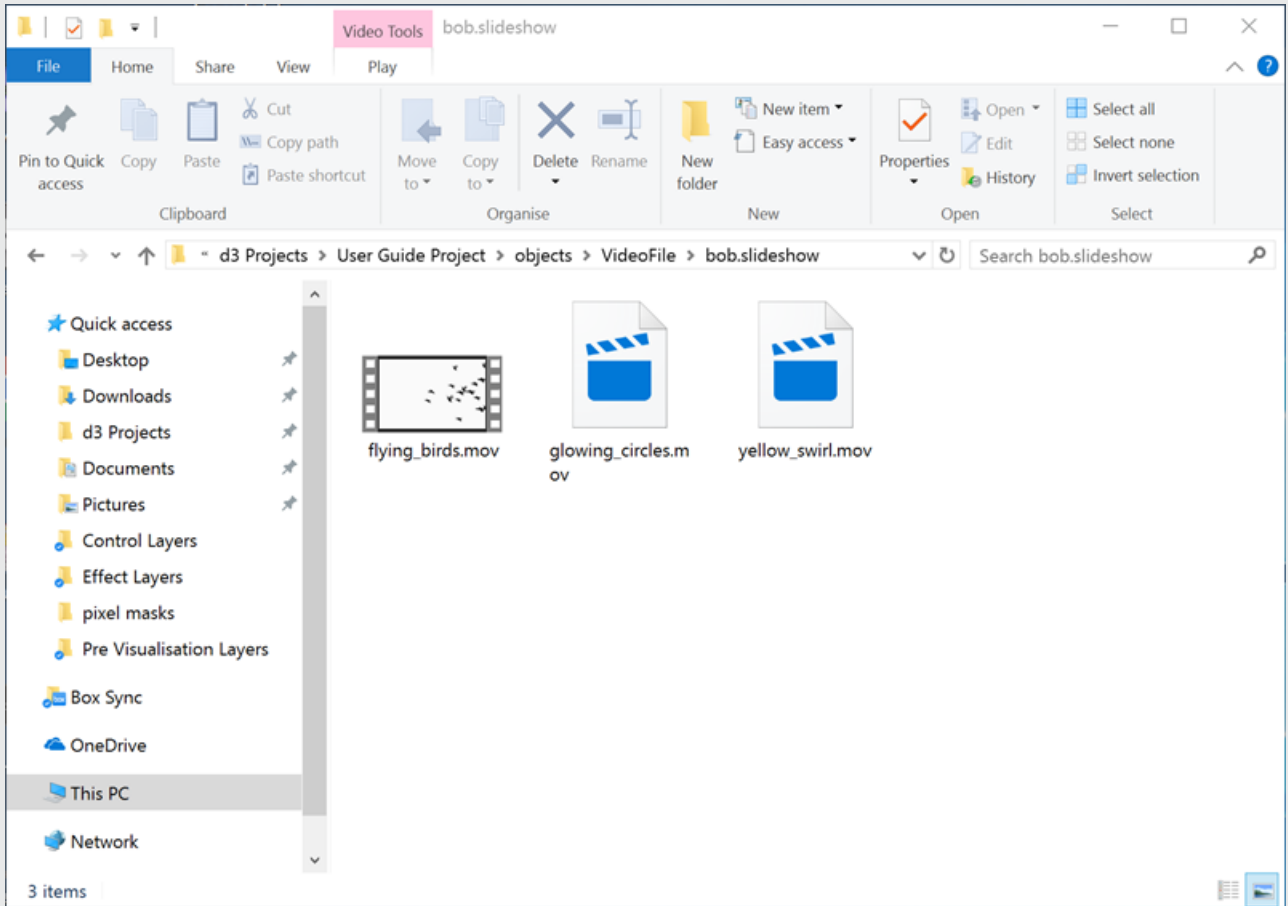

*bob.slideshow showing 3 videos*

Slideshows are accessed inside Disguise, just in the way normal videofile content is. On the video layer, open your media object keyframe and select your slideshow.

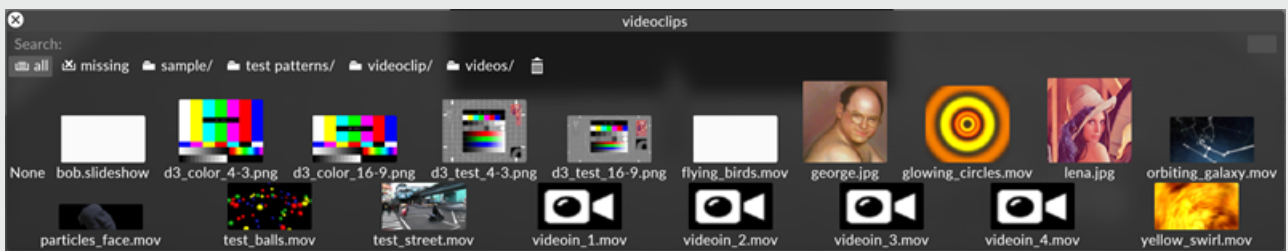

*bob.slideshow now available as standard video content*

The slideshow behaves just like a regular video file in Disguise, so playmodes, colourshift, audio routings, etc are all applicable. Transition Time will enable a crossfade between each piece of content, as if each piece of content were separately keyframed into the module.



*bob.slideshow on the video keyframe editor*

Clicking unlock clips will allow you to rename (ie: reorder), and delete slideshow clips without having to restart d3. When in unlocked mode, the slideshow cannot be played back.

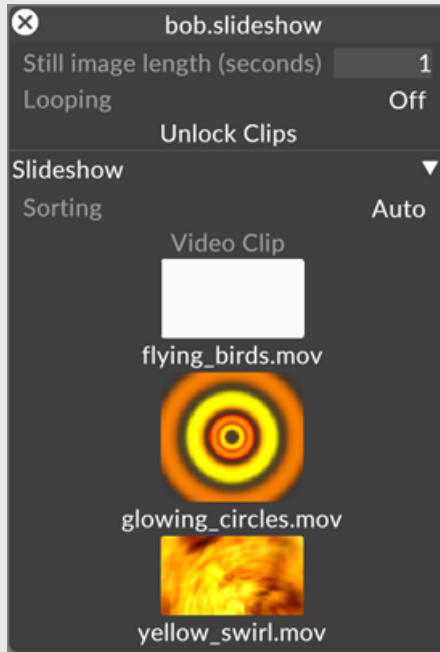

## Content management and slideshows

Versions, proxies and frame replacements are all compatible with slideshows. Versions can exist within the same .slideshow folder. The Disguise software will automatically use the highest version content it can find.

# VideoClip object

## Overview

When sequencing video files in Disguise software, you are actually sequencing VideoClip objects, which are the container Disguise software uses to identify the media file, its properties, versions as well as other specific properties.

## Duplicating VideoClip objects

Sometimes it's useful to have a single video file that has different settings for different parts of the show. For example, you may wish to have Video 1 with in and out frames at default in one part of the show, but change the in and out frames to a different setting later one. Instead of making a hard copy of the file in the VideoFile folder of the project, you can simply duplicate the VideoClip object in Disguise software and change the VideoClip object properties. This saves media drive space, and also allows for better internal handling of the media files.

To duplicate a VideoClip object:

1. In the VideoClips editor, which can be accessed via the Video, Legacy video or VideoTrigger layers, left click the Video property under the media tab.

The VideoClips manager opens.

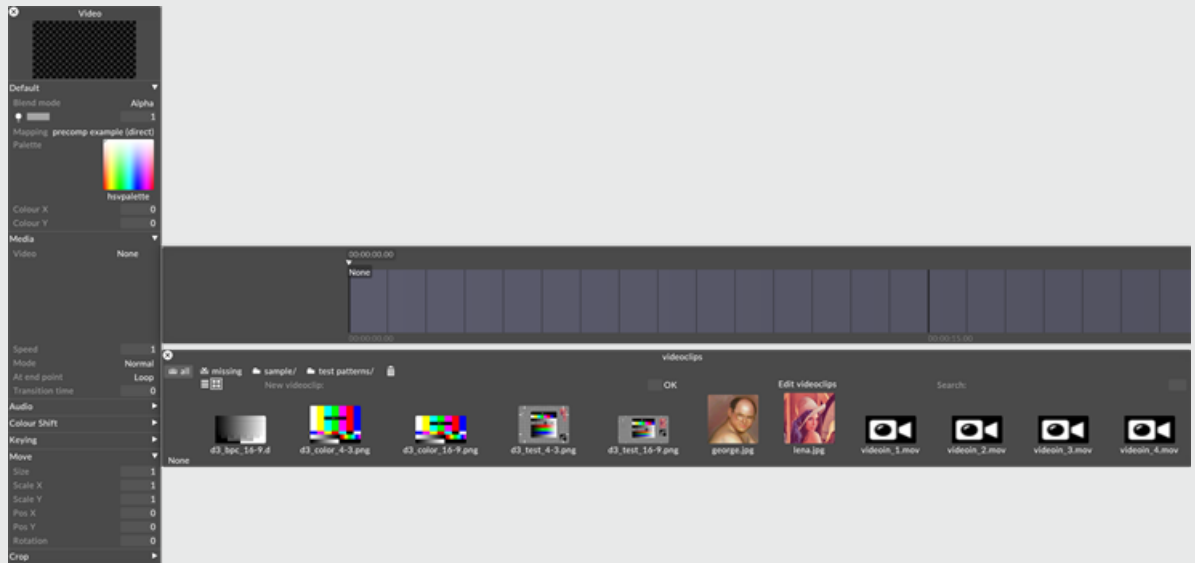

2. Right click a **VideoClip**  
The VideoClip editor will open, containing the properties of that VideoClip.
3. Right click the header of the VideoClip editor
4. Select **Duplicate**, give the duplicate a name, and then hit **Enter** or **OK**.



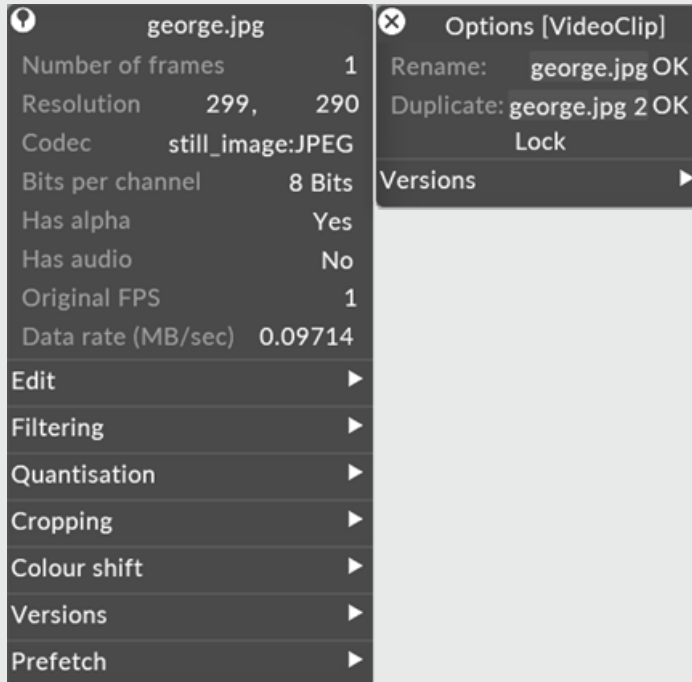

5. You will now see the duplicate VideoClip available in the manager, but only one piece of content will be in the VideoFile folder. You can edit the settings of the duplicate clip to be different to the original.

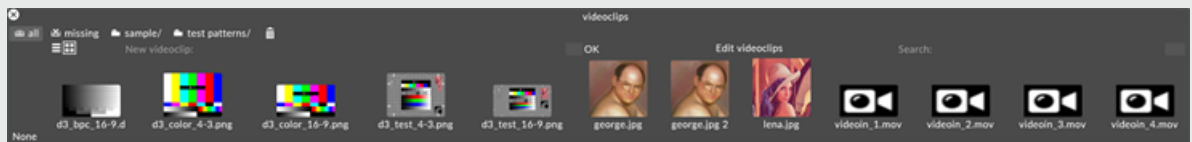

## Multi Editing VideoClip objects

Its possible to Multi-Edit most objects in Disguise software, but due to the VideoClip objects being items used for sequencing, the method to multi-edit them is slightly different.

To multi-edit a VideoClip:

1. In the VideoClips editor, which can be accessed via the Video, Legacy video or VideoTrigger layers, left click the Video property under the media tab.

The VideoClips manager opens.

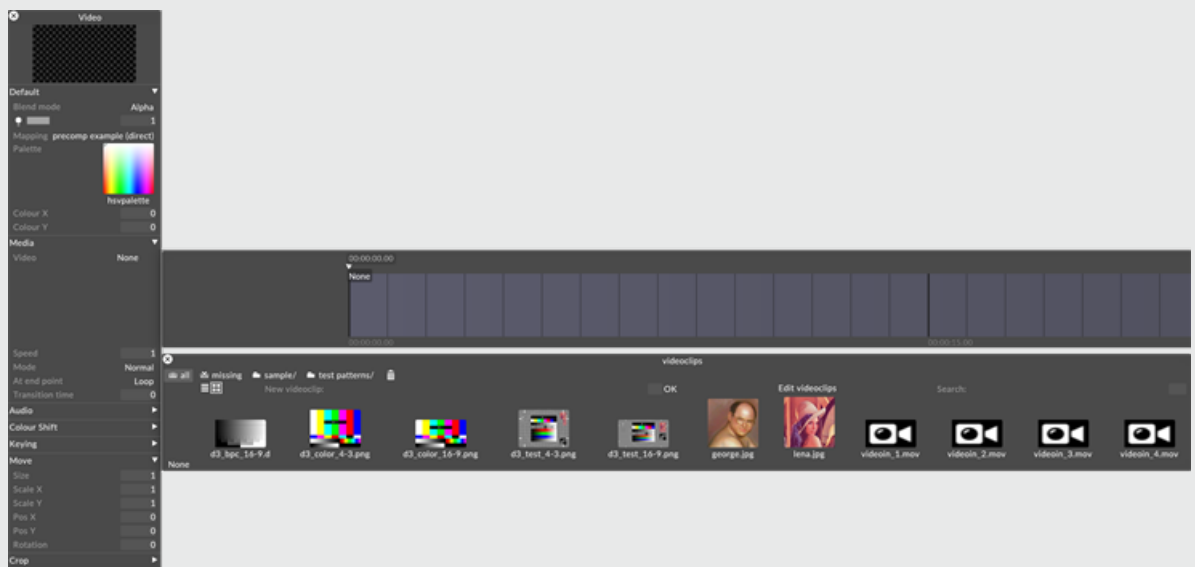

2. Left click the **Edit VideoClips** button.
3. The Multi Editor opens, select clips by using CTRL or SHIFT and alter their properties accordingly.

VideoClip												
Name	FPS	Start	End	In	Out	Bilinear filtering	Frame blending	Colour profile	Colour shift	Deinterlace method		
d3_bpc_16-9.d	1	0	1	0	0	On	Auto	itu709	ColourShift	Weave & Interpolate		
d3_color_4-3.png	1	0	1	0	0	On	Auto	itu709	ColourShift	Weave & Interpolate		
d3_color_16-9.png	1	0	1	0	0	On	Auto	itu709	ColourShift	Weave & Interpolate		
d3_test_4-3.png	1	0	1	0	0	On	Auto	itu709	ColourShift	Weave & Interpolate		
d3_test_16-9.png	1	0	1	0	0	On	Auto	itu709	ColourShift	Weave & Interpolate		
george.jpg	1	0	1	0	0	On	Auto	itu709	ColourShift	Weave & Interpolate		
george.jpg 2	1	0	1	0	0	On	Auto	itu709	ColourShift	Weave & Interpolate		
lena.jpg	1	0	1	0	0	On	Auto	itu709	ColourShift	Weave & Interpolate		
videoin_1.mov	0	0	1	0	0	On	Auto	itu709	ColourShift	Weave & Interpolate		
videoin_2.mov	0	0	1	0	0	On	Auto	itu709	ColourShift	Weave & Interpolate		
videoin_3.mov	0	0	1	0	0	On	Auto	itu709	ColourShift	Weave & Interpolate		
videoin_4.mov	0	0	1	0	0	On	Auto	itu709	ColourShift	Weave & Interpolate		

See the [Multi-Edit](#) topic for more information.

# Video Codec overview

The Disguise software uses the Quicktime .mov video container for playing back various codecs.

The Disguise software utilises advanced GPU codecs DXV/HAP/HAP-Q which allow for excellent quality/performance trade offs.

**HAP / DXV** : Two very similar GPU based codecs that allow for high numbers of simultaneous video to be played at a good quality. Utilise HAP for resolutions greater than HD.

**HAP-Q** : Utilises twice the bandwidth of HAP/DXV, but delivers higher tonal fidelity especially in rendered content, or content with tonal gradients (such as skylines)

**Animation** - A totally lossless, but very high bandwidth codec.

**Notch LC** - 10bit ltd have developed a new video codec which is intended to fit in between HAP and lossless image sequences in terms of both visual quality and performance. All users who are currently unsatisfied with HAP, but are unable to justify the cost of lossless playback will benefit from this addition.

# DXV 2.1.1 codec

Disguise software utilises a number of codecs; however, its primary video codec is DXV. The DXV 2.1.1 codec performs all decompression on the GPU allowing for greater media playback performance compared to CPU based codecs (ProRes, MPEG, Photo JPEG). All codecs have characteristics due to the various compression methodologies and DXV 2.1.1 is no exception.

DXV 2.1.1 provides excellent results and quality to size ratio. When playing back filmed video content, it performs very well without any changes to workflow.

See the 'Filmed Video' section below.

When playing back graphics with strong gradients, noise can be added to the video during render to reduce compression artifacts.

See the 'Graphics & Gradients' below.

Download the DXV 2.1.1 Codec [here](#).

**Please note:** DXV3 is not supported

## Filmed Video

Stills from the short film [Tears of Steel](#). Source media, 1920 x 800 PNG.

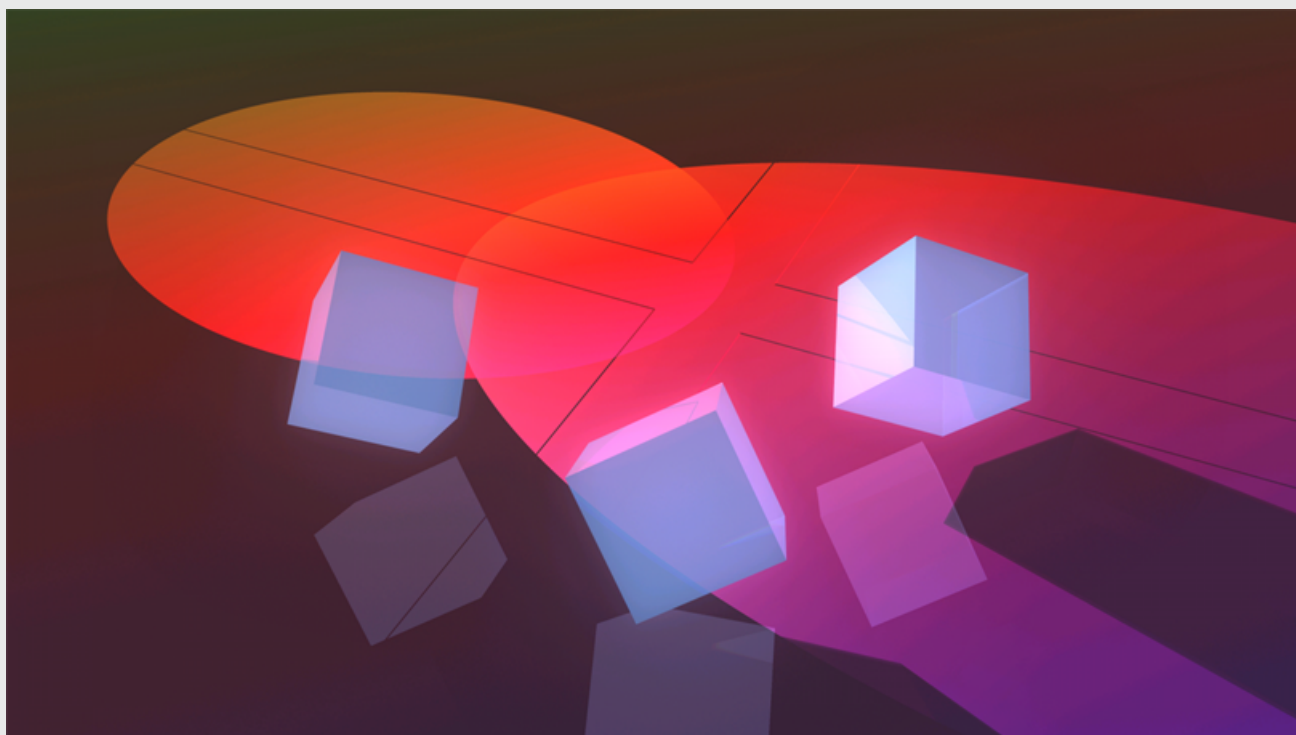



Photo JPEG

## Graphics with Gradients

With the DXV 2.1.1 codec there can be artifacts after compression in certain cases. One issue that can occur is 'banding' in gradients, however this can be eased by adding a small amount of noise to the media before conversion.



DXV



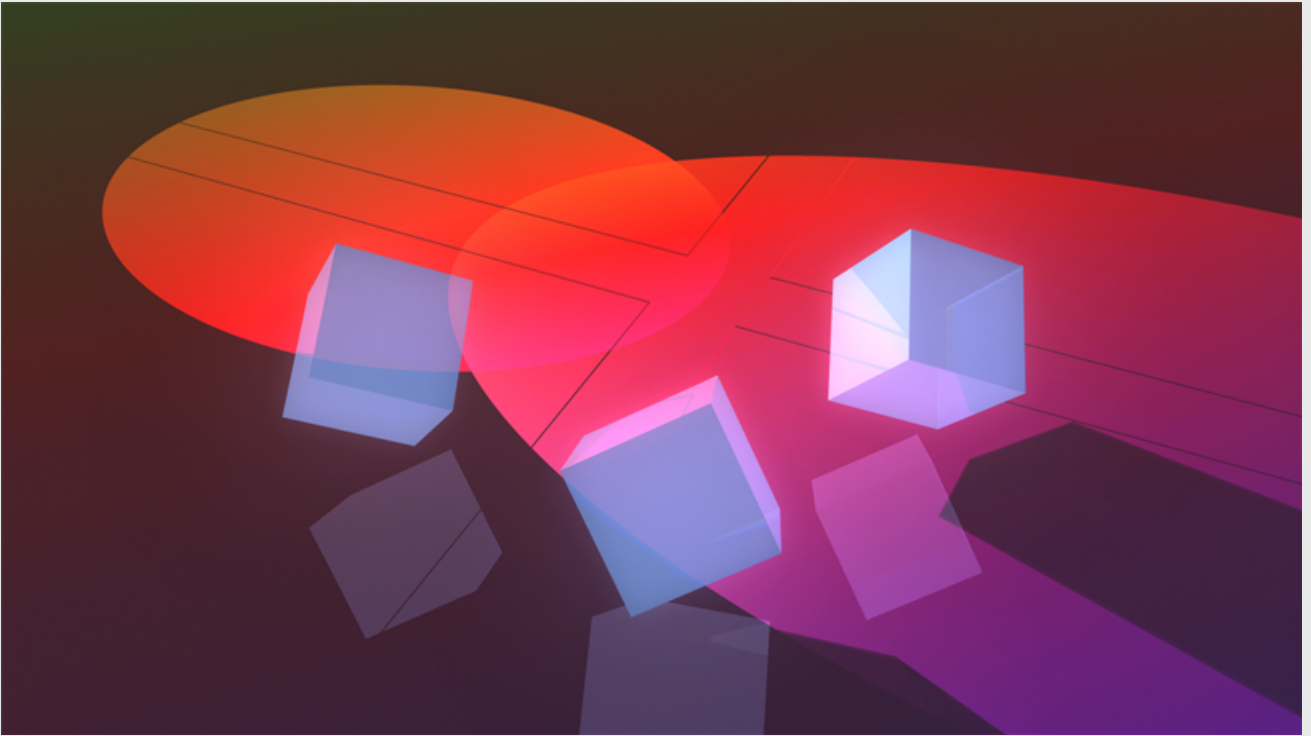

*DXV + 3% Noise*

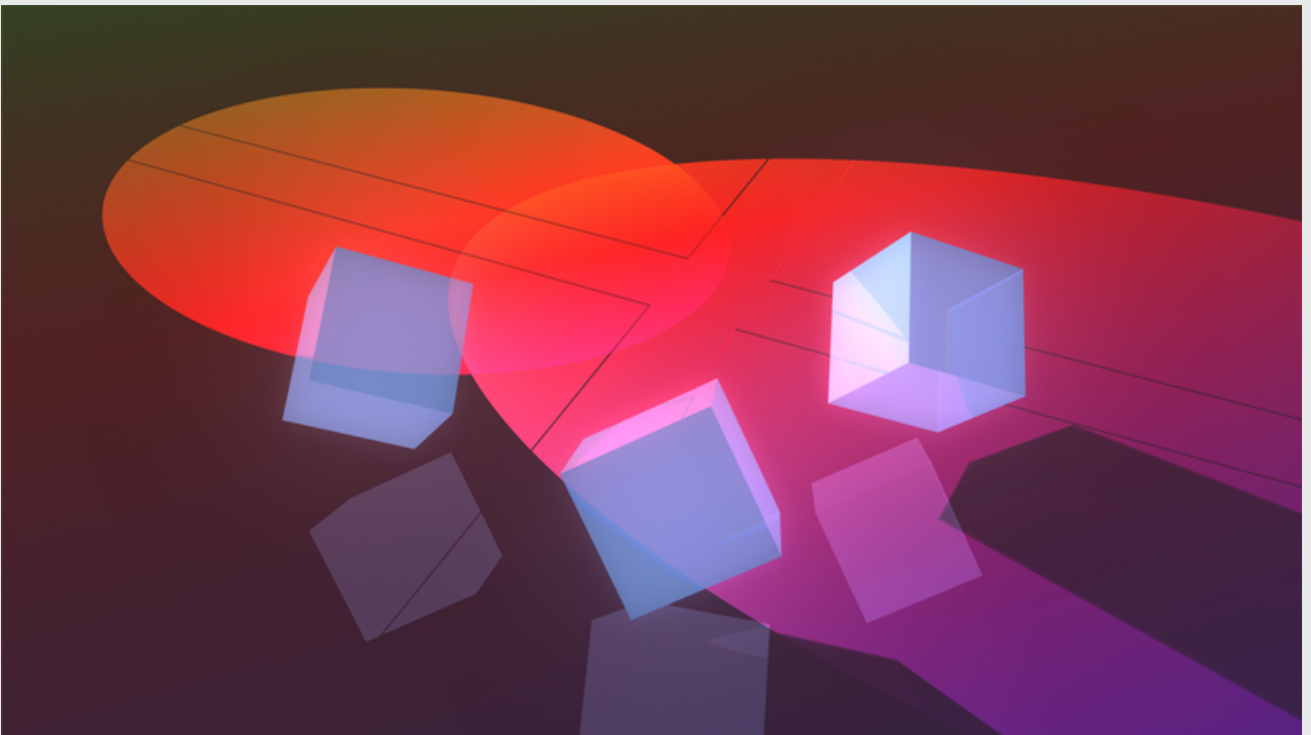

*Photo JPEG*

# HAP / HAP-Q codec

The HAP family comes in multiple flavours for different purposes.

## HAP

Enables very large canvases at lower bitrates, with some trade-off for compression. HAP is very similar to DXV in terms of compression profile, but allows much larger canvases. If you are preparing canvases over HD, we recommend using HAP. When preparing shot footage, HAP is often the go to choice for bandwidth and compression.

## HAP-Q

Utilises twice the bandwidth of HAP, but offers much better detail in tone, which is especially important in rendered content where tone gradients are utilised.

## HAP Alpha

HAP Alpha has the same image quality as HAP, and supports an Alpha channel. HAP Alpha has roughly the same bandwidth as HAP-Q.

**Please note:** Download the HAP/HAP-Q Codec [here](#).



**Warning:** Disguise software does not support Hap-Q Alpha

## Graphics with Gradients usage of HAP-Q

Most lossy codecs are very sensitive to gradients through tone. Below is a comparison of HAP-Q and HAP performance on a gradient through tone in order of quality. Click the image for full size.

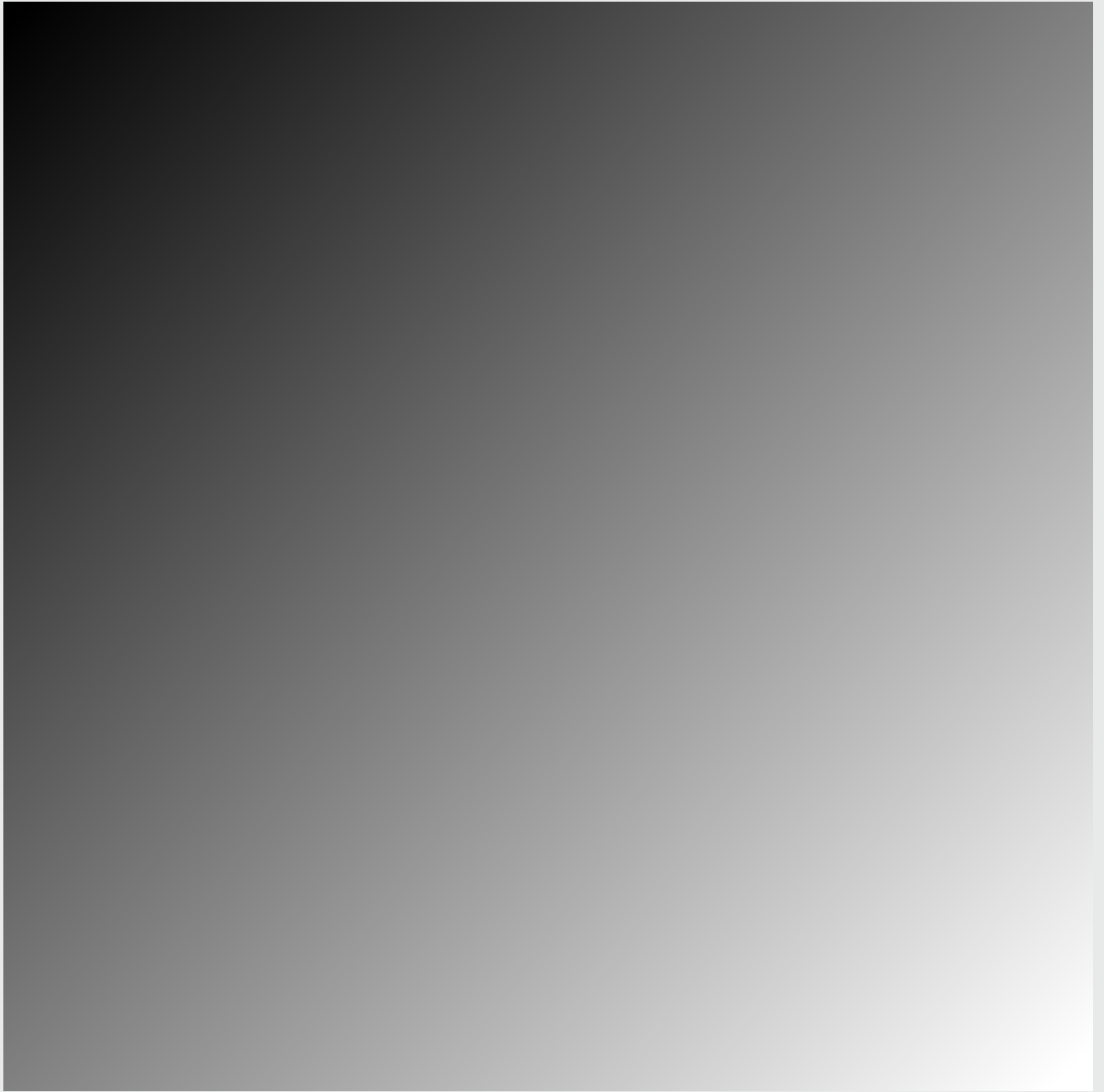

*Original*



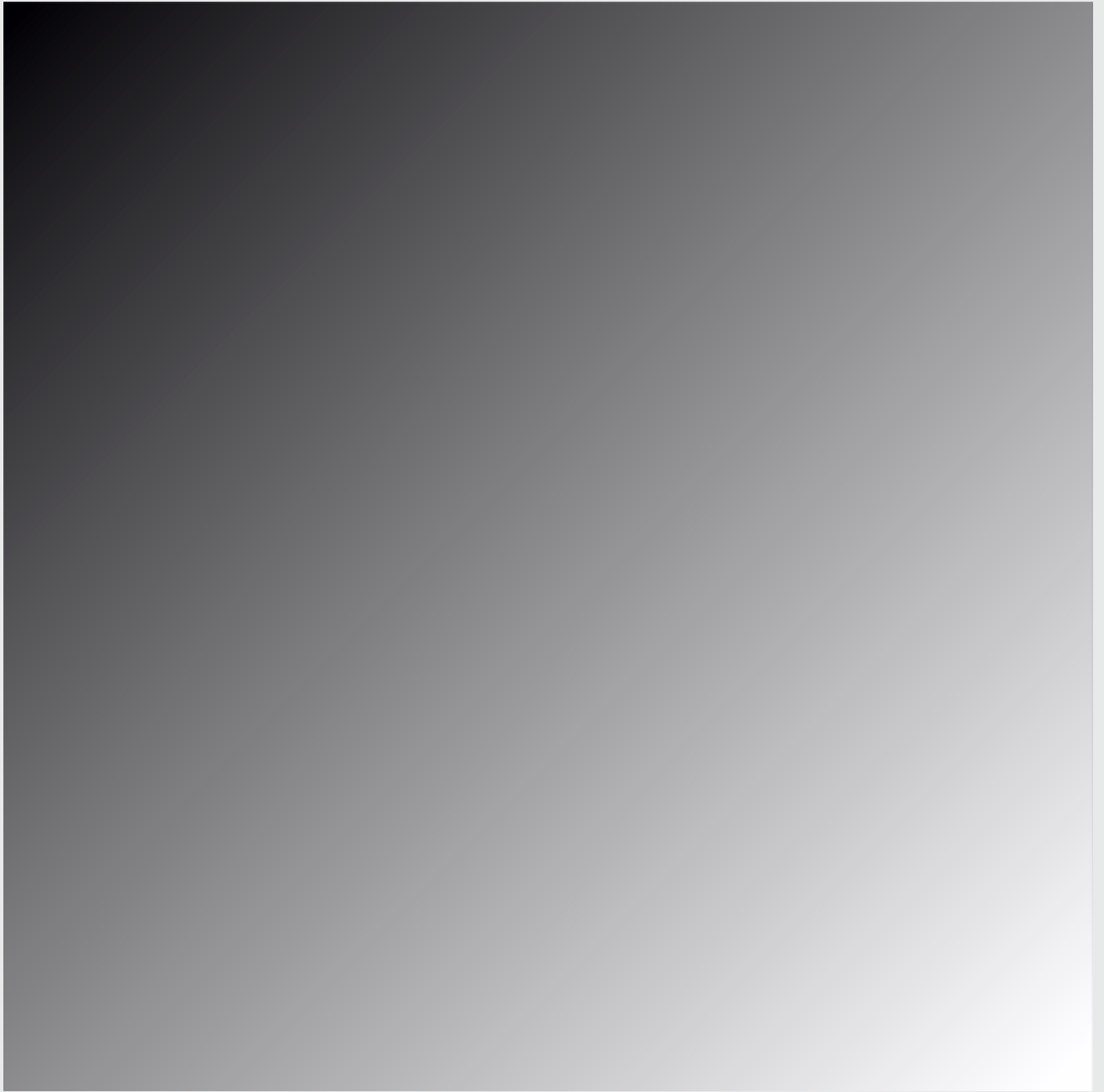

HAP-Q

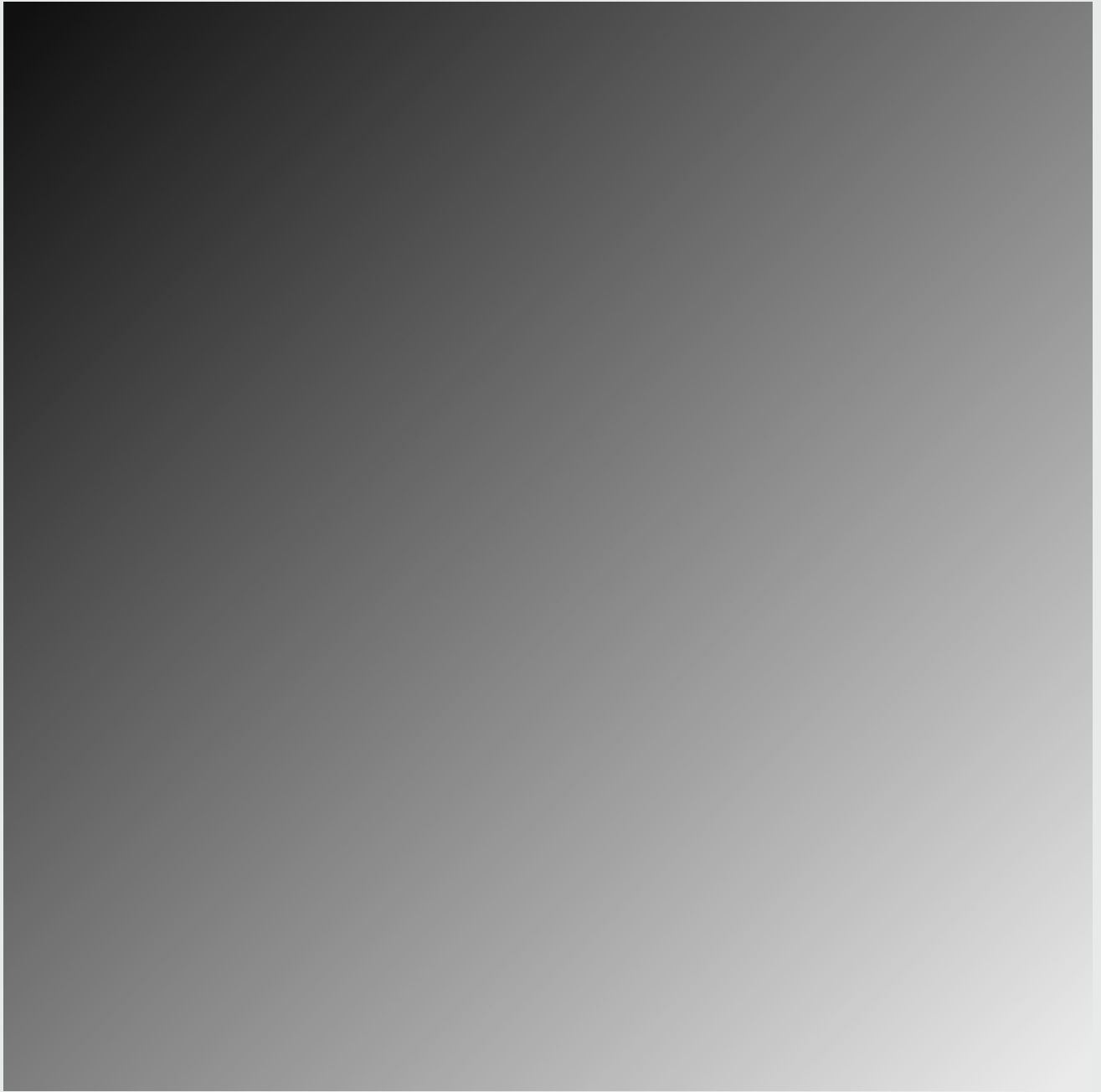

*PhotoJPEG*



*HAP/DXV*

# Transcoding software

After installing the DXV/HAP/HAP-Q codec for Mac or Windows it can be utilized by any standard rendering software such for example After Effects but also directly in QuickTime Player Pro.

You can also transcode from any movie format to DXV/HAP/HAP-Q using the Adobe Media Encoder CC or the freeware MPEG Streamclip. Both of them allows for drag-and-drop batch transcoding.

Download the HAP/HAP-Q Codec [here](#).

Download the DXV Codec [here](#).

Download MPEG Streamclip [here](#).

# Adding noise in After Effects

Adding a small amount noise before converting media to any codec is a good way to reduce compression artifacts.

The easiest way is to use the noise effect in After Effects.

## Example

First, create a new After Effects project and composition, and add your content as a layer.

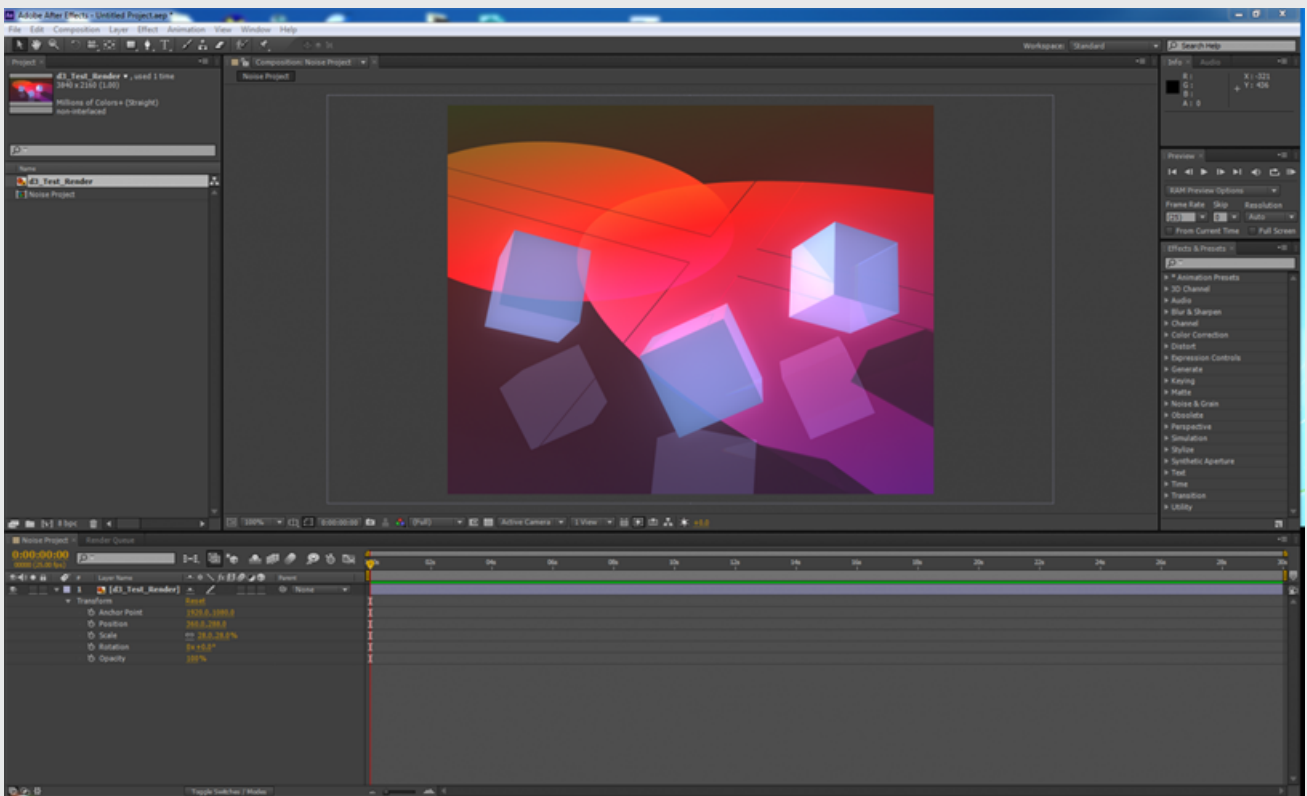

Next, select your content layer and from the toolbar choose, Effect > Noise & Grain > Noise. Or apply a preset to your content by clicking [here](#) and importing it into the After Effects composition.

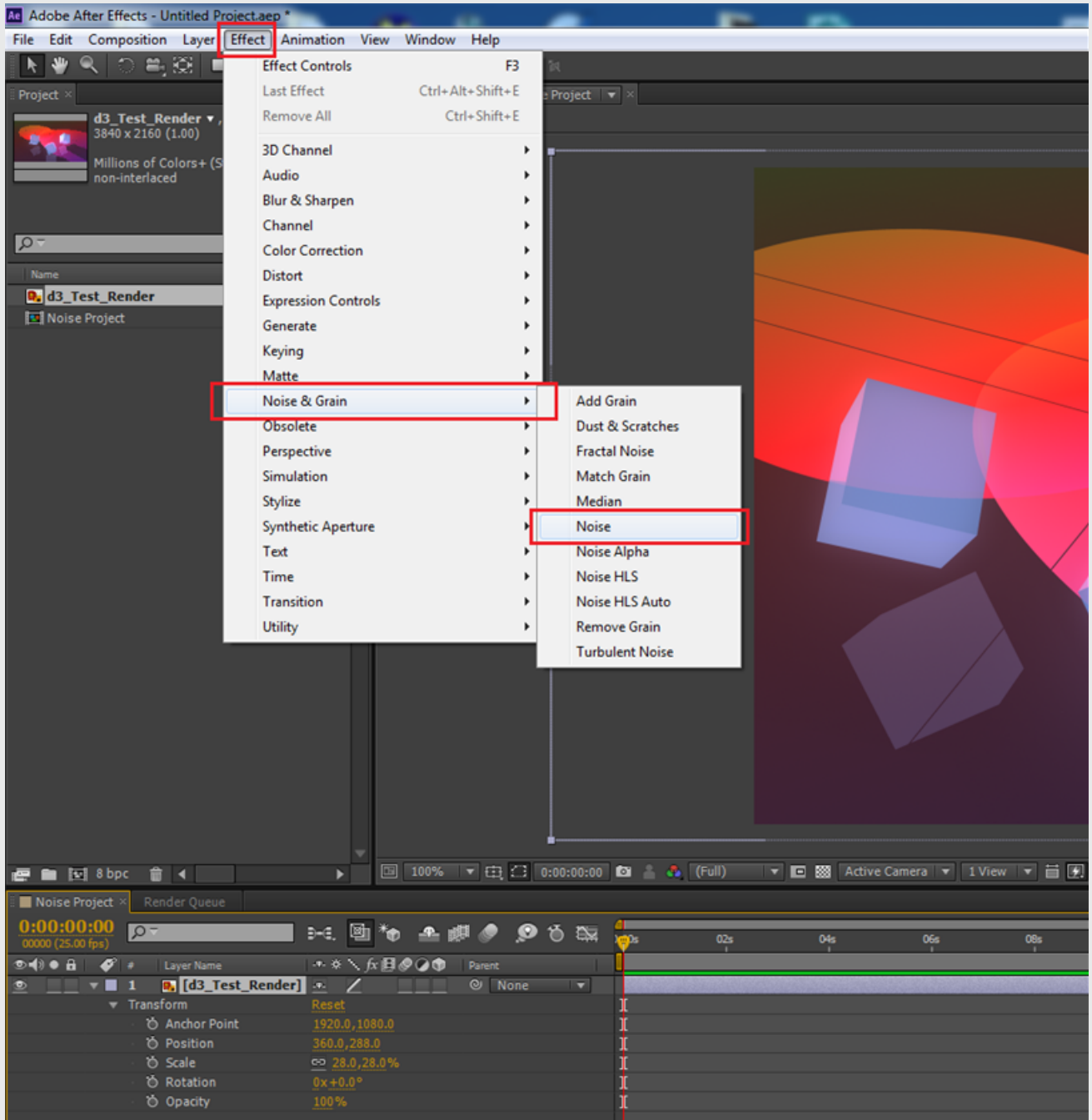

Now in the effects property box, set the amount of noise to be applied. 2 - 3% works well.

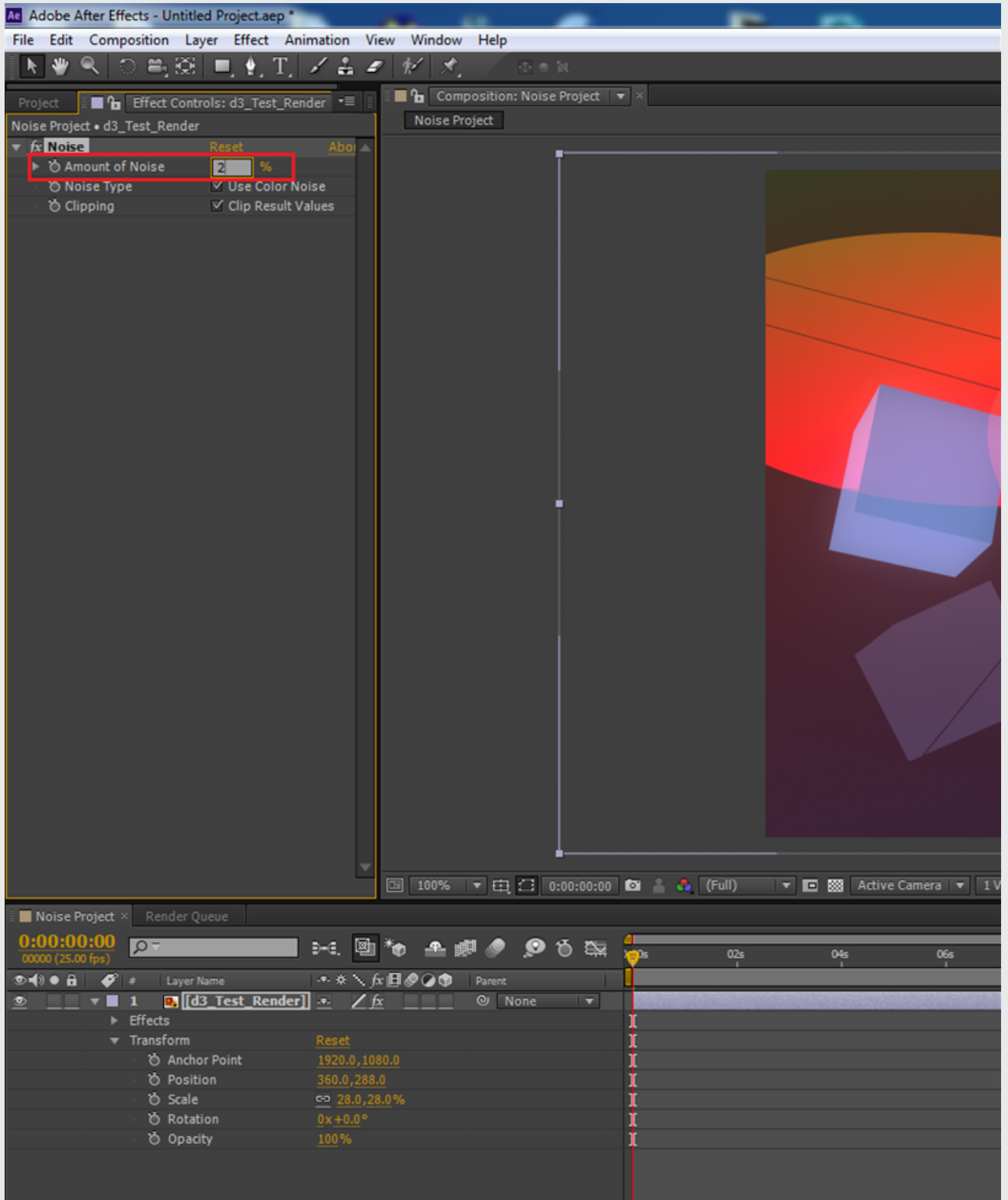

Now you can render out your content.

# Colour Management

Disguise software has powerful colour management tools to ensure that your content plays back exactly as it was created.

## Overview

### Colour Management

Colour management refers to the workflow for preserving the colour space that the content was created in throughout the entire creation to playback pipeline.

### What is a colour space?

A colour space, in simplistic terms, is a mathematical definition of how a triple of red, green and blue values (or X, Y, Z, or Y, U, V, or L, a, b or any other three-way breakdown) interact to produce a specific colour.

Colour is derived from different wavelengths of lights hitting our eyes. While each pure wavelength has a distinct colour, the blending of different wavelengths produces more colours still. The CIE colour space diagram provides a visualisation of all possible colours at a given intensity of light (or brightness, although the word has other meanings in this context.)

The colours that a particular colour space can represent can be displayed as a triangle drawn onto the CIE diagram:



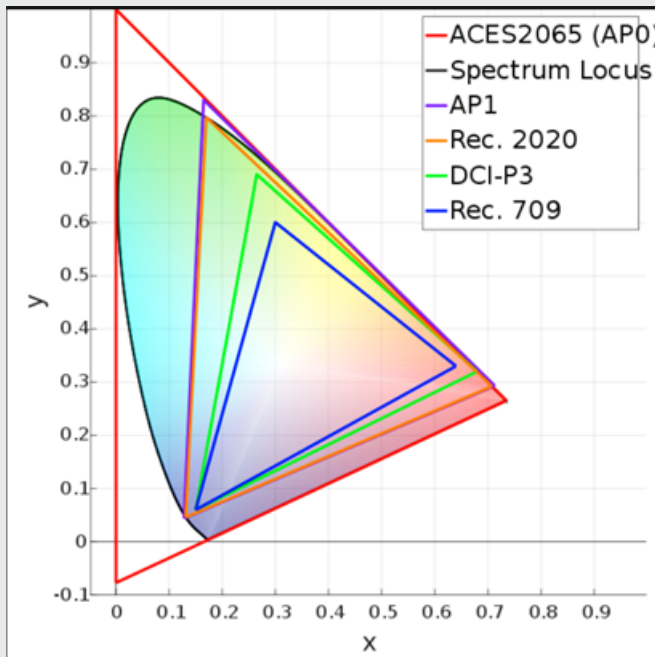

Here we can see that sRGB, the standard colour space computer monitors operate in, is a relatively small triangle compared to rec2020, or ACES AP0/ AP1.

### Colour Bit Depth

The reason a relatively small space was chosen is that using 8-bit values, only  $255 \times 255 \times 255$  values are available to specify a colour location. To be able to display smooth gradients, more extreme greens, reds and blues were excluded. Now, as 8+bit displays become more widespread, wider colour spaces which capture more of the possible colours become viable. rec2020 and P3-DCI are two widely used industry standards.

The default working colour space in Disguise software is sRGB, and it is capable of storing 16bit colour values, which allows for bit depths to always be preserved throughout the colour-managed workflow.

### Colour-managed workflow

Broadly, a colour-managed workflow is a workflow that can maintain and interchange accurate colour information between different stages in a process that brings image data from the point at which it is generated to the point at which it is displayed. This process might involve one application such as Disguise software, or it might involve several.

These workflows were pioneered for the visual effects industry, to ensure that images scanned from a camera could be combined, edited, composited, graded and printed back onto film in a way that did not corrupt or alter the colours contrary to artistic intent.

# Colour Management Modes

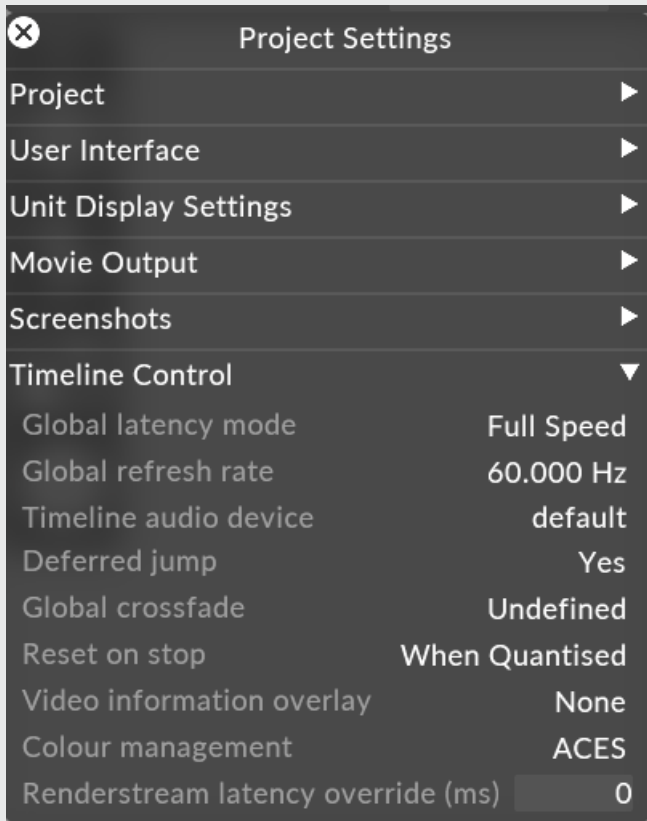

Disguise software currently supports three separate modes for colour management, selectable from inside project settings. These are “Disabled”, “Gamma Space”, and “ACES”, with “Gamma Space” being the default.

## 1. Disabled

- “Disabled” mode removes all colour transforms from the Disguise software pipeline. This is useful when you want to bring content into Disguise software and have no colour processing applied as it goes out to displays.
- Colour values of content are not altered, gamma curves are baked in, and the type of output device is not specified.
- This option can't support HDR properly.
- Perfect for sRGB/ ~Rec.709 all in/out situations
- Zero cost in GPU time.

## 2. Gamma

- “Gamma Space” mode is the existing colour management workflow within Disguise software. It has a range of input and output transforms, broken down into colour space and gamma function. All content is maintained internally as sRGB.
- This colour management option also means all content is blended with its gamma space applied (sRGB gamma curve). However mixed content (like Rec.709 and Rec.2020) will be more 'correctly' blended and converted to the output transform specified.
- Supports HDR and Wide Colour Gamut displays.
- Only leverages the GPU when the content or display isn't sRGB.

### 3. ACES

- “ACES” mode enables the ACES pipeline.
- Only “ACES” colour space has linear gamma 1.0, where e.g. sRGB content will have the sRGB gamma curve removed and colour space rotated to AP0 i.e. extended to the widest possible area.
- All content is blended in ACES and then transformed back out to the selected output transform.

For more information on ACES, visit this [link](#).

# Colour profiles

A colour profile is an object within Disguise software that allows you to specify what colour space the content was produced in, and what colour space the content is output in which allows Disguise software to convert between the two colour spaces, to preserve colour detail as required.

## Overview

A feature of Disguise software is the ability to apply a colour profile to both screens as well as pieces of content.

A colour profile consists of a colour space specification and a gamma curve.

Colour profiles are supported on LED Screen, DMX Screen and DMX Lights screen objects.

## Colour space

A colour space defines the range of colours achievable with a particular signal chain (content source -> display device). Different signal chains enable different colour spaces - this is not directly related to the colour depth (8 bit or 10 bit), but there is a relationship - you can think of the colour depth as increasing the resolution of the available colour space.

Colour space becomes important when considering content chains, as the colour space which the content is produced in should be preserved throughout the chain to ensure it can be output in the same colour space.

The Disguise software's colour space is sRGB - also known as Rec.709.

## Gamma

When expressing a color in RGB (red, green, blue), what we are specifying is the amount of light which will be emitted from each phosphor, as a fraction of full power. What we are actually specifying is however the voltage which will be applied to pixel on the output device (projector, LED processor, etc). These devices don't respond linearly to the voltage, and the gamma curve is a way to correct for the non-linear relationship between content and display.

## Workflow

A colour profile is a discrete object within Disguise software that can be applied to a piece of content. The workflow consists of two parts, creating a new colour profile in the colourprofile manager, and

applying that profile to the content.

## Applying a colour profile to content

- Open your content layer.
- Right click the content thumbnail.
- Navigate to the Colour shift tab.
- Apply a new Colour profile to the clip using the Colour profile property.

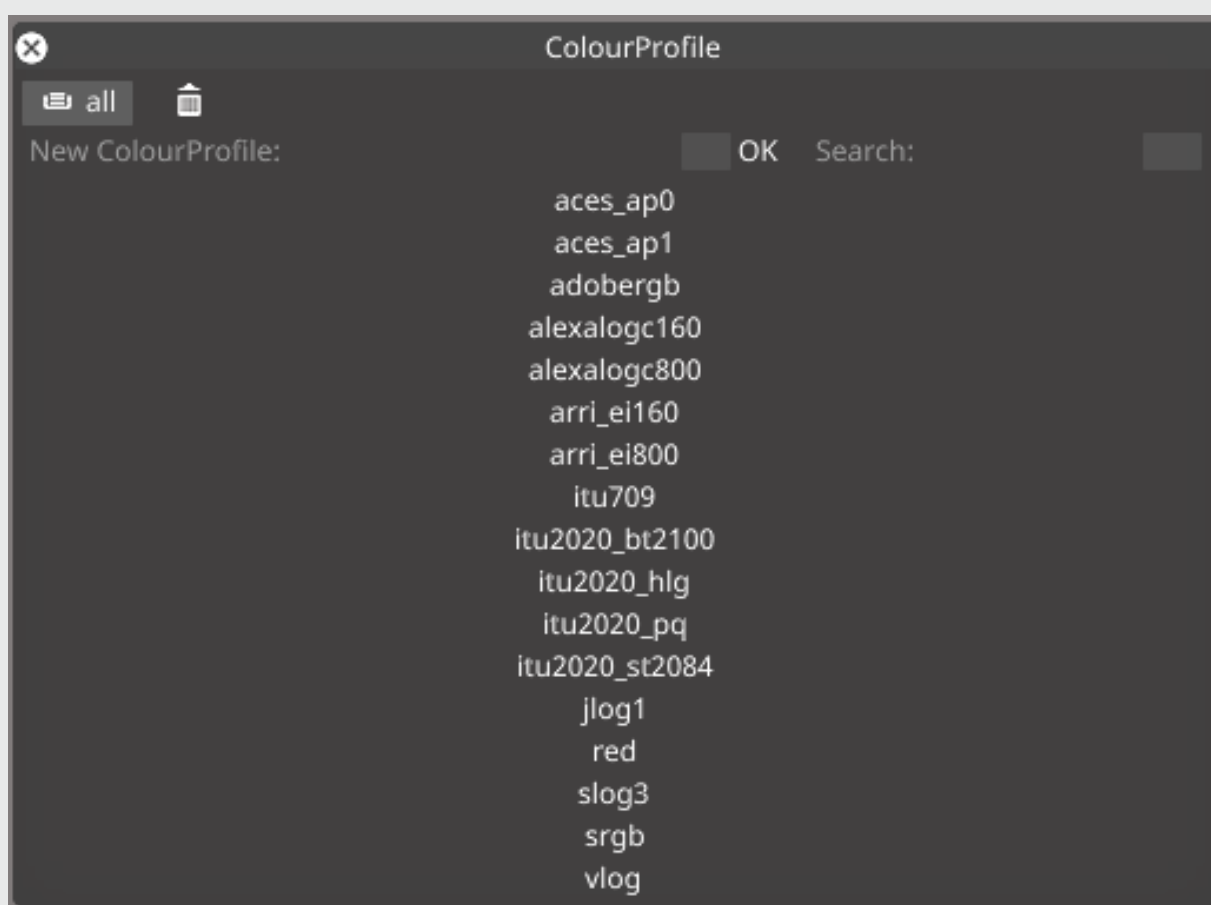

## Creating a colour profile

- Open a Video layer and apply a piece of content.
- Right click on the Media thumbnail and expand the Colour shift tab.
- Create a new Colour profile.

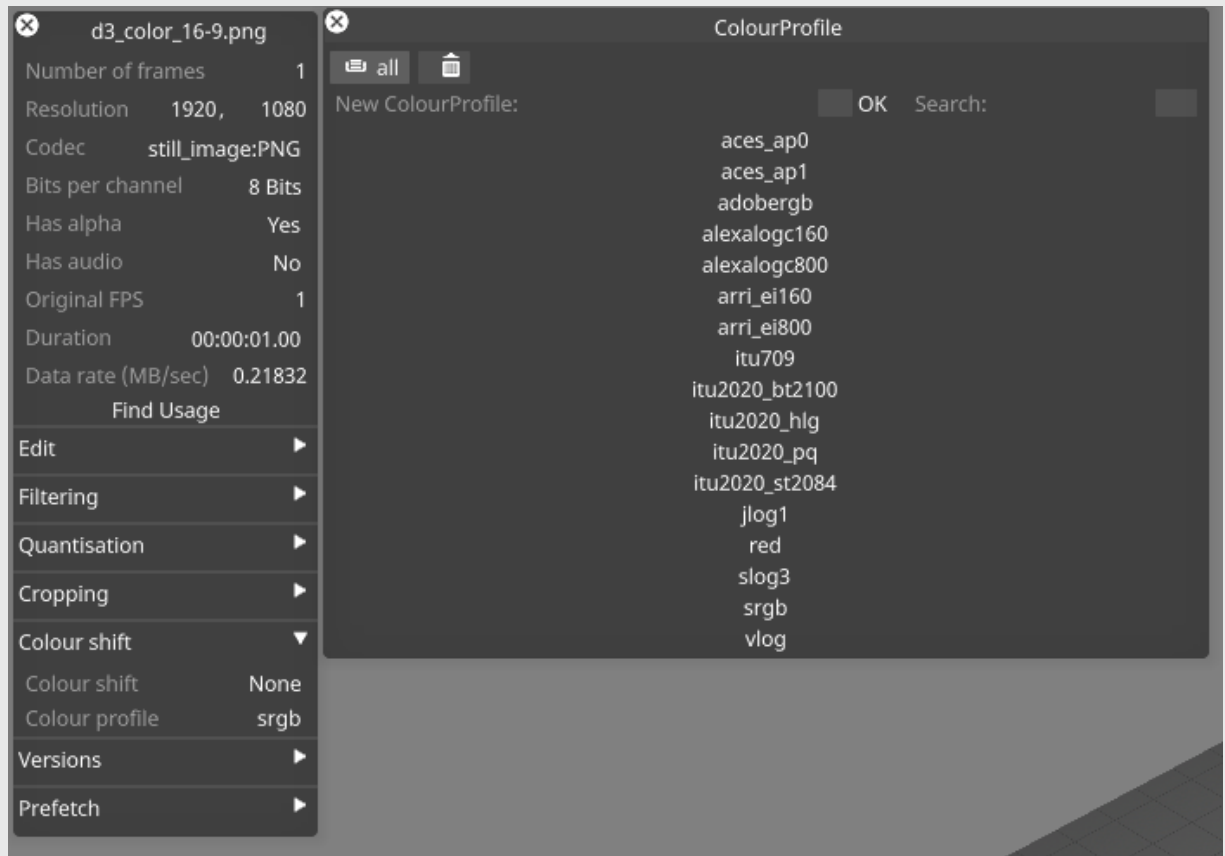

- Enter a the name for your new profile in the naming field.
- Hit Enter or click OK.
- In the profile editor, specify your Colour space and Gamma curve.

**d3\_color\_16-9.png**

Number of frames 1

Resolution 1920, 1080

Codec still\_image:PNG

Bits per channel 8 Bits

Has alpha Yes

Has audio No

Original FPS 1

Duration 00:00:01.00

Data rate (MB/sec) 0.21832

Find Usage

Edit ▶

Filtering ▶

Quantisation ▶

Cropping ▶

Colour shift ▼

Colour shift None

Colour profile new cp

Versions ▶

Prefetch ▶

**new cp**

Name

Colour space ITU-R BT.709

Gamma curve sRGB

Tone mapping None

Paper white

Maximum luminance

Gamma level

# Colour picker

## Overview

An ink dropper tool is available on the colour picker UI to enable users to select colour instead of manually looking for the colour by RGB. The ink dropper tool makes keying using colour parameters easier.

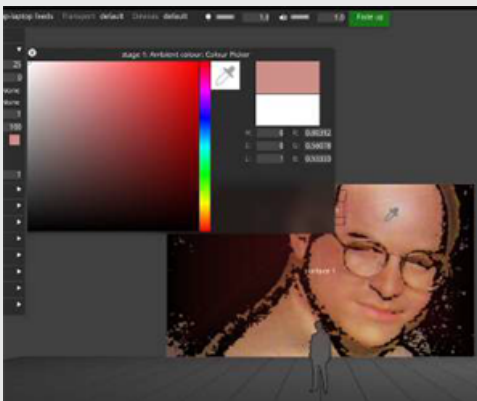

## Workflow

### Understanding the Colour Picker

There are multiple ways to access the colour picker tool, for example;

Chroma Key Layer - Add Layer -> Effects -> Chroma Key -> Key Colour

The tool is also available within other modules such as, VideoIn Layer, Colour Adjust Module, Green Screen, DMX Screen and within the BitMap Module.





# Colour shifts

A colour shift is a discrete object within Disguise software that allows you to alter the colour properties of a piece of content.

## Applying color shifts to video clips

It is possible to attach a colour shift object to an individual video clip so that every time you use that video clip it will colour shift in the same way. You can then place these video clips onto the key-frame editor and sequence these video clips. To do this:

1. Create a Video layer.
2. Open the Video Clip editor by right-clicking on the media thumbnail in the layer editor.



- Note: making changes to properties of a clip alters the state of the clip, and any changes made will appear in each instance where the clip is used. For this reason, it is recommended to make a duplicate of the clip and then make changes to the duplicate, keeping the original in its unaltered state.

To duplicate the video clip, begin by right clicking the header of the clip options and typing the name of the new video clip into the **duplicate** text field and hitting **Enter** . You will notice the title bar of the Video Clip editor change; it is now the object editor for your new video clip. The video clip will also be added to the Video keyframe editor at the current playhead position.

4. Left-click **colour shift** from the Video Clip editor. This will open the Colour Shift manager showing a list of colour shift objects. The colour shift object assigned to a video clip may be untitled, in which case it is unique to that clip. Renaming the colour shift object will add it to the ColourShift manager, allowing it to be used by multiple clips.

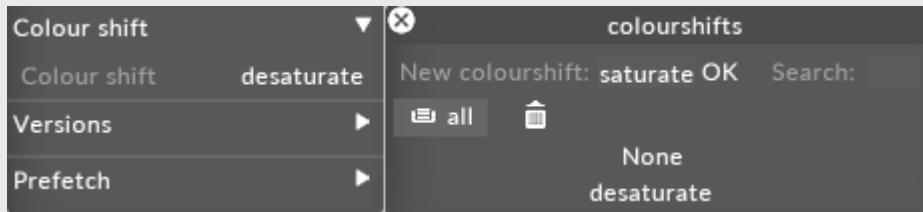

5. Create and attach the colour shift object to the video clip by typing the name of the new colour shift object, for example **desaturate**, into the **new colourshift** text field and hitting **Enter**. This will open the Colour Shift editor. For information on the Colour shift properties please visit the section 'Colour Shift' in the [Common layer properties](#) sub-chapter.

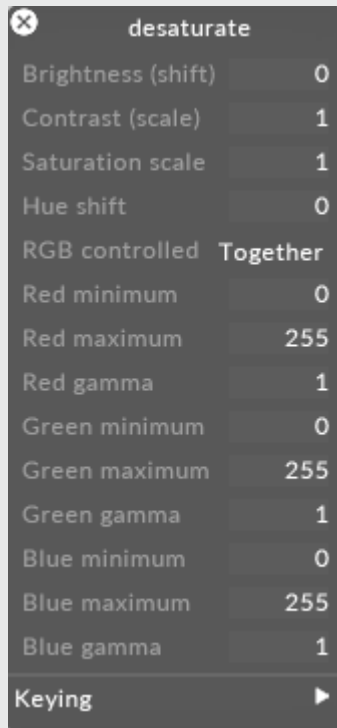

6. Edit the properties. In this example we have desaturated the video clip by decreasing the **saturation scale** property to 0.

# Transforms

Transforms are used to transform an image from one colour space to another

## Overview

### Input and Output transforms

#### Input transform

A formula or LUT mapping the values from a camera or stored in a file into the ACES colour space. Also known as the IDT.

#### Output transform

A formula or LUT mapping values from the ACES colour space to the output of a specific device or device specification, e.g. to PQ or HLG or rec709. The output transform is the collective name for the RRT and ODT.

By using transforms, you can ensure that your content will be displayed correctly on the displays.

# Workflow

## Input Gamma and Exposure Transforms

For video inputs it is possible to enter a number to specify a gamma transform (in **Input Gamma field**), or enter an amount in stops (in **Input Exposure field**) to make an image more or less exposed.

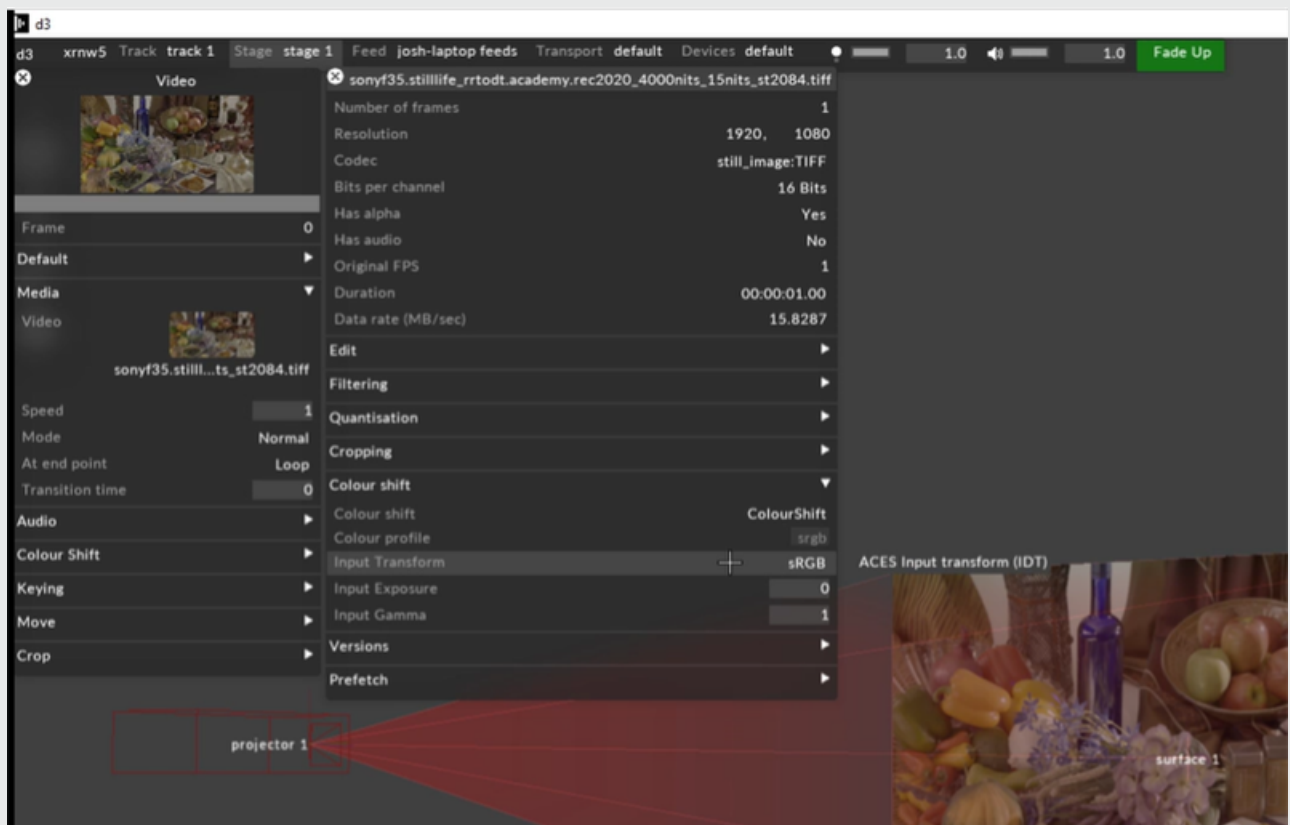

1. Open a Video layer
2. Right click on the media clip used on the layer
3. Open the video clip editor
4. Enter the number for Input Gamma or Input Exposure

All content inputs (i.e. video files, RenderStreams, anything that is coming into Disguise software that has color & has image data) has an “Input Transform” field. Upon configuring the input, you will see a dropdown list with the ACES standard list of colour spaces that are supported for input. This includes both scene-referred content derived from cameras (such as ARRI LogC), and display-referred content mastered to an output standard (such as ST 2084).

All display outputs have an “Output Transform” field. You will see a dropdown box with the ACES standard list of colour spaces that are supported for output; and you simply choose the appropriate one for your display.

Output Transform - ACES ODT (added on virtual devices such as camera and projector: Output → OT)  
Input Transform - ACES IDT (beneath: Video → Media → Edit media menu → Colour Shift → IT)

For video module: 2 fields were added: Beneath: Colour Shift - on video editor: Input Gamma-

Input Gamma Transform (IGT) - control the brightness (user can set less or more contrast using numbers) Input exposure -

Input Exposure Transform (stops) - (IET) - changing the brightness of the image accordingly: less exposure darker, more exposure: brighter, user can specify it by entering the number)

## Additional Information

### Differences between a Colour Transform and a Transfer Function

A given piece of content will have both a relationship to a colour space, which will be independent of intensity, and a function of some kind that describes how intensity is encoded into the colour values. So a colour transform will affect how colour is represented relative to the CIE colour diagram, while a transfer function will not. A transfer function will change the perceived intensity or contrast of an image, where a colour transform will not.



In addition to this, there are specifications such as rec709 and sRGB that define a colour space as well as a transfer function, as well as transfer functions that are independent of colour space and colour spaces that are used independently of transfer functions.

### **Linear Transfer Function**

When we say an image is 'linear', we mean that the transfer function is linear, i.e. there is no curve applied and a value that is twice another value will be twice as intense. This is useful for mathematical accuracy in visual effects, but is inefficient for display.

### **Curves**

The sRGB and rec709 curves are closely related but different, although they're often used interchangeably with each other as well as with a 2.2 gamma curve. This is the most common curve in graphics and is the current 'default' curve in Disguise software, which content is assumed to be in if no other choice is specified.

The PQ and HLG curves are for displaying HDR content on HDR displays.

Camera-specific formats, as well as ACEScc, are "log" formats that use a log curve on intensity.

# ACES

The Academy Colour Encoding System (ACES) is a colour space management workflow specifically designed to make capturing and displaying video in the correct colour format easier to achieve in film pipelines.

## Overview

ACES (Academy Color Encoding System) is an open device-independent color management and image interchange system. It enables creation of digital masters suitable for long term archiving. It is also a set of developer tools: a suite of encoding specification, transform definitions and guidelines, archive-ready image data and metadata container specification. In simple language - it allows color transformation/ conversion across screens.

Supporting ACES inside of Disguise software allows Disguise to be used as part of a colour-managed workflow alongside other ACES-compatible software such as Davinci Resolve, Autodesk Maya, Foundry Nuke and Unreal Engine.

For more information on colour spaces and colour management please visit this [link](#).

## Why does ACES define multiple colour spaces?

To be able to transform between these spaces, a space wide enough to contain the entirety of both the larger space and the smaller space is required. To this end, ACES defined the AP0 colour space, used in ACES-2065-1, which is the largest red triangle in the diagram. It is intended to be a futureproof archival colour space and so contains all possible colours in the CIE diagram, but in a red, green, blue triple rather than the more awkward CIE XYZ format.

For day-to-day use, ACES also defines the AP1 space, which is intended to be larger than all colour space formats currently in use (i.e. rec2020 and P3-DCI). AP1 is used in the ACEScc, ACEScct and ACEScg spaces.

ACES defines multiple different colour spaces, each with their own intended purpose:

- ACES-2065-1 is the only space using the AP0 colour primaries. It is intended for transforming between different ACES colour spaces, and for archival purposes.
- ACEScc uses the AP1 colour space with a log-based transfer function and is intended for use as an intermediate format in colour grading, where a log curve is preferred to preserve maximum detail in brightness gradients.
- ACEScct is identical to ACEScc but with a “toe” that keeps black values away from zero.
- ACEScg uses the AP1 colour space with a linear transfer function and is intended for use as an output format for graphics renderers, which produce linear output natively.
- ACESproxy is similar to ACEScc but is specified for fixed-point output rather than floating-point output, in the case where floating-point transport is not available, e.g. if the image must be transferred via SDI. Note that Disguise does not implement ACESproxy.
- Each of these colour spaces has specific strengths for specific workflows.

Disguise works in ACES-2065-1, for maximum compatibility with these as well as other colour spaces users may require.

## Workflows

### Within Disguise

1. Right-click the d3state editor in the dashboard and select **Project settings**
2. Set the **Colour management** option to ACES. The transform options will not be available unless the project is set to ACES mode.

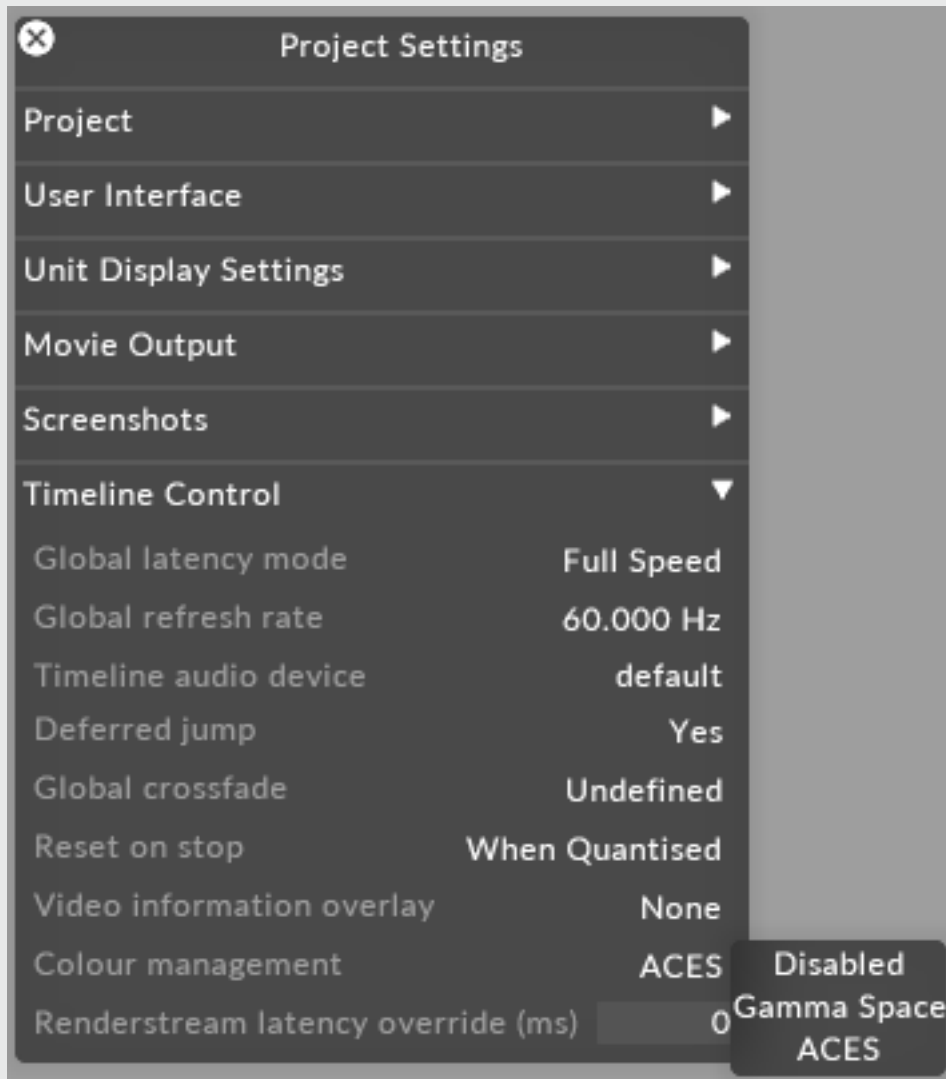

3. On every video clip/asset, right click on the thumbnail from the **Media** field of any content layer.
4. Expand the **Colour shift** tab.
5. Set the **Input transform** to the format that the content was authored in.

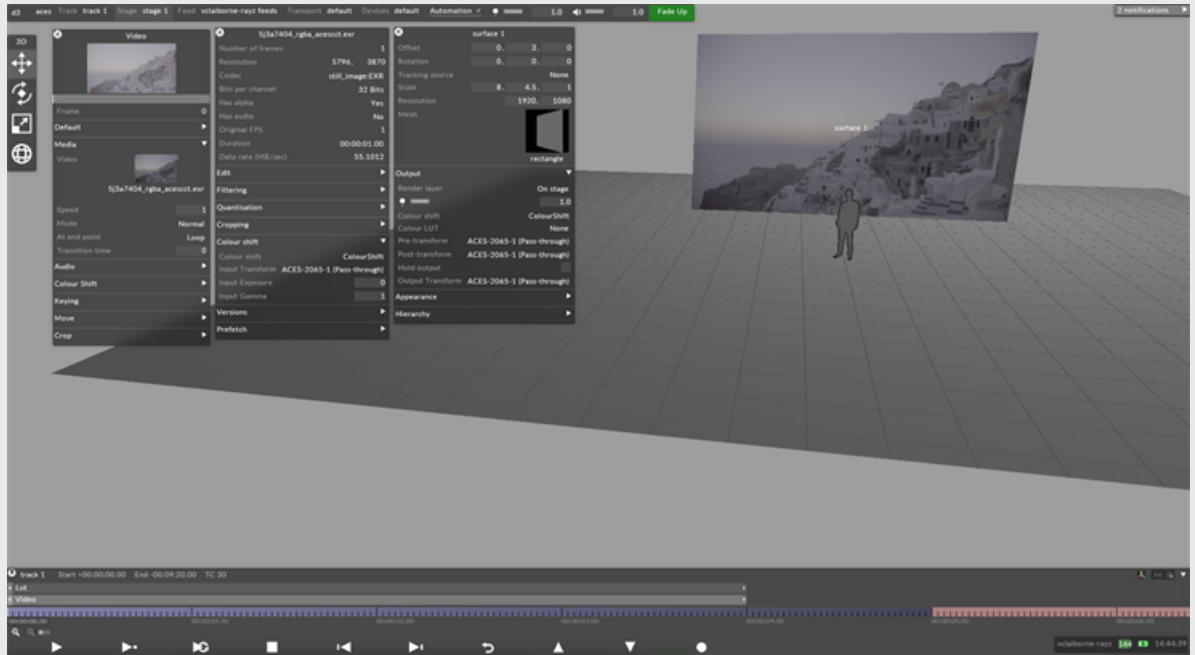

6. The content should reflect more accurately in the visualizer.

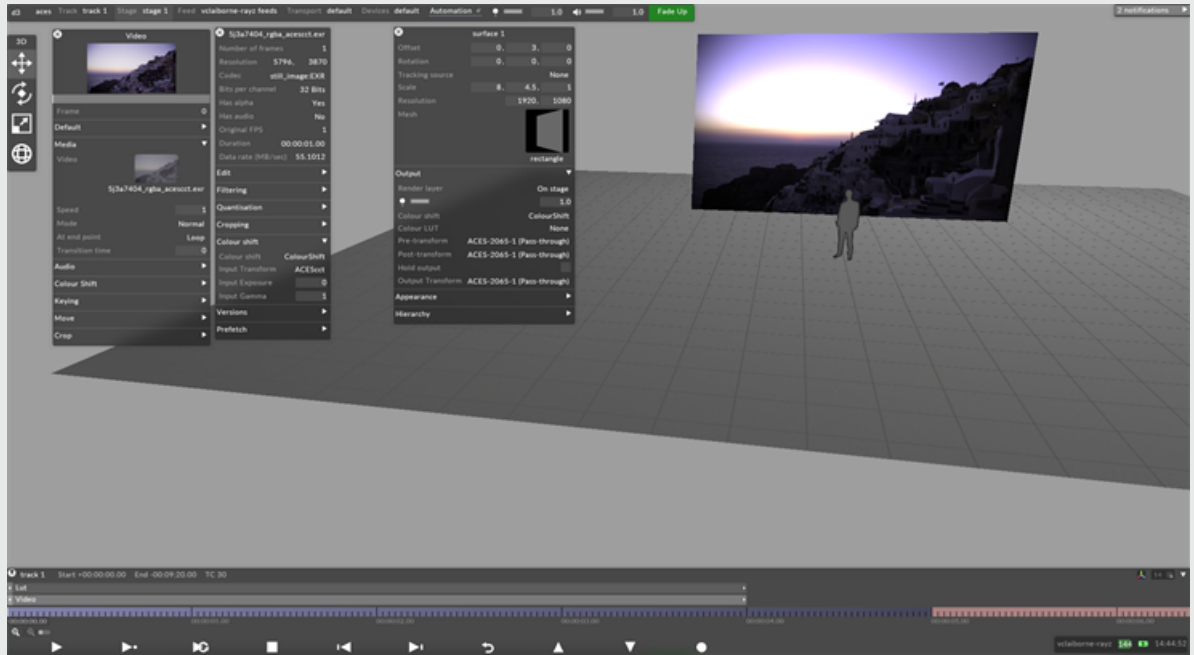

Note that you can view the content library in table form and use **Select All** to bulk change a whole folder.

7. On all LED screens in the visualizer, right click and set the **Output transform** to the desired format for the LED processors.

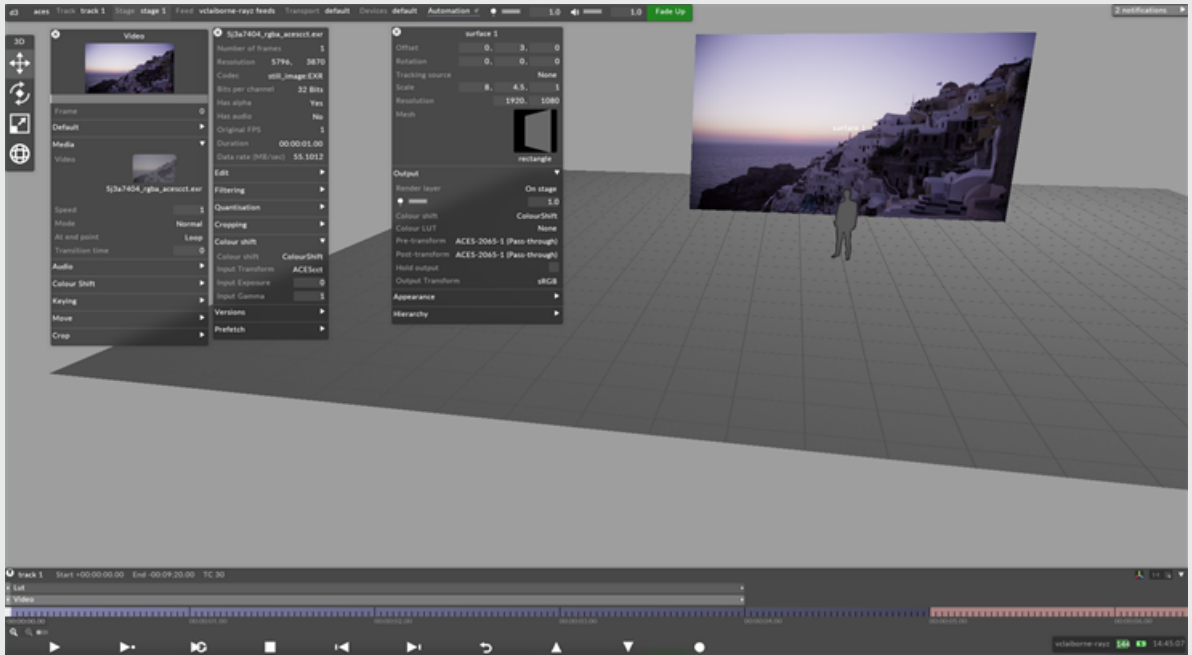

Note that all screens can be bulk selected from the stage editor and edited at once.

8. Optional: A LUT file can be applied using a LUT layer.

**Please note:** In previous versions of disguise, LUTs had to correspond with the colour space of the project. Now in the LUT layer, a pre and post transform can be applied to mix LUTs and colour spaces by conforming to the ACES workflow.

### On the connected hardware

1. Set the **output transform** to match the chosen format set on the LED screen objects.

**Please note:** Note that Disguise does not embed any HDR metadata in the video signal so the display device must be set at the other end to the matching format.

Additional notes:

- Author any static video content in the colour space and gamma curve that you are intending to use.
- For true HDR video playback from video content, a DPX 10-bit image sequence is best.
- For Generative Layers there is no Input Transform to pick.

## RenderStream-Render Engine Workflow

If the disguise project is configured for ACES transforms, the incoming RenderStream content from a third party render engine can be configured to HDR for compatibility. In this example we demonstrate with Unreal, but the ACES workflow may also be used with other render engines.

1. Choose your colour space in Unreal
2. Set Execute Console Command nodes:
  - **r.HDR.Display.OutputDevice**
  - **r.HDR.Display.ColorGamut**
3. Set after **Event BeginPlay** in the project blueprint: these settings tell the project to output in this format when the stream begins.

### In the disguise project

1. In the **Project settings**, set the **Colour management** option to ACES.
2. In the RenderStream Layer layer in Disguise software, right click the asset to enable ACES Colour Management and set transform to the incoming format as determined in the Unreal output settings.



**Please note:** The **ACEScg** format is tested in house and supported by Unreal for 10bit and HDR.

3. On all LED screens in the visualizer, right click and set the **output transform** to the desired format for the LED processors.

**Please note:** Note that all screens can be bulk selected from the stage editor and edited at once.

### On the connected hardware

1. Set the output transform to match the chosen format set on the LED screen objects.
2. Note that disguise does not embed any HDR metadata in the video signal so the display device must be set at the other end to the matching format.

## ACES and the colour-managed workflow

ACES intends to provide a universal base for a colour-managed workflow, replacing individual bespoke systems, to allow for accurate interchange between organisations as well as within, and for archival purposes.

ACES makes use of two important core concepts, “display-referred content” and “scene-referred content”. Before your content enters an ACES pipeline, generally, it is “scene-referred”. Once it has left the ACES pipeline, generally, it is “display-referred”.

Content which is produced by a camera or by a 3D renderer is “scene-referred”; that is, the values stored in the image are interchangeable only with other images from that camera or renderer using the same settings.

By contrast, “display-referred” content has a direct relationship between the values stored in the image and the expected colour and intensity of the image when displayed on a calibrated display.

As a user of imaging software outside of a colour-managed workflow, there are some unintuitive aspects of using a colour-managed workflow. The ACES pipeline is designed to bring your content from designated input or intermediate formats, such as ARRI LogC, Canon CLog3, or ACEScg to

designated display output formats such as sRGB, rec2020 or P3-DCI. While ACES provides transforms for bringing output content back into ACES space, and these transforms are often necessary (e.g. if you have a camera that outputs rec709 content), the intention is that the pipeline is end-to-end with a single output stage. Bringing display-referred content into ACES and putting it through a pipeline again is not transparent.

Visit this [link](#) for a helpful ACES colourspace to RGB converter.

# Histogram

## Overview

The histogram shows the number of pixels that are a certain value.

Histograms are mainly used to verify the end-to-end signal of an image. This is particularly useful when there is a known value in the content, and we want to make sure that it remains at that value throughout the signal chain.

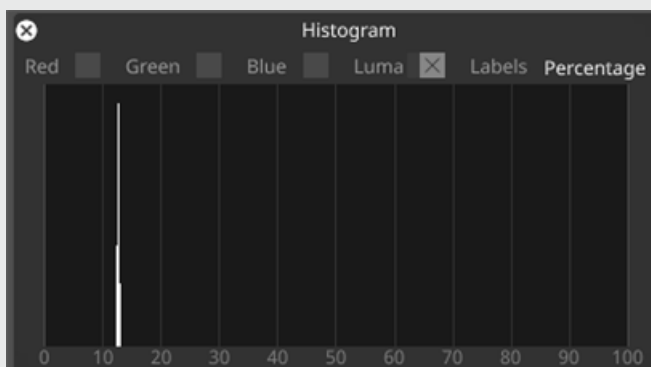

## Opening the Histogram

A histogram can be used to verify the signal chain at these points:

- On a Video Input within the Video Input patch Editor- After capture into disguise and any layer stack modifications
- The feed output - after being transformed into the final 8- or 10-bit format going to the display

1. Open the Feed Output window by clicking on Feed in the dashboard
2. Right click on the border of an output to open the Output Properties window

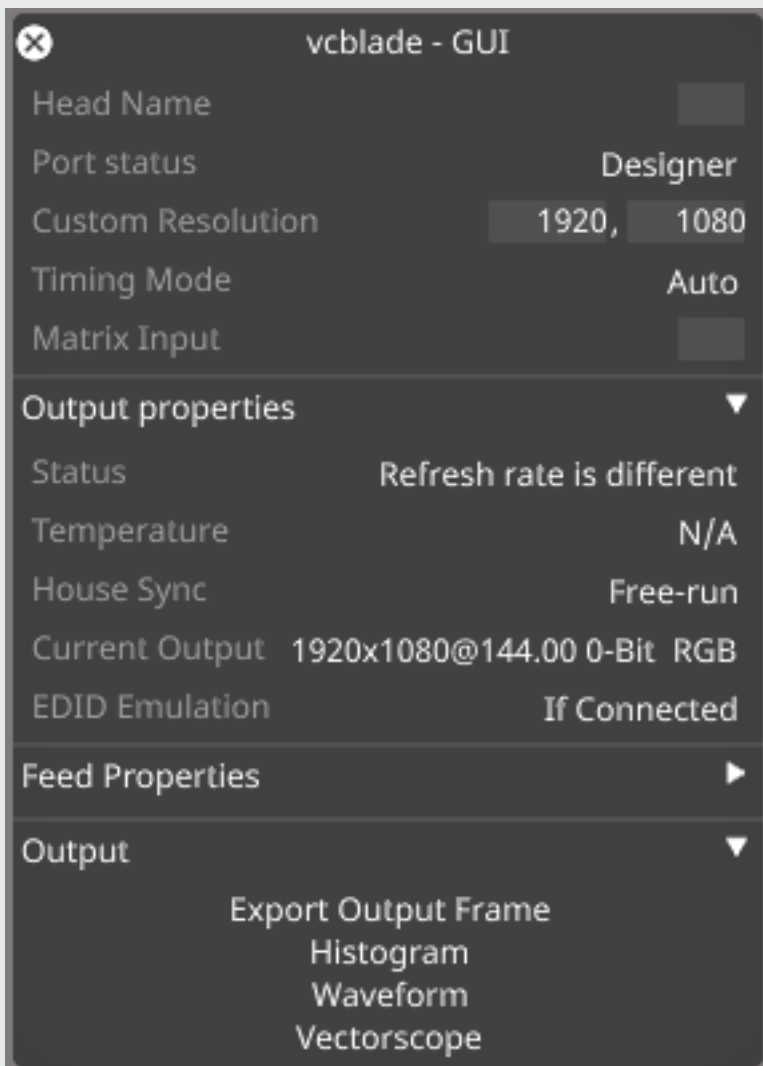

3. Click on Histogram in the Output tab

## Workflow

### Understanding the Histogram

The histogram can take its value either from the red, green or blue channels, or from the combined luma value i.e. brightness:

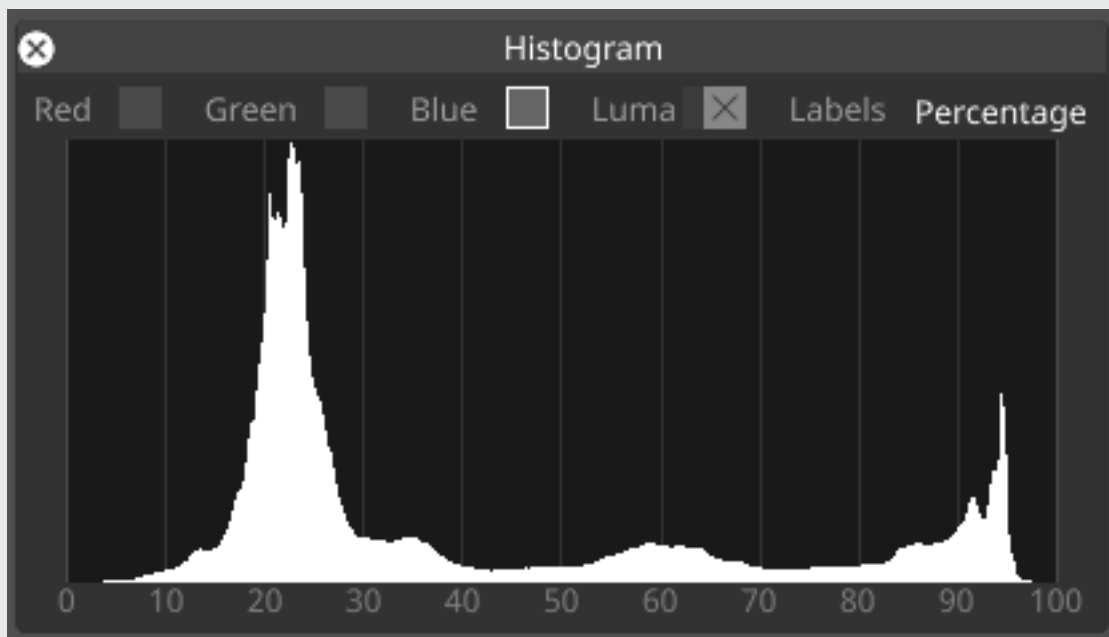
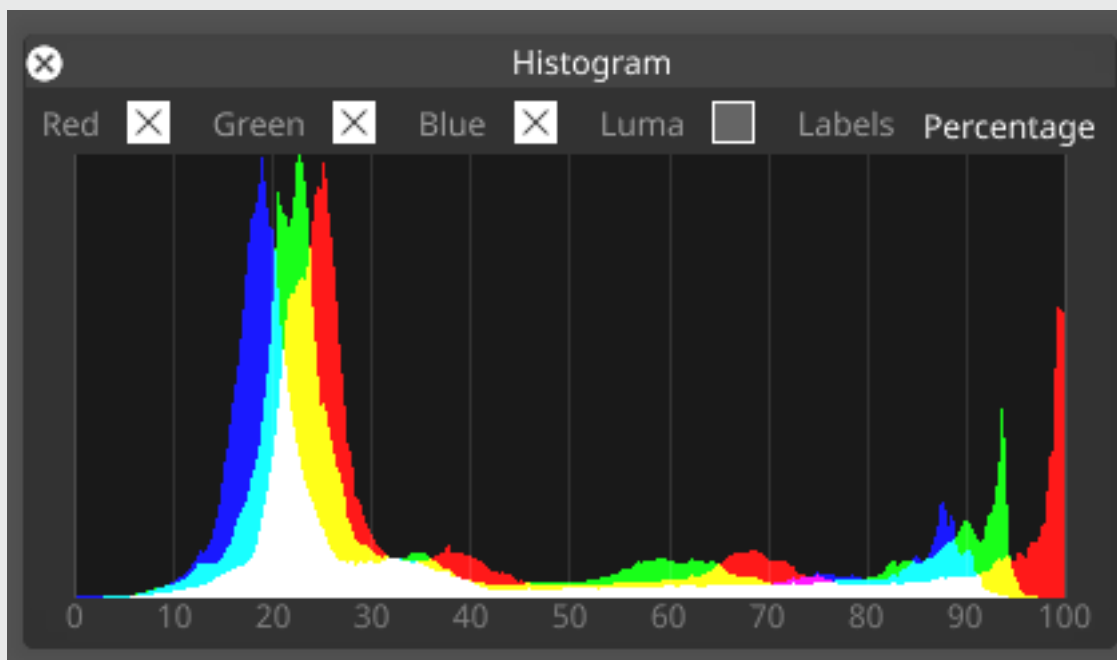

- The horizontal axis shows the value
- The vertical axis is the percentage of pixels at that value.
- The left side of the histogram is the lowest value (e.g. black)
- The right hand side is the highest value (e.g. white).
- A peak means that the majority of the image is at that value

The horizontal axis can be :

- Unlabeled
- Labeled by raw value (0..255 for 8-bit images, 0-1023 for 10-bit images, 0..1 for floating point images)
- A percentage from 0 to 100
- A nit value on the Perceptual Quantizer (PQ) scale – which is common for HDR outputs

# LUT files

A LUT can be used as a Pre or Post transform

## Overview

### LUTs

**From r21, Designer's LUT Format Support has expanded.**

When calibrating LED screens for large VP volumes, industry-standard solutions use two sets of LUT files - a 1D LUT for adjusting brightness, contrast, and gamma, and a 3D LUT file for adjusting colors. Initially, only 3D LUT was supported, and meant that manual adjustments still had to be made on the LED processor to achieve a linear color reproduction.

From r21, Designer also supports **1D LUT** files. View the **Workflow** tab on this page for more details.

Prior to r18, LUTs were essentially defined by the context they were used in. A user entering a LUT layer on the timeline was expected to have authored the LUT to transform from whatever space the image they were connecting to was in, and the output was expected to either be in sRGB or some other colour space that the user was going to manually preserve through Disguise software to output.

With ACES enabled, LUTs now have a pre- and post-transform option, so the user can specify which space the LUT expects to receive and which space will be output from the LUT, and Disguise software will be able to convert that content safely back into the ACES-2065-1 space Disguise software uses internally, for output via any one of the output transforms.

Applying a pre and post transform has now moved from the LUT layer to the LUT itself.

## Supported LUT file types

We support:

- **.spi1d** and **.lut** for **1D LUTs**
- **.spi3d** and **.3dl** for **3D LUTs**

.cube files which can be 1D or 3D

## Workflow

### Expanded LUT Format Support:

1. Acquire a LUT in each of the new file formats and place them within the lutfiles folder within a d3 project.
2. Launch a Designer project.
3. Create a LUT layer and open the editor.
4. Confirm that the files placed within the LutFiles folder have appeared as LUT objects.
5. Create a video layer, assign some content and arrow it into the LUT layer.
6. Assign each LUT in turn to confirm that the expected LUT effect appears on the targeted display.

### LUT Layer Colour Management:

Inspect the LUT layer, and then inspect the LUT assigned to the layer, and there access the Colour Management options.

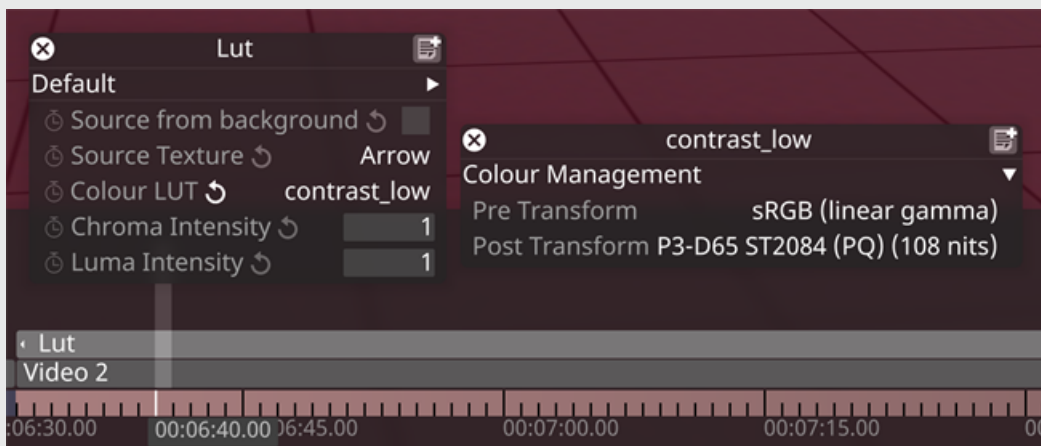



# Example

## Example 1

LUTs generated from Davinci Resolve in ACES mode operate on the ACEScc colour space.

So, a user can generate a cube LUT from Resolve, then specify the pre- and post- transforms in the LUT within Disguise software to “ACEScc”.

Disguise software will transform the content from the ACES-2065-1 space to ACEScc, apply the LUT, then transform the output content from ACEScc back to ACES-2065-1 space.

# Vectorscope

As of r21, it's possible to see if you're going out of the scopes of your colour space.

## Overview

The Vectorscope plots the chroma of the image. Chroma is the colour information that is left when you remove the luma. This would typically be used to confirm colour accuracy against known test patterns, or to colour correct images objectively.

## Vectorscope Overlays

The Vectorscope has two overlays that can be combined or used separately:

- RGBCMY - red, green, blue, cyan, magenta, and yellow markers at 75% or 100% saturation
- IQ lines - aka the "skin tone" line, which can be used to correct skin tones

## Workflows

To open the Vectorscope on an Output:

1. Open the Feed Output window by clicking on Feed in the d3 dashboard
2. Right click on the border of an output to open the Output Properties window

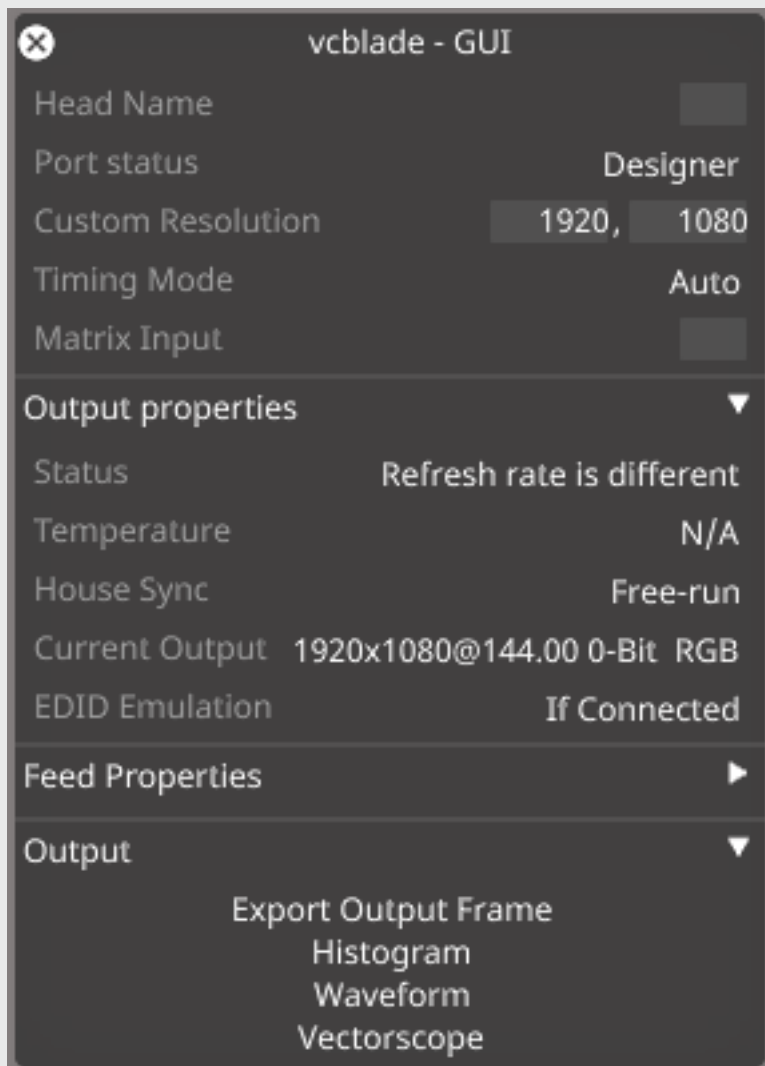

3. Click on Vectorscope in the Output tab

The vectorscope may also be opened on a video input by opening the Video Input Patch Editor and then right clicking on a local input's thumbnail

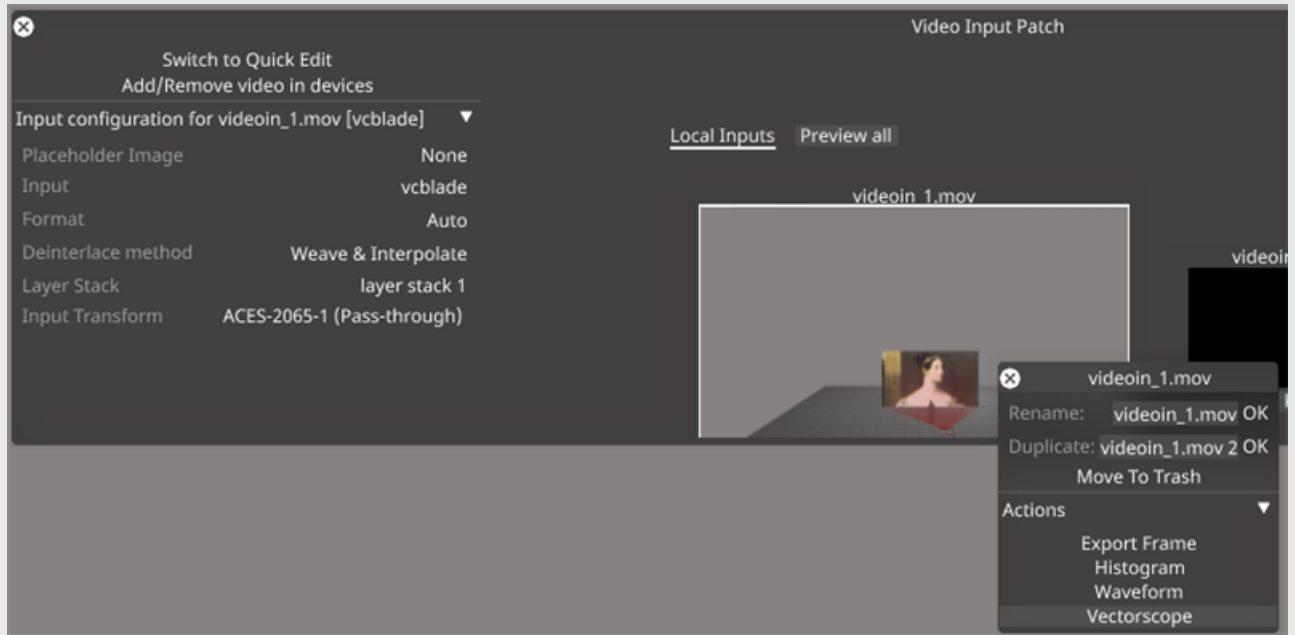

## How to Use the Vectorscope

This graph is a circular UV plot indicating where each additional pixel hitting at the same point additively increases intensity.



# Waveform

## Overview

The waveform is a histogram for each column of pixels in the image.

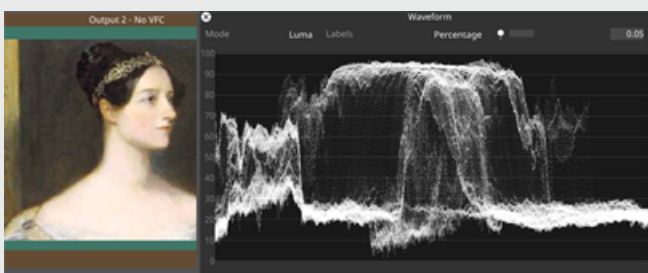

## Opening the Waveform scope

A waveform scope can be used to verify the signal chain at these points:

- On a Video Input within the Video Input patch Editor- After capture into disguise and any layer stack modifications
- The feed output - after being transformed into the final 8- or 10-bit format going to the display
  1. Open the Feed Output window by clicking on Feed in the dashboard
  2. Right click on the border of an output to open the Output Properties window

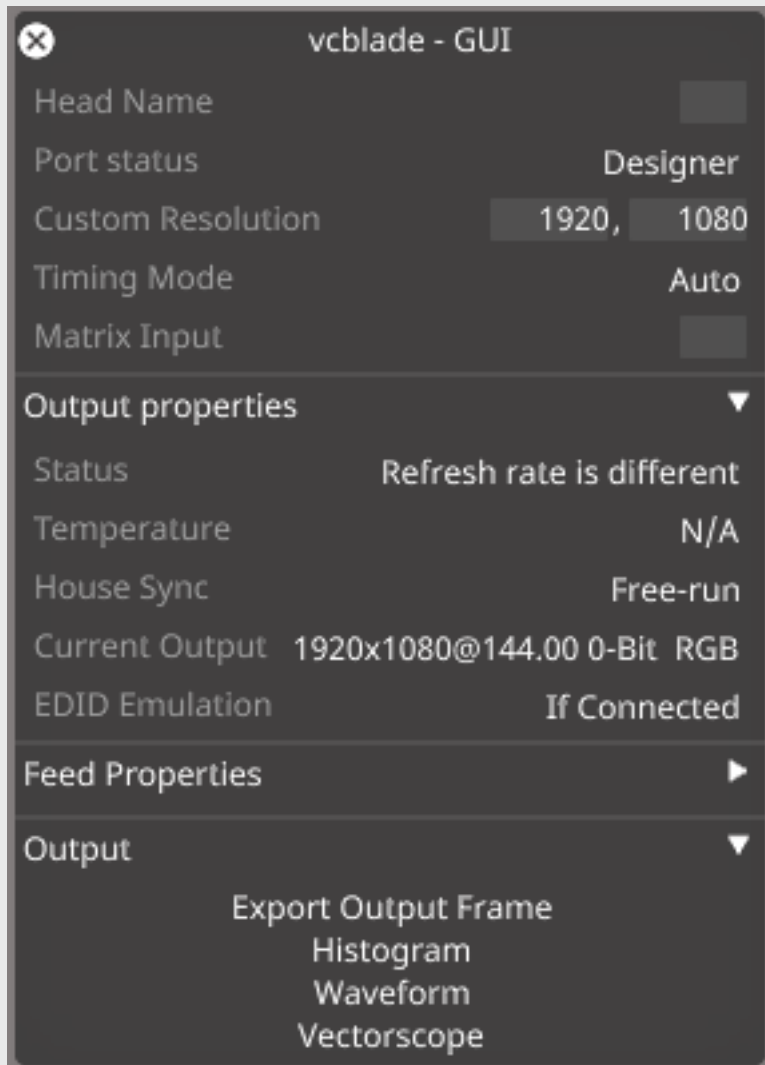

3. Click on Histogram in the Output tab

For more information on Histograms, please visit [this link](#).

## Workflow

### Understanding the Waveform

Waveforms are typically used to ensure that the image is within safe limits i.e. above a minimum black level or below a maximum white level, and are also used to balance the red, green and blue channels.

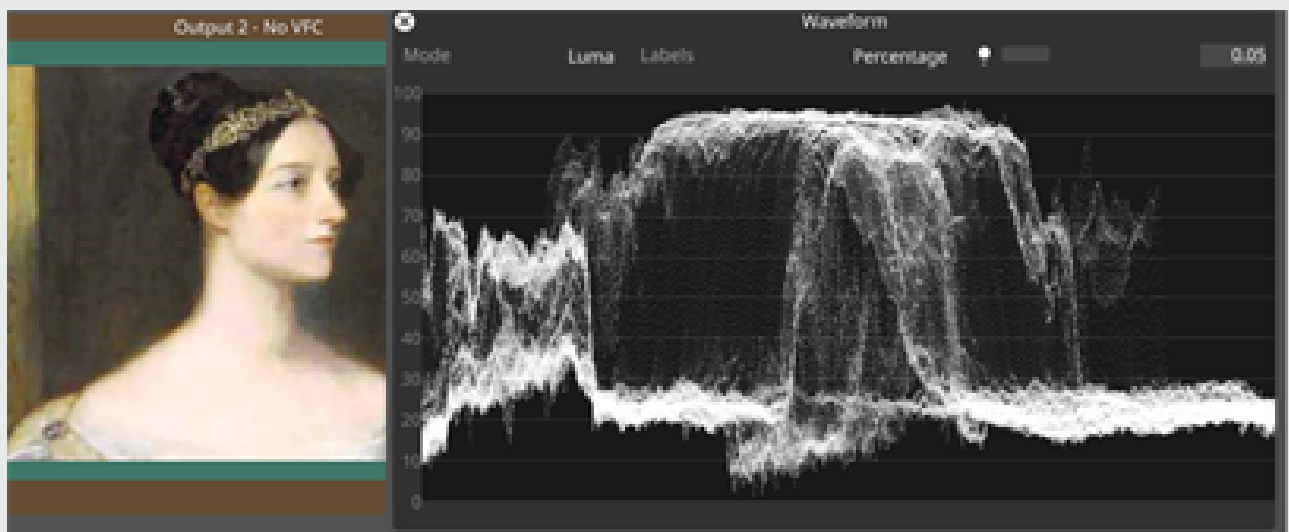

- The horizontal axis is the same as the image's horizontal axis i.e. left of the waveform is the left of the image, and right of the waveform is the right of the image. This means that panning the image will have the same pan effect on the waveform.
- The vertical axis is the value of the pixel. Down on the waveform vertical axis is the lowest value (e.g. black), and up is the highest value (e.g. white).
- The brightness at each point in the waveform is the amount of pixels at that value.

The waveform has three modes which can be accessed by clicking on the 'Mode' button on the waveform:



- Luma - (shown above) the same brightness value from the histogram
- RGB - red, green and blue values are overlaid on each other

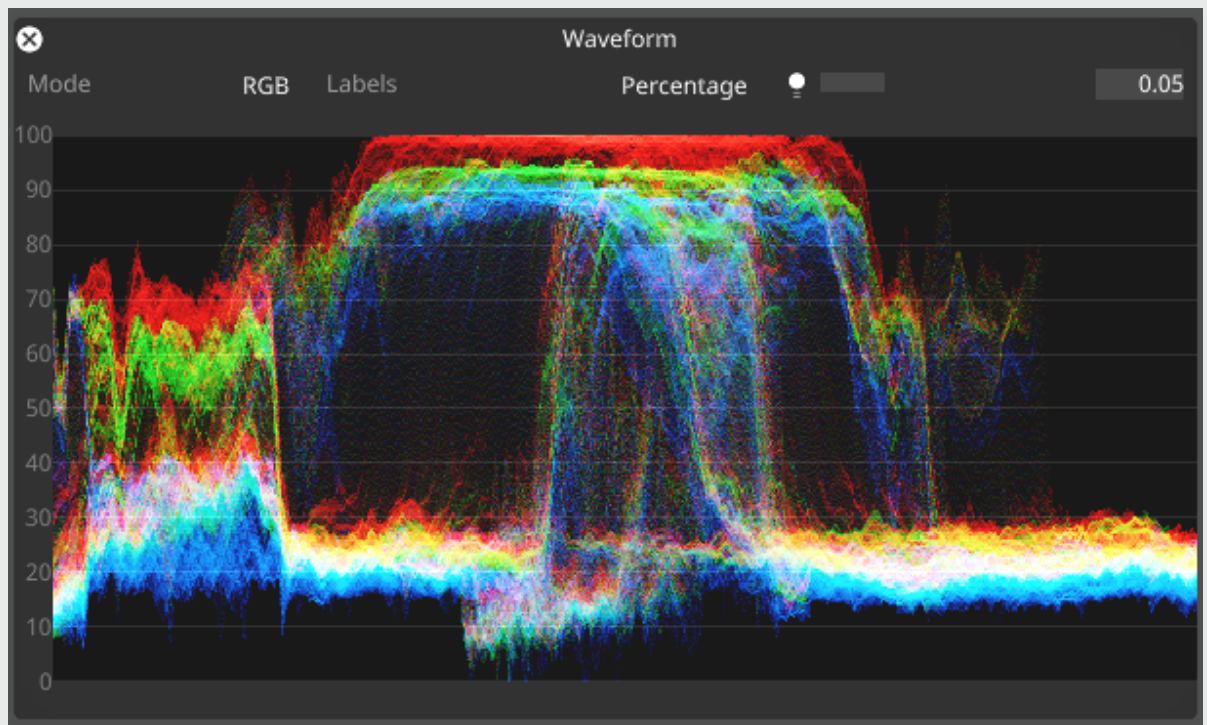

- Parade - red, green and blue values side-by-side

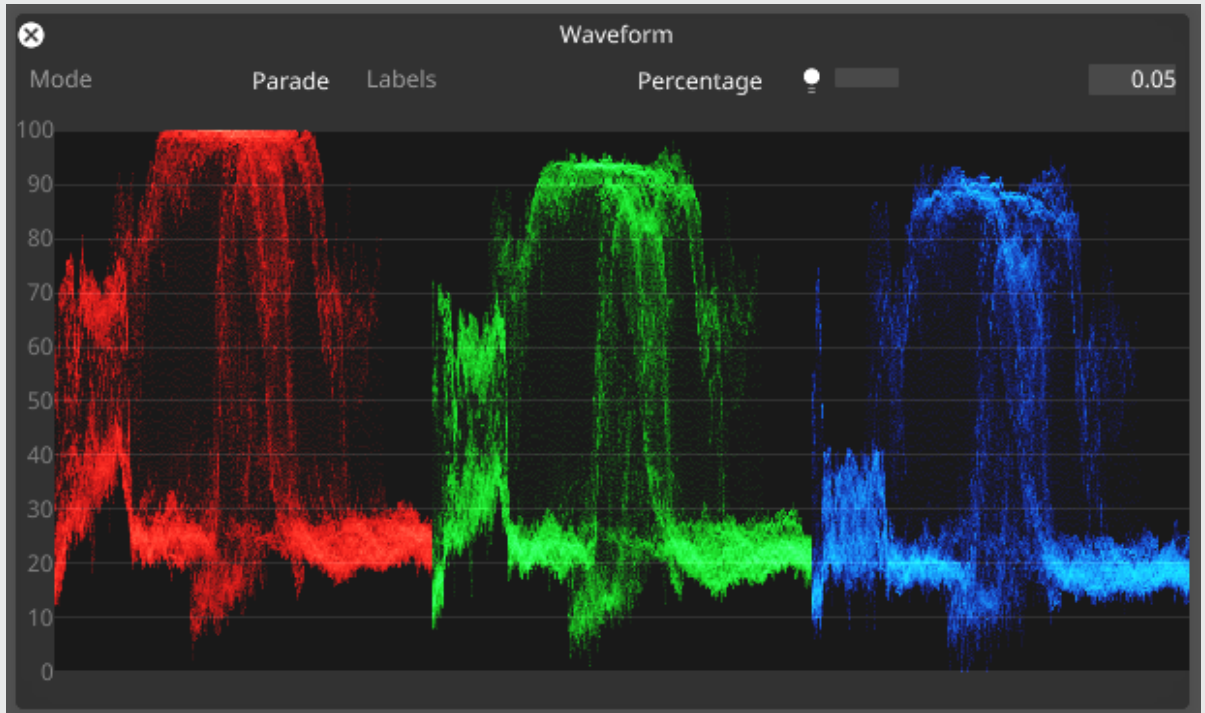

The values of the waveform can be presented as a value, a percentage or as PQ nits.

# Rendering media overview

## Stage/Feed movies

Stage movies and Feed movies can be rendered in d3. Stage movies can be used to provide the client or production team with the latest update on the project, and Feed movies allow rendered project content to be played back on a conventional media server.

Before rendering the Stage/Feed movies please specify the video output settings by reading the following sub-chapter [video output settings](#).

## Screenshots

If there is not enough time for rendering a movie screenshots can be made. See the [rendering screenshots](#) topic to see how.

# Video output settings

Before rendering a Stage or Feed movie it is important to set the size, frames-per-second and codec used for the output video. To do this:

1. Open the Program Settings menu by right-clicking **d3** from the dashboard (bar at the top of the screen).
2. Select **Project settings...**
3. The **Movie Output** section contains the properties used to specify the settings of the Stage/Feed movie.

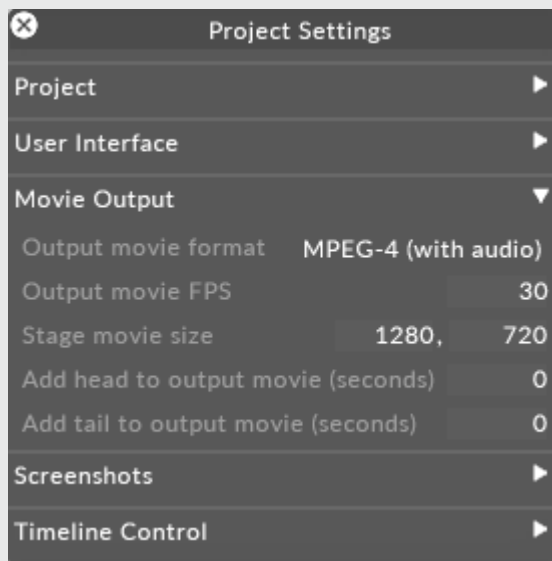

## Movie Output properties

### Output movie format

This selects the codec for the video. Options are: **Photo- JPEG (no audio)** , **Animation (no audio)** , **.mp4 (with audio)** , or **Photo- JPEG mov ( OLD quicktime players)** . Only the **.mp4** option writes audio to the file. In general, the first two options are used for writing Feed movies for playback since they do not need audio. The **.mp4** option is used mainly for Stage movies since Stage movies most likely need audio and also need to be as compact as possible to be sent via the internet.

## Output movie fps

The output movie speed, in frames-per-second. Any frame-rate can be used, but common values are 24, 25, 29.97 or 30.

## Output movie size

The output movie size, in pixels.

## Add head to output movie (in seconds)

This option will add an extra number of seconds to the beginning of the file. This can be useful when writing out short sections for playback on other systems.

## Add tail to output movie (in seconds)

This option will add an extra number of seconds to the end of the file. This can be useful when writing out short sections for playback on other systems.

# Rendering screenshots

Screenshots can be made of the Stage or Feed levels.

These can be used for:

- allowing the client or entire production team to know exactly what the latest update is on the project, particularly if there is not enough time for rendering Stage movies.
- matching the position of the Feed rectangles in their Display heads to an LED processor when configuring outputs.

## How to make a screenshot:

1. Specify the file format used for saving screenshots as described in the section below.
2. If the Track Player is obscuring part of the shot close it by left-clicking the x icon in the top left corner of the Track Player. To re-open the Track Player, left-click **track** in the d3 State editor (bar at the top of the screen).
3. Hit **Alt-X**. The screenshots are saved in a new folder called **screenshots** inside the specific Project folder. For information on where the specific Project folder is located please see the sub-chapter Projects location/structure. To learn the other d3 shortcuts please see the sub-

## chapter Shortcuts.

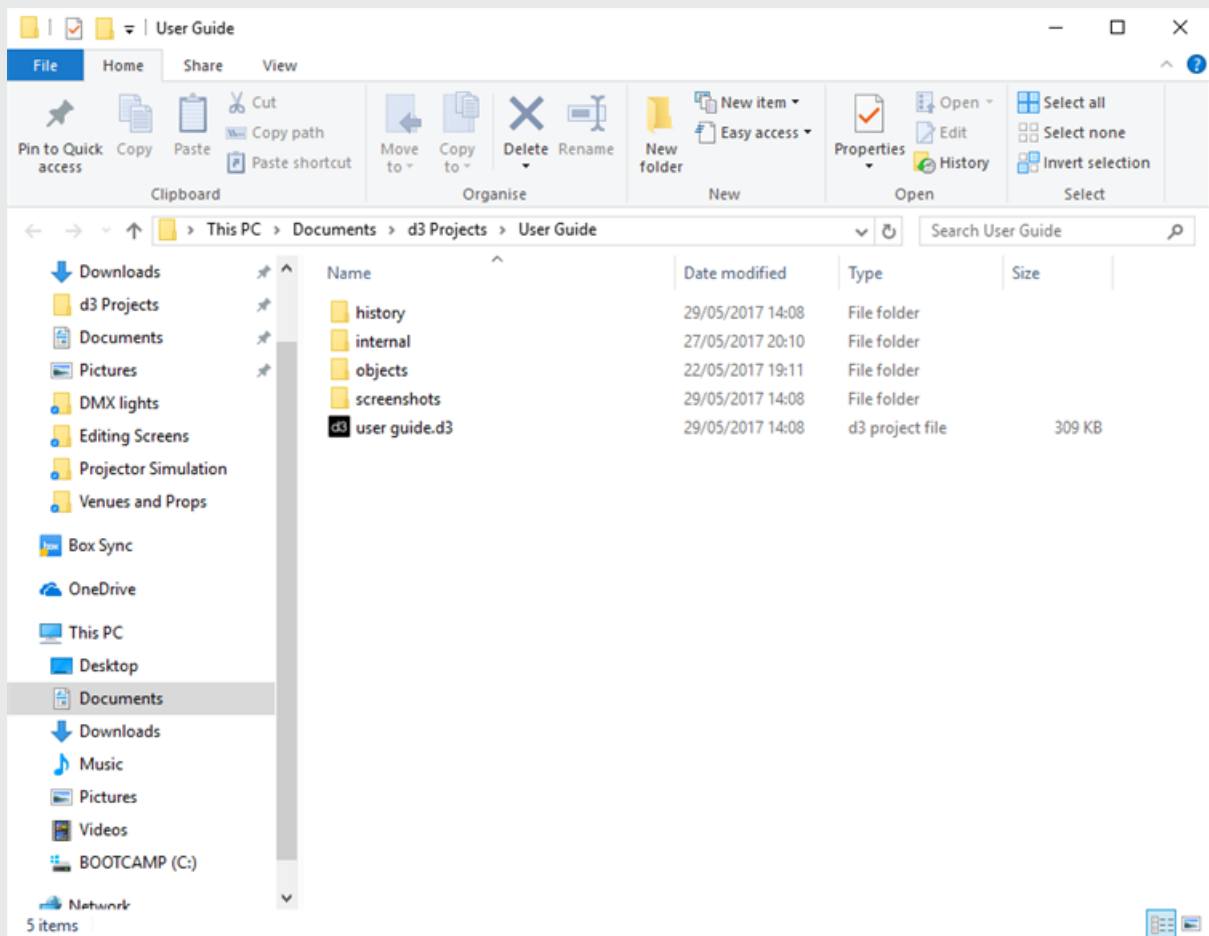

**Warning:** it is recommended not to delete or rename screenshots in the **screenshots** folder. If screenshots are renamed or deleted, ensure the screenshots ascend numerically in name with no gaps, for example 'screenshot\_00000', 'screenshot\_00001', 'screenshot\_00002', otherwise the most recent screenshot will be overwritten and lost when a new screenshot is made.

## Specifying the screenshot file format

1. Open the Projects Settings menu by right-clicking **d3** from the dashboard (bar at the top of the screen) and selecting project settings.
2. In the **Screenshots** tab, Select an option from the menu of file formats by left-clicking **output format**. There are five file formats to choose from: **.png .jpeg .bmp .tif .dds**.

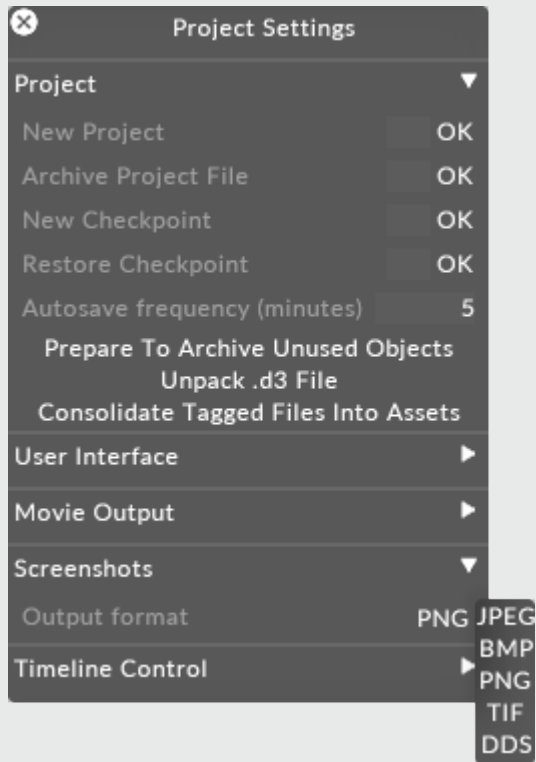

Output Screenshot Format property within the Program Settings menu points to the five screenshot file saving formats



# Rendering Stage movies

Stage movies render the content in the Stage levels Stage Visualiser, allowing the client or entire production team to know exactly what the latest update is on the project.

**Please note:** before rendering a Stage movie the AnimateCamera2 layer can be used to create camera fly-throughs of the show. Please see the [AnimateCamera2 layer](#) sub-chapter for more information.

## How to render Stage movies

1. Specify the settings of the Stage movie as described in the previous sub-chapter [video output settings](#).
2. Hold down the left **Shift** key and click-drag a rectangle across the Track bars to be rendered.
3. Open the Track bars menu by right-clicking the selection rectangle.
4. Type in the name of the Stage movie into the **write movie (stage)** text field.

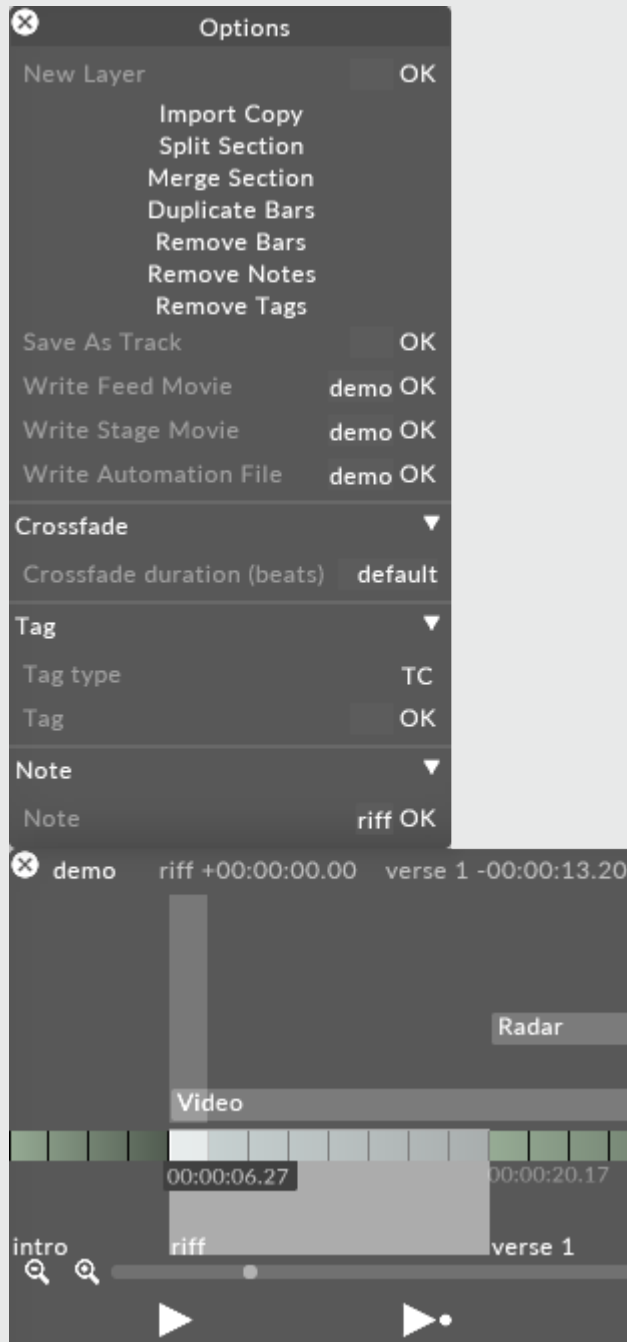

5. Hit **Enter** to render the Stage movie. The Stage movie will be saved in a new folder called **output** inside the specific Project folder. For information on where the specific Project folder is located please see the sub-chapter [Projects location/structure](#).

If there is not enough time to render a Stage movie screenshots of the stage may suffice. For more information on this useful feature please see the [rendering screenshots](#) sub-chapter.

# Rendering Feed movies

Feed movies render the feed outputs in the Feed level, allowing rendered project content to be played back on a conventional media server.

For more information on configuring outputs please see the chapter [Output Feeds](#).

## How to render Feed movies

1. Specify the settings of the Feed movie as described in the previous sub-chapter [video output settings](#).
2. Hold down the left **Shift** key and click-drag a rectangle across the Track bars to be rendered.
3. Open the Track bars menu by right clicking the selection rectangle.
4. Type in the name of the Feed movie into the **write feed movie** text field.
5. Hit **Enter** to render the Feed movie. The Feed movie will be saved in a new folder called **output** inside the specific Project folder. For information on where the specific Project folder is located please see the sub-chapter [Projects location/structure](#).

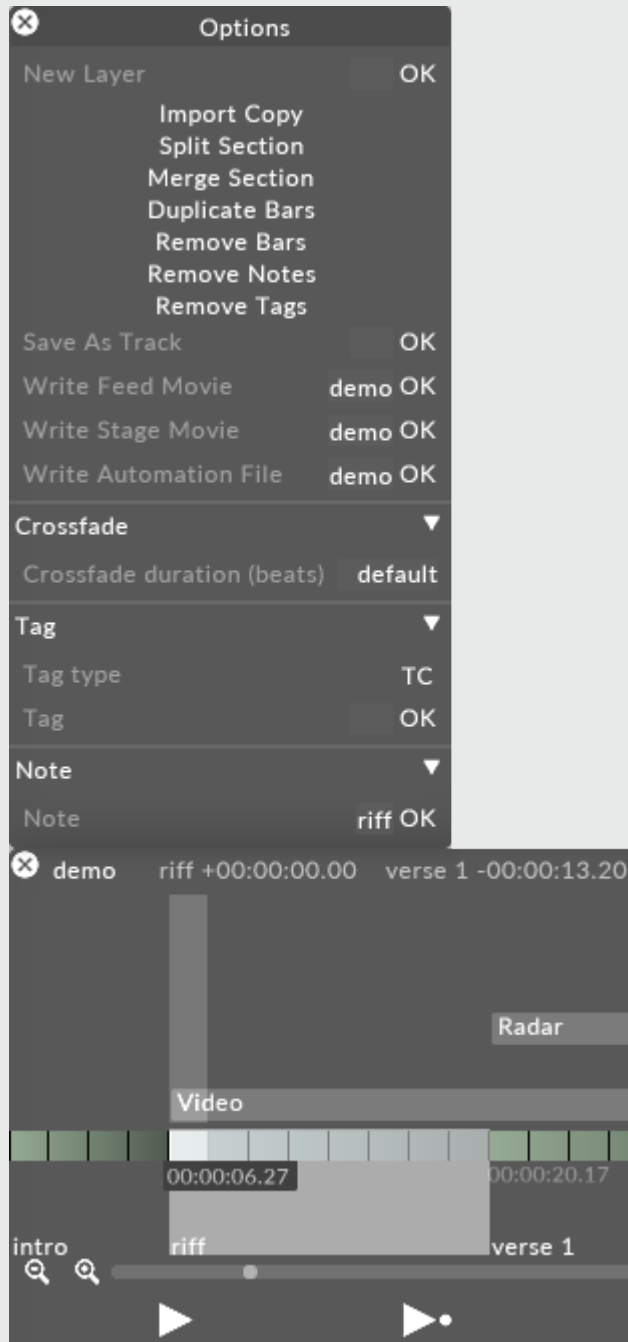

Write Feed Movie option from the Track bars menu is used to render a Feed movie, opened by right-clicking the grey selection rectangle.

**Please note:** Disguise software Designer limits the maximum resolution of a feed movie to 2160x2160.

# Generate content table

Generate Content Table allows users to export a list of content used in the project.

## Generating a content table

1. Open the track manager by left clicking track from the [dashboard](#).
2. Right click the **All** box (or whichever box you wish to export a table of).

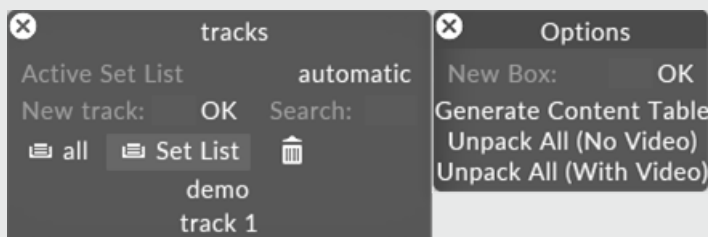

3. Left click the **Generate content table** option.
4. A notification will appear upon successful generation of the content table.

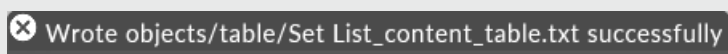

## Viewing a content table

The content table is written as a text file (.txt) to a newly created **Table** folder inside the Objects folder of the project.

Open your project folder by navigating through the windows file structure to its location. For more information see [Project structure](#).

1. Open the **Objects** folder.
2. Open the **Table** folder.

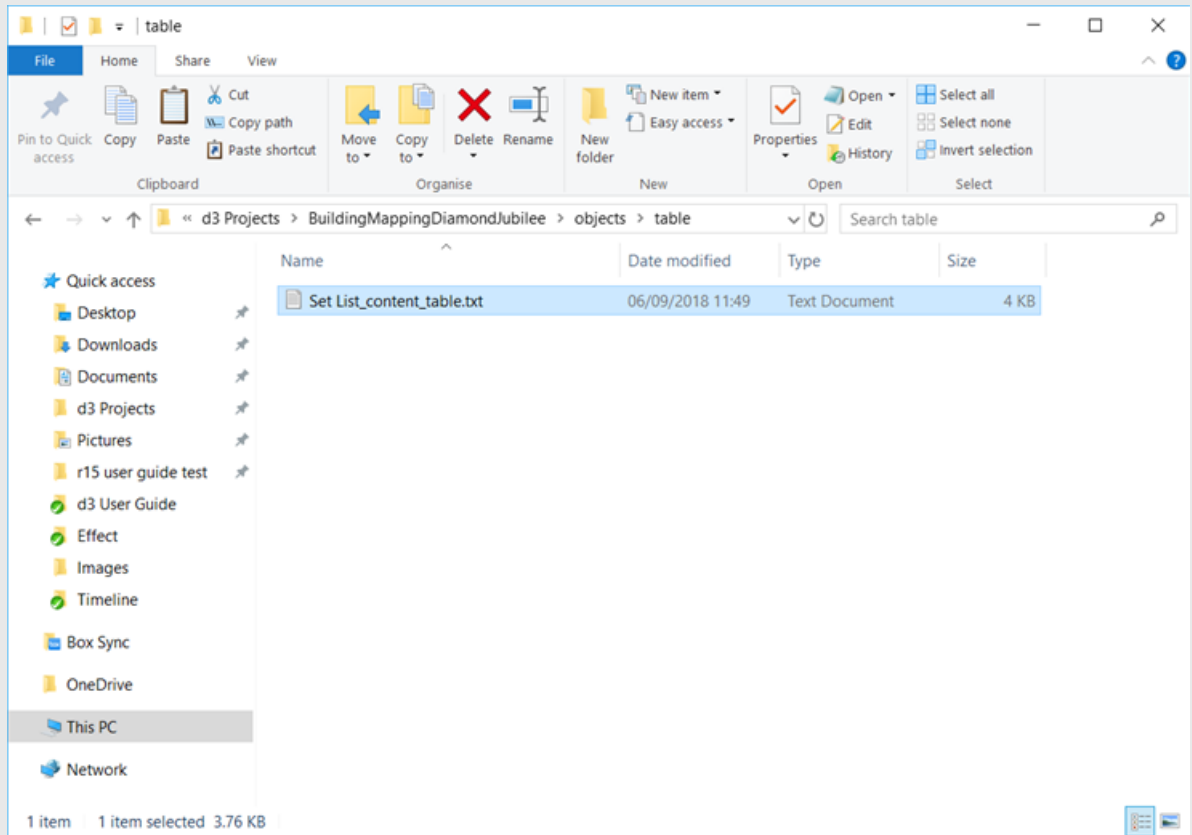

3. Open the newly created .txt file in the Table folder.

```
Set List_content_table.txt - Notepad
File Edit Format View Help
Track demo
Section Content template applied 00:00:00.00
bitmap Bitmap - Palace Texture 00:00:04.00 palace_texture
video Video - Live And Let Die 00:00:32.00 macca_live_and_let_die_video.mov v0
Output Video - Live And Let Die 00:00:32.00 default
video Video - Live And Let Die Audio 00:00:32.00 live_and_let_die_audio.mov v0
Output Video - Live And Let Die Audio 00:00:32.00 default
bitmap Bitmap - Content Template 00:00:00.00 content_template_4096_x_1046
Section VIDEO - Hit play! 00:00:32.00
video Video - Live And Let Die 00:00:32.00 macca_live_and_let_die_video.mov v0
Output Video - Live And Let Die 00:00:32.00 default
video Video - Live And Let Die Audio 00:00:32.00 live_and_let_die_audio.mov v0
Output Video - Live And Let Die Audio 00:00:32.00 default
video Video - Our House Part 1 00:01:48.00 our_house_part_001_video.mov v0
Output Video - Our House Part 1 00:01:48.00 default
```

# 3D fundamentals overview

This sub-chapter will teach you the fundamental knowledge necessary to prepare 3D models for Disguise software.



The London Ralph Lauren Flagship Store in Disguise software.



# 3D fundamentals overview

This sub-chapter will teach you the fundamental knowledge necessary to prepare 3D models for Disguise software.



*The London Ralph Lauren Flagship Store in Disguise software.*

# Exporting 3D models

Disguise software supports the .obj format for 3D meshes. This topic covers the .obj export settings unique to Blender, 3ds Max, Maya, and Cinema 4D, which should be followed to ensure the object is exported to the disguise software correctly.

## 3D Models Overview

Custom 3D models can be loaded into your project and utilized for previsualisation. These models be used as either display surfaces or as props. The supported format for a 3D model is .obj.

Custom 3D objects can either have a baked in **UV unwrap**, or not. Objects with a **UV unwrap** can be used as screen objects to display content, while non-unwrapped ones can only be used as Prop objects used for the visualiser.

Outlined in these tabs are the needed export settings for a custom OBJ to be used in disguise.

**Please note:** Other types of 3D objects known as Alembic files can also be imported into Disguise software; these types of objects included animation that can be triggered from within Disguise software. For more information on these types of files, please visit this link: [Alembic files](#).

## Blender

### Blender Export Settings

1. Select the object to be exported from the 3D application. Note that the selection can not contain any scene elements such as lights or cameras.
2. Select the 3D application's export utility.
3. Select the .obj format from the list of available formats.

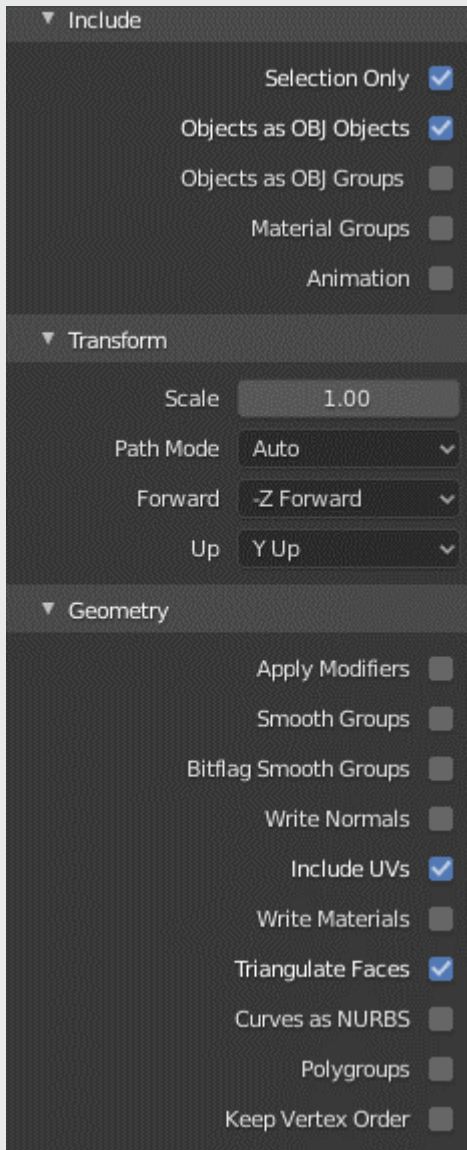

*Export settings for Blender*

## Maya

### Maya Export Settings

1. Select the object to be exported from the 3D application. Note that the selection can not contain any scene elements such as lights or cameras.
2. Select the 3D application's export utility.
3. Select the .obj format from the list of available formats.

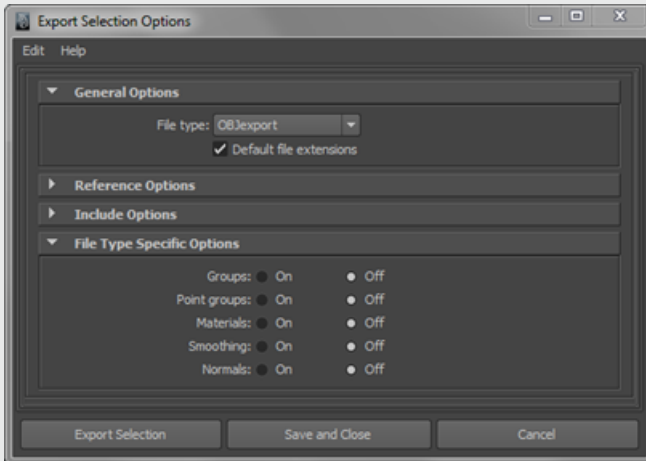

Export settings for Maya

## 3ds Max

### 3ds Export Settings

1. Select the object to be exported from the 3D application. Note that the selection can not contain any scene elements such as lights or cameras.
2. Select the 3D application's export utility.
3. Select the .obj format from the list of available formats.

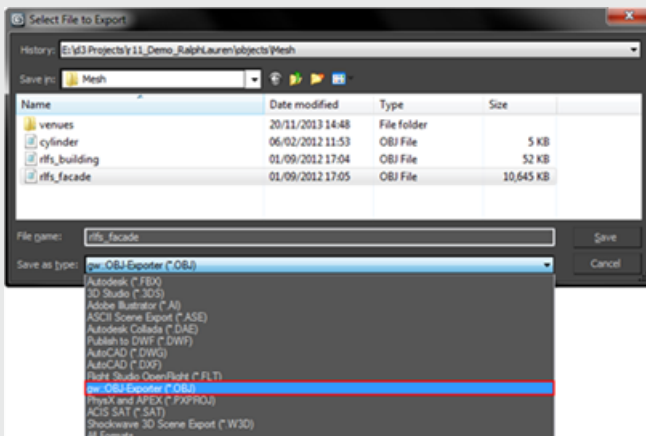

- Deselect **shapes, lines, hidden objects, normals, smoothing groups, material, and material libraries**. Disguise does not support these.
- If the object is to become a screen or a textured prop, select **texture coordinates**, which will export the object's UV map.
- Select **flip yz-axis** to ensure the object is orientated correctly in Disguise software.

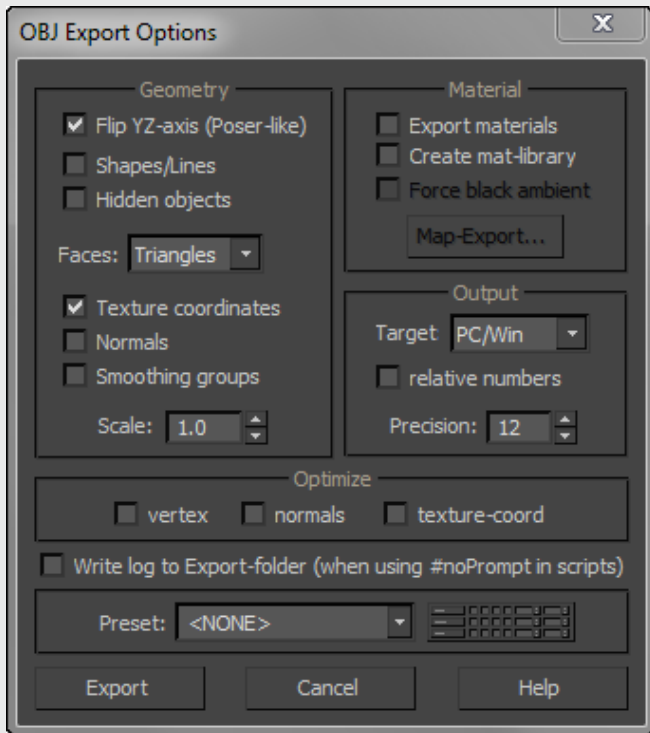

*Export settings for 3ds Max*

Save the **.obj** file in the Disguise Project folder in the following directory: **Projects > Project Name > objects > Mesh**.

To read more about where to place media, see the [Placing media files for a project](#) page.

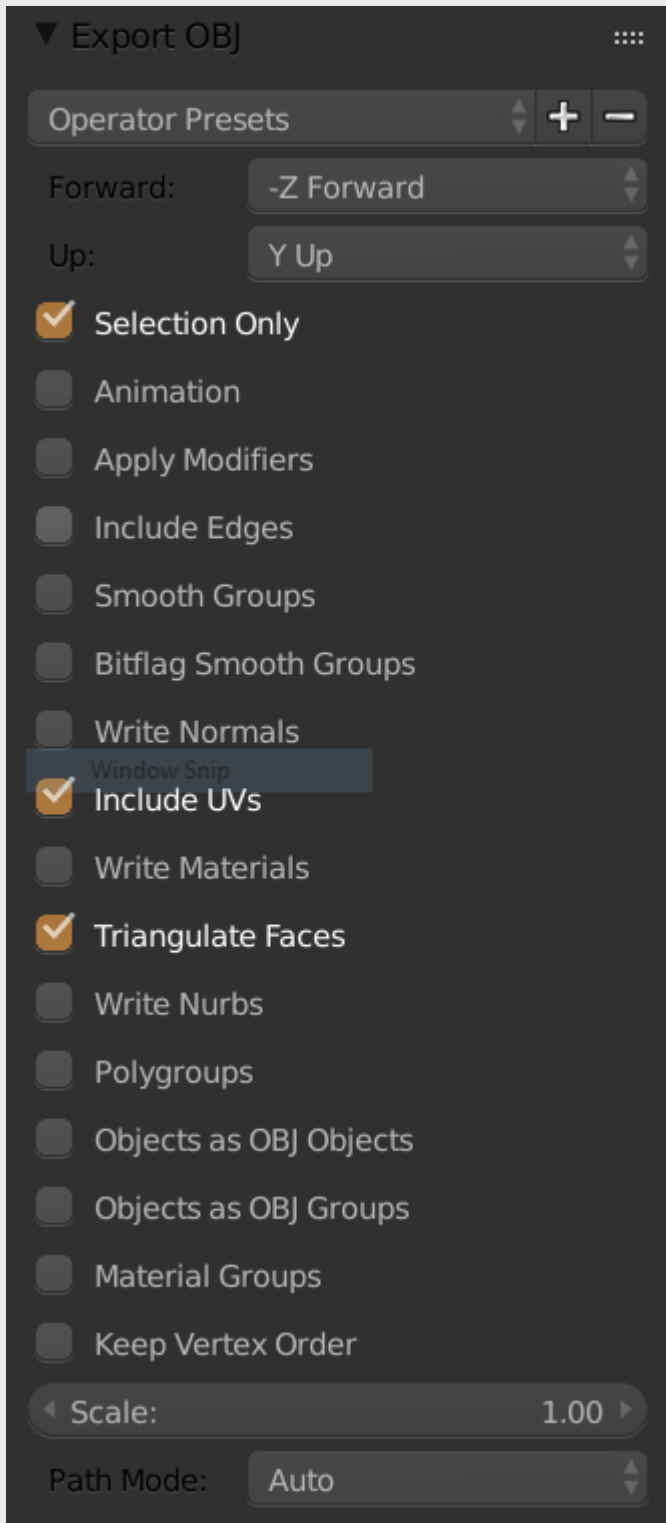

*A list of .obj files exported from 3ds Max to a Disguise Project folder.*

**Please note:** We recommend triangulating faces before exporting models for use in Disguise software.

# Cinema 4D

## C4D Export Settings

1. Check the project settings are set to scale in **meters** (C4D defaults to cm).
2. Select the object to be exported from the 3D application. Note that the selection can not contain any scene elements such as lights or cameras.
3. Select the 3D application's export utility.
4. Select the .obj format from the list of available formats.

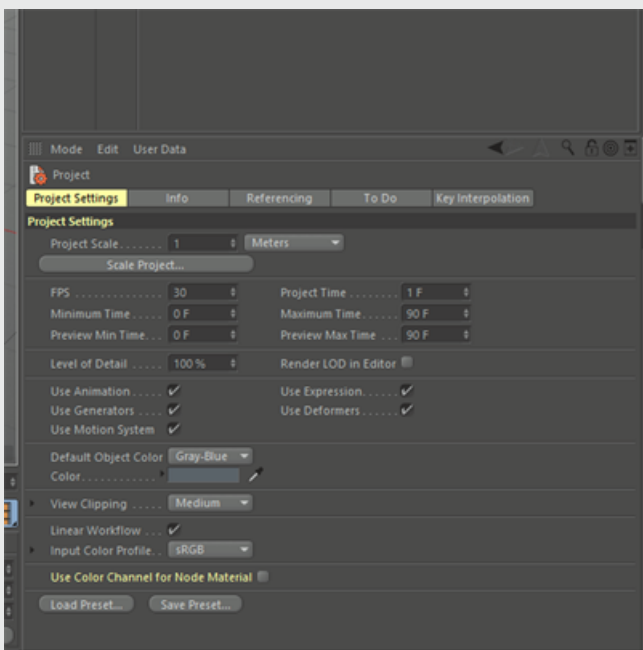

Export settings for C4D

# Optimising 3D models

When preparing objects for Disguise software there are a number of processes to consider.

- Objects should be **divided** into Screens and Props.
- Screens should only include the surfaces necessary to **display** video content and may require re-modelling by detaching or deleting unnecessary polygons.
- Detached objects can be used in Disguise software as props, which are helpful for **simulating** a show in the Stage visualiser to present to the client.
- Objects should not exceed 150,000-200,000 vertices and may require remodelling by **welding** unnecessary vertices.

## Dividing 3D models into screens and props

In a 3D application an object can be **detached** into multiple sub-objects. This is necessary when dividing a 3D model into screens and props for Disguise software. Screens are video displays such as LED panels, projection surfaces and DMX fixtures, and props are scenographic elements such as audience seating, stage floors and truss pieces.

### Screens

A new Disguise project contains the following **.obj** files to be used as screens:

- **rectangle.obj**
- **cylinder.obj**
- **concave.obj**
- **dome.obj**

**Please note:** the **rectangle.obj**, **concave.obj** and **puffersphere.obj** file is generated in the software and is not visible in the mesh library.



Complex screens, for example a building or a car, require 3D modelling and UV mapping tools available in 3D applications. For further information see the [LED screen examples](#) and the [Projection screen examples](#).

## Props

Parts of an object which are not required to display video content can be used in Disguise software as props. The image below shows the Ralph Lauren London Flagship Store **divided** into two sub-objects: a screen to display video content and a prop to simulate the building's top and bottom. In Disguise software a prop can be customised to simulate the object more realistically including the ability to map paint textures to it. For further information see the [Editing Props](#) page.

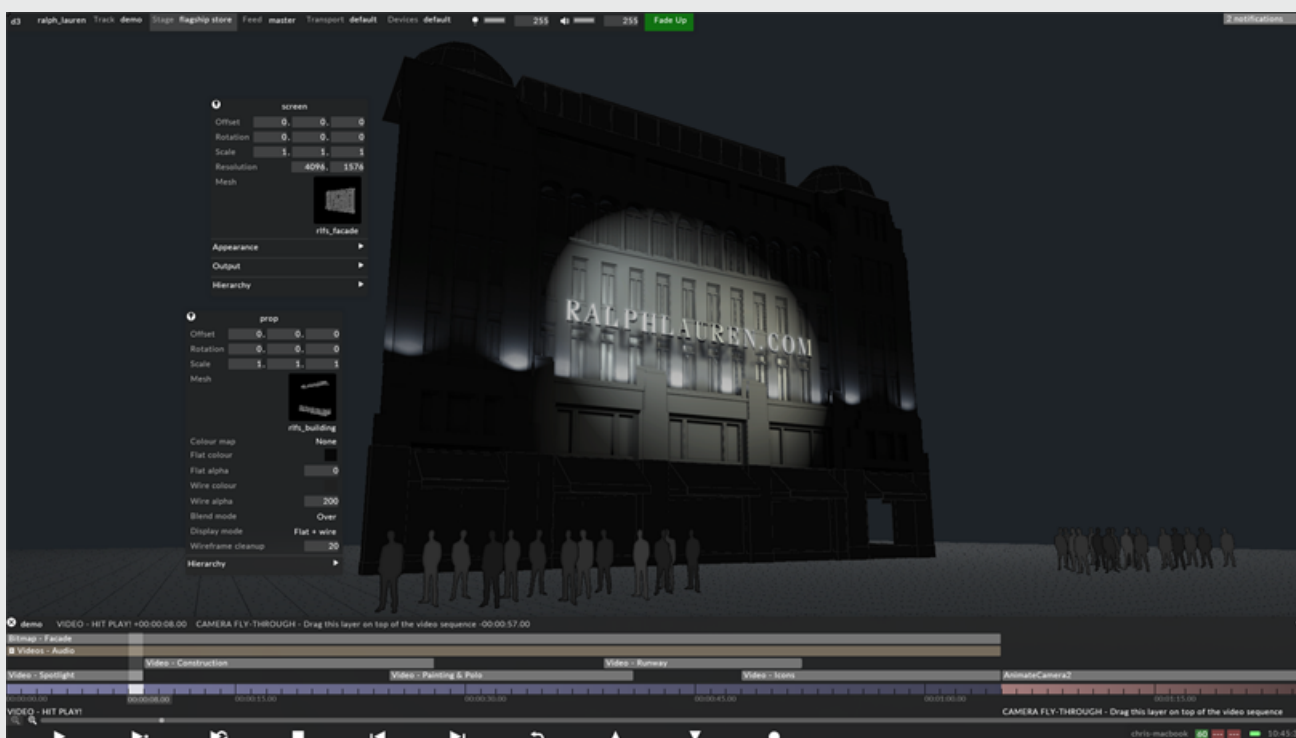

The Ralph Lauren Flagship Store divided into a screen and a prop in Disguise.

## Deleting overlapping faces

Delete all **overlapping** faces from the object. It is important to understand when video content is mapped to the screen in Disguise software, any surfaces with overlapping faces will display overlapping content. To test this, map a [Radar](#) layer to the screen.

## Reducing the number of vertices

In Disguise software, the Stage should not exceed 150,000-200,000 vertices. It is recommended to reduce the total number of vertices by **welding** them together, which should be done in a 3D application. Be careful not to delete too many vertices because this may lower playback **quality**, but on the other hand too many vertices may lower playback **performance**. A balance between quality and performance is necessary.

**Please note:** during a live show it is recommended to remove props from the Stage in order to optimise playback performance. For further information see the [Creating and removing props](#) page.

## Helpful resources

### 3ds Max

— [Support and learning](#)

### Maya

— [Support and learning](#)

# Orientation

When preparing objects for Disguise software they should be orientated accurately.

- In the 3D application rotate the object in a **south-north** direction. Doing so will help ensure the object is clearly viewed from the camera's home position in Disguise software, which can be enabled by selecting the **F12** button.

To read more about camera controls, see the [Navigating Stage](#) sub-chapter.

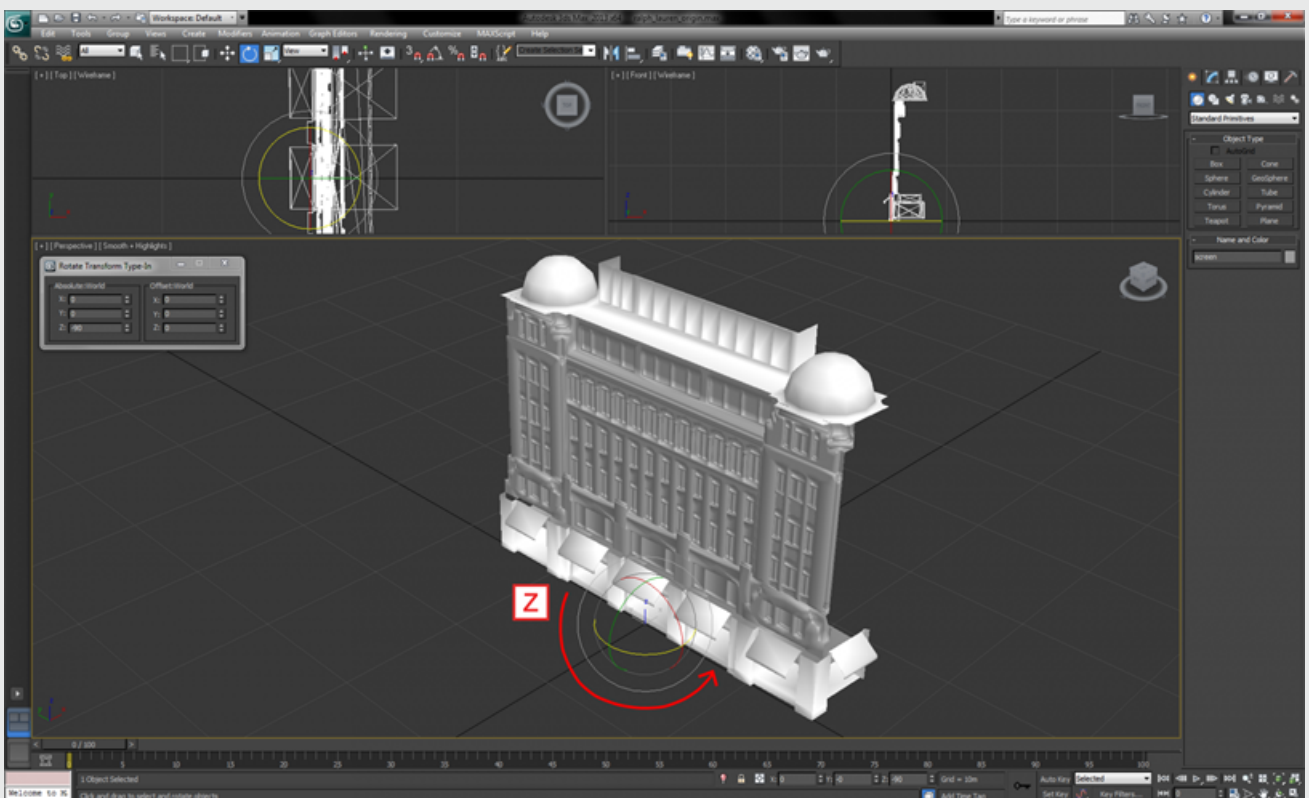

*The Ralph Lauren London Flagship Store orientated incorrectly in 3ds Max, set in a west-east direction.*

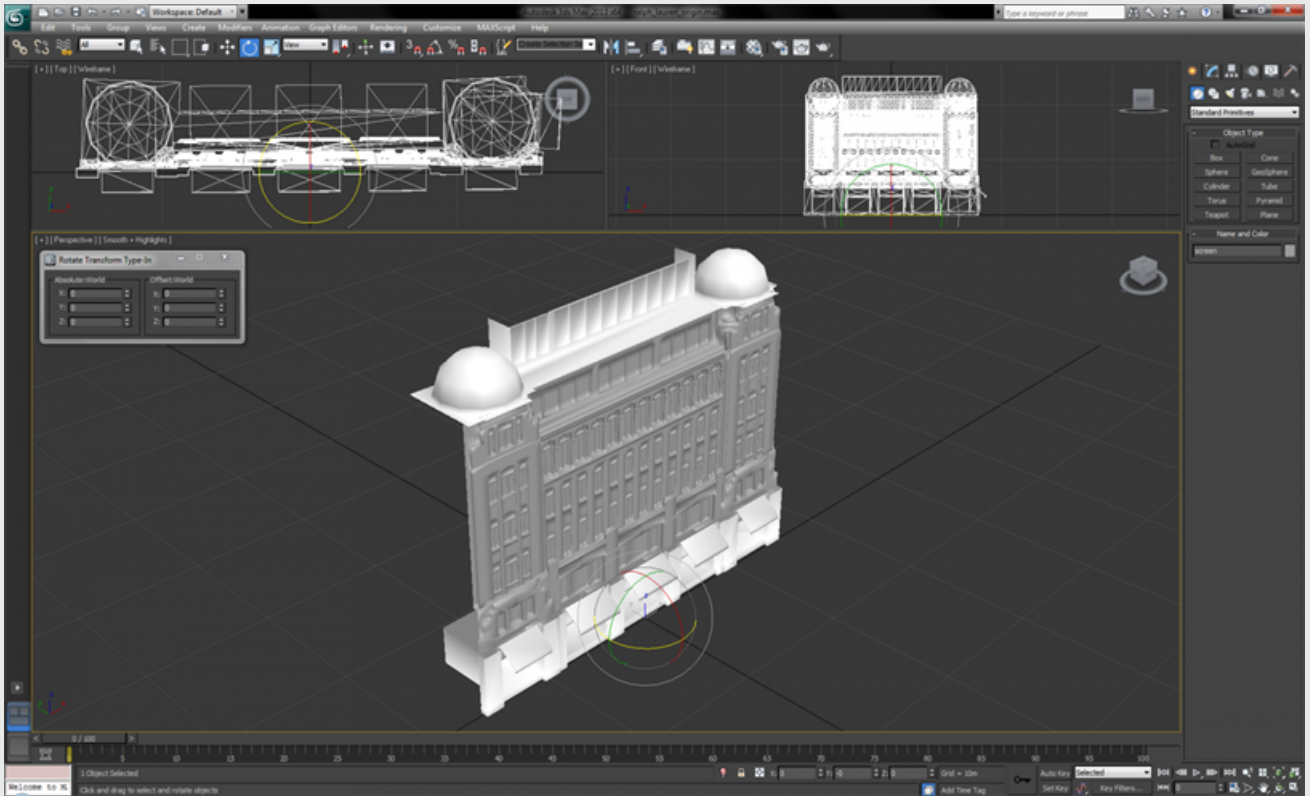

*The Ralph Lauren London Flagship Store orientated correctly in 3ds Max, set in a south-north direction.*

## Helpful Resources

### 3ds Max

- [Support and learning](#)

### Maya

- [Support and learning](#)

# Position

When preparing objects for Disguise software they should be positioned accurately.

- In the 3D application align the object to the scene's **origin**. The origin is **0,0,0** in 3D space corresponding to the **x,y,z** axes.
- It is highly recommended to align the object's base to the origin on the **vertical** axis. Doing so will help ensure the object's vertical position can be easily referenced in Disguise software, which is particularly helpful during [projector calibration](#).

## Pivot points

The **.obj** file format does not save pivot points. Therefore, before exporting objects to Disguise software it is important to understand if and how the object should rotate.

- If the object should rotate around the origin, then in the 3D application **offset** the object from the origin before exporting it to Disguise software.
- If the object should rotate around a pivot point, then in the 3D application **align** the object's pivot point to the origin before exporting it to Disguise software. In the software, the object can be offset to any position and it will always rotate around this pivot point.

For further information see the [Exporting 3D models](#) page.

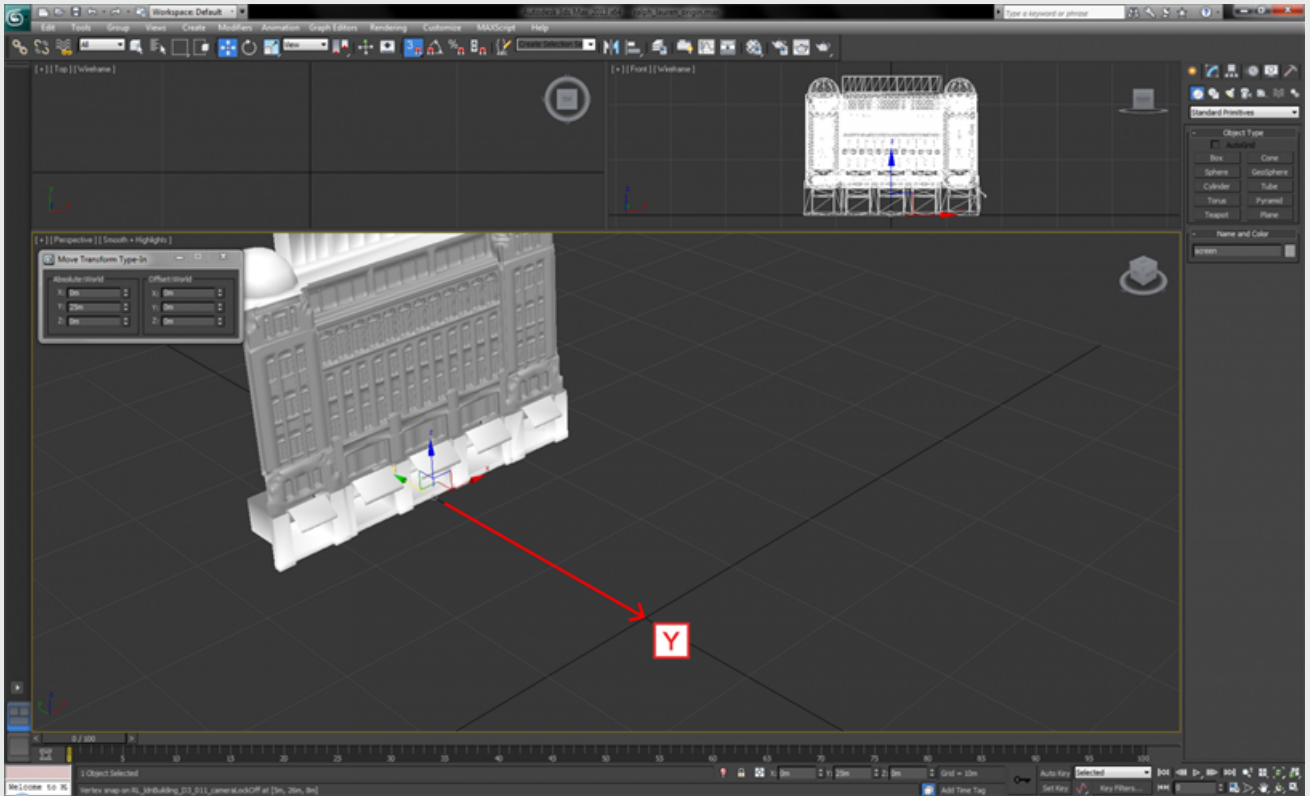

The Ralph Lauren London Flagship Store offset from the origin in 3ds Max.

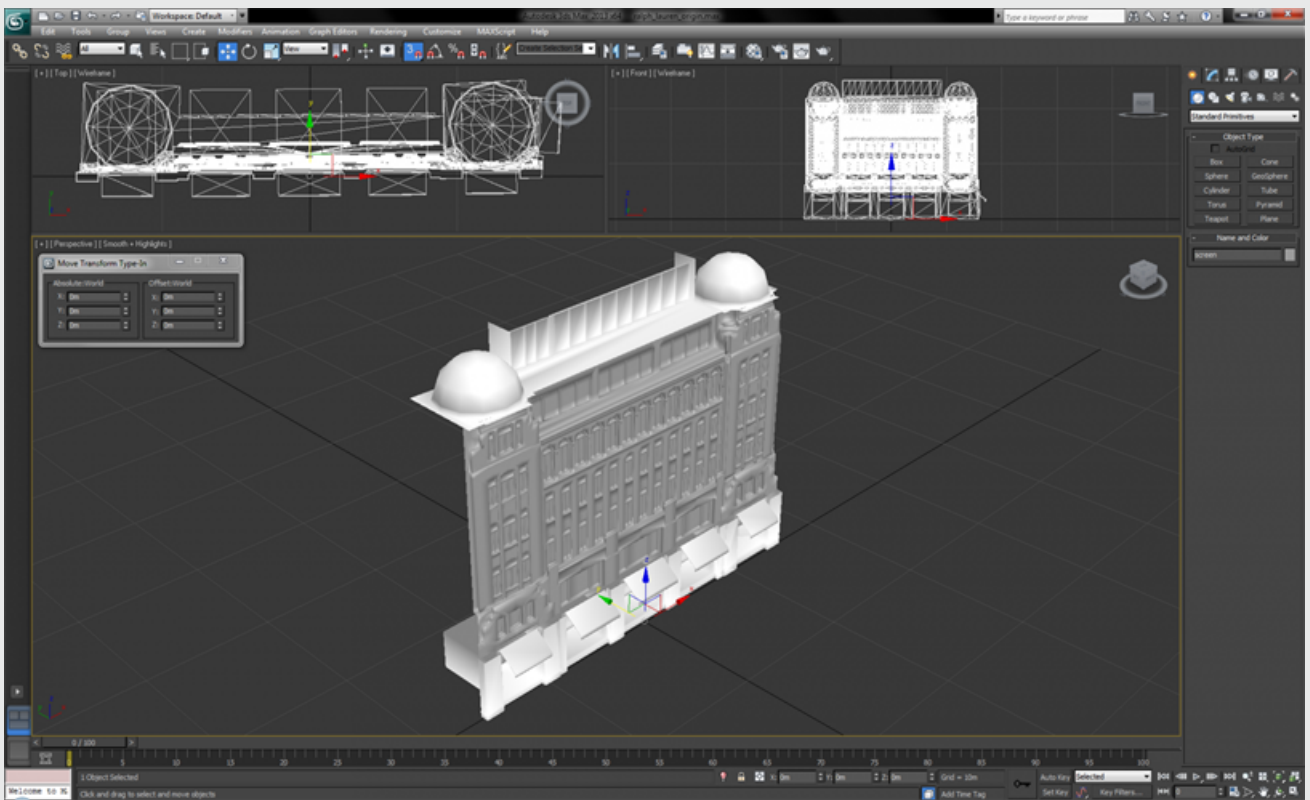

The Ralph Lauren London Flagship Store aligned to the origin in 3ds Max.

## Helpful Resources

### 3ds Max

— [Support and learning](#)

### Maya

— [Support and learning](#)

# Scale

When preparing objects for Disguise software they should be scaled accurately.

- In the 3D application set the system unit to **metres**, because Disguise software automatically rescales objects to metres. Doing so will help ensure the object is correctly scaled. If working in feet and inches, you should rescale the object to metres **before** exporting it to Disguise software.
- If the object in Disguise software is too large or too small it can be rescaled using the Screen editor.

**Please note:** Maya only exports objects to **centimetres** and therefore in Disguise software they are rescaled 100:1. To avoid this, before exporting the object to Disguise, rescale it 1:100.

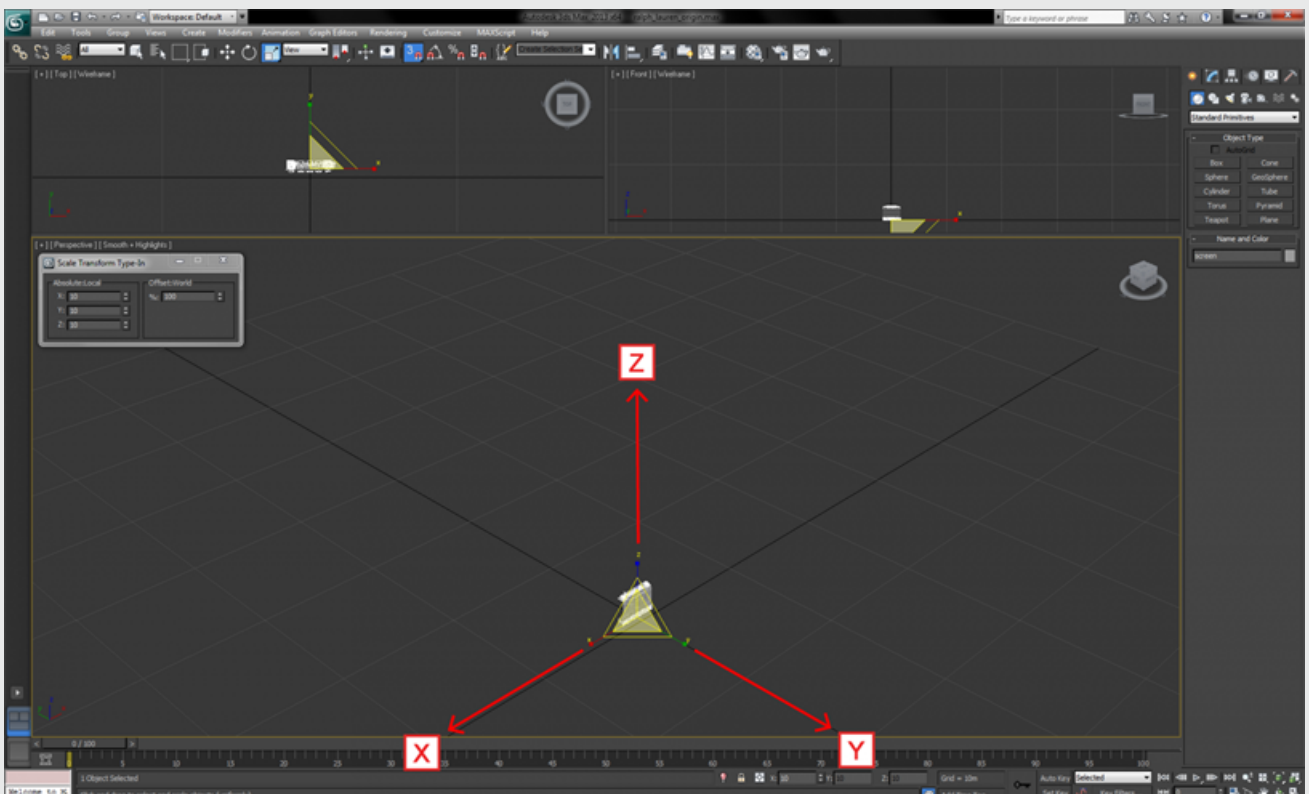



The Ralph Lauren London Flagship Store scaled incorrectly in 3ds Max, set to 1:10 scale.

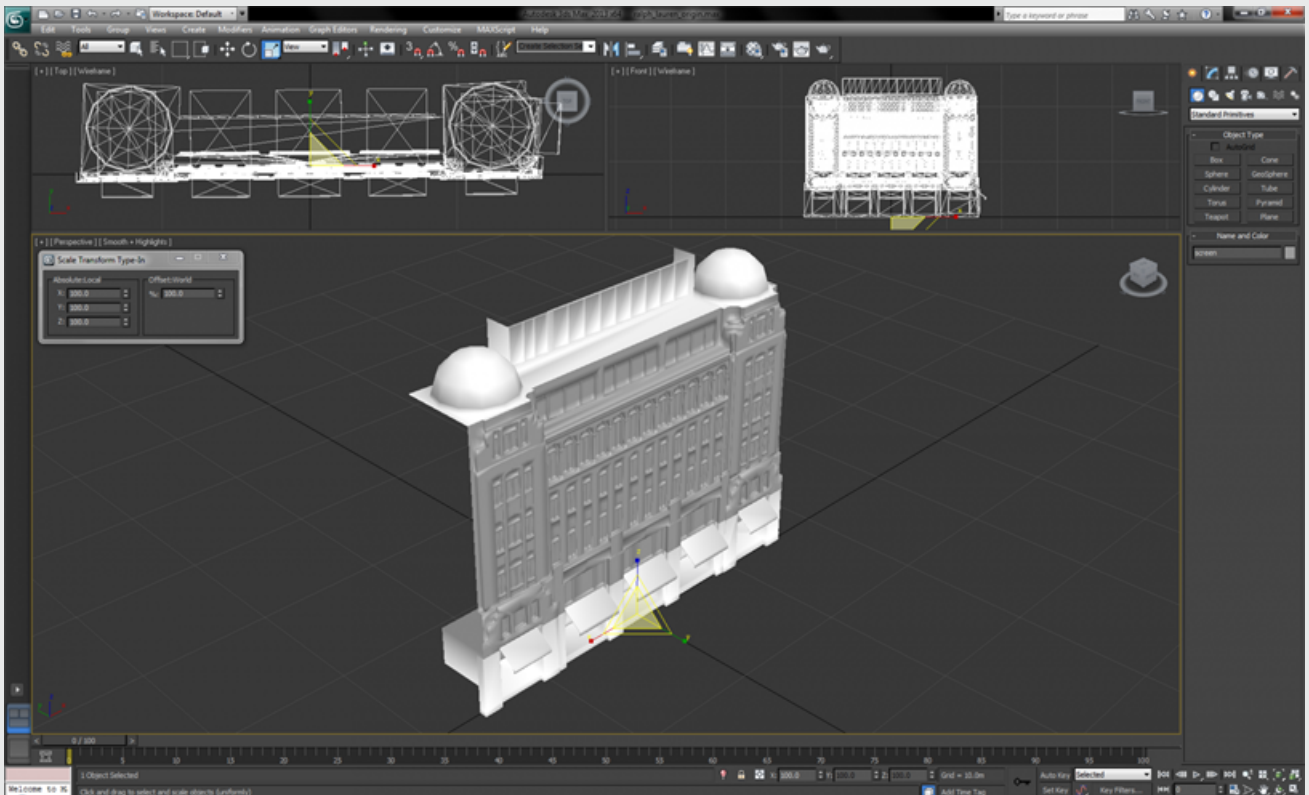

The Ralph Lauren London Flagship Store scaled correctly in 3ds Max, set to 1:1 scale.

## Helpful Resources

### 3ds Max

— [Support and learning](#)

### Maya

— [Support and learning](#)

# Understanding .obj files

An .obj file is a format containing data for an object's vertices, polygons and texture coordinates.

The image below shows a Disguise project containing common .obj files which can be separated into two categories: **Screens** and **Props**. A Screen is an object representing a **video display**, for example a projection dome, and requires a **UV map** to display video content. A Prop is an object representing a **scenographic element**, for example a theatre venue, and does not always require a UV map. To read more about where to place media, see the [Placing media files for a project](#) page. To read more about UV mapping, see the [What is UV mapping](#) page.

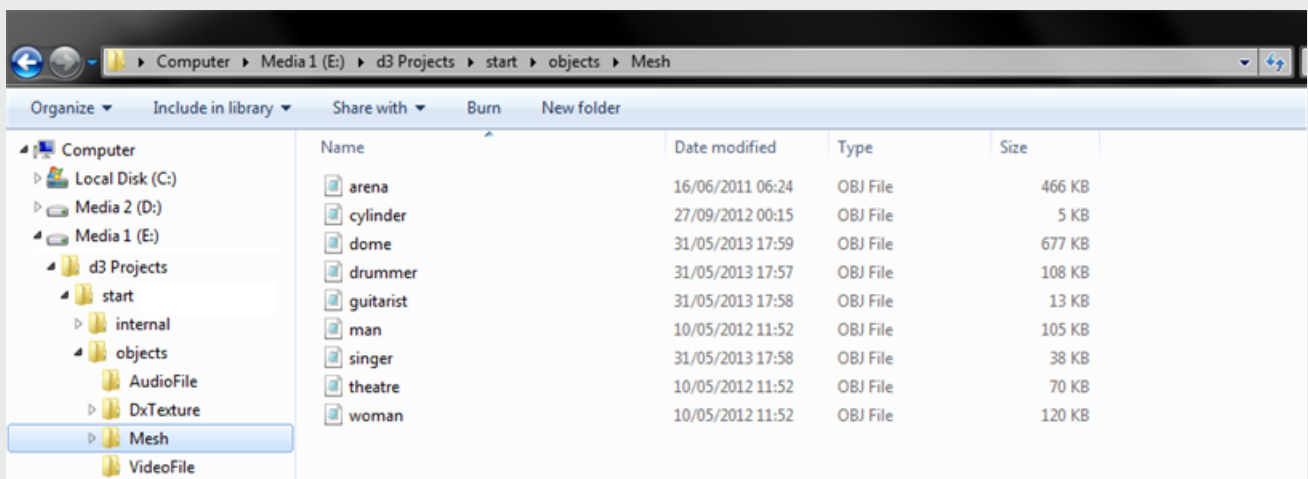

Common .obj files contained in the Disguise Start project.

## Helpful Resources

- [Wavefront OBJ File Format Summary](#)

# 3D modelling / UV mapping overview

This chapter will introduce you to workflows used by the Disguise support team to prepare projects. You will learn 3D modelling and UV mapping techniques to create pixel-perfect LED panels, projection surfaces and DMX screens. However, this chapter will not teach you how to master 3D applications. It is recommended you have a basic knowledge of 3D modelling and UV mapping techniques before reading further.

## Why learn 3D modelling and UV mapping techniques?

It is important to understand why Disguise software requires knowledge in 3D modelling and UV mapping techniques. The Disguise software features a 3D realtime simulator for visualising venues and video displays including LED panels, projection surfaces, DMX fixtures, or any other video display technology. To simulate a pixel-perfect screen in Disguise which is complex in shape, for example a building or a car, a fundamental understanding of 3D modelling and UV mapping techniques is required. For further information please contact the [Support Team](#).

# UV mapping overview

This sub-chapter will teach you the specific principles necessary to UV map 3D models for Disguise software.

Topics include:

- [What is UV mapping?](#)
- [How does Disguise sample UV maps?](#)
- [The UV map as the hardware output](#)
- [The UV map as the content template](#)
- [Editing UV maps](#)
- [Exporting UV maps](#)

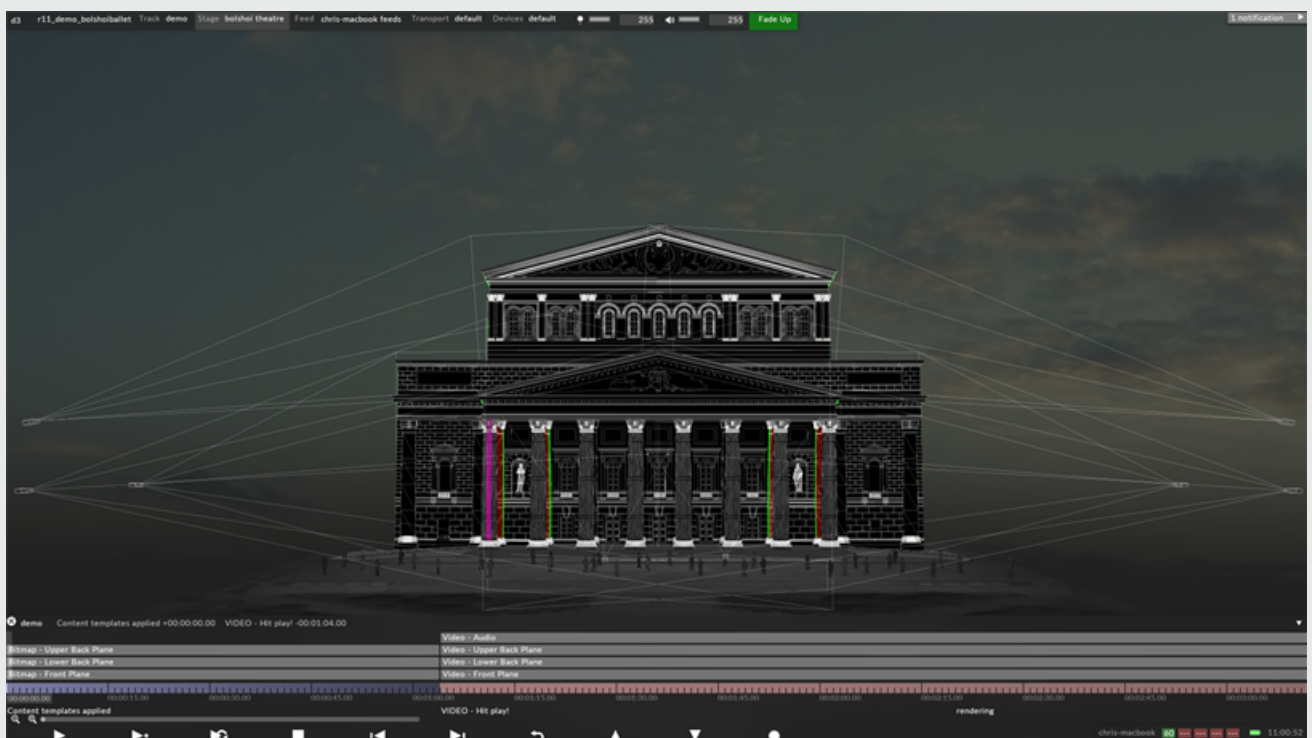

# UV mapping overview

This sub-chapter will teach you the specific principles necessary to UV map 3D models for Disguise software.

Topics include:

- [What is UV mapping?](#)
- [How does Disguise sample UV maps?](#)
- [The UV map as the hardware output](#)
- [The UV map as the content template](#)
- [Editing UV maps](#)
- [Exporting UV maps](#)

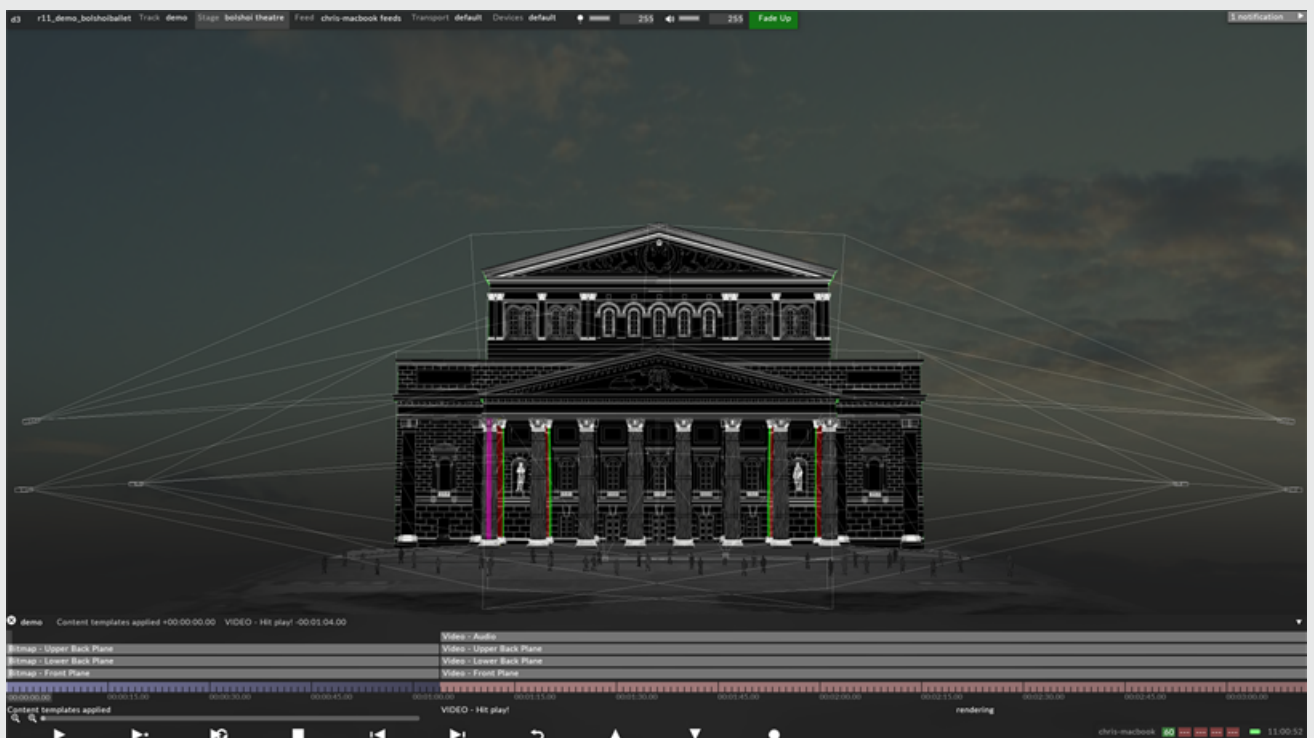

# What is UV mapping?

UV mapping is the process of generating a 2D representation of a 3D object.

This 2D representation is constructed from UV coordinates, which are commonly known as texture coordinates. U represents the horizontal axis and V represents the vertical axis. Each UV coordinate has a corresponding point in 3D space called a vertex. Together vertices form edges, edges form faces, faces form polygons, and polygons form surfaces. The image below shows how a cube in 3D space can be unwrapped into a texture in 2D space to generate a UV map.

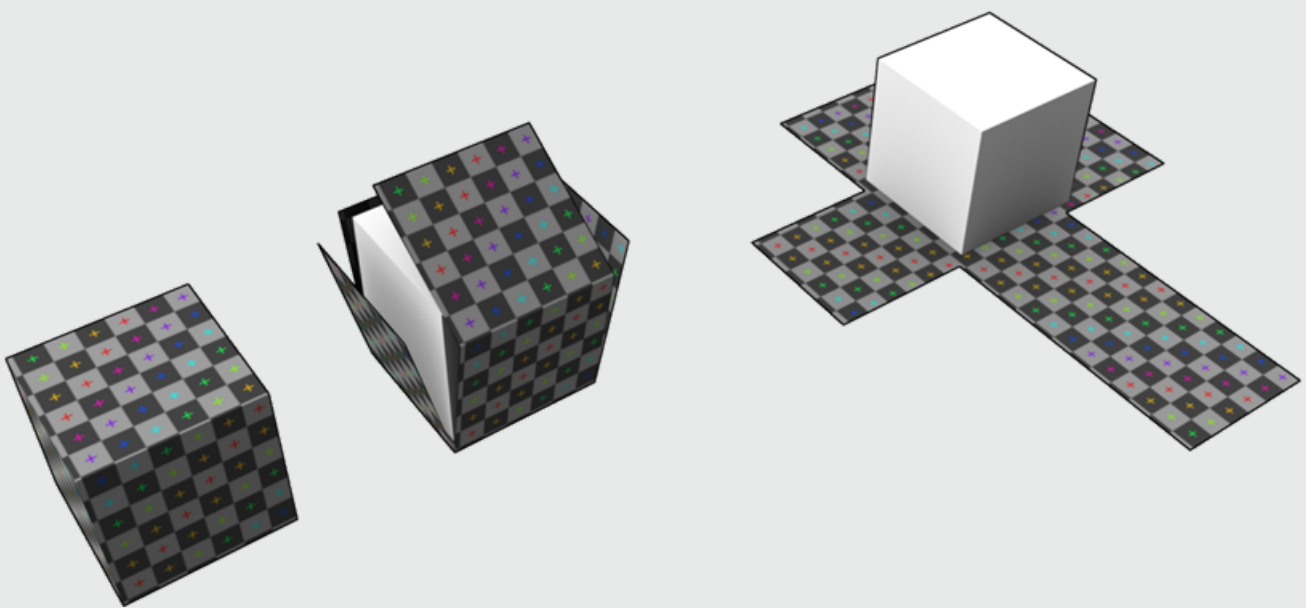

A 3D cube being unwrapped into a 2D representation to generate a UV map.

A UV map can be generated automatically by a 3D application, for example [3ds Max](#), [Maya](#), [Cinema 4D](#) and [Blender](#), but normally the UV map requires editing manually. To read more about editing UV maps see the [Editing UV maps](#) page.

## Example UV map

The image below shows a plane constructed from four vertices with four corresponding texture coordinates. The top-left vertex corresponds to the top-left texture coordinate and the bottom-right vertex corresponds to the bottom-right texture coordinate. For further information see the [LED screen examples](#) and the [Projection screen examples](#).

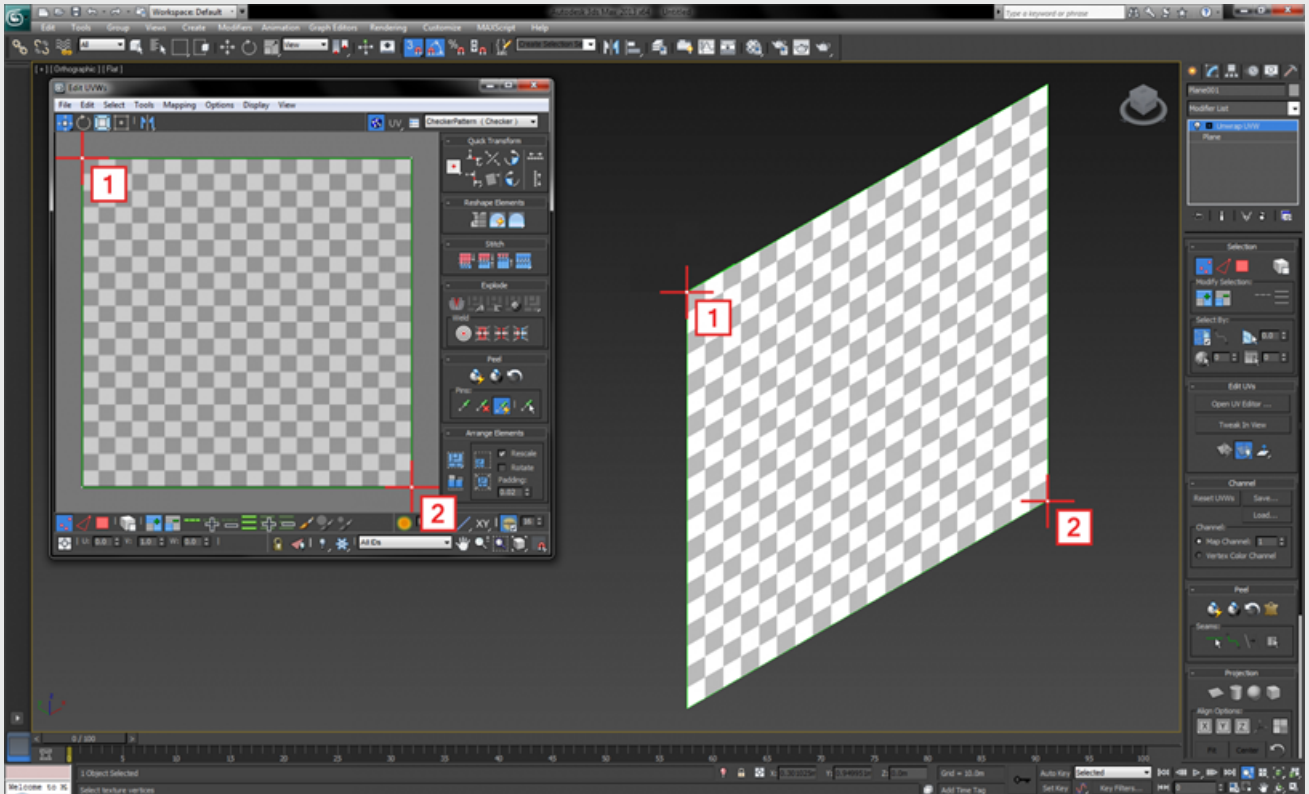

*A plane modelled and UV mapped in 3ds Max. The plane's top-left vertice corresponds to the top-left texture coordinate (1), and the bottom-right vertice corresponds to the bottom-right texture coordinate (2).*

## Helpful Resources

### 3ds Max

- [Support and learning](#)

### Maya

- [Support and learning](#)

# How does d3 sample UV maps?

In Disguise software, all meshes used for displays such as LED screens or Projection surfaces require a UV map to function. This is important because if a display does not contain a UV map it will display black and cannot be used for any mapping or output.

A UV map tells Disguise how to translate back and forth between the 2D source content and the mesh's 3D polygons for visualisation and to enable Disguise's 3D content mapping & projection mapping capabilities.

A UV map does not specify the aspect ratio or resolution of the mesh. UVs are defined in what is called 'normalised coordinates', which means they must have values between 0 and 1 on both the U and V axes, and there should not be any gaps left at the edges of the UV 'box'.

This normalised property of UV maps enables you to select the appropriate resolution and aspect ratio based on artistic and technical requirements from within the d3 visualiser. The aspect ratio of the display is usually defined by the position and size of the 3D geometry of the mesh, while the resolution is determined based on the LED product or projector type and positioning within d3, depending on the display technology used. Aspect ratio is determined by the ratio between the horizontal and vertical dimensions of the display resolution.

For example, if Disguise software is started with a standard 'rectangle' mesh on a display, the mesh has 4 vertices in each corner with normalised UV coordinates at (0,0), (0,1), (1,0), and (1,1). The display is set to 1920x1080 resolution. The software will sample source content 1920 times across each of the 1080 lines stretching across the mesh polygons. If d3 wishes to know the 3D location of the second pixel on the second line, the UV coordinate (0.0005, 0.0009), or (1/1920, 1/1080) is found, and d3 calculates the corresponding 3D location.



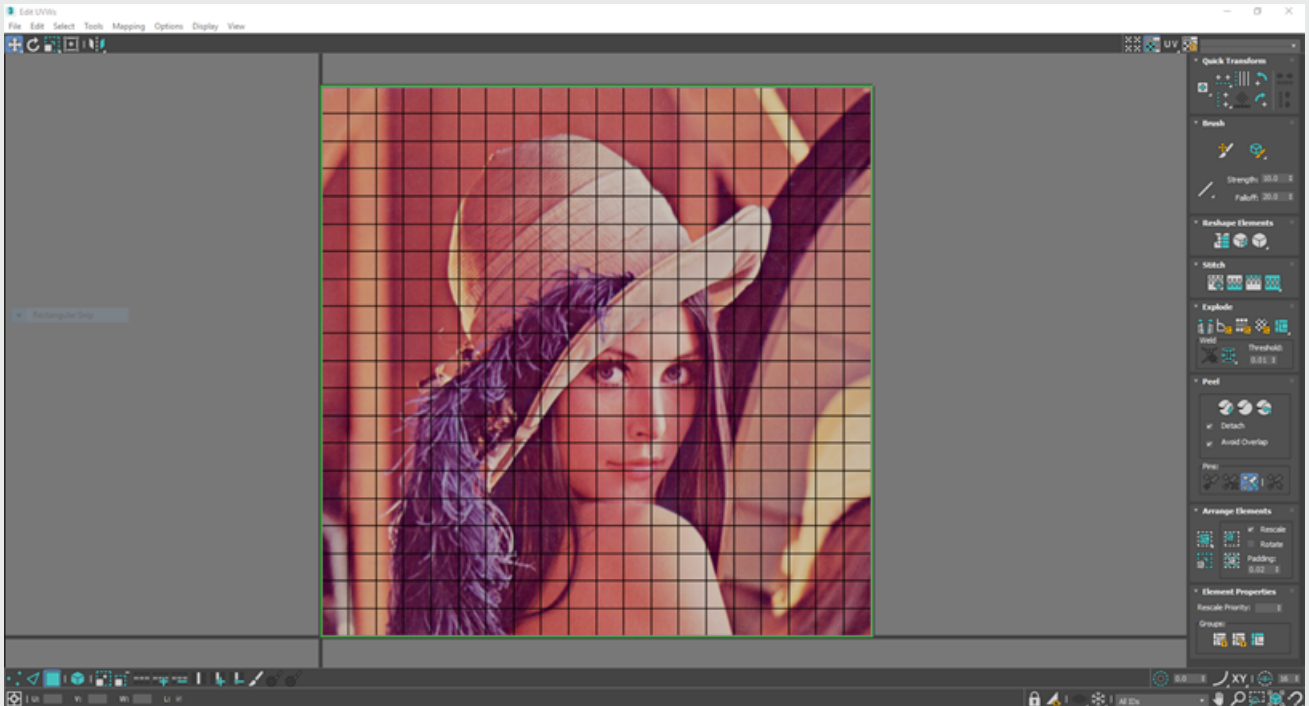

Screen in Disguise sampling the UV map shown in 3ds Max. The screen's top left pixel is sampling the UV map's top left quad.

## Normalising UV maps

Normalising is the process of scaling the UV map to fill UV space entirely from a range of 0-1 in both the U and V axes. When Disguise samples the UV map it will capture the entire UV space. Therefore, it is important to normalise the UV map correctly while setting the resolution of the screen in Disguise correctly, because together these will determine how video content is mapped to the screen.

The normalised UV map is capable of generating uniform pixels across the 3D model if the resolution of the screen is set correctly in Disguise software. To do so, the resolution must be set to a non-square aspect, and this is possible because Disguise can read textures with different horizontal and vertical resolutions. However, a non-normalised UV map is capable of generating uniform pixels too, although in this case the resolution should be set to a square aspect in Disguise, for example 1024x1024 pixels. However, here the disadvantage is the UV map is sampling less UV space, resulting in more virtual pixels that will not be visible in Disguise. To read more about setting screen resolutions see the [Screen properties](#) page.

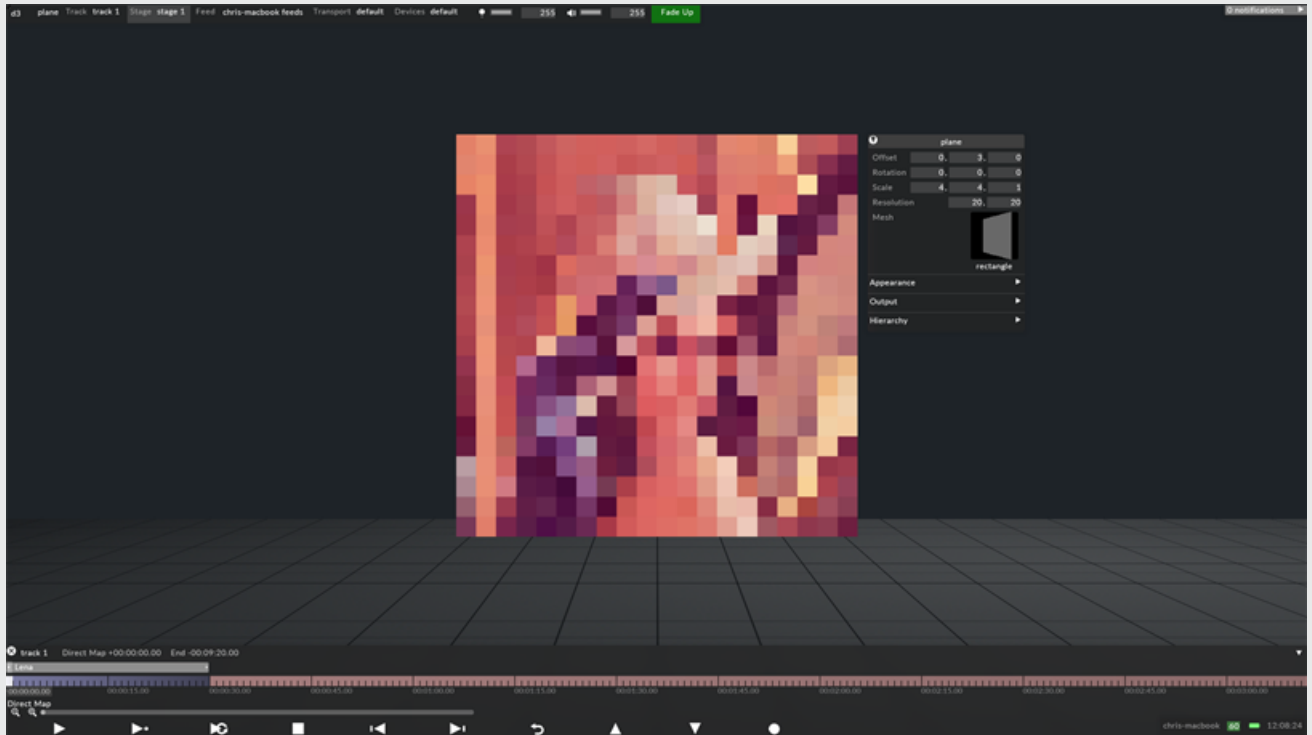

The UV map has been normalised allowing for all pixels set in Disguise's screen editor to be assigned on the screen.

## Helpful Resources

- [Normalize UV's \(Maya\)](#)
- [PolyUnwrapper \(3ds Max plugin\)](#)

# Editing UV maps

Usually after you've generated an appropriate UV map you may still need to edit the UV coordinates manually. Regardless if you have to do that or not you should always inspect the UV layout before exporting the object. 3d Max, Maya and Cinema4D offers powerful tools and plugins to do so.

The most commonly used operations for editing UV coordinates are:

- Re-scale UV coordinates horizontally or vertically, or both.
- Move UV vertices and/or faces.
- Rotate UV coordinates.
- Mirror UV coordinates.
- Snap UV coordinates to each other.
- Relax UV coordinates.
- Normalize UV coordinates.

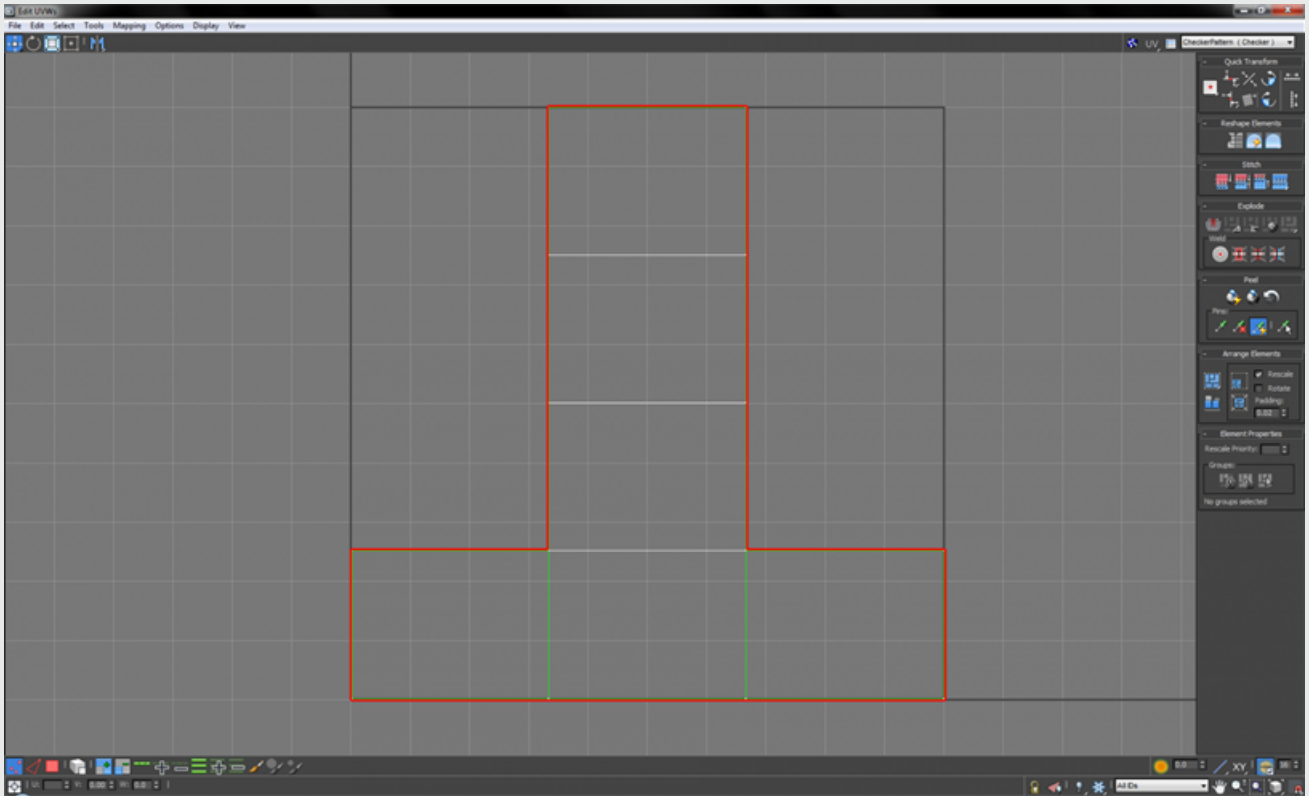

UV editor of 3ds Max

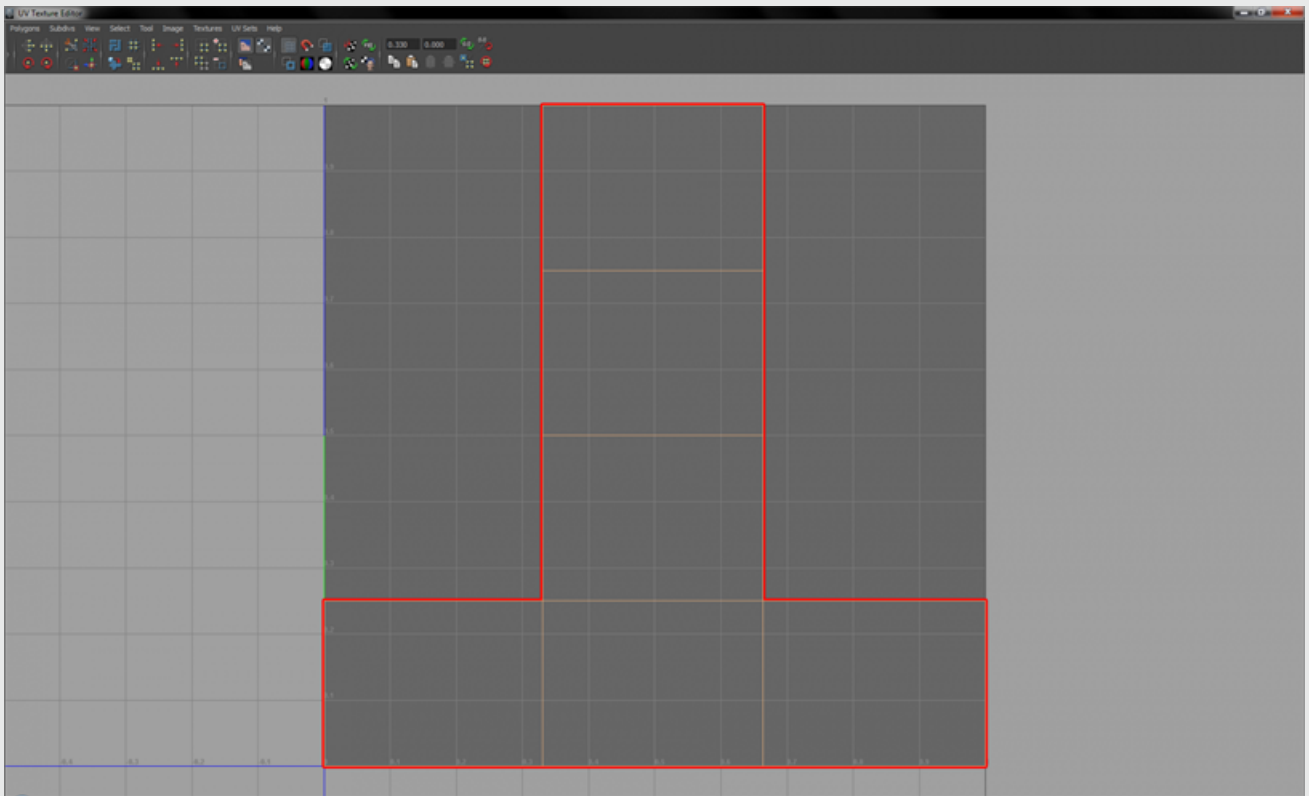

UV editor of Maya

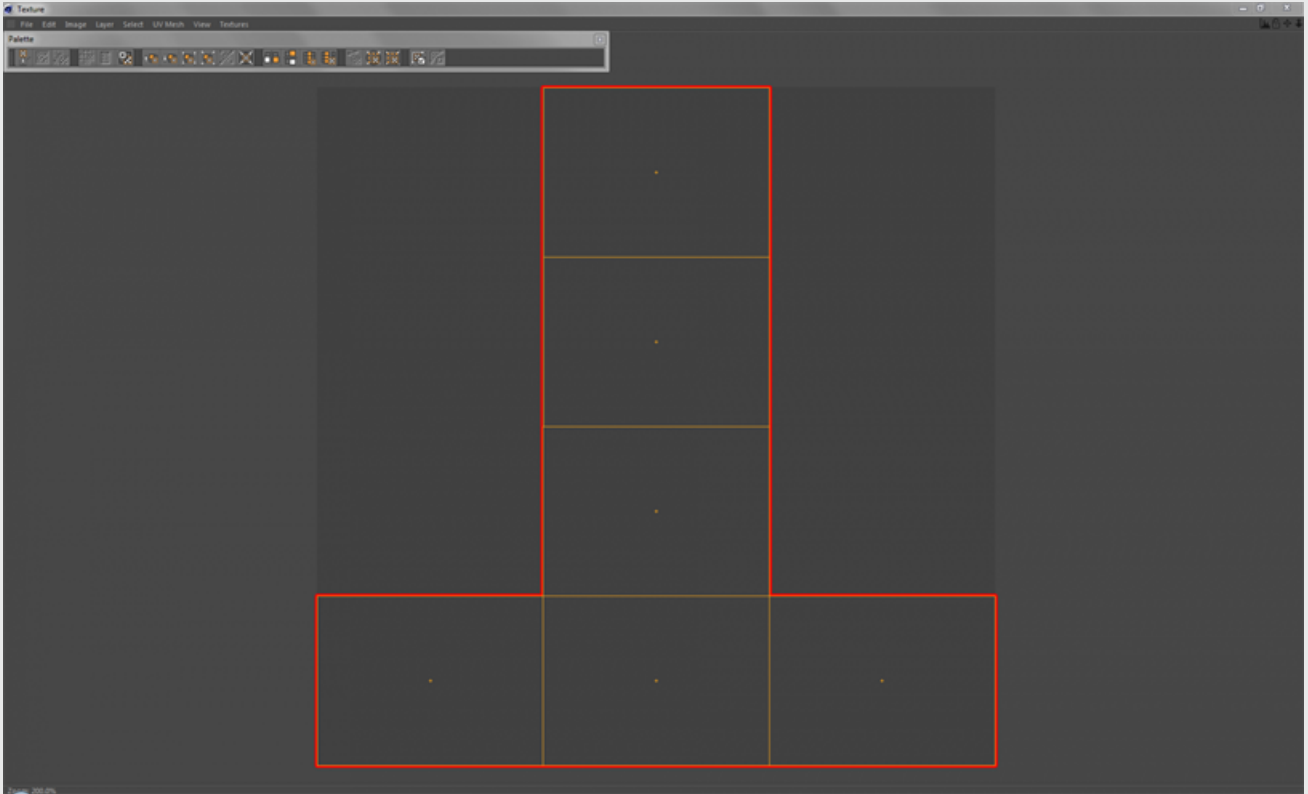

UV editor of Cinema4D

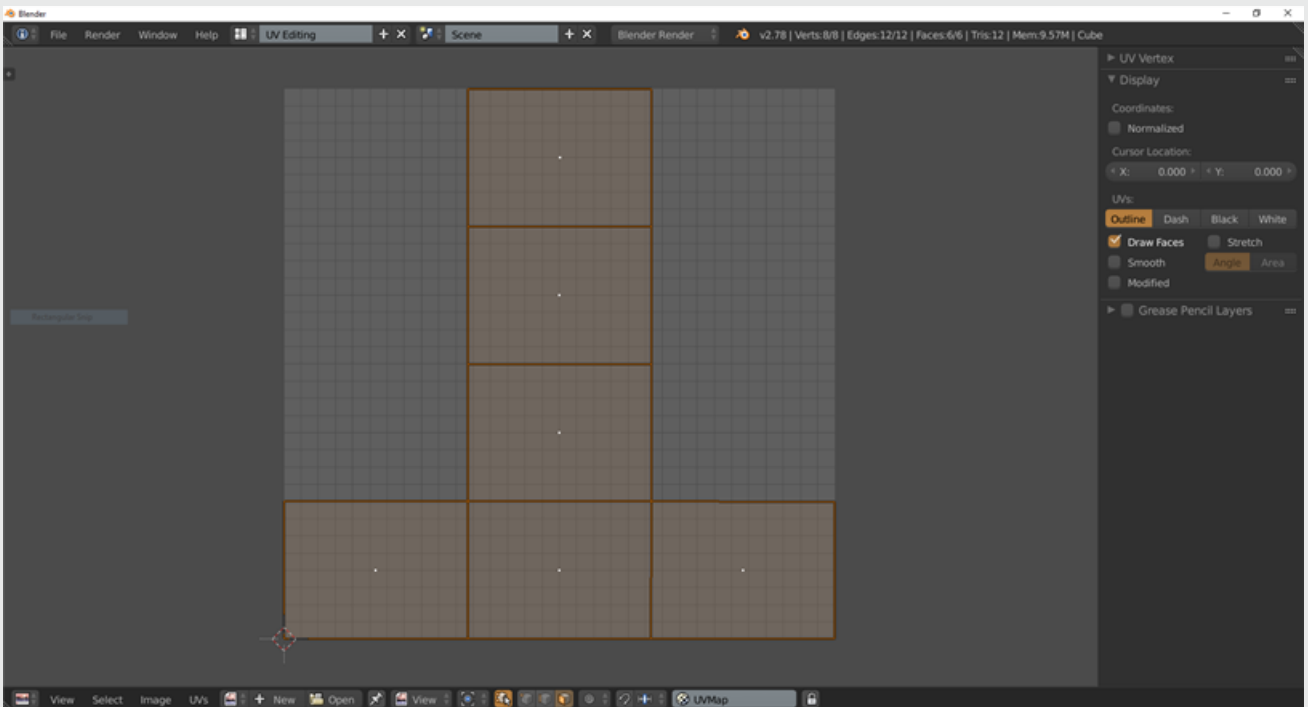

UV editor of Blender

## Helpful resources

### 3ds Max

- [Unwrap UVW Modifier](#)
- [Edit UVW](#)

### Maya

- [UV editor](#)
- [Viewing and evaluating UVs](#)

# Rendering UV maps to content

## templates

If rendering the UV map to a template image with the correct resolution ("correct" referring to sufficient pixel density and square pixels) it can be used as a background image for a 2D animator. Assuming that the animator creates graphics within the geometries and lines of the UV map, the rendered content will perfectly map back again onto corresponding faces of the 3D model.

3ds Max, Maya and Cinema4d can render out the UV map to a preferred resolution with different shading options.

## Useful external link:

— [Render Uv's Dialog](#) (3ds Max)

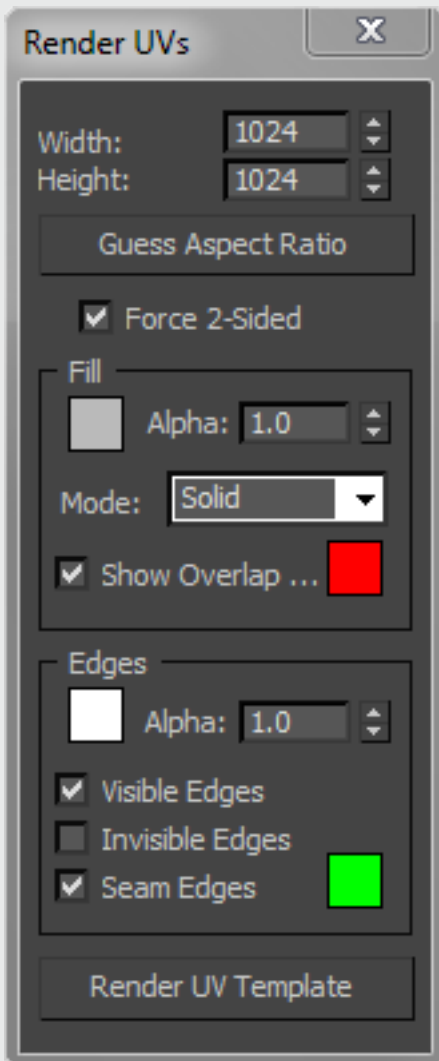



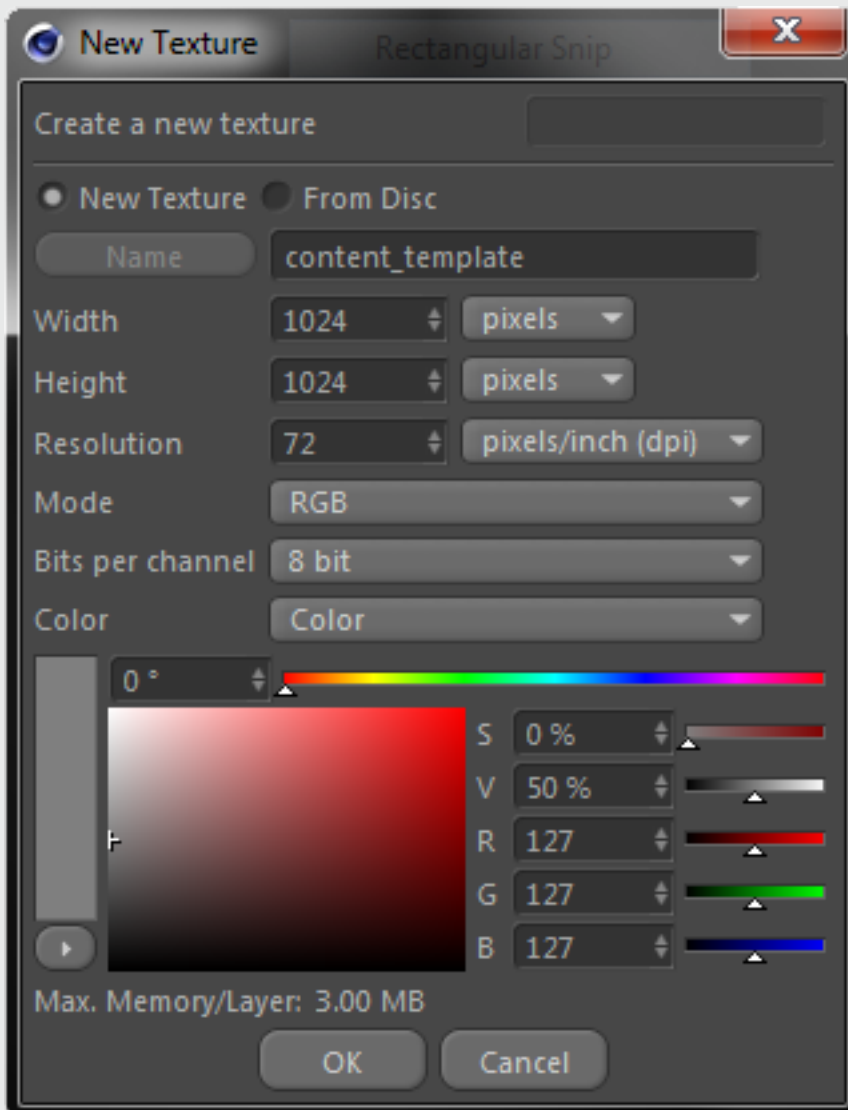

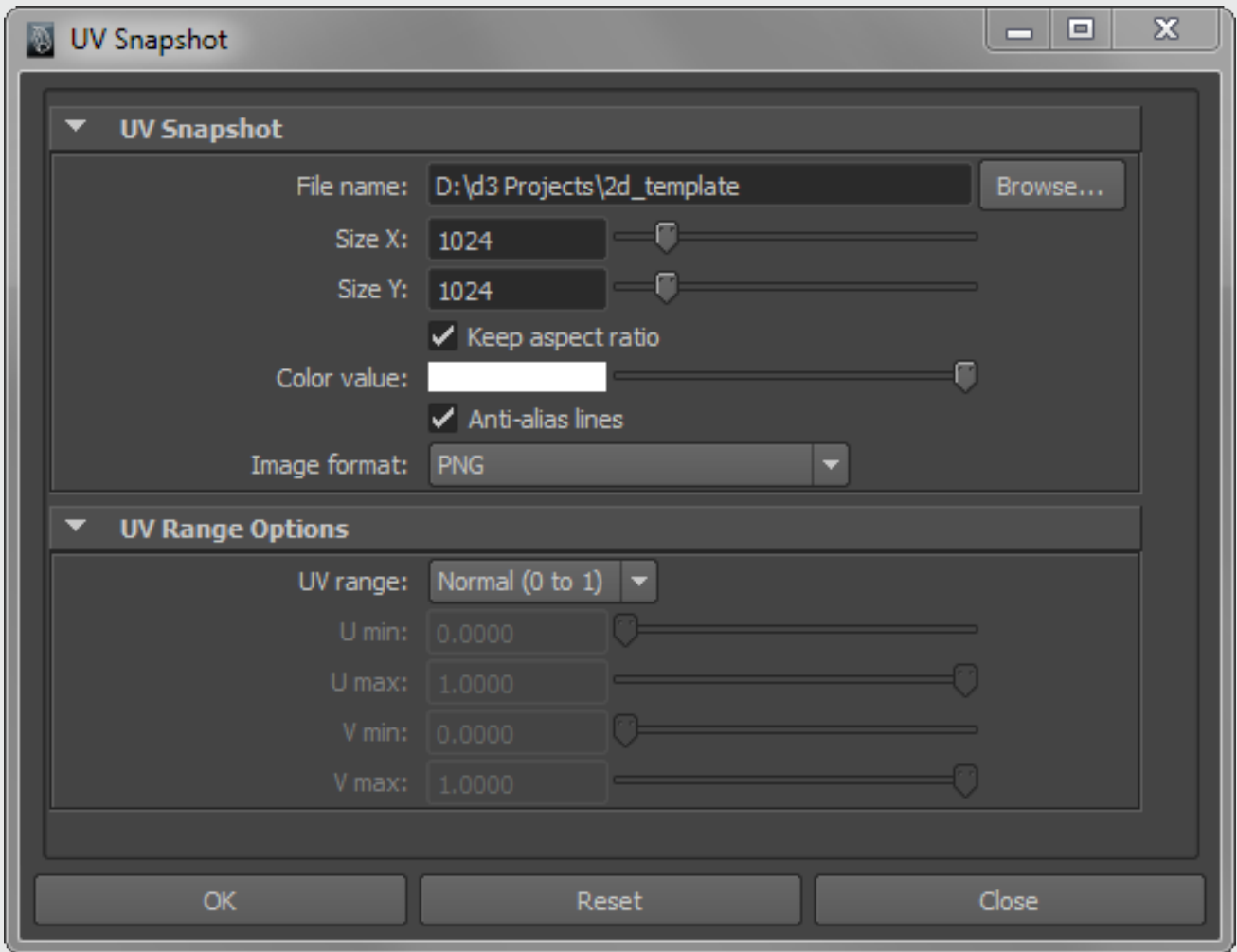

A good trick to ensure square pixels is, except applying a pixel perfect square using the bitmap layer described in the Setting resolutions and rendering UV maps page, is to also bring the rendered UV template into Photoshop and add a perfect square and circle to it. If applying the template as Direct map inside Disguise software, the square and circle should still appear as a perfect square and circle. If not, your resolution is set incorrectly. In order to verify correct mirroring of the UV coordinates, and to give the content creator an idea what screen his making content for it's also a good idea to write the name of the screen and its resolution.

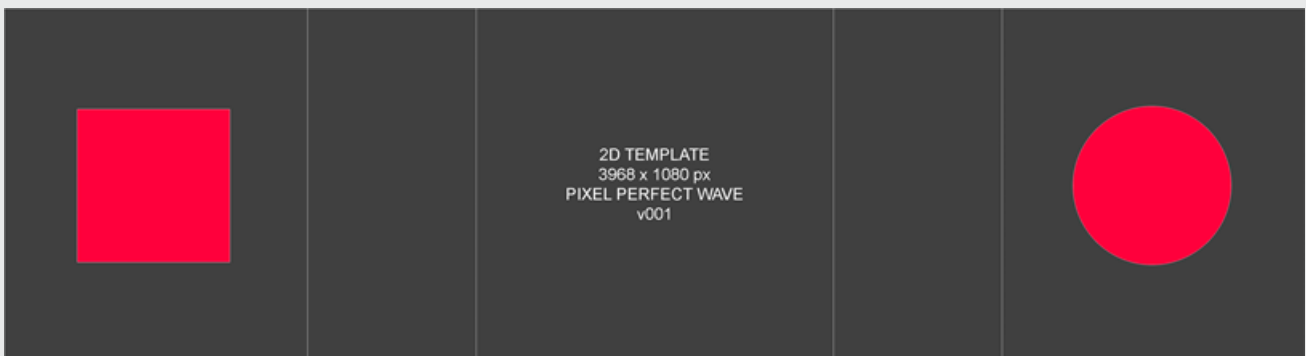

For complex unwrapped surfaces you may need to highlight specific areas in the 2D unwrapped template, apply the template in Disguise and make a screenshot of it being applied onto the screen.

The animator can now know what area in the 2D template that represents what part on the 3D model. Of course, best approach is that the content creator has a copy of Designer so he/she can test out the content himself.

# The UV map as the content template

As explained on the previous page, the UV map determines the output to the LED processor. However, preparing UV maps for projection surfaces requires a different workflow.

Normally the projection surface is unwrapped into a texture that the content creator can generate video content from, in a similar way to how artists texture 3D models in the video games industry. The UV map is rendered into a content template to be placed as a background in Adobe Photoshop, Illustrator, After Effects or any other image / video editing application. The template's resolution is calculated from two variables: aspect and density.

- The template's aspect ratio should match the UV map's to enable square pixels. This requires knowing precisely how the UV coordinates have been mapped to the 3D model. If the aspect is calculated incorrectly the rendered content may appear stretched across the projection surface.
- The template's pixel density should match, or preferably exceed, the projector's to enable a 1:1 pixel density. This requires knowing precisely how many pixels produced by the projector will hit the projection surface. If the density is calculated incorrectly the content may appear pixelated across the projection surface.

When video content has been rendered from the content template, it can then be Direct mapped to the screen in Disguise. The content will map perfectly to the 3D model if the UV map for the template matches the UV map for the screen. In Disguise software, virtual projectors can be configured to sample content from the screen, and in realtime the sampled content is outputted to the physical projectors. Therefore, the projector outputs are independent of the content, which means the creative workflow for the content creator is separated from the technical workflow for the hardware technicians, as explained in The UV Map as the Hardware Output page.

## Example

The example below demonstrates how the unwrapped UV map is rendered into a 2D image which can be used as a background template for 2D animations. When re-applied onto the screen in Disguise software, the same template perfectly maps onto the 3D geometry. Virtual projectors are then sampling different parts of the screen and sends the output to the physical projectors. In this example, three HD projectors are covering the screen. This example below is identical to the example on the Pixel-perfect mapping page except the details how to create the UV map.

## Step 1 - initial UV unwrap

The UV map has been unwrapped and normalised. See the [Pixel Perfect Mapping](#) page for more details how to create the UV map.

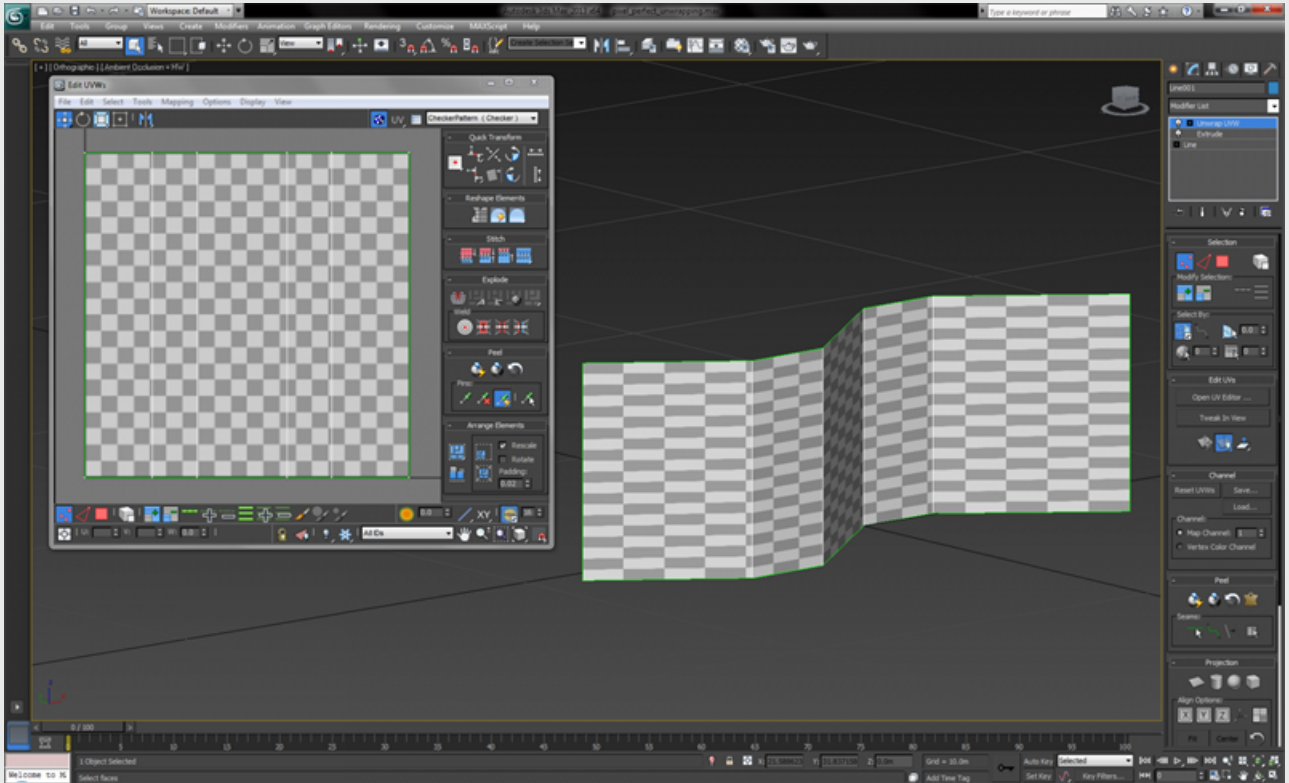

*The UV map of the linear screen has been unwrapped and normalized.*

## Step 2 - Rendering UV maps to content templates

The image below shows the content template, which was rendered from the UV map. The template's resolution was calculated by:

- Knowing precisely how many pixels produced by the projector will hit the projection surface, across either the horizontal or vertical axis.
- Dividing this value by the projection surface's dimension across the chosen axis, to calculate a pixel density.
- Multiplying the pixel density by the remaining axis' dimension, to calculate its resolution.

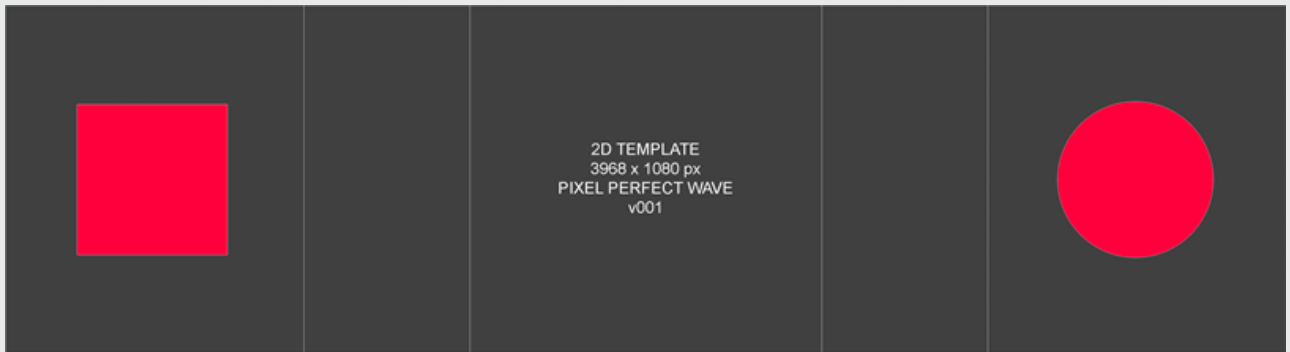

*UV map rendered to a content template.*

It is important to measure the projection surface's dimensions based on the UV map. In this case, the total length of the extruded spline should be measured, because the extrusion automatically generated the normalised UV map.

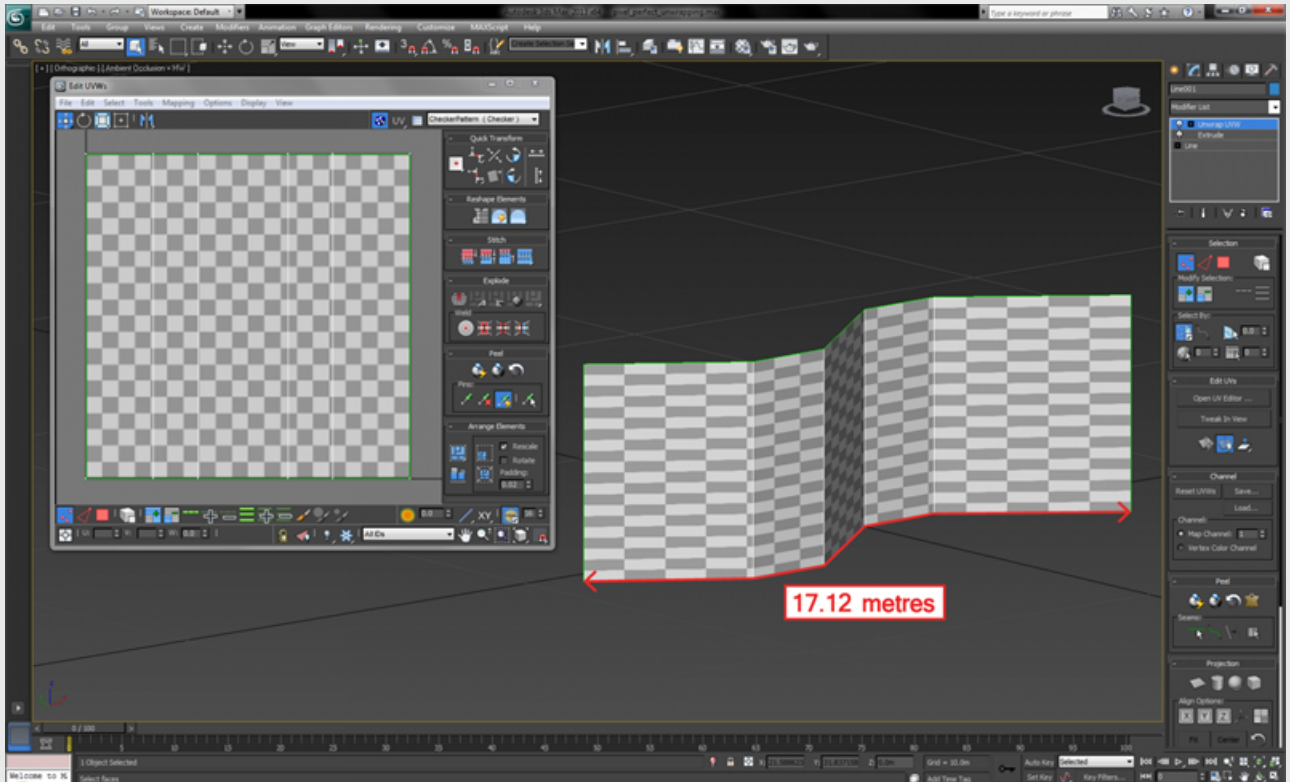

By calculating both the template's horizontal and vertical resolutions from a single pixel density value, the content should enable square pixels. This is important because if the resolution is calculated incorrectly the content may appear stretched across the projection surface. The template's resolution is 3698x1080 pixels. This was calculated by:

- Knowing approximately 1080 pixels will hit the projection surface vertically.
- $1080 \text{ pixels} / 5 \text{ metres (the projection surface's height)} = 216 \text{ pixels per metre (hitting the projection surface vertically)}$ .
- $216 \text{ pixels} \times 17.12 \text{ metres (the projection surface's length)} = 3698 \text{ pixels (the horizontal resolution)}$ .

As a result, the aspect of the template's resolution should match that of the surface's dimensions. This can be checked by:

- Dividing the template's horizontal resolution by the vertical resolution.
- Dividing the surface's length by the physical height (remember to base the measurements on the UV map, explained earlier).

In this case:

- $3698 / 1080 = 3.424$
- $17.2 / 5 = 3.424$

Both values are matching, which indicates the template's resolution is correct. To double-check this, a uniform square and circle should be drawn on the template in an image editing application, for example [Adobe Illustrator](#), before the template is exported to Disguise. If the square and circle appear uniform across the screen in Disguise the template's resolution is correct.

## Step 3 - Mapping content to screens

The image below shows the content template directly mapped to the screen in Disguise, which was exported as an .obj file from 3ds Max. In Disguise software, three HD virtual projectors have been configured to sample content from the screen. Each virtual projector samples a different part of the screen, and in realtime the sampled content is outputted to the physical projectors by three unique feeds.

**Please note:** Remember to set the resolution of the screen in Disguise to match the content template by opening the [Screen editor](#).



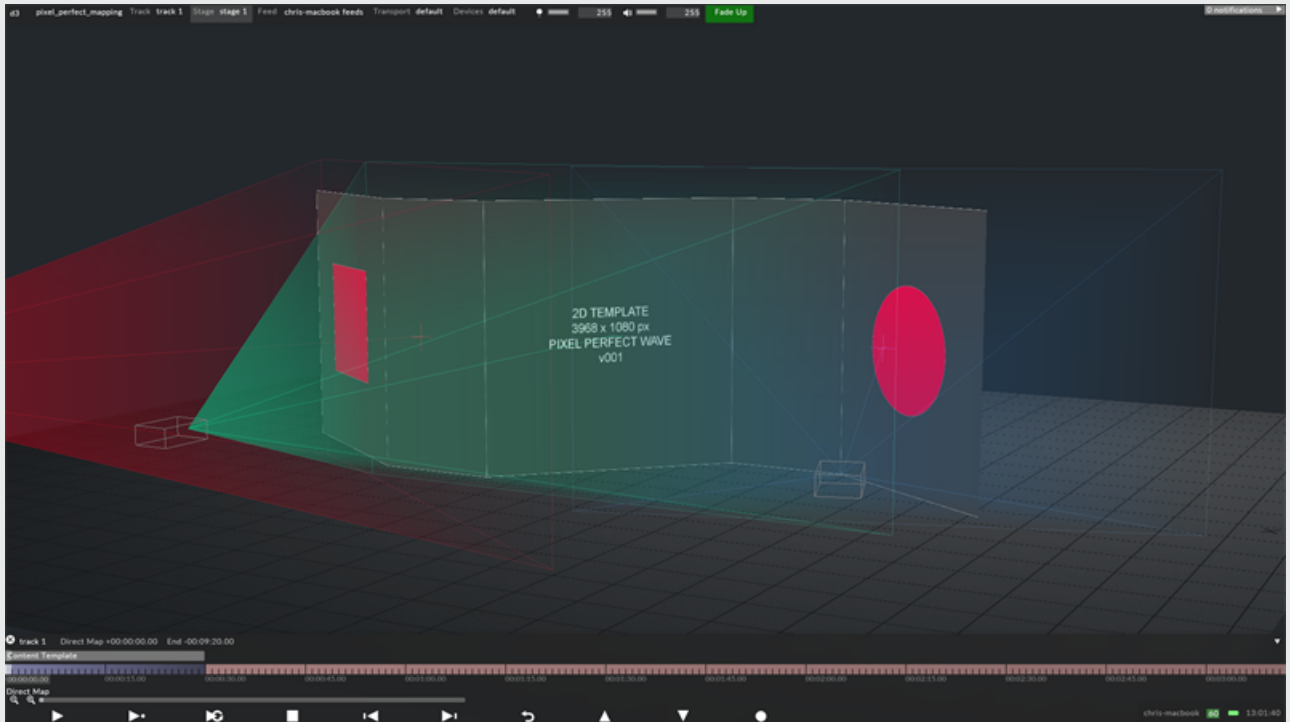

Template re-applied on the screen in Disguise.

## Step 4 - Outputting content to projectors

The image below shows the three unique feeds to be outputted to the physical projectors. If a virtual projector changes position its corresponding output will automatically update in realtime to show the virtual projector's updated point of view. Therefore, if a virtual projector's position changes onsite, content does not require re-rendering, because the outputs are independent of the content. To read more about Disguise's projector simulation toolkit see the [Projector simulation](#) chapter, which explains how to [quick calibrate](#), [warp](#), and [blend](#) projectors.



*The automatically generated outputs from the three virtual projectors.*

## Helpful Resources

- [Unwrapping UV maps 3ds Max](#)
- [Unwrapping UV maps in Maya](#)

# The UV map as the hardware output

Direct mapping means that content is being applied directly onto the UV map of the screen's mesh, inside Disguise's visualiser. But the UV map itself, set to the assigned resolution by the screen editor also turns into the output that can be added to the displayhead and further sent to the LED processor. The output is captured by the processor pixel per pixel and sent to the physical LED technology. As LED processors only can capture strict rectangular outputs it is therefore necessary to generate a precise grid-like UV map for LED screens.

## Creative and Technical workflow separation

With Disguise software's advanced capabilities of mapping surfaces in various ways (using the different Mapping types), you are not bound not to make content only according to the layout of the UV map or resolution of the screens. Content can for example be virtually projected using a Parallel map, Perspective map, Cylindrical map, Radial map, or re-distributed using a Feed map. Only when using a Direct Map the content is applied directly onto the UV coordinates. When virtually projecting the content onto the pixels using a Parallel map the content instead gets "baked" it into the respective UV maps of all screens included in the map while the output always stays in the format of the UV maps.

With this unique system, you can use multiple content templates (i.e. mapping types) throughout your project while the outputs always stay in the same format defined by the UV map of the screens. As a result of this the content workflow and the technical output get separated; the content people can work from content templates that don't reflect the layout of the outputs.

In the example below a screen made of 20 MiStrips receives content from a Parallel map. The Parallel map virtually projects the content into the UV coordinates of the object, i.e the content gets baked into the UV coordinates as explained above. However, the output is still in the format of the UV map and is to be captured by a LED processor.

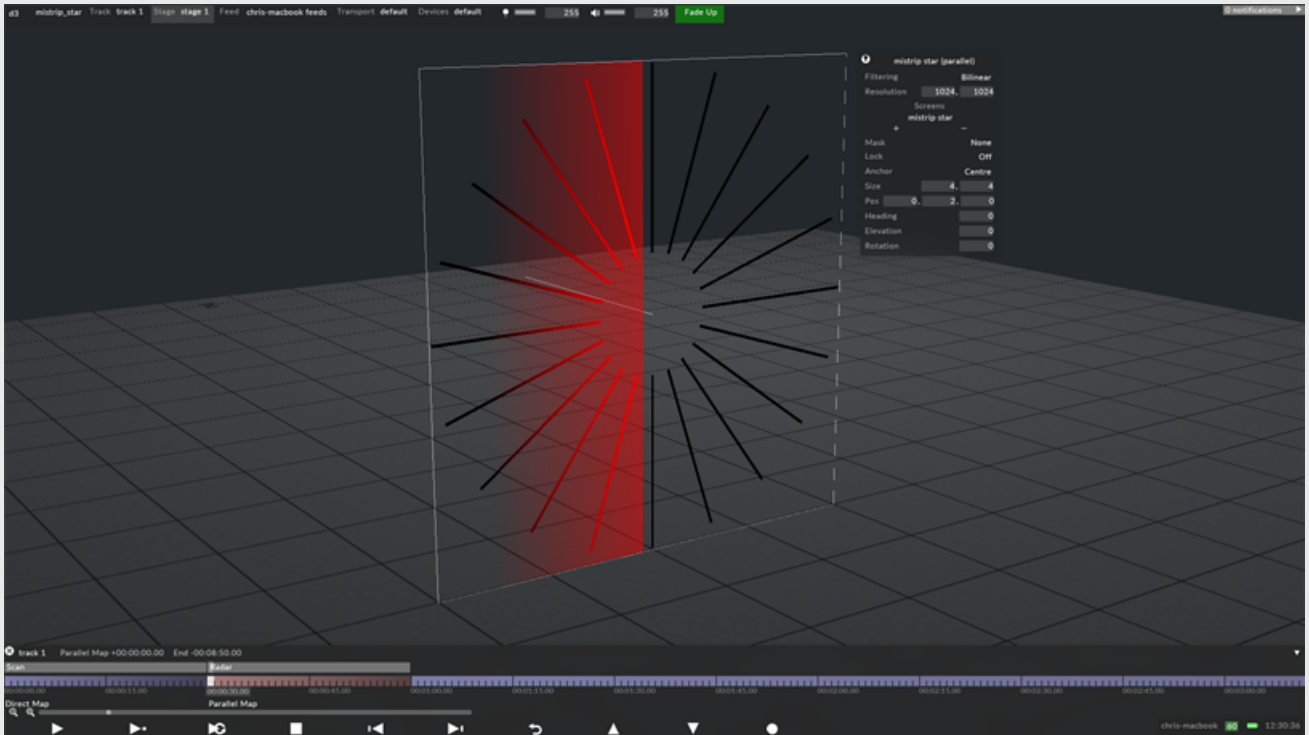

Content rendered out onto a display head for an LED processor to receive from Disguise.

## Re-configure the outputs

If the output does not match the LED processor's specifications, it can be reconfigured using Disguise's quick editing controls including the ability to re-position, chop, mirror, and rotate the output.

This allows for even more freedom and separation between the creative and technical workflow.

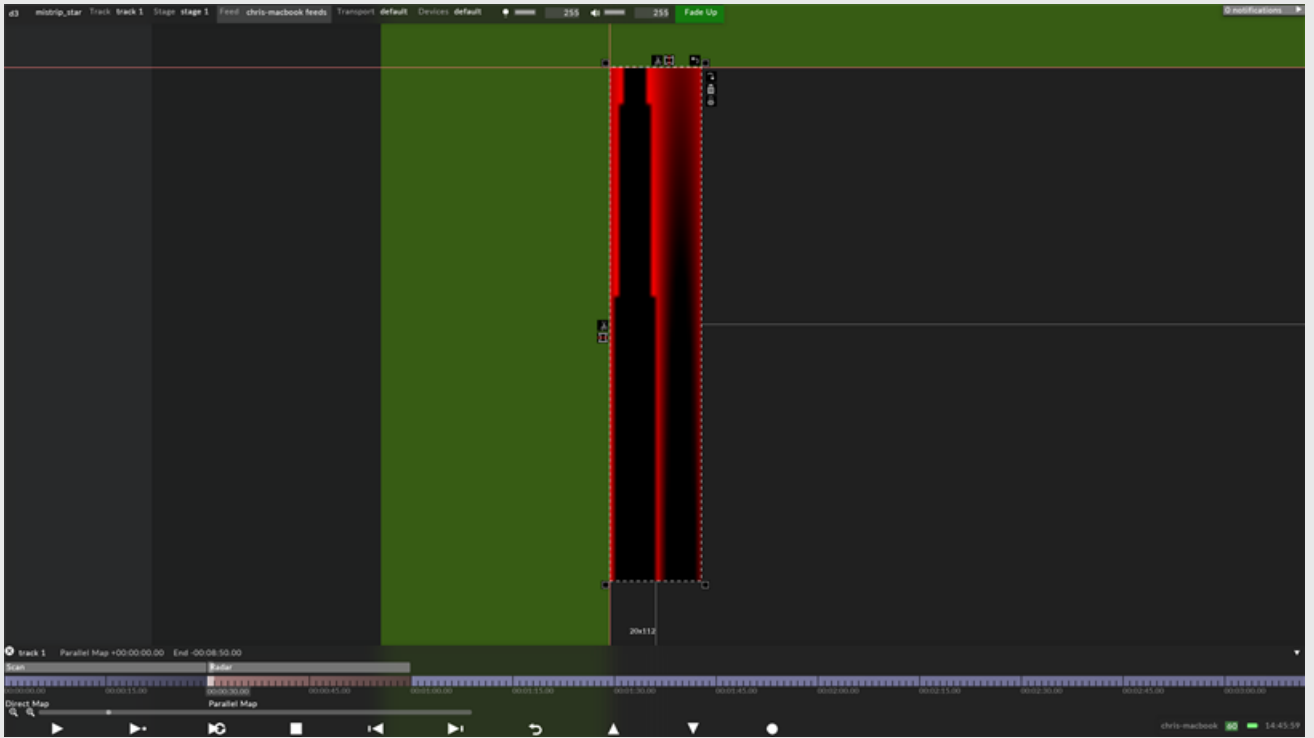

Same example as above but the output has been reconfigured using Disguise's quick editing controls.

# Projection Examples Overview

This sub-chapter will teach you how to UV map Projection screens for Disguise software. The following examples revisit the UV mapping principles covered in the previous sub-chapter. Therefore, it is recommended to read this first.

Topics include:

- Cylindrical Mapping
- Pelt Mapping
- Perspective Mapping
- Pixel Perfect Mapping
- Planar Mapping
- Shrink Wrapping
- Spline Mapping



# Projection Examples Overview

This sub-chapter will teach you how to UV map Projection screens for Disguise software. The following examples revisit the UV mapping principles covered in the previous sub-chapter. Therefore, it is recommended to read this first.

Topics include:

- Cylindrical Mapping
- Pelt Mapping
- Perspective Mapping
- Pixel Perfect Mapping
- Planar Mapping
- Shrink Wrapping
- Spline Mapping





# Cylindrical mapping

Cylindrical mapping is suitable for projection surfaces wrapping around 360 degrees, for example a cylinder or a bottle.

## How the UV map is generated

The Cylindrical map will **cylindrically** project UV coordinates to the surface, by **arraying** the map around 360 degrees. This will enable **symmetrical** content to flow across the surface **smoothly**. However, because the UV map is joined at a seam, **asymmetrical** content will **not** flow around the surface smoothly.

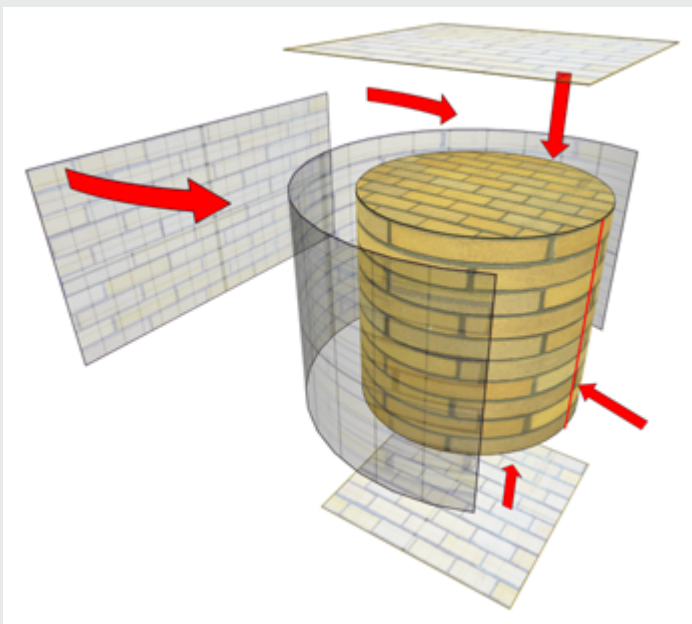

# Step 1 - Generating the UV map (3ds Max)

1. Select the UVW Map modifier.
2. From the list of projection types select **cylindrical**.
3. The cylindrical map will project UV coordinates from its normals to the surface. Therefore, it is necessary to fit the cylindrical map's position, orientation and scale to the surface.
4. Select the Unwrap UVW modifier.
5. Open the Edit UVWs window to view the UV map.

The image below shows a **non-uniform** checker pattern rendered to the surface, which indicates the UV map has an **uneven** distribution of UV coordinates. To fully unwrap the surface the UV map should be *relaxed*.

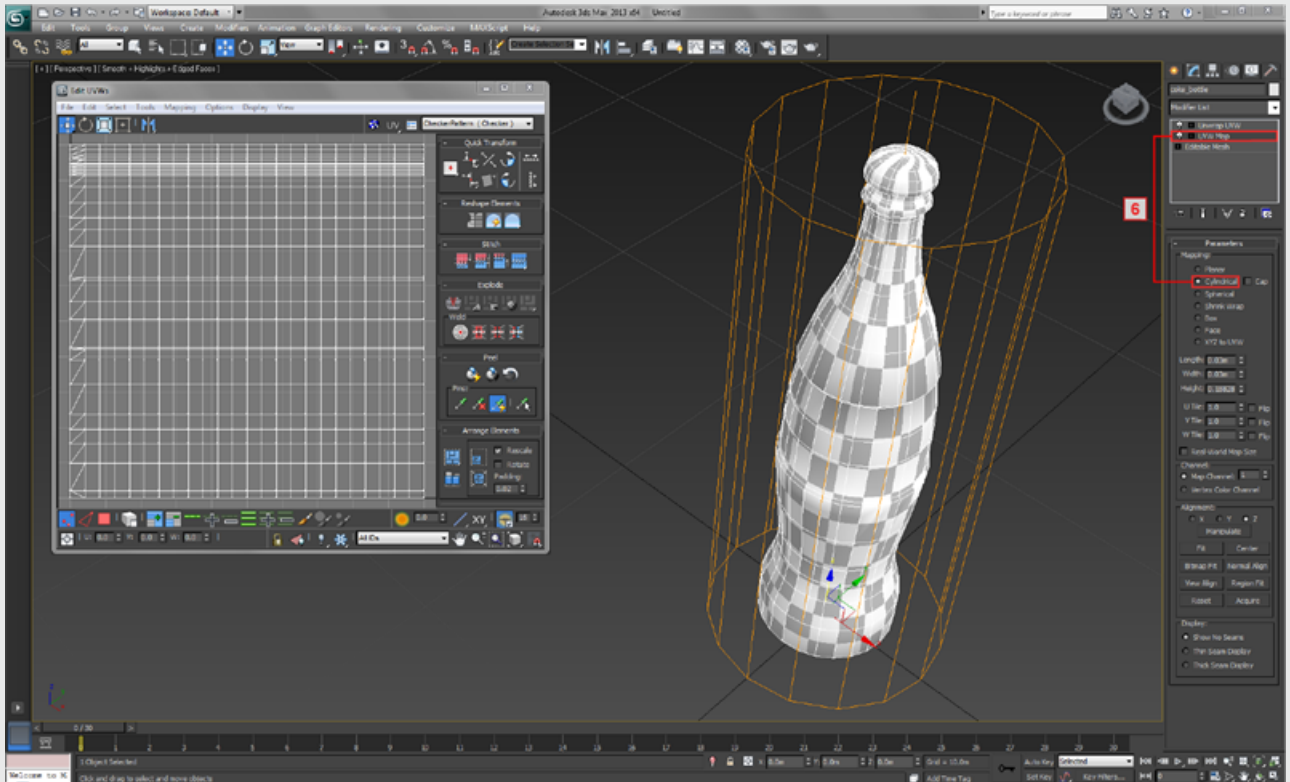

A 3D model of a coke bottle cylindrically mapped in 3ds Max.

## Step 2 - Rendering UV maps to content templates

The images below show two content templates mapped to the screen in Disguise software. The template's resolution was calculated by following the same technique used for Shrink wrapped projection surfaces, because when a surface is Cylindrically mapped it is problematic to calculate the resolution **mathematically**.

If a **horizontal** line is drawn across the template, in Disguise it will seamlessly map to the screen.

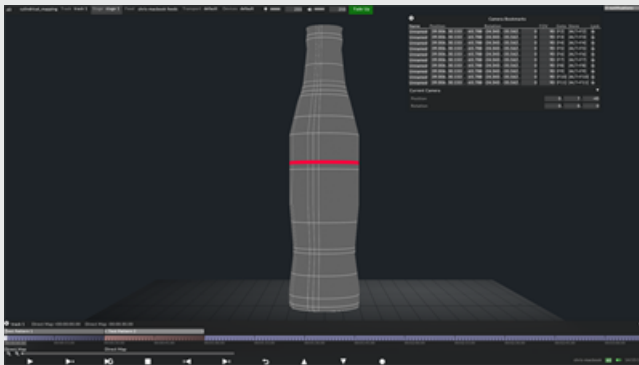
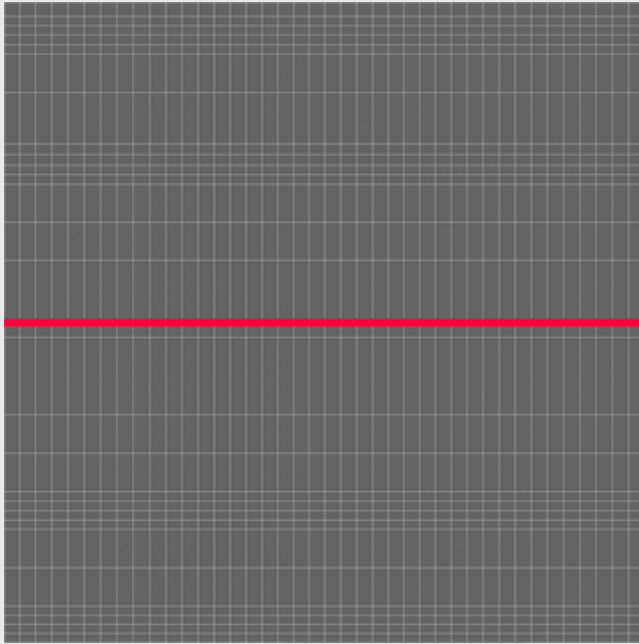

A 2D content template rendered from 3ds Max and applied to the coke bottle in Disguise. Notice how the horizontal line maps onto the 3D model seamlessly.

If a **diagonal** line is drawn across the template, in Disguise it will reveal a seam when mapped to the screen.

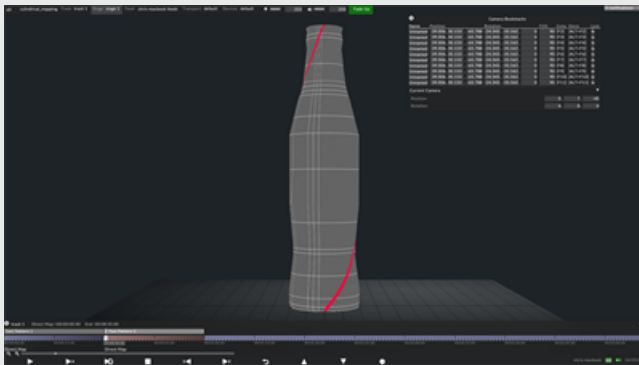
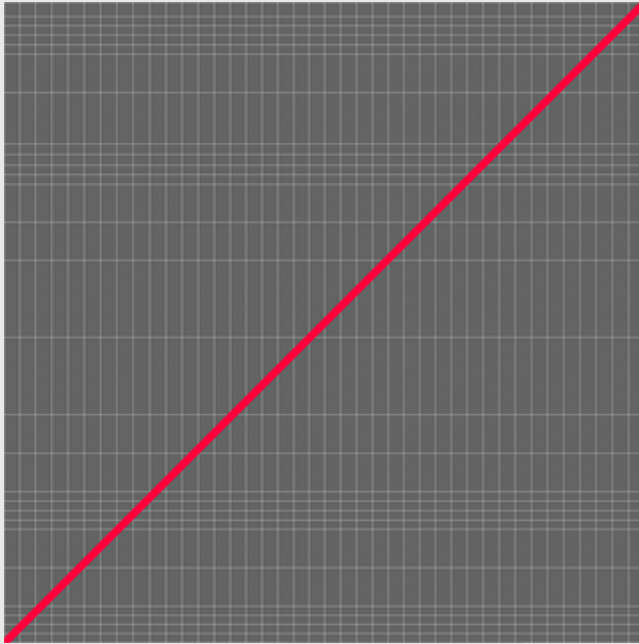

A 2D content template rendered from 3ds Max and applied to the coke bottle in Disguise. Notice how the diagonal line reveals a seam at its start and end points.

## Helpful resources

- [Projecting cylindrical maps in 3ds Max](#)
- [Unwrapping UVs in 3ds Max](#)
- [Editing UVs in 3ds Max](#)
- [Flattening UVs in 3ds Max](#)
- [Unfolding UVs in 3ds Max](#)
- [Rendering content templates in 3ds Max](#)

# Pelt mapping

Pelt mapping is suitable for projection surfaces curving across multiple axes, which are problematic to unwrap using other mapping types, for example a body or a head.

## How the UV map is generated

The Pelt map features a **stretcher** that can be manipulated by **springs** to **pull** the UV map outwards. This enables **precision** control over the UV coordinates to ensure they are **evenly** distributed across the **most** complex surfaces, which other mapping types are incapable of **completely** unwrapping.

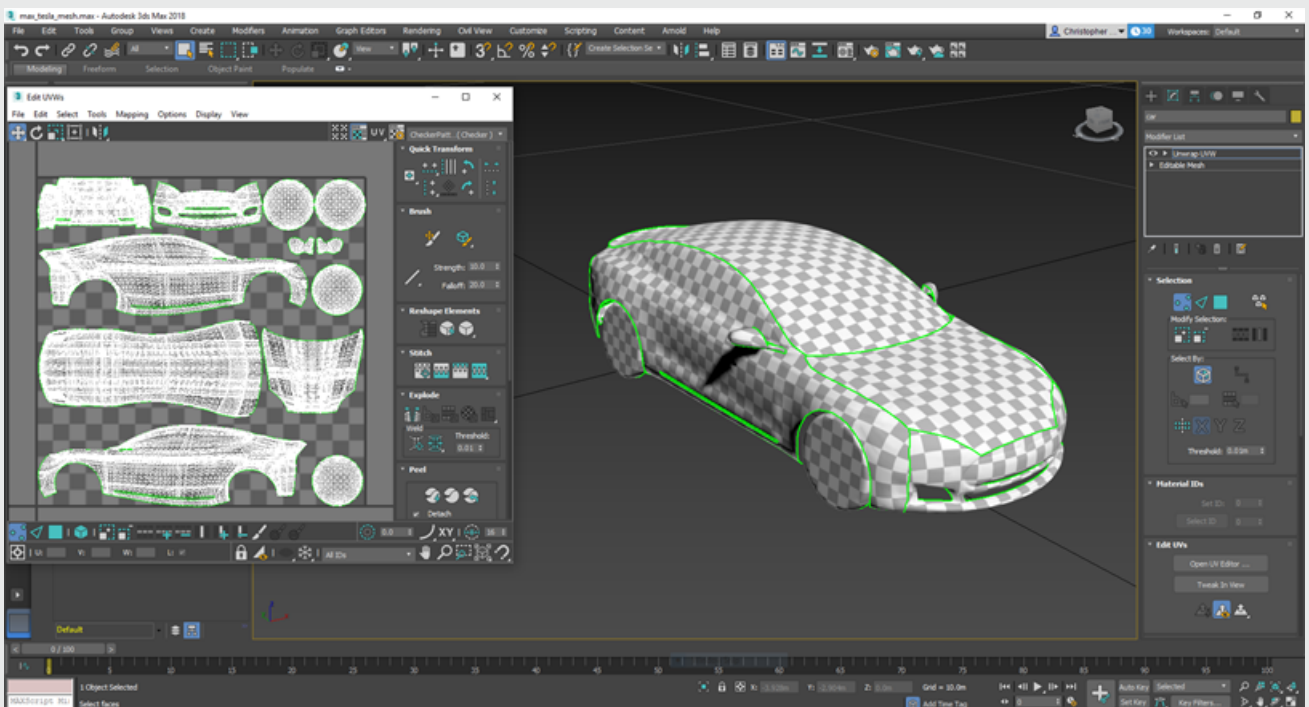

# Step 1 - Generating the UV map (3ds Max)

1. Select the **Unwrap UVW** modifier.
2. From the list of projection types select **pelt mapping**.
3. Open the **Edit UVWs** window to view the UV map.

The image below shows a **non-uniform** checker pattern rendered to the surface, which indicates the UV map has an **uneven** distribution of UV coordinates.

4. To fully unwrap the surface the pelt map's stretchers should be **pulled** outwards until the UV map **accurately** represents the **true** shape of the projection surface.



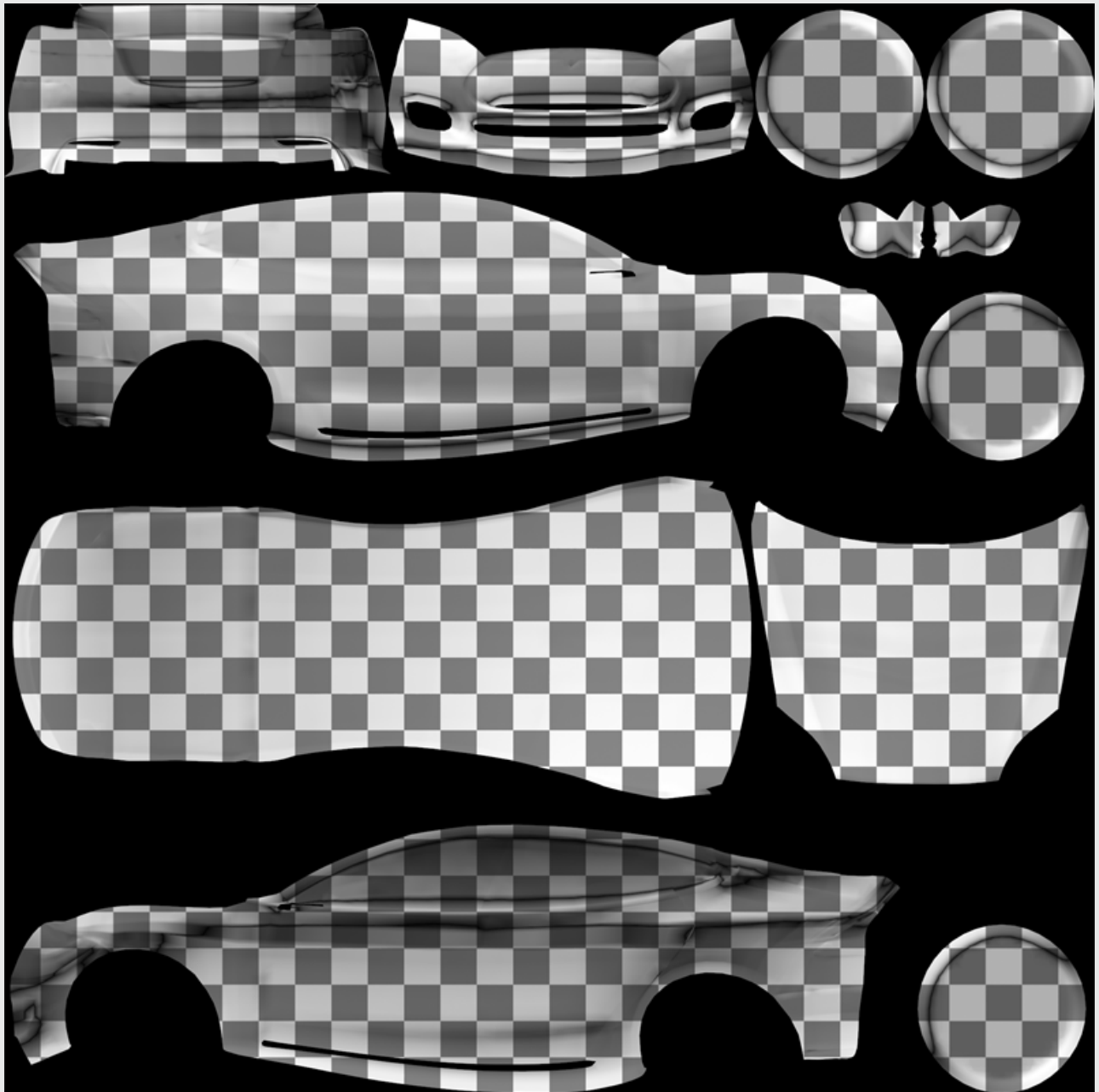

*A 3D model of a car pelt mapped in 3ds Max.*

## Step 2 - Rendering UV maps to content templates

The image below shows the content template mapped to the screen in Disguise. The template's resolution was calculated by following the same technique used for Shrink wrapped / Cylindrical mapped projection surfaces, because when a surface is Pelt mapped it is problematic to calculate the resolution **mathematically**.

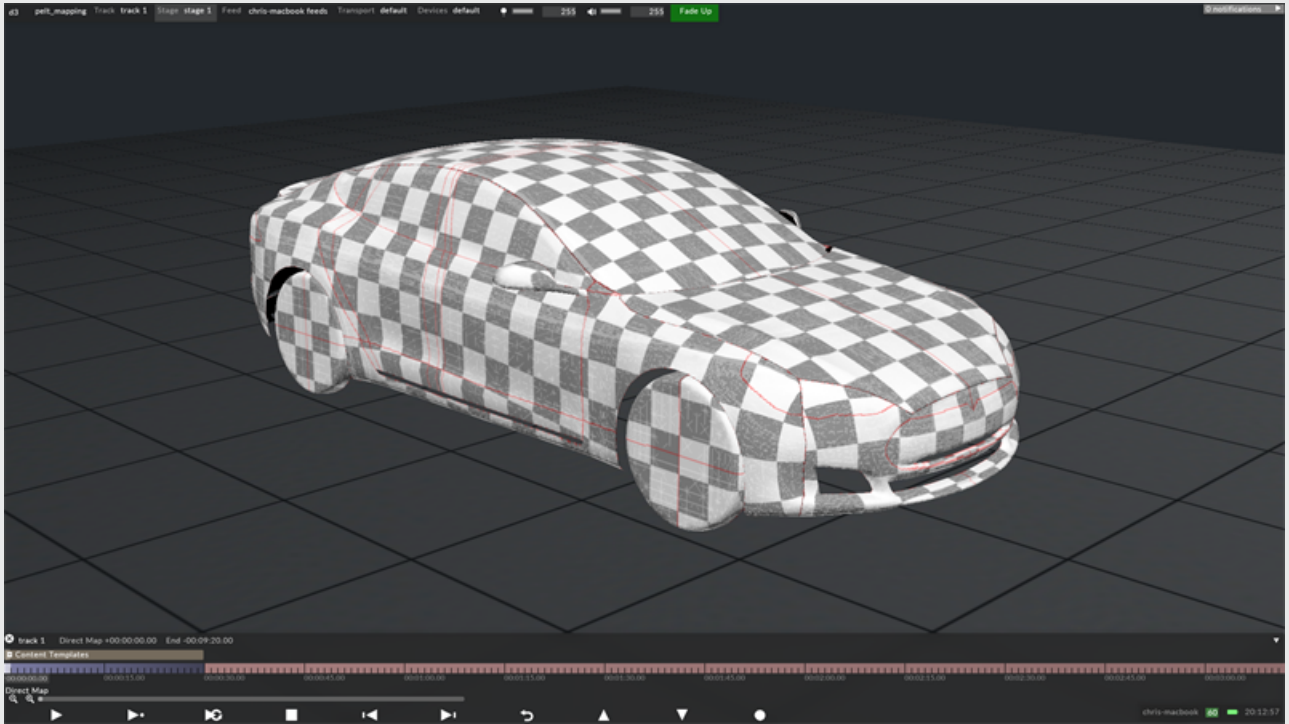

For more information:

[Autodesk 3ds Max Learning center](#)

# Perspective Mapping

Perspective mapping is suitable for projection surfaces to display content rendered to a single point of view, for example building blocks animating into a building. However, perspective mapping is also suitable for 2D content, as explained below.

## How the UV map is generated

A camera can perspective project UV coordinates from its point of view to the surface. The UV map can then be rendered to a content template to be placed as a background in Adobe After Effects. Here the content creator can render 2D content and in Disguise software the content will map perfectly to the screen. The 2D content will appear correct from any point of view.

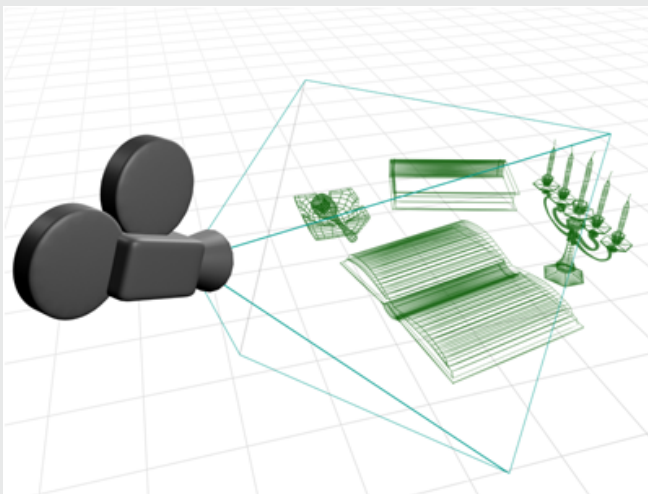

In a 3D application the content creator can also render 3D content by rendering 3D effects from a camera's point of view. The render camera should match the position of the previous camera, and the 3D content should be rendered to a resolution that matches the 2D content. The mapped 3D content will only appear correct from the render camera's point of view. Therefore, both cameras should be positioned to the point of view from which the audience will view the projection surface.

## Step 1 - Generating the UV map (3ds Max)

1. Create a camera in your 3D scene.
2. Adjust its position, field of view and zoom, to capture the surface's outer edge. In the camera's viewport safe frames can be enabled to show the captured area more clearly.
3. Select the surface and apply a Camera Map modifier.
4. From the Camera Map modifier pick camera. The camera will perspective project UV coordinates onto the surface.
5. Select the Unwrap UVW modifier.
6. Open the Edit UVWs window to view the UV map.

The image here shows a non-uniform checker pattern rendered to the surface. However, from the camera's point of view the UV map will appear to have an even distribution of UV coordinates.

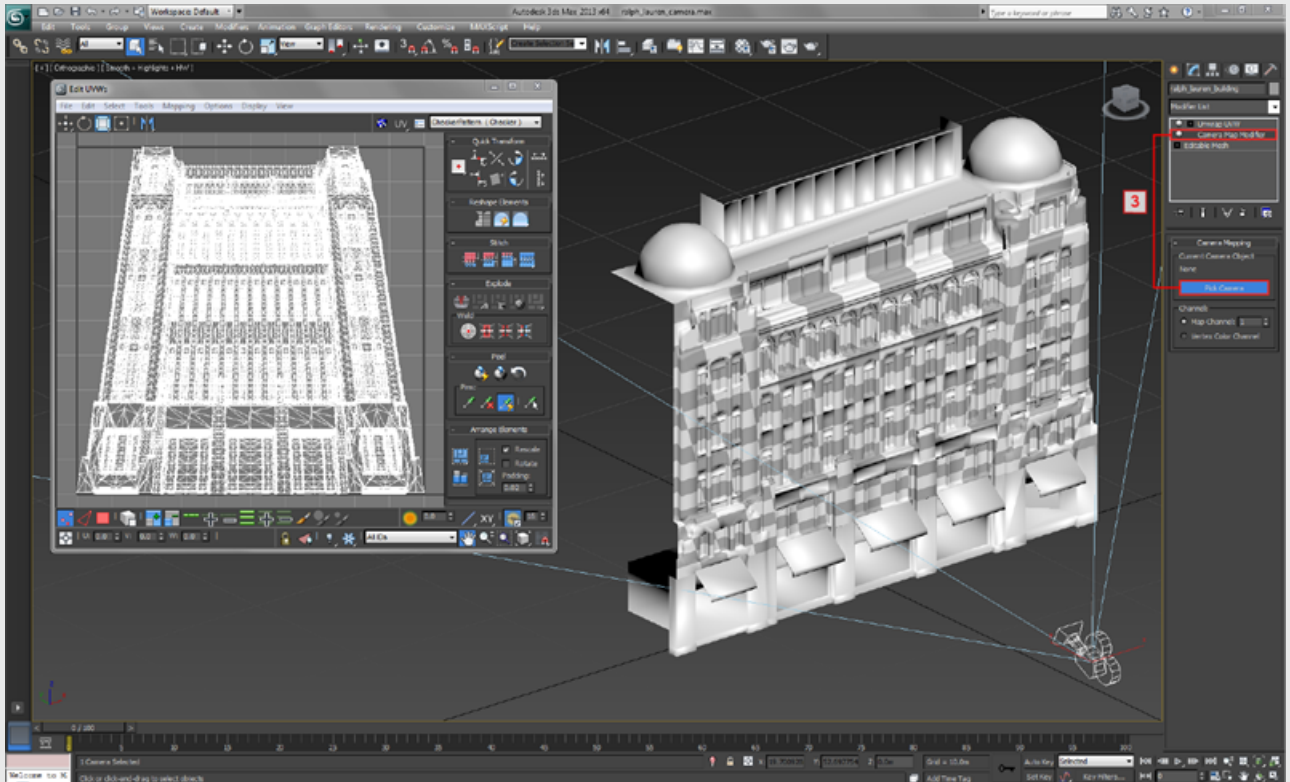

## Step 2 - Rendering UV maps to content templates

- The images below show the content template and how its resolution was calculated. The template's resolution was calculated from the render settings set to generate 3D content, because when a projection surface is perspective mapped the UV map can be used to generate both 2D and 3D content. Therefore, the 2D and 3D content should match in resolution.
- The UV map can be rendered to a template to be placed as a background in Adobe After Effects, to generate 2D content.
- The UV map can have animated geometry baked into it in a 3D application, for example 3ds Max, to generate 3D content.

The template's resolution is 4096x1576 pixels. This was calculated by:

- Knowing the aspect ratio of the camera's output (this is automatically generated by the camera output's width and height, shown in the render settings).
- Knowing precisely how many pixels produced by the projector will hit the projection surface, across either the horizontal or vertical axis.
- Multiplying or dividing this value by the aspect ratio, to calculate a resolution for the remaining axis.

Therefore, the following calculations apply:

- The camera's output has an aspect ratio of 2.599.
- Approximately 4096 pixels will hit the projection surface horizontally.
- $4096 \text{ pixels} / 2.599 = 1576 \text{ pixels}$  (the vertical resolution).

# Render settings from 3ds Max.

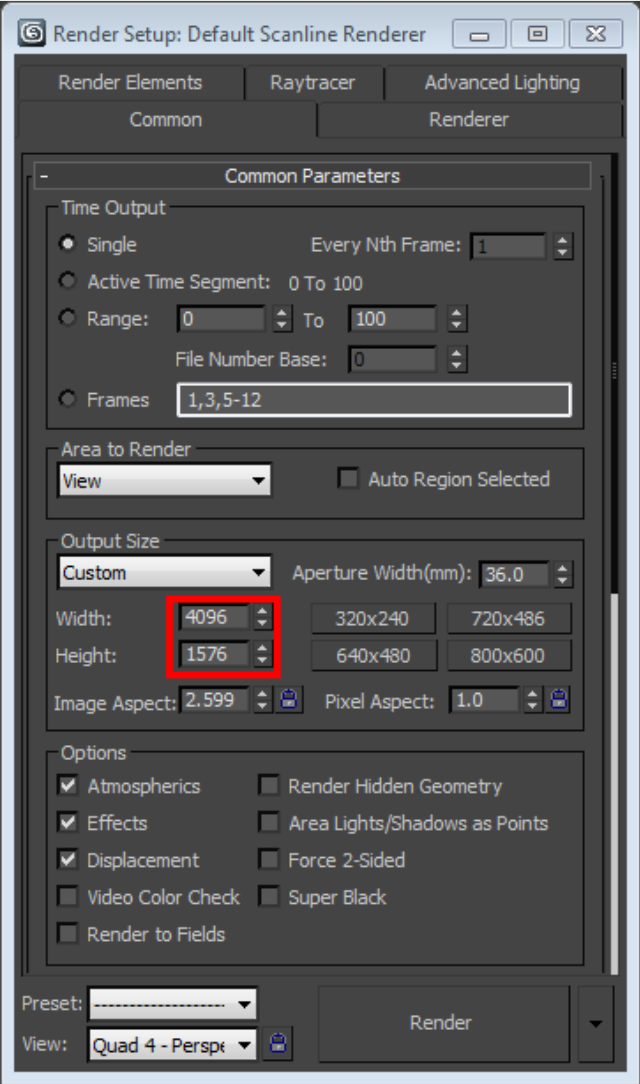

The images below show the content template and examples of 2D and 3D content rendered from the UV map.



*A 2D content template of the Ralph Lauren London Flagship Store rendered from 3ds Max.*

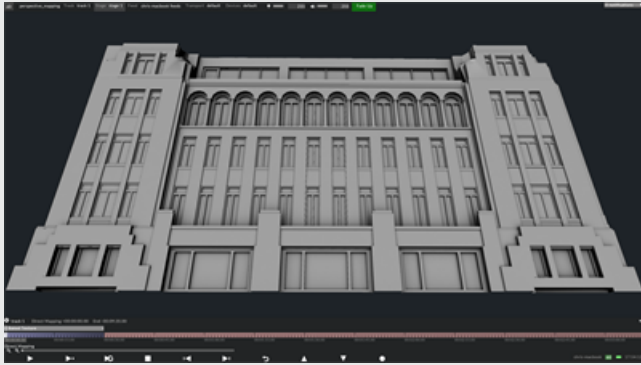



# Pixel-perfect mapping

Pixel-perfect mapping is suitable for projection surfaces bending across one axis, for example a wall constructed from multiple angled surfaces.

## How the UV map is generated

A spline can be **extruded** to recreate the surface with the UV map **automatically generated**. Because the UV coordinates are generated by the extrusion, the UV map will have a **perfectly** even distribution of UV coordinates.

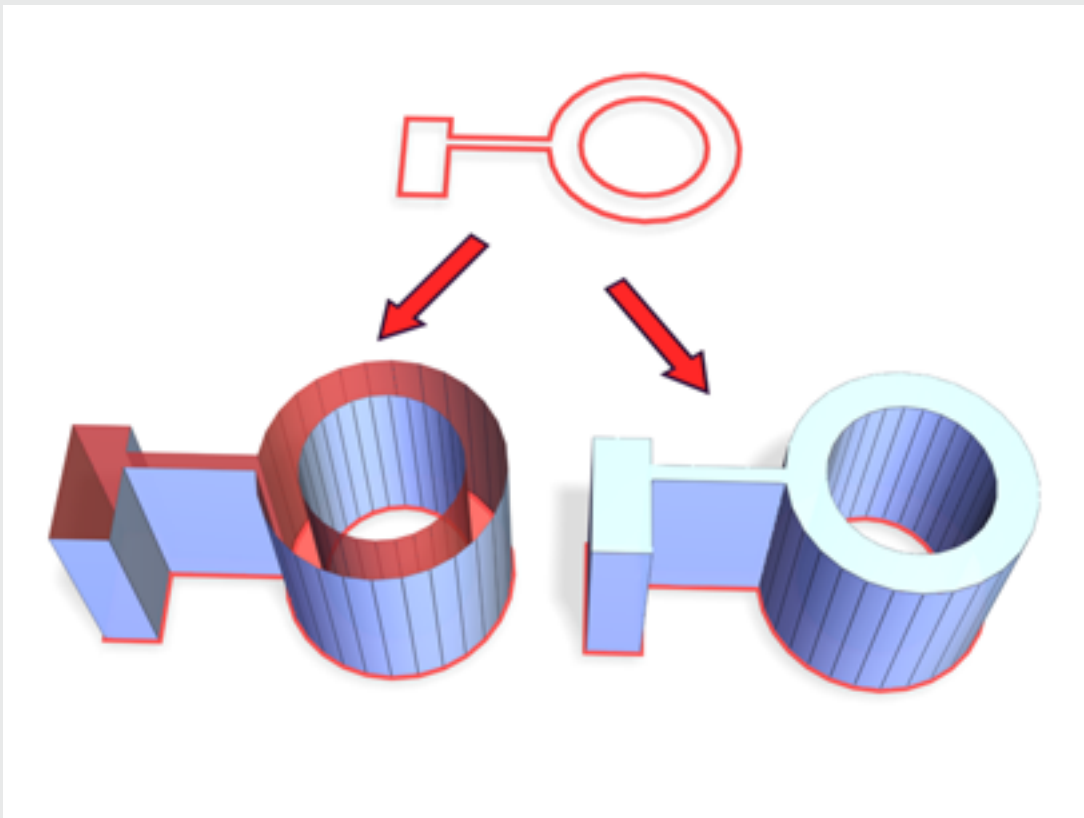

## Step 1 - Generating the UV map (3ds Max)

1. Draw a spline that traces the surface's bottom edge.
2. Apply an Extrude modifier to extrude the spline to match the surface's height.
3. Ensure you have the box called **generate mapping coordinates** checked when extruding the spline. Doing so will enable the extrusion to automatically generate a normalised UV map.
4. Select the Unwrap UVW modifier.
5. Open the Edit UVWs window to view the UV map.
6. Check the UV coordinates are correctly **flipped** by comparing the positions of the surface's vertices to the UV map's texture coordinates. Before performing the check, ensure the surface is orientated and viewed in a south-north (front-back) direction. The image below shows the surface's top-left vertice corresponds to the UV map's top-left texture coordinate. This is correct. If the UV coordinates were incorrectly flipped, in Disguise, the video content would be **mirrored** across the screen when Direct mapped, for example a **Radar** layer would scan the screen in the **opposite** direction.

The image below shows a **uniform** checker pattern rendered to the surface, which indicates the UV map has an **even** distribution of UV coordinates. If the checker pattern appeared non-uniform, i.e. the checkers were differently sized, this would indicate the UV map had an **uneven** distribution of UV coordinates.

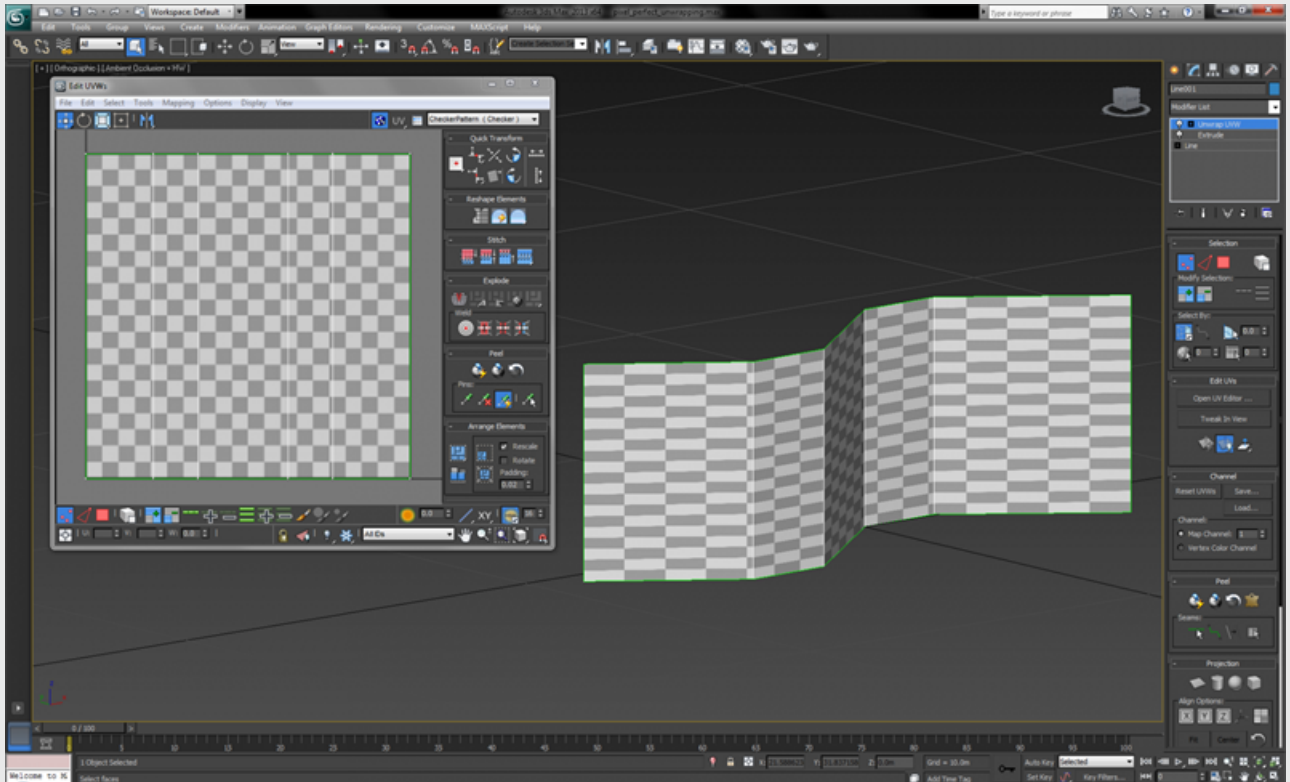

*A pixel-perfect UV mapped surface in 3ds Max.*

## Step 2 - Rendering UV maps to content templates

The image below shows the content template, which was rendered from the UV map. The template's resolution was calculated by:

- Knowing precisely how many pixels produced by the projector will hit the projection surface, across **either** the horizontal or vertical axis.
- Dividing this value by the projection surface's dimension across the chosen axis, to calculate a **pixel density**.
- Multiplying the pixel density by the remaining axis' dimension, to calculate its resolution.

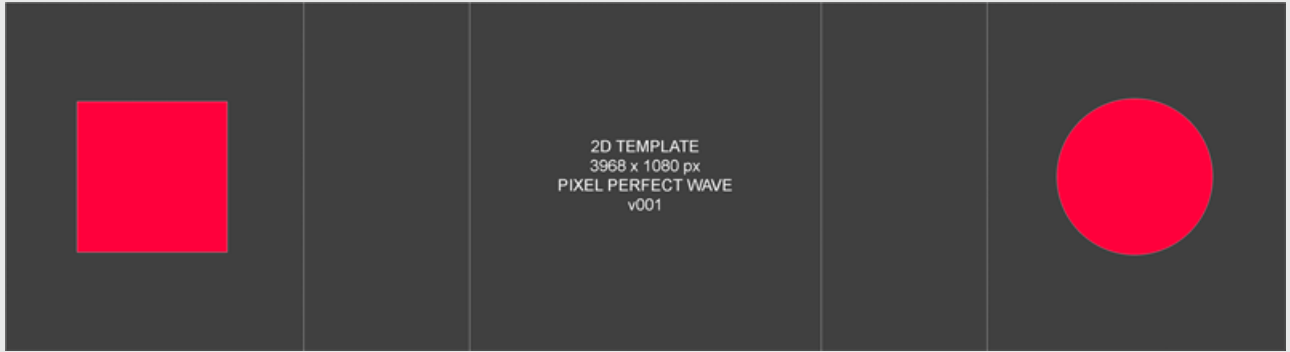

## UV map rendered to a content template.

It is important to measure the projection surface's dimensions based on the UV map. In this case, the total length of the extruded spline should be measured, because the extrusion automatically generated the normalised UV map

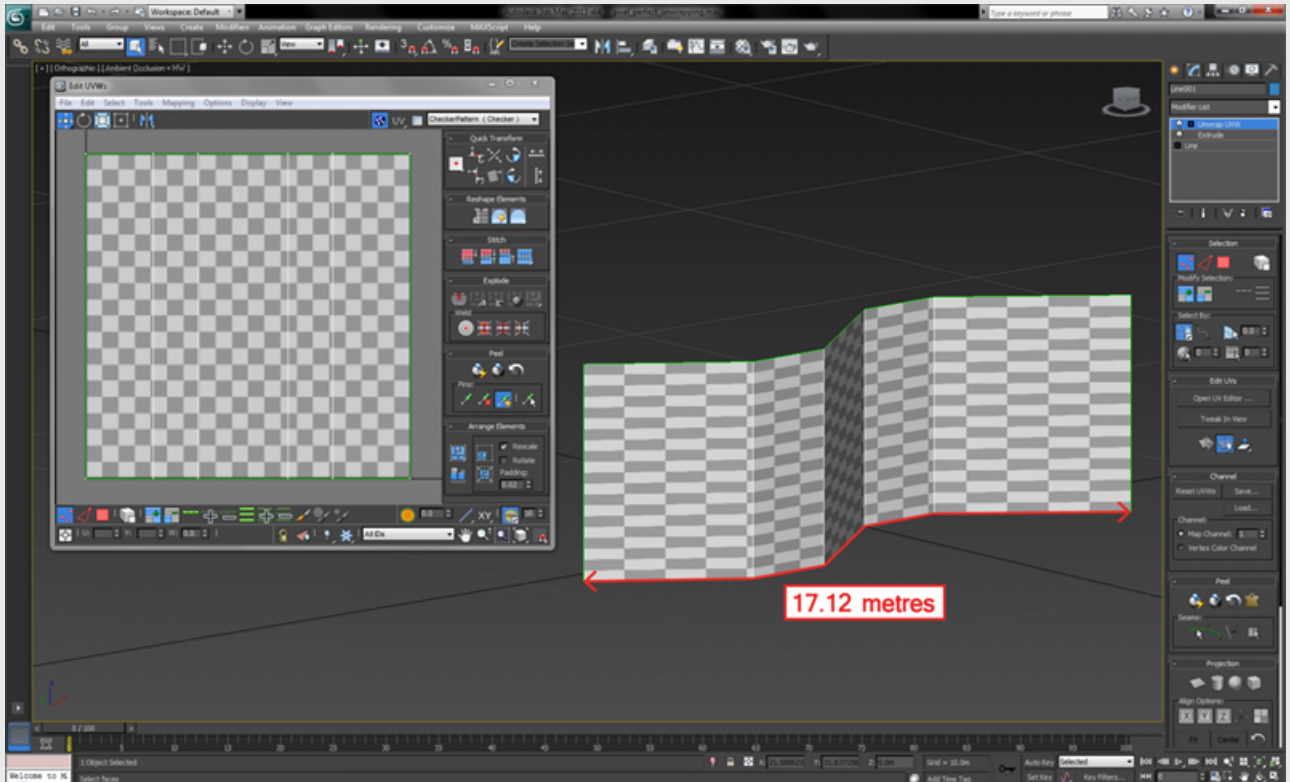

By calculating both the template's horizontal and vertical resolutions from a single pixel density value, the content should enable square pixels. This is important because if the resolution is calculated incorrectly the content may appear stretched across the projection surface. The template's resolution is 3698x1080 pixels. This was calculated by:

- Knowing approximately 1080 pixels will hit the projection surface vertically.
- $1080 \text{ pixels} / 5 \text{ meters (the projection surface's height)} = 216 \text{ pixels per meter (hitting the projection surface vertically)}$ .
- $216 \text{ pixels} \times 17.12 \text{ meters (the projection surface's length)} = 3698 \text{ pixels (the horizontal resolution)}$ .

As a result, the aspect of the template's resolution should match that of the surface's dimensions. This can be checked by:

- Dividing the template's horizontal resolution by the vertical resolution.
- Dividing the surface's length by the physical height (remember to base the measurements on the UV map, explained earlier).

In this case:

- $3698 / 1080 = 3.424$
- $17.2 / 5 = 3.424$

Both values are matching, which indicates the template's resolution is correct. To double-check this, a uniform square and circle should be drawn on the template in an image editing application, for example Adobe Illustrator, before the template is exported to Disguise software. If the square and circle appear uniform across the screen in Disguise the template's resolution is correct.

## Step 3 - Mapping content to screens

The image below shows the content template directly mapped to the screen in Disguise, which was exported as an `.obj` file from 3ds Max. In Disguise software three HD virtual projectors have been configured to sample content from the screen. Each virtual projector samples a different part of the screen, and in realtime the sampled content is outputted to the physical projectors by three unique feeds.

**Please note:** Remember to set the resolution of the screen in Disguise to match the content template by opening the Screen editor.

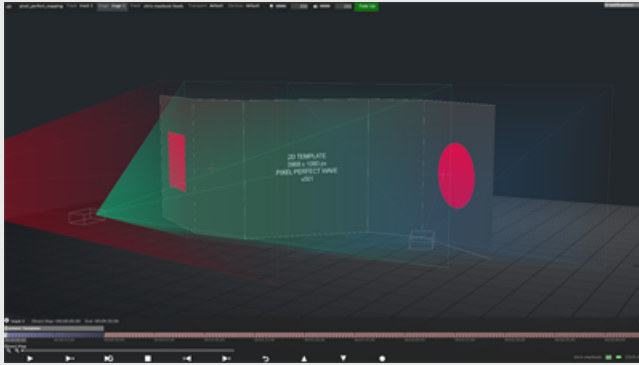

Template re-applied on the screen in Disguise.

## Step 4 - Outputting content to projectors

The image below shows the three unique feeds to be outputted to the physical projectors. If a virtual projector changes position its corresponding output will automatically update in realtime to show the virtual projector's updated point of view. Therefore, if a virtual projector's position changes onsite, content does not require re-rendering, because the outputs are independent of the content. To read more about Disguise's projector simulation toolkit see the [Projector simulation](#) chapter, which explains how to [quick calibrate](#), [warp](#), and [blend](#) projectors using Disguise software.

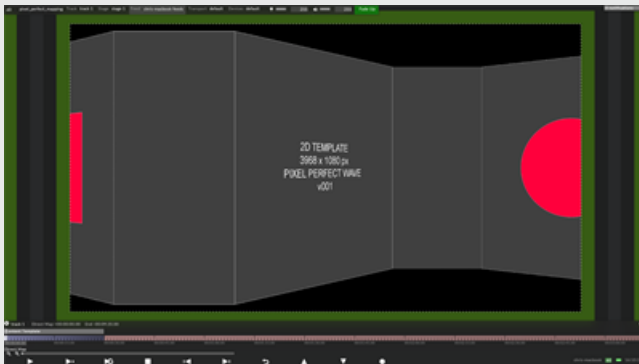

The automatically generated outputs from the three virtual projectors.

## Helpful resources

- [Drawing splines in 3ds Max](#)
- [Extruding splines in 3ds Max](#)

- Unwrapping UVs in 3ds Max
- Editing UVs in 3ds Max
- Rendering content templates in 3ds Max



# Planar mapping

Planar mapping is suitable for projection surfaces that have:

- flat surfaces requiring one side to be UV mapped
- shallow surfaces requiring multiple oblique sides to be UV mapped
- for example a plane or a facade

## How the UV map is generated

The Planar map will parallel project UV coordinates to the surface. Therefore, it is important to align the Planar map's position, orientation and scale to the surface.

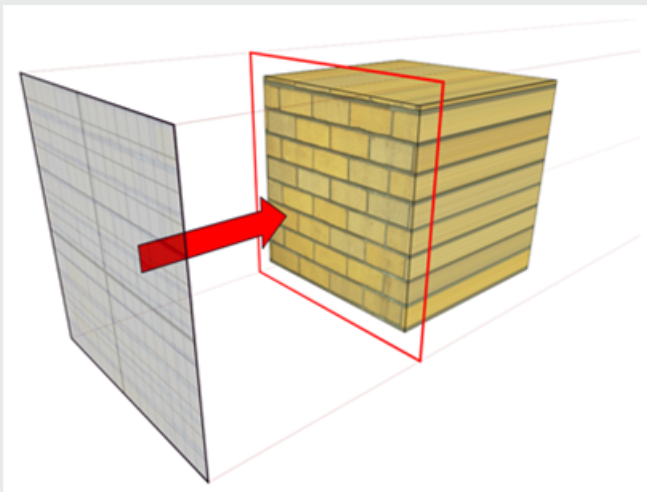

# Step 1 - Generating the UV map (3ds Max)

1. Select the UVW Map modifier.
2. From the list of projection types select planar.
3. The Planar map will project UV coordinates from its normals to the surface. Therefore, it is necessary to fit the planar map's position, orientation and scale to the surface.
4. Select the Unwrap UVW modifier.
5. Open the Edit UVWs window to view the UV map.

The image here shows a uniform checker pattern rendered to the surface, which indicates the UV map has an even distribution of UV coordinates, for all areas facing towards the Planar map. As a result, those areas have a higher UV density than the areas facing away from the Planar map. For example, the windows' side faces have a lower UV density, which will result in content appearing stretched. To avoid this the UV map should be relaxed.

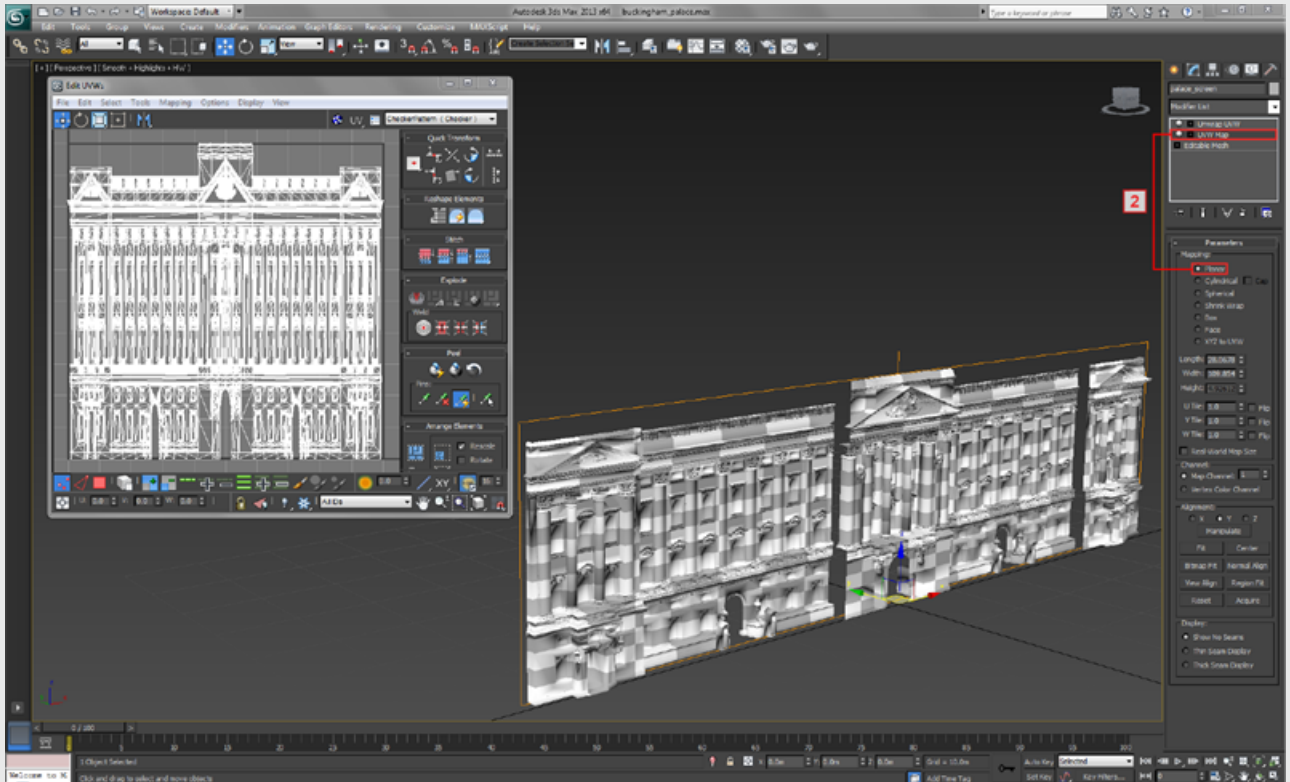

A 3D model of the Buckingham Palace planar mapped in 3ds Max.

## Step 2 - Rendering UV maps to content templates

The image below shows the content template, which was rendered from the UV map. The template's resolution was calculated by following the same technique used for pixel-perfect projection surfaces. However, the key difference is this template was calculated by measuring the dimensions of the Planar map object, because in this case the Planar map automatically generated the normalised UV map.



*A 2D content template of the Buckingham Palace rendered from 3ds Max.*

## Helpful Resources

- [Projecting planar maps in 3ds Max](#)
- [Unwrapping UVs in 3ds Max](#)
- [Editing UVs in 3ds Max](#)
- [Relaxing UVs in 3ds Max](#)
- [Rendering content templates in 3ds Max](#)

# Shrink wrapping

Shrink wrapping is suitable for projection surfaces curving across multiple axes, for example a sphere or a car. However, depending on the creative requirements, a Pelt map may be more suitable.

## How the UV map is generated

The Shrink wrap will spherically project UV coordinates to the surface, by truncating the corners of the map and joining them at a single pole. This will enable content to flow across the surface smoothly, because the UV map will only contain one singularity.

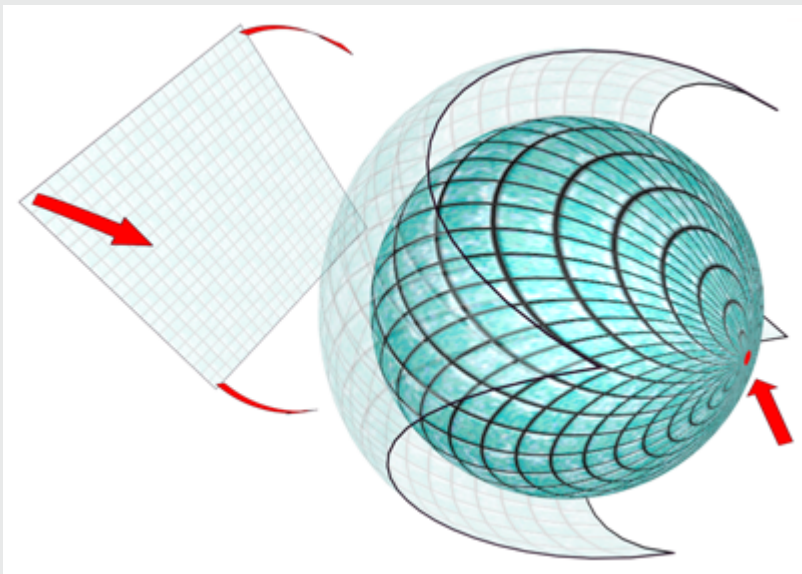

## Step 1 - Generating the UV map (3ds Max)

1. Select the UVW Map modifier.
2. From the list of projection types select shrink wrap.
3. The shrink wrap will project UV coordinates from its normals to the surface. Therefore, it is necessary to fit the shrink wrap's position, orientation and scale to the surface.
4. Select the Unwrap UVW modifier.
5. Open the Edit UVWs window to view the UV map.

The image below shows a non-uniform checker pattern rendered to the surface, which indicates the UV map has an uneven distribution of UV coordinates. To fully unwrap the surface the UV map should be relaxed.

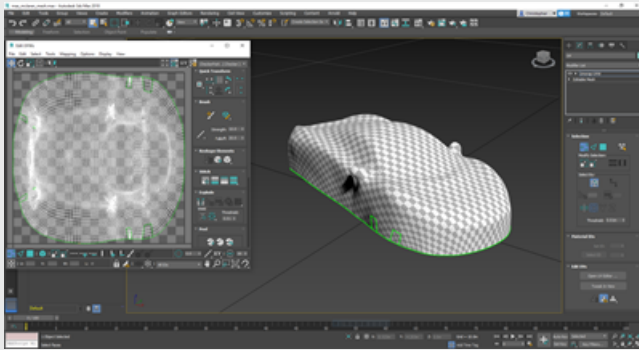

*A 3D model of the Audi A7 mesh shrink wrapped in 3ds Max.*

## Step 2 - Rendering UV maps to content templates

The images below show the content template and how its resolution was calculated. When a projection surface is shrink wrapped, it is problematic to calculate the resolution mathematically. However, it is possible to calculate the resolution visually. The template's resolution is 3448x1424 pixels. This was calculated following the steps below:

1. Export the projection surface as an .obj from the 3D application to Disguise software.  
Remember to export the .obj's texture coordinates, as explained in the Exporting UV maps

page.

2. In Disguise add the .obj to the Stage as a Screen.
3. Create a Bitmap layer on the Timeline.
4. From the layer's DxTexture library, select a texture with a square aspect.
5. Direct map the texture to the screen.
6. Set the layer's scale mode to pixel-perfect.
7. From the screen's editor, set a resolution for the horizontal or vertical axis that matches, or preferably exceeds, the projector's pixel density. This requires knowing precisely how many pixels produced by the projector will hit the projection surface.
8. Increase / decrease the screen's resolution across the remaining axis until the texture appears square. This will ensure square pixels are enabled.
9. Offset the texture using the pos x and y parameters, to check square pixels are visible across the entire surface.





*A square Bitmap Direct mapped to the car screen in Disguise.*





*A content template rendered from the Audi A7 UV map with a paint texture baked into the shrink wrap.*

## Helpful Resources

- [Projecting shrink wraps in 3ds Max](#)
- [Unwrapping UVs in 3ds Max](#)
- [Editing UVs in 3ds Max](#)
- [Flattening UVs in 3ds Max](#)
- [Unfolding UVs in 3ds Max](#)
- [Rendering content templates in 3ds Max](#)

# Spline mapping

Spline mapping is suitable for projection surfaces curving across multiple axes, for example a coiled snake or a winding road.

## How the UV map is generated

The Spline map will extrude UV coordinates from a selected spline to be projected to the surface. This will enable content to flow across the surface smoothly, because the UV coordinates will match the surface's curvature.

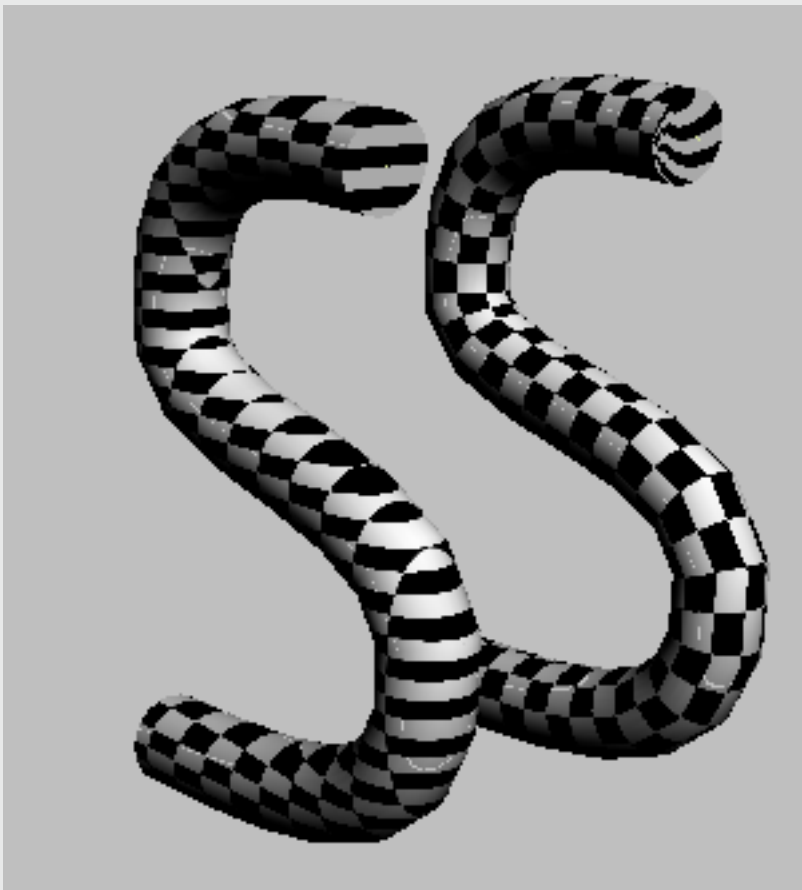

# Step 1 - Generating the UV map (3ds Max)

1. Draw a spline that snaps to the surface's bottom edge.
2. Plot all the vertices in the same vertical position to ensure the UV projection is orientated correctly.
3. Plot the spline across the surface's widest points to ensure the UV projection is assigned to the entire surface.
4. Select the Unwrap UVW modifier.
5. Select all of the surface's faces.
6. From the list of projection types select spline mapping.
7. From the spline map's parameters select pick spline.
8. Open the Edit UVWs window to view the UV map.
9. Rotate and normalise the UV map, if necessary.

The image here shows a uniform checker pattern rendered to the surface, which indicates the UV map has an even distribution of UV coordinates.

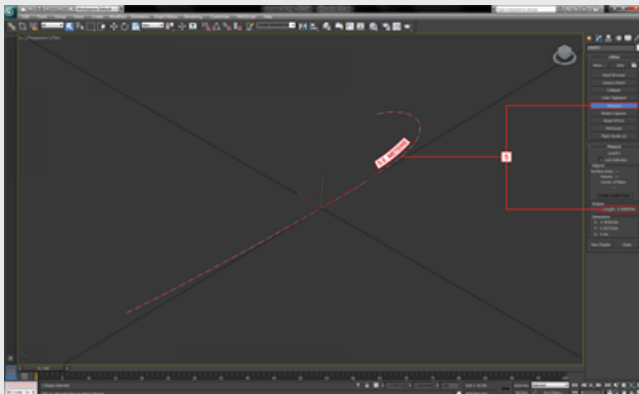

## Step 2 - Rendering UV maps to content templates

The images below show the content template and how its resolution was calculated. The template's resolution was calculated by following the same technique used for pixel-perfect projection surfaces. However, the key difference is this template was calculated by measuring the total length of the extruded spline, because in this case the extrusion automatically generated the UV map.

**Please note:** The 3D application should calculate the total length of the spline automatically. In 3ds Max select the spline, **Command Panel > Utilities > Measure**.

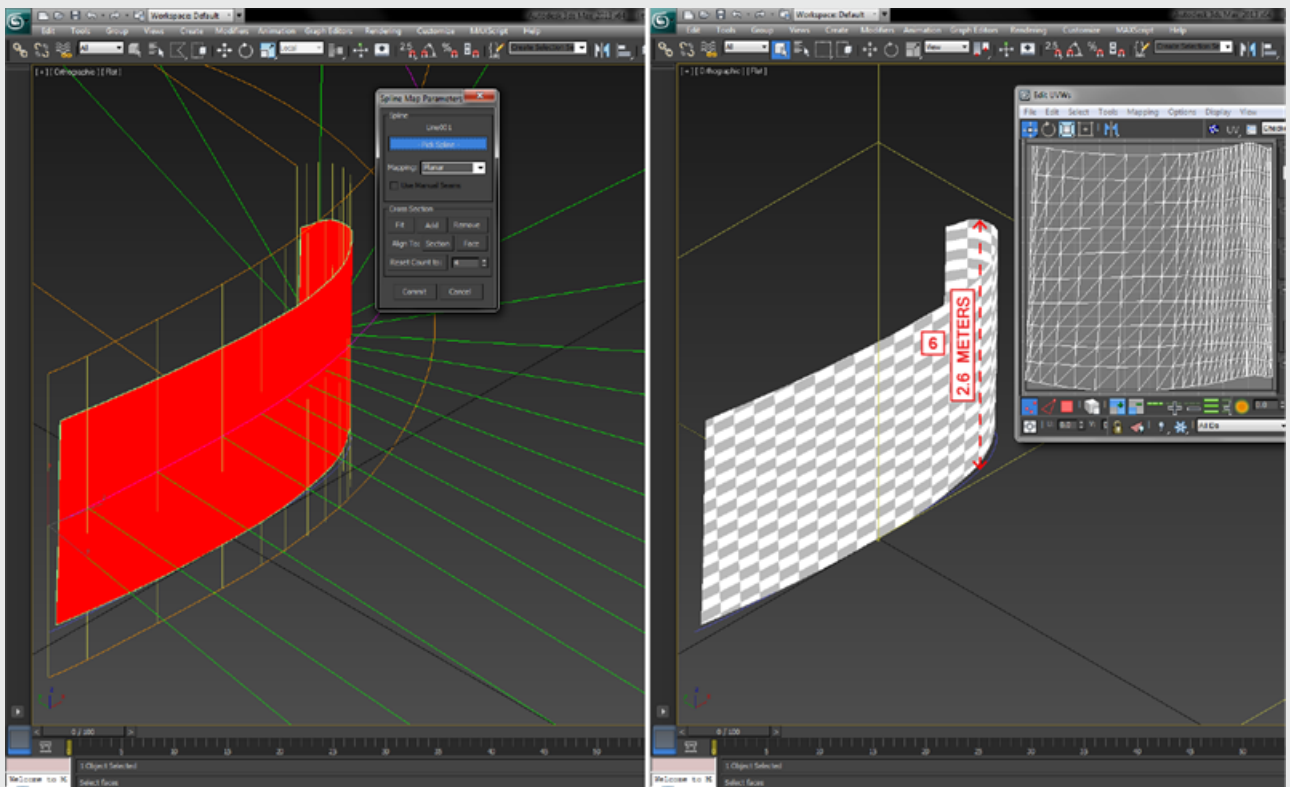

The length of the spline can be measured by selecting it and then selecting Utilities > Measure.

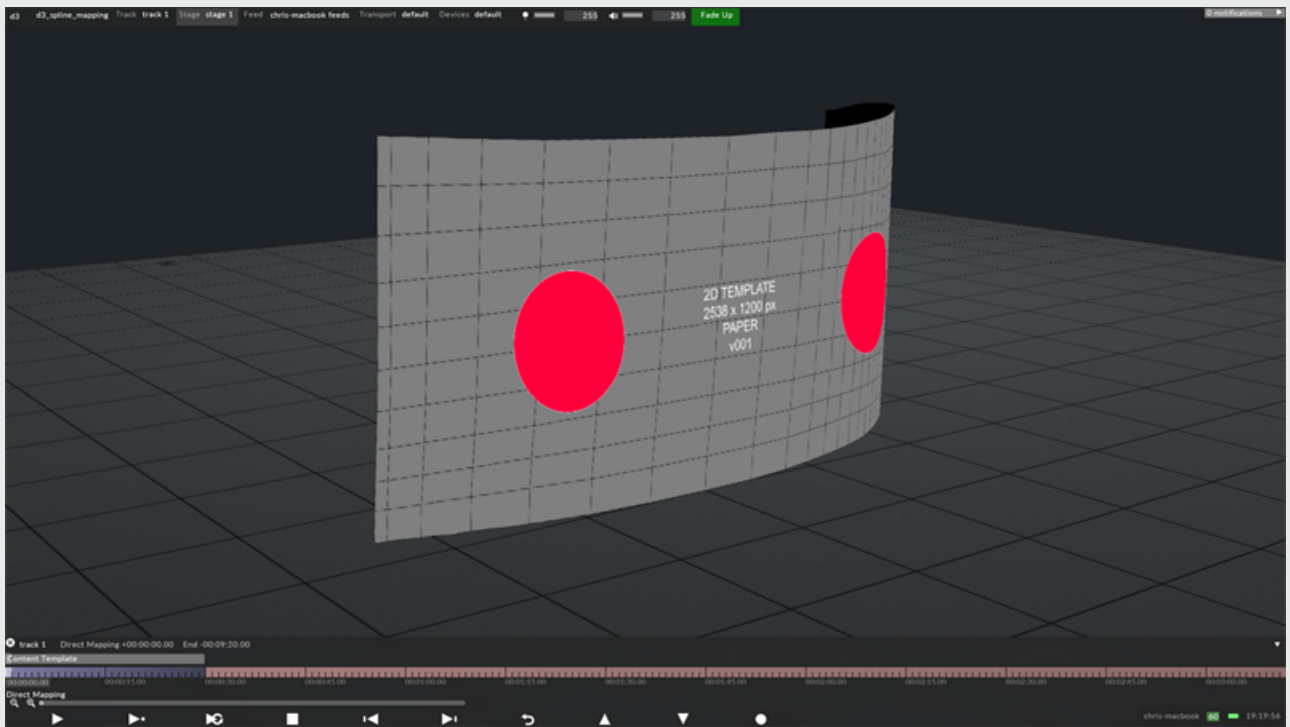
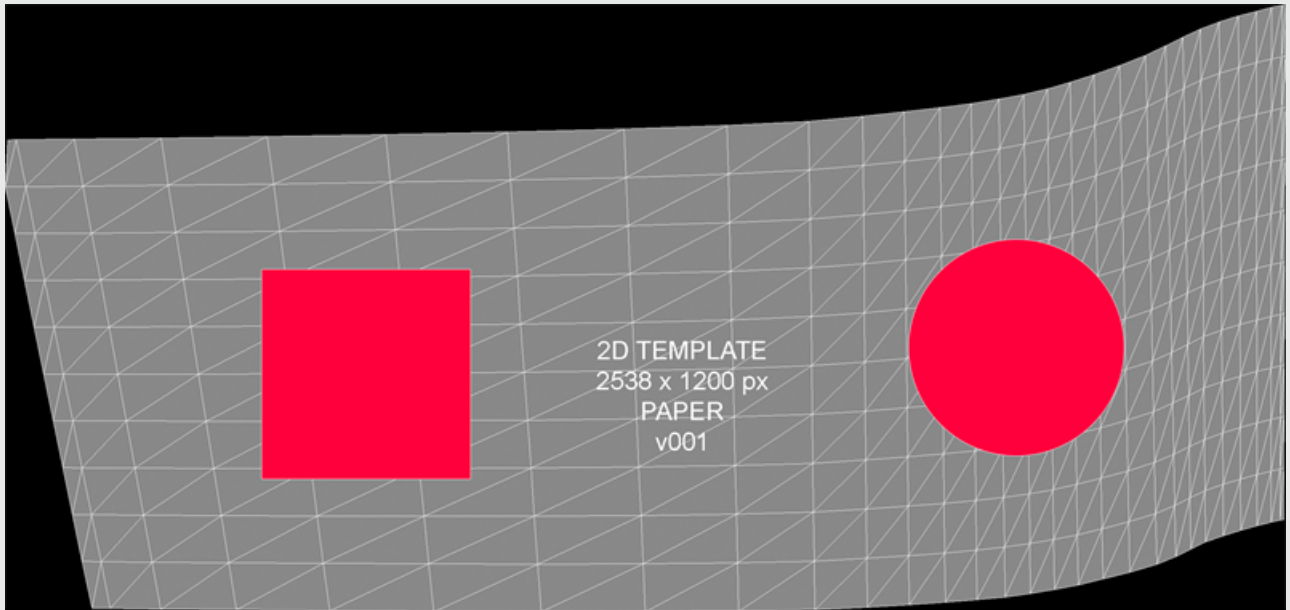

A 2D content template of a screen from the Little Prince musical rendered from 3ds Max.

## Helpful Resources

- [Projecting spline maps in 3ds Max](#)
- [Unwrapping UVs in 3ds Max](#)

- Editing UVs in 3ds Max
- Rendering content templates in 3ds Max

# LED screen examples overview

This sub-chapter will teach you how to UV map LED screens for Disguise software, which are controlled either by DVI or DMX signals. The following examples revisit the UV mapping principles covered in the previous sub-chapter. Therefore, it is recommended to read this first. Topics include:

Example 1: MiSTRIP star

Example 2: OLite column

Example 3: DNA spiral

Example 4: Millenia Tower





# LED screen examples overview

This sub-chapter will teach you how to UV map LED screens for Disguise software, which are controlled either by DVI or DMX signals. The following examples revisit the UV mapping principles covered in the previous sub-chapter. Therefore, it is recommended to read this first. Topics include:

Example 1: MiSTRIP star

Example 2: OLite column

Example 3: DNA spiral

Example 4: Millenia Tower





# Example 1: MiSTRIP star

This case study shows how to prepare a star shaped LED screen constructed from [Barco MiSTRIPS](#) for Disguise software. The first step is to UV map the 3D model by unwrapping the mesh into a grid. As explained on [The UV Map as the Hardware Output page](#), the UV map should comprise a grid because this is the output to the LED processor from the software, and LED processor's can only capture outputs composed from rectangles.

## How the UV map is generated

A plane can be **arrayed around a local pivot point** to recreate the surface with the UV map **automatically generated**. However, the UV map will have **overlapping** UV shells and therefore will require editing, either **manually** using UV editing tools or **automatically** using a script, depending on the level of complexity.

## Step 1 - Generating the UV map (3ds Max)

1. Draw a plane that matches a MiSTRIP's dimensions, 0.063x1.484 metres.
2. Ensure you have the box called **generate mapping coordinates** checked. Doing so will enable the plane to automatically generate a normalised UV map.
3. Position the plane's local pivot point to the scene's origin. The origin is 0,0,0 in 3D space corresponding to the X,Y,Z axes.
4. With the plane selected, select the **Array** tool.
5. **Array** the plane by a count of **20** around **360** degrees. This will array twenty planes around the local pivot point.

6. **Attach** all the plane's together into one **Editable Mesh / Editable Poly**.
7. Select the **Unwrap UVW** modifier.
8. Open the **Edit UVWs** window to view the UV map.
9. At this stage, the UV map will have overlapping UV shells. To **unwrap** the UV map, reposition the UV shells next to each other, either **manually** using UV editing tools or **automatically** using a script.
10. It is important to **snap** the UV shells next to each other into a **grid**. Doing so will remove gaps in the UV map, which in turn will remove virtual pixels from Disguise's output to the LED processor.
11. **Normalise** the UV map by rescaling it to fill UV space entirely from a range of 0-1 in both the U and V axes.

The image below shows the MiSTRIPs arrayed in a 360 degree **arc**, but in UV space they are arrayed in a horizontal **row** as a **grid**. Importantly, the surface's outer ring of vertices correspond to the UV map's bottom row of UV coordinates, highlighted in red. This indicates the surface's UV coordinates are **uniformly** positioned.

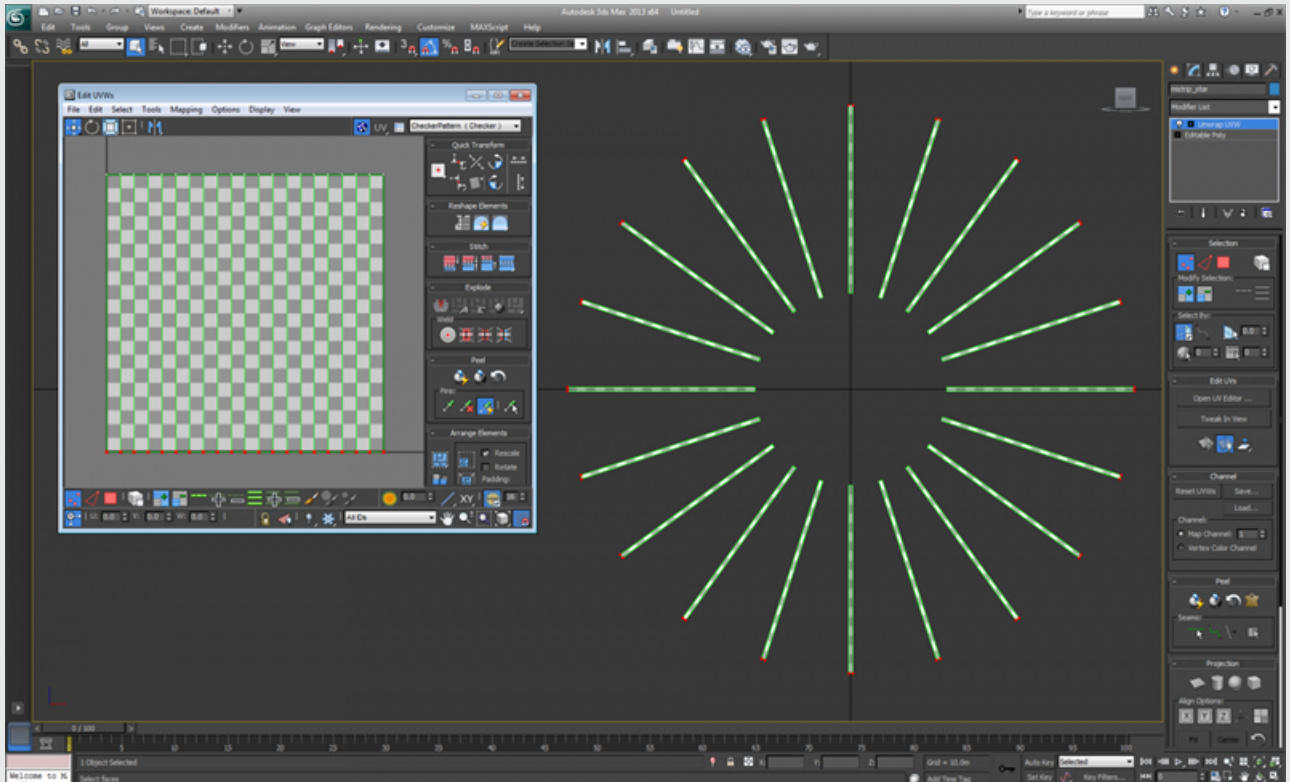

The image below shows how each MiSTRIP corresponds to a UV shell, highlighted in red. Importantly, each UV shell is *equal* in scale to each MiSTRIP, which indicates the UV map has an *even* distribution of UV coordinates.

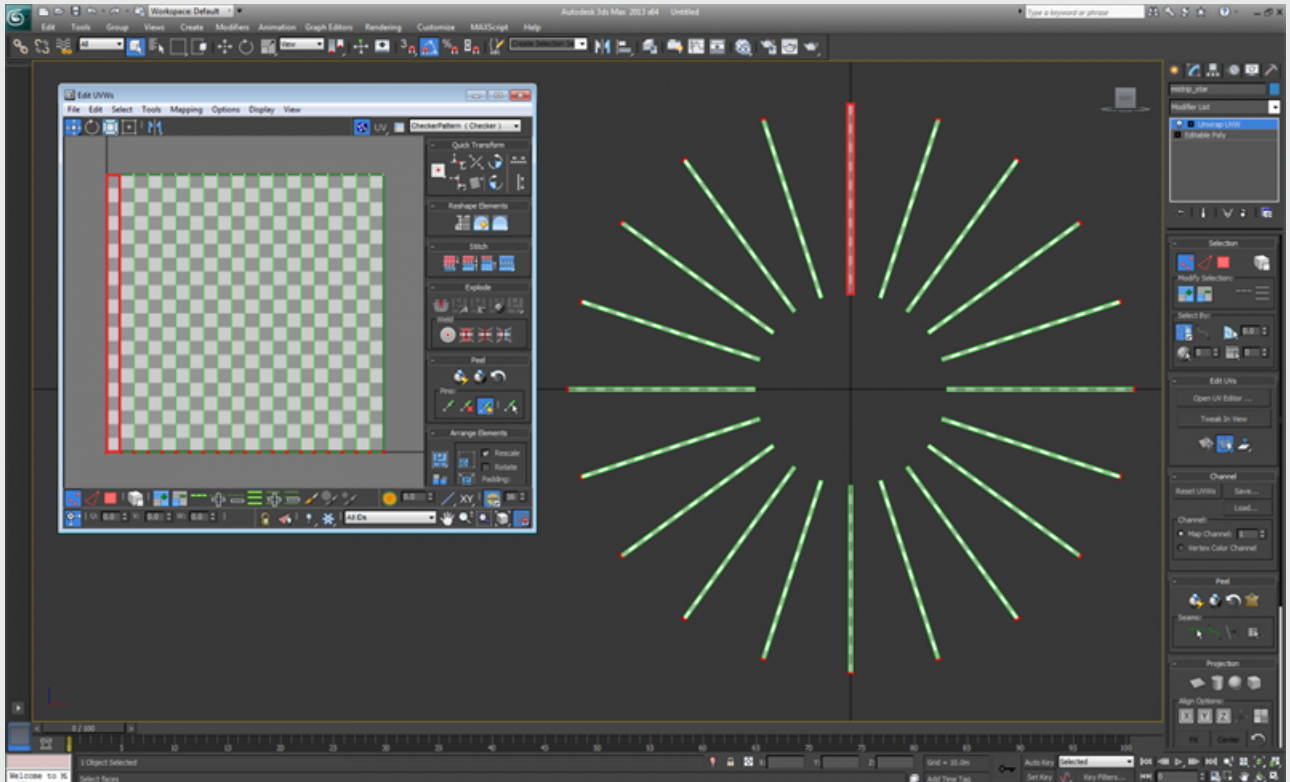

The image below shows how the MiSTRIPs are arrayed in UV space. Importantly, the MiSTRIPs are arrayed in a *clockwise* direction, and this order follows the UV map, where the UV shells are arrayed in a *left to right* direction.

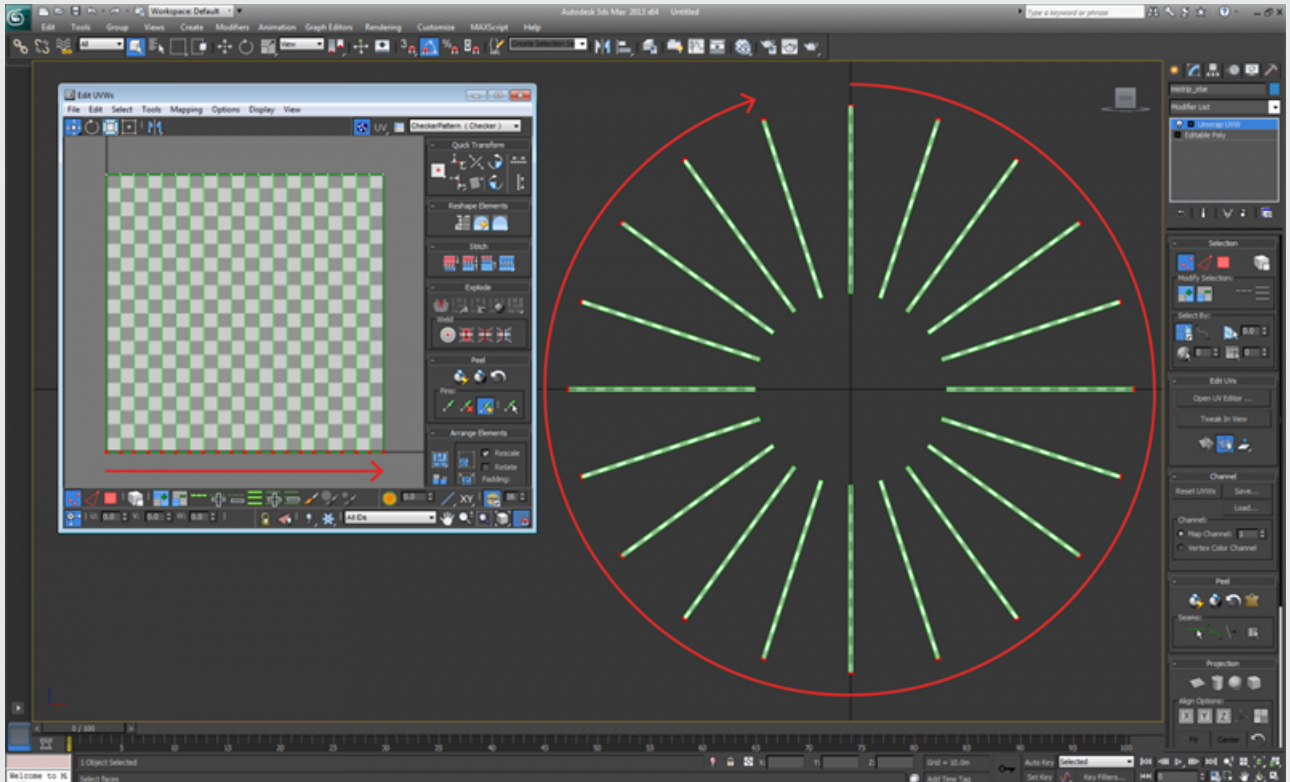

In order to set a resolution of this screen made of 20 Mistrips it is crucial to turn each strip into a rectangle in UV space.

## Step 2 - Mapping content to screens

The left-image below shows a **Radar layer Parallel** mapped to the screen in Disguise software, which was exported as an **.obj** file from **Autodesk 3ds Max**. The right-image shows the **Output Feed** from Disguise to the LED processor, which is being generated in **realtime** by the Parallel map applied in Disguise's **Stage simulator**. The feed output is **independent** of the video content, which means the output can be a **different** resolution. In this case, the content has a resolution of 1024x1024 pixels, but the output has a resolution of 20x112 pixels. This is possible because **the Parallel map does not apply content directly to the screen's UV coordinates**; enabling the content creator to design content using templates that are **independent** of the LED outputs. Therefore, the creative workflow for the content creator is **separated** from the technical workflow for the hardware technicians, as explained on [The UV Map as the Hardware Output](#) page.

The resolution of the screen in Disguise software should **exactly** match the physical screen's number of pixels. The resolution of 20x112 pixels was calculated by:

- Knowing precisely how many pixels each MiSTRIP contains **horizontally**.
- Multiplying this value by the **total** number of horizontal MiSTRIPs, to calculate a horizontal resolution.
- Knowing precisely how many pixels each MiSTRIP contains **vertically**.

In this case:

- 1 MiSTRIP = 1 pixel **horizontally**.
- The total number of horizontal MiSTRIPs is 20. Therefore, 1 pixel x 20 MiSTRIPs = 20 pixels horizontally in **total**.
- 1 MiSTRIP = 112 pixels **vertically**.

**Please note:** When setting the resolution of a screen in the software, the UV map is **divided** into a **grid** of the same resolution, and in turn each of the grid's quads are **sampled** by the screen and **outputted** to the LED processor. Therefore, it is important to **match** the resolution of Disguise's screen to the physical screen. For further information see the [How Does Disguise Sample UV Maps](#) page.

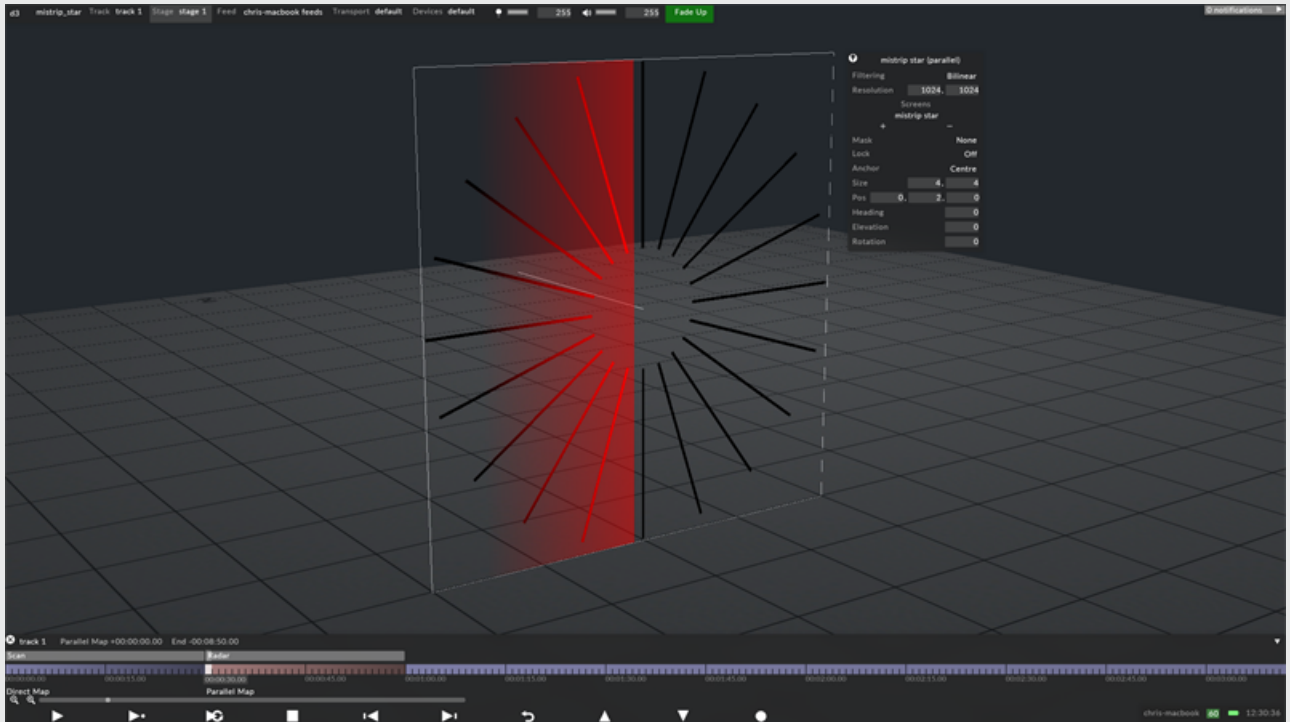

*The UV map also represent the output sent to the physical LED strips.*

The image below shows a Population mask applied to the screen in Disguise software, which was exported as a **.png** from **Adobe Photoshop**. The Population mask has removed MiSTRIP sections from the screen and, in turn, from the output to the LED processor, which maybe necessary if the screen's geometry requires updating. To read more about generating Population masks, see the [Population masks](#) page.

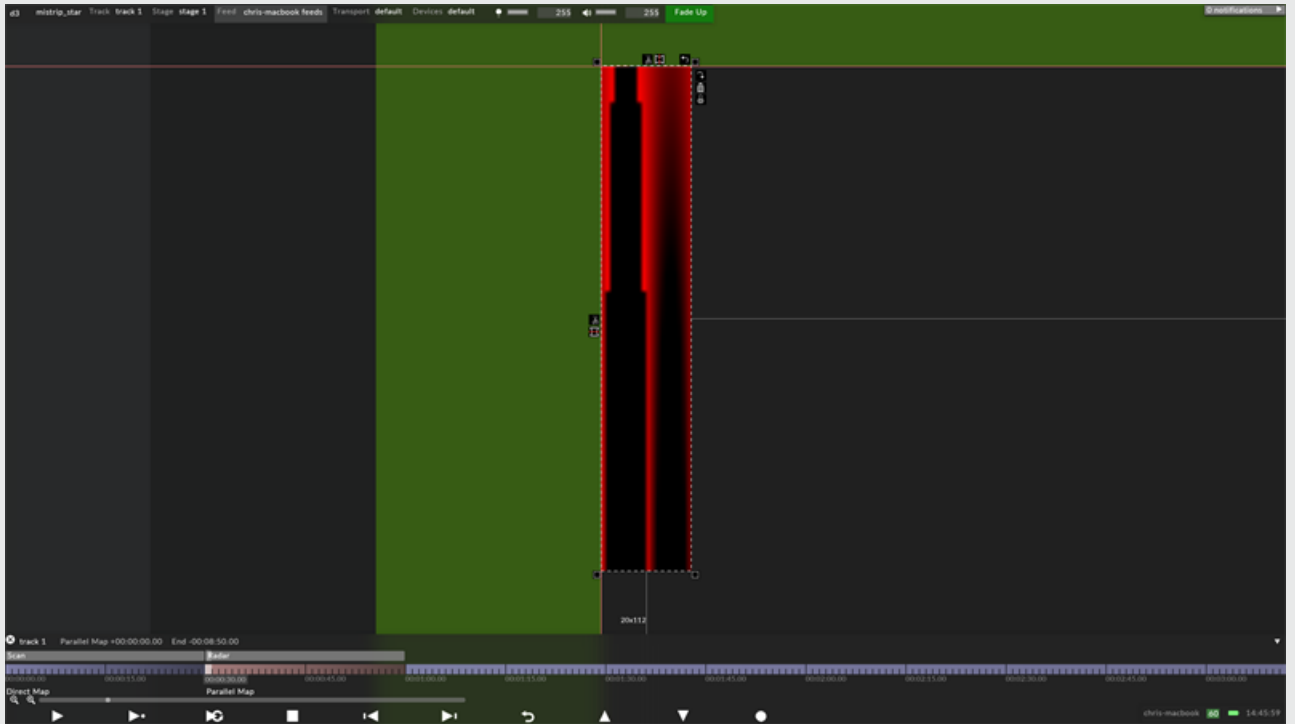



# Example 2: OLite column

This case study shows how to prepare a column shaped LED screen constructed from [Barco OLites](#) for [Disguise software](#). As explained on the [MiSTRIP Star](#) page, the first step is to UV map the 3D model by unwrapping the mesh into a grid.

## How the UV map is generated

A plane can be **arrayed across a spline** to recreate the surface with the UV map **automatically generated**. However, the UV map will have **overlapping** UV shells and therefore will require editing, either **manually** using [UV editing tools](#) or **automatically** using a script, depending on the level of complexity.

## Step 1 - Generating the UV map (3ds Max)

1. Draw a plane that matches an OLite's dimensions, 0.084x0.112 metres.
2. Ensure you have the box called **generate mapping coordinates** checked. Doing so will enable the plane to automatically generate a normalised UV map.
3. Draw a [spline](#) that snaps to the outer edge of one OLite column.
4. With the plane selected, select the **Spacing** tool.
5. From the spacing tool's parameters select **pick path**, and select the spline.
6. From the spacing tool's parameters select **count**, and enter a value of **34**. This will array thirty four planes across the spline.

7. **Attach** all the plane's together into one **Editable Mesh / Editable Poly**.
8. **Clone** the column by a count of **11**.
9. Align each column into position using the **move** and **rotate** tools.
10. **Attach** all the column's together into one **Editable Mesh / Editable Poly**.
11. Select the **Unwrap UVW**modifier.
12. Open the **Edit UVWs** window to view the UV map.
13. At this stage, the UV map will have overlapping UV shells. To **unwrap**the UV map, reposition the UV shells next to each other, either **manually** using UV editing tools or **automatically** using a script.
14. It is important to **snap** the UV shells next to each other into a **grid**. Doing so will remove gaps in the UV map, which in turn will remove virtual pixels from Disguise's output to the LED processor.
15. **Normalise** the UV map by rescaling it to fill UV space entirely from a range of 0-1 in both the U and V axes.

The image below shows the OLites arrayed in a **curved** direction, but in UV space they are arrayed in a **linear** direction as a **grid**. Importantly, the surface's outer ring of polys correspond to the UV map's top row of UV shells, highlighted in red. This indicates the surface's UV shells are **uniformly** positioned.

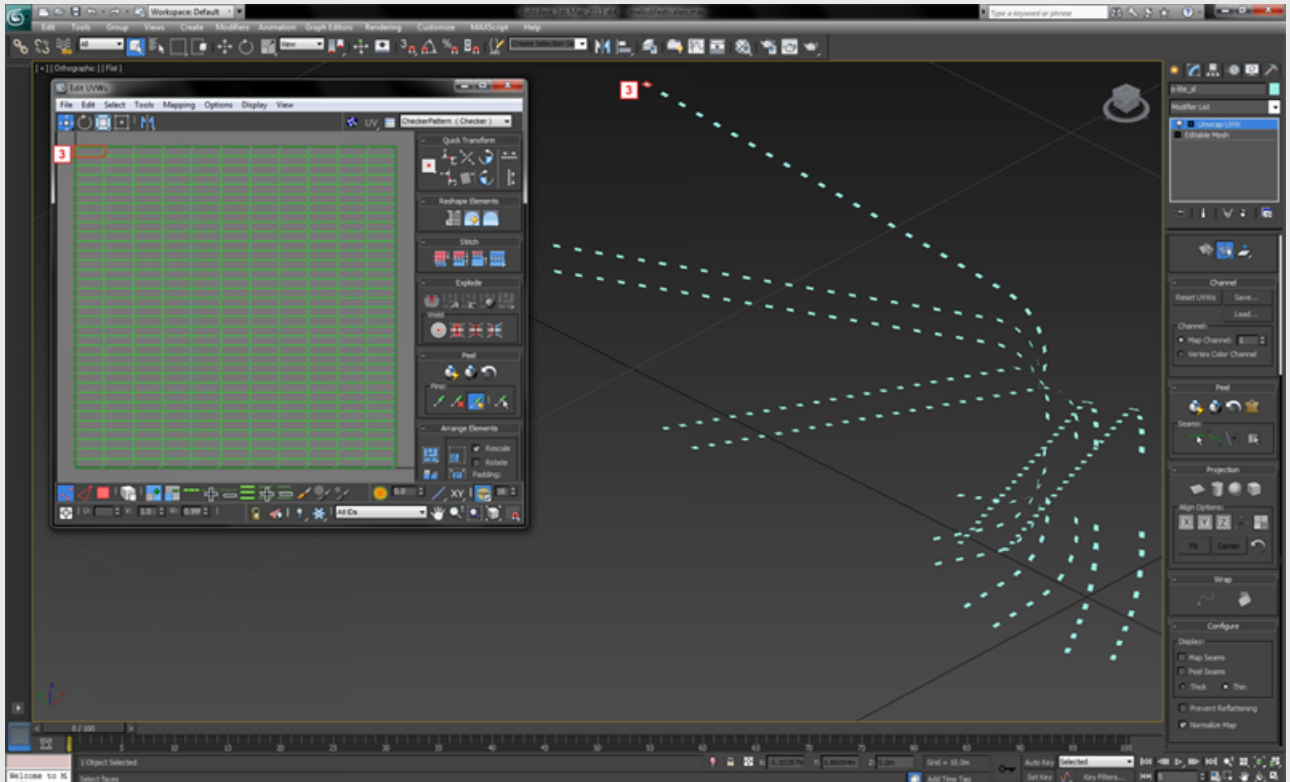

## Step 2 - Mapping content to screens

The image below shows a content template **Feed** mapped to the screen in Disguise, which was exported as an **.obj** file from **Autodesk 3ds Max**. The template was rendered from the UV map, and therefore contains no information about the **physical gaps** between the OLites. If video content is to be mapped to the screen with the physical gaps included, then a **Feed** map could be generated in d3. The Feed map **samples** different areas of the template, and in turn the sampled areas are **mapped** to the OLites. The advantage here is the sampled areas can be **reconfigured**, allowing for content to be moved, cropped, scaled and rotated, in the same way the Output Feeds can be reconfigured.

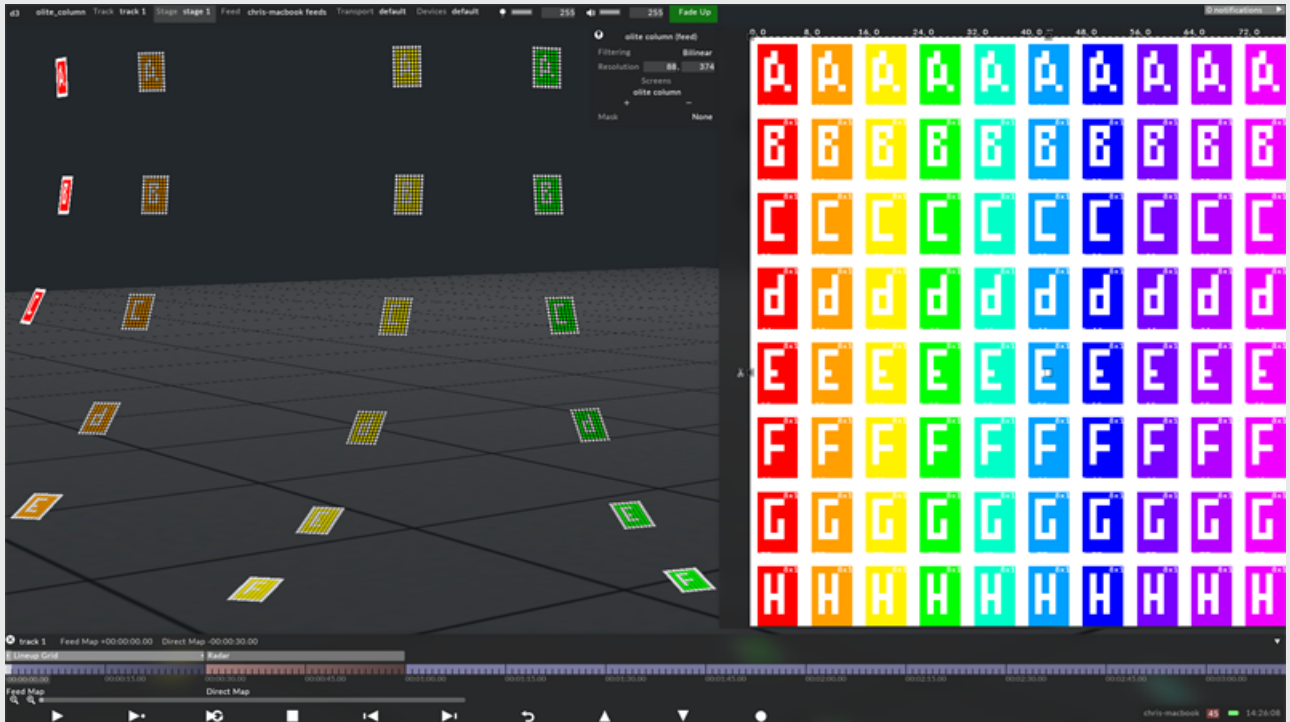

A **Parallel** or **Perspective** map can be generated from Disguise software. As explained on the [MiSTRIP Star](#) page, these mappings **do not apply content directly to the screen's UV coordinates**; enabling the content creator to design content using templates that are **independent** of the LED outputs. Therefore, the creative workflow for the content creator is **separated** from the technical workflow for the hardware technicians, as explained on [The UV Map as the Hardware Output](#) page.

The resolution of the screen in Disguise software should **exactly** match the physical screen's number of pixels. The resolution of 80x374 pixels was calculated by:

- Knowing precisely how many pixels each OLite contains **horizontally**.
- Multiplying this value by the **total** number of horizontal OLites, to calculate a horizontal resolution.
- Knowing precisely how many pixels each OLite contains **vertically**.
- Multiplying this value by the **total** number of vertical OLites, to calculate a vertical resolution.

In this case:

- 1 OLite = 8 pixels **horizontally**.
- The total number of horizontal OLites is 11. Therefore, 8 pixels x 11 OLites = 88 pixels horizontally in **total**.
- 1 OLite = 11 pixels **vertically**.
- The total number of vertical OLites is 34. Therefore, 11 pixels x 34 OLites = 374 pixels horizontally in **total**.

**Please note:** When setting the resolution of a screen in Disguise software, the UV map is **divided** into a **grid** of the same resolution, and in turn each of the grid's quads are **sampled** by the screen and **outputted** to the LED processor. Therefore, it is important to **match** the resolution of Disguise software's screen to the physical screen. For further information see the [How Does Disguise Sample UV Maps](#) page.

# Example 3: DNA Spiral

This case study shows how to prepare a spiral shaped LED screen constructed from pucks for Disguise software. As explained in the previous case studies, the first step is to UV map the 3D model by unwrapping the mesh into a grid.

## How the UV map is generated

The DNA spiral's UV map was generated using a combination of techniques applied to the [MiSTRIP Star](#) and the [OLite Column](#). However, the key difference here is the UV map contains **gaps**. This is because the content creator required a 2D template that **accurately** represented the 3D model. In this case, **virtual gaps** were included to represent the **physical gaps** between the pucks.

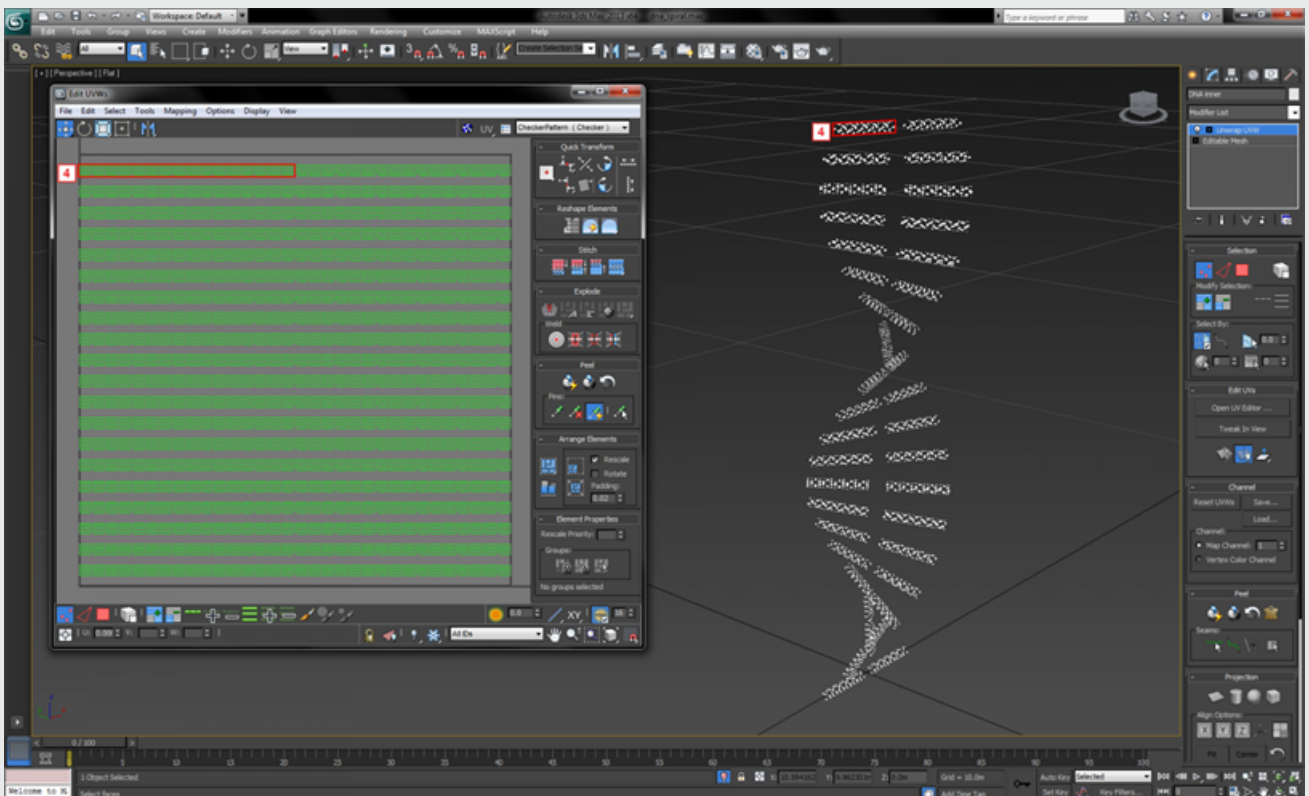

## The UV map of the DNA spiral.

The left-image below shows a content template **Direct** mapped to the screen in Disguise software, which was exported as an **.obj** file from **Autodesk 3ds Max**. The template was rendered from the UV

map, and therefore includes **virtual gaps** to represent the **physical gaps** between the pucks. The Direct map samples the **entire** UV map including the **virtual gaps**, but only the UV coordinates **assigned** to the 3D model will display video content; enabling the content creator to design content using a template which **accurately** represents the 3D model. However, here the disadvantage is Disguise's screen will require a **higher** resolution than the physical screen, **which may affect video performance**. The right-image below shows the **Output Feed** from Disguise software to the LED processor. The output is **independent** of the content, which means the output can be a **different** resolution. In this case, the content has a resolution of 32x164 pixels, but the output has a resolution of 32x82. This is possible because the Output Feeds can be **reconfigured**, allowing for virtual pixels to be **removed** from the output, and for the output to be **edited** to match the LED processor's pixel map. Therefore, the creative workflow for the content creator is **separated** from the technical workflow for the hardware technicians, as explained on [The UV Map as the Hardware Output](#) page.

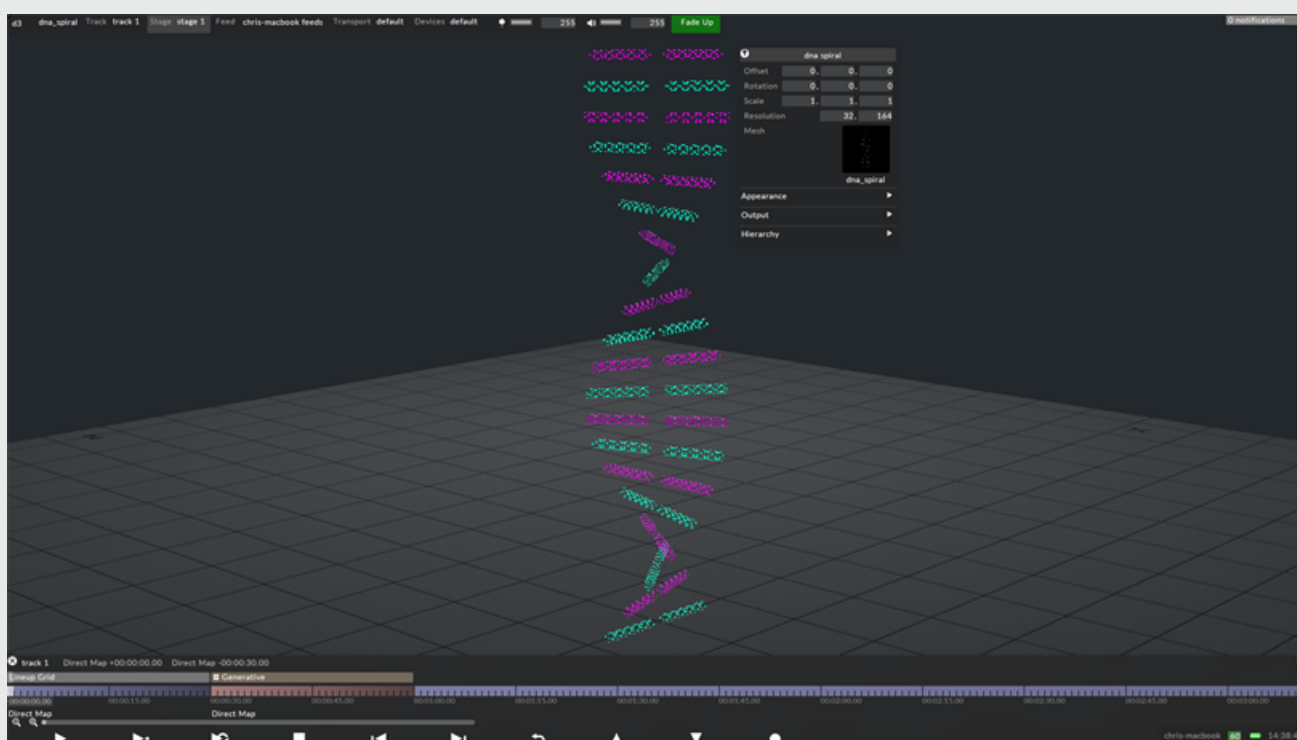

Normally, the resolution of the screen in Disguise software should **exactly** match the physical screen's number of pixels. However, in this case the resolutions can **differ**. The resolution of 32x164 pixels was calculated by:

- Knowing precisely how many pixels each puck contains **horizontally**.
- Multiplying this value by the **total** number of horizontal pucks, to calculate a horizontal resolution.
- Knowing precisely how many pixels each puck contains **vertically**.
- Multiplying this value by the **total** number of vertical pucks, and **doubling** the sum, to calculate a vertical resolution.

In this case:

---

- 1 puck = 1 pixel **horizontally**.
- The total number of horizontal pucks is 32. Therefore, 1 pixel x 32 pucks = 32 pixels horizontally in **total**.
- 1 puck = 1 pixel **vertically**.
- The total number of vertical pucks is 84. Therefore, 1 pixel x 82 pucks = 82, and 82 x 2 = 164 pixels horizontally in **total**.

The vertical resolution was **doubled** because the UV map contains **gaps**. **Importantly, the gaps were spaced evenly to match the heights of the UV shells**. Doing so ensures Disguise's screen will **precisely** sample the UV map. If the resolution is incorrect the screen will sample virtual pixels, which in turn will display **black** across the output. Therefore, it is important to generate a **pixel-perfect** content template to render video content from.

**Please note:** When setting the resolution of a screen in Disguise software, the UV map is **divided** into a **grid** of the same resolution, and in turn each of the grid's quads are **sampled** by the screen and **outputted** to the LED processor. Normally, it is important to **match** the resolution of the screen to the physical screen but, in this case, Disguise's screen should have a **higher** resolution to allow for virtual pixels. Therefore, it is **highly recommended** to test playback performance before running a live show. For further information see the [How Does Disguise Sample UV Maps](#) page.



# Example 4: Millenia Tower

This case study shows how Singapore's Millenia Tower was prepared for Disguise software. The key difference here is the screens used Pulsar Chroma lights, which are DMX controlled fixtures. The previous case studies explained how to prepare DVI controlled fixtures for Disguise, although Disguise maps DMX pixels in the *same* way it does DVI pixels. Therefore, the 3D modelling and UV mapping techniques covered earlier apply here. However, it is important to understand Disguise's DMX screen sends RGB data over Art-Net and other supported protocols, instead of the Output Feeds. To read more about DMX screens, see the Creating DMX screens sub-chapter.

## How the UV map is generated

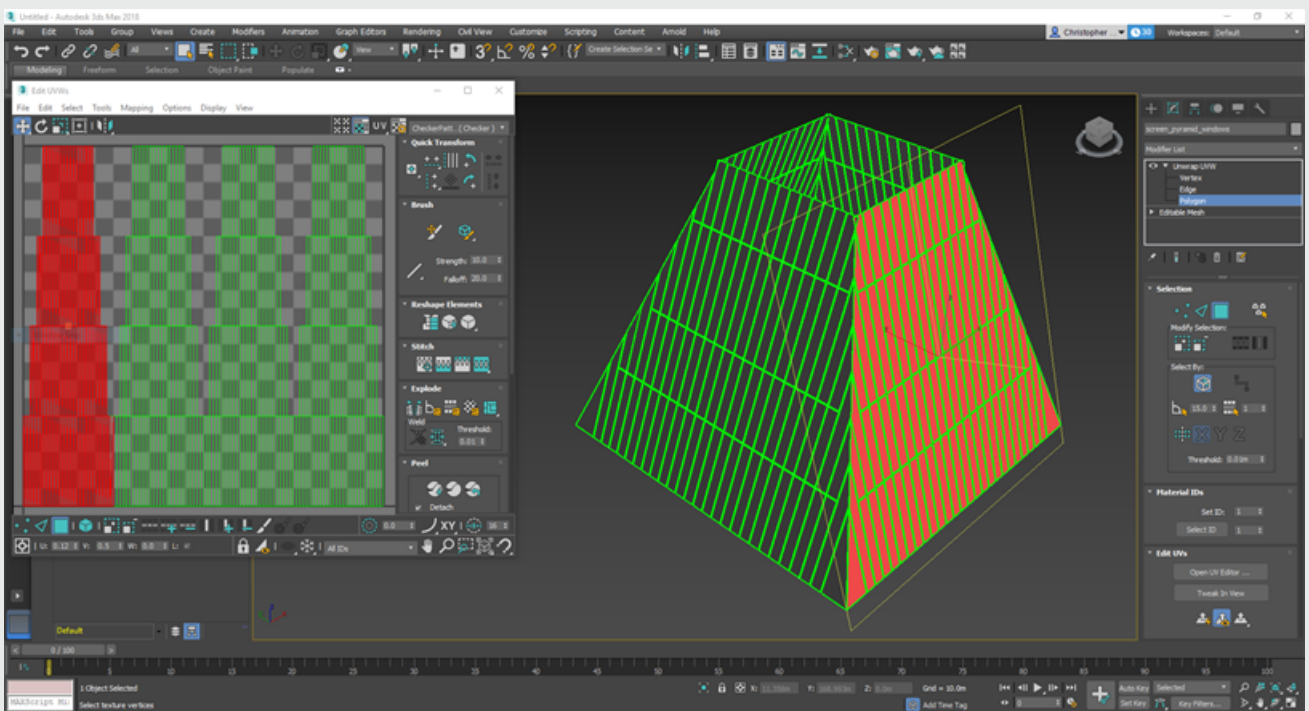

The Millenia Tower's UV map was generated using a combination of techniques applied previously, which explained how to **unwrap** a 3D model into a **grid**.

Similar to the DNA Spiral, this UV map contains gaps **separating** the tower's four sides, although in this case the 3D model does **not** contain the same gaps.

The UV map was designed on the basis that each Chroma light would be mapped in Disguise to a resolution of 1x1 pixels. Consequently, in **Autodesk 3ds Max** each Chroma light was assigned one UV

shell, all of which **matched** in scale, because this ensured Disguise's **Direct** map **precisely** sampled the UV map. Because the tower's upper levels contain less Chroma lights than the lower levels, the UV map's upper levels contained less UV shells than the lower levels, resulting in **virtual gaps**.

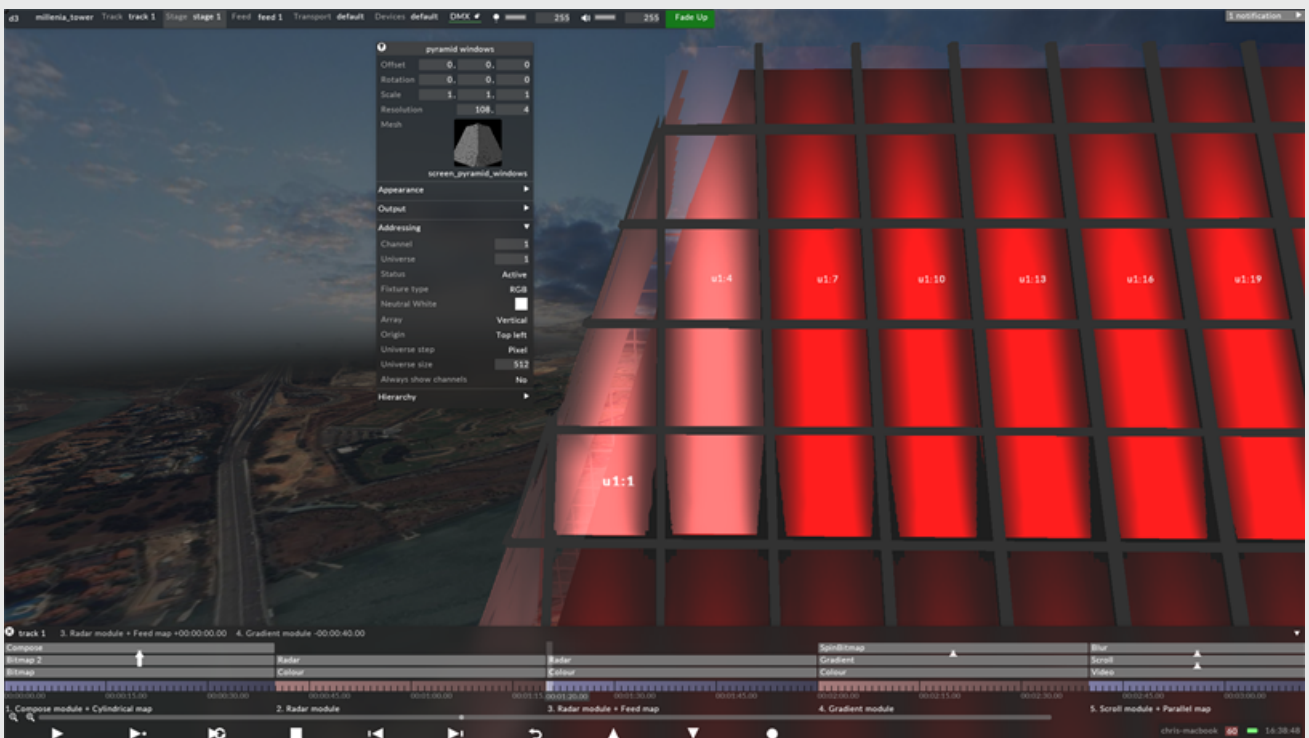
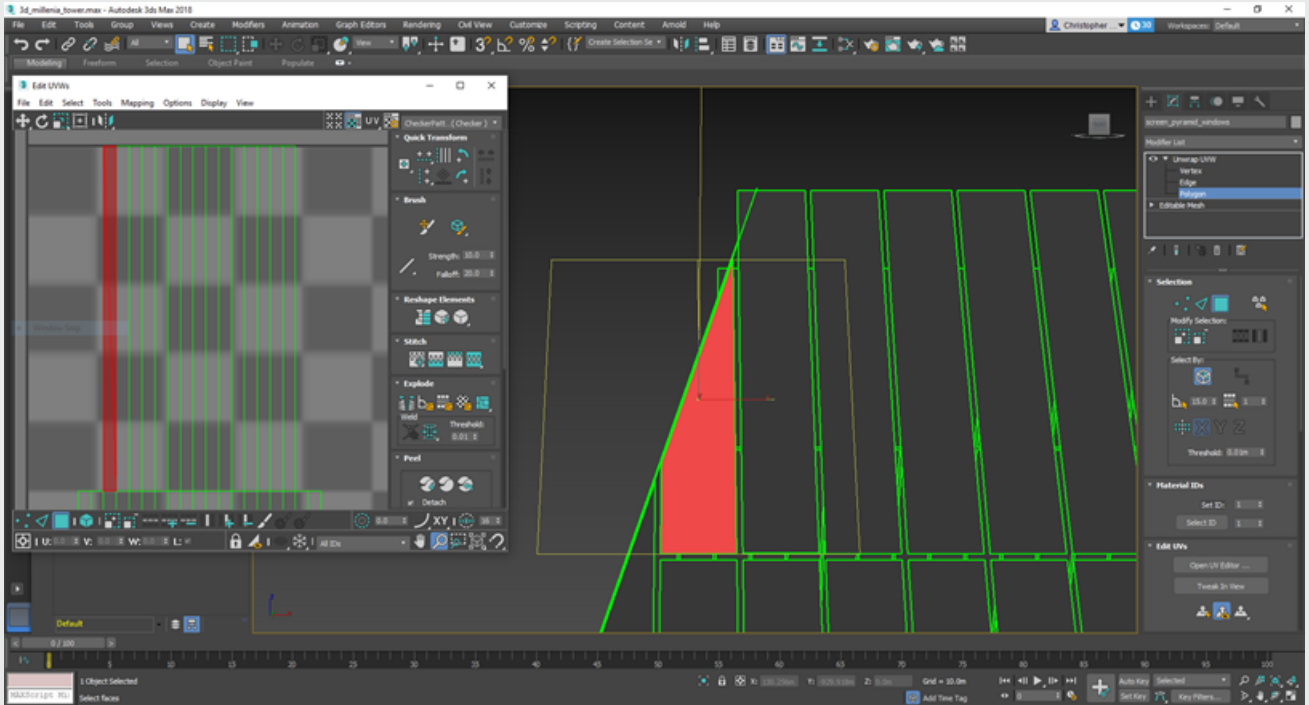

03 millenia\_tower Track track 1 Stage stage 1 Feed feed 1 Transport default Devices default DMX 2 255 255 Fade Up Notification

Monitor		DMX Monitor										Output
Universe												Decimal
View		10 Per Row										
Layer		1	2	3	4	5	6	7	8	9	10	
1	255	33	33	255	29	29	255	19	19	255		
11	0	0	252	0	0	252	0	0	252	0		
21	0	252	0	0	252	0	0	252	0	0		
31	252	0	0	252	0	0	252	0	0	252		
41	0	0	252	0	0	252	0	0	252	0		
51	0	252	0	0	252	0	0	252	0	0		
61	252	0	0	252	0	0	252	0	0	252		
71	0	0	252	0	0	252	0	0	252	0		
81	0	252	0	0	252	0	0	252	0	0		
91	252	0	0	252	0	0	252	0	0	252		
101	0	0	252	0	0	252	0	0	252	0		
111	0	252	0	0	252	0	0	252	0	0		
121	252	0	0	252	247	245	255	256	234	255		
131	225	223	255	218	216	255	212	210	255	207		
141	206	255	198	196	255	186	185	255	174	173		
151	255	159	158	255	143	142	255	129	128	255		
161	112	111	255	98	95	255	81	81	255	49		
171	49	255	18	17	255	47	47	255	40	40		
181	0	0	0	0	0	0	0	0	0	0		
191	0	0	0	0	0	0	0	0	0	0		
201	0	0	0	0	0	0	0	0	0	0		
211	0	0	0	0	0	0	0	0	0	0		
221	0	0	0	0	0	0	0	0	0	0		
231	0	0	0	0	0	0	0	0	0	0		
241	0	0	0	0	0	0	0	0	0	0		
251	0	0	0	0	0	0	0	0	0	0		
261	0	0	0	0	0	0	0	0	0	0		
271	0	0	0	0	0	0	0	0	0	0		
281	0	0	0	0	0	0	0	0	0	0		
291	0	0	0	0	0	0	0	0	0	0		
301	0	0	0	0	0	0	0	0	0	0		
311	0	0	0	0	0	0	0	0	0	0		
321	0	0	0	0	0	0	0	0	0	0		
331	0	0	0	0	0	0	0	0	0	0		
341	0	0	0	0	0	0	0	0	0	0		
351	0	0	0	0	0	0	0	0	0	0		
361	0	0	0	0	0	0	0	0	0	0		
371	0	0	0	0	0	0	0	0	0	0		
381	0	0	0	0	0	0	0	0	0	0		
391	0	0	0	0	0	0	0	0	0	0		
401	0	0	0	0	0	0	0	0	0	0		
411	0	0	0	0	0	0	0	0	0	0		
421	0	0	0	0	0	0	0	0	0	0		
431	0	0	0	0	0	0	0	0	0	0		
441	0	0	0	0	0	0	0	0	0	0		
451	0	0	0	0	0	0	0	0	0	0		
461	0	0	0	0	0	0	0	0	0	0		
471	0	0	0	0	0	0	0	0	0	0		
481	0	0	0	0	0	0	0	0	0	0		
491	0	0	0	0	0	0	0	0	0	0		
501	0	0	0	0	0	0	0	0	0	0		
511	0	0	0	0	0	0	0	0	0	0		

Track 1    2. Radar module +00:00:00.00    3. Radar module + Feed map -00:00:40.00

Composite    Radar    Radar    SplitMap    Blur  
 BitMap 2    Colour    Colour    Gradient    Stript  
 BitMap    Colour    Colour    Colour    Video

1. Composite module + Cylindrical map    2. Radar module    3. Radar module + Feed map    4. Gradient module    5. Scroll module + Parallel map

rbt-machben 88 14:40:29

# Stage overview

## What is the Stage?

The **Stage** is a level in Disguise software that uses the Stage Visualiser to view your current stage from any angle. The terms the Stage and the Stage level have the same meaning but to avoid confusion we will be using the Stage level term most commonly throughout the User Guide.

- Left-click **stage** from the [dashboard](#) to open the Stage level.

## Objects within a stage

A stage is constructed from a series of [objects](#). These objects are a range of different screen types, venues and props.

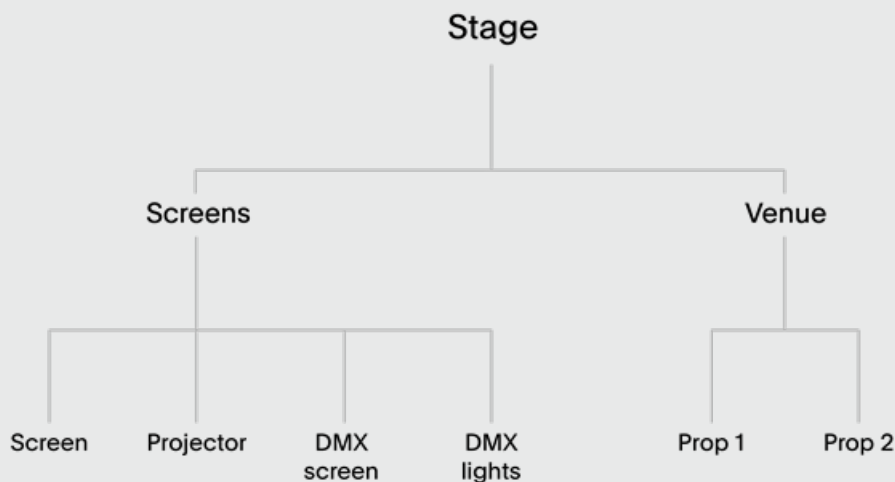

Hierarchy of objects contained within a stage: screens, venues and props

## Screens

d3 has a number of different types of **screens** that you can add to a stage. The stage can then be used to play video from the [Timeline](#) onto the screens in real-time, avoiding the need for time consuming re-renders.

# Venues

A stage can contain multiple **venues**. This is useful if you wish to create a range of stage designs, each venue representing a different stage design option, allowing you to quickly change from one design to another (during a client meeting for example).

**Props** : these venues are constructed from **props**. Props are objects which form the building blocks of your venue.

## Multiple Stages

The Stage level can even contain multiple stages, which can be switched between quickly from the same d3 file.

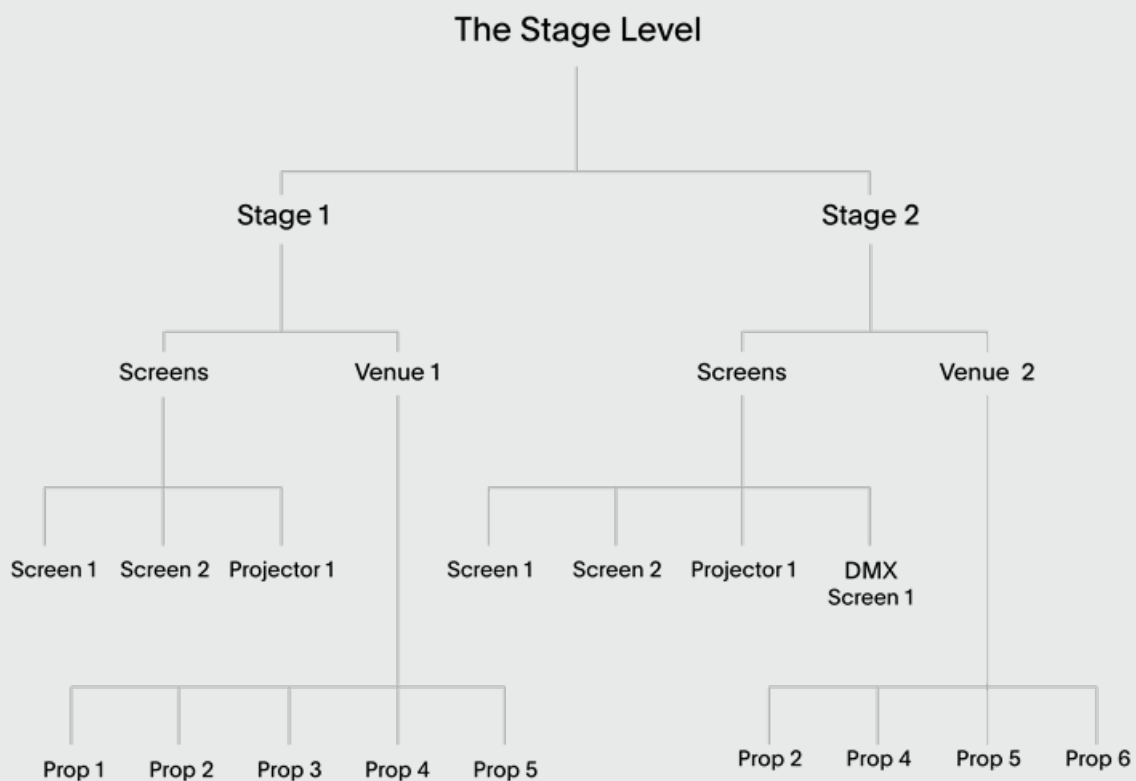

The Stage level can contain multiple stages which can be switched between quickly from the same project file, these stages can share the same screens, venues and props

Each stage you create can share the same screens, venues and props. In the example above there are two different stages in the same d3 file: **Stage1** and **Stage2**. Notice that both of these stages share certain screen types: **Screen1**, **Screen2** and **Projector1**; they also share specific props: **Prop2** , **Prop4** and **Prop5** . However, their overall prop configurations are different, hence the need to create two different venues; and their overall screen configurations are different, hence the need to create two different stages.

For information on adding, removing, and editing stages, screens, venues and props please read the following sub-chapters.

**Please note:** For solid performance from Disguisehardware it is best to keep the total number of vertex points in your scene below about 150,000-200,000 vertices. This figure varies with the amount of video loading required.

# Stage overview

## What is the Stage?

The **Stage** is a level in Disguise software that uses the **Stage Visualiser** to view your current stage from any angle. The terms the **Stage** and the **Stage level** have the same meaning but to avoid confusion we will be using the **Stage level** term most commonly throughout the User Guide.

- Left-click **stage** from the [dashboard](#) to open the Stage level.

## Objects within a stage

A stage is constructed from a series of [objects](#). These objects are a range of different screen types, venues and props.

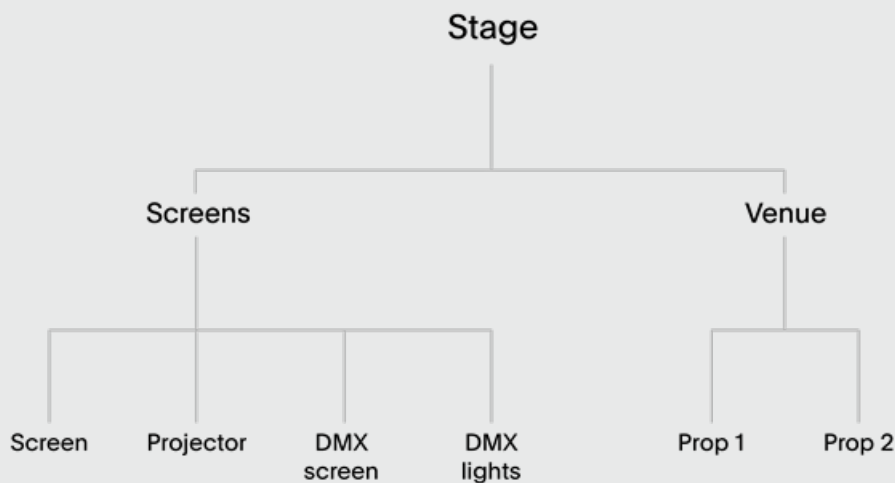

Hierarchy of objects contained within a stage: screens, venues and props

## Screens

d3 has a number of different types of **screens** that you can add to a stage. The stage can then be used to play video from the [Timeline](#) onto the screens in real-time, avoiding the need for time consuming re-renders.

# Venues

A stage can contain multiple **venues**. This is useful if you wish to create a range of stage designs, each venue representing a different stage design option, allowing you to quickly change from one design to another (during a client meeting for example).

**Props** : these venues are constructed from **props**. Props are objects which form the building blocks of your venue.

## Multiple Stages

The Stage level can even contain multiple stages, which can be switched between quickly from the same d3 file.

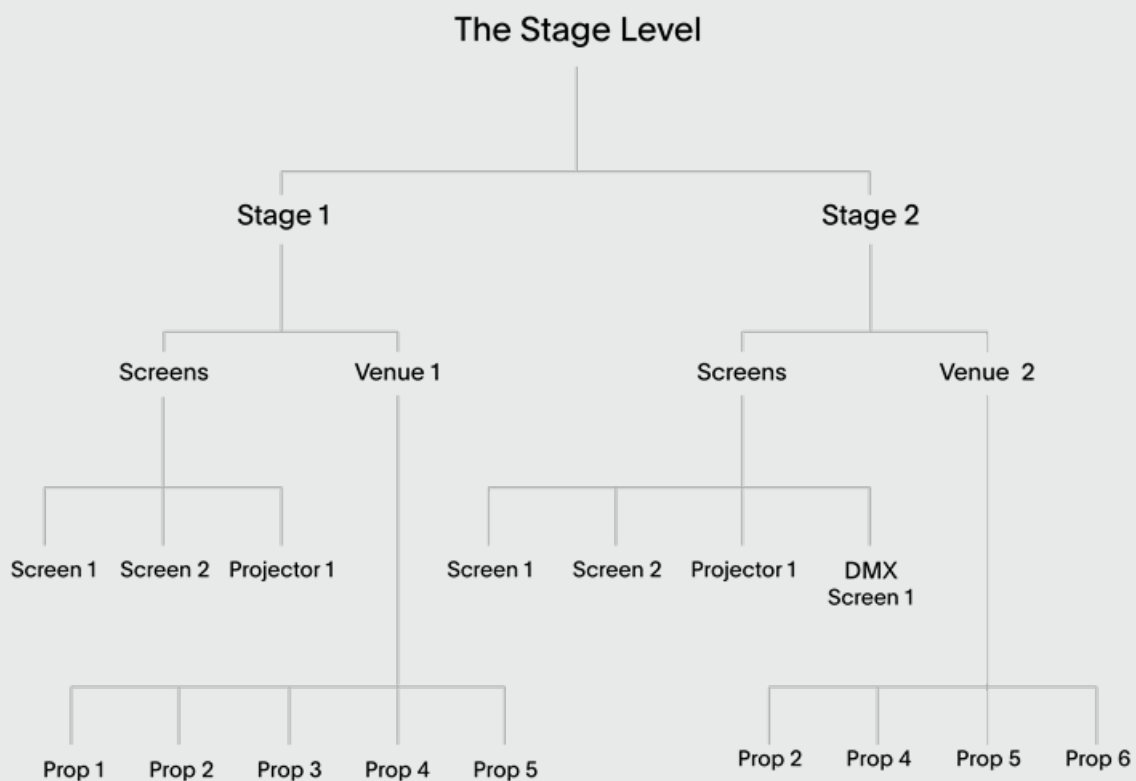

The Stage level can contain multiple stages which can be switched between quickly from the same project file, these stages can share the same screens, venues and props

Each stage you create can share the same screens, venues and props. In the example above there are two different stages in the same d3 file: **Stage1** and **Stage2**. Notice that both of these stages share certain screen types: **Screen1**, **Screen2** and **Projector1**; they also share specific props: **Prop2** , **Prop4** and **Prop5** . However, their overall prop configurations are different, hence the need to create two different venues; and their overall screen configurations are different, hence the need to create two different stages.



For information on adding, removing, and editing stages, screens, venues and props please read the following sub-chapters.

**Please note:** For solid performance from Disguisehardware it is best to keep the total number of vertex points in your scene below about 150,000-200,000 vertices. This figure varies with the amount of video loading required.

# Editing the Stage

## Stage editor

To edit the Stage you need to open the **Stage editor**.

To open the stage editor, right-click **stage** from the dashboard (bar at the top of the screen).

stage 1

Scene ▼

Floor size 25, 25

Floor position 0, 0, 0

Floor plan None

Venue None

People 1

Ambient brightness 100

Ambient colour 

Scene lights

+ -

Footprints Quality 0

LED Screens ▶

DMX Screens ▶

DMX Lights ▶

Projection Surfaces ▶

Projectors ▶

Cameras ▶

MR Sets ▶

Actions ▶

Stage editor accessed by right-clicking Stage from the dashboard.

## Scene

Select the scene tab to display the following properties:

### Floor size

This property controls a stage's floor size. There are two numbers laid out horizontally: respectively the x (width) and z (depth) coordinates. The units used for floor size are meters.

### Floor position

This property controls a stage's floor position in 3D space. There are three numbers laid out horizontally: respectively the x (left/right), y (up/down) and z (forward/backward) coordinates.

### Floor plan

This points to the still image file that defines the floor plan of the currently active stage. Selecting this property will open the Texture object library, which shows all of the still image files saved on your local hard-drive in the **DxTexture** folder.

To add the floor plan to the stage floor:

1. Left-click **floor plan** to open the Texture object library.
2. Left-click the image you want to use for the stage floor.

If you want to use a floor plan other than the standard still images provided in the software, you will need to use a custom still image file.

See the [Placing media files for a project](#) sub-chapter to understand where to place a custom still image file and how to access it. Also, save the file to a [supported file format](#).

# Venue

This property enables you to swap a venue with the currently active venue. This switching of venues will be updated in the Stage Visualiser. This is very useful for quickly switching between different prop configurations.

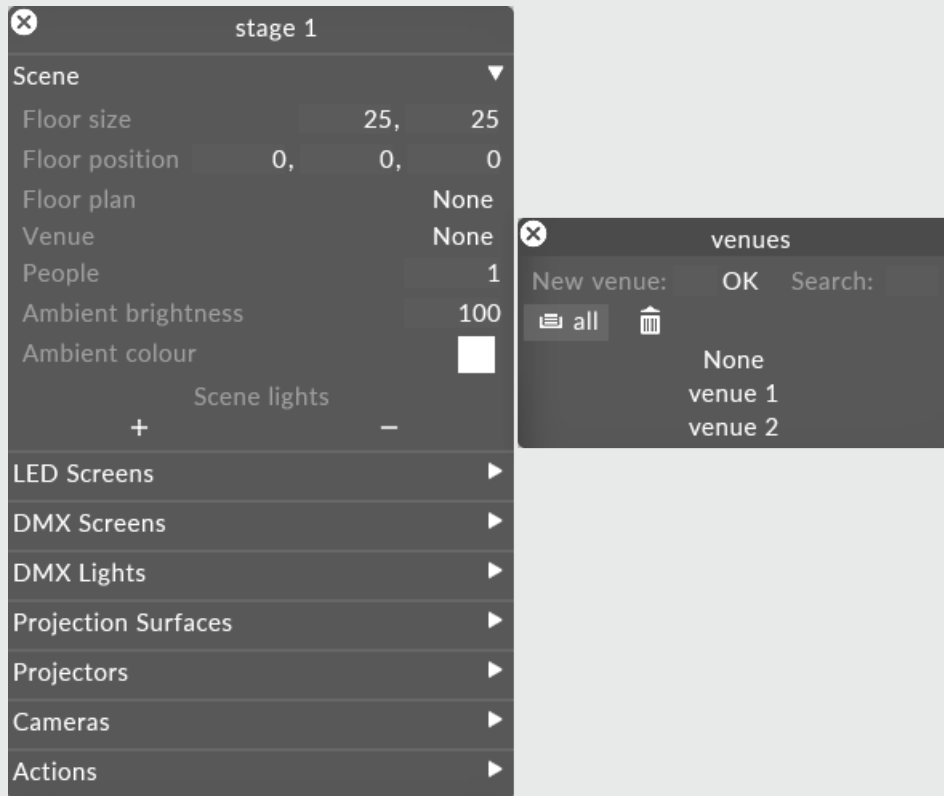

Venue property is used to open the Venue manager

1. Left-click **venue** to open the Venue manager. This will display a list of all of the venues you have created.
2. Left-click the venue you want to switch with the currently active venue.

For more detailed information on using this feature please see the [Creating/switching venues](#), [Editing venues](#), [Creating/removing props](#) and [Editing props](#) sub-chapters. For general information about venues and props please see the [Venues/props overview](#).

## People

This property controls the number of human figures displayed in the Stage Visualiser. The maximum number of human figures in a stage is 320.

## Ambient Brightness

This property controls the ambient brightness level of the stage while in Lux renderer mode.

## Ambient Colour

This property controls ambient colour of the stage while in Lux renderer mode

Use the Colour Dropper tool to select an ambient colour for the stage

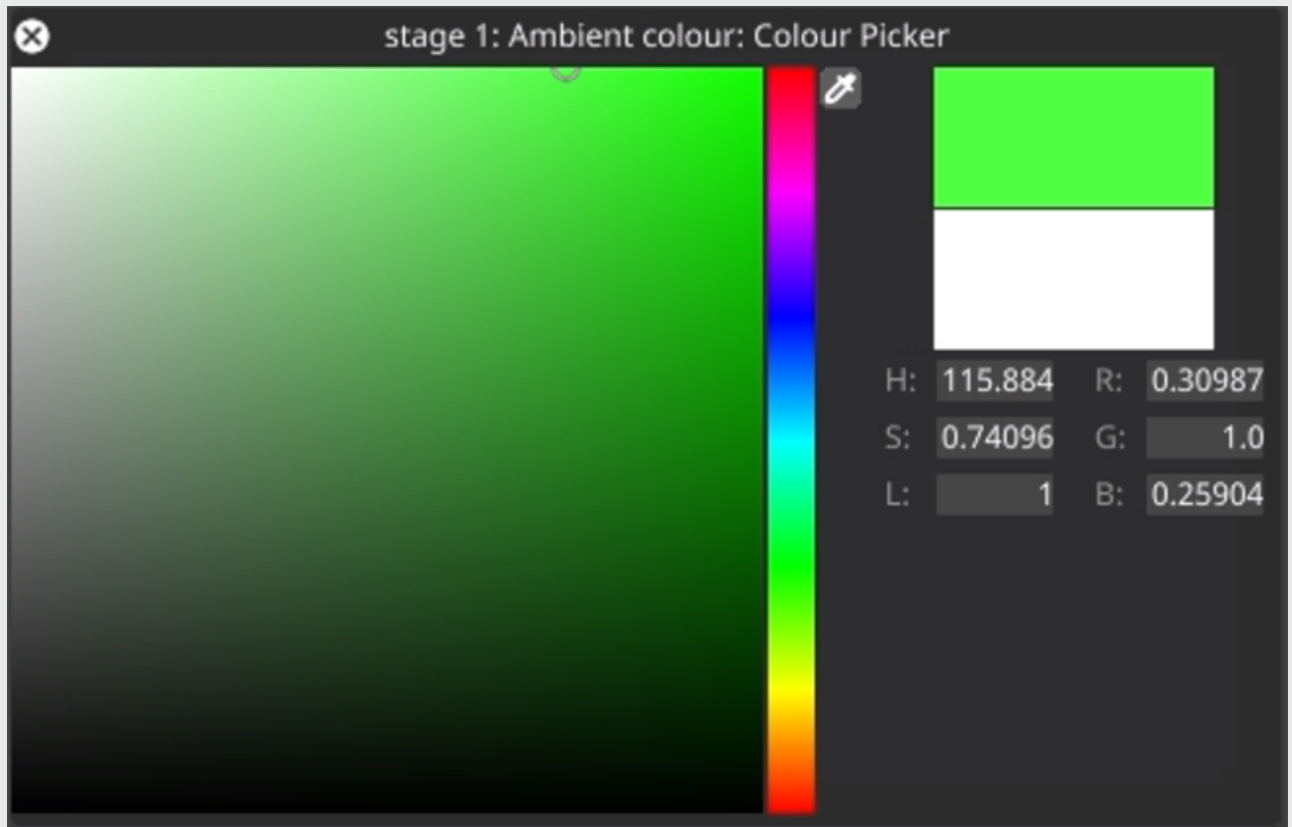

## Footprints level

This property is a resolution multiplier for projector shadow buffers. 0 disables footprints.

## LED Screens

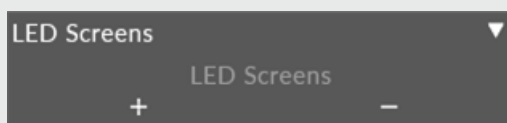

Click the + icon to open the LED screens manager and create new LED screens to add to the stage.

Left click and drag LED screens in the list into the - icon to remove them from the stage.

For more information see [screen types overview](#) and [creating screens](#).

## DMX Screens

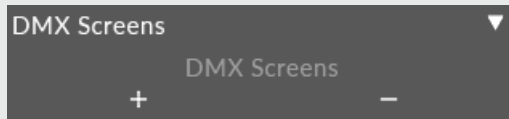

Click the + icon to open the DMX screens manager and create new DMX screens to add to the stage.

Left click and drag DMX screens in the list into the - icon to remove them from the stage.

For more information see [screen types overview](#) and [creating screens](#).

## DMX Lights

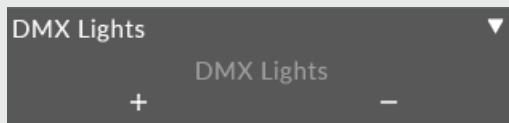

Click the + icon to open the DMX lights manager and create new DMX lights to add to the stage.

Left click and drag DMX lights in the list into the - icon to remove them from the stage.

For more information see [screen types overview](#) and [creating screens](#).



# Projection Surfaces

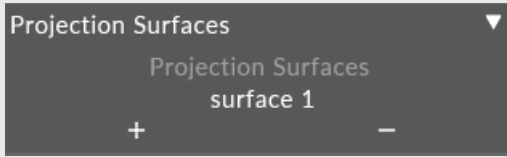

Click the + icon to open the Projection Surfaces manager and create new Projection Surfaces to add to the stage.

Left click and drag Projection Surfaces in the list into the - icon to remove them from the stage.

For more information see [screen types overview](#) and [creating screens](#).

# Projectors

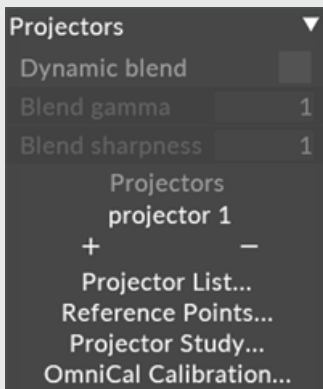

# Dynamic Blend

Toggles dynamic blend on and off for projectors, globally.

## Blend gamma

Controls the blend gamma for Dynamic Blend.

## Blend sharpness

Controls the blend sharpness for Dynamic Blend.

Click the + icon to open the Projector manager and create new Projector to add to the stage.

Left click and drag Projectors in the list into the - icon to remove them from the stage.

For more information see [screen types overview](#) and [creating screens](#).

## Projector List...

Clicking this button opens a list of all projectors in the project, with the ability to edit their properties in one editor. This can also be accessed with the shortcut, **CTRL P**.

## Reference points...

Clicking this button opens a list of all projector calibration points in the project, with the ability to view the name, parent object as well as toggle the mute, lock & delete functions.

## Projector Studies...

Clicking this button opens the [Projector Studies](#) editor.

## OmniCal Calibration...

Clicking this button opens the [OmniCal Calibration](#) editor.

# Cameras

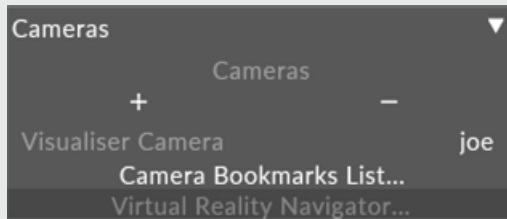

The cameras tab allows you to add fixed cameras to the stage that all have their own rendering settings. All cameras can be assigned to feed outputs.

## Visualiser camera

The visualiser camera is the camera you are looking through on the local machine. It has its own set of settings, and can be changed by left clicking the property and selecting a different camera. See [visualiser renderer](#) for more information.

## Camera bookmarks list

Opens the camera bookmarks list.

See [storing & recalling camera positions](#) for more information.

## Virtual reality navigator

Opens the VR viewfinder.

# Actions

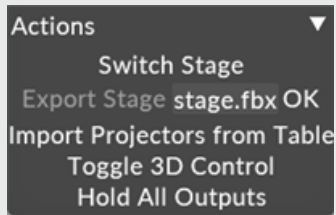

Select the Actions tab to display the following properties:

## Switch Stage

This property allows you to change the stage displayed in the Stage Visualiser. The currently active stage name will be displayed in the **Stage** tab of the dashboard as highlighted in the image below.

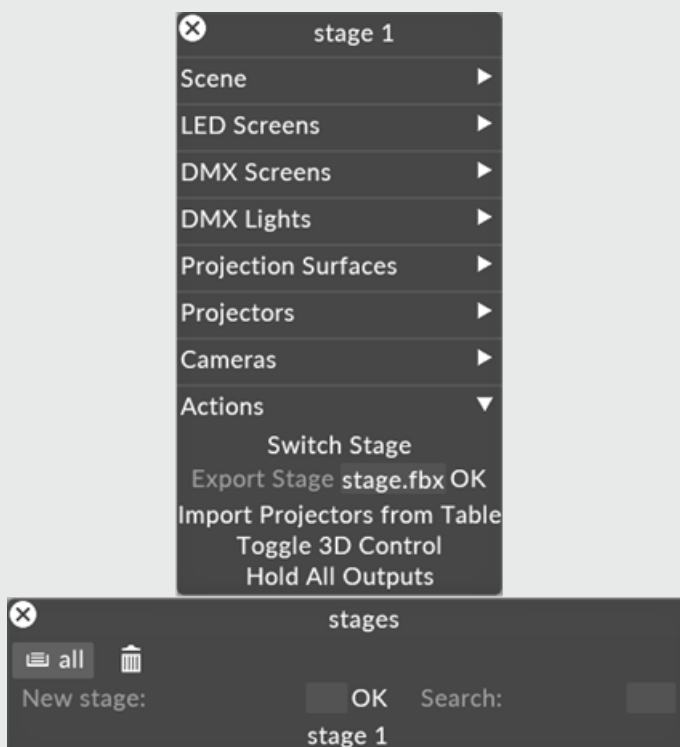

Switch Stage property is used to open the Stage manager and select a stage

To create a new stage:

1. Left-click **Switch stage** to open the Stage manager. This will display a list of all of the stages you have created.
2. Type the name of a stage into the **new stage** text field and hit **Enter**. This will create a new stage which will be added to the Stage manager.

You can then use the Stage editor to select the stage you want to switch with the currently active stage.

## Export stage

As of r17.3, the stage can be exported as either FBX, OBJ or 3DS.

1. Enter a name for the export.
2. Append the file extension, such as .fbx .obj or .3ds
3. Click **OK**.



4. The exported file will be written to the output folder of the project folder.

## Import Projectors from table

This button is used to import projectors via CSV. See Projector Import for more information.

## Toggle 3D control

This button is used to toggle the Manipulators function on and off. It can also be toggled through the axis icon on the track header and with the CTRL M keyboard shortcut.

## Hold/Unhold all outputs

Hold all outputs is a toggle between hold/unhold. Similar to the existing Hold functionality available in the dashboard, this function allows you to quickly set all screens in the stage to Hold mode which freeze the frame displayed on them, allowing you to continue sequencing without changing their output. This can also be done on a per screen basis as detailed in [output properties](#).

# Manipulators

Manipulators allow the user to offset, rotate and scale properties of objects in the stage using mouse input rather than numeric values.

## Overview

Manipulators are a feature of the stage added in r17. They allow the user to freely offset, rotate and scale objects such as screens, projectors and props in the stage using a combination of keyboard shortcuts and mouse manipulation. This feature allows for workflows that are more familiar to users from packages such as Blender, 3DS, Cinema4D etc.

## Workflow

1. Select items in the stage by left clicking on them. When highlighted, items will receive an orange outline.
2. Use the E, R or T buttons on the keyboard to toggle between offset, rotate and scale modes.
3. Use the on screen gizmo to manipulate the object(s)

## Example

1. Select items in the stage by left clicking on them. When highlighted, items will receive an orange outline.
2. Use the E, R or T buttons on the keyboard to toggle between offset, rotate and scale modes.
3. Use the on screen gizmo to manipulate the object(s) by left clicking and dragging on one of the coloured axis handles.

## Manipulators shortcuts & actions

### Manipulators editor



The Manipulators editor appears as an overlay to the stage when Manipulators are enabled via the icon on the track header, or by clicking **Toggle 3D control** in the actions tab of the stage editor.

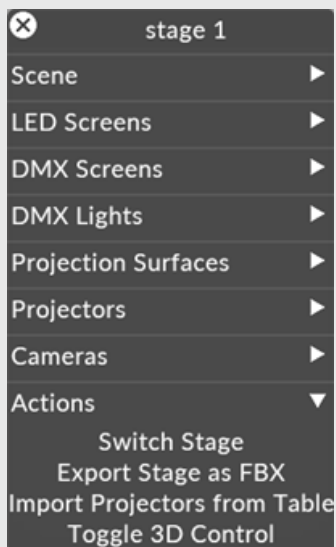



# Keyboard shortcuts

Once Manipulators are activated, you can then use the following keyboard shortcuts while using the feature:

## Offset (E)

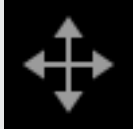

The offset mode allows you to freely offset x, y or z values using the gizmo in the stage.

## Rotate (R)



The rotate mode allows you to freely rotate x, y or z values using the gizmo in the stage.

## Scale (T)



The scale mode allows you to freely scale x, y or z values using the gizmo in the stage.

**Please note:** Note that some items, for example Projectors, cannot be scaled.

## Object/ Global space toggle (G)



Global space is the coordinate system for the entire scene. Its origin is at the center of the stage.

Object space is the coordinate system from an object's point of view. The origin of object space is at the object's centroid, and its axes are rotated with the object.

If multiple objects are selected, object space refers to the centroid of all selected objects with the rotation of the most recently selected.

# Screen types overview

## What is a screen?

A screen in Disguise software consists of exactly as many pixels as there are in the real world screen. Content can be rendered from the [Timeline](#) and mapped to the screens in the stage in real time (with the exception of the Projector screen type). The screens can then output their data via the Feed system or DMX depending on the screen type. The Disguise software uses DmxScreens to output DMX data, and DmxLights to create DMX-based moving lights and other DMX-based screens.

## Types of screens

The Disguise software contains five different screen types that can be added to a stage.

### Dmx Lights

This is the screen type to use when you want to create DMX-based moving lights and other DMX-based screens where custom DMX drivers are required (that cannot be created using the DmxScreens type, see below). DmxLights also visualises beam effects and movement. Learn more about DmxLights in the [DmxScreens/Lights](#) chapter.

### Dmx Screens

This screen type is a normal video screen of any shape and form but outputs DMX data instead of video. Learn more about DmxScreens in the [DmxScreens/Lights](#) chapter.

### Projection Surfaces

This screen type is an object that will be projected onto and should be used in conjunction with a virtual projector. Projection screens have no output feed and require projectors to view them. Learn more about this feature in the [Projector Simulation](#) chapter.

### LED Screens

This screen type is used for LED screens.

### Projectors

This screen type is actually a virtual projector used for projection mapping projects. Learn more about this feature in the [Projector Simulation](#) chapter.

In addition, Disguise software contains by default a set of primitive meshes:

- 1 x 1m Rectangle. The name 'Rectangle' may sound confusing as it's actually a 1 x 1m plane. This plane has been exported from the origin in 3ds Max (0,0,0).
- 1 x 1m Cylinder.
- 1 x 1m Convex.

These three primitive meshes can be used as the screen mesh for the six different screen types (with the exception of Projectors), defining the shape of your screens. They are already UV-mapped and can be re-sized, positioned and configured to match your design requirements. If you are using any other shape than the standard Rectangle, Cylinder or Convex meshes, the screen requires an imported UV-mapped **.obj** file as the screen mesh. Please see the Mesh section within the Editing screens sub-chapter for information on how to import a screen mesh into the software.

# Screen types overview

## What is a screen?

A screen in Disguise software consists of exactly as many pixels as there are in the real world screen. Content can be rendered from the [Timeline](#) and mapped to the screens in the stage in real time (with the exception of the Projector screen type). The screens can then output their data via the Feed system or DMX depending on the screen type. The Disguise software uses DmxScreens to output DMX data, and DmxLights to create DMX-based moving lights and other DMX-based screens.

## Types of screens

The Disguise software contains five different screen types that can be added to a stage.

### Dmx Lights

This is the screen type to use when you want to create DMX-based moving lights and other DMX-based screens where custom DMX drivers are required (that cannot be created using the DmxScreens type, see below). DmxLights also visualises beam effects and movement. Learn more about DmxLights in the [DmxScreens/Lights](#) chapter.

### Dmx Screens

This screen type is a normal video screen of any shape and form but outputs DMX data instead of video. Learn more about DmxScreens in the [DmxScreens/Lights](#) chapter.

### Projection Surfaces

This screen type is an object that will be projected onto and should be used in conjunction with a virtual projector. Projection screens have no output feed and require projectors to view them. Learn more about this feature in the [Projector Simulation](#) chapter.

## LED Screens

This screen type is used for LED screens.

## Projectors

This screen type is actually a virtual projector used for projection mapping projects. Learn more about this feature in the [Projector Simulation](#) chapter.

In addition, Disguise software contains by default a set of primitive meshes:

- 1 x 1m Rectangle. The name 'Rectangle' may sound confusing as it's actually a 1 x 1 m plane. This plane has been exported from the origin in 3ds Max (0,0,0).
- 1 x 1m Cylinder.
- 1 x 1m Convex.

These three primitive meshes can be used as the screen mesh for the six different screen types (with the exception of Projectors), defining the shape of your screens. They are already UV-mapped and can be re-sized, positioned and configured to match your design requirements. If you are using any other shape than the standard Rectangle, Cylinder or Convex meshes, the screen requires an imported UV-mapped **.obj** file as the screen mesh. Please see the Mesh section within the [Editing screens](#) sub-chapter for information on how to import a screen mesh into the software.

# Creating screens

When you create a new project, a projection surface screen and virtual projector are inserted by default. To remove this default screen see [removing screens](#).

## Creating a new screen

1. Right-click **stage** to open the [Stage editor](#). Each type of screen has its own tab in the stage editor. Listed below each screen type are screens associated to that type. A new project will, by default, contain a Screen called surface 1.

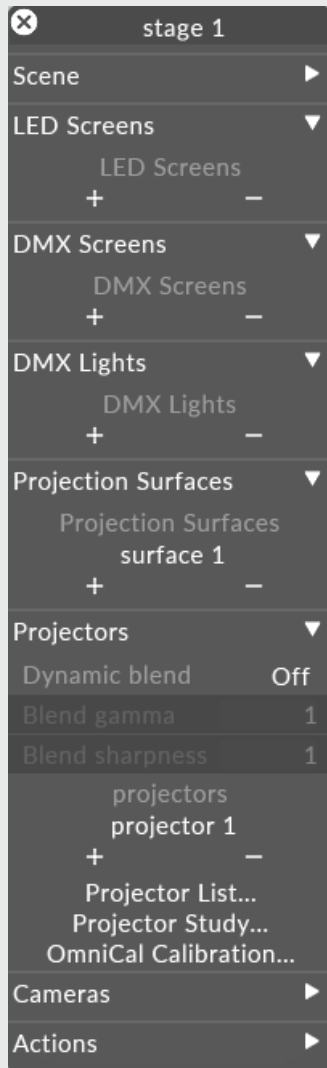

Stage editor showing the different screen types

2. Left-click the **+** button for the type of screen you wish to add. This opens the screen manager for that screen type. In this example we will add a new projection surface.
3. Type the name of the new screen in the **new surface** text box, in this example **Projection Screen**, and hit **Enter**.





To add a screen left-click the + for the correct type of screen and type a name for the new screen

The new screen will appear in the list of screens for that screen type. The new screen will be created and added to the currently active stage and the screen editor will open.

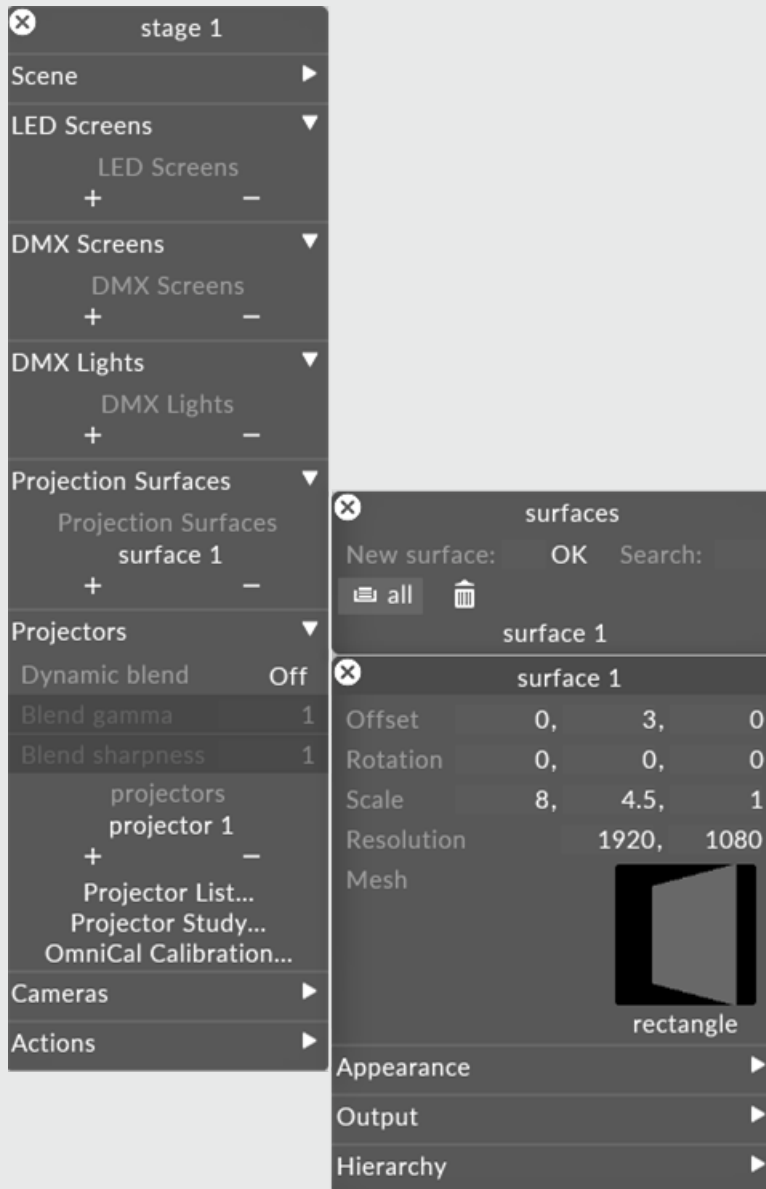

New screen listed in the screen list and the screen editor opened.

You can now edit the screen to change its size, position, orientation and shape.

# Deleting screens

## Permanently deleting a screen

1. Left-click on the **+** button just below the **screens** list for that type of screen in the Stage editor to open the Screens manager.
2. Left-click and drag the screen you want to delete from the Screens manager to **trash** (represented by a trash-can icon).

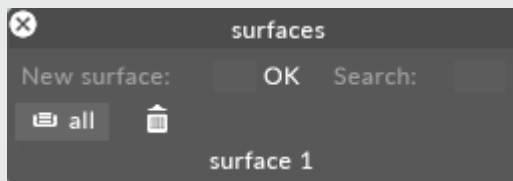

Left-click and drag the screen you want to delete from the Screens manager to Trash  
This places the screen in the trash can (deleted items)

To permanently delete the screen out of the trash can:

- Right-click **trash** and select **empty trash** to permanently delete the screen from your stage.

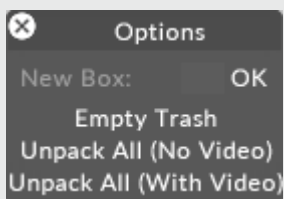

Right-click Trash and select Empty Trash to permanently delete the screen



**Warning:** you can never permanently delete a screen if it's active or referenced from anywhere in the project.

# Changing the Screen Type

## Changing screen type

1. right-click on the screen editor title bar
2. select the 'change type' option
3. select the new type of screen

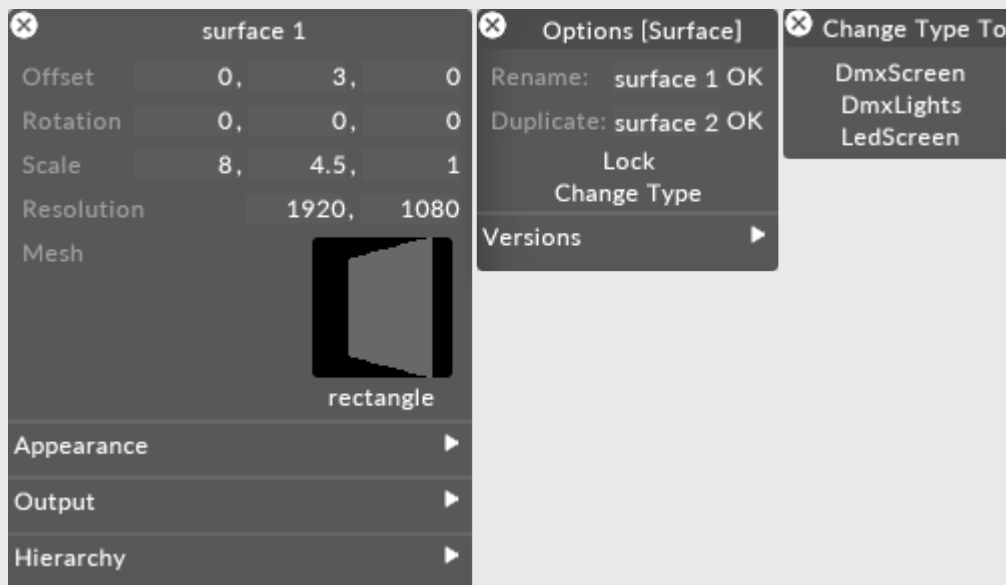

*Changing screen type*

# Removing screens

## Removing a screen

- Left-click and drag the screen name to the -button below in it's section of the Stage editor.

This will remove the screen from the currently active stage. The screen itself will not be deleted, it is still listed in the ScreensManager. To delete the screen permanently see the [deleting screens](#) sub-chapter.

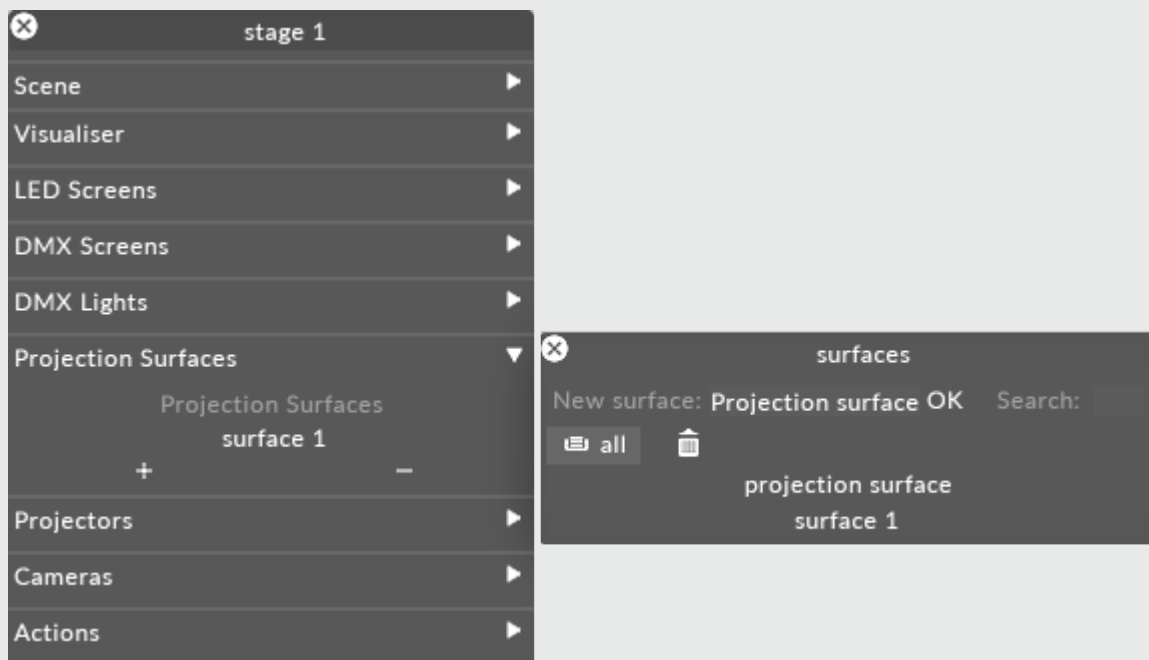

In this example surface 1, has been removed from the currently active stage, but remains in the surfaces manager.

# Screen editor

To edit a screen you need to open the **Screen editor**.

To open the Screen editor:

- Right-click a screen directly in the Stage level, or
- Right-click the screen name from the **screens** list in the Stage editor.

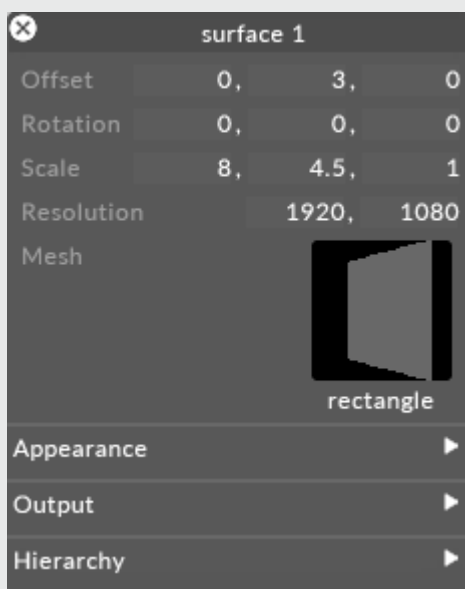

Screen editor is used to edit a screen.

# Screen editor

To edit a screen you need to open the **Screen editor**.

To open the Screen editor:

- Right-click a screen directly in the Stage level, or
- Right-click the screen name from the **screens** list in the Stage editor.

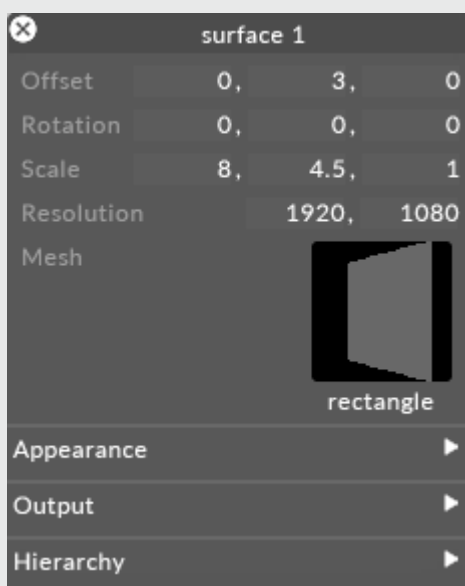

Screen editor is used to edit a screen.



# Screen properties

## Offset

This controls the screen position in the 3D space. There are three numbers laid out horizontally: respectively the x (left/right), y (up/down) and z (into/out of the screen) coordinates.

## Rotation

This controls the **rotation** of the screen mesh, in degrees. The x component controls the rotation around the x axis; the y component around the y axis; and the z component around the z axis. Mesh vertices are rotated around their origin; for this reason, it is recommended that mesh vertices are centered around their origin.

## Tracking source

This property defines which automation axis controls the offset & rotation properties of the object. For more information, see [Object tracking source](#).

## Scale

The **scale** property specifies a scaling factor to be applied to the mesh. If the original mesh is a unit mesh (i.e. its x, y and z extents are 1 meter) then the size refers to its actual size. The installed Rectangle, Cylindrical and Concave meshes are examples of unit meshes. The scales z component will have no meaning for flat rectangular screens. For screens with curvature (such as the installed Concave mesh) the z component will scale the z size of the screen.

## Resolution

This controls the **resolution** of the screens physical canvas. If you are using Disguise's pre-installed Rectangle mesh as the screen, set the resolution to match the physical dimension (aspect) of the screen.

## Mesh

This points to the Mesh file that defines the shape of your screens. Selecting this property will open the Mesh object library, which shows all of the Mesh **.obj** files saved on your local hard-drive in

the **Mesh** folder. The mesh consists of an array of vertices, each of which specifies a 3D position in space and a 2D texture coordinate that indexes the physical canvas.

To swap a screen mesh with the currently active mesh:

- Left-click **meshto** to open the Mesh object library.
- Left-click the mesh you want to replace the currently active mesh. This will update the screen mesh.

If you are using any other shape than the standard Rectangle, Cylinder or Convex meshes, the screen requires a UV-mapped **.obj** file as the screen mesh.

See the [Placing media files for a project](#) sub-chapter to understand where to place a mesh **.obj** file and how to access it in Disguise software. Also save the file to a [supported file format](#).

To edit a mesh:

- Right-click the mesh inside the Mesh object library to open the Mesh editor. The Mesh editor is used to flip or swap the UV mapping coordinates of a mesh or find out how many vertices a 3D mesh contains.

The chapter [LED Screen examples](#) explains how to create a UV-mapped LED screens.

# Appearance properties

Appearance properties control how the screen appears in the visualiser.

## Alpha

This controls the opacity of the screen. When Alpha is set to full (255), the screen is completely opaque; when Alpha is set to 0, the screen is completely transparent.

**Please note:** the Alpha value only takes effect when the **blendMode** is set to **alpha**.

## BlendMode

This controls how the screen contents are composited with the rest of the objects in the stage. Use **over** for nontransparent screens, **add** for screens that are totally invisible when there is no content on them, and **alpha** for screens that are partially transparent.

**Please note:** setting the mode to **over** when either mask contains transparent pixels will still make those pixels seethrough.

## Content

This controls how the screen displays its content in the Stage Visualiser. If you set it to **front**, only the front surfaces of the mesh will show content. If you use **back**, only the back surface will show content. If

you select **both**, both surfaces will display content.

## Brightness (NITS)

Sets the brightness in NITS. This value affects visualisation only.

## Viewing angle

Angle in degrees where luminance is at 50%. Visualisation in Lux only. Setting a value of 0 will disable the visualisation.

## Reflectivity

Proportion of incident light returned by the screen surface.

# Pixel mask

This points to the still image file that defines the Pixel mask. This property lets you specify an image mask that is applied to the screen per physical pixel and thus allows you to create specific looks for individual pixels. For instance, if your pixels are circular, your mask should consist of a circle.

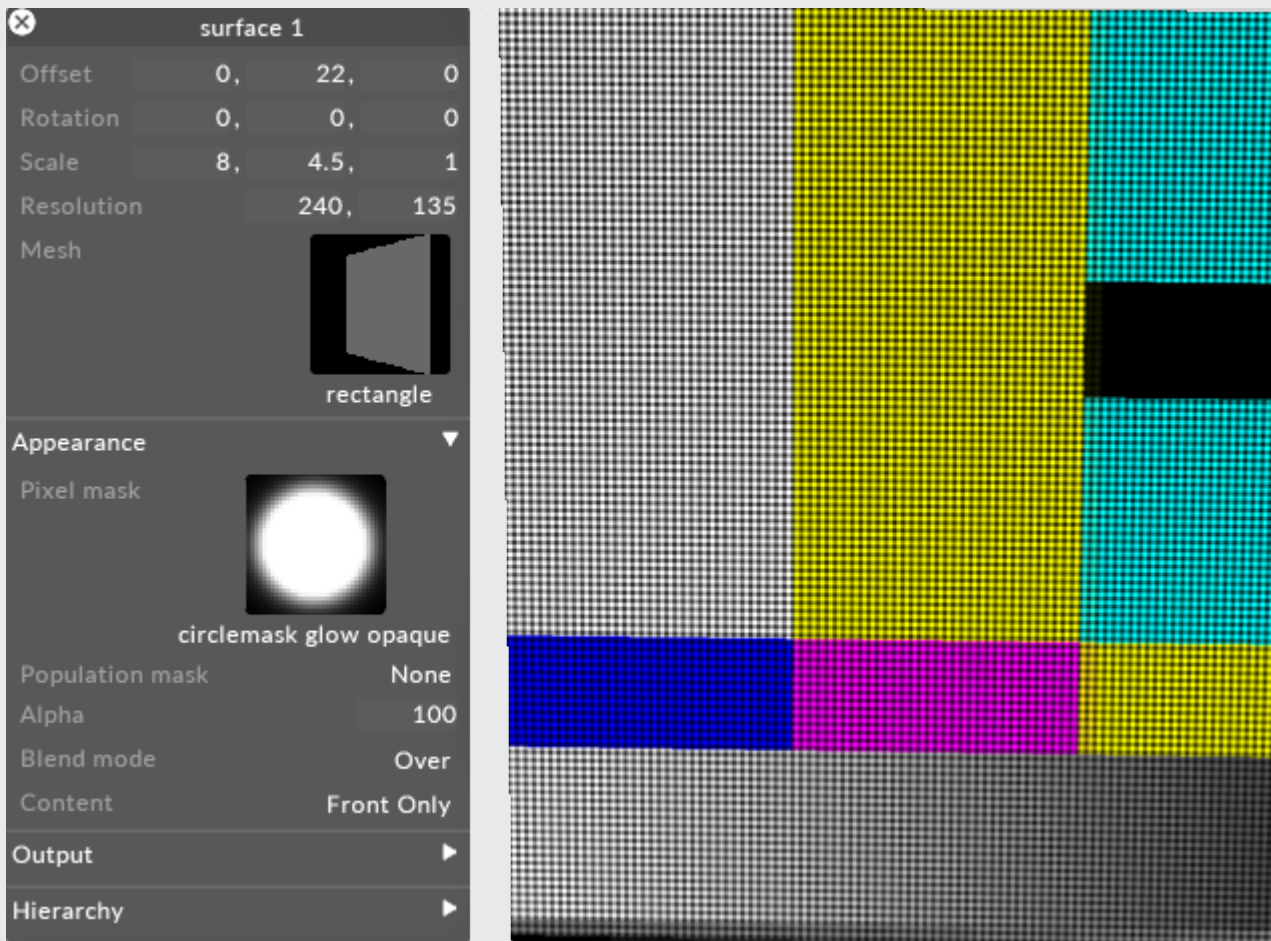

Circular Glow Opaque pixel mask applied to a screen

The Disguise software comes with a number of pre-installed Pixel masks for simulating LED Stealth screens. Selecting this property will open the Texture object library, which shows all of the Texture still image files saved on your local hard-drive in the **DxTexture** folder. Pixel masks can also have **alpha** channels, allowing you to model other seethrough LED technologies.

# Creating a Pixel mask

- Create a 36 x 36px **.png** image. We recommend using Adobe Photoshop for this.
- Make the transparent areas in the screen transparent in the Pixel mask.
- Make the illuminating areas in the screen as a white area in the Pixel mask.
- Make the black areas in the screen to black areas in the Pixel mask.

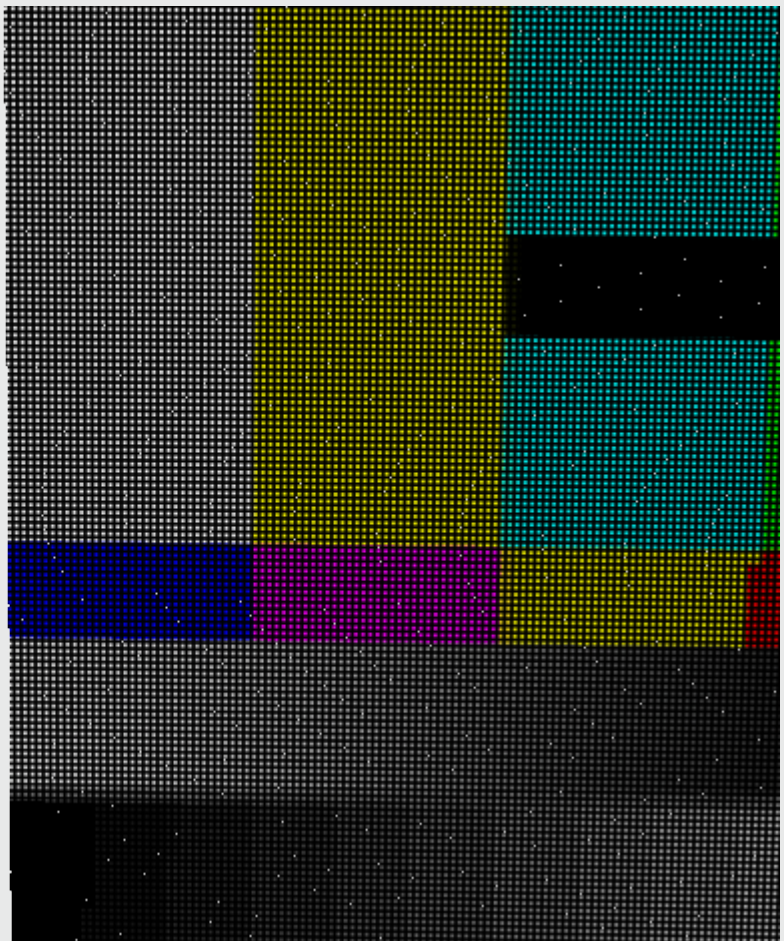
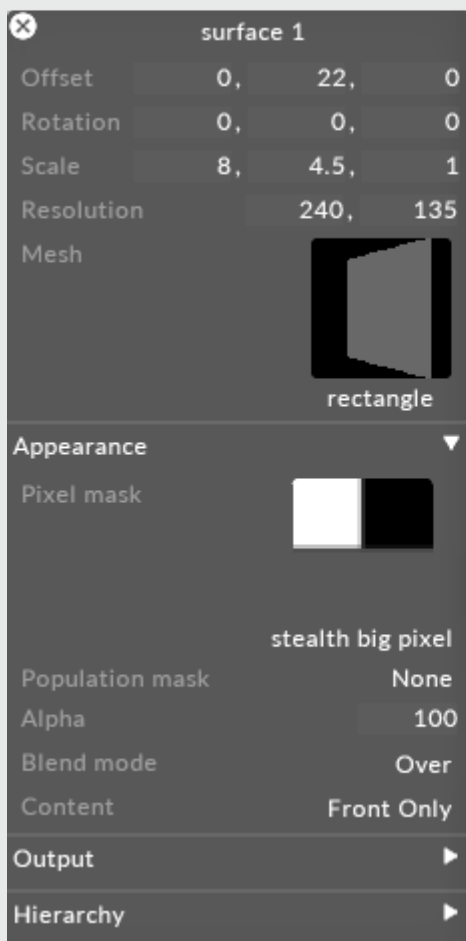

See the [Placing media files for a project](#) sub-chapter to understand where to place a still image file and how to access it in Disguise software. Also save the file to a [supported file format](#).

The Pixel mask will be applied onto every pixel of the screen (the number of pixels is defined by the resolution of the screen).

# Population mask

This points to the still image file that defines the Population mask. The population mask allows you to quickly specify which pixels in the screen are present and which are absent. Selecting this property will open the Texture object library, which shows all of the Texture still image files saved on your local hard-drive in the DxTexture folder. However, before placing a Population mask you will need to create it.

## How to create a Population mask

- Create a **.png** image. We recommend using Adobe Photoshop for this. The Population mask should have the same resolution as the screen.

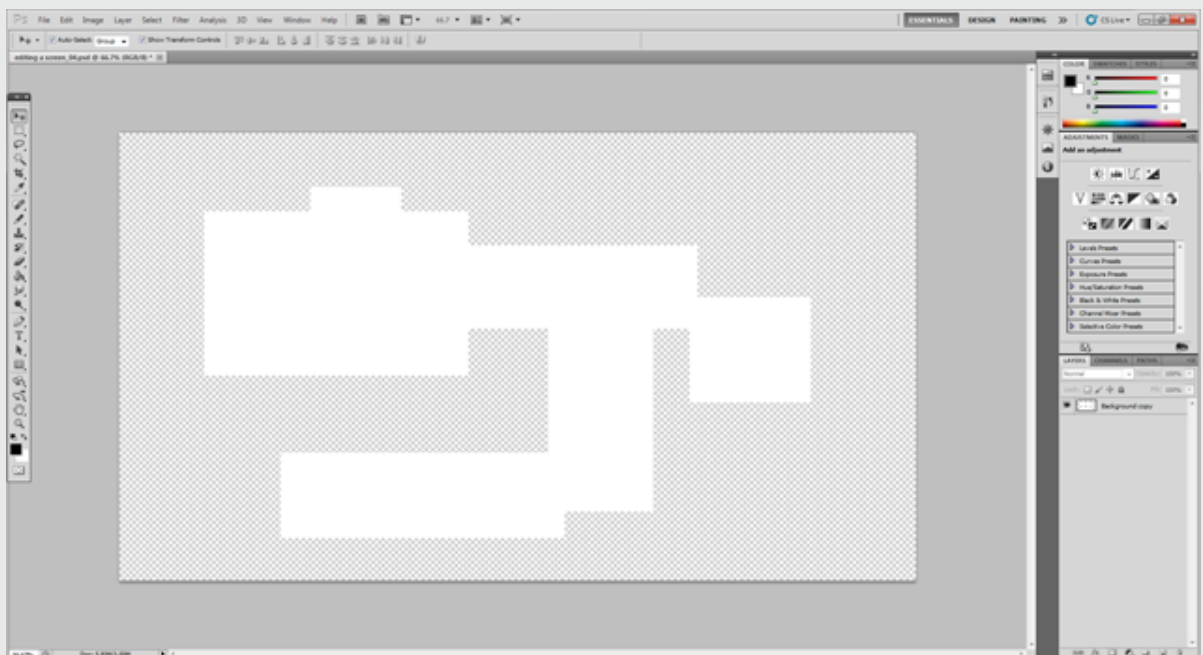



Population mask being created in Adobe Photoshop

- Make the areas you want to be see-through in the screen the alpha channel in the Population mask.
- Make the areas you want to be illuminating in the screen white in the Population mask.
- Make the areas you want to be black in the screen black in the Population mask.

See the [Placing media files for a project](#) sub-chapter to understand where to place a still image file and how to access it in Disguise software. Also save the file to a [supported file format](#).

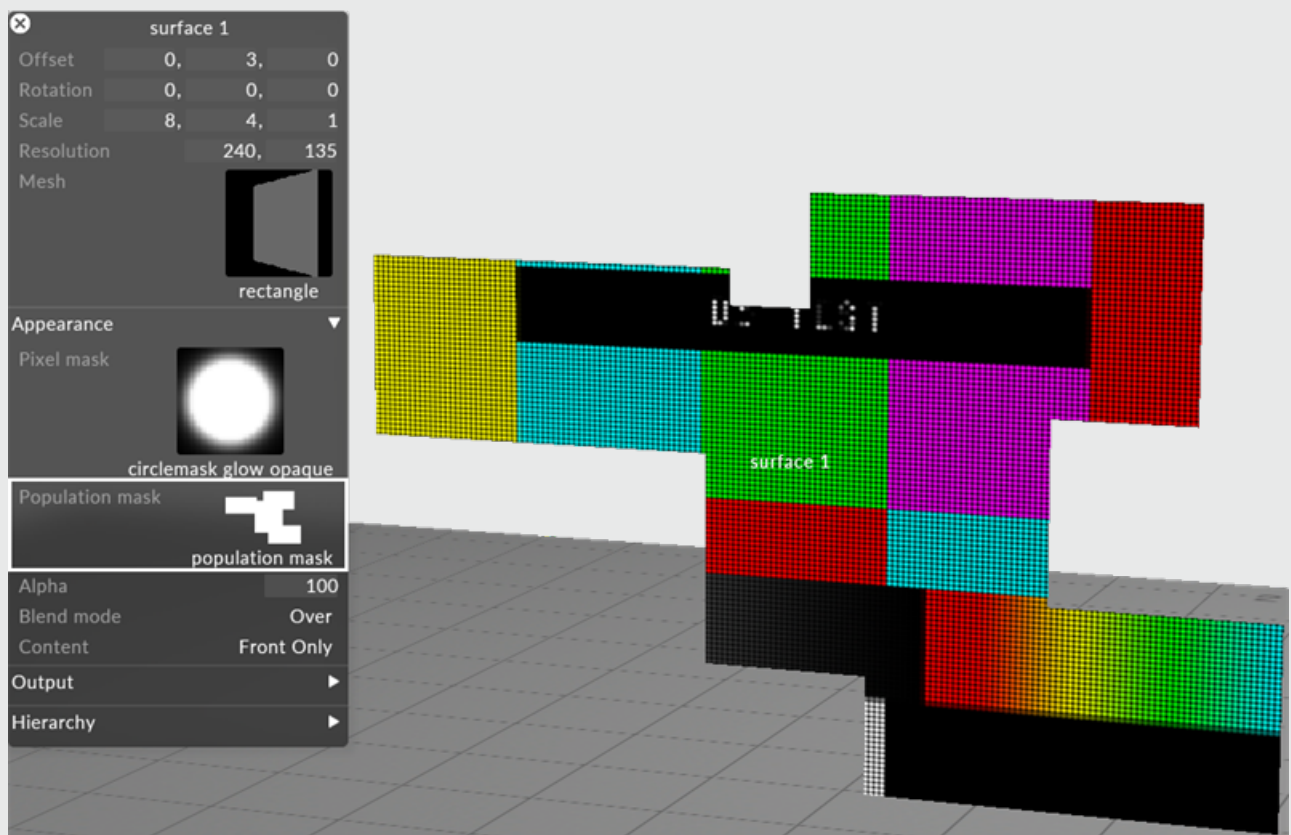

Population mask created in Adobe Photoshop applied to a screen

# Output properties

Output properties control additional properties that affect a screens output.

## Render layer

The render layer feature allows you to define where the screen is rendered.

**On Stage** - the screen is rendered in the camera & projector view ports.

**Off Stage** - the screen is in the stage, but not rendered at all.

**Frontplate (AR)** - the screen is in the stage, but only rendered to the camera frontplate.

## Master fade

This controls the output level of the screen when sent to the Output Feeds level. It ranges from 0 to 1. Use this to reduce the brightness of a physical screen to compensate for cameras or other less bright fixtures. Reducing Master Fade does not affect the brightness of the screen content in the Stage level.

## Colourshift

Each Screen has a **Colourshift** property which can be used to control the colour balance of the screen when sent to the Output Feeds level. This can be used to compensate for different colour and brightness characteristics of different LED technologies, allowing you to output consistent colour and brightness when using a mix of different technologies. This parameter does not take effect in the visualiser, as it is used exclusively to fix display hardware inconsistencies. For a full explanation on the **Colourshift** property please see the Colour Shift section of the Common layer properties topic.

## Colour profile

Allows you to specify a Colour profile for a screen.

## Colour LUT

Allows for a LUT file to be applied to the screen. This is useful if you need to change the colour profile of the screen. We recommend you do this in your LED screen processor or onboard screen hardware, but an option do to it via a LUT exists for circumstances this may not be possible or for other creative uses.

## Projector View Blending

Allows for Alpha blending in the projector view. Note that the projector surface blend most must be set to **Alpha** for this to work.

## Hold output

The hold output function allows the user to freeze the output of a screen similar to the project level Hold function. This allows the user to continue sequencing but hold the frame of output on one or a selection of screens.

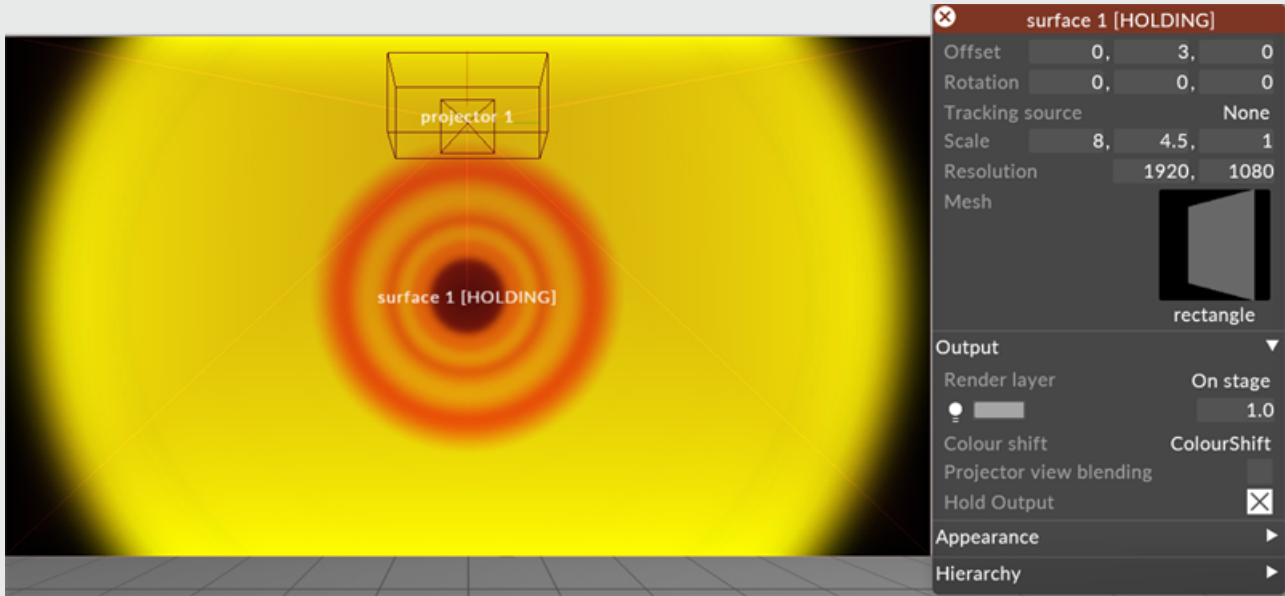

# Hierarchy

Parenting objects such as screens, props, and projectors.

It is possible to make a object such as a screen, prop or projector the child of another object. This links the objects together, meaning that if you change the offset and rotation properties of the Parent object, the Child object will also be affected.

## How to add a child to a screen

1. Right-click the screen you want to turn into a parent screen, in this example **mother screen**. This will open the Screen editor. Notice that **stage 1** is the parent of the Mother screen.
2. Under the hierarchy tab, left-click **Add Child** . This will open up a list of all screens and props in your Stage.



List of potential child screens and props opened by left-clicking Add Child from the Screen editor

3. Left-click the screens you want to turn into children of the Parent screen. In this example we have added **child screen 1** and **child screen 2** as children of the Parent screen **mother screen 1**.

**Please note:** After adding a child to the parent screen you will see that the child screen position and rotation have changed. This is because its offset position and rotation is now calculated from the pivot point of their parent screen rather than calculated from the centre of the Disguise Stage.

## How to parent the child back to the Stage

- Under the hierarchy tab under the the child screens editor, left-click **Parent to Stage**. This will bring the child screen back to be parented to the Stage, in this example **stage 1**.

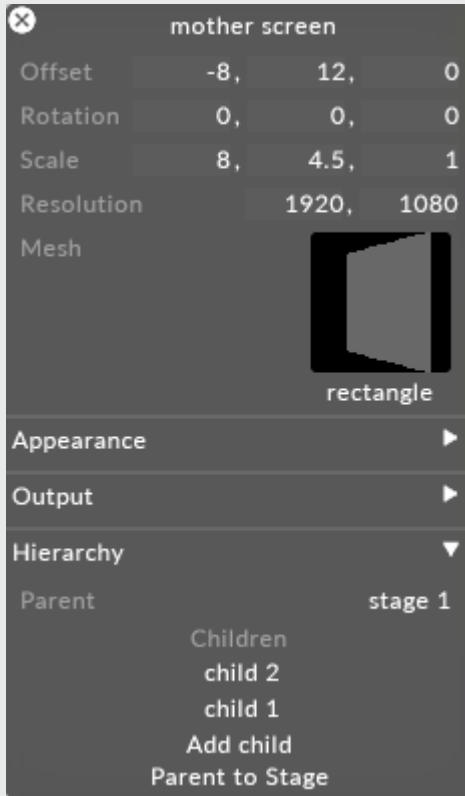

*Parent to Stage property of the Child Screen editor being used to return the Child screens parent back to Stage 1*

Note: A Parent screen can have multiple child screens and props.

# Pixel mask

This points to the still image file that defines the Pixel mask. This property lets you specify an image mask that is applied to the screen per physical pixel and thus allows you to create specific looks for individual pixels. For instance, if your pixels are circular, your mask should consist of a circle.

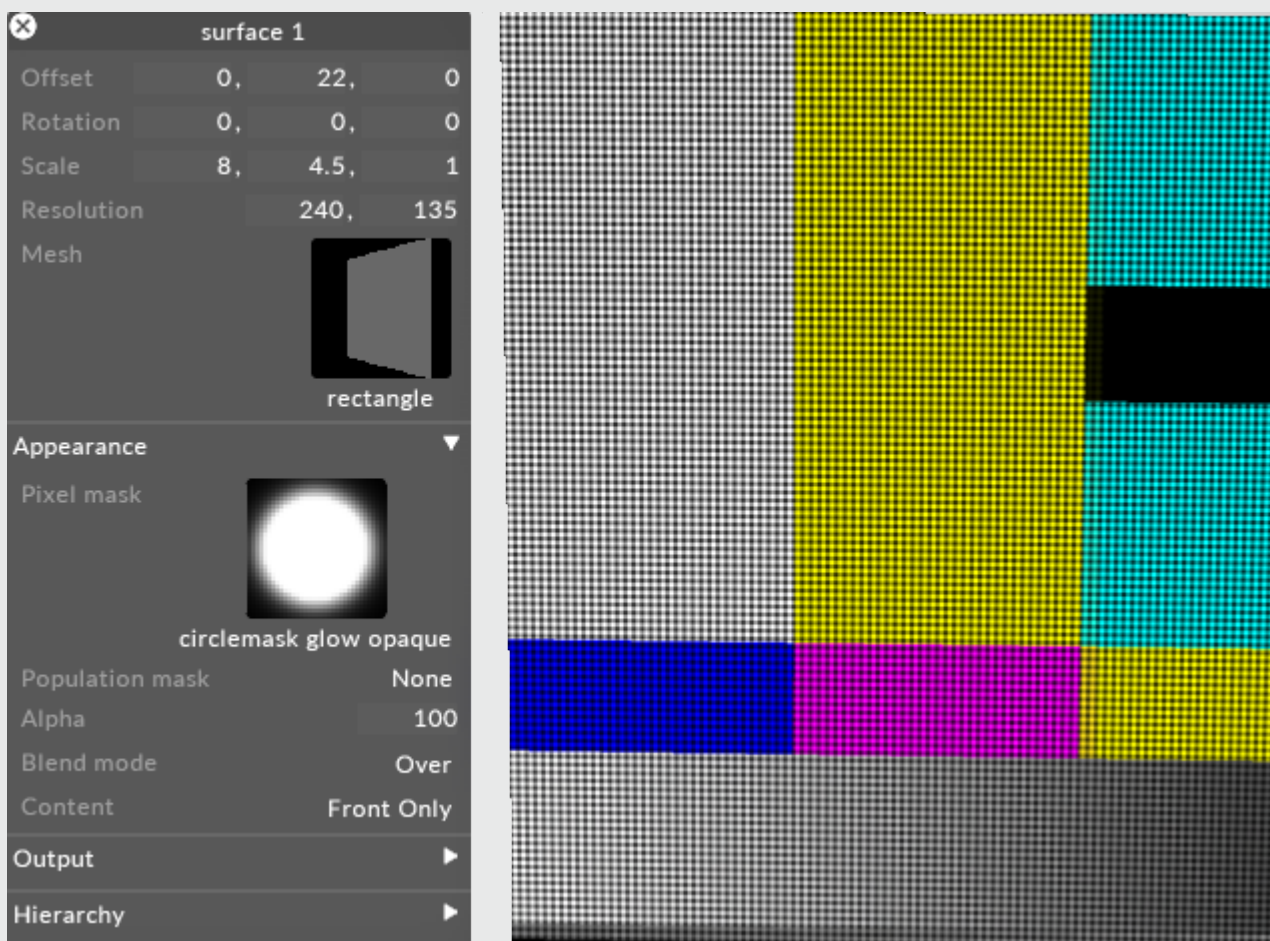

Circular Glow Opaque pixel mask applied to a screen

The Disguise software comes with a number of pre-installed Pixel masks for simulating LED Stealth screens. Selecting this property will open the Texture object library, which shows all of the Texture still image files saved on your local hard-drive in the **DxTexture** folder. Pixel masks can also have **alpha** channels, allowing you to model other seethrough LED technologies.



# Creating a Pixel mask

- Create a 36 x 36px **.png** image. We recommend using Adobe Photoshop for this.
- Make the transparent areas in the screen transparent in the Pixel mask.
- Make the illuminating areas in the screen as a white area in the Pixel mask.
- Make the black areas in the screen to black areas in the Pixel mask.

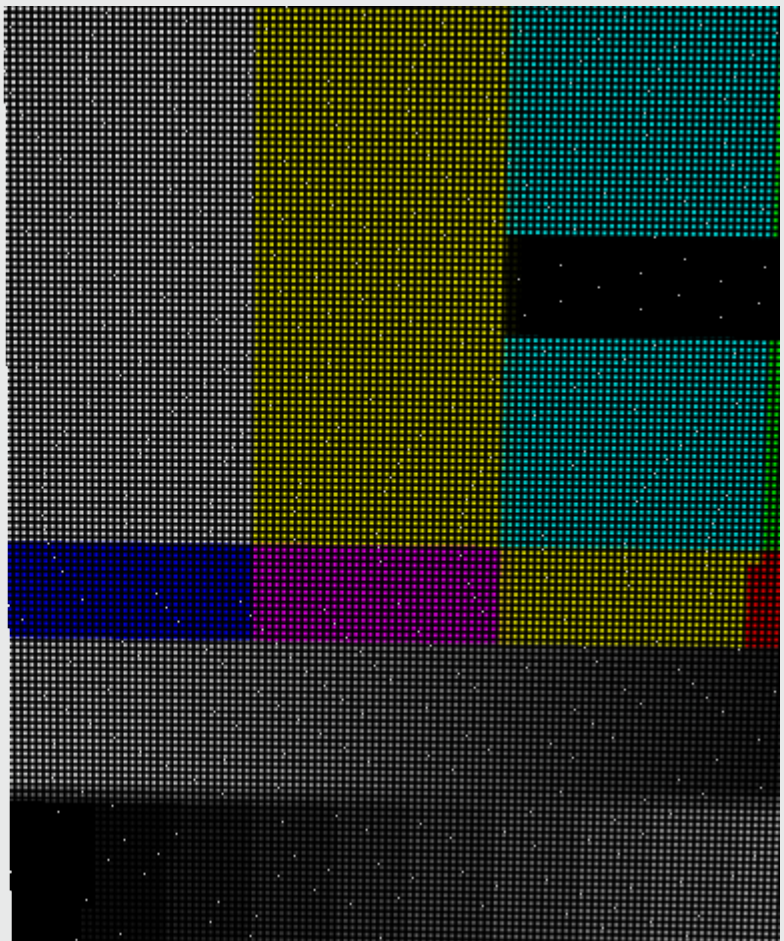
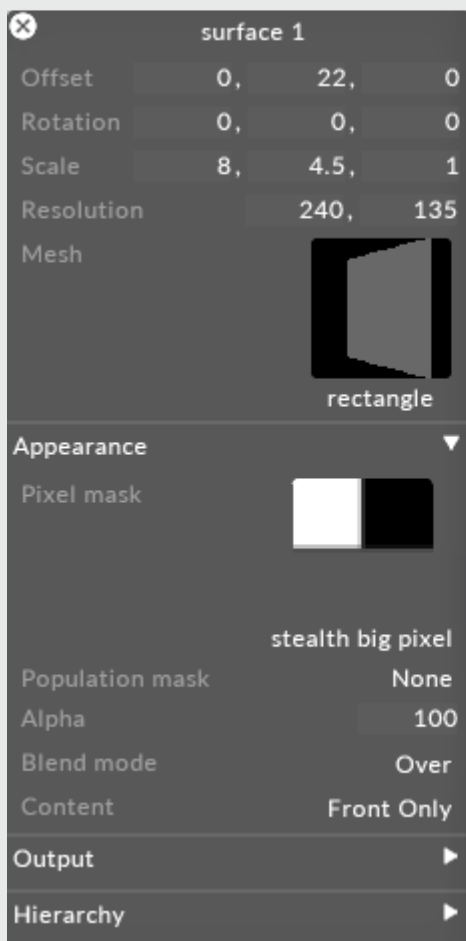

See the [Placing media files for a project](#) sub-chapter to understand where to place a still image file and how to access it in Disguise software. Also save the file to a [supported file format](#).

The Pixel mask will be applied onto every pixel of the screen (the number of pixels is defined by the resolution of the screen).

# Population mask

This points to the still image file that defines the Population mask. The population mask allows you to quickly specify which pixels in the screen are present and which are absent. Selecting this property will open the Texture object library, which shows all of the Texture still image files saved on your local hard-drive in the DxTexture folder. However, before placing a Population mask you will need to create it.

## How to create a Population mask

- Create a **.png** image. We recommend using Adobe Photoshop for this. The Population mask should have the same resolution as the screen.

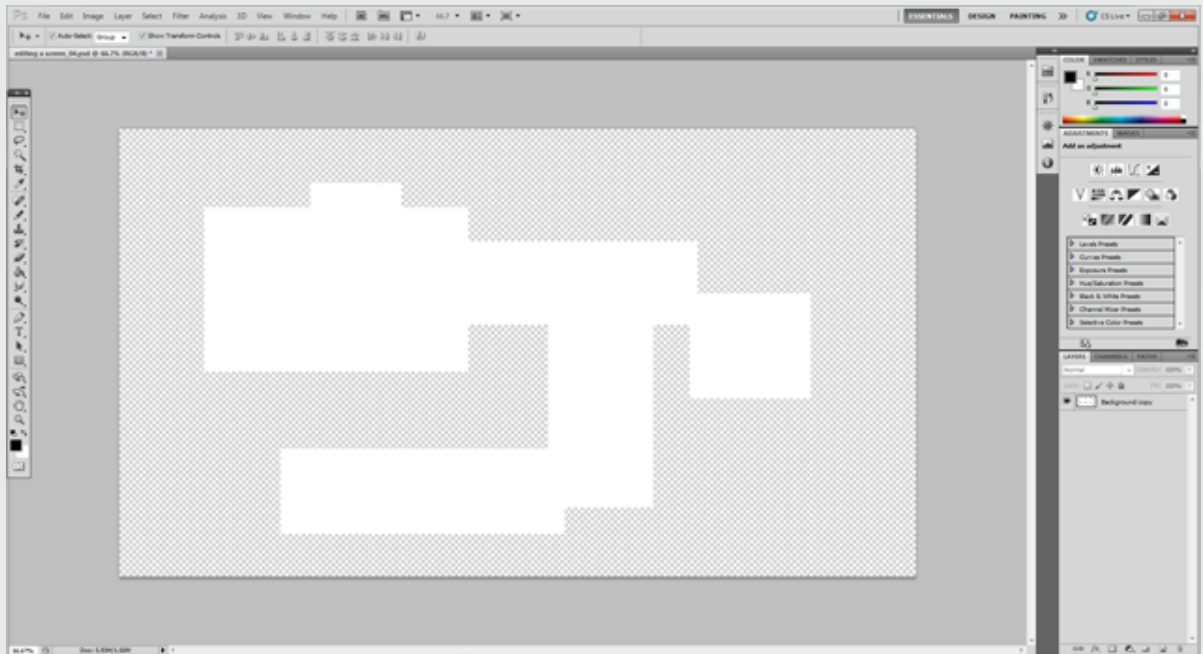

Population mask being created in Adobe Photoshop

- Make the areas you want to be see-through in the screen the alpha channel in the Population mask.
- Make the areas you want to be illuminating in the screen white in the Population mask.
- Make the areas you want to be black in the screen black in the Population mask.

See the [Placing media files for a project](#) sub-chapter to understand where to place a still image file and how to access it in Disguise software. Also save the file to a [supported file format](#).

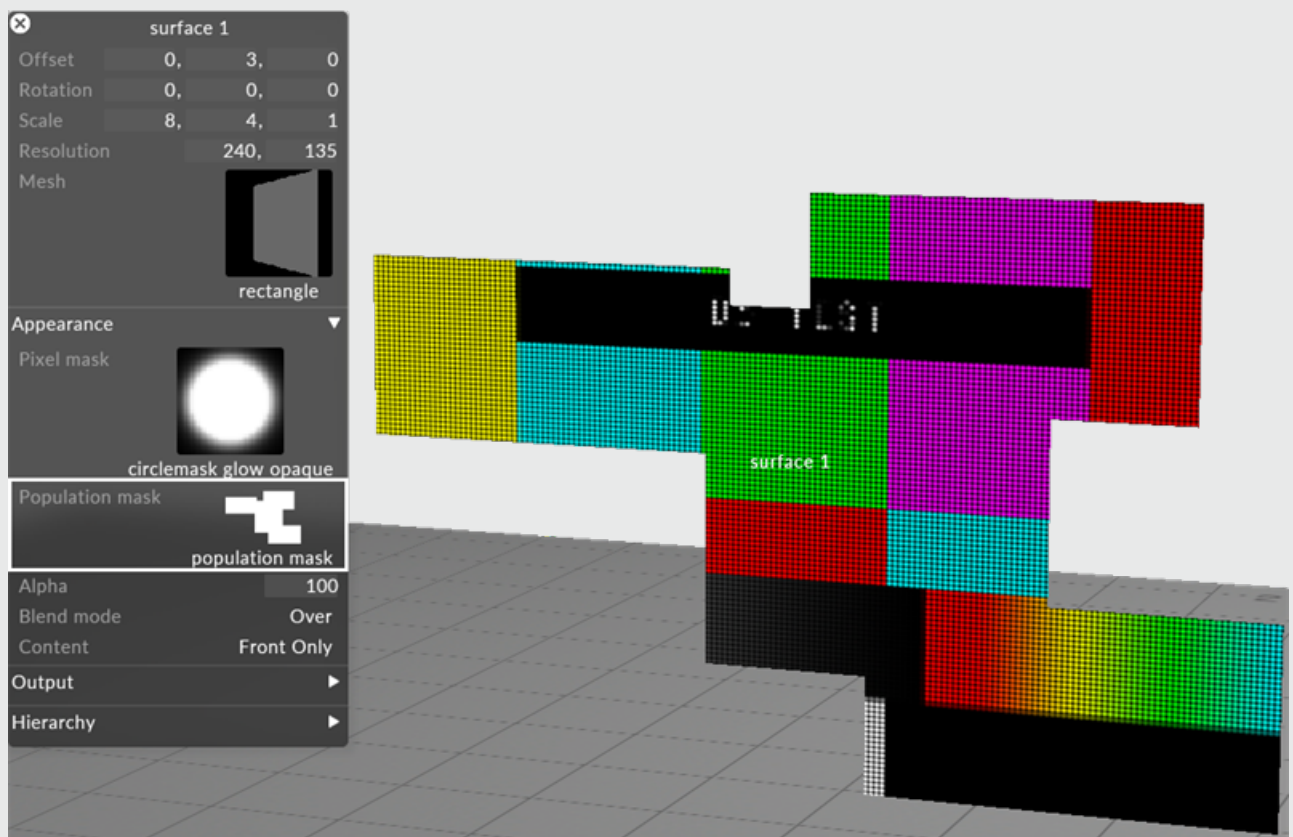

Population mask created in Adobe Photoshop applied to a screen

# Single Large Canvas

A Single Large Canvas (SLC), launched in r22, is a practically unlimited canvas that users can operate on without having to manually split canvases (i.e. the displays and mappings) or concern for the mechanics and logic of distributing content over multiple machines or for performance. SLC allows users to focus on the creative side without concern for the practical limitations of large scale projects.

Previously, a show going from a small venue with HD screens to a large venue with massive screens had to work around GPU limits - such as the max internal resolution of 16384x16384 pixels of GPUs, - and manually split content across machines so the increased resolution wouldn't affect performance.

SLC removes these limitations and allows you to operate on massive content as if it was a single large piece of content, while only processing the content that is being output by each individual machine in the session.

SLC works in conjunction with the Media Distribution feature to make working with video at massive resolutions practical.

SLC can be combined with mesh projection to split large canvases across multiple machines.

## How to configure Single Large Canvas

The new logic is always enabled, but the SLC configuration is hidden and limited to non-SLC resolutions until explicitly enabled.

1. Tick the “enableSLC” option switch in advanced project settings.
  - a. The SLC config is now visible under d3->Advanced->SLC configuration.
  - b. SLC-aware display types (currently projection surfaces and LED screens) now have their default min/max set to 100,000x100,000 instead of 16384x16384.
2. Create a display larger than 16384x16384 or reduce the “Resolution threshold” in the SLC configuration to enable SLC splitting for that display.
3. Create SLC video content:
  - a. Split video content into regions smaller than 16384x16384 (most codecs only support 8K) and include a region name into each split in the format “\_region<region name>”.
  - b. Ingest the content and specify the regions inside d3 under <video clip>->Video asset->Regions.

**Please note:** SLC currently only supports projection surfaces and LED screens. Other displays are still limited to 16k.  
SLC does not currently integrate with any other content than video.

# DMX screens and DMX lights overview

## Background

The Disguise software DMX functionality was motivated by the need to control RGB LED pixel-based fixtures that were DMX-driven. In this view, a DMX-controlled pixel is no different from a DVI-controlled pixel; it is simply controlled using a different type of signal. This led to the implementation of the DMXScreen, which is identical to the normal screen type except that it outputs the RGB information via DMX instead of via the Feed system. For more information on the different screen types please see the [Screen types overview](#) sub-chapter.

Over time, this idea of lights being simply pixels extended to the control of traditional lighting fixtures, with the conversion from RGB to CMY colour spaces and the addition of moving head bases. This led to the creation of the Fixture System, which allows more complex fixtures to be modeled.

Using Disguise software for controlling DMX-fixtures is recommended for tasks involving highly sculptural lighting arrangements where the individual lights/pixels are being looked at, rather than lighting another surface. The Disguise software is particularly suited for RGB LED pixel fixtures, since these have no personalities as such and therefore have zero setup time.

However, Disguise does not replace traditional lighting desks where typical tasks such as lighting a performer or surface is a requirement.

## Current status

At the time of writing, Disguise software has the following limitations when dealing with DMX fixtures:

- The visualiser shows light beams but does not model how light falls on surfaces or smoke/fog.
- Shadows are not visualised.
- CMYK fixtures can be driven, as can RGB, RGB+Amber and RGB+white fixtures. However, fixtures that are controlled via colourwheel are not supported.
- Disguise software does not have a fixture personality library. This means that when using Disguise to drive a new fixture, you need to create and validate a fixture personality (the Disguise term is Fixture Driver) that specifies which channel numbers have which functions. This is usually a

simple process; however, it can take some time to get the driver working correctly and this time must be calculated into the project planning.

- Moving head fixtures are supported via the Target layer and Target2 layer. These allow groups of lights to be aimed at points in stage space. However, Disguise software does not provide as much control over aiming as a standard lighting desk would do.
- While Disguise software can control non-colour parameters such as iris, gobo, focus and zoom, a lighting desk is still recommended for controlling such parameters.



# DMX screens and DMX lights overview

## Background

The Disguise software DMX functionality was motivated by the need to control RGB LED pixel-based fixtures that were DMX-driven. In this view, a DMX-controlled pixel is no different from a DVI-controlled pixel; it is simply controlled using a different type of signal. This led to the implementation of the DMXScreen, which is identical to the normal screen type except that it outputs the RGB information via DMX instead of via the Feed system. For more information on the different screen types please see the [Screen types overview](#) sub-chapter.

Over time, this idea of lights being simply pixels extended to the control of traditional lighting fixtures, with the conversion from RGB to CMY colour spaces and the addition of moving head bases. This led to the creation of the Fixture System, which allows more complex fixtures to be modeled.

Using Disguise software for controlling DMX-fixtures is recommended for tasks involving highly sculptural lighting arrangements where the individual lights/pixels are being looked at, rather than lighting another surface. The Disguise software is particularly suited for RGB LED pixel fixtures, since these have no personalities as such and therefore have zero setup time.

However, Disguise does not replace traditional lighting desks where typical tasks such as lighting a performer or surface is a requirement.

## Current status

At the time of writing, Disguise software has the following limitations when dealing with DMX fixtures:

- The visualiser shows light beams but does not model how light falls on surfaces or smoke/fog.
- Shadows are not visualised.
- CMYK fixtures can be driven, as can RGB , RGB+Amber and RGB+white fixtures. However, fixtures that are controlled via colourwheel are not supported.
- Disguise software does not have a fixture personality library. This means that when using Disguise to drive a new fixture, you need to create and validate a fixture personality (the Disguise term is Fixture Driver) that specifies which channel numbers have which functions. This is usually a

simple process; however, it can take some time to get the driver working correctly and this time must be calculated into the project planning.

- Moving head fixtures are supported via the Target layer and Target2 layer. These allow groups of lights to be aimed at points in stage space. However, Disguise software does not provide as much control over aiming as a standard lighting desk would do.
- While Disguise software can control non-colour parameters such as iris, gobo, focus and zoom, a lighting desk is still recommended for controlling such parameters.

# Global DMX options

There are four global switches that control how Disguise software outputs DMX information. They are found under the DMX tab of the Program Settings menu.

- To access the global DMX properties, rightclick **d3** from the dashboard (bar at the top of the screen) and open DMX tab.

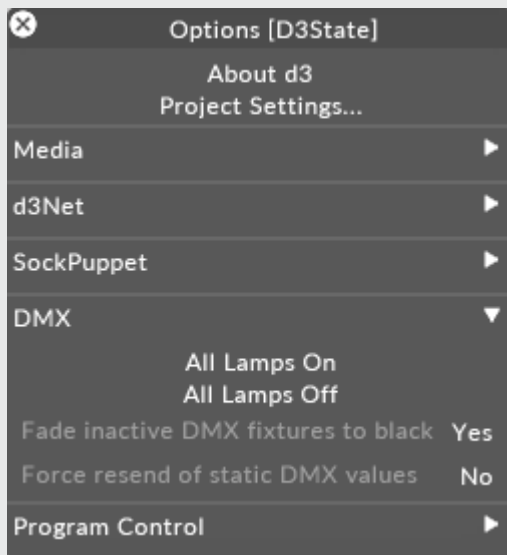

## Global DMX properties

### All lamps on

- Left-click **All lamps on** to send lamp on commands to all active fixtures in the stage.

### All lamps off

- Left-click **All lamps off** to send lamp off commands to all active fixtures in the stage.

**Please note:** some fixtures may have a mandatory cooling off period (say 5 minutes) before they can be turned off again.

## Fade inactive DMX fixtures to black

This option controls what happens when no layers on the Timeline are writing to fixtures. Selecting **yes** (default value) will enable Disguise software to send black; selecting **no** will enable d3 to send nothing.

## Force resend of static DMX values

This option controls whether or not Disguise software sends DMX values when they change. Selecting **no** (default value) will enable Disguise software to only send DMX values when they change; selecting **yes** will enable DMX values to be sent constantly, regardless of whether the value is changing or not. This setting can be useful when merging Disguise's DMX information with other DMX information, for example coming from a lighting desk.

# Creating DMX lights

DmxLights are screens to which a rectangular array of fixtures has been attached. The fixtures are spaced out equally across the surface of the screen and sample content from the screen before sending it out via DMX .

You should use a DmxLights screen when you are trying to control an array of complex fixtures. Complex fixtures are those which have any or all of the following:

- Shutter open/close, lamp on/off, reset and other commands
- CMY colour mixers with a traditional lamp
- Extra control channels such as focus, zoom, iris, gobo
- A moving head base with pan and tilt

## Creating a DmxLights screen

The DmxLights screen is added in the same way as any other screen type. Please see the sub-chapter [Creating/removing screens](#) for step-by-step instructions on how to add a screen to a stage, and select **DmxLights** from the menu of different screen types.

## DmxLights properties

The DmxLights properties are similar to the Screen properties, but with an extra tab called **addressing** (explained in the sub-chapter [DMX addressing](#)) and **fixtures** . Therefore all of the DmxLights properties not related to addressing or fixtures can be read in the sub-chapter [Editing screens](#).

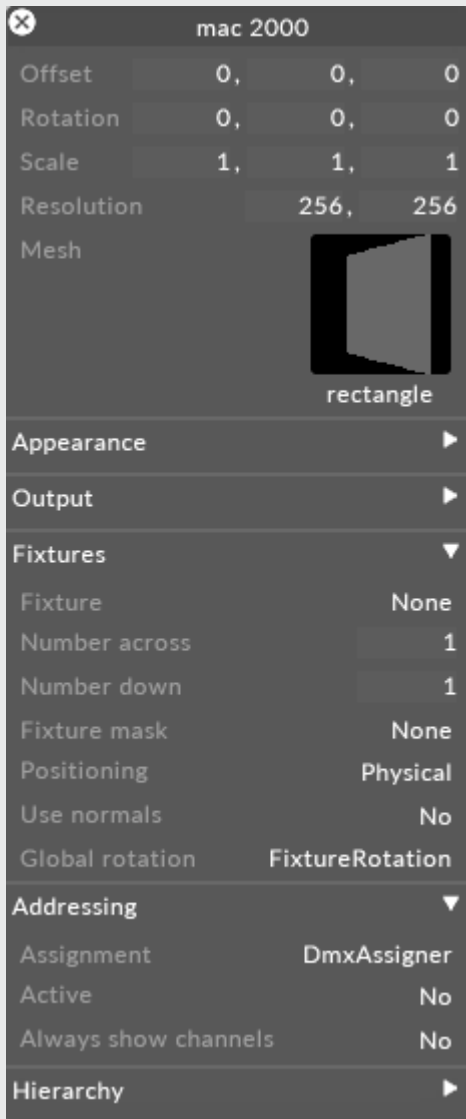

DmxLights has the same properties as a Screen but with two extra sections called Addressing and Fixtures

An explanation of each of the properties contained in the **fixtures** section are explained in the following sub-chapter [Creating a fixture](#) , and the sub-chapter [Setting up a grid of fixtures](#).

# Creating DMX lights

DmxLights are screens to which a rectangular array of fixtures has been attached. The fixtures are spaced out equally across the surface of the screen and sample content from the screen before sending it out via DMX .

You should use a DmxLights screen when you are trying to control an array of complex fixtures. Complex fixtures are those which have any or all of the following:

- Shutter open/close, lamp on/off, reset and other commands
- CMY colour mixers with a traditional lamp
- Extra control channels such as focus, zoom, iris, gobo
- A moving head base with pan and tilt

## Creating a DmxLights screen

The DmxLights screen is added in the same way as any other screen type. Please see the sub-chapter [Creating/removing screens](#) for step-by-step instructions on how to add a screen to a stage, and select **DmxLights** from the menu of different screen types.

## DmxLights properties

The DmxLights properties are similar to the Screen properties, but with an extra tab called **addressing** (explained in the sub-chapter [DMX addressing](#)) and **fixtures** . Therefore all of the DmxLights properties not related to addressing or fixtures can be read in the sub-chapter [Editing screens](#).

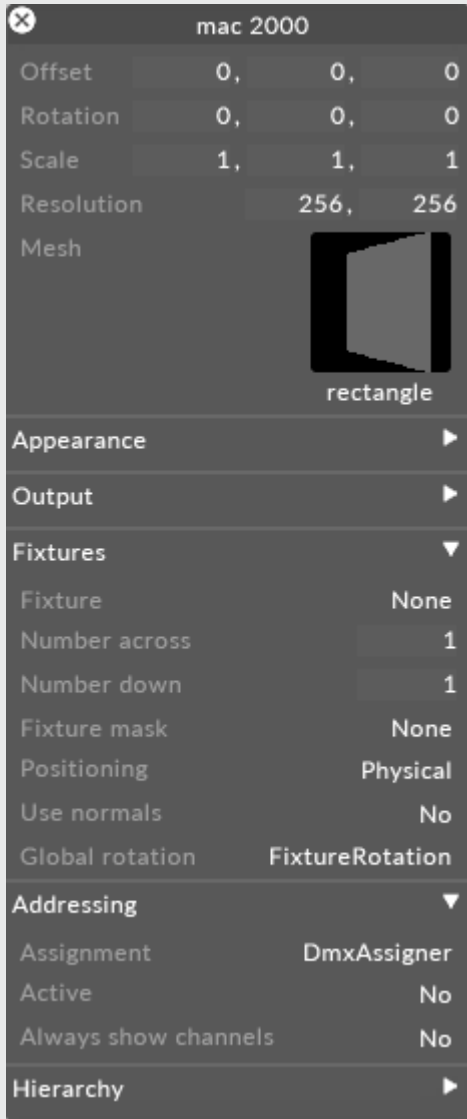

DmxLights has the same properties as a Screen but with two extra sections called Addressing and Fixtures

An explanation of each of the properties contained in the **fixtures** section are explained in the following sub-chapter [Creating a fixture](#) , and the sub-chapter [Setting up a grid of fixtures](#).



# Creating a fixture

When you first create a DmxLights screen, it is just an ordinary screen. You can drive content to it and see the content in the Stage Visualiser, but you cannot see the screen in the Feed level.

The first step is to set up the fixture the DmxLights screen will use to cover its surface. For information on how to create a DmxLights screen please read the previous sub-chapter [DmxLights](#).

To create a fixture:

1. Left-click **fixture** from the DmxLights editor. This will open the Fixtures manager.
2. Type in the name of the fixture in the **new fixture** text field, in this example **mac 2000**.
3. Hit **Enter** to open a list of fixture types.
4. Left-click the type **Fixture**.

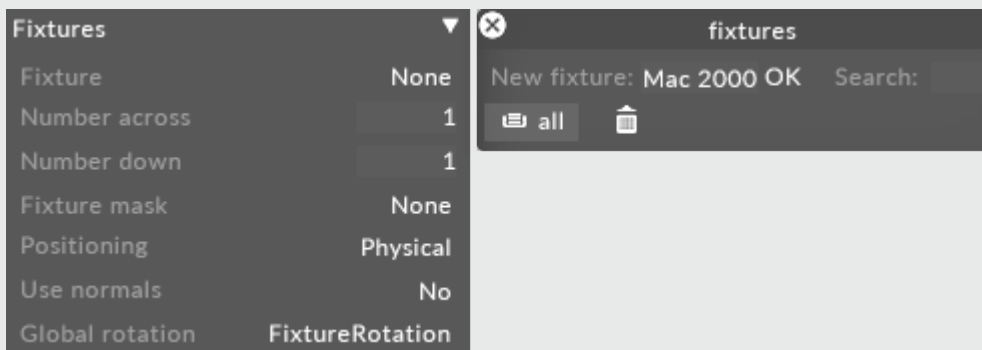

Process used to create a fixture, in this example Mac 2000

5. Hit **Enter** to create the new fixture. For information on how to create a grid of fixtures please see the following sub-chapter [Setting up a grid of fixtures](#).



Fixture editor, in this example for the newly created Mac 2000 fixture

- Hitting **Enter** will also open the Fixture editor.

**Please note:** the fixture object defines a fixture within the Stage Visualiser. It does not set up information about how to actually drive the fixture; that is handled by the **driver** property.

## Fixture properties

### Size

This specifies the physical size of the fixture, in meters. The first number is the x component (width), the second is the y component (height) and the third is the z component (depth). These numbers refer to the size of the actual fixture emitter, not to the total size of the fixture base.

### Resolution

Each fixture is considered to be a mini screen containing one or more pixels. The default resolution is 1 by 1 pixel (i.e. a single pixel) but it is possible to have multiple pixels in the same fixture. For example, a Traxon tile has a grid of 8 by 8 pixels; a Robe Redwash has a grid of 4 by 1 pixels.

### Aimable

Set this to **yes** if the fixture has a moving head, otherwise select **no**.



Aimable property should be set to yes if the fixture has a moving head

## Number of Channels

Specifies the number of DMX channels in the fixtures personality.

## Mask

This points to the still image file that defines the mask used when rendering the fixture. Selecting this property will open the Texture object library, which shows all of the Texture still image files saved on your local hard-drive in the **DxTexture** folder. By default d3 comes with a number of still image files. For example, fixtures with circular emitter profiles should use the **circlemask** bitmap.

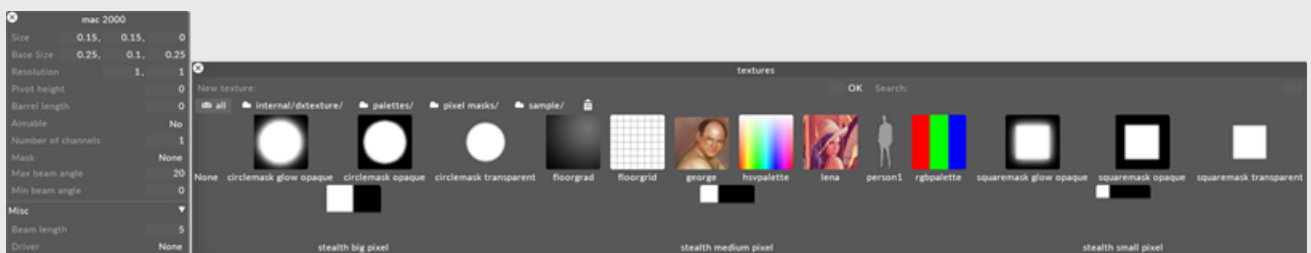

Mask property is used to select a still image file that defines the mask used when rendering the fixture

The instructions on how to create a custom Pixel mask can be used to create a mask for rendering a fixture. For step-by-step instructions on how to create a Pixel mask, where to place a still image file, and how to access it in d3, scroll down to the section Pixel mask in the [Editing screens](#) topic.

## Beam Angle

These control the max (zoomed out) and min (zoomed in) beam angles of the light, in degrees.

## Beam Length

This sets the beam length, in meters. This property is for visualisation purposes only; it does not send a signal to the light.

## Drivers

This specifies how colour and orientation information are sent to the actual physical fixture. For detailed information on how to use this property please see the [Fixture drivers](#) topic.

# Fixture drivers

The final property of a fixture, driver, specifies how colour and orientation information are sent to the actual physical fixture. Please scroll down to the section 'Fixture properties in the [Creating a fixture](#) sub-chapter for information on the other fixture properties.

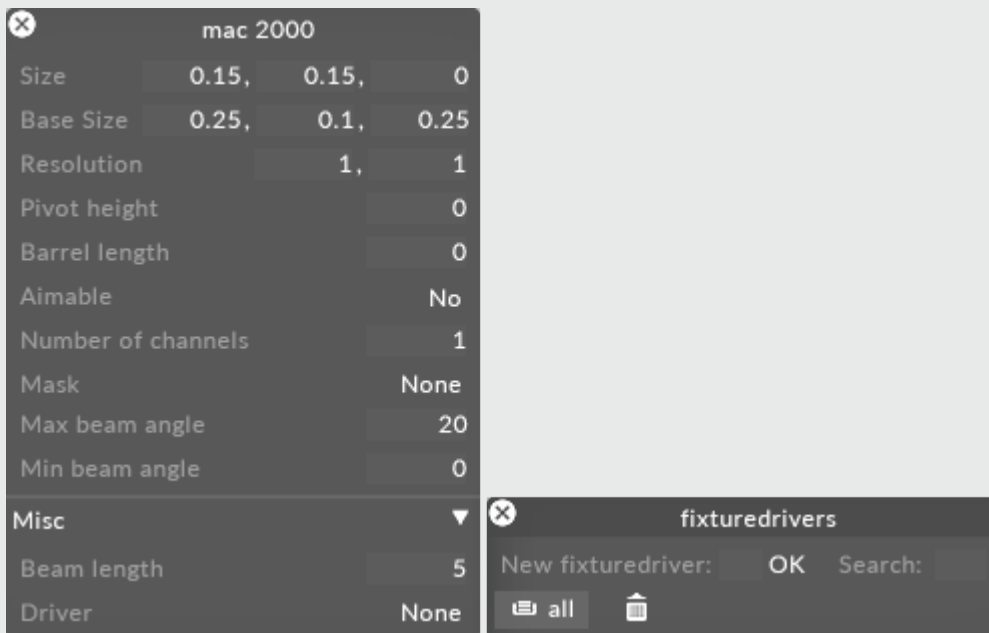

Driver property of a fixture specifies how colour and orientation information are sent to the actual physical fixture

This is sometimes referred to as the personality of the fixture. It is a list of functions that are supported by the fixture and the channels used to control those functions. This information is usually found in the product manual for the fixture, which is downloadable from the manufacturers website.

You can sequence a complete show in the visualiser without creating fixture drivers. However, a fixture must have a valid driver in order to be assigned a DMX address (channel/universe) using the addressing system and in order to send DMX to the outside world.

## Types of fixture drivers

There are four types of fixture drivers available, each suitable for a different class of fixtures.

## DmxDriver

This is the easiest type. Use this for DMXcontrolled pixelgrid fixtures that have no moving head or CMY colour mixing hardware.

## FixtureDriver

Please ignore this type of fixture driver.

## GenericLampDriver

This driver is suitable for traditional moving head lights containing (optionally) a pan and tilt base and (also optionally) a CMY (cyan/magenta/yellow) colour mixing system. It supports programming commands such as lamp on/off, shutter on/off, etc.

## MovingHeadLEDDriver

This driver combines elements of DmxDriver and GenericLampDriver and is suitable for moving head fixtures that have multiple LED pixels mounted on the moving head.

# Creating a fixture driver

To create a fixture driver:

1. Open the Fixture editor by right-clicking **fixture**, in this example **mac 2000** , from the DmxLights editor.
2. Open the Fixturedrivers manager by left-clicking **driver** from the Fixture editor.
3. Type in the name of the new fixture driver, in this example **bb4 driver**, in the **new fixturedriver** text field.
4. Hit **Enter** to create the new fixture driver.

5. Select a fixture driver type from the list of driver types.

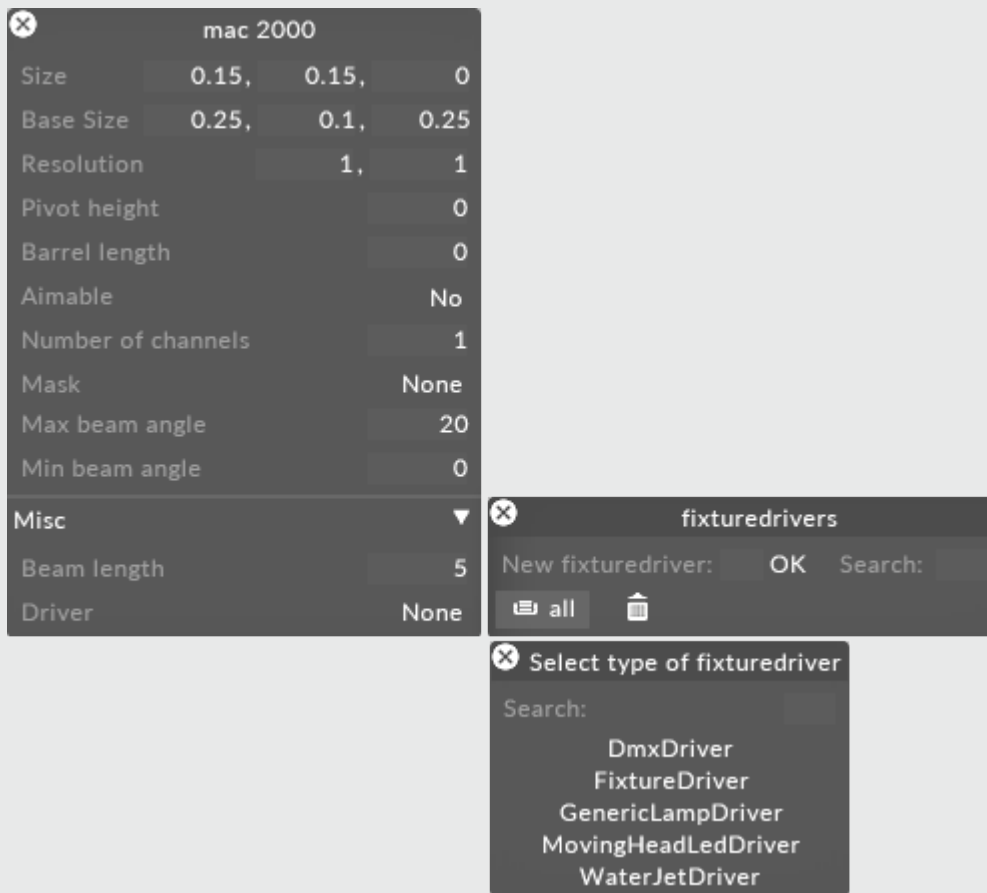

## DmxDriver

The DmxDriver is a fixture driver type that routes RGB pixel information to a regular rectangular grid of LED pixels.

# DmxDriver properties:

## Mode

This describes the pixel type of the LED fixture. There are two monochrome modes: *mono [weighted sum]* gives a more natural result for photographic/gradient images, whereas *mono [max signal]* ensures that peak brightness is maintained. Sending a redonly image with all levels at 255 will result in an output level of 255, whereas the weighted result will be less than 255.

The options are:

**rgb** : traditional threecomponent RGB LED , with eight bits per signal (red, green and blue).

**rgb + amber** : RGB + an extra amber component, all at eight bits per signal.

**rgb + white** : RGB + an extra white component, all at eight bits per signal.

**rgb + amber + white** : RGB + amber and white components, all at eight bits per signal.

**cmv** : cyan, magenta and yellow components.

**mono [weighted sum]** : monochrome (8 bits); the value sent is a weighted sum of red, green and blue.

**mono [max signal]** : monochrome (8 bits); the value sent is the maximum of red, green and blue.

## Horizontal

This property allows the data sent to the tile to be mirrored in the horizontal axis.

## Vertical

This property allows the data sent to the tile to be mirrored in the vertical axis.

## Rotation

This property allows image data being sent to be rotated by 90 degrees clockwise or 90 degrees counterclockwise . This only has an effect if the grid is a square grid.



## Amber Level, White Level

These properties allow you to directly control the amber and white signals sent to all pixels. They only have an effect if the mode property is set to RGB+amber or RGB+amber+white . In RGB+white mode, the signal sent to the white LED is computed from the RGB signals.

## GenericLampDrivers

To set up a GenericLampDriver object, you need to start with the DMX channel specification of the fixture, usually downloadable as a PDF from the manufacturer. You then read down the channel list, filling in channel numbers into the GenericLampDriver as you go.

Most properties specify either a DMX channel number (which is always taken as an index from the first channel in the fixture, 1 being the first valid channel). If a property is set to 0, no data is sent for that property. For instance, if a light is a CMY fixture (cyan, magenta, yellow), but the cyan channel is set to 0, then information will only be sent to the magenta and yellow channels.

The properties are divided into three major sections: **lamp** , which controls how information is sent to the lamp; **pan/tilt** , which controls how rotation commands are sent to moving head fixtures; and **commands** , which allows for setting default parameters.

## Mode

This specifies the colour mixing mode for the lamp. This is initialised to **cmv**.

Since GenericLampDrivers are only meant for singlelamp/pixel fixtures, the mirror/rotate properties from the DmxDrivers are unnecessary and are therefore removed. You can, however, change this to another value if you wish; this allows the GenericLampDriver to be used for singlepixel movinghead RGB LED fixtures.

## Lamp controls

This set of properties controls how information is sent to the lamp.

Lamp properties for a GenericLampDriver

**Dimmer channel** : standard CMY lights allow you to vary the output brightness using a dimmer. This is a mechanical shutter that blocks more or less light as you change the dimmer setting. This property

sets the channel number assigned to the dimmer; if set to 0 (as it should be for RGB LED fixtures), no information is sent.

**Dimmer flipMode** : some fixtures use the value '0 to signify dimmer closed (i.e. minimum light output); others use this value to signify dimmer open (i.e. maximum light output). This switch allows you to change the fixtures behaviour as appropriate.

**Min brightness** : dimmers, being mechanical, do not always produce a linear response. In particular, some dimmers appear to block all light until the value rises to a non0 value and then open up from there. If the fixtures dimmer exhibits this feature, set *min brightness* to the value at which output brightness reaches 0 as you dim the light. From then on, Disguise software will scale the output brightness appropriately to give you a clean, linear response.

**Cyan, magenta, yellow channels** : these properties apply to lights that use CMY colour generators. They are the channel numbers within the fixture of the cyan, magenta and yellow channels, respectively. These should be set to 0 for RGB fixtures.

**CMYKflipMode** : if it turns out that your lighting fixture views the world backwards, flip this switch and the CMYK values sent will be inverted, i.e. 0 will be most colour, 255 will be least colour.

**Red, green, blue channels** : these properties apply to lights for which the **mode** property (above) is set to **rgb** . They are the channel numbers of the red, green and blue components respectively. These should be set to 0 for CMY fixtures.

**Zoom channel** : if the light has the ability to zoom its beam (make it narrower and wider), enter the channel number of the zoom control here; otherwise, leave it at 0.

**Focus channel** : if the light has the ability to focus its spot so it appears hard edged at different distances, enter the channel number of the focus control here; otherwise, leave it at 0.

**Gobo channel** : if the light has the ability to change its gobo dynamically, enter the number of the gobo control channel here; otherwise, leave it at zero.

**Lamp on, lamp off** : these are DMX commands (see section ' DMX commands below) to switch the fixtures lamp on or off. Fixtures often require you to send a DMX value continuously for a number of seconds to fire the command. The DMX commands gives you the ability to do this.

**Open shutter, close shutter** : many fixtures have a shutter that has two states: open (all light passes through) or closed (no light passes through). Shutter response is usually much faster than dimmer

response, so Disguise software will use the shutter whenever a fast cuttoblack is required. The open/close shutter DMX commands (see next section) allow you to represent this.

## DMX commands

Many lamp or fixture commands require you to send a particular value on a particular channel for some number of seconds. For example, the Martin Mac2000 will switch off its lamp if you send the value 250 on channel 1 for 5 seconds.

**Please note:** it is possible to add DMX commands and animate their values using the [DmxControl layer](#).

To create a DMX command:

1. Open the DmxCommands manager by left-clicking the **lamp on** , **lamp off** , **open shutter** or **close shutter** properties.
2. Type in the name of your DMX command, in this example **frost** , in the **new dmxcommand** text field.
3. Hit **Enter** . A DmxCommand editor will open.

**Channel** : the channel number to send the command on. As with all other channel numbers, this is local to the fixture, with the lowest valid channel being 1. If channel is 0, no data will be sent. You can read the channel number directly from the fixtures DMX chart.

**Value** : this is the value to be sent on the channel in order to actuate the command. Permissible values are 0 to 255 inclusive. Some commands work with a range of numbers, eg. 248255. It is usually best to pick a value near the middle of the range, i.e. 250 in this case.

**Time** : this is the duration that the value should be sent to actuate the command, in seconds. Once the command is actuated, Disguise will continue to send the value on the channel for this number of seconds; a command cant be cancelled once it has been actuated. It is possible for this number to be set to 0. If this is the case, Disguise software will send the value once only.

**Min/max value** : allows the value to be scaled to any range. **min** specifies the lower value in the range, 'max specifies the upper number in the range.

## Pan/tilt controls

This set of properties specifies the pan/tilt behaviour of the fixture. If the fixture does not have a moving head base, just leave these values at 0.

**Pan/pan fine** : most moving head fixtures allow the control of angles via a 16bit number, split into two parts and sent on two separate channels. These two properties specify those channels. As with all other channels, the lowest permissible value is 1. You can read the values directly off the fixture DMX chart.

**Pan range** : this specifies the range of travel in the pan axis (rotation around the vertical axis), in degrees. The range can be found in the fixtures manual. If, for example, the manual states a range of 270 to +270, the pan range should be set to  $270*2 = 540$  (you can always use Disguises built in calculator rather than working it out yourself). You can also set this property to a negative number; this will cause the fixture to flip its rotation direction.

**Tilt/tilt fine** : this specifies the channel numbers for the tilt control and the fine tilt control respectively. As with pan and pan fine , you can read these directly from the manual.

**Tilt min/max** : while pan range is usually symmetrical around the central axis, the tilt range may differ from front (positive values of tilt) to back (negative values). Therefore, Disguise allows you to specify the minimum and maximum tilt values in degrees. It is permissible for tilt min to be higher than tilt max ; if this is the case, the tilt direction response is reversed.

## Commands

This set of properties allows for setting default parameters.

Commands properties for a GenericLampDriver

**Reset** : this is a DMX command that is issued to reset the fixture.

To reset all stage fixtures:

1. Open the Program Settings menu by right-clicking **d3** from the dashboard (bar at the top of the screen).
2. Select **reset all DMX fixtures** .

**Default** : this is an array of DMX commands that are sent every frame, regardless of what other data is being sent. This is because fixtures often have a number of extra controls that Disguise software does not drive directly, such as pan/tilt speed, gobo speed, strobing, secondary gobo or colour wheel controls, etc. If these are left unset, they can end up with values that interfere with normal operation. For this reason, it is advised that you create a DMX command for each extra fixture parameter, name it appropriately, set the default value to an appropriate value, and add it to the default array. This will ensure smooth operation of the fixture as a pixel.

## Testing

Testing property used to test a fixture driver with a real example of a fixture

**Tester** : the final property of the driver is **LampTester** . This is a helper designed to help you test the fixture driver with a real example of a fixture, without going to the trouble of addressing the complete grid of fixtures.

- Right-click **tester** to open the LampTester editor.

To use the **LampTester** property, plug a single fixture into Disguise software and then modify the properties contained in the LampTester editor. While the LampTester editor is open, all other DMX signals (from the grid of fixtures, or from other DmxScreens) are suppressed.

**Test channel** : this is the base channel number of the fixture (1 is the lowest valid number). Ensure that this number is the same channel number as you have assigned to the fixture.

**Test universe** : this is the universe number you have assigned to the fixture (1 is the lowest valid universe).

**Please note:** universe numbers refer to a physical DMX cable. They are not assigned on the fixture the way channel numbers are.

**Lamp** : this property allows you to test that you have the right lamp on/off commands. At the start, the state is set to **unknown** , as the tester has not sent any on/off commands and therefore does not know whether the lamp is on or off. When you set the property to **on** or **off** , the lamp on/off command is sent to the fixture. If you have the command filled in correctly, the lamp should turn on and off. If not, you need to check the command against the fixture manual.

**Shutter** : this property lets you test the shutter open/close command. Set the option switch to **open** or **closed** ; the lamp shutter should immediately respond.

**Test intensity** : this property lets you test the dimmer command. Change this number to a value between 0 (dark) and 255 (bright). The value you specify is sent directly to the dimmer, without mediation by the dimmer **min brightness** value (although the **dimmer flipMode** is taken into account).

**Test colour** : this property lets you send a test colour to the fixture. The colour you select is converted to RGB or CMY (depending on the fixture type), the **dimmer flipMode** mode is taken into account, and the data is sent to the fixture. If you have the channel numbers correct, the fixture should reproduce the colour you specify.

Colour Picker window is used to specify a test colour to the fixture, opened by left-clicking the Test Colour property

**Pan** : this property lets you directly send a pan angle to the fixture (in normal operation, pan and tilt are computer based on target points). 0 degrees should point the fixture towards the front of the fixture base, with negative values turning to the left and positive values to the right. The front of the fixture is defined (by convention) to be the side to the right of the small LED control panel. The procedure is to send an angle (eg. 90 degrees) and check that the fixture does indeed turn to that angle. If it does not, you may have to adjust either the pan channel numbers (if there is no movement) or the pan range.

**Tilt** : this property lets you directly send a tilt angle to the fixture. When pan is set to 0, positive tilt values should tilt the fixture lamp towards the front of the fixture; negative values should tilt it towards the back. Setting tilt to 0 should point the fixture directly upwards. If the fixture fails to move when you change the tilt value, you have incorrect tilt channel number settings; if the fixture angle does not match the angle you enter, you will need to edit the tilt min and max values in the driver.

## MovingHeadLedDrivers

The MovingHeadLedDriver controls fixtures consisting of a moving head base and a grid of LED pixels. It therefore combines the standard DmxDriver controls with the **pan/tilt** and **commands** properties from the GenericLampDriver. The only extra property of note is **first pixel channel** .

# MovingHeadLedDriver properties

## First pixel channel

This sets the channel (relative to the start of the fixtures channel; 1 is the lowest valid number) of the first pixel in the array.

First Pixel Channel property sets the channel of the first pixel in the array.

# Setting up a grid of fixtures

To set up a fixture please see the previous sub-chapter [Creating a fixture](#).

Now that you have set up the fixture, you can begin playing with it in the Stage Visualiser. Initially, the DmxLights screen holds only one fixture; if you send content to the Dmx Lights (for example, by targeting a Colour layer), you will see a single beam of colour coming from the centre of the screen surface (assuming you have set a nonzero beam length).

You can now increase the number of fixtures by editing the properties contained in the **fixture** section of the DmxLights screen editor.

## DmxLights properties

**Please note:** this sub-chapter explains the DmxLights properties relevant to setting up a grid of fixtures. For an explanation of the other DmxLight properties not mentioned in this sub-chapter please see the earlier topic [DmxLights](#).

### Number Across, Number Down

This controls the number of fixtures in the grid attached to the screen surface.

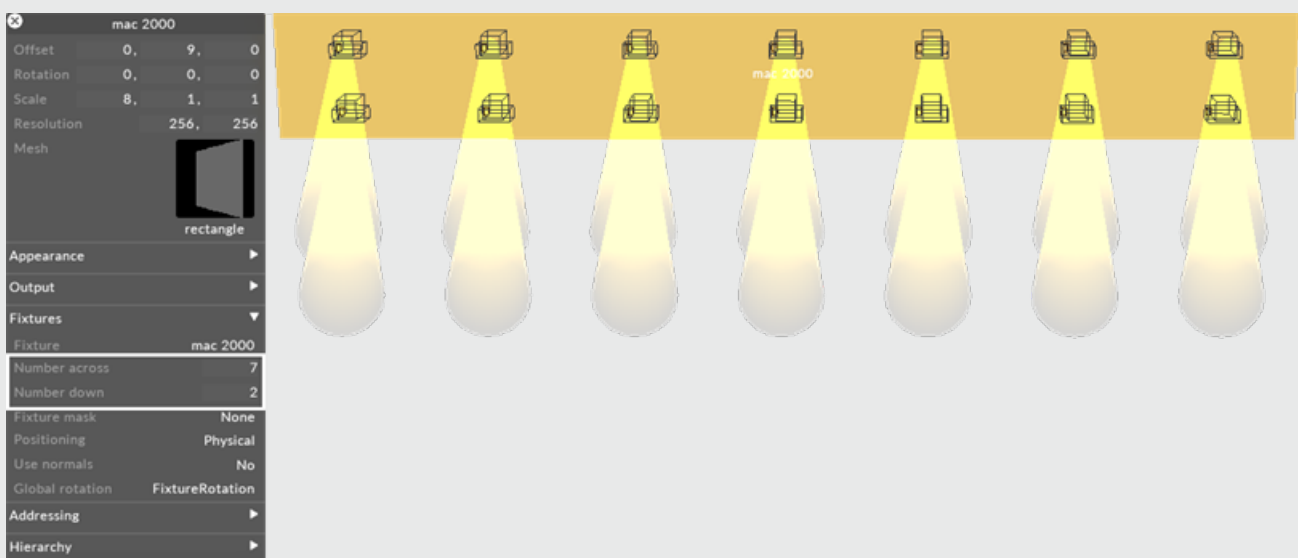



Number Across and Number Down properties control the number of fixtures in the grid attached to a screens surface

As you increase these values, you should see the number of fixture beams increase (assuming there is content going to the screen). **Number Across** increases the number of fixture beams horizontally, and **Number Down** increases the number of fixture beams vertically.

## Fixture Mask

This controls the mask used when rendering the fixture.



Fixture Mask property is used to select a still image file that defines the mask used when rendering the fixture

Please scroll down to the explanation of the **mask** property in the previous sub-chapter [Creating a fixture](#) for information on how to use the **fixtureMask** property.

## Positioning

This controls how the positions of the individual fixtures are generated.

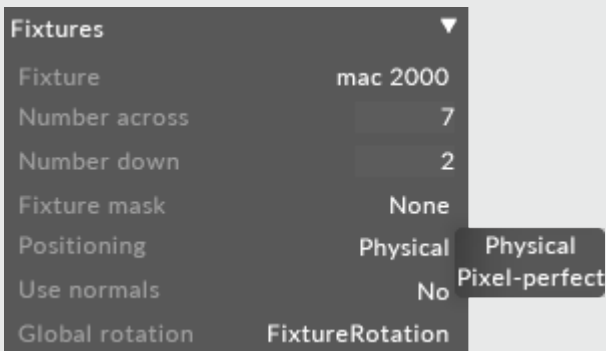

Positioning property controls how the positions of the individual fixtures are generated

There are two options: **physical** spaces the fixtures out at equal physical separations and samples the underlying content accordingly, **pixelperfect** spaces the fixtures out so that they sample the underlying content at regular intervals and positions them at the appropriate physical locations.

## Use normals

This controls how the orientation of each fixture instance depends on the screens surface.



Use Normals property controls how the orientation of each fixture instance depends on the screens surface, in this example the fixtures are inverted

There are three options. If set to **no** , then the orientation of each fixture does not depend on the screen surface. If set to **yes** , each fixture is oriented so that it is parallel to the screen surface. If set to **inverted**, a negative version of the surface normal is used, flipping the fixture upside down relative to the surface.

## Global rotation

This allows you to rotate the fixtures relative to their standard orientation.

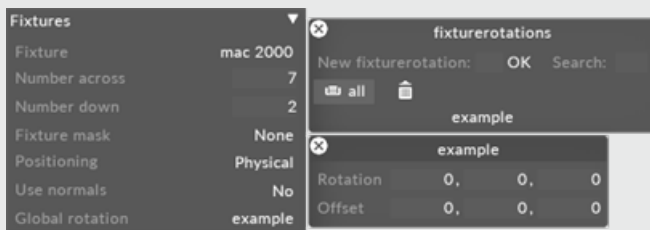

Global Rotation property being used to, in this example, rotate the fixtures by minus 20 degrees in the x direction

- Rightclick **global rotation** to open a local (untitled) FixtureRotation editor. **rotation** controls the rotation of the fixtures, in degrees. The x component controls the rotation around the x axis; the y component around the y axis; and the z component around the z axis. **offset** controls the screen position in the 3D space, in metres. There are three numbers laid out horizontally: respectively the x (left/right), y (up/down) and z (into/out of the screen) coordinates.

**Please note:** you will not see the effect of this rotation until you visualise the fixture bases. For more information please see the [DMX addressing](#) sub-chapter.

Once you see the fixture beams it is possible to just visualise the lights.

— Switch off the underlying screen content and just visualise the lights by setting the **alpha** property to 0. This property is contained in the **appearance** section of the DmxLights editor.

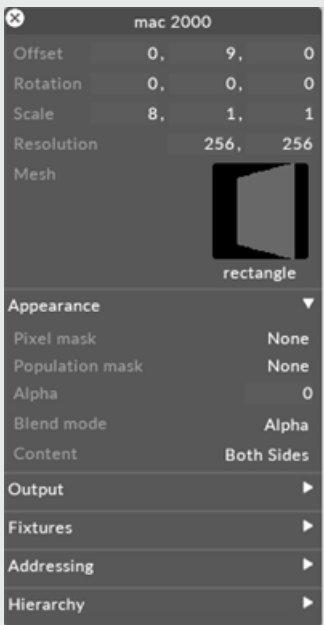

Alpha property set to 0 to switch off the underlying screen content

# DMX addressing

Addressing is the process of assigning a unique DMX channel and universe number to each fixture in the DmxLights screen. There are two ways this can work: either you specify the addressing layout in Disguise software and print out a screenshot for the technicians to work to, or you receive an addressing layout chart and have to match it within Disguise software.

Addressing is handled under the **addressing** tab of the DmxLights editor.

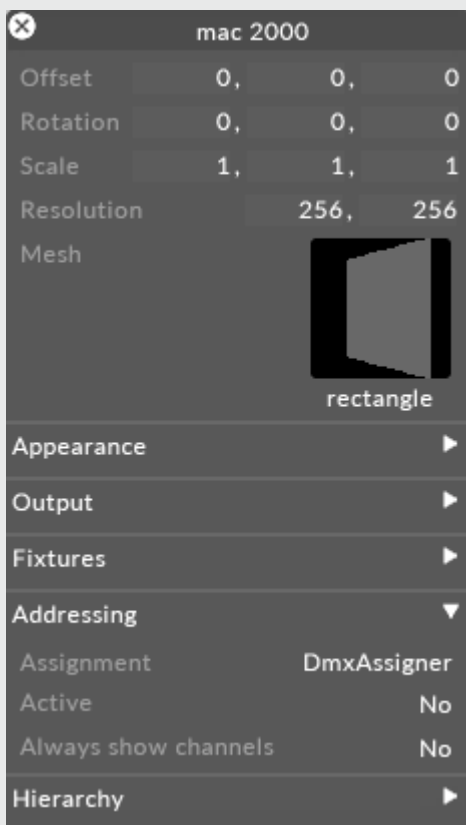

Addressing properties of the DmxLights editor control how DMX channels and universe numbers are assigned to each fixture.

## Addressing properties

### Assignment

The **DmxAssigner** specifies a set of addressing strings. These strings are used to assign addresses to the fixtures.

— To open the **DmxAssigner** right-click **assignment**.



DmxAssigner is used to control how addresses are assigned to fixtures, opened by right-clicking Assignment from the DmxLights editor.

The **DmxAssigner** contains an array of **DmxStrings**. Each DmxString specifies a string of fixtures that have contiguous channel numbers.

## Active

This indicates whether the DmxLights screen is actually outputting DMX . By default, this is set to **off** ; you should only switch it to **on** once the addressing is checked and complete.

## Show channels

This controls whether the fixture bases and channel numbers are displayed in the visualiser.

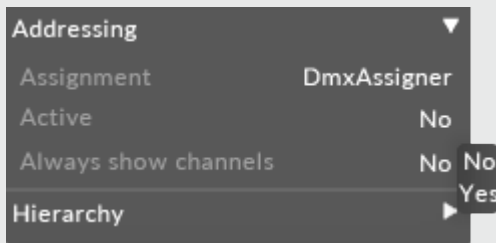

Show Channels property controls whether channel numbers and fixture bases are displayed for each fixture in the Stage Visualiser

Switching **show channels** to **yes** will display each fixture in the visualiser.

## DmxAssigner

When wiring DMX fixtures, the usual practice is to arrange fixtures in strings, i.e. a series of fixtures wired in daisychain fashion, with channel numbers that step up in a certain way. A DmxLights screen may contain multiple strings. Each of these strings is specified using a DmxString.

To add a DmxString to the DmxAssigner:

1. Right-click **+** to open the Dmxstrings manager.
2. Type the string name into the **new dmxstring** text field, in this example Mac2000 String 1 (be sure to include the name of the DmxLights screen in the name).

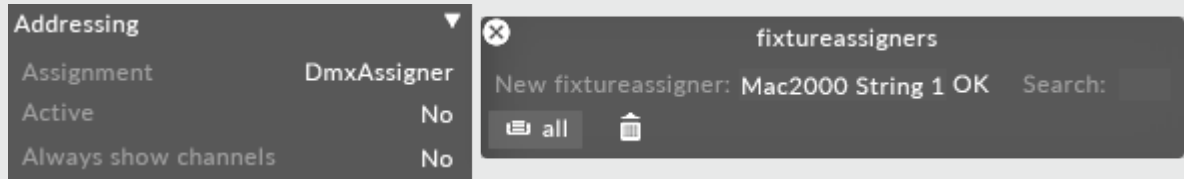

Process used to create a new DMX string, in this example Mygroup\_str1

3. Hit **Enter**. This creates the new DmxString, adds it to the DmxAssigner, and opens the DmxString editor.

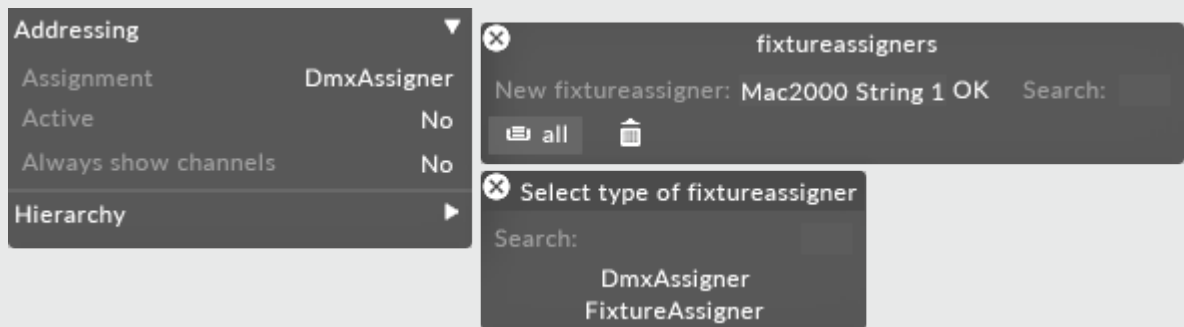

DmxString editor

4. Type in the properties you want and hit **assign!** . The DmxString will then assign the channel numbers, and the visualiser will display the channel numbers.

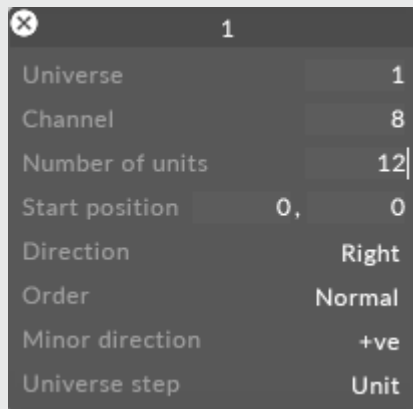

Assigning the channel numbers to the fixtures by left-clicking Assign!

## DmxString properties

The DmxString starts at a particular fixture position in the grid and then steps across the grid, assigning channel numbers as it goes. The properties of the DmxString editor control which channels are assigned and the step direction.

## Universe

This specifies the universe number that should be assigned to the first object in the string. The lowest valid number is 1.

## Channel

This specifies the channel number within the universe that should be assigned to the first object in the string. Valid numbers are 1 to 512 inclusive.

## Number of Units

This specifies the number of fixtures you want in your string. In the example above, our DmxLights screen has a 2 by 4 grid of fixtures, so the number of units is set to  $2 \times 4 = 8$ .

## Start position

This specifies the index within the DmxLights screen of the first fixture in the string. The topleft fixture is designated (0,0), the fixture to its right is (1,0) and the fixture below it is (0,1). In general, you can find fixture (i, j) by starting at the top left fixture and counting (i) to the right and (j) down. In this example, we set start pos to (0,0) to indicate the top left fixture.

## Direction

Starting at the first fixture, the DmxString will assign a channel, then step in a certain direction across the surface of the DmxLights screen before assigning the next channel number. There are four possibilities: left , right , up or down . In this example, the channel number are stepping to the right.

## Order

This specifies the stepping order across the grid as a whole. You can select one of two options. Choosing normal means that when it reaches the edge of the grid, it moves up or down one row/column and starts again at the opposite edge. Selecting alternating means that when it reaches the edge of the grid, it moves up or down one row/column and then starts stepping in the other direction.

## Minor Direction

This controls the direction of the step that takes place when the assigner gets to the edge of the grid. There are two options : ve (steps left or up) or +ve (steps right or down).

## Universe step

Since fixtures cannot straddle a universe boundary, the assignment algorithm will step up a universe if it finds that there are not enough channels left in the current universe. However, it is sometimes more useful if each row or column within the grid is constrained to be contained within one universe. If this is the case, set universe step to row/column instead of unit.

# Targeting fixtures

The Target2 layer and Target layer are used to change the orientation of moving head fixtures. The advantage of the Target2 layer is that it can edit multiple fixture targets, whereas the Target layer can only edit a single fixture target.

## How to target the fixtures

1. Create a Target2 or Target layer depending on the number of fixture targets you wish to edit.
2. Left-click **mapping**.
3. Assign the layer to either a Direct mapping type with the lights you want to control; or a Feed mapping type that allows you to control the lights of more than one screen simultaneously, or control a subset of lights within a single DmxLights screen. In this example we have assigned a Direct mapping type to the **mac2000** fixtures. You will then see a set of target points (small white crosshairs), one per fixture.



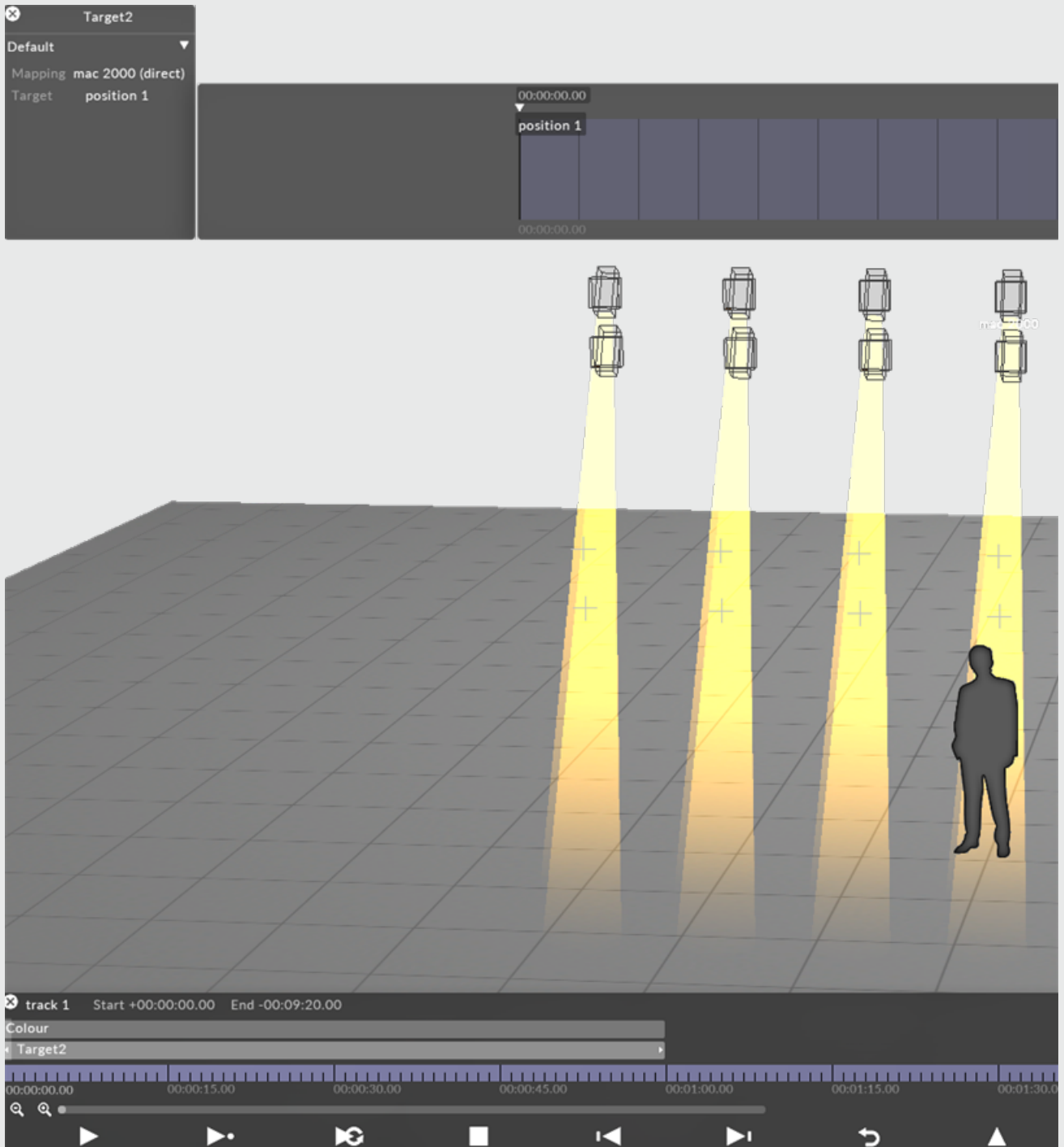

Target points used to change the orientation of moving head fixtures, created by mapping the Target 2layer to the fixtures

**Please note:** to visualise the fixtures following the fixture targets, you must have the Aimable property set to Yes. For more information please see the sub-chapter [Creating a fixture](#).

— To animate the fixtures by editing multiple fixture targets please see the section Targeting/animating fixtures in the [Target2 layer](#) topic. To edit a single fixture target use the [Target layer](#).

# Creating DMX screens

Working with DmxScreens is the easiest way to get DMX output with Disguise software. They behave like regular screens, but each pixel's colour and/or brightness information is sent out directly via DMX . The Disguise software has no understanding of what kind of fixture is accepting this DMX stream; it sees them only as pixels.

DmxScreens are suitable for LED fixtures that accept RGB or luminance only signals and have no extra control channels.

DmxScreens are not suitable for fixtures that have complex personalities including on/off commands, moving heads, CMY colour mixing lamps, etc. For these kinds of fixtures you should create a DmxLights, which allows more complex fixtures to be modeled. For more information please see the following sub-chapter [DmxLights](#).

## Creating a DmxScreen

The DmxScreen is added in the same way as any other screen type. Please see the sub-chapter [Creating/removing screens](#) for step-by-step instructions on how to add a screen to a stage, and select **DmxScreen** from the menu of different screen types.

## DmxScreen properties

The DmxScreen properties are similar to the Screen properties, but with an extra tab called **addressing** which controls the way each pixels channel number is assigned. Therefore all of the DmxScreen properties not related to addressing can be read in the sub-chapter [Editing screens](#).

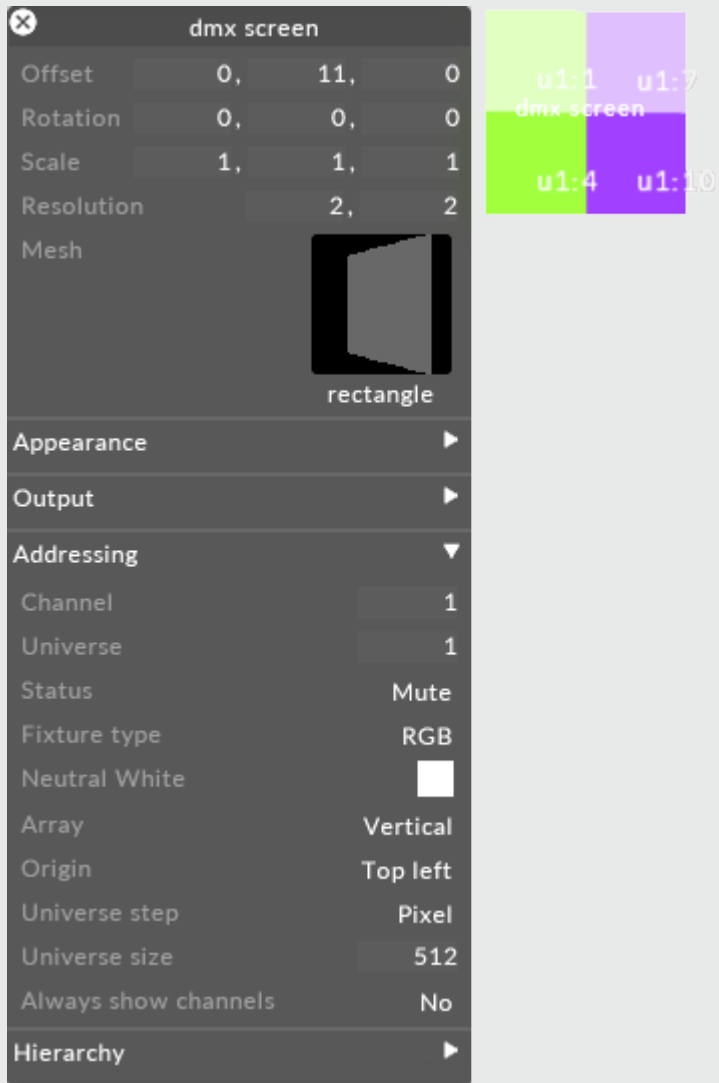

DmxScreen has the same properties as a Screen but with an extra tab called Addressing (explained below)

## Channel

The start channel number of the first pixel to be assigned. You can fill in numbers ranging from 1 to 512.

## Universe

The start universe number of the first pixel to be assigned. Valid universe numbers start from 1.

## Status

This is either **mute** (not sending DMX) or **active** (sending DMX). Because it may be dangerous to send DMX for an incorrectly addressed screen, the default status is **mute**. When the screen is addressed correctly, set this to **active**.

## Fixture type

This specifies the fixture type. Options are **rgb**, **monochrome** (which computes a weighted sum from red, green and blue), **monochrome max** (which computes a single luminance from the maximum of red, green and blue) or **rgbw**.

## Neutral white

This enables the user to color correct the pixels using a palette or precise RGB value.

## Array

Starting from the origin (see below), the assignment algorithm steps horizontally or vertically, increasing the channel number as it goes. This property controls whether the step is **horizontal** or **vertical**.

## Origin

This controls the starting point for channel assignment. If set to **top left**, the top left pixel is the first to have its channel assigned; if set to **top right**, the top right pixel is the first to be assigned; and so on.

## Universe step

For large screens, the total number of channels in the screen may exceed 512, the maximum number of channels in a universe. When this happens, the channel assignment algorithm will jump up a universe and resume assignment. If this universe step happens within a row or column, this may prove inconvenient for physical wiring as two cables will have to be run to the row or column. For this reason, Disguise allows a **row/column** option which ensures that the universe number will not step halfway through a row or column.

## Universe size

By default, a universe is assumed to be 512 pixels. If you want, you can set the size to something smaller. This allows a portion of the universe to be used for other fixtures or control channels, if required.

## Always show channels

When set to **yes**, Disguise superimposes the universe and channel number for each pixel over the pixel in the Stage Visualiser. Left-clicking a channel number allows you to edit it using the mouse wheel. Note that changing the colour, array, origin or universe step properties will reassign the channel numbers.

**Please note:** showing channels of very large arrays (eg. with 256x256 pixels) will kill the visualiser. For this reason, it helps to make sure you set the screen resolution correctly before you turn on **show channels** .

# Creating DMX screens

Working with DmxScreens is the easiest way to get DMX output with Disguise software. They behave like regular screens, but each pixel's colour and/or brightness information is sent out directly via DMX . The Disguise software has no understanding of what kind of fixture is accepting this DMX stream; it sees them only as pixels.

DmxScreens are suitable for LED fixtures that accept RGB or luminance only signals and have no extra control channels.

DmxScreens are not suitable for fixtures that have complex personalities including on/off commands, moving heads, CMY colour mixing lamps, etc. For these kinds of fixtures you should create a DmxLights, which allows more complex fixtures to be modeled. For more information please see the following sub-chapter [DmxLights](#).

## Creating a DmxScreen

The DmxScreen is added in the same way as any other screen type. Please see the sub-chapter [Creating/removing screens](#) for step-by-step instructions on how to add a screen to a stage, and select **DmxScreen** from the menu of different screen types.

## DmxScreen properties

The DmxScreen properties are similar to the Screen properties, but with an extra tab called **addressing** which controls the way each pixels channel number is assigned. Therefore all of the DmxScreen properties not related to addressing can be read in the sub-chapter [Editing screens](#).

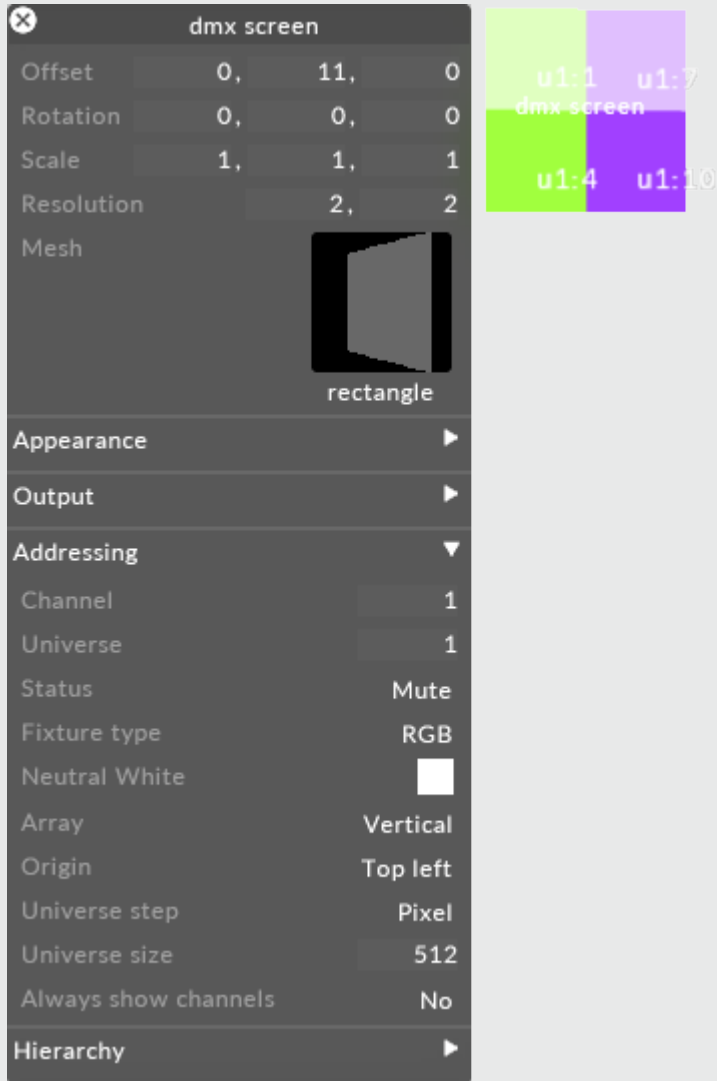

DmxScreen has the same properties as a Screen but with an extra tab called Addressing (explained below)

## Channel

The start channel number of the first pixel to be assigned. You can fill in numbers ranging from 1 to 512.

## Universe

The start universe number of the first pixel to be assigned. Valid universe numbers start from 1.



## Status

This is either **mute** (not sending DMX ) or **active** (sending DMX ). Because it may be dangerous to send DMX for an incorrectly addressed screen, the default status is **mute** . When the screen is addressed correctly, set this to **active** .

## Fixture type

This specifies the fixture type. Options are **rgb** , **monochrome** (which computes a weighted sum from red, green and blue), **monochrome max** (which computes a single luminance from the maximum of red, green and blue) or **rgbw**.

## Neutral white

This enables the user to color correct the pixels using a paletter or precise RGB value.

## Array

Starting from the origin (see below), the assignment algorithm steps horizontally or vertically, increasing the channel number as it goes. This property controls whether the step is **horizontal** or **vertical** .

## Origin

This controls the starting point for channel assignment. If set to **top left** , the top left pixel is the first to have its channel assigned; if set to **top right** , the top right pixel is the first to be assigned; and so on.

## Universe step

For large screens, the total number of channels in the screen may exceed 512, the maximum number of channels in a universe. When this happens, the channel assignment algorithm will jump up a universe and resume assignment. If this universe step happens within a row or column, this may prove inconvenient for physical wiring as two cables will have to be run to the row or column. For this reason, Disguise allows a **row/column** option which ensures that the universe number will not step halfway through a row or column.

## Universe size

By default, a universe is assumed to be 512 pixels. If you want, you can set the size to something smaller. This allows a portion of the universe to be used for other fixtures or control channels, if

required.

## Always show channels

When set to **yes**, Disguise superimposes the universe and channel number for each pixel over the pixel in the Stage Visualiser. Left-clicking a channel number allows you to edit it using the mouse wheel. Note that changing the colour, array, origin or universe step properties will reassign the channel numbers.

**Please note:** showing channels of very large arrays (eg. with 256x256 pixels) will kill the visualiser. For this reason, it helps to make sure you set the screen resolution correctly before you turn on **show channels** .

# Editing local channels

If you want to edit DMX channels locally do the following:

1. Hold down Alt and left-click a channel.
2. If you want to change the universe, change the **universe** property.
3. Change the start channel in the **channel** property.
4. In the **number of fixtures** property choose number of fixtures, i.e. pixels you want to change the channel of.
5. Depending on the orientation of the UV map change the direction to **right, left, up, down**.
6. Click **assign**.



Interface showing how edit local DMX channels

# DMX table screens

## Overview

A DMX table screen is a DMXscreen whose DMX patch is defined by a csv file. The behavior of the screen is much like the DMXscreen except that the patch is automated by the csv file allowing for more fluid patch mechanisms for non-linear patching.

Tables should be placed in a newly created **Table folder**, inside the **Objects folder** of the project file.

## CSV format

The first line is the four column headers (pos x, pos y, universe, channel) and is ignored. These properties are explained as follows.

### x position

x coordinate of the pixel, zero-based, relative to the resolution of the mesh as defined in Disguise software. 0 is left.

### y position

y coordinate of the pixel, zero-based, relative to the resolution of the mesh as defined in Disguise software. 0 is top.

### universe

DMX universe number offset, 1-based, relative to the start universe of the screen as defined in Disguise software.

## channel

DMX start channel number offset of the pixel, 1-based, relative to the start address of the screen as defined in Disguise software.

## Workflow

1. Create your DMX patch using a CSV or spreadsheet editor.
2. Create your DMXscreen in Disguise software as normal remembering to set the resolution correctly.
3. Use the **Table** property of the screen to point to the CSV file that defines the channel assignments.

## Example

### Creating a table in excel

1. Define the column order in Excel.

x	y	universe	channel
1	1	1	1
1	2	1	4
1	3	1	7
1	4	1	10
1	5	1	13
1	6	1	16
1	7	1	19
1	8	1	22
1	9	1	25
1	10	1	28
1	11	1	31
1	12	1	34
1	13	1	37

The X is the x axis in the UV Space and Y is the y axis in the UV Space when looking at UVs of a 3d Model.

2. So if the resolution of the Screen is 10x10 for example then the co-ordinates of the UV space would look like the image below .

	0	1	2	3	4	5	6	7	8	9
0										
1										
2										
3										
4										
5										
6										
7										
8										
9										

3. If the Fixture is a 3 channel fixture, then the address would be as follows compared to the table screen.

						0	1	2	3	4	5	6	7	8	9
x	y	universe	channel		0	1.1	1.31	1.61	1.81	1.111	1.141	1.171	1.201	1.231	1.261
	0	0	1	1	1	1.4	1.34	1.64	1.94	1.114	1.144	1.174	1.204	1.234	1.264
	0	1	1	4	2	1.7	1.37	1.67	1.97	1.117	1.147	1.177	1.207	1.237	1.267
	0	2	1	7	3	1.10	1.40	1.70	1.100	1.120	1.150	1.180	1.210	1.240	1.270
	0	3	1	10	4	1.13	1.43	1.73	1.103	1.123	1.153	1.183	1.213	1.243	1.273
	0	4	1	13	5	1.16	1.46	1.76	1.106	1.126	1.156	1.186	1.216	1.246	1.276
	0	5	1	16	6	1.19	1.49	1.79	1.109	1.129	1.159	1.189	1.219	1.249	1.279
	0	6	1	19	7	1.22	1.52	1.82	1.102	1.132	1.162	1.192	1.222	1.252	1.282
	0	7	1	22	8	1.25	1.55	1.85	1.105	1.135	1.165	1.195	1.225	1.255	1.285
	0	8	1	25	9	1.28	1.58	1.88	1.108	1.138	1.168	1.198	1.228	1.258	1.288
	0	9	1	28											
	1	0	1	31											
	1	1	1	34											
	1	2	1	37											
	1	3	1	40											
	1	4	1	43											
	1	5	1	46											

4. Now export the x, y, universe, channel information as a .csv file.

## Excel table creation tip

The following method expects the LEDs to be addressed column by column, left-to-right. If you require a different addressing order, the x and y equations can be swapped.

### x column

Use the equation  $=\text{TRUNC}((\text{ROW}()-1)/y)$ , repeat this down the sheet to  $x*y$  number of rows, this will make each number from 0 to x repeat y-number of times.



## y column

Use the equation  $=\text{TRUNC}(\text{ROW}()-1)-(y*(\text{TRUNC}((\text{ROW}()-1)/y)))$ , repeat this down the sheet to  $x*y$  number of rows. This will make the numbers from 0 to  $y$  repeat with each number from 0 to  $x$ , covering every permutation of these two ranges.

## Universe column

Find the maximum number of LEDs you can fit in one universe ( $n$ ). For RGB or any other three-channel LED's this number is 170. Use the equation  $=\text{TRUNC}(((\text{ROW}()+n-1)/n))$ , repeat for  $x*y$  rows.

## Channel column

Put a 1 in the first row, then  $=\text{MOD}(D1+i, 510)$  (where  $i$  is the number of channels required by a single LED) in the next row down, copy down letting the  $D$  co-ordinate increment. 510 is obtained by adding 1 to the highest addressable number (509 in the case of RGB LED's), repeat for  $x*y$  rows.

Once this is complete, export as csv, open in a text editor, create a new line at the top of the list and type "x,y,universe,channel". Save the csv and use it in Disguise software.

## Placing the CSV file

1. Copy the exported CSV file from excel.
2. Create a new folder inside the objects folder of your project file, name this folder **Table**.

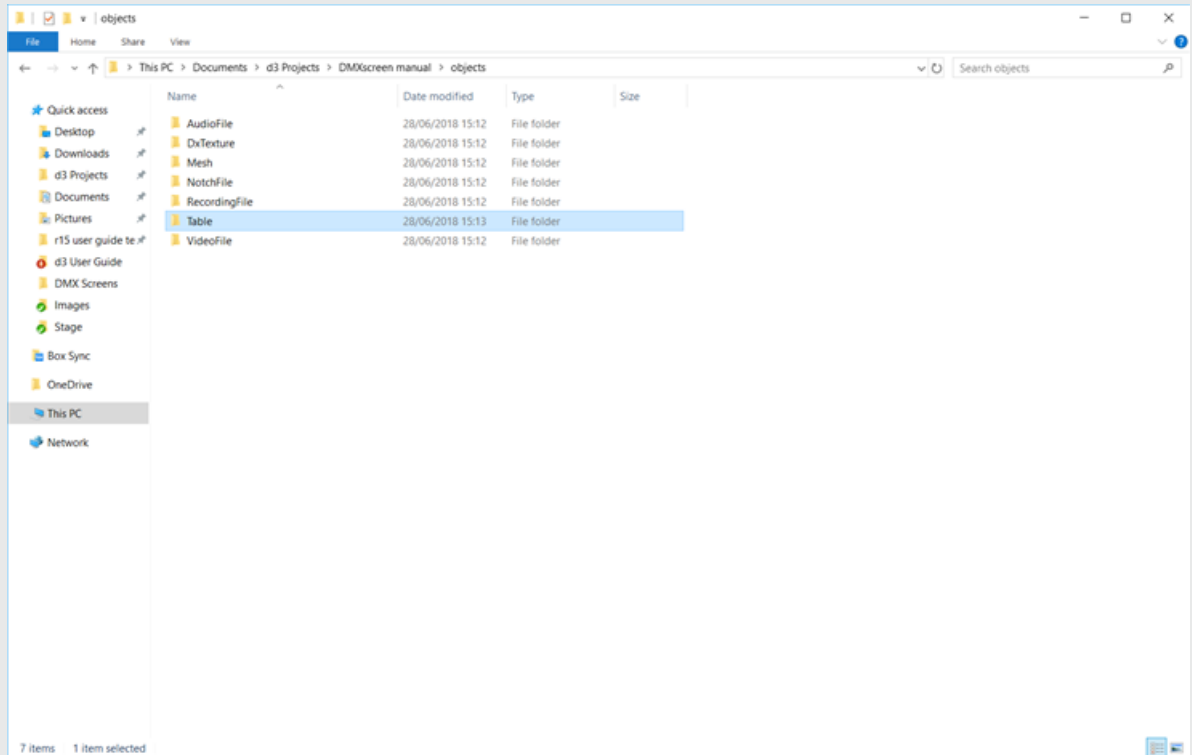

3. Paste the CSV file into this newly created table folder.

## Creating the DMXtablescreen

1. Open the stage editor by right clicking **Stage** from the dashboard or by right clicking the **floor** in the visualiser.
2. Expand the **DMXscreens** tab.

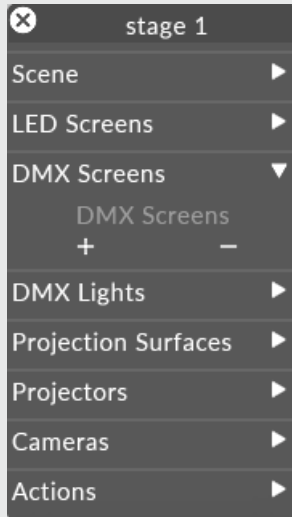

3. Click the + icon to open the DMXscreens manager.
4. Define a name for your screen and left click **OK**.

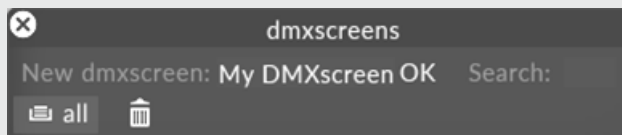

5. Position your screen in the stage as normal.
6. Define the **Table property** as the CSV file you placed in the Table folder earlier.

Addressing ▼	
Channel	1
Universe	1
Status	Mute
Fixture type	RGB
Neutral White	<input type="checkbox"/>
Table	None
Array	Vertical
Origin	Top left
Universe step	Pixel
Universe size	512
Always show channels	No

✕
tables

Search:

all

None

dmxtable\_100x2

# Projector Simulation overview

In Disguise software, content is created and as a texture applied to the projection surface - the car in the example here. Content can be made without any knowledge of the actual number of projectors that will be used - whether there is one projector or twenty, the content will stay the same.

In Disguise software, you begin by creating Projector objects and add them to the scene; you set up their position, rotation and lens qualities to precisely match those of the real projectors. The software then renders the projection surface (and its content) from the point of view of each virtual projector, and outputs the resulting image to the real projector. If the projection surface and virtual projectors precisely match their counterparts in the real world, the result is a perfect image.

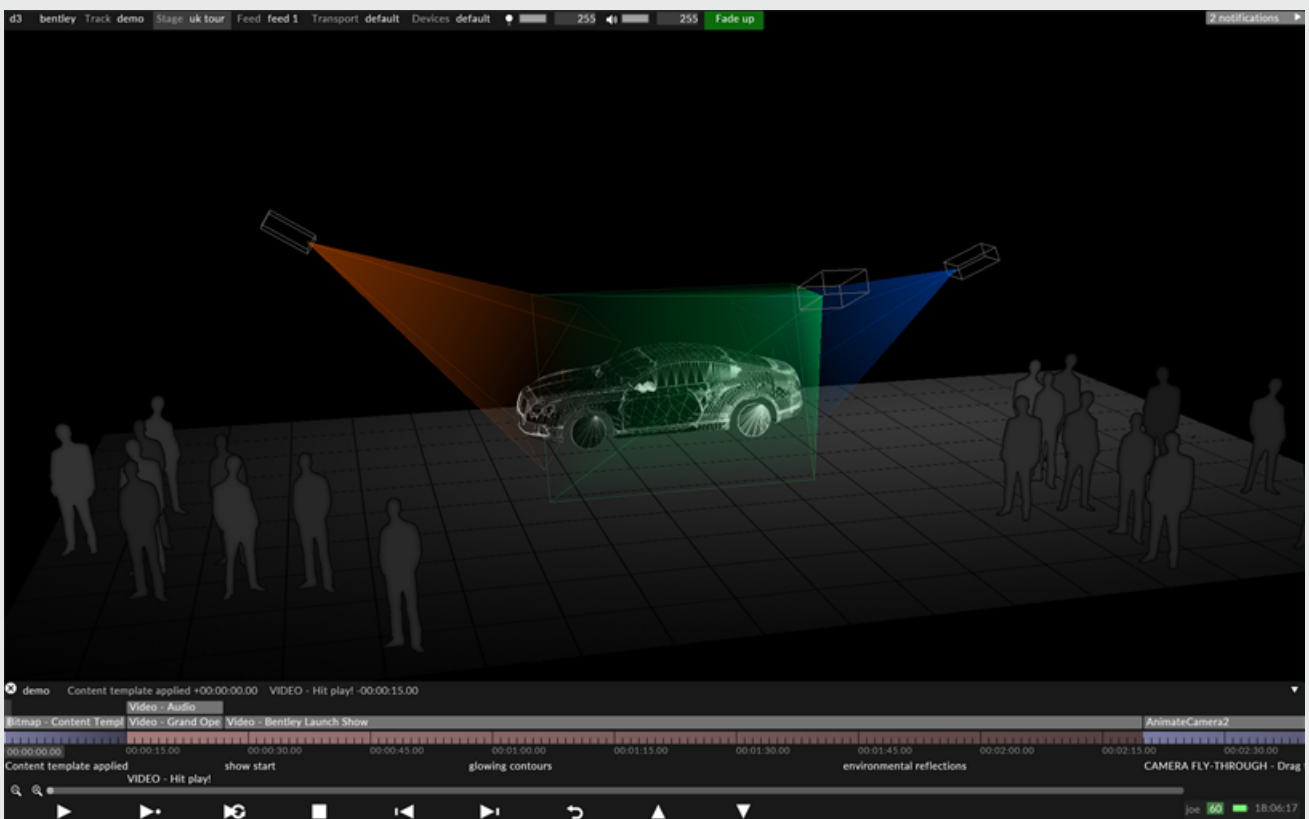

The Disguise software used to visualise, simulate and calculate how physical projectors should be positioned for the [Bentley Continental GT UK Tour](#)

If the physical projector has to move a couple of meters to the side, there is no need to re-render any content, just move the corresponding virtual projector to match. It will then render a new image from the

new point of view. Similarly, if new projectors are added, there's no need to re-render content; just add a new projector to the scene and set it up.

There are two ways of matching a virtual projector to its physical counterpart: [Manual calibration](#), or the calibration process referred to as [QuickCal](#). For situations where your 3D model does not precisely match the real projection surface, Disguise provides a selection of warping tools.

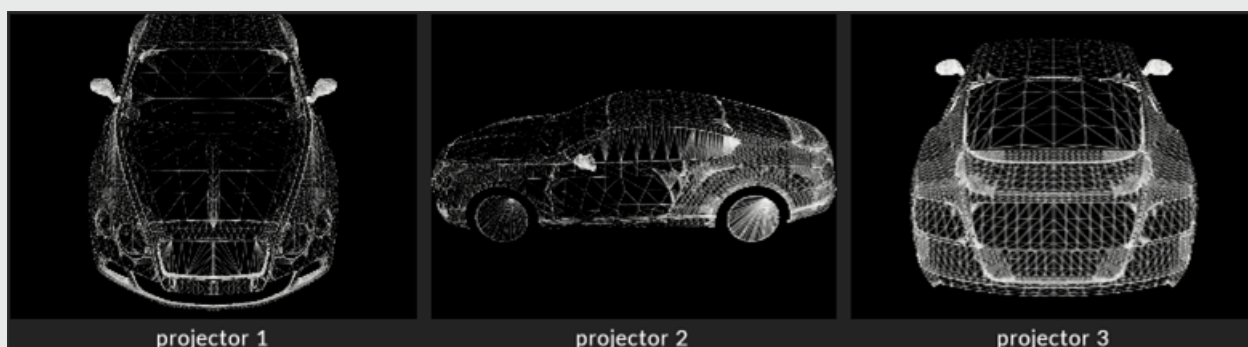

Outputs that the three virtual projectors from the above image see in the [Output Feeds level](#)

## Projector Simulation as a decision-making tool

Projector simulation does not only have to be used for output purposes. During the early production stages, Projector Simulation can be used to explore projector positions, aiming points, appropriate lens sizes etc; it is a tool for specifying the correct hardware for a show.

## 3D models preparation

As always when working in Disguise software, you need to model an exact virtual replica of the real-world screens. If only standard rectangular screens are being used, these can be created directly in Disguise software. However, for more complex three-dimensional objects, it is required that the screen is built and exported from a 3D software such as 3ds Max, Maya, Cinema4D or similar. It is crucial to not only model and export the 3D models, but to also properly texture-map (UV-map) them and to carefully optimize the polygon count of the model.

The more accurate the 3D model the better. The level of accuracy usually depends on the distance between the audience and the object. For building projections, it is recommended to laser scan the building. A laser scan can generate a highly accurate 3D mesh (+5mm accuracy) that you can import into a 3D software application from which the optimization, UV-mapping and content template creation process can take place. The mesh is then exported as a texture mapped **.obj** file into Disguise.

For smaller objects, where the audience stands much closer to the object and the pixel density is higher (for example for car projections), it is even more important that the 3D mesh is as accurate as possible. However, as this usually is not the case, Disguise has a number of 2D-based warping tools allowing you to compensate for the inaccuracies between the virtual and the real-world model. Please see the sub-chapter [Warping outputs](#) for more information.

# Content creation

Based on 3D models, animators can create content either in 2D or in 3D, or both. For simple setups, a 2D content template generated from the UV-coordinates of the 3D model can be used as a background image in for example After Effects.

Video files are rendered and imported. In the software, the content is then applied back onto the same 3D models, allowing the content to be pre-visualised in 3D and in real-time, from any point of view. As the output to the physical projectors is handled by the virtual projectors, the animators only need to think about how to create content that looks good on the screen in Disguise software.

## How do I learn about preparing a projection-based 3D model for Disguise?

The 3D modelling and UV-mapping processes are currently not covered in detail in this User Guide. To learn more about these processes, register for the Pre-Production Workflows course offered online in our free e-learning system at <https://training.disguise.one>.

# Projector Simulation overview

In Disguise software, content is created and as a texture applied to the projection surface - the car in the example here. Content can be made without any knowledge of the actual number of projectors that will be used - whether there is one projector or twenty, the content will stay the same.

In Disguise software, you begin by creating Projector objects and add them to the scene; you set up their position, rotation and lens qualities to precisely match those of the real projectors. The software then renders the projection surface (and its content) from the point of view of each virtual projector, and outputs the resulting image to the real projector. If the projection surface and virtual projectors precisely match their counterparts in the real world, the result is a perfect image.

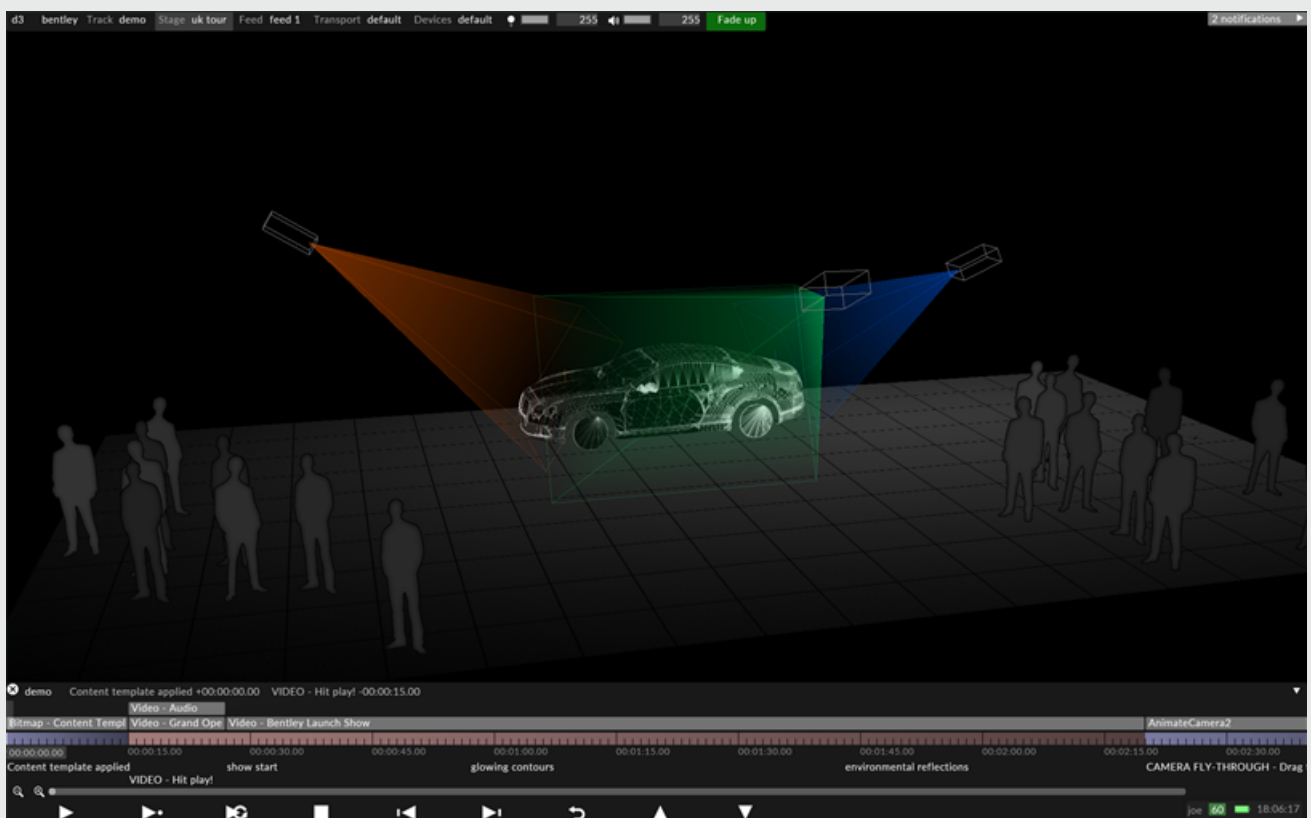

The Disguise software used to visualise, simulate and calculate how physical projectors should be positioned for the [Bentley Continental GT UK Tour](#)

If the physical projector has to move a couple of meters to the side, there is no need to re-render any content, just move the corresponding virtual projector to match. It will then render a new image from the



new point of view. Similarly, if new projectors are added, there's no need to re-render content; just add a new projector to the scene and set it up.

There are two ways of matching a virtual projector to its physical counterpart: [Manual calibration](#), or the calibration process referred to as [QuickCal](#). For situations where your 3D model does not precisely match the real projection surface, Disguise provides a selection of warping tools.

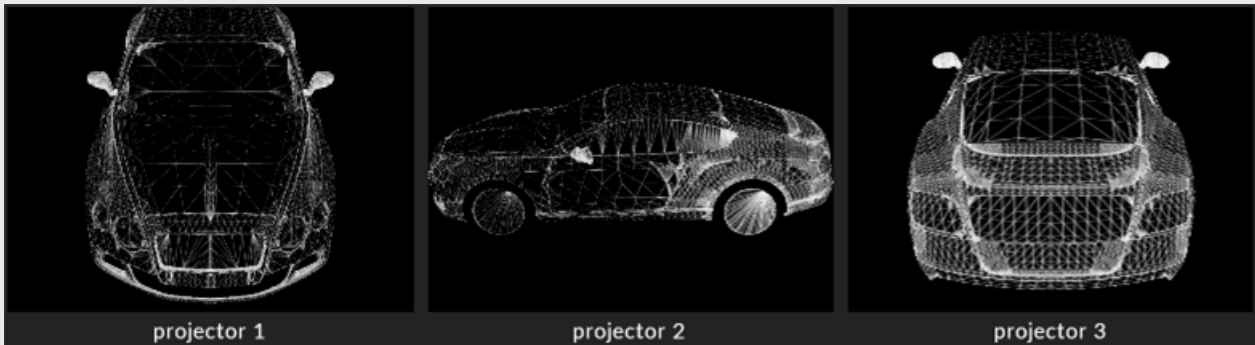

Outputs that the three virtual projectors from the above image see in the [Output Feeds level](#)

## Projector Simulation as a decision-making tool

Projector simulation does not only have to be used for output purposes. During the early production stages, Projector Simulation can be used to explore projector positions, aiming points, appropriate lens sizes etc; it is a tool for specifying the correct hardware for a show.

### 3D models preparation

As always when working in Disguise software, you need to model an exact virtual replica of the real-world screens. If only standard rectangular screens are being used, these can be created directly in Disguise software. However, for more complex three-dimensional objects, it is required that the screen is built and exported from a 3D software such as 3ds Max, Maya, Cinema4D or similar. It is crucial to not only model and export the 3D models, but to also properly texture-map (UV-map) them and to carefully optimize the polygon count of the model.

The more accurate the 3D model the better. The level of accuracy usually depends on the distance between the audience and the object. For building projections, it is recommended to laser scan the building. A laser scan can generate a highly accurate 3D mesh (+-5mm accuracy) that you can import into a 3D software application from which the optimization, UV-mapping and content template creation process can take place. The mesh is then exported as a texture mapped **.obj** file into Disguise.

For smaller objects, where the audience stands much closer to the object and the pixel density is higher (for example for car projections), it is even more important that the 3D mesh is as accurate as possible. However, as this usually is not the case, Disguise has a number of 2D-based warping tools allowing you to compensate for the inaccuracies between the virtual and the real-world model. Please see the sub-chapter [Warping outputs](#) for more information.

## Content creation

Based on 3D models, animators can create content either in 2D or in 3D, or both. For simple setups, a 2D content template generated from the UV-coordinates of the 3D model can be used as a background image in for example After Effects.

Video files are rendered and imported. In the software, the content is then applied back onto the same 3D models, allowing the content to be pre-visualised in 3D and in real-time, from any point of view. As the output to the physical projectors is handled by the virtual projectors, the animators only need to think about how to create content that looks good on the screen in Disguise software.

## How do I learn about preparing a projection-based 3D model for Disguise?

The 3D modelling and UV-mapping processes are currently not covered in detail in this User Guide. To learn more about these processes, register for the Pre-Production Workflows course offered online in our free e-learning system at <https://training.disguise.one>.

# Creating and removing projectors

Projectors in Disguise software are currently categorised as a type of screen, as they share so many of the same properties - they have a position, a rotation, a resolution, and output content via the feed system.

## Creating a projector for a stage

Please see the sub-chapter [Creating screens](#) for step-by-step instructions on how to add a screen to the Disguise Stage.

- Select **Projector** from the menu of screen types.

The below image shows an example of two projectors added to the d3 Stage.

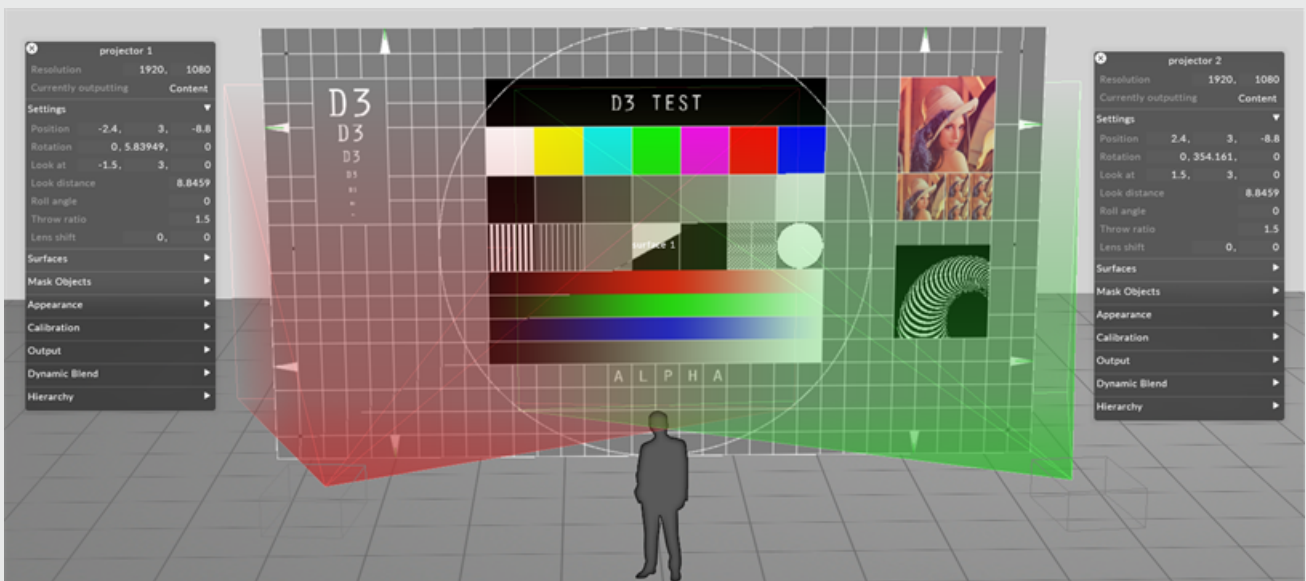

Stage Visualiser being used to visualise two projectors and a sculpture in a section of the d3 studio

## Removing a projector from a stage

- Open the Stage Editor by right clicking Stage on the d3 dashboard  
Or alternatively

- Right click the floor
- Left click and drag the Projector into the - icon

# Editing projectors

This sub-chapter explains the definition of the projector properties. These properties can be edited using the projector editor. To understand how to use the properties please see the sub-chapters [Manual Calibration](#) and [QuickCal](#).

## Editing a projector

- To edit a projector, either right-click directly on a projector in the Stage or right-click the projector from the screens list in the [Stage editor](#).

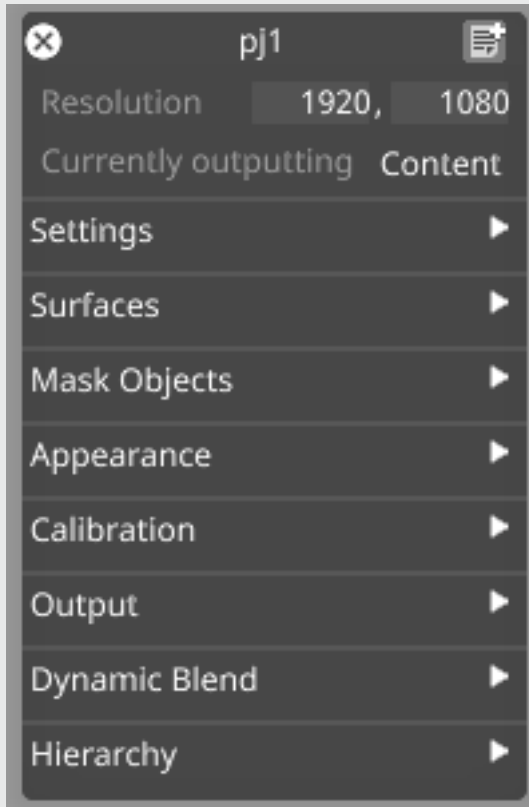

General projector properties

## Resolution

The x and y **resolution** of the projector, set in pixels. This should ideally be the native resolution of the physical projector model you're using.

## Currently outputting

Type of output mode that currently is active.

- Content: Outputs the content played on the timeline.
- Wireframe: Outputs the wireframe of the model.
- Identify: Full colour image with the projectors name on it.

- Grid: Outputs a coloured grid applied to the projection object
- None: Outputs nothing (except reference points during QuickCal lineup)

# Settings





## Offset

The x, y and z position of the projector based from the origin point (0,0,0), set in meters.

## Rotation

The rotation of the projector around the x, y and z axes respectively, in degrees.

## Look At

The x, y and z position (in meters) of the **Look At** point. The projector always rotates to point at the **Look At** point.

## Look Distance

The absolute distance between the projector position and its **Look At** position, in meters.

## Throw ratio

The throw ratio is defined as the throw distance "D" divided by the width of the projected image, "W". Since D and W are both in meters, the throw ratio quantity itself has no unit. Simply, the larger the throw ratio, the narrower the focus. Projector lenses are usually rated at particular throw ratios; you would simply type in the lens throw ratio here.

## Field of View

Field of view in degrees for the specified throw ratio

## Lens shift

Represents horizontal and vertical lens shift. When horizontal shift is set to 0, there is no shift; when it's set to 1, the left edge of the projected image lines up with the central projection axis. The same applies to negative numbers (-1 lines up the right edge) and to the vertical shift (bottom and top edges respectively).

## Radial distortion

Radial lens distortion coefficients  $k_1$ ,  $k_2$ ,  $k_3$

## Tangential distortion

Tangential lens distortion coefficients  $p_1$ ,  $p_2$

# Surfaces

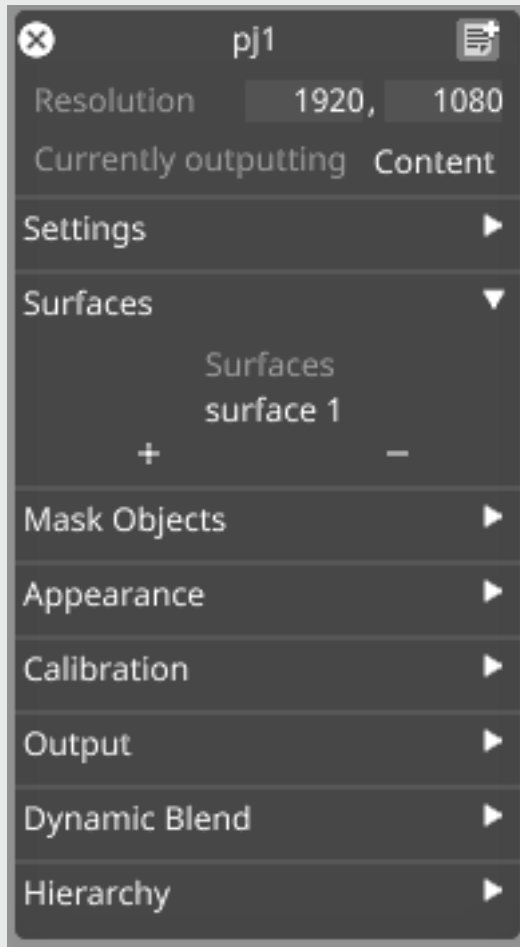

The list of screen surfaces the projector will project onto. The projectors view of the virtual stage will only contain these surfaces.

To add a projection surface to the list:

- Left-click the + button to open the Surfaces manager.
- Select the surfaces you wish the projector to see.

# Mask objects

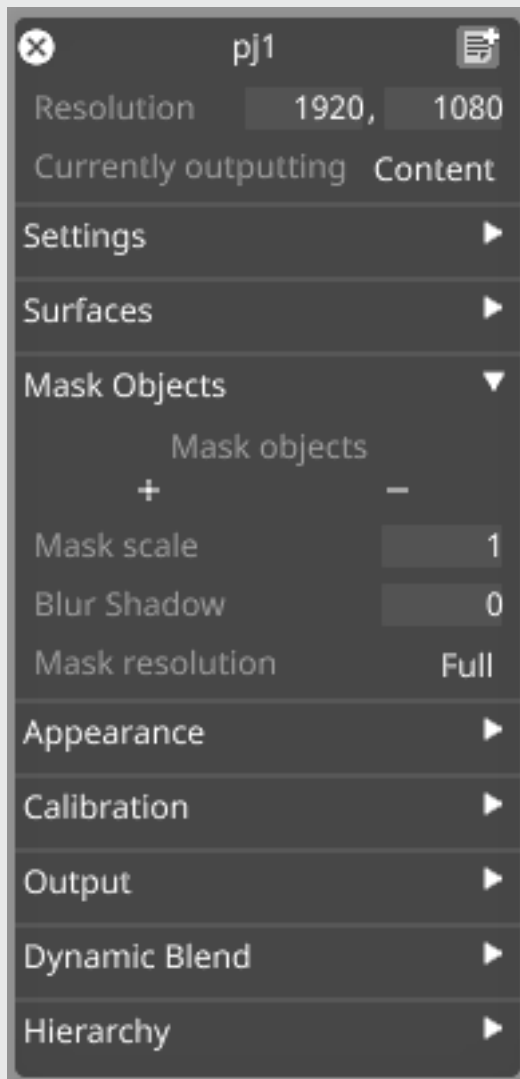

The list of objects this projector should render as black.

To add a mask object to the list:

- Left-click the + button to open the Objects manager.
- Select the objects you wish the projector to mask out (render black)

## Mask scale

Mask scale allows you to scale the texture that is generated as the mask.

## Blur shadow

Blur shadow allows you to add a blur effect to the edges of the generated mask.

## Mask resolution

Mask resolution, set to Full by default, allows you to only generate the mask at half and quarter resolution for times when full resolution is not needed, or to save performance.

# Appearance

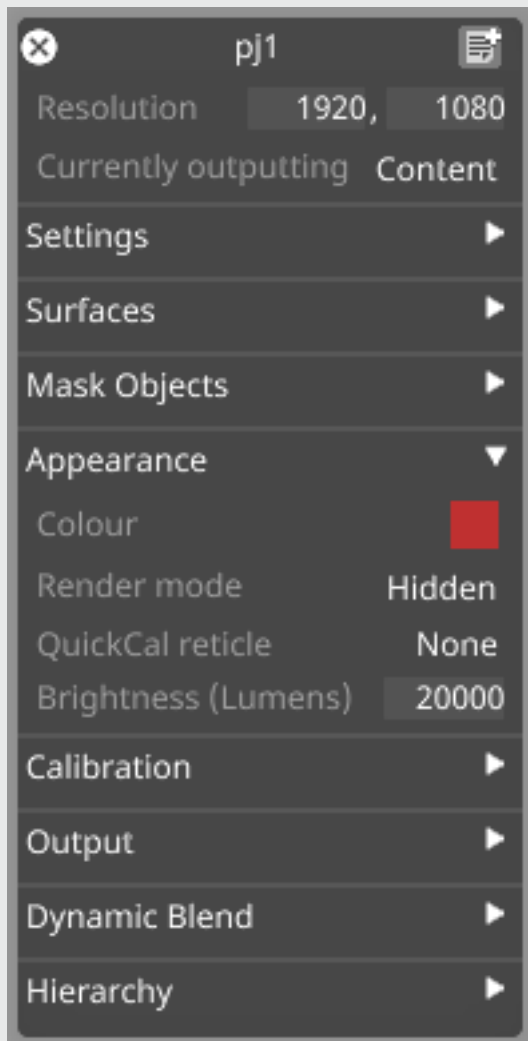





## Colour

The colour of the projector beam in the visualiser.

## Render Mode

Switches the projector's output in the virtual stage for easier identification of testing.

Types of render mode:

-  Hidden
-  Beam
-  Wire
-  Beam & Wire

## QuickCal reticle

Create and chose a custom bitmap as the QuickCal lineup cursor.

## Brightness (Lumens)

Projector brightness, in ANSI Lumens. This setting affects the visualiser only.



# Calibration

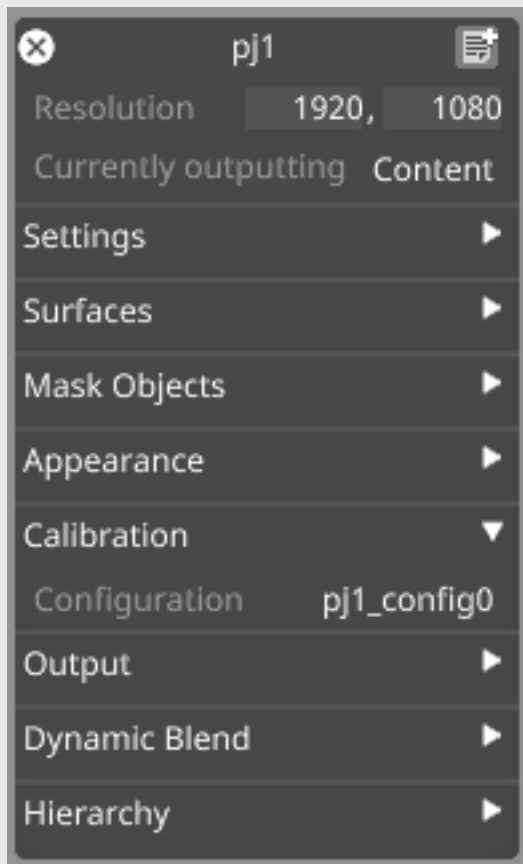

## Configuration

The configuration of a projector stores its **calibration** - a precise measurement of its actual position and lens settings. Calibrated quantities are not necessarily the same as the properties you enter in the preceding boxes, but will usually match fairly closely.

- Left-click on the configuration property to open the library of settings for all projectors. You can also create multiple configuration files for the same projector.
- Right-click **configuration** to start a QuickCal lineup.

Output

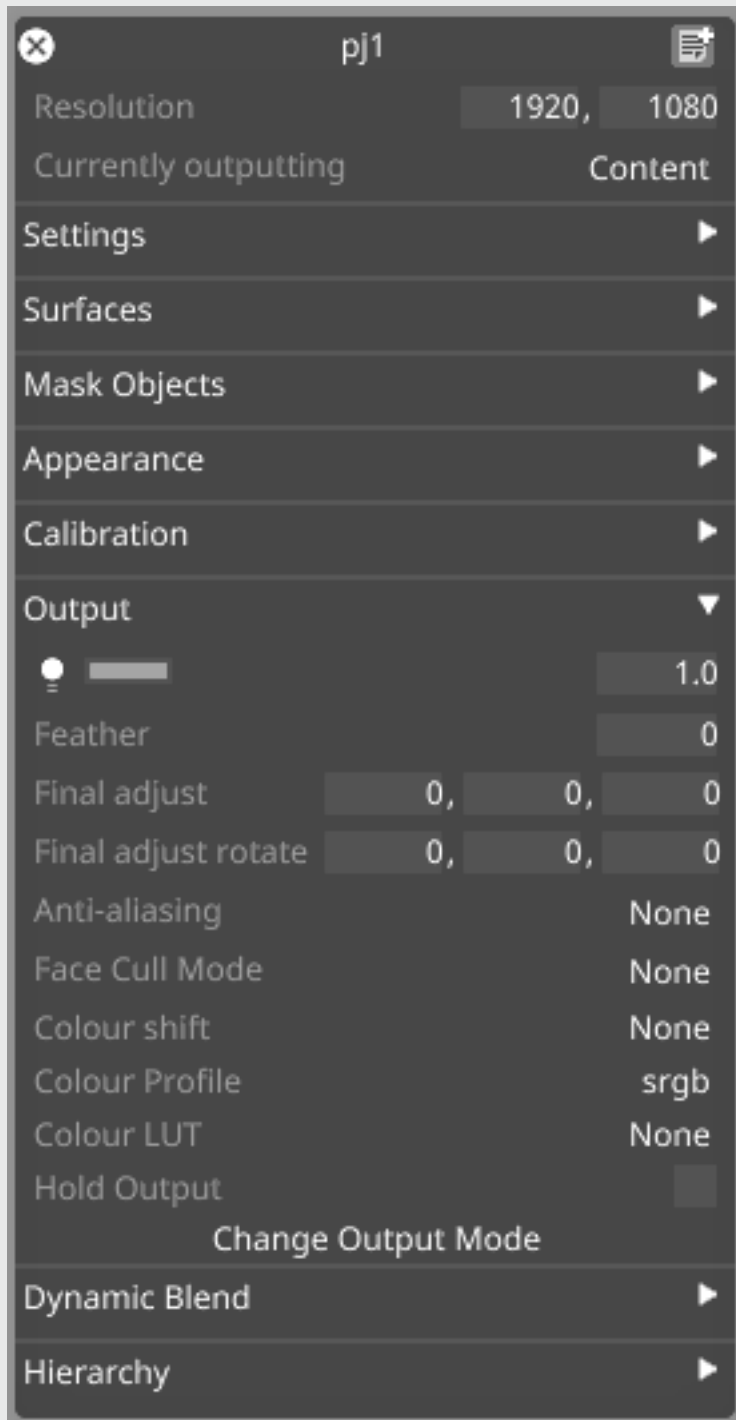

## Master Fade

Controls the output brightness.

**Please note:** the Master fade only controls the brightness of the output feed. The brightness in the stage visualiser is not affected.

## Feather

Shrinks or grows screens in the projector's view, to fix over-projection.

## Final Adjust

Adjust the offset added to a projector's position, in meters

## Final Adjust Rotation

Offset added to a projector's rotation, in degrees

## Anti-Aliasing

The anti-aliasing options for the projector.



**Warning:** enabling anti-aliasing on projectors can cause performance degradation.

- None
- 2X FXAA

- 2X MSAA
- 4X MSAA
- 8X MSAA

## Face Cull Mode

Use this to skip rendering faces with normals pointing toward (Front) or away (Back) from the projector.

## Colour shift

The **Colour shift** property allows you to perform a number of colour-correction operations on the output of a projector.

To apply a **Colour shift** to a projector:

- Left-click **Colour shift** to open the Colour shift manager
- Either create a new Colour shift by typing a name into the new **colour shift** text box and hit **Enter** , or select a colour shift configuration from the list.

To edit a **Colour shift** :

- Right-click a **Colour shift** in the **Colour shift** manager to bring up the **Colour shift** editor.

## Colour Profile

Colour/gamma space of the output display

## Colour LUT

Cube LUT applied to correct display device output; does not appear in visualizer.

## Hold Output

Stops the output of this display until unchecked

## Change Output Mode

Left-click to change the type of output mode that currently is active.

- **Content:** Outputs the content played on the timeline.
- **Wireframe:** Outputs the wireframe of the model.
- **Identify:** Full colour image with the projectors name on it.
- **Grid:** Outputs a coloured grid applied to the projection object
- **None:** Outputs nothing (except reference points during QuickCal lineup)
- **BlackTrax:** For Blacktrax line up

# Dynamic Blend



✕ pj1 

Resolution 1920, 1080

Currently outputting Content

Settings ▶

Surfaces ▶

Mask Objects ▶

Appearance ▶

Calibration ▶

Output ▶

Dynamic Blend ▼

Dynamic blend Enabled

Membership function Linear

Gamma bias 0

Barn door (top) 0

Barn door (left) 0

Barn door (bottom) 0

Barn door (right) 0

Exclude Projectors:  
+ -

Use snapshot No

Hierarchy ▶

## Dynamic Blend

Allows you to enable/disable Dynamic blend on individual projectors.

## Membership function

Dynamic Blend Membership Algorithm;

Options are Linear, Radial, and Linear to Radial

## Gamma bias

Adjusts the estimate of this projector's gamma relative to the Stage's global blend gamma.

## Barn door (top)

Top edge of the Dynamic Blend

## Barn door (left)

Left edge of the Dynamic Blend

## Barn door (bottom)

Bottom edge of the Dynamic Blend

## Barn door (right)

Right edge of the Dynamic Blend

## Exclude Projectors

Projectors excluded from the Dynamic Blend

## Use snapshot

Lock the Dynamic Blend in a snapshot

For more information on using Dynamic Blend, please visit [this link](#).

# Hierarchy

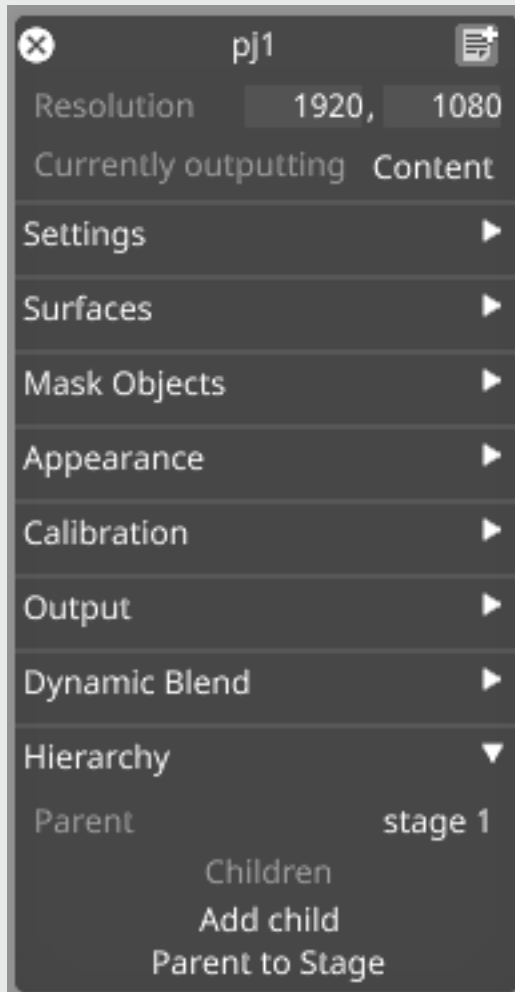

For more information on Hierarchy, visit this [link](#)

# Outputting to projectors

The Disguise software uses **Feed scenes** to output projector outputs. The output displays contained in these **Feed scenes** can be configured to a specific resolution and frame rate. For more information please see the sub-chapter [Configuring Feed scenes](#).

## Creating an output from a projector

- Go to the **Feed** level by left-clicking **Feed** from the dashboard. The top half of the screen displays the video screens and the outputs from the projectors currently active stage in the **Stage** level.
- Right-click the first projector output, then left-click **add feed rectangle**. Please make sure that you clicked a projector output and not the video screen that the projector is sampling from. This will generate an output feed from the projector and place it on head 2 (by default, output head 1 is represented by the GUI ). This should now send a feed to the first physical projector. Repeat this step for each projector that needs to be outputted. For a show that requires more than 3 projectors (1 GUI + 3 outputs) you will have to create a **Director/ Actor network** explained in the [Director/ Actor setup using d3Net](#).

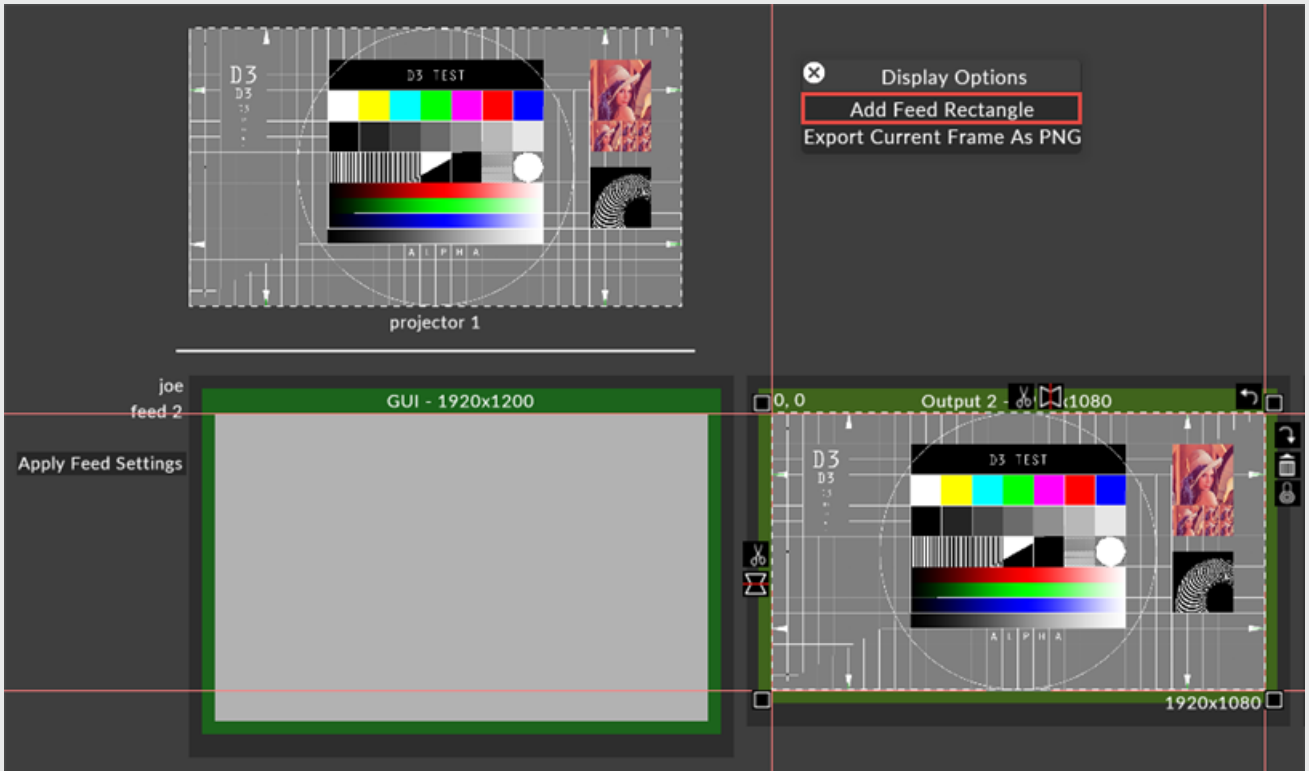

The Add Feed Rectangle option is used to add a Feed rectangle and generate an output feed from a projector.

# Projector List Overview

The Projector List is a faster way of managing calibration when you have a large number of projectors to work through.

To open the Projector List, hit **Ctrl + P**

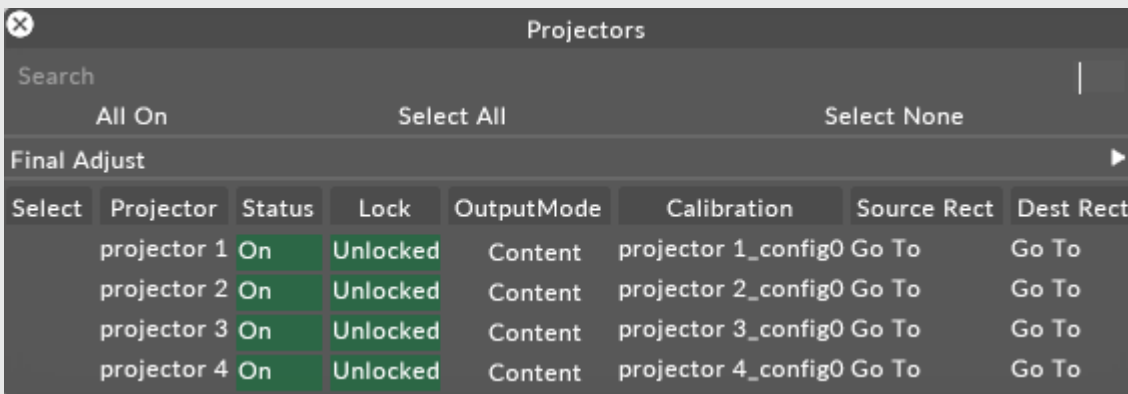

The Projector List. Open the Projector List by hitting Ctrl-P or via the Stage Editor.

## Features of the Projector List

### Select

- Left-click to select which projectors are to be controlled together.

### Projector

- Left-click on a projector name to open its Projector Editor

### Status

- Left-click to turn projectors on and off ('mute' means 'faded to black')

## Lock

- Left-click to lock the projector settings

## Output Mode

- Left-click to switch the output mode of the projectors

## Calibration

- Left-click on a projector config to open the projection calibration editor (QuickCal)

## Source Rectangle

- Left-click to jump to the feed source rectangle for that projector in the feed view

## Destination Rectangle

- Left-click to jump to the destination (output) rectangle in the feed view

## Final Adjust

- Fine-adjust selected projector's positions in x, y & x axes for last minute adjustments (hold down the Ctrl key for fine control or the shift key for fast control)

## Multiple Projector Lists

Everytime you hit **Ctrl + P** another instance of the projection list is opened. Using the select buttons you can you can filter them differently to aid workflow when using large numbers of projectors.



# Manual Calibration - Projectors



**Warning:** reset all digital and optical warps inside the projector, including lens-shift, otherwise the lineup features will be interrupted.

- Open the projector editor by either right-clicking the projector directly in the Stage, or by right-clicking the projector from the **screens** list in the Stage editor.
- Familiarize yourself with the properties of a projector. After this follow the instructions explained below.

## Set the correct resolution

Set the **resolution** of the projector to match the corresponding output head's resolution.

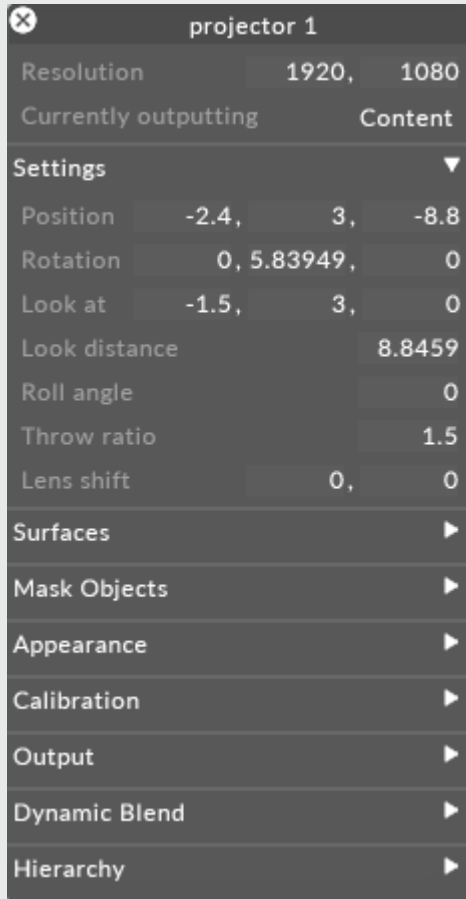

**Warning:** If the resolution of the projector doesn't match the real world output, you will end up with an incorrect calibration.

## Add surfaces

Under the **Surfaces** tab add the projection screens that the particular projector is covering.

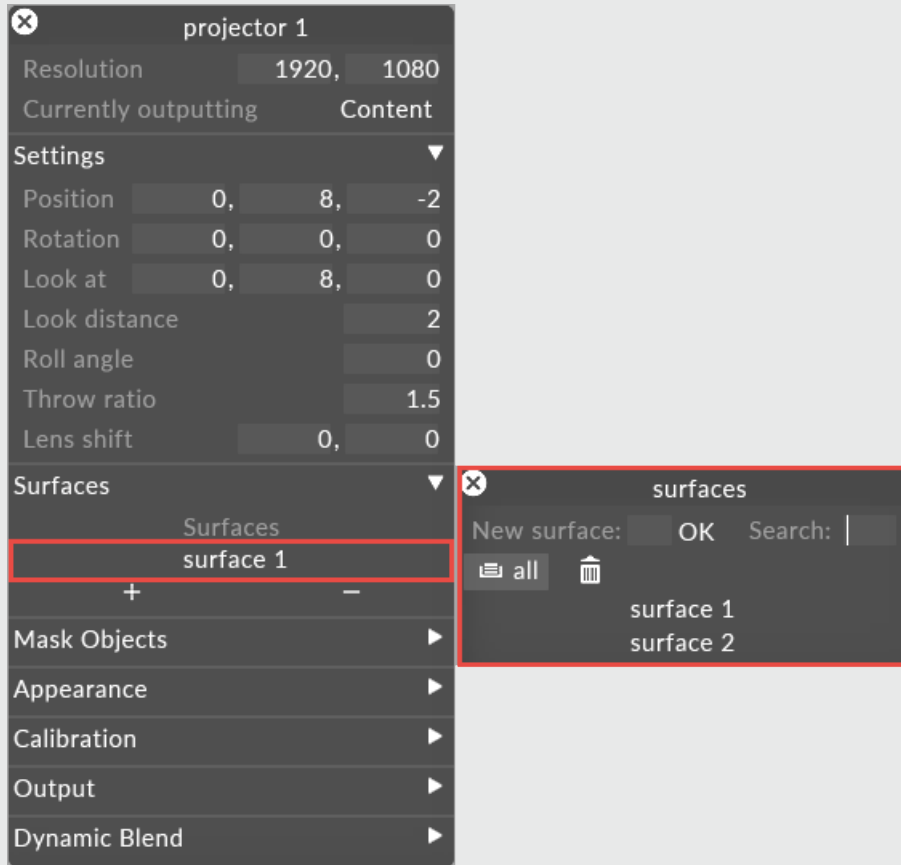

**Warning:** If you don't add a screen to the projector the output will stay black.

## Add the projector outputs to the Output Feeds

Ensure all of the Feed rectangles from the projector outputs have been added to the output heads.

Please see [adding feed rectangles](#) for information how to do this.

# Place the projector correctly

Change the **pos** (projector position) and **the throw ratio** (lens value) properties so that the projector covers the required part of the screen surface. A laser measure may be required to calculate the correct position by measuring the distance from the physical projector to the video surface.

## Adjust the Look at position

The **Look at** position of a projector defines the centre point of its corresponding output feed. When lining up a virtual projector to the physical projector it is therefore crucial to match the Look at position to its corresponding point in the real world.

Disguise has a built-in wireframe feature allowing the system to generate a line-drawing based on the 3D mesh of the projection surface. In the same output frame Disguise will also output a red cross positioned in the centre of the output feed. When the wireframe test pattern is applied, Disguise will output this red cross regardless of the orientation of the projector.

Consequently, if the look at position of the projector is aligned to the red cross on the physical projection surface, the virtual projector and the physical projector are orientated around the same point which is a great starting point for an accurate manual lineup.

## Align the look at position of the projector

- Change the output mode to **wireframe** by clicking the **output** tab at the bottom of the projector editor.
- Return to the Stage level. Set the **step** value of the look at position to 0.01 to enable smoother scrolling of the look at values. To change the step value, right-click the property **name** and change the value in the Step value property.
- Begin aligning the look at position of the projector to the red cross by comparing the look at positions crosshair in the Stage level and the red cross being outputted from the physical projector.



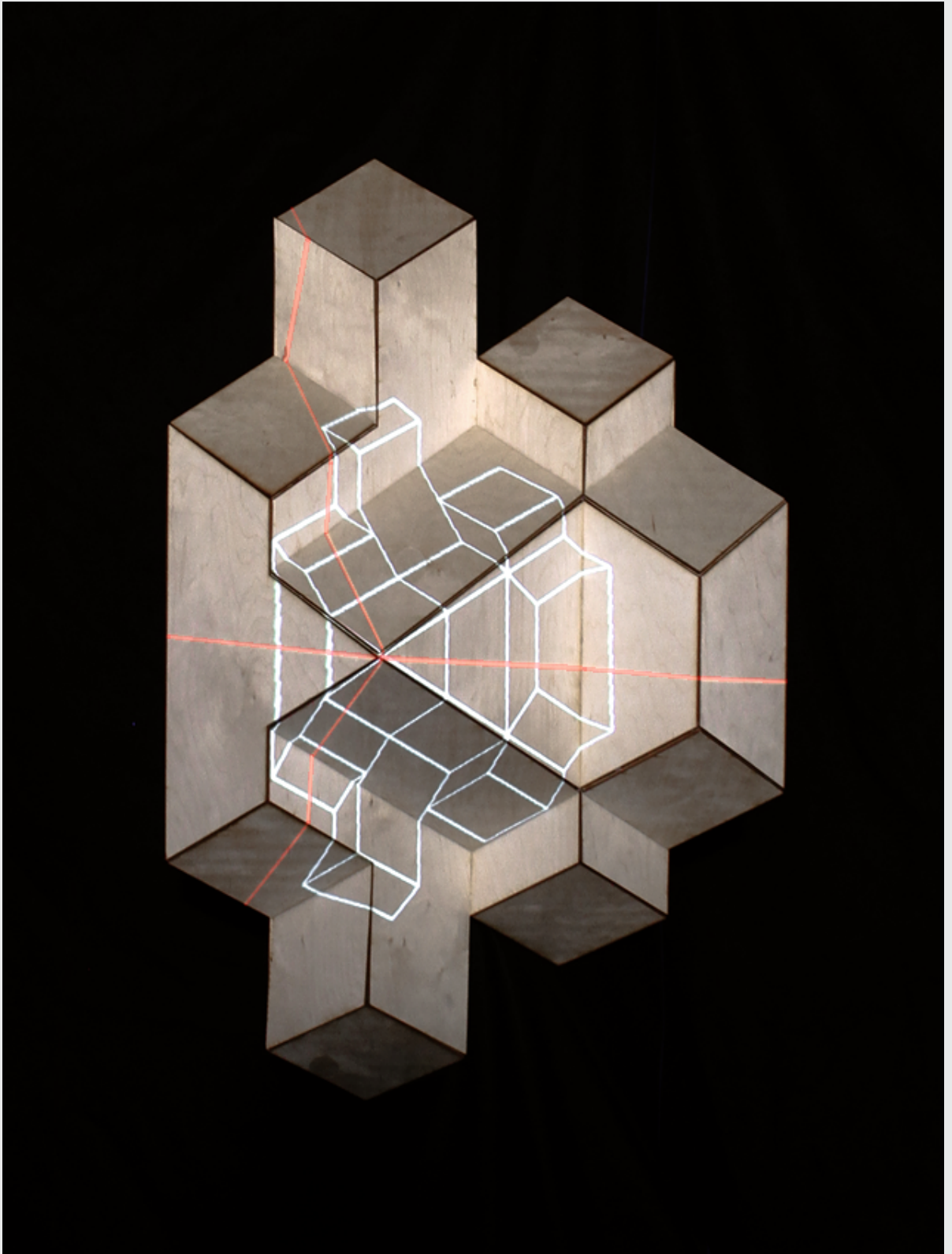

Look at position of the virtual projector now matches its corresponding point on the physical video screen, in this example a wooden sculpture

## Adjust the throw Ratio

- To zoom in on the physical video screens content, change the **throwRatio** value. This value corresponds to the lens size of the physical projector.
- If the exact lens size is known (for example a fixed lens size is being used), type it in.
- If a zoom lens is being used, set the start value to the lowest (or highest) value in the zoom range. Slowly change the value by scrolling the mouse wheel in the property field.

## Fine tune property values

- After setting the initial lens value, try not to edit the position properties. Instead, start adjusting the **rotation** parameters if needed, in particular the x and y rotations. Aim to establish parallel lines mapping onto the video screen **globally** rather than focusing only on one part of the screen. Adjust the **step** value if needed.
- Go back and fine tune the values of the lookAt position to center the output to the physical video screen. **Remember to establish parallel lines.**
- Adjust the throw ratio to zoom in/out of the content on the video screen. Assuming that the 3D mesh is accurate to the physical video screen, the mapping should gradually fall into place.

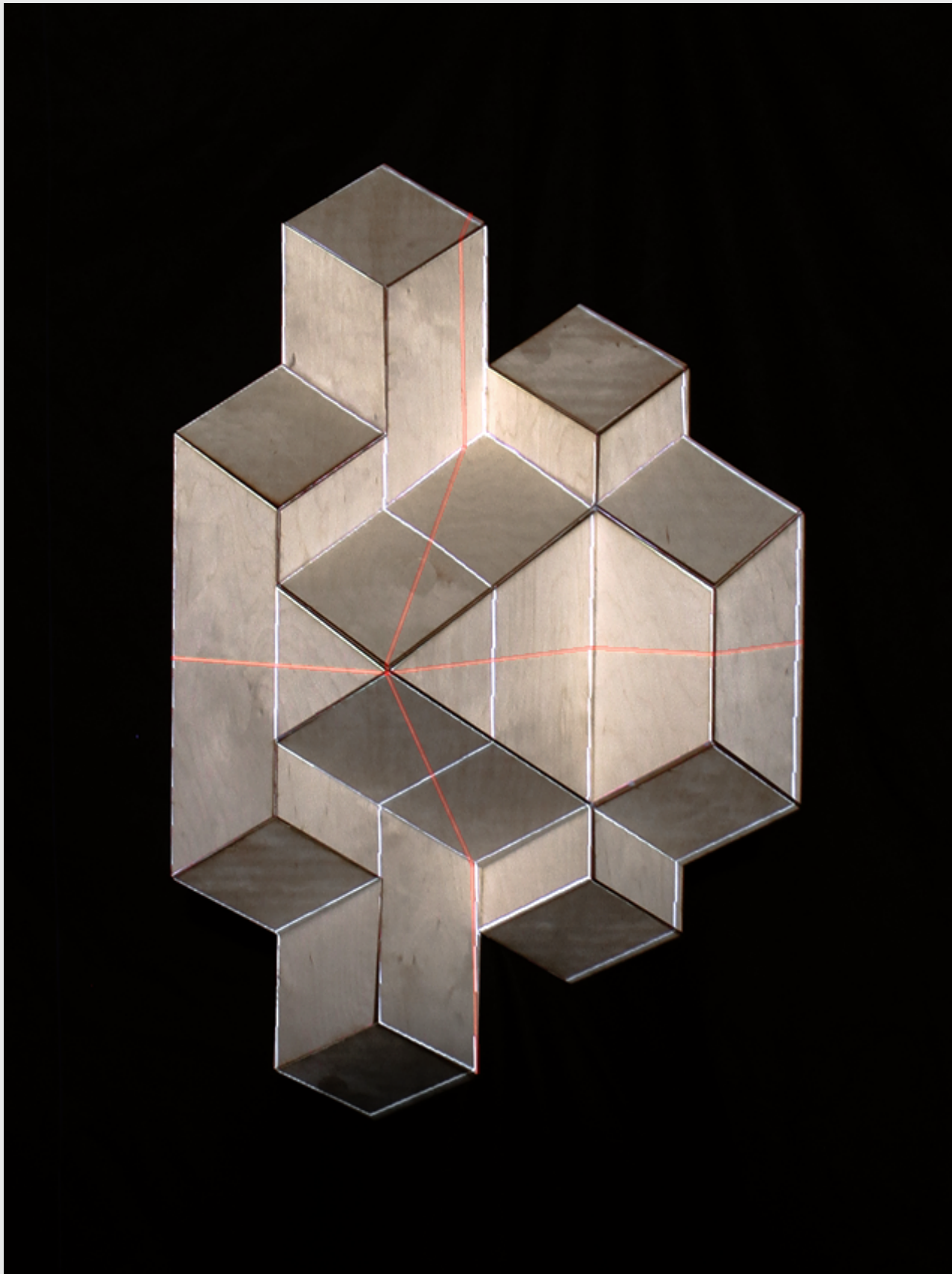



Projector has been manually calibrated; the 3D mesh test pattern now lines up with the wooden sculpture

If the projection surface does not match the 3D model after carrying out manual calibration the lineup may need to be fine-tuned. Please see the sub-chapter [Warping outputs](#) for more information.

# Warping outputs

In cases where the projection surface does not match the virtual 3D model (i.e. where the lineup from the manual or automatic calibration needs a slight fine-tune), Disguise software provides a number of powerful warping layers that can be applied directly to the output. By using these tools there is no requirement for projector keystoneing or any other warping inside the physical projector.



**Warning:** reset all digital and optical warps inside the projector, including lens-shift, otherwise the lineup features within Disguise software will be interrupted.

## Adding/using warping layers

- To add a warping layer to an output left-click **feed** in the dashboard (bar at the top of the screen), right-click the appropriate output and select **Edit Warp** from the options list.

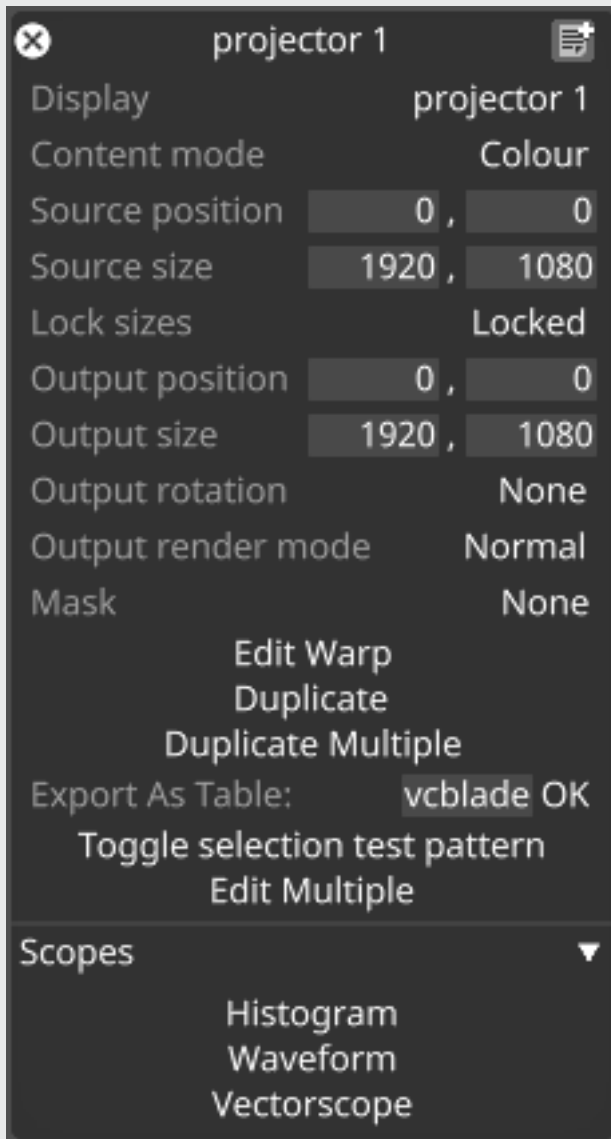

In the editing window, left-click the + button under the **Deformation layers** title. This will display a list of deformation layers.

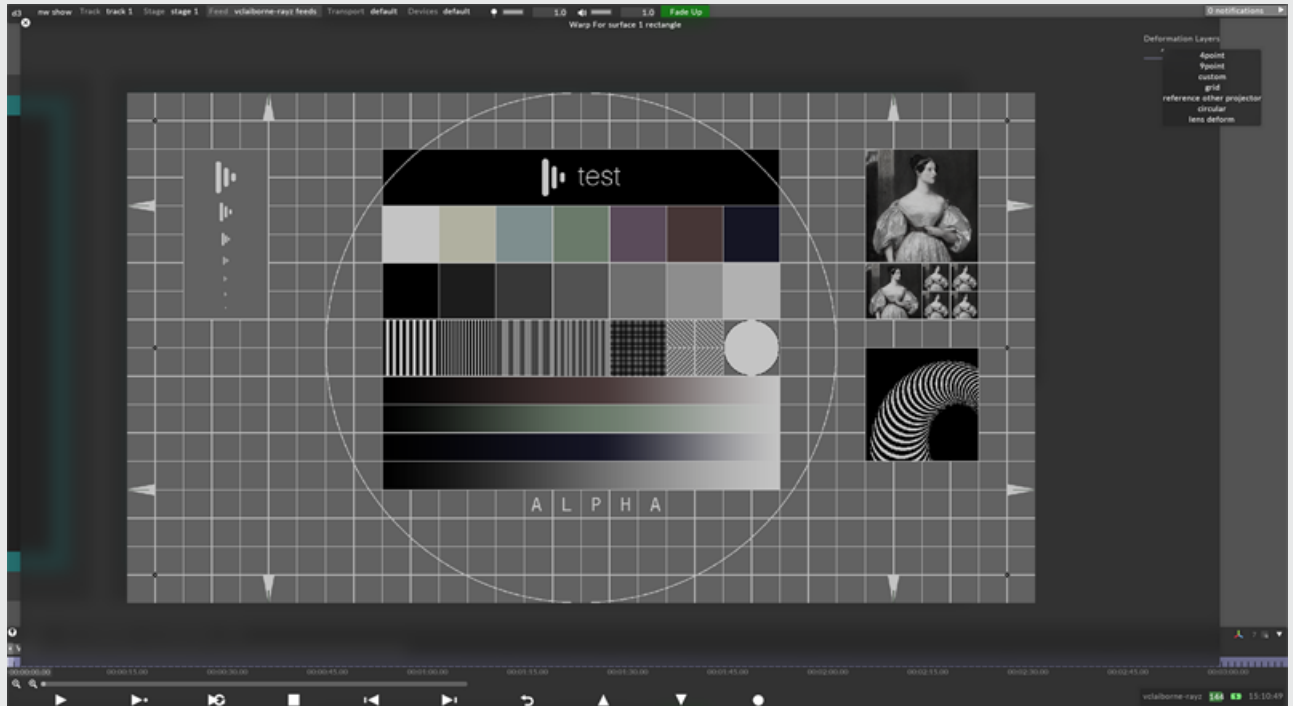

Deformation layers for warping an output feed, opened by left-clicking + under the Deformation Layers title

**Please note:** Warp points can be added to the output so you can see exactly which part of the output is being manipulated

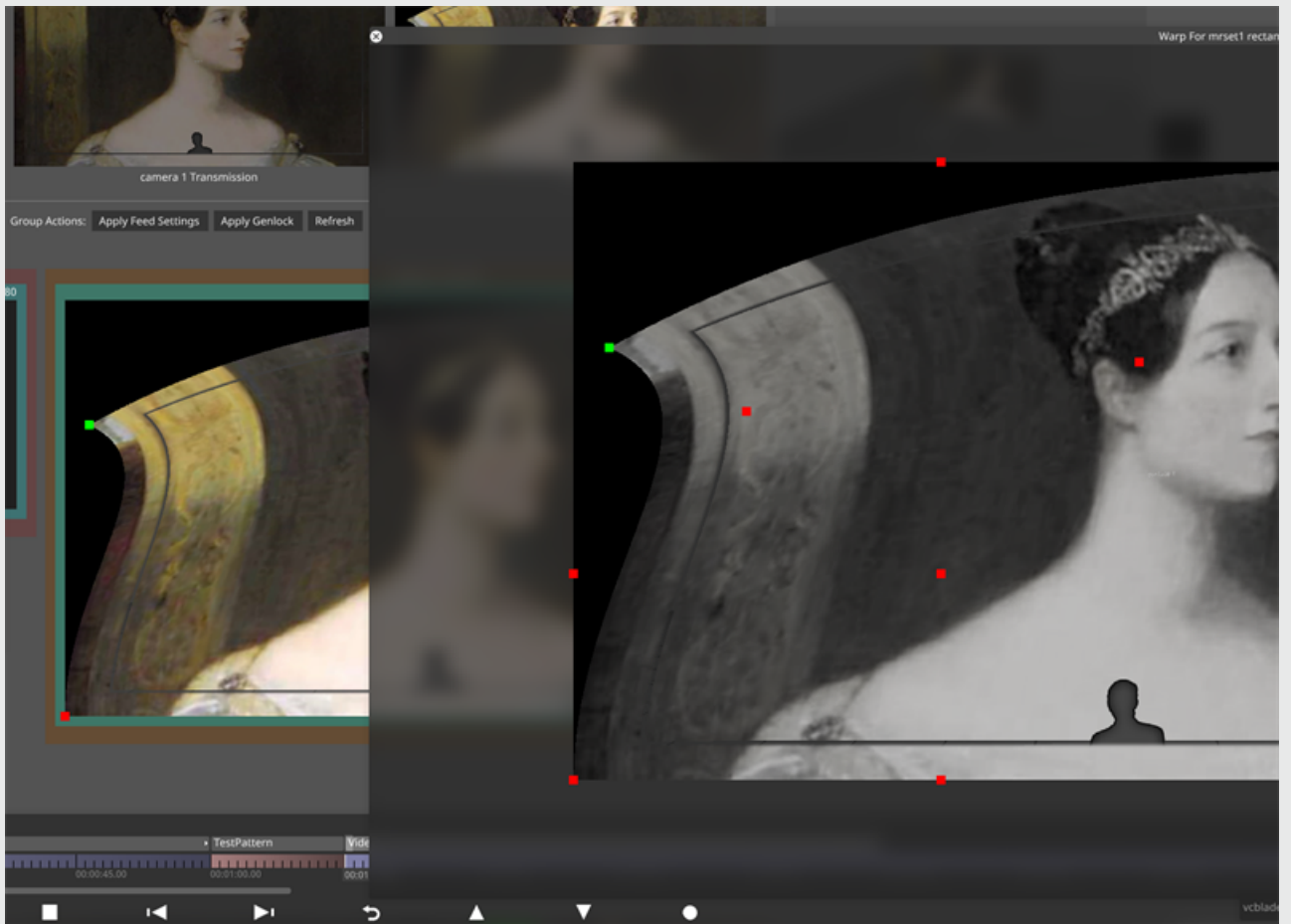

Warp points being added to an output

# 4point

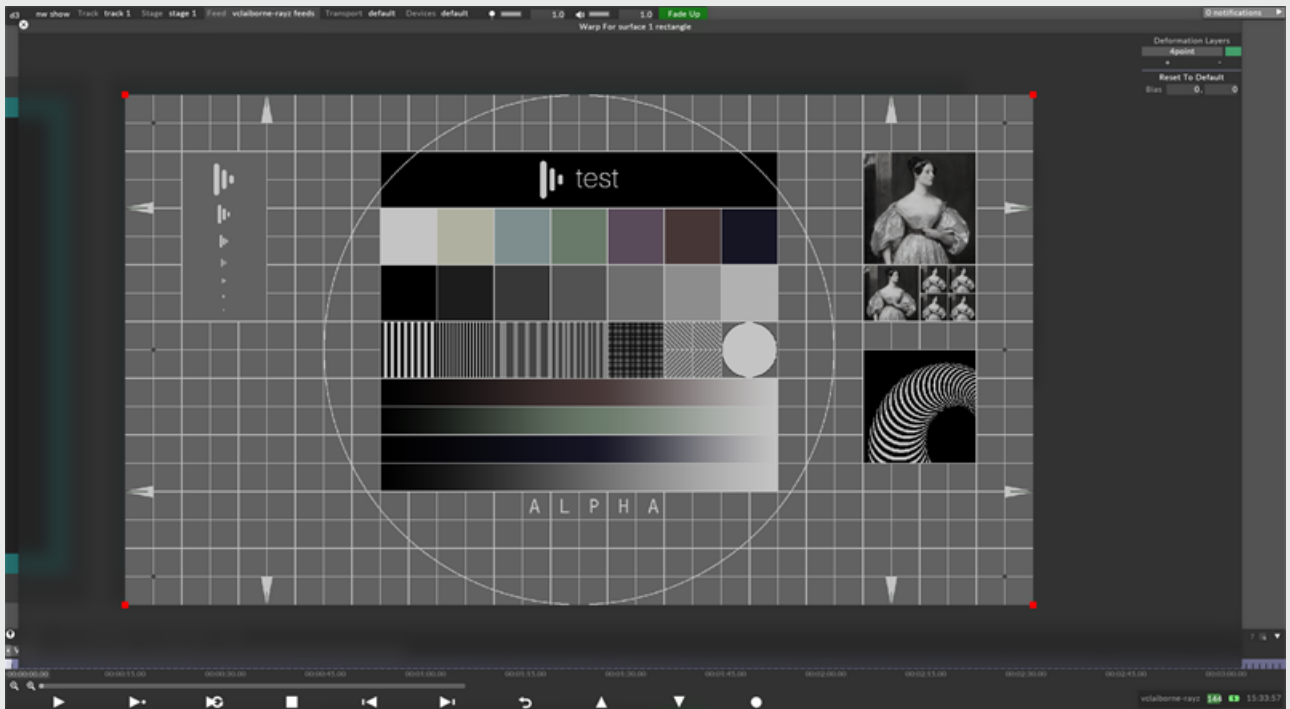

Drag any of the 4 points inwards to globally adjust the warping of the output. Adjust the horizontal and vertical **bias** to shift-scale the content.

# 9point

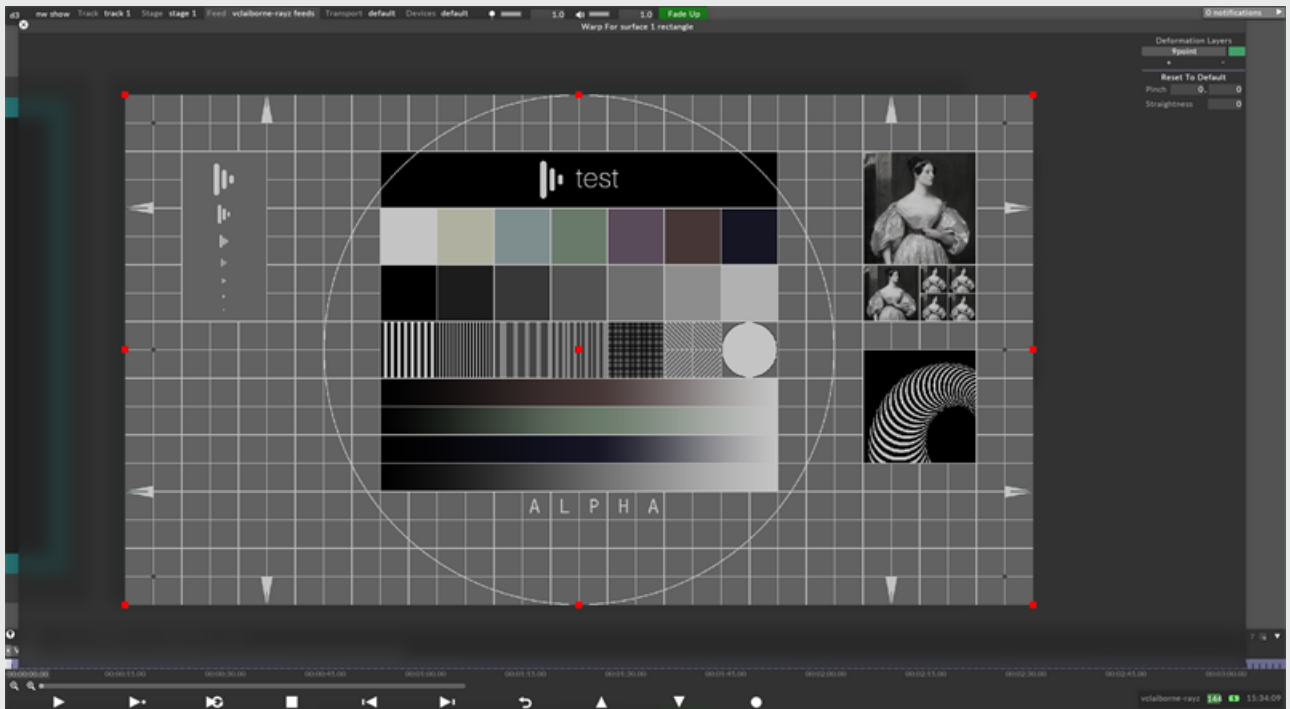

9point warp allows you to drag 9 points inwards and adjust the pinch and straightness between them. This feed warp is useful when projecting onto a cylindrical screen when not using Projector Simulation. It easily conforms a rectangular output to fit to a cylindrical screen.

# Custom

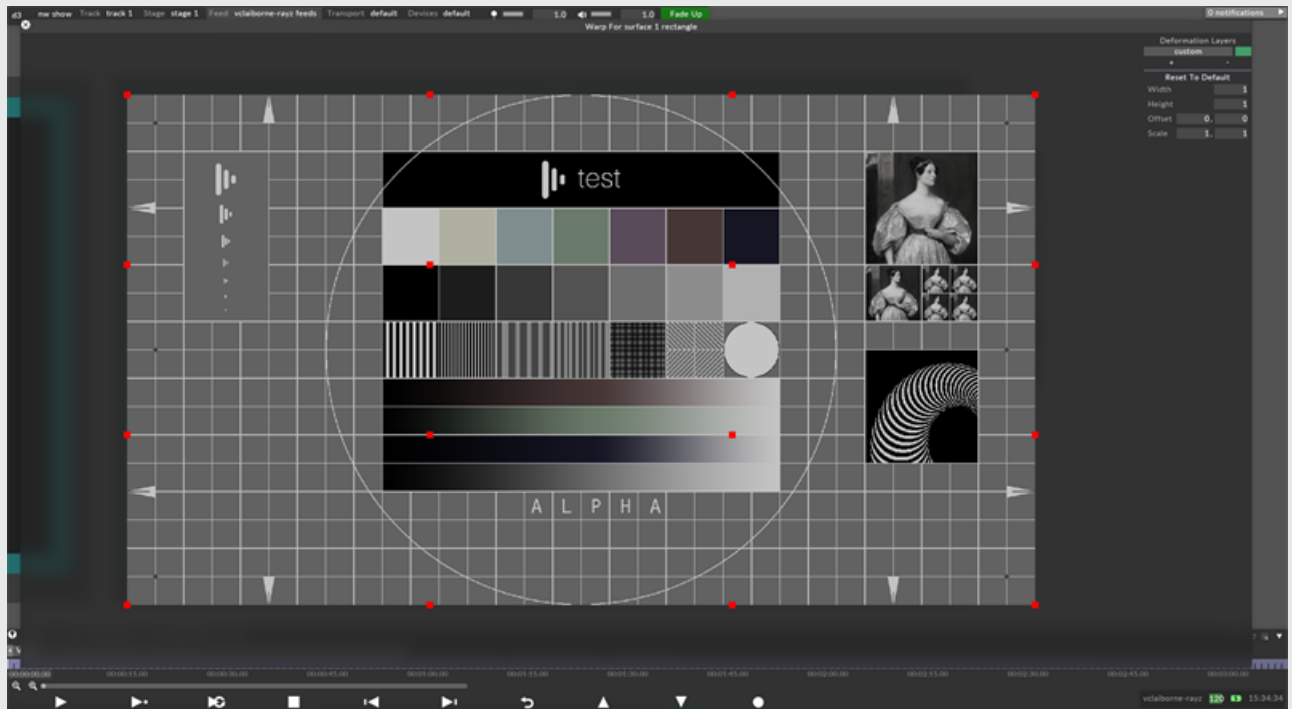

Creates an arbitrary number of grid points on the output which can be group-selected. You can use this when **local warping** on an object is required.



# Grid

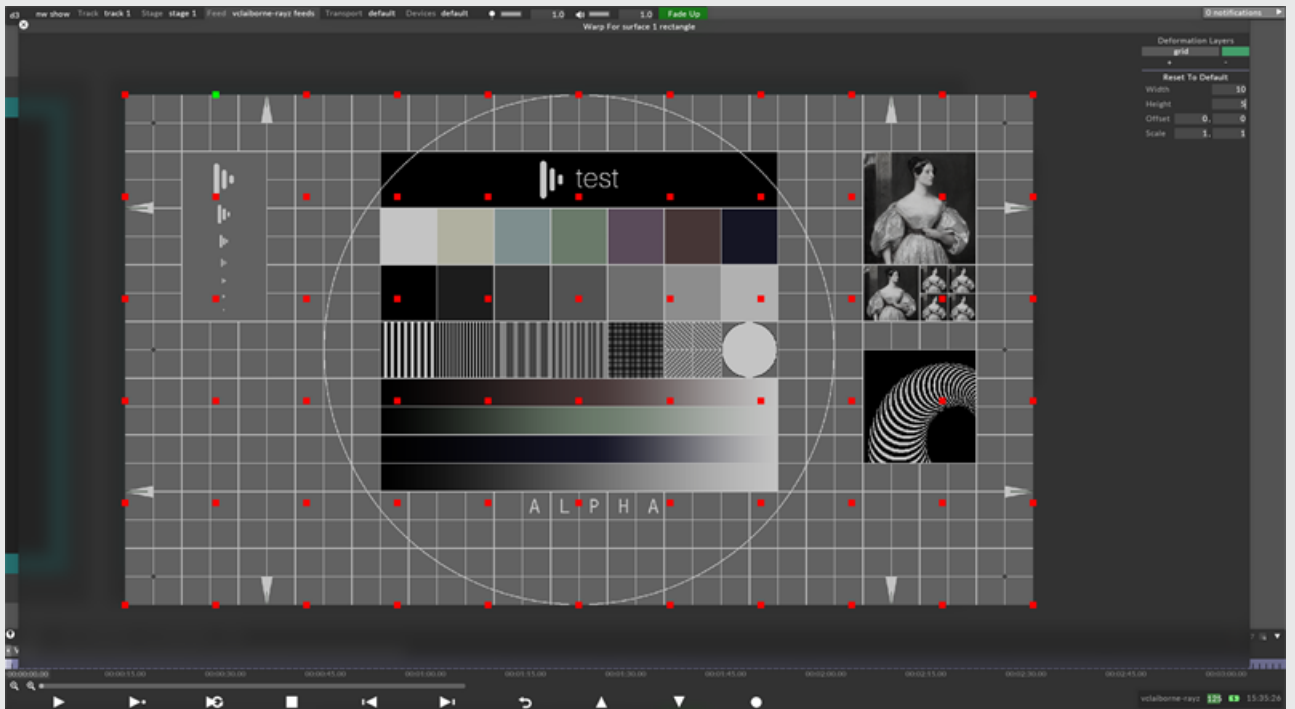

# Reference other projector

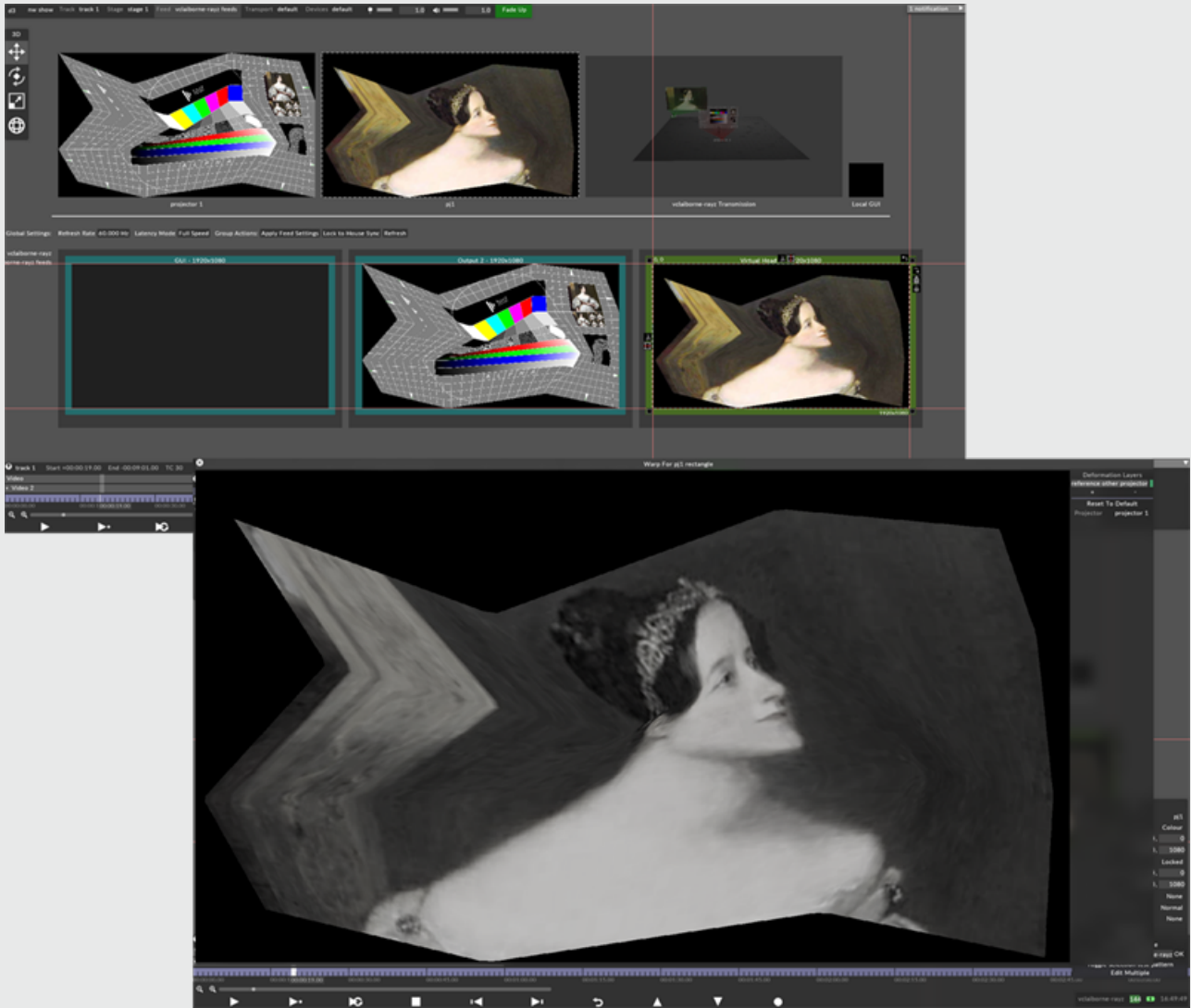

# Circular

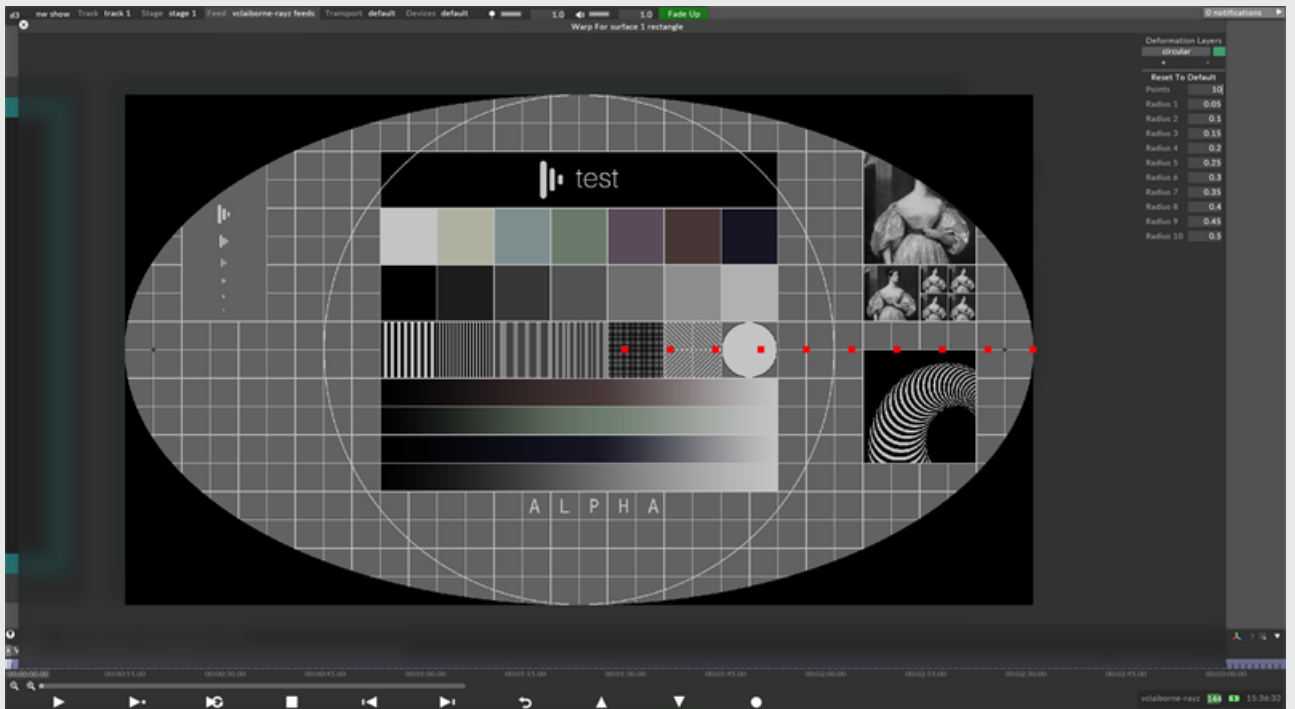

# Lens deform

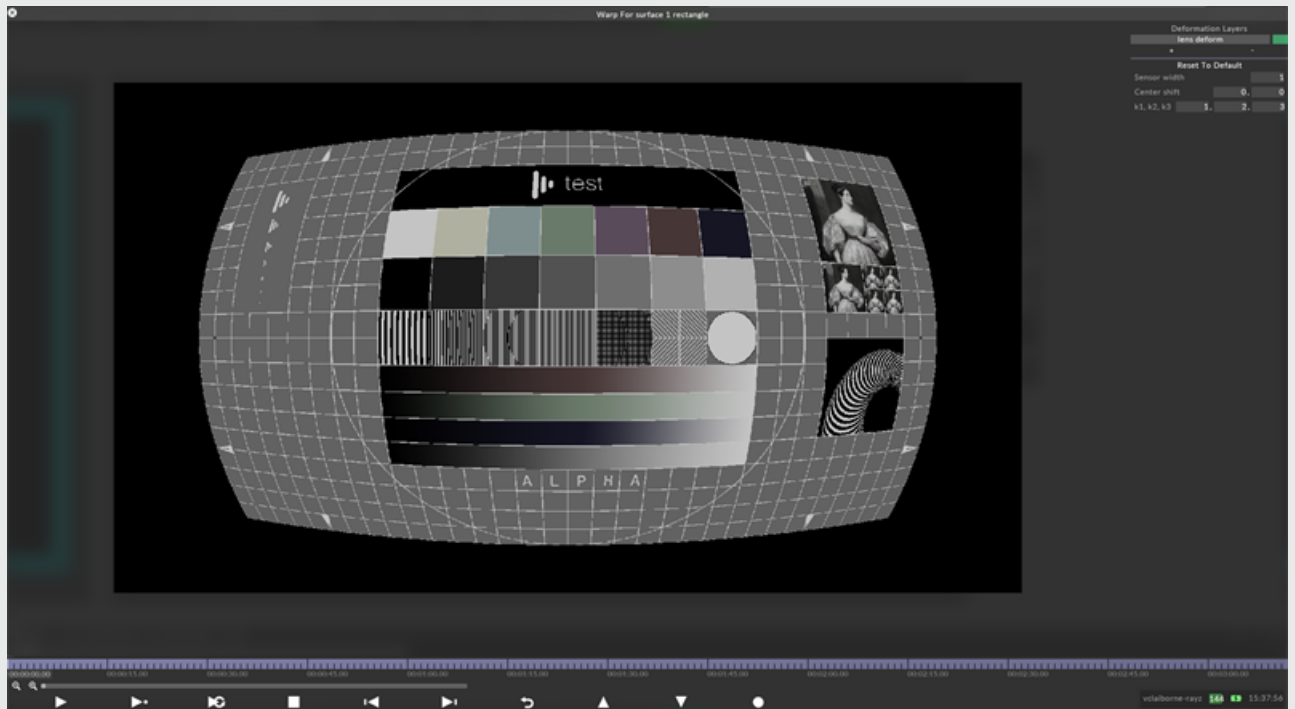

# Draw control points on output

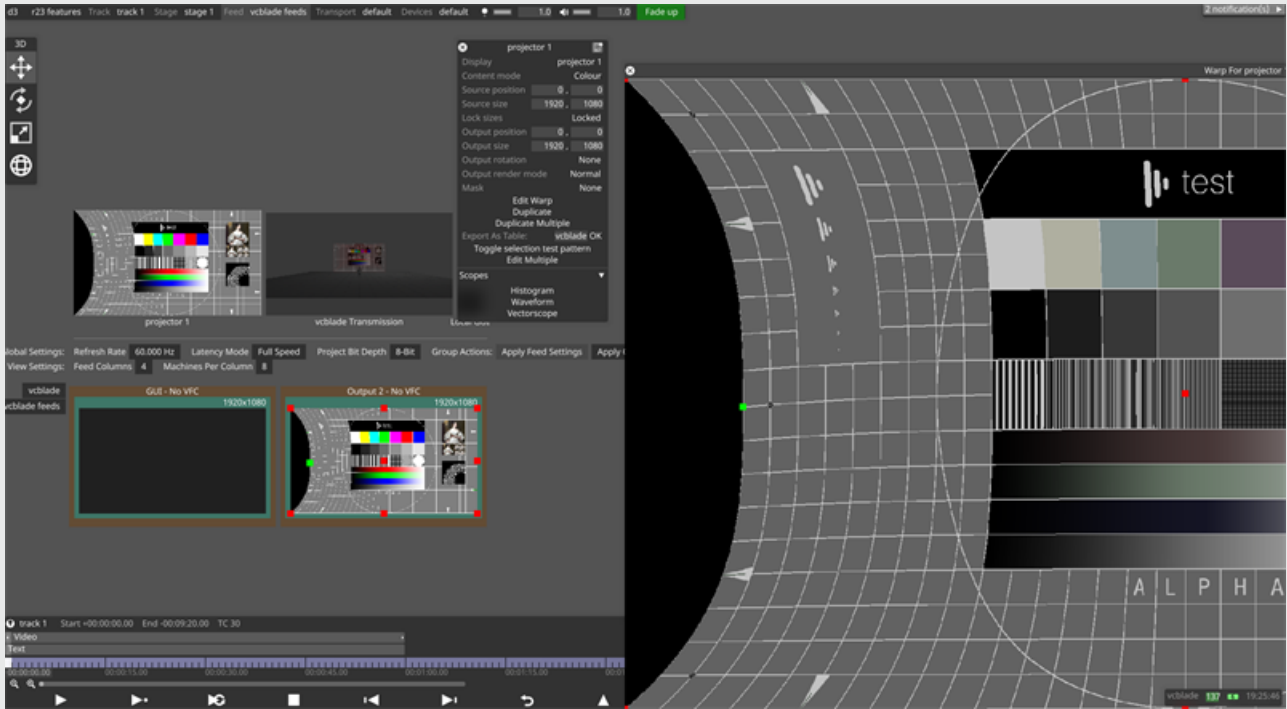

Warp points can be added to the output so you can see exactly which part of the output is being manipulated

# Projector Footprints

Projector footprints is a pre-production feature of Disguise software that allows you to simulate what the projector would actually behave like in the real world. Projector footprints show projector brightness overlap, pixel stretching and brightness falloff accurate to the position of the projector in 3D space.



*Example of projector footprints*

## Enabling Projector Footprints

To enable projector footprints -

- Right click the Stage Editor from the d3 dashboard
- Expand the visualiser tab

Toggle Footprints to On

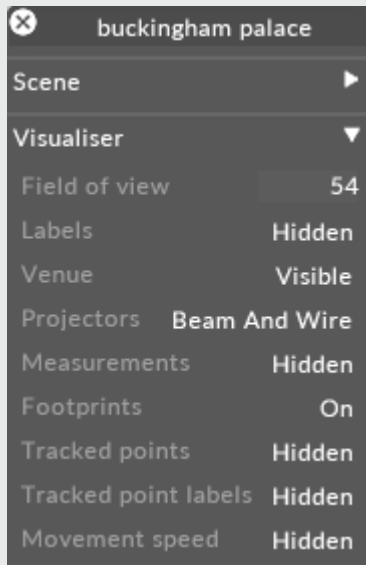

*Projector Footprints enabled*

# Multi-Pose Projection

## Calibration Overview

The QuickCal configuration includes a Multi-Pose workflow to allow for the calibration of objects that move.

### Multi-Pose Projection Workflow

1. place the moveable object in a particular position (the “pose”) and then perform a standard quick-calibration.
2. Then rotate the object to a second position.
3. Drag the existing markers to the correct positions and add new ones if necessary, until the projected image is correct and sharp.
4. This process is then repeated for as many poses as are required.

Unlike in the single-pose workflow, we see the dropped calibration points rotate along with the model.

### Example

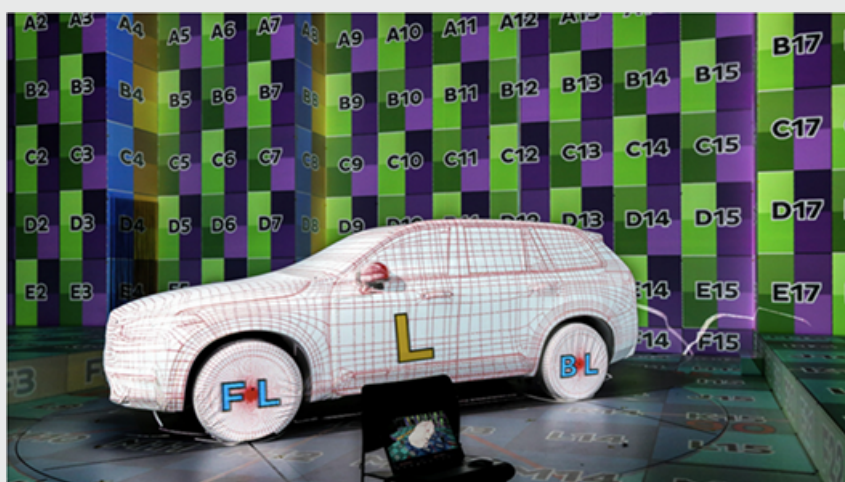

Example application : a car on a rotating turntable, with encoder



In this image, is an example of a car on a motorised turntable. During configuration as the car rotates, the calibrated points gradually drift from their locations on the real model, showing that the calibration isn't perfect across the space. Once the car is in a new pose, we simply drag the existing markers to the correct positions, and add new ones if necessary, until the projected image is correct and sharp.

# Blending and masking outputs

The Disguise software allows the user to generate custom softedge textures and masks inside it. You can then apply the softedge texture directly on the output and update the shape, gradient and gamma settings in real-time.

## Create a softedge mask on the output

Select Mask option is used to create a custom SoftEdgeTexture mask

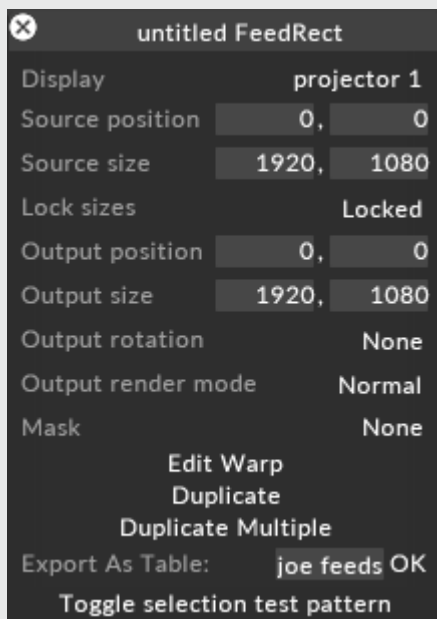

This will open the Texture object library which shows all of the still image files saved on your local hard-drive in the **DxTexture** folder. For more information on the **DxTexture** folder and other folders please see the sub-chapter [Placing media files for a project](#).

- In the top-left corner of the library, where it says **new texture** , type in the name of the softedge mask, for example **Output1\_softedge**.
- Hit **Enter** and select the texture type **SoftEdgeTexture**.
  - » Open the Feed level by left-clicking **Feed** from the dashboard (bar at the top of the screen), right-click the appropriate output and select **select mask** from the options list.

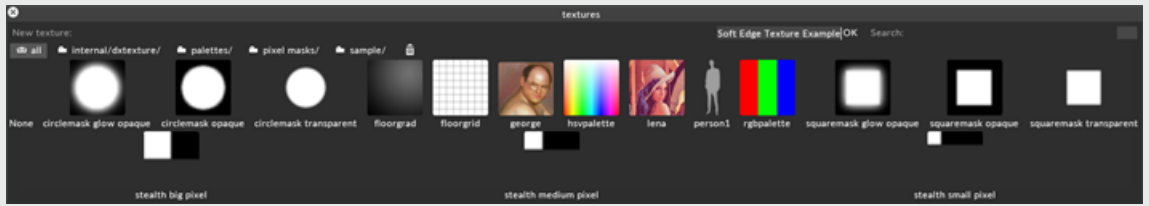

Texture object library being used to create a SoftEdgeTexture mask.

- Create a new Texture, and choose SoftEdge Texture when prompted.

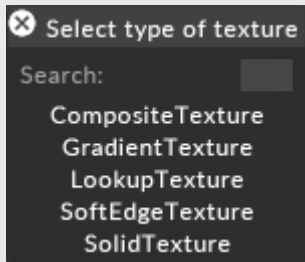

# Softedge editor

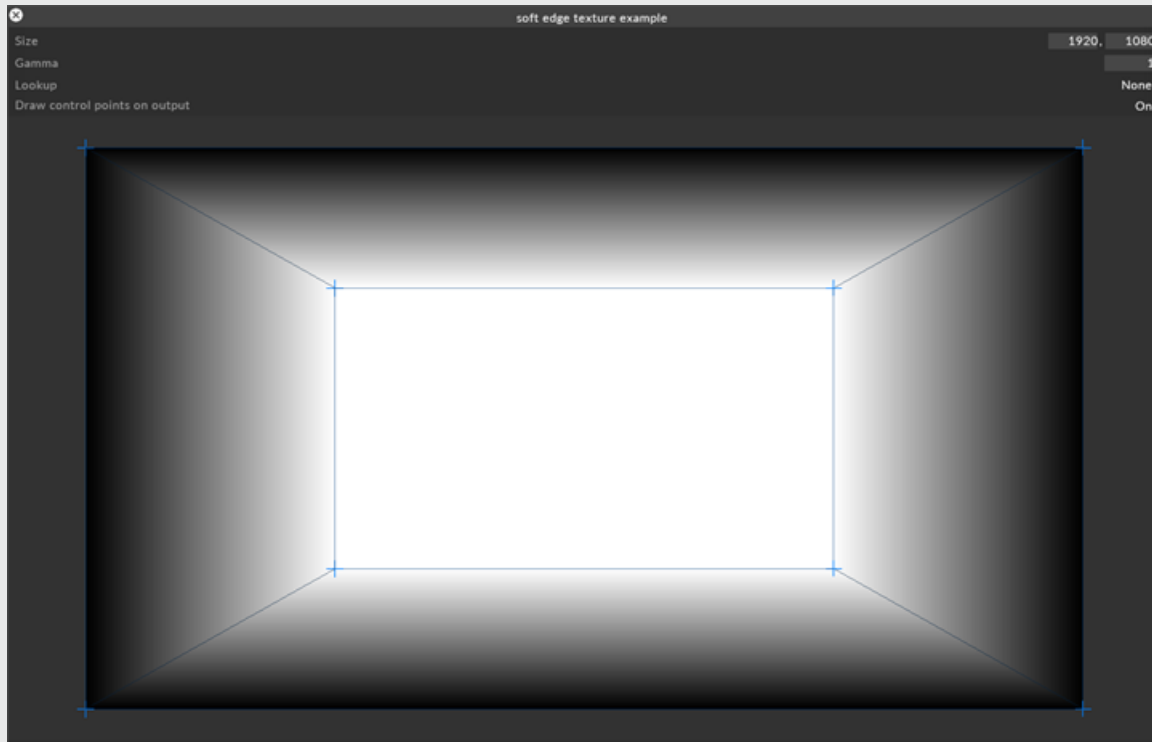

## Resolution

The resolution values are shown in the top right corner of the softedge editor. The resolution is automatically set to the resolution of the output head.

## Adjust global gradients through gamma

The **gamma** value adjusts the global gradient between the inner and outer points in the softedge mask.

## Select and move points

- Select individual points, pairs of inner and outer points, or drag-select multiple points to adjust the blend level.

## Add and remove points

- Add more points by holding down **Ctrl** and left-clicking between existing points.
- Remove points by right-clicking a point.

## Adjust local gradients

- Adjust the gradient between an inner and outer point by dragging them further apart, or closer together.

**Please note:** press **Esc** to exit texture editing. Right-click the output feed and select 'Edit mask (Name) to edit the texture again.

## Create a mask rather than a softedge

- To create a mask rather than a softedge, set either **gamma** to 0 (this will set a sharp edge between the inner and outer points regardless of spacing between them) or move the inner and outer points closer together.

## Composite multiple textures

Disguise allows the user to generate two different textures and composite them into one single texture. To do this:

- Create two different textures (they do not have to be of the type **SoftEdgeTexture** but can also be of the types **GradientTexture** and **SolidTexture**).
- Repeat the same process as above when creating a texture but this time choose the texture type **CompositeTexture** and name it, for example, **SoftEdge\_output1** and **Gradient\_output1**.
- After creating the the CompositeTexture textures, their corresponding outputs will turn grey. This is because the CompositeTexture textures need to be told what textures they contain.
- Right-click the output head and select edit mask (**SoftEdge\_output1**) and edit mask (**Gradient\_output1**) in the options window.
- Set the resolution of the CompositeTexture texture.
- Add the first texture by left-clicking **add new layer**, and then selecting the image from the Texture library.
- Click **add new layer** again and select the second image.
- To multiply the two images together, set the blend mode of image two to **multiply** .
- Press **Esc** to exit texture editing.

# Dynamic Blend

Dynamic Blend is a feature of Disguise software that enables automatic calculation of soft edge blends across projectors automatically. The Disguise software can do this as long as it has accurate information of where the projector is in 3D space.

## Enabling Dynamic Blend

- Right click the stage editor from the dashboard  
or alternatively  
Right click the stage floor
- Expand the **Projectors** tab

Left click the Dynamic Blend property and set it to **On**

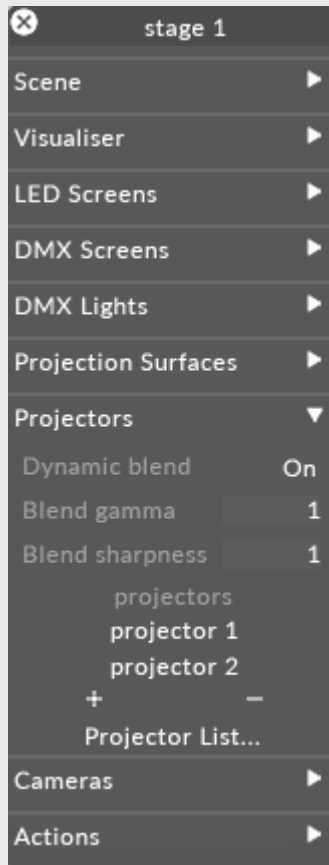

## Global Dynamic Blend Settings

### Blend Gamma

Blend Gamma controls the gamma curve and should be matched to the same as the physical projectors.



## Blend Sharpness

Controls the size of the blend zones created; the higher the number, the smaller the blend zones.

## Projector Level Dynamic Blend Settings

There are further controls for Dynamic Blend within the individual projector settings.

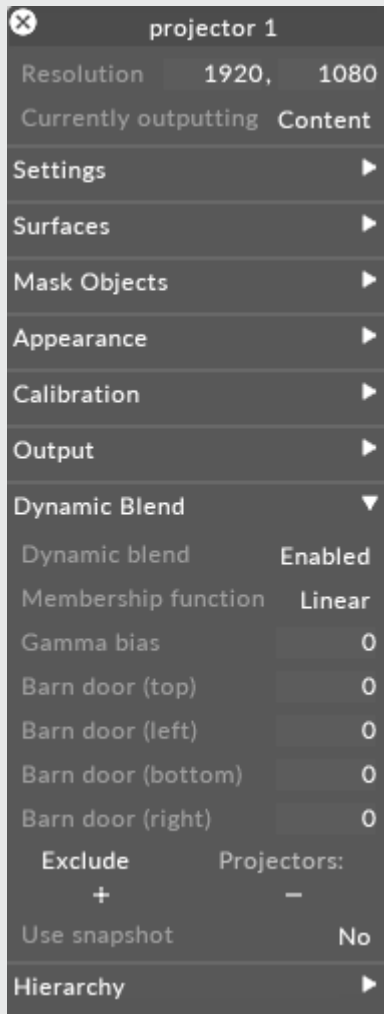

## Dynamic Blend

Enabled/Disabled. This allows you to enable or disable dynamic blend on individual projectors.

## Membership Function

Linear/Radial/Linear to Radial. This controls how the blend is calculated for the individual projector.

## Gamma bias

This adjusts the gamma bias of the individual projector relative to the gamma set in the stage editor.

Barn Door top/left/bottom/right

## Include/Exclude list

See the [Include/Exclude topic](#)

## Use Snapshot

Yes/No. This allows you to snapshot the soft edge mask generated by dynamic blend, edit it in external program, then have it re-applied to the projector. The texture files will appear in the DxTexture folder.

# Include Exclude list

The include & exclude functionality found under the dynamic blend tab of a projectors properties, is specifically for use when dynamic blending large numbers of projectors. Dynamic blend has a limit of 12 projectors, so when going beyond 12 the include/exclude functionality allows you to specifically defined which projectors blend with which other projectors.

When using this functionality, you should stick to using either include or exclude per group of projectors.

## Using the Include & Exclude list

- Right click on a projector to edit its properties
- Expand the Dynamic Blend tab
- Left click Exclude to choose between either Exclude or Include
- Select the other projectors that this projector should include or exclude blending with

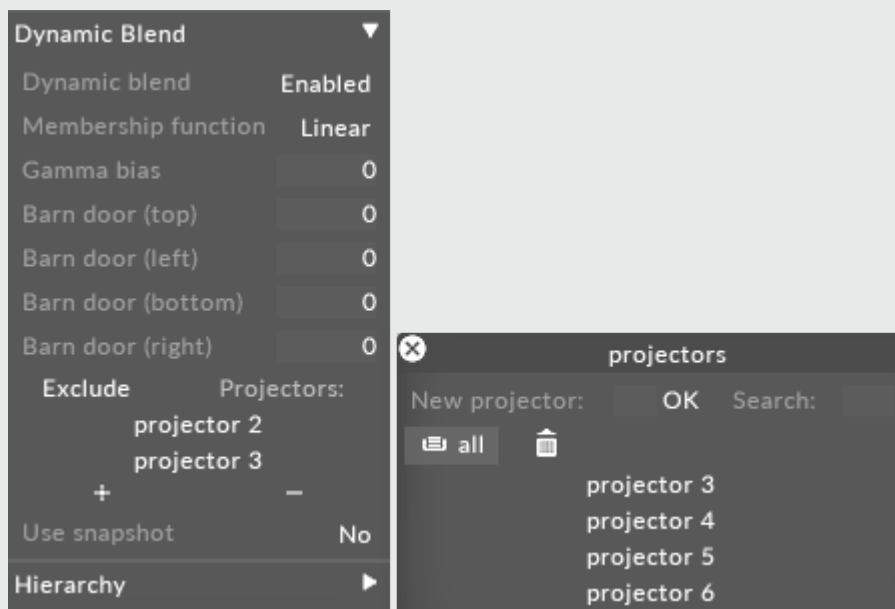

# Quick Calibration overview

This sub-chapter explains the process of using QuickCal to line up projectors to real world screens.

## QuickCal overview

QuickCal is a user-driven process of calibrating a virtual projector's position, orientation and lens properties to match the real-world projector. QuickCal is based on reference points on given 3D meshes for a projector's target surfaces, and user-defined 2D image coordinates that are manually assigned to these 3D reference points. As long as the 3D meshes are good matches to the real-world projection surfaces, QuickCal can accurately calculate the projector parameters.

The basic process of QuickCal is relatively simple : drop reference points onto the 3D model of the projection surface, and then 'line up' by dragging each point in the projector's output raster until it hits the corresponding point on the real surface. Once you've done enough points (about 10-15 per projector) Disguise software can work out exactly where the projector is, and what lens qualities it has.

## 3D mesh accuracy

When calibrating projectors using QuickCal it is **crucial** that the 3D mesh object is modelled accurately to the physical model. The reason for this is that Disguise's calibration algorithm assumes that the virtual reference points link exactly to their corresponding real-world points. The best way to generate a highly accurate 3D model is to laser scan the physical model, or to laser cut the physical model based on the same 3D file you later use in Disguise software. For building projections we recommend a mesh with a +/- 5mm error margin.

## Using QuickCal

To start using QuickCal, first move the virtual projector into roughly the right position and orientation, and set up its lens qualities to roughly match the real projector. You don't have to be particularly accurate in this, but when you're trying to select projectors in the visualiser for editing, it's easier when they're in roughly the right place. Then move on to creating reference points, and then line them up.

# Tips & tricks

## General QuickCal background information

The calibration goal is to calculate a projector's projection matrix so that it produces physically valid projections on its assigned projection surfaces in the real world (the scene). This means that the matrix does not need to be absolutely physically correct, but should be correct for at least this projection area (or rather volume). Indeed, it helps to think of the calibration as a process that works on a volume in space, rather than on 2-dimensional surfaces.

The calibration process uses as main inputs:

### **3D Reference Points (in world space)**

These are usually created from vertices of the mesh/object. Note that the mesh needs to match the real object, at least in the vertices used for creating Reference Points. In d3 Reference Points are 3D objects themselves, and a certain point can be used by several Projectors.

### **2D coordinates (in the projector image plane)**

These are created during line up of a Reference Point in a given Projector. In Disguise software the Projector Configuration stores a pair that links the 2D coordinate to the 3D Reference Point.

## Projection matrix

The projection matrix is a linear transformation that represents the projector's position, orientation and internal sensor and lens properties. Note that Disguise software currently does not support correction of non-linear lens distortion in QuickCal. Lens distortion is only calculated and compensated for in OmniCal.

In Disguise software the projection matrix is applied to all 3D meshes in the Surfaces list, so they get transformed and projected on to the virtual Projector's image plane. This creates the projector's output image that is visible in the Feed Scene.

# Choice of Reference Points and Order of line-ups

A Reference Point and the 2D line-up coordinate together form a correspondence point pair. Several such pairs are required for a calibration. QuickCal supports several algorithms that have different requirements on the minimum number of points (e.g. 4, 6, or more).

It doesn't matter for the calibration itself which object/mesh the Reference Points come from, as long as that 3D point exists in the real world as a recognisable feature. Object corners are usually good choices.

It is possible to use Reference Points from several objects for a single Projector.

Important requirements are:

- The real-world equivalents of the Reference Points are actually visible by the physical projector (lie inside its light cone).
- All Reference Points that are used for a projector:
  - » span a large enough 3D volume. Often this is referred to as "adding enough depth". The main issue is to ensure that the Reference Points do not all lie on the same (virtual) plane in 3D space.
  - » should evenly cover a large enough area in the Projector's image. It's a good idea to use Reference Points that get lined-up in all four corners of the projector output image.

Additionally, if you want to verify the wireframe of an object during QuickCal line-up, then the objects needs to be added to the Projector's Surfaces list.

It is worth to keep in mind that calibrating creates a working volume for a projector, using the 3D Reference Points as a helper. So the volume in which the projector "is valid in" is always limited by the extent of Reference Points you have lined up. As an example, lining up 6 points that are all in the same image corner of the projector will likely produce a calibrated matrix that doesn't work well for the rest of the image. The same goes for points that are in close proximity in the real world, i.e. the calibrated matrix will only be valid in the small volume within those points.

The order in which Reference Points are created and lined up does not affect the calculation of the projection matrix. The calibration will produce the same result no matter what points are lined up first.

However, to help the calibration work out things faster, it makes sense to line up Reference Points from extreme parts of the scene first, before adding points that are closer to each other. Otherwise there may not be a good visual output until enough points are lined up so that they cover the whole scene with enough depth.

## Short QuickCal Rules

1. Leave the Calibration Method setting at Auto, unless you really have a good reason to force a specific algorithm. Auto will choose the best algorithm based on how many Reference Points you have, and what their 3D relationship is.
2. Don't "cheat" with your line-up coordinates unless you absolutely have to.
3. Never "cheat" until all Reference Points have been added and lined-up.
4. Line up the extreme parts of the mesh(es) and projector image first (e.g. image corners Left/Right/Top/Bottom and Close/Far in the scene). Then improve on that by adding more points. E.g. concentrate on Reference Points in areas where the projected images are still "off" when looking at the real object.

## Limited Scene Depth and number of Reference Points

Meshes/Objects that are flat or have little depth are more difficult to use for calibration. This is even more problematic if the real world object has few or no visible features, like a wall where only 4 corners are easily usable as Reference Points.

However, with 4 correspondence point pairs it's already possible to do a simple calibration (usually IterLM algorithm). This calibration is not able to calculate internal lens parameters such as lens shift or throw ratio. It will take values for these parameters from the manual projector settings. Note that these settings are still editable when using QuickCal with under 6 points, or if certain algorithms are set. It

can be difficult to get these values right by hand, but if the throw ratio and lens shift of the physical projector is roughly known, then adjusting this can help improve the calibration significantly.

With 6 or more correspondence point pairs a different algorithm is used (usually Zhang algorithm), which also calculates lens shift and throw ratio parameters automatically. If the Reference Points provide little or no depth, then this algorithm has problems finding a good projector matrix. This is because mathematically it is very difficult to differentiate between some internal lens parameters and 3D parameters. For example throw ratio (or focal length, if you prefer) and distance to an object are interchangeable to a certain degree. Think of the famous Dolly Zoom effect used by Hitchcock in the film "Vertigo", where the face always stays the same size, only fore- and background objects get smaller or disappear). This ambiguity can only be resolved by more depth. It is necessary to line up more points from the scene background/foreground to constrain the calibration better, essentially thereby increasing the calibration volume.

In practice, it may be preferable in certain rare situations to stick with 4 or 5 points, rather than adding a 6th, because the switch to the different algorithm may make the visual result worse rather than better.

## Correspondence Point influence on calibration

A correspondence point pair is not like guide points for splines, or a fixed warp or rule that associates the two to each other.

Instead, they are inputs into an iterative algorithm that tries to solve a matrix so that all of these point pair conditions are (more or less) satisfied. But due to mesh/ reality discrepancies, line-up inaccuracies, constraints of the optical model, even rounding errors, etc. there will never be a perfect matrix that fits all these pairs. There are many matrices though that will be good enough, so that the error for each of these point pairs is small (e.g. ideally below 1 pixel). If the inaccuracies in the input data are high, then some correspondence point pairs will basically contradict each other strongly. In that case the overall error will be high, too (e.g. 5-10 pixels, or even more). If the error is due to mesh/object discrepancies, then "cheating" might help (see below).

## Cheating

If the 3D model and the physical object don't match exactly, then QuickCal allows to "cheat" a bit. "Cheating" isn't recommended, but often it's not possible to get a better 3D model while being on-site.

There are several ways to "cheat":



- Moving the line-up cursor slightly off from where it should be, so that the overall calibration looks better and the reprojection error gets smaller.

Note that the advanced option 'Disable reference point bounds' allows moving the 2D line-up coordinate outside of the projector's image, e.g. to a negative value.

- Moving a 3D Reference Point away from its original vertex position. In QuickCal this can be done in "Manage" mode by holding the Shift key and moving the 3D Reference Point left, right, up or down. This will move the point in 3D space according to the current visualiser view, and allows placing the point in a non-vertex position. By default, Reference Points snap to the nearest mesh vertex, indicated by a green cross.

The problem with any of these tricks is to know which Reference Points to cheat with, and how it eventually affects the calibration.

# Quick Calibration overview

This sub-chapter explains the process of using QuickCal to line up projectors to real world screens.

## QuickCal overview

QuickCal is a user-driven process of calibrating a virtual projector's position, orientation and lens properties to match the real-world projector. QuickCal is based on reference points on given 3D meshes for a projector's target surfaces, and user-defined 2D image coordinates that are manually assigned to these 3D reference points. As long as the 3D meshes are good matches to the real-world projection surfaces, QuickCal can accurately calculate the projector parameters.

The basic process of QuickCal is relatively simple : drop reference points onto the 3D model of the projection surface, and then 'line up' by dragging each point in the projector's output raster until it hits the corresponding point on the real surface. Once you've done enough points (about 10- 15 per projector) Disguise software can work out exactly where the projector is, and what lens qualities it has.

## 3D mesh accuracy

When calibrating projectors using QuickCal it is **crucial** that the 3D mesh object is modelled accurately to the physical model. The reason for this is that Disguise's calibration algorithm assumes that the virtual reference points link exactly to their corresponding real-world points. The best way to generate a highly accurate 3D model is to laser scan the physical model, or to laser cut the physical model based on the same 3D file you later use in Disguise software. For building projections we recommend a mesh with a +- 5mm error margin.

## Using QuickCal

To start using QuickCal, first move the virtual projector into roughly the right position and orientation, and set up its lens qualities to roughly match the real projector. You don't have to be particularly accurate in this, but when you're trying to select projectors in the visualiser for editing, it's easier when they're in roughly the right place. Then move on to creating reference points, and then line them up.

## Tips & tricks

# General QuickCal background information

The calibration goal is to calculate a projector's projection matrix so that it produces physically valid projections on its assigned projection surfaces in the real world (the scene). This means that the matrix does not need to be absolutely physically correct, but should be correct for at least this projection area (or rather volume). Indeed, it helps to think of the calibration as a process that works on a volume in space, rather than on 2-dimensional surfaces.

The calibration process uses as main inputs:

### **3D Reference Points (in world space)**

These are usually created from vertices of the mesh/object. Note that the mesh needs to match the real object, at least in the vertices used for creating Reference Points. In d3 Reference Points are 3D objects themselves, and a certain point can be used by several Projectors.

### **2D coordinates (in the projector image plane)**

These are created during line up of a Reference Point in a given Projector. In Disguise software the Projector Configuration stores a pair that links the 2D coordinate to the 3D Reference Point.

## Projection matrix

The projection matrix is a linear transformation that represents the projector's position, orientation and internal sensor and lens properties. Note that Disguise software currently does not support correction of non-linear lens distortion in QuickCal. Lens distortion is only calculated and compensated for in OmniCal.

In Disguise software the projection matrix is applied to all 3D meshes in the Surfaces list, so they get transformed and projected on to the virtual Projector's image plane. This creates the projector's output image that is visible in the Feed Scene.

# Choice of Reference Points and Order of line-ups

A Reference Point and the 2D line-up coordinate together form a correspondence point pair. Several such pairs are required for a calibration. QuickCal supports several algorithms that have different requirements on the minimum number of points (e.g. 4, 6, or more).

It doesn't matter for the calibration itself which object/mesh the Reference Points come from, as long as that 3D point exists in the real world as a recognisable feature. Object corners are usually good choices.

It is possible to use Reference Points from several objects for a single Projector.

Important requirements are:

- The real-world equivalents of the Reference Points are actually visible by the physical projector (lie inside its light cone).
- All Reference Points that are used for a projector:
  - » span a large enough 3D volume. Often this is referred to as "adding enough depth". The main issue is to ensure that the Reference Points do not all lie on the same (virtual) plane in 3D space.
  - » should evenly cover a large enough area in the Projector's image. It's a good idea to use Reference Points that get lined-up in all four corners of the projector output image.

Additionally, if you want to verify the wireframe of an object during QuickCal line-up, then the objects needs to be added to the Projector's Surfaces list.

It is worth to keep in mind that calibrating creates a working volume for a projector, using the 3D Reference Points as a helper. So the volume in which the projector "is valid in" is always limited by the extent of Reference Points you have lined up. As an example, lining up 6 points that are all in the same image corner of the projector will likely produce a calibrated matrix that doesn't work well for the rest of the image. The same goes for points that are in close proximity in the real world, i.e. the calibrated matrix will only be valid in the small volume within those points.

The order in which Reference Points are created and lined up does not affect the calculation of the projection matrix. The calibration will produce the same result no matter what points are lined up first.

However, to help the calibration work out things faster, it makes sense to line up Reference Points from extreme parts of the scene first, before adding points that are closer to each other. Otherwise there may not be a good visual output until enough points are lined up so that they cover the whole scene with enough depth.

## Short QuickCal Rules

1. Leave the Calibration Method setting at Auto, unless you really have a good reason to force a specific algorithm. Auto will choose the best algorithm based on how many Reference Points you have, and what their 3D relationship is.
2. Don't "cheat" with your line-up coordinates unless you absolutely have to.
3. Never "cheat" until all Reference Points have been added and lined-up.
4. Line up the extreme parts of the mesh(es) and projector image first (e.g. image corners Left/Right/Top/Bottom and Close/Far in the scene). Then improve on that by adding more points. E.g. concentrate on Reference Points in areas where the projected images are still "off" when looking at the real object.

## Limited Scene Depth and number of Reference Points

Meshes/Objects that are flat or have little depth are more difficult to use for calibration. This is even more problematic if the real world object has few or no visible features, like a wall where only 4 corners are easily usable as Reference Points.

However, with 4 correspondence point pairs it's already possible to do a simple calibration (usually IterLM algorithm). This calibration is not able to calculate internal lens parameters such as lens shift or throw ratio. It will take values for these parameters from the manual projector settings. Note that these settings are still editable when using QuickCal with under 6 points, or if certain algorithms are set. It

can be difficult to get these values right by hand, but if the throw ratio and lens shift of the physical projector is roughly known, then adjusting this can help improve the calibration significantly.

With 6 or more correspondence point pairs a different algorithm is used (usually Zhang algorithm), which also calculates lens shift and throw ratio parameters automatically. If the Reference Points provide little or no depth, then this algorithm has problems finding a good projector matrix. This is because mathematically it is very difficult to differentiate between some internal lens parameters and 3D parameters. For example throw ratio (or focal length, if you prefer) and distance to an object are interchangeable to a certain degree. Think of the famous Dolly Zoom effect used by Hitchcock in the film "Vertigo", where the face always stays the same size, only fore- and background objects get smaller or disappear). This ambiguity can only be resolved by more depth. It is necessary to line up more points from the scene background/foreground to constrain the calibration better, essentially thereby increasing the calibration volume.

In practice, it may be preferable in certain rare situations to stick with 4 or 5 points, rather than adding a 6th, because the switch to the different algorithm may make the visual result worse rather than better.

## Correspondence Point influence on calibration

A correspondence point pair is not like guide points for splines, or a fixed warp or rule that associates the two to each other.

Instead, they are inputs into an iterative algorithm that tries to solve a matrix so that all of these point pair conditions are (more or less) satisfied. But due to mesh/ reality discrepancies, line-up inaccuracies, constraints of the optical model, even rounding errors, etc. there will never be a perfect matrix that fits all these pairs. There are many matrices though that will be good enough, so that the error for each of these point pairs is small (e.g. ideally below 1 pixel). If the inaccuracies in the input data are high, then some correspondence point pairs will basically contradict each other strongly. In that case the overall error will be high, too (e.g. 5-10 pixels, or even more). If the error is due to mesh/object discrepancies, then "cheating" might help (see below).

## Cheating

If the 3D model and the physical object don't match exactly, then QuickCal allows to "cheat" a bit. "Cheating" isn't recommended, but often it's not possible to get a better 3D model while being on-site.

There are several ways to "cheat":

- Moving the line-up cursor slightly off from where it should be, so that the overall calibration looks better and the reprojection error gets smaller.

Note that the advanced option 'Disable reference point bounds' allows moving the 2D line-up coordinate outside of the projector's image, e.g. to a negative value.

- Moving a 3D Reference Point away from its original vertex position. In QuickCal this can be done in "Manage" mode by holding the Shift key and moving the 3D Reference Point left, right, up or down. This will move the point in 3D space according to the current visualiser view, and allows placing the point in a non-vertex position. By default, Reference Points snap to the nearest mesh vertex, indicated by a green cross.

The problem with any of these tricks is to know which Reference Points to cheat with, and how it eventually affects the calibration.

# Quick Calibrating - Projectors

## Quick calibrating projectors

1. Right-click the projector you wish to line up.
2. Right-click the configuration file to open the QuickCal editor.

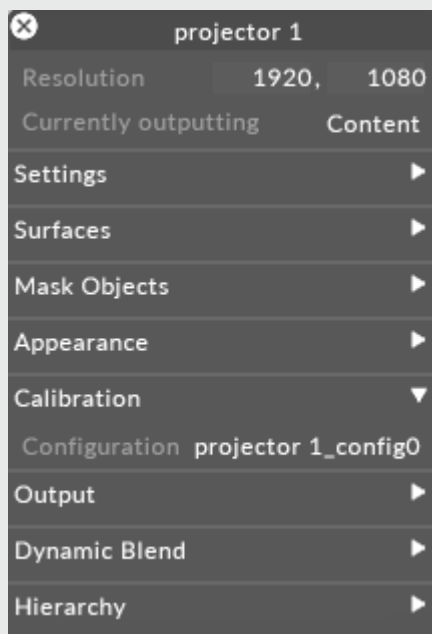

Projector configuration menu.



3. At the top of the QuickCal editor select **line up points**.

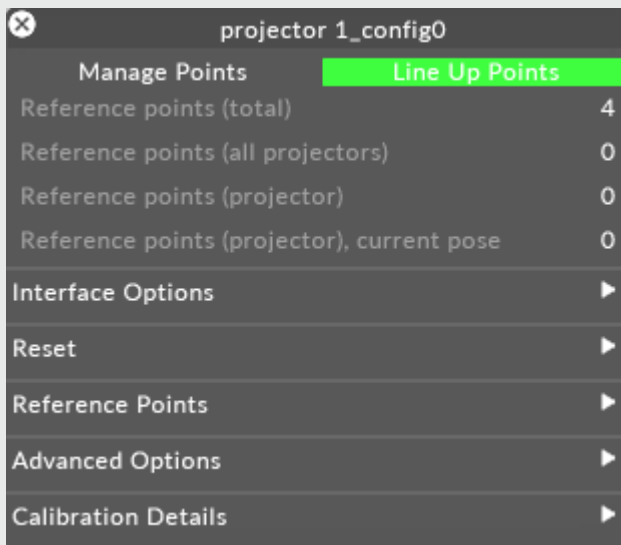

Line up point selection.

**Please note:** You must have the projector you're configuring assigned to an output otherwise the button is greyed-out

4. Left-click a point (representing a reference point on the video screen), hold the left-click and drag the cursor in the output and match it to its physical corresponding point.  
  
Note: The output of the projector you working with will tinted the colour that you have set in the **appearance** tab in the projectors configuration.
5. Once the point is in the right position release the point and now its set.
6. To adjust cursor location using finer increments use the arrow keys to adjust in 1px movements.

When you have adjusted a point it will be displayed in the colour that matches the projectors colour.



Buckingham Palace with points calibrated.

## Remove a reference point from the projector

This will remove the 2D lineup between the selected reference point and the current projector. The reference point itself will not be deleted.

### To remove a reference point:

- Right-click on the reference point that you wish to remove from the projector lineup. The options menu will open.

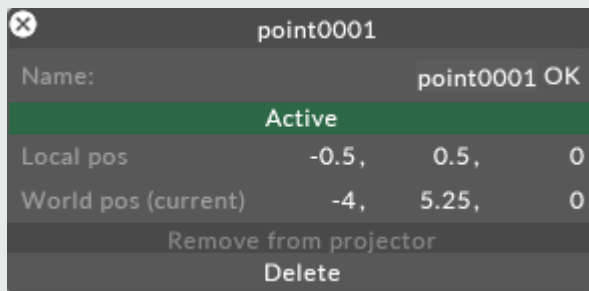

### To remove a reference point from a projector.

- Left-click on the remove from projector button.

## Rotate Controls

This option allows you to rotate your controls whilst lining up, This is especially useful when your projectors are rotated for example if they are portrait in orientation rather than landscape.

There are four options:

- None: Mouse and keyboard operate normally.
- 90 degrees clockwise: mouse and keyboard are rotated 90 degrees clockwise
- 180 degrees: mouse and keyboard are rotated 180 degrees.
- 180 degrees anti-clockwise: mouse and keyboard are rotated 180 degrees anti-clockwise.

## Lineup output mode

Lineup output mode allows you to change what is applied to the output whilst lining up.

**Please note:** During QuickCal lineup all lined up reference points will be drawn on top of the selected output.

You can choose between the following output modes:

- **Content:** Outputs the content that's on the timeline.

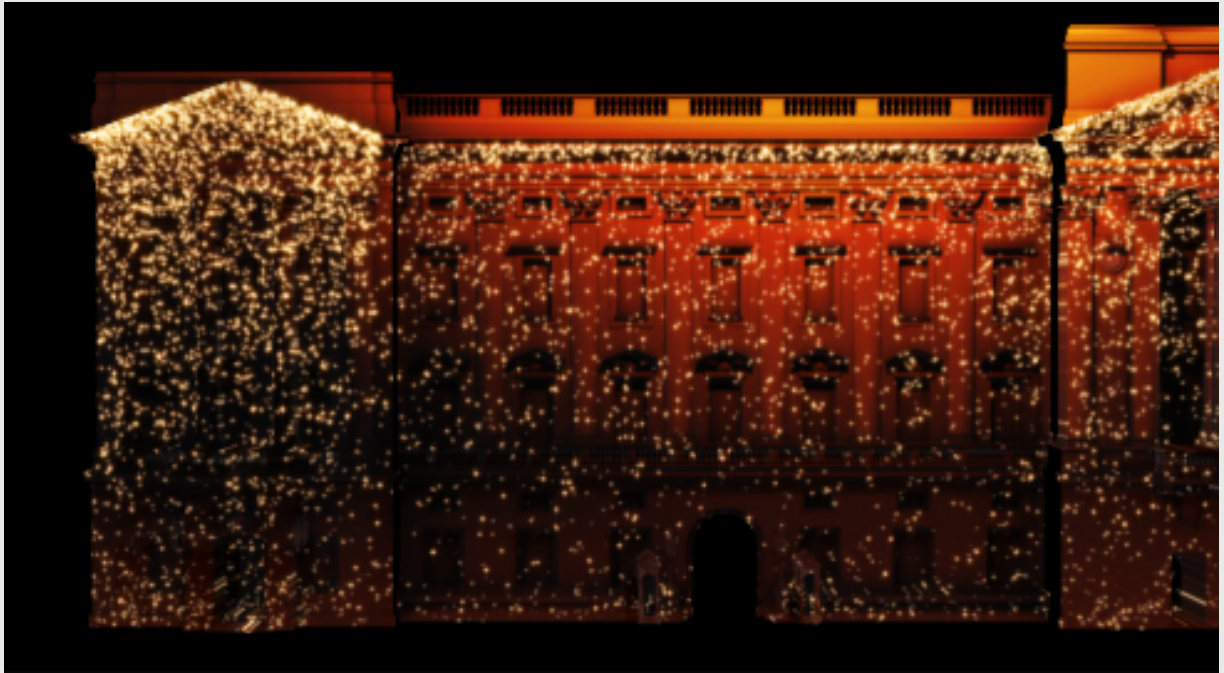

- **Wireframe:** Outputs the wire frame of the model.

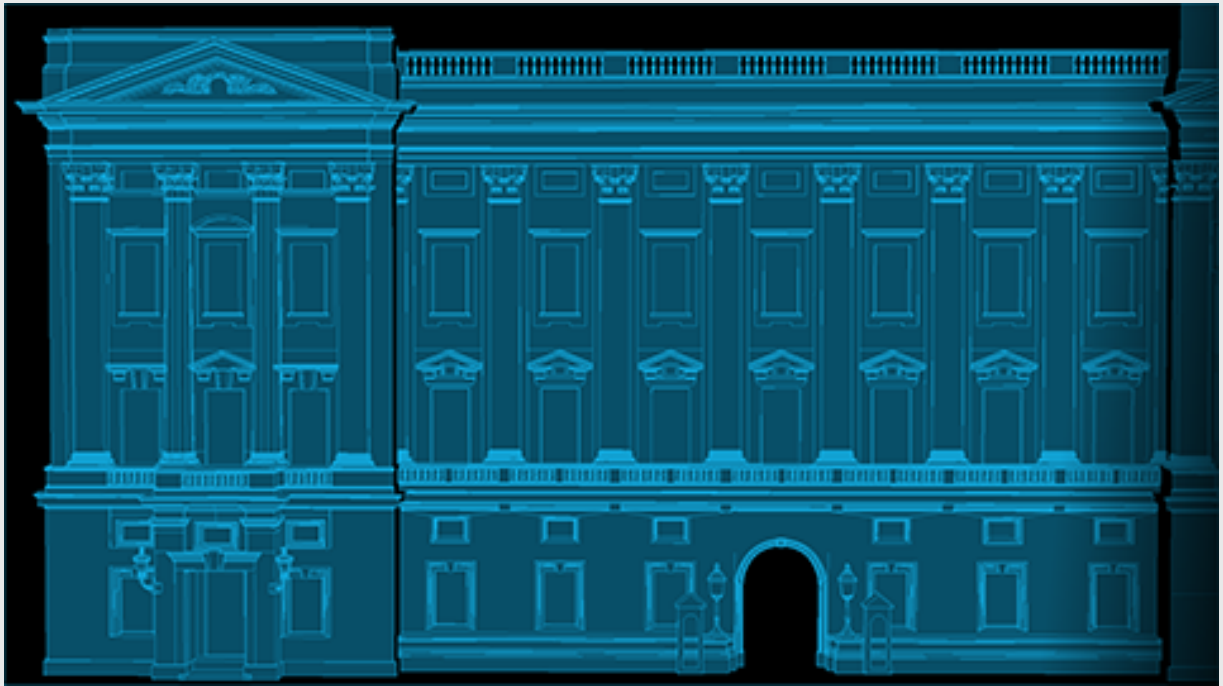

Image of wireframe applied to Buckingham Palace.

- **Identify:** Outputs a full colour grid that has the projectors name on it.



- **Grid:** Outputs a grid that is applied to the model

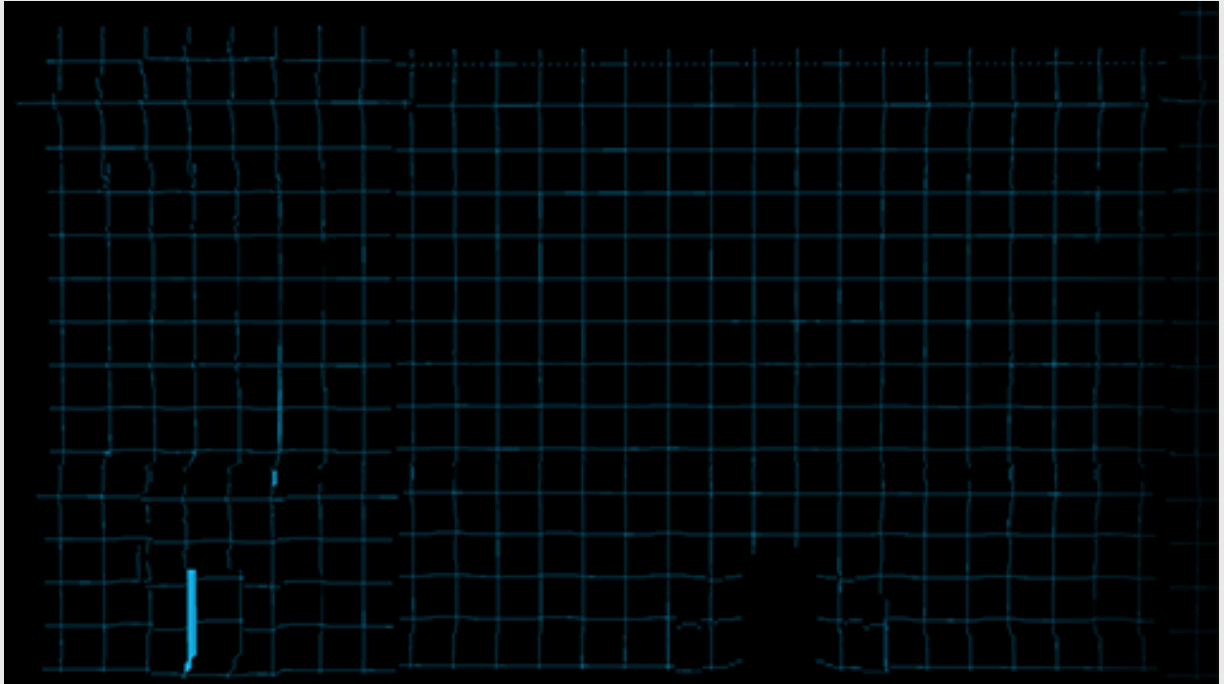

Image of grid pattern applied to Buckingham Palace.

- **None:** Outputs nothing but the line up points.

## Cursor Types

There are four cursor types to choose from:

Horizontal

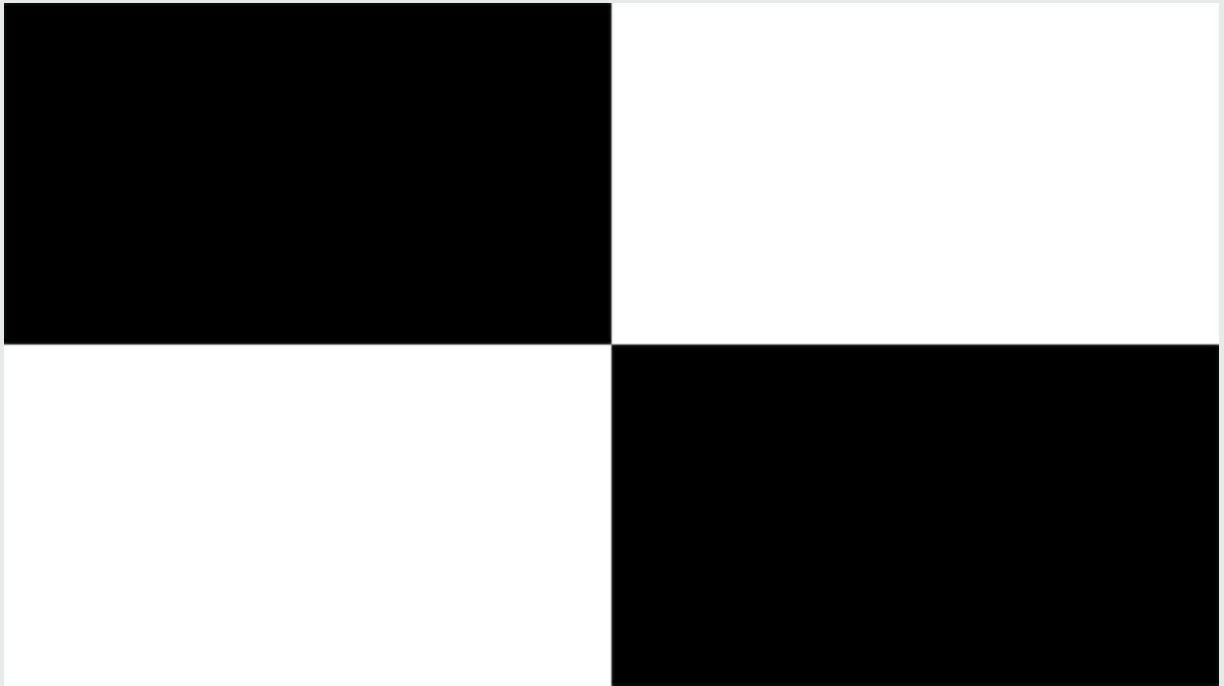

Image of horizontal lineup cursor.

Diagonal

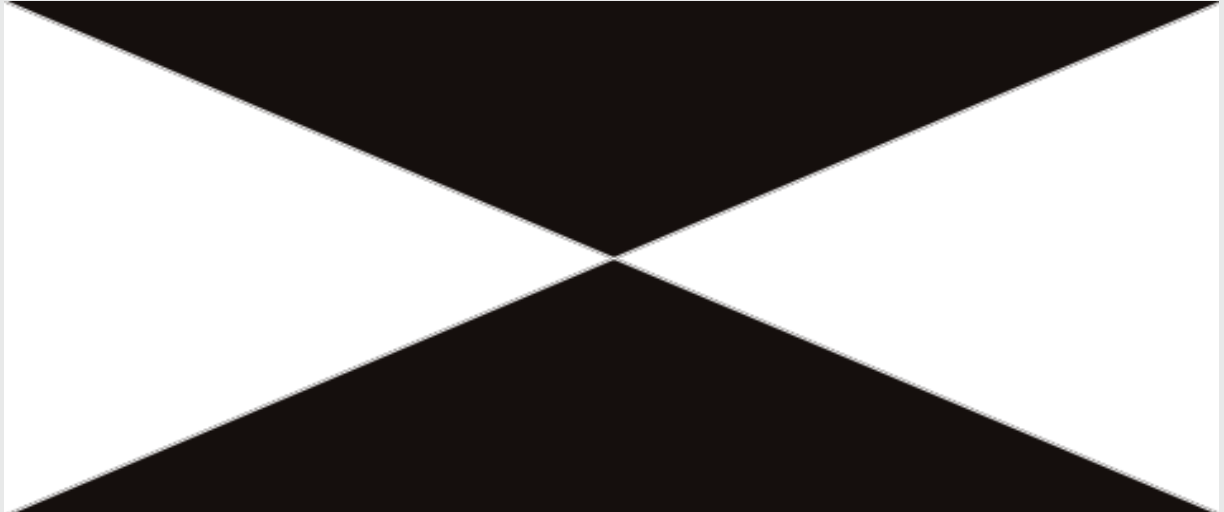

Image of horizontal diagonal cursor.

## Horizontal Lines

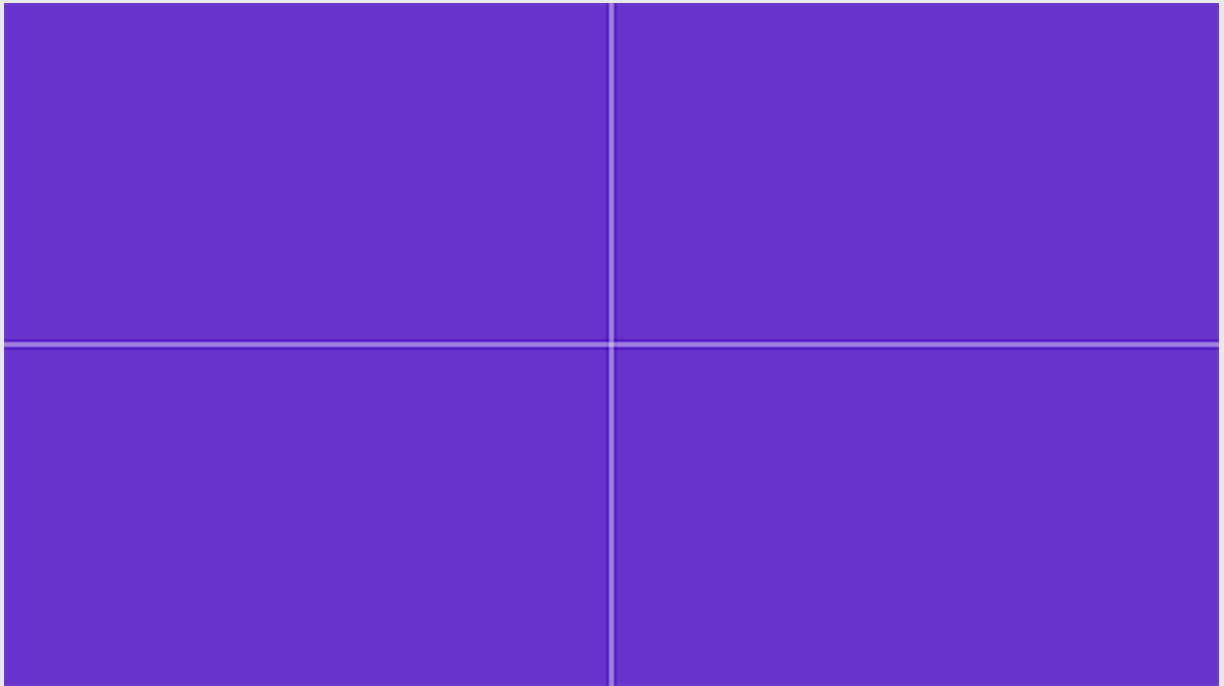

Image of horizontal lines cursor.

## Diagonal Lines

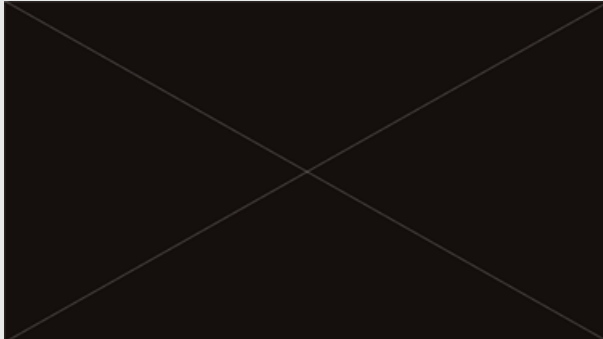

Image of diagonal lines cursor.

## Marker Size

This setting allows you to adjust the size of the marker that's left behind once you have calibrated a point. The default marker size is 16.

## Reset options

To reset the projector so no points have been selected or calibrated either:

- select **reset reference point lineup (current pose)** to reset the points for that pose in a multi-pose line up (see the [Multi-pose calibration](#) sub-chapter for more info on this topic)
- select **reset reference point lineup**

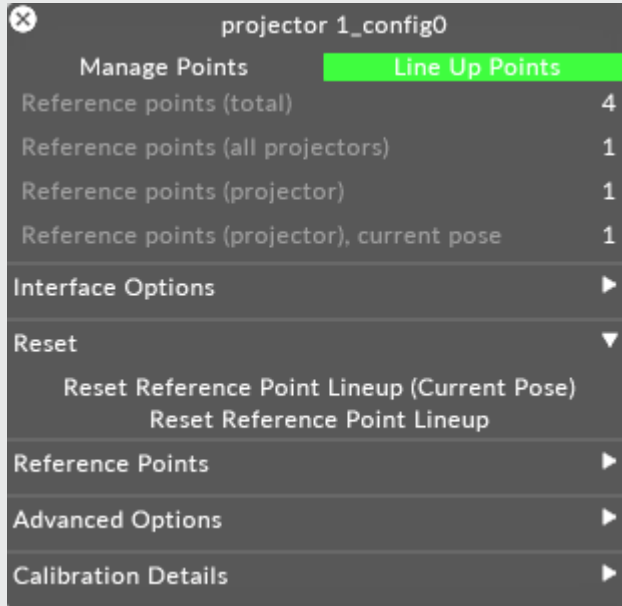

Reset reference point lineup.

- A warning message will pop up when you select **reset projector config**. Click **yes** to **reset projector config**.

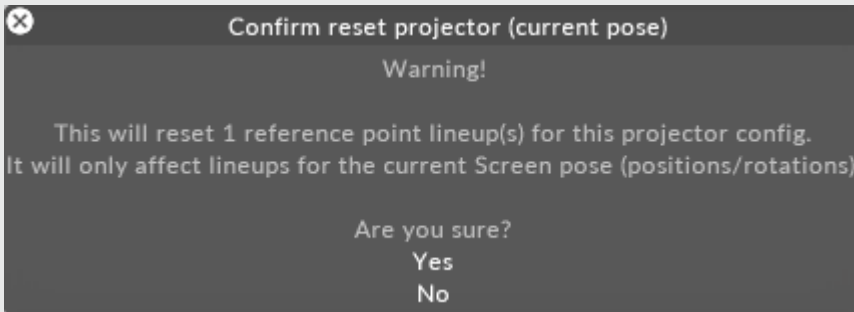

Confirm reset projection config.



## Removing reference points

There are 3 options for removing reference points under the **Reference points** tab:

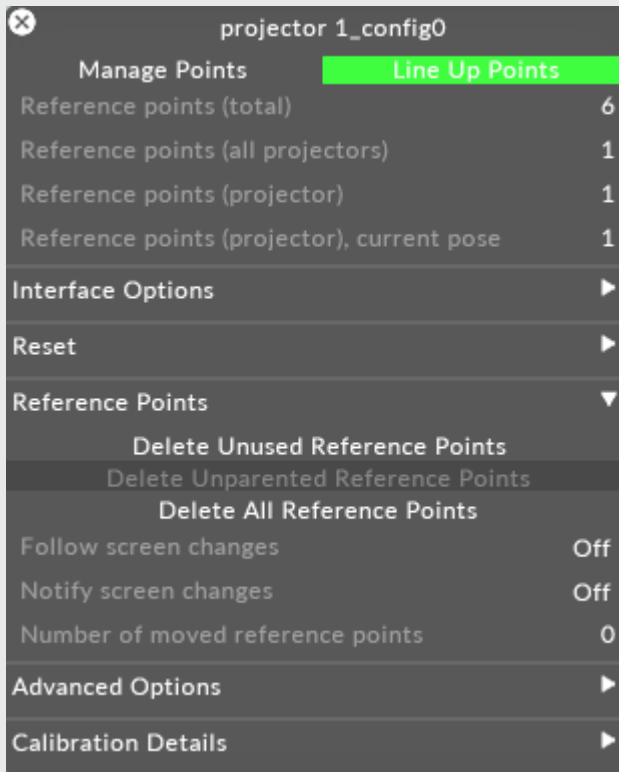

Deleting reference points.

### Delete unused reference points

This option deletes reference points which have not been associated with a projector lineup.

### Delete unparented reference points

This option deletes reference points which are not parented to a screen

### Delete all reference points

This option deletes all reference points from the virtual stage.

A warning message will pop up when you select **delete all reference points**, **Click yes to delete all reference points**.

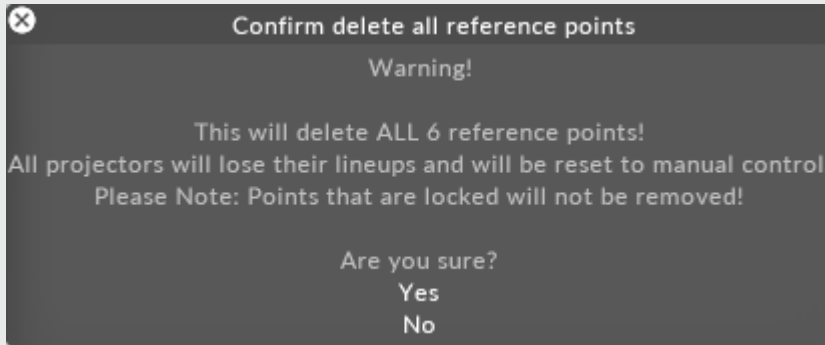

Confirm delete of all reference points.



**Warning:** Delete all reference points is a global action, It will affect all the reference points on the model not just the ones associated with the current projector.

## Advanced options

### Follow screen changes

This option allows you to choose if the reference points follow screen changes. For example if you change your screen position the reference points will move with the screen.



**Warning:** This will automatically update any projector's QuickCal calibration using the new 3D positions of the reference points

## Notify screen changes

This options allows you to choose if you want to be notified of screen changes. For example if the screen position changes and the points move with the screen you will be notified. The notification will ask you whether you want to update the QuickCal calibration with the new 3D positions. It will also show by how much each reference point has moved.

## No. of moved reference points

This informs you how many points have moved with a screen position change for example.

## Auto z-clipping

If auto z-clipping doesn't work, this means some parts of a Screen, which are either very close or very distant, may only be partially visible. then manually adjusting these near/far values can make sure that the projector renders the whole screen.

## Lineup Result

Here is a real world photo of a lineup of Buckingham Palace without the edge blending.



# Creating & deleting reference points

## To create reference points:

1. Open the projector editor.
2. Locate the **Calibration** tab.

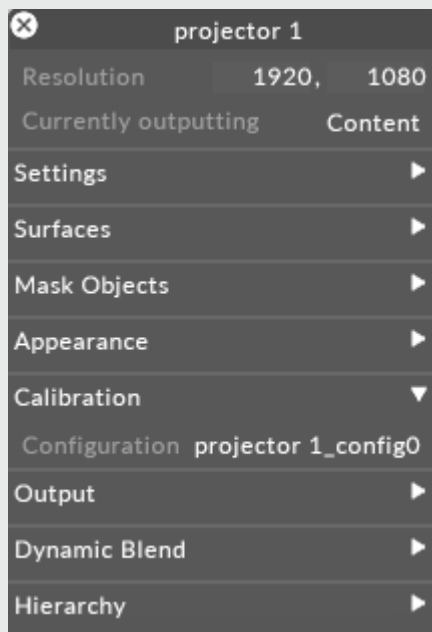

Projector config editor selecting the configuration tab.

3. click the configuration file to open the QuickCal editor. If **left-clicking** you will instead open the Projector Configuration manager which stores all the configuration files for the existing projectors.

4. Select **manage points**.

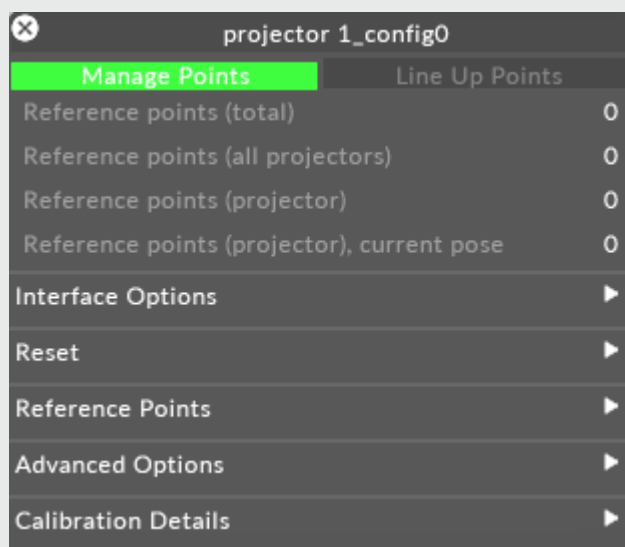

Projector config editor, Selecting manage points.

5. The d3 cursor will now turn in a circle. This indicates that you are in **manage points** mode and when you click on the model a reference point will be created at that location.

**Please note:** The reference points will automatically snap to a vertex near to where you clicked. If you have a really complicated model they may not snap to the correct position select the point you wish to move and hold down the left mouse button to drag it to the desired location.

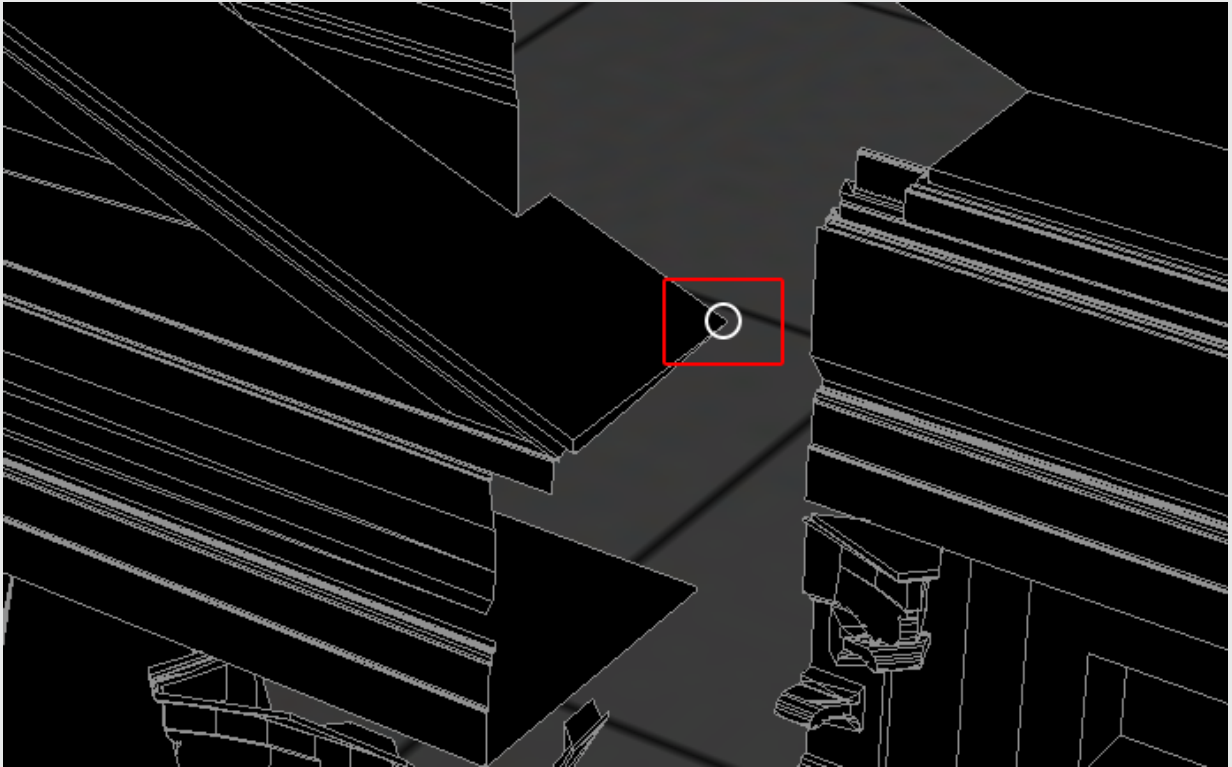

Point creation cursor, Adding a point.

6. Create a minimum of 6 reference points and place them on **clearly** identifiable real-world reference points. This is to make it easier to link the virtual reference points to the corresponding real-world points at a later stage in the lineup process. Usually, there is no need to create more than 6-12 reference points per virtual projector but for more complex geometry it may be necessary to create more. Some complex building mapping projects have required up to 30 reference points per projector.
7. Notice that multiple projectors can use the same reference points.



## To delete a reference point

1. Right-click on the point that you wish to delete.  
The options menu will open.

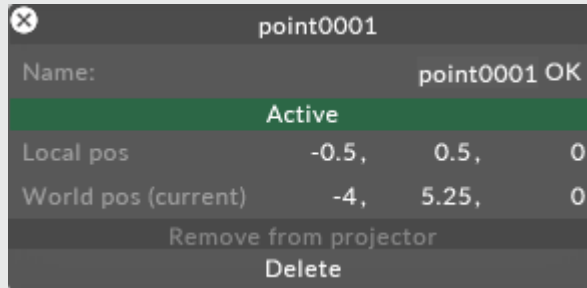

Delete a reference point from the virtual model.

2. Left-click on the **delete** button.



**Warning:** reference points that are lined up in another projector cannot be deleted (since this would affect the other projector's calibration).

# Venues and props overview

## What is a venue?

A stage can contain multiple **venues**. This is useful if you wish to create a range of stage designs, each venue representing a different stage design option, allowing you to quickly change from one design to another (during a client meeting for example). When you create a new project there is already one venue prepared called **venue 1**. It only contains one prop called **Arena**.

## What is a prop?

The venues are constructed from **props**. Props are objects which form the building blocks of your venue. A new project will by default contain a series of props contained in the Mesh object library. These props consist of a range of different buildings, a 3D man and a 3D woman.

Props are **.obj** meshes. If you want to use a prop other than the standard props available in Disguise software, you can import this prop. Please see the Mesh section within the [Editing props](#) sub-chapter for information on how to import a prop mesh into the software.



# Venues and props overview

## What is a venue?

A stage can contain multiple **venues**. This is useful if you wish to create a range of stage designs, each venue representing a different stage design option, allowing you to quickly change from one design to another (during a client meeting for example). When you create a new project there is already one venue prepared called **venue 1**. It only contains one prop called **Arena**.

## What is a prop?

The venues are constructed from **props**. Props are objects which form the building blocks of your venue. A new project will by default contain a series of props contained in the Mesh object library. These props consist of a range of different buildings, a 3D man and a 3D woman.

Props are **.obj** meshes. If you want to use a prop other than the standard props available in Disguise software, you can import this prop. Please see the Mesh section within the [Editing props](#) sub-chapter for information on how to import a prop mesh into the software.

# Creating and removing props

## Creating a prop for a venue

- Right-click **stage** from the dashboard (bar at the top of the screen). This will open the [Stage editor](#).
- Right-click **venue**. This will open up the Props menu which displays a list of all of the active props in the currently active venue.

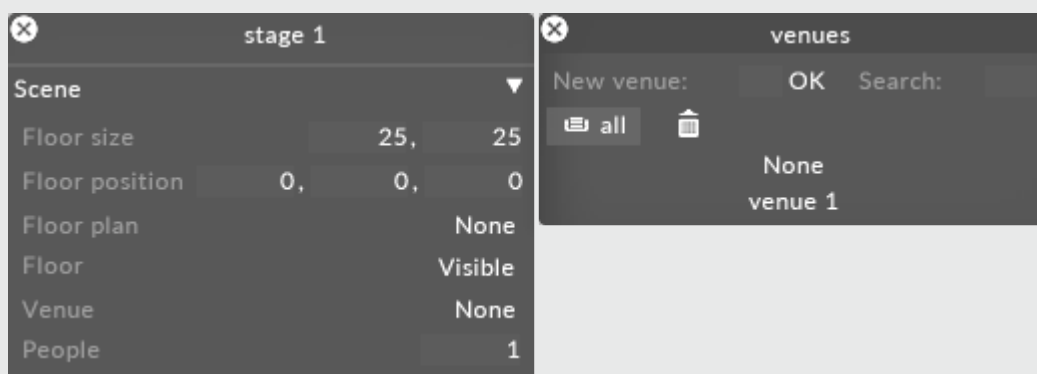

*Process used to open the Props menu which displays all of the active props in the currently active venue*

A new project will by default contain one venue called **venue 1**, which itself will contain one prop called **Arena**.

- Left-click **+**. This will open a Props manager that lists all of your props. It is important to note that the props in this list can be added to either, some, or all of your venues; you do not have to limit

a prop to only one venue.

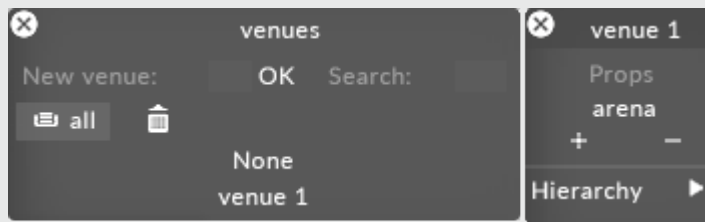

*Props manager opened by left-clicking + from the Props menu*

- Left-click a prop from the Prop manager to add it to the currently active venue, in this example **venue 1**. You can now edit the prop.
- If you wish to create a new prop, type the name of a new prop in the **new prop** text field and hit **Enter**. This will create the prop and add it to the currently active venue.
- Repeat these steps for each prop you wish to add to the currently active venue.

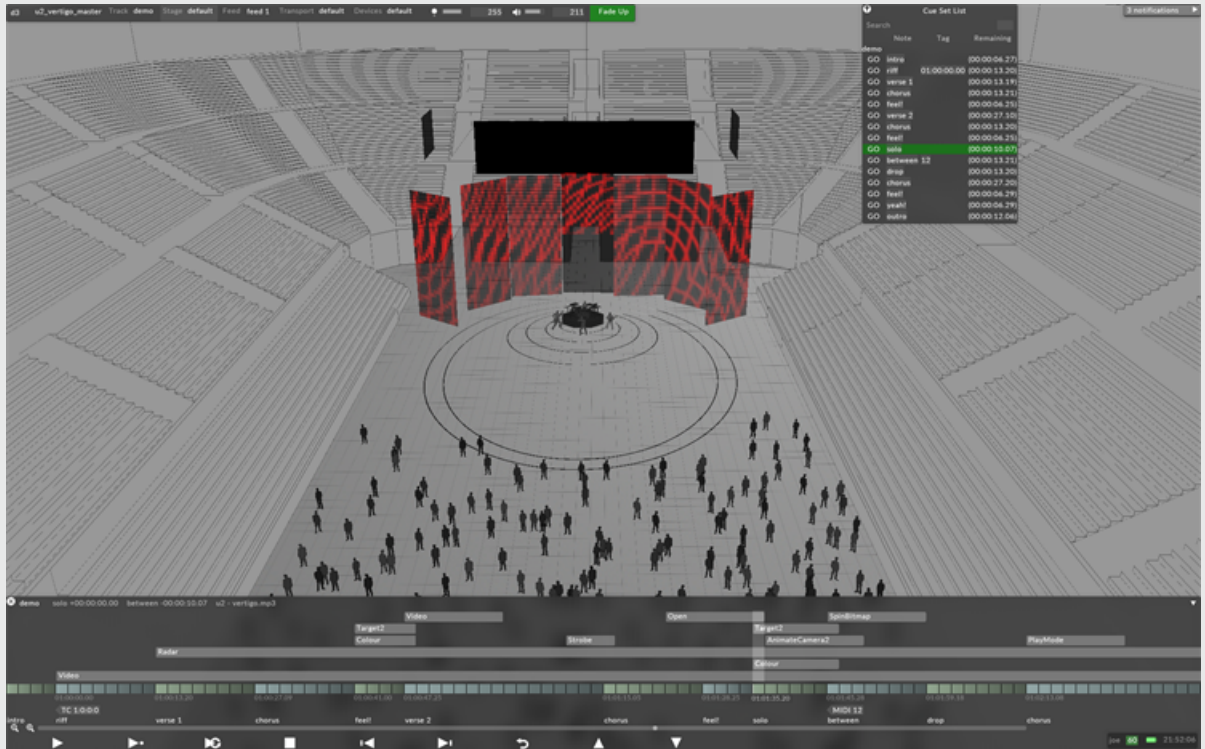

Example of a complete venue imported into the Stage for the U2 Vertigo Tour.

## Removing a prop from a venue

- Left-click and drag a prop, from the prop menu to the - button. This will remove the prop from the prop menu, although the prop itself will not be deleted: it is still listed in the Prop manager. Notice how this change has been updated in the Stage Visualiser.

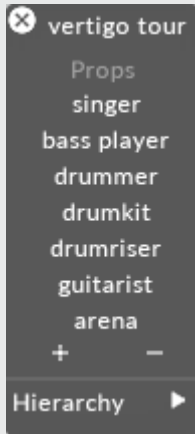

## Permanently deleting a prop



**Warning:** you can never permanently delete a prop if its active or referenced to from anywhere in the project.

- Left-click and drag the prop you want to delete from the Prop manager to **trash** (represented by a trash-can icon).

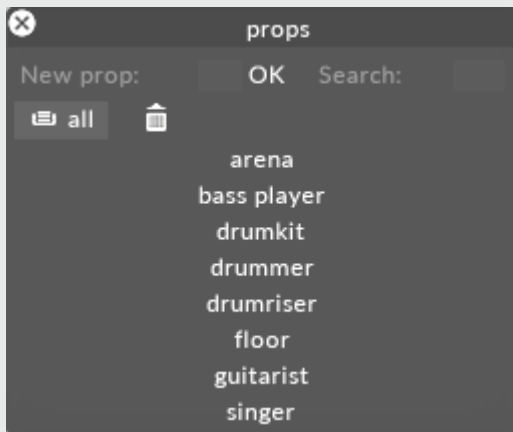

*Left-click and drag the prop you want to delete, from the Props manager to Trash.*

- Right-click **trash** and select **empty trash** to permanently delete the prop from your stage.

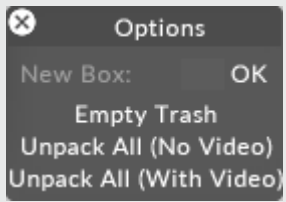

# Editing props

## Editing a prop

- Right-click a prop directly in the Stage level, or
- Right click the prop's name from the list of props in the Props Manager menu. Read the [Creating/Removing props](#) sub-chapter above to learn how to open the Props Manager/Props menu.

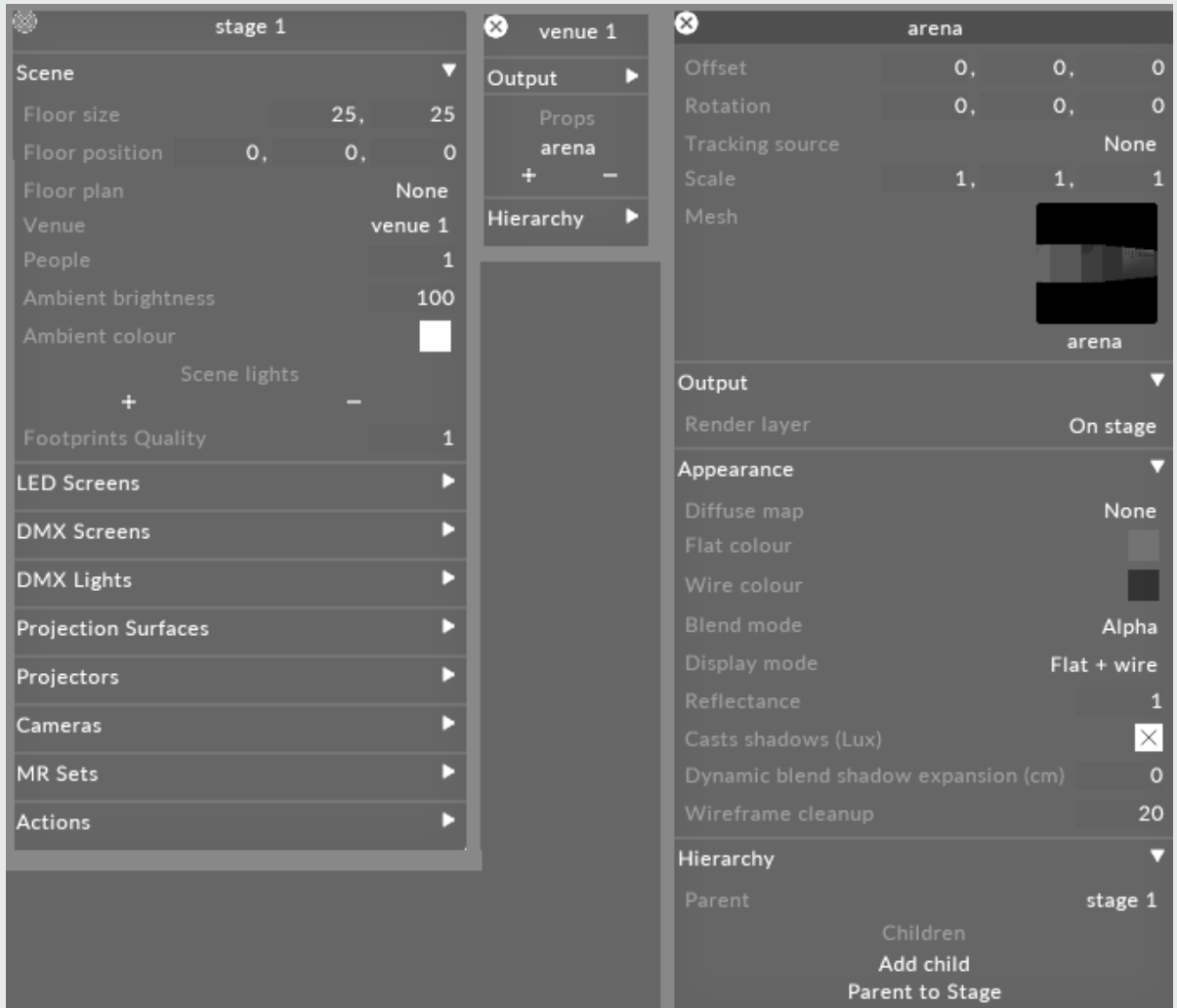

The Prop editor is used to edit a prop, in this example a prop called Arena.

## Prop properties

### Offset



Offset values are expressed in meters and are based on the original prop position along the x, y, z in the 3D application it was exported from.

## Rotation

The rotation value is always based around the origin point in the 3D application it was exported from. For example, if you export a cube which is offset 10m to the right in Blender it will show up 10m to the right in the stage. When you change the rotation values it will rotate around the origin in Disguise, rather than the local origin of the object.

To avoid this, you should export the object at the origin 0,0,0 of your 3D application. Then offset it 10m in the stage. When you rotate the object in Disguise it will now rotate around its local axis.

## Scale

The scale property is a multiplier. It multiplies the prop size with its original size as exported from the 3D application.

## Mesh

This points to the Mesh file that defines the shape of your props. Selecting this property will open the Mesh object library, which shows all of the Mesh **.obj** files saved on your local hard-drive in the **Mesh** folder.



Mesh property being used to update the mesh of a prop from the Mesh object library

To change a prop mesh:

- Left-click **mesh** to open the Mesh object library.
- Left-click the mesh you want to replace the currently active mesh. This will update the prop mesh.

If you want to use any other shape than the standard prop meshes provided in Disguise software, you will need to use a UV-mapped **.obj** file of the prop.

See the [Placing media files for a project](#) sub-chapter to understand where to place a mesh **.obj** file and how to access it in the software. Also save the file to a [supported file format](#).

## Diffuse Map

This points to the Texture file that defines a prop's texture. You can use this property to create and apply a texture to a prop, allowing you to visualise your stage as realistically as possible. Selecting this property will open the Texture object library, which shows all of the still image files saved on your local hard-drive in the **DxTexture** folder.

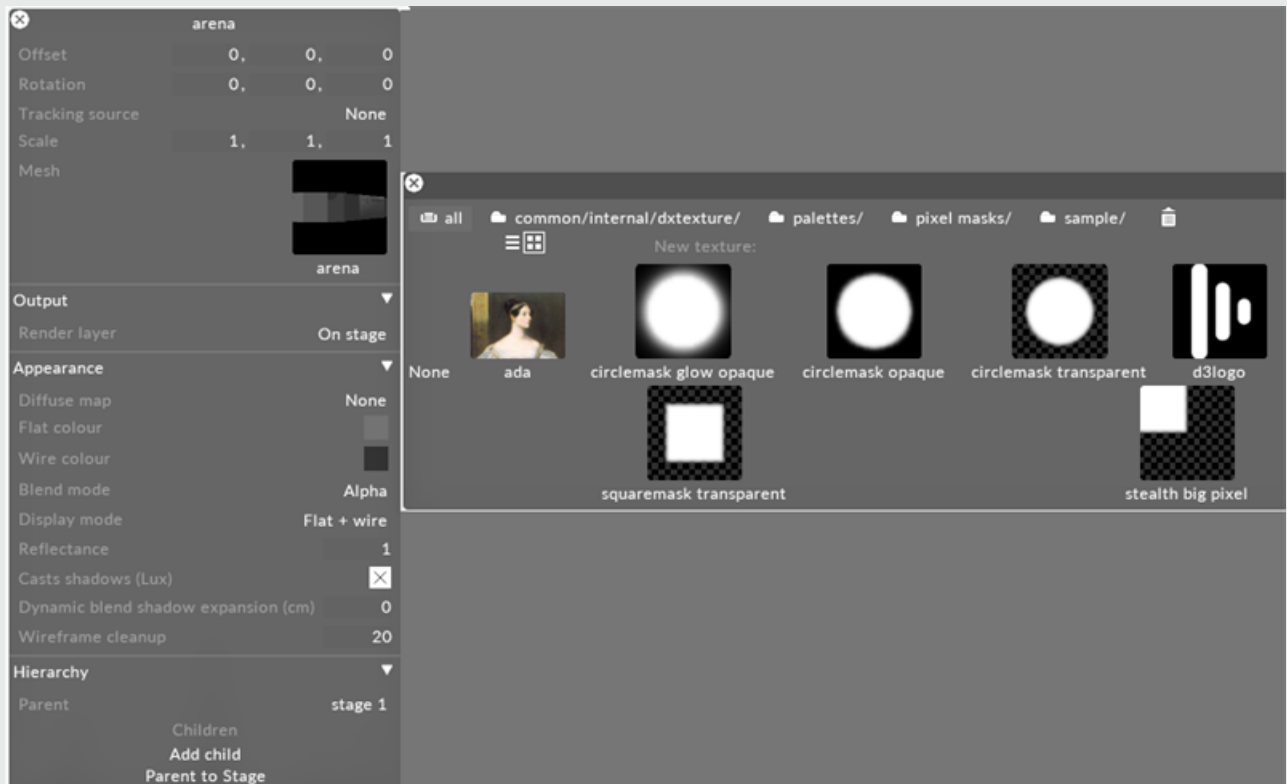

Diffuse Map property being used to apply a still image to a prop from the Texture object library

To apply a texture to a prop:

- Left-click **texture** to open the Texture object library.
- Left-click the texture you want to apply to the prop.

If you want to use a texture other than the standard still images provided in Disguise software, you will need to use a custom still image file.

See the [Placing media files for a project](#) sub-chapter to understand where to place a custom still image file and how to access it in the software. Also save the file to a [supported file format](#).

**Please note:** to apply a texture to a prop you need to UV-map the mesh of the prop.

## Flat colour

This property defines the color of a prop.

## Wire colour

This defines the color of the wire-frame of the Prop. In order to see the wire-frame you need to set the props Display Mode to either **flat+wire** or **wireframe**.

## Blend mode

This controls how the props contents are composited with the rest of the objects in the stage.

**Over:** should be used for non-transparent props.

**Add:** should be used for screens that are totally invisible when there is no content on them.

**Alpha:** should be used for screens that are partially transparent.

## Display mode

This controls the different shading types of the prop.

**Hidden:** does not render the prop.

**Flat:** only renders a flat shaded prop.

**Wireframe:** only renders a wire-frame of the prop.

**Flat+wire:** renders a flat shaded prop with highlighted edges.

## Wireframe cleanup

This defines the level of detail of the wire-frame rendering. The default value is 20. The lowest value is 0 which will render the most wire-frames, and the maximum value is 255 which will render the least wire-frames.

# Creating and switching venues

## Creating a venue

- Right-click **stage** from the dashboard (bar at the top of the screen). This will open the Stage editor.
- Left-click **venue**. This will open up the Venues manager which displays a list of all of the venues you have created. The venues listed in the Venues manager are the same regardless of which stage is active, allowing you to share venues in multiple stages. A new project will by default contain one venue called **venue 1**.
- Type the name of the new venue in the **new venue** text box, in this example **venue 2**, and hit **Enter**. This will create the venue and add it to the list of venues in the Venue manager. You can now edit the venue by adding or removing props.

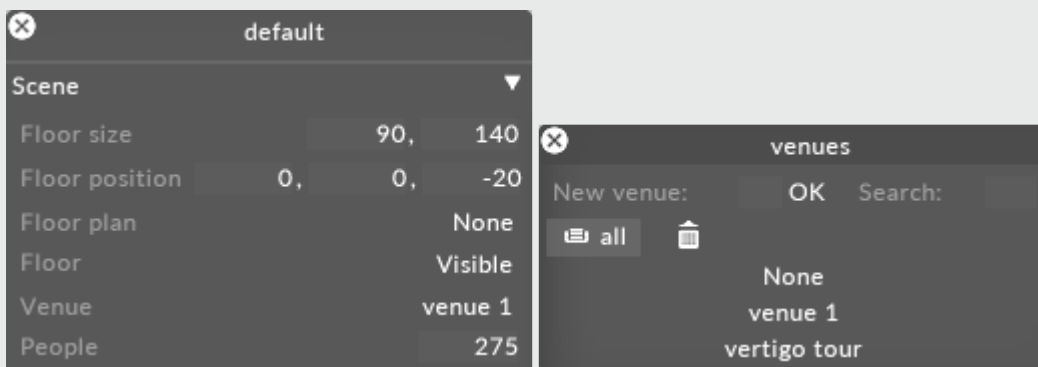

*Process used to add a venue to the currently active stage, in this example Venue 1*

## Switching from one venue to another

- Left-click the venue from the Venue manager you want to switch to. The venue will then be updated in the currently active stage.

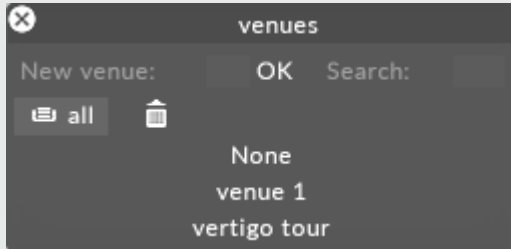

Switching venues by left-clicking a venue from the Venues manager

## Deleting a venue

- Left-click and drag the venue you want to delete from the Venue manager to **trash** (represented by a trash-can icon).
- Right-click Trash and select Empty Trash to permanently delete the venue

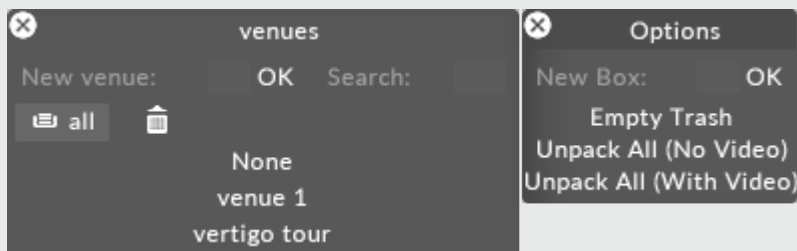

**Warning:** you can never permanently delete a venue if its active or referenced to from anywhere in the project.

# Editing venues

Unlike screens, venues do not have a series of properties which can be edited. Instead, venues contain **props**, which are objects that form the building blocks of your venue. Props have a series of editable properties including the option to add your own textures, all of which are explained in the [Editing props](#) topic.



# Cameras

Cameras are another display type in Disguise software. Similarly to projectors they render the scene from a specific point of view.

## Overview

It is possible to create multiple cameras in a project in order to simulate the location and viewing perspectives of physical cameras in the real world.



**Warning:** Be aware that having multiple cameras requires part of the scene to be rendered multiple times so can incur a major performance cost.

The Visualiser's view of the stage is also a camera referred to as the Visualiser Camera. This can be accessed by clicking the Visualiser Camera button below the Cameras list or right clicking on the background.

## Creating a Camera

1. Open the stage editor by right clicking **stage** from the dashboard or by right clicking the floor in the visualiser.
2. Expand the **Cameras** tab.

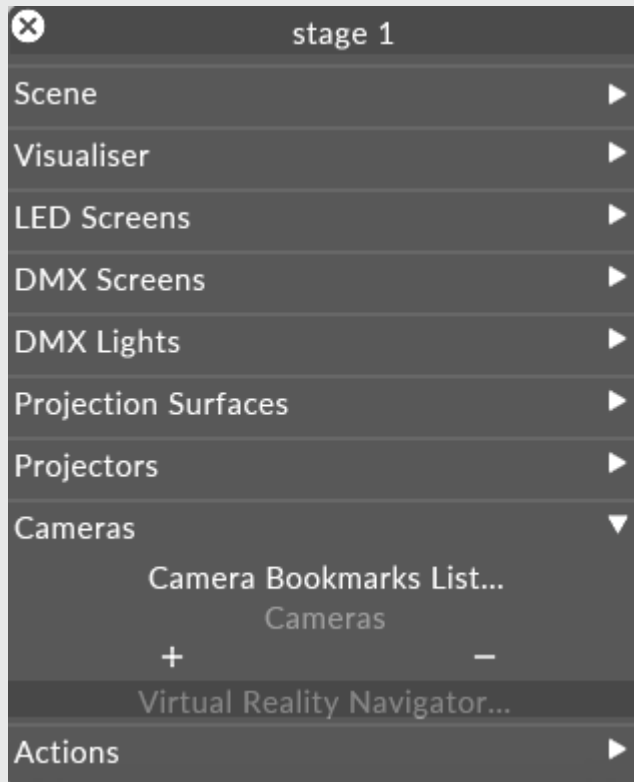

3. Click **+** to add a camera.
4. Left click the **new camera** field in the Camera manager.
5. Enter a name for the camera.

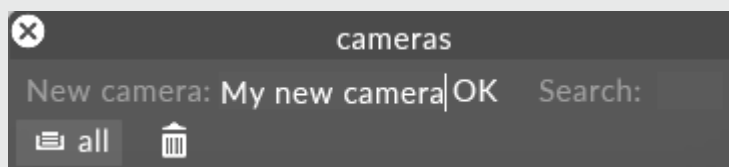

6. Left click **OK**
7. Choose **Camera** from the camera types list
8. You will now see a camera object in the visualiser, at the origin point (0,0,0).

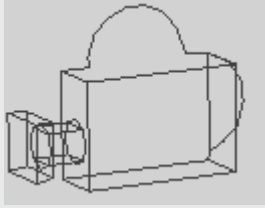

9. Use the 3D widget to adjust the camera's X,Y,Z position within the stage

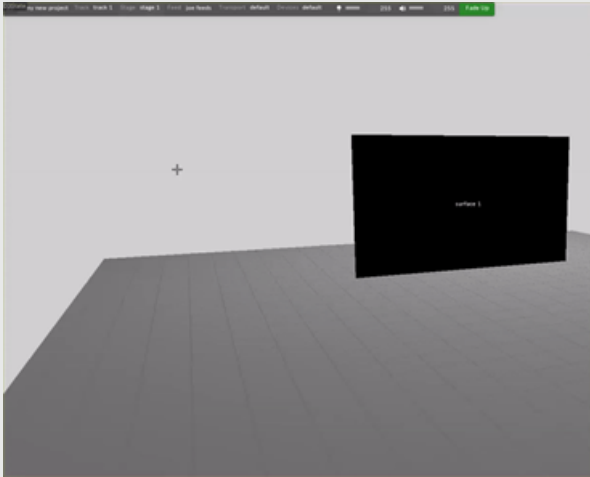

# MR Set

The MR Set object is used as the 'container' for the stage elements used in the xR workflow.

## Overview

An MR set contains all the components of your virtual set and the camera(s) you will be using to capture that virtual set for transmission.



**Warning:** xR will not work properly if the configuration is not completed properly. For more information on the configuring xR, please visit the [xR workflow](#) page.

## Workflow

To create an MR set:

1. Open the Stage properties widget and navigate to the MR Set tab

**Please note:** It can be useful to pin this widget open.

2. Add LED screens to the MR set
3. Add an Indirection Controller (if needed)

## Properties

# Settings

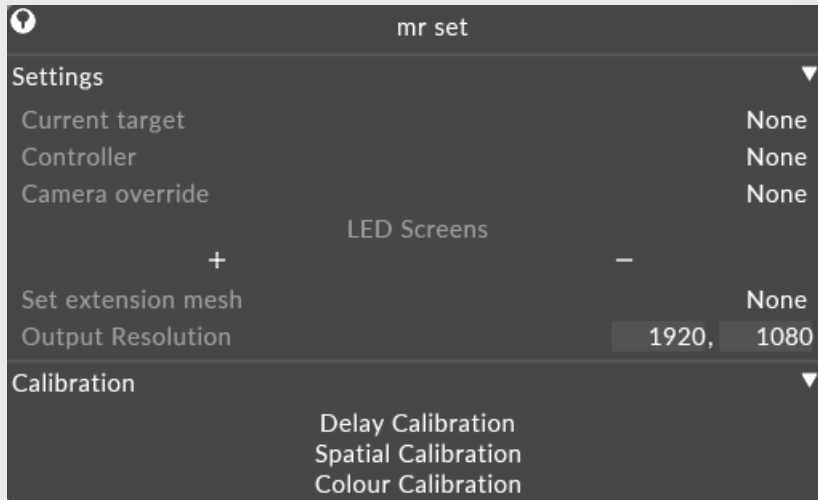

## — Current target

Defines the camera that the content is being rendered from.

## — Controller

Defines the indirection controller that controls the camera switching.

## — Camera override

Allows you to set a camera override for whatever the current controller is set to.

## — LED Screens

Defines which LED screens are included in the MR Set.

## — Set extension mesh

Defines the mesh used for the set extension. This property reads from the mesh folder of your project folder.

- Output resolution  
Defines the final output resolution of the MR Set.
- Output resolution  
Defines the final output resolution of the MR Set.

## Calibration

### Delay calibration

Left click this button to open the calibrate displays editor.

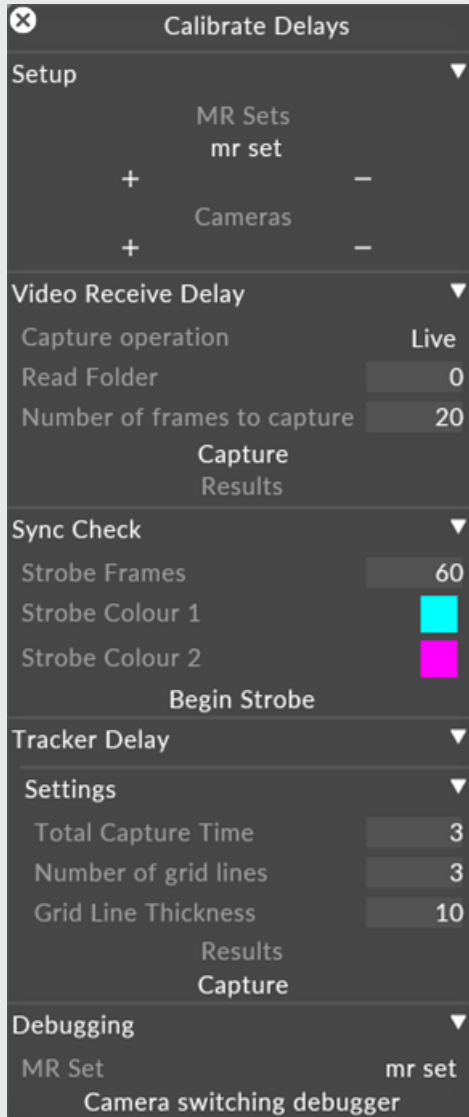

## Setup

**MR Set** - defines which MR Sets are used.

**Cameras** - defines which cameras are included.

## Video Receive delay

**Capture operation.** There are three options:

**Live** - The live setting will use the live captured images to do the calibration.

**Write** - The write setting will write the images captured to disk so they can be used for debugging later.

**Read** - The read setting will read back the images you previously wrote to disc, this is useful for debugging.

## Sync check

**Strobe frames** - defines the FPS for the sync test.

**Strobe colour 1** - Defines the colour for part one of the strobe alternation.

**Strobe colour 2** - Defines the colour for part two of the strobe alternation.

## Tracker Delay

### Settings

**Total capture time** - Defined in seconds. This is the total capture time of the calibration.

**Number of grid lines** - Defines the number of grid lines.

**Grid line thickness** - Defines the thickness of the grid lines. Increase or decrease thickness based on specific stage setup.

**Results** - Left click Results to open the results dialog.

**Capture** - Left click capture to run a calibration.

### Debugging

**MR set** - Defines the MR Set to debug.

**Camera switching debugger** - Left click to open the camera switching debugger.

## Spatial calibration

Left click this button to start a spatial calibration.



# Visualiser renderer overview

The Disguise software has three visualiser render modes. Schematic, lux and heatmap.

In r15, the visualiser rendering mode was changed to encompass two additional new modes. Heatmap and lux. Schematic was the default rendering mode for the visualiser before r15.

## Schematic

Effectively communicate the technical aspects of your creative concept to the whole production team. View your stage, storyboards, and test content from any angle in the real-time 3D stage simulator.

For more information see [Schematic](#).

## Lux

Use as a communication tool to bring together both the technical planning and creative vision of your project. Lux now includes ambient occlusion, directional light, camera exposure and enhanced projector simulation. Communicate ideas clearly and quickly to get everyone, from clients to operators, inspired and on board.

For more information see [Lux](#).

## Heatmap

Heatmaps for projector studies using evidence based calculations - use the orthographic camera mode to ensure accuracy in positioning of objects. Export your projector study to provide paperwork evidencing the proposed setup against a target light level.

For more information see [Heatmap](#).

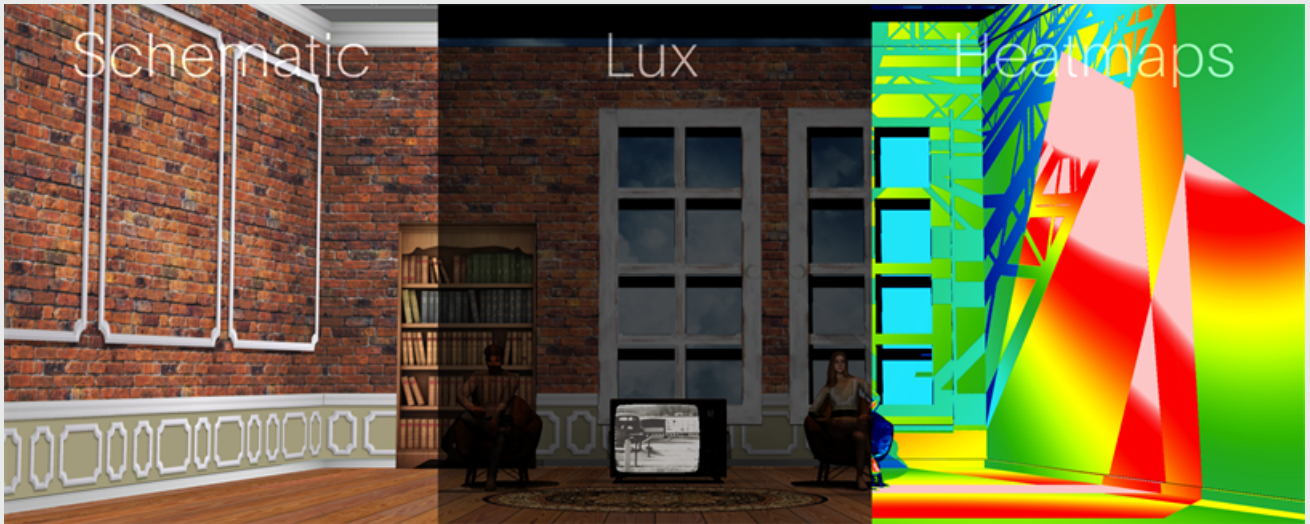

*Image of the three different render modes, side by side.*

# Visualiser renderer overview

The Disguise software has three visualiser render modes. Schematic, lux and heatmap.

In r15, the visualiser rendering mode was changed to encompass two additional new modes. Heatmap and lux. Schematic was the default rendering mode for the visualiser before r15.

## Schematic

Effectively communicate the technical aspects of your creative concept to the whole production team. View your stage, storyboards, and test content from any angle in the real-time 3D stage simulator.

For more information see [Schematic](#).

## Lux

Use as a communication tool to bring together both the technical planning and creative vision of your project. Lux now includes ambient occlusion, directional light, camera exposure and enhanced projector simulation. Communicate ideas clearly and quickly to get everyone, from clients to operators, inspired and on board.

For more information see [Lux](#).

## Heatmap

Heatmaps for projector studies using evidence based calculations - use the orthographic camera mode to ensure accuracy in positioning of objects. Export your projector study to provide paperwork evidencing the proposed setup against a target light level.

For more information see [Heatmap](#).

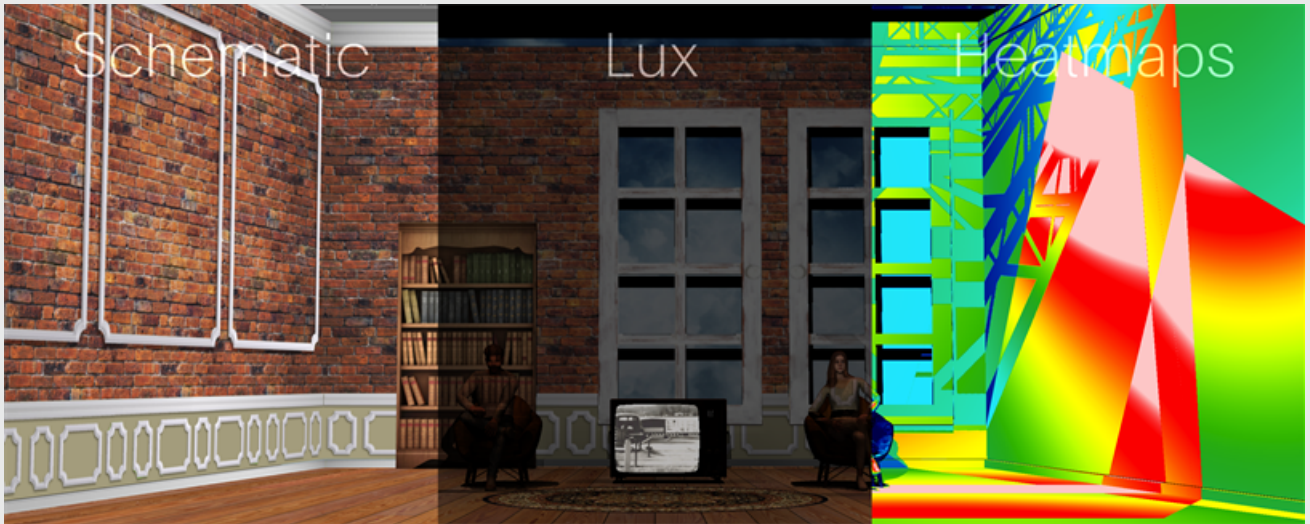

*Image of the three different render modes, side by side.*

# Schematic

Schematic render is an operational rendering mode that provides unlit, but accurate rendering of content in the stage visualiser.

## Overview

Previous to r15, the schematic rendering mode was the only mode available in the stage visualiser settings. It is intended to be used during playback, sequencing and when maximum performance is needed.

Effectively communicate the technical aspects of your creative concept to the whole production team. View your stage, storyboards, and test content from any angle in the real-time 3D stage simulator.

## Workflow

- Setup your project as normal by adding projectors, screens, venues & props.
- Change your visualiser camera to schematic mode, or make a new Camera to assign to a feed output.

**Please note:** Schematic is the default enabled mode of the three renderers.

# Example

## Enabling schematic mode

1. Open the stage editor by right clicking **Stage** from the dashboard or by right clicking the **floor** in the visualiser.
2. Expand the Cameras tab, and right click **Visualiser camera** to edit the visualiser camera settings. Alternatively, you can edit another camera and output that to the feeds.
3. In the camera editor, expand the **Renderer** tab and set the render mode to **Schematic**.

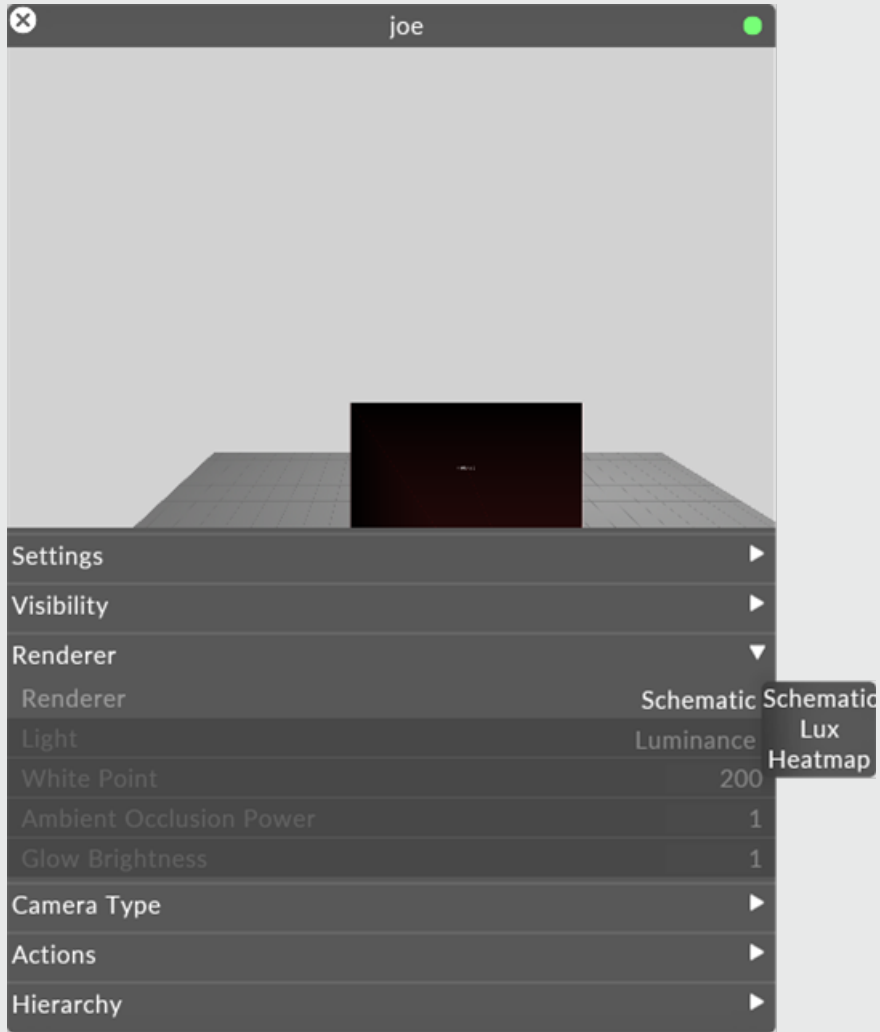

# Viewing schematic rendering through cameras

1. Position the camera in the visualiser.



2. Left click **Feed** from the dashboard.
3. Right click on the camera feed at the top of the feed scene and left click **Add feed rectangle** or alternatively hold **ALT**, left click and drag an arrow from the camera feed to an available output head.



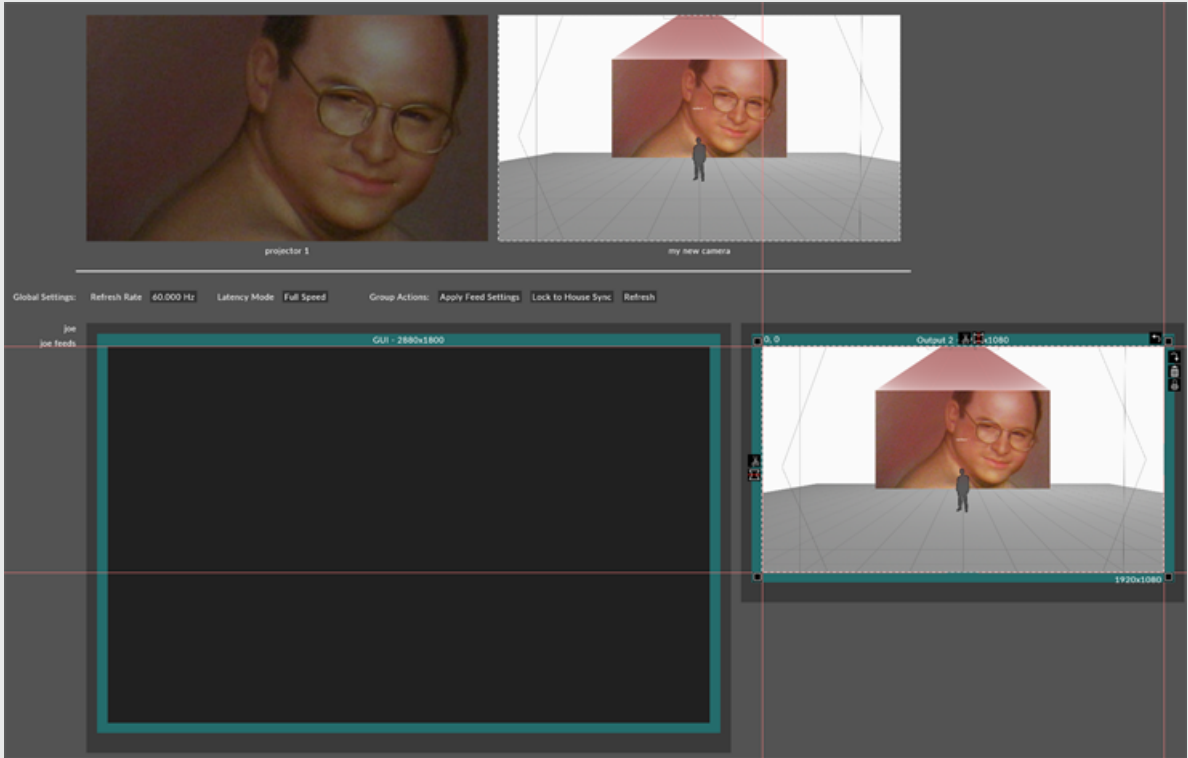

# Lux

Lux is an enhanced rendering mode designed to simulate a more realistic impression of how a show would look.



**Warning: Lux is an intensive performance mode and should not be used for playback!**

## Overview

Lux is most useful for showing clients a more realistic impression of how a project would look. This includes ambient lighting, shadowing of objects being hit by projectors based on physical lighting and scene settings. This allows you to make more technical & creative decisions in advance before going onsite.

**Please note:** Modern rendering modes such as Lux depend on appropriately powerful GPU choices. This feature requires significantly more GPU power than other rendering features in Disguise software. For project specific guidance, please contact [support@disguise.one](mailto:support@disguise.one).

## Features of this rendering mode

- Physical lighting values
- Ambient light
- Ambient occlusion

- Projector shadows
- Bloom effect
- Diffuse maps

## Limitations of the rendering mode

- Lux does not support transparent objects, that includes transparent pixel and population masks.
- Lux does not support blend modes other than 'Over', i.e. any non-opaque modes.

## Scene Lighting

Lux aims to simulate light in an accurate way, as such the Scene is absent of light by default and only Projectors and Scene Lights can be used to introduce lights.

All objects will be affected by the Ambient Brightness in lux of the scene where ever they are. This must be accounted for when setting Exposure and is required to allow props to be seen.

The Ambient Colour effects the colour of this light. So a high Ambient Brightness and a red Ambient Colour will give everything a red tint.

Directional Lights can be used to add a sun-like light source to the scene, it has no source point but casts lights at a constant angle into the scene in parallel rays. This improves the appearance of a 3D object by providing shading to surfaces depending on their exposure to the Directional Light, much like an object in the real world. Directional Lights are visualised in the Scene at the specified Offset but this value has no effect on the lighting and visual results as the Directional Light has no source point.

The Reflectivity of an object can be set to adjust the amount of light reflected by the surface. This number is based on a perfect lambertian surface and represents the fraction of light that will be reflected. It does not indicate screen gain or simulate colour response.



**Warning:** Scene lighting does not cast shadows.

## Screens

All objects will be affected by any projectors that hit them. The brightness is determined by the projectors lumen value. Projectors will cast shadows.

LEDScreens, DMXScreens have physical luminance values based on NITS but do not cast light on other objects in the scene.



**Warning:** DMXLights are not currently supported as lights.

## Ambient Occlusion

Ambient Occlusion is an effect that emulates the occlusion seen in dark corners of objects in the real-world but is not related to any real lighting. It is only affected by the ambient light in the scene.

Ambient Occlusion Power can be changed via the [Camera Editor](#) and turned off to improve performance.

## Enhanced Projector Footprints

Projector brightness is specified in Lux which is used for simulating the brightness of an image in Lux and also the resulting Lux readings in Heat Map mode.

In Lux mode all objects will cast shadows when in the projector frustum for the use of pre-visualisation and checking of sight-lines. These shadows are not shown in the feed outputs.

## Diffuse Maps

A Diffuse Map can be added to Projection Surfaces or Props to simulate how the projected light will interact with the surface. This is useful when projecting on surfaces that are not ideal for projection such as buildings with a stone surface or painted set pieces where the light that is reflected may be different than imagined due to the interference of the surface.

# Workflow

- Setup your project as normal by adding projectors, screens, venues & props.
- Define Ambient Brightness & Colour.
- Change your visualiser camera to Lux mode, or make a new Camera to assign to a feed output.

## Example

### Enabling lux

1. Open the stage editor by right clicking **Stage** from the dashboard or by right clicking the **floor** in the visualiser.
2. Expand the Cameras tab, and right click **Visualiser camera** to edit the visualiser camera settings. Alternatively, you can edit another camera and output that to the feeds.
3. In the camera editor, expand the **Renderer** tab and set the render mode to **Lux**.

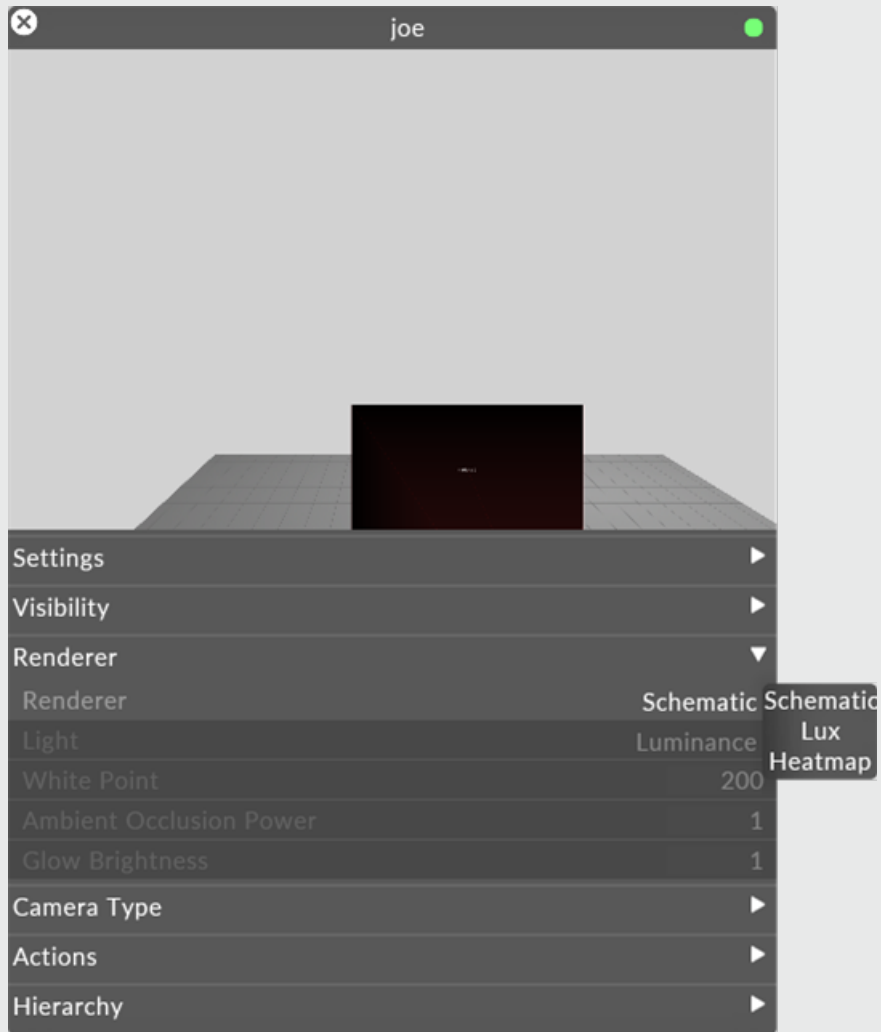

You are now viewing a Lux rendering of the scene based on the values defined in the visualiser camera.

For more information, see the [Cameras](#) topic.

# Setting scene lighting

1. Open the [stage editor](#) by right clicking **Stage** from the [dashboard](#) or by right clicking the **floor** in the visualiser.
2. Expand the Scene tab.
3. Adjust the ambient light and colour values to suit.

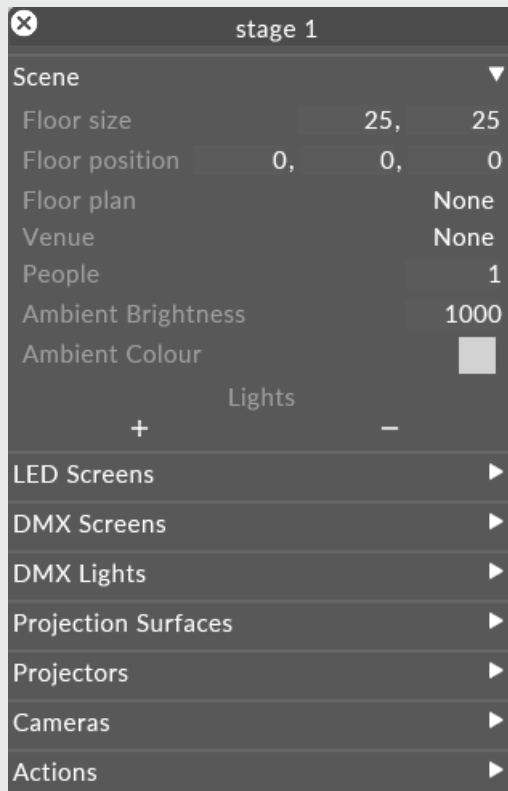

# Viewing Lux through cameras

1. Position the camera in the visualiser.



2. Left click **Feed** from the dashboard.
3. Right click on the camera feed at the top of the feed scene and left click **Add feed rectangle** or alternatively hold **ALT**, left click and drag an arrow from the camera feed to an available output head.



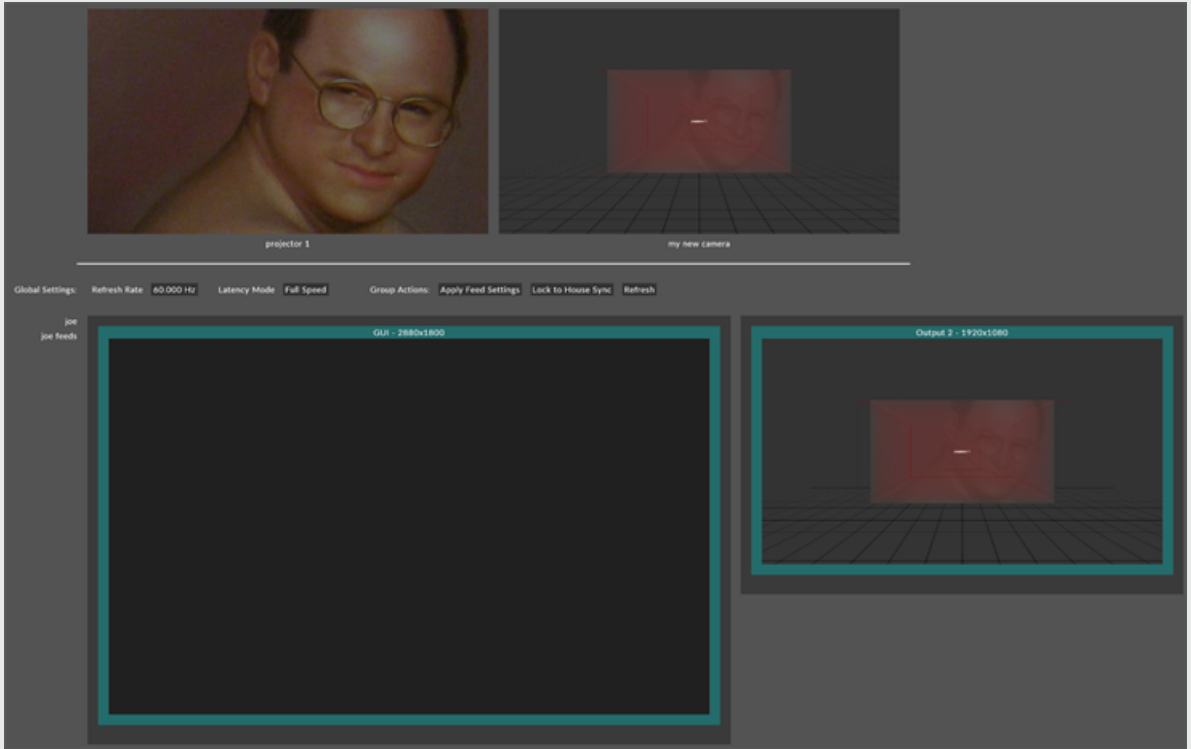

# Heatmap

This renders the view using colour coding for different lux levels, rather than applying the glow filter.

## Overview

The heatmap render mode is primarily used for visualising light levels within the scene.

All projectors and LEDs output white content in this mode. The graph on the right goes up to twice the camera's exposure max-lux level, so use that to scale it if necessary. This is the mode that will be used for Projector studies.

**Please note:** Modern rendering modes such as Heatmap depend on appropriately powerful GPU choices. This feature requires significantly more GPU power than other rendering features in Disguise software. For project specific guidance, please contact [support@disguise.one](mailto:support@disguise.one).

## Workflow

- Setup your project as normal by adding projectors, screens, venues & props.
- Change your visualiser camera to Heatmap mode, or make a new Camera to assign to a feed output.
- Define your target lux in the heatmap editor.

## Example

# Enabling heatmap

1. Open the stage editor by right clicking **Stage** from the dashboard or by right clicking the **floor** in the visualiser.
2. Expand the Cameras tab, and right click **Visualiser camera** to edit the visualiser camera settings. Alternatively, you can edit another camera and output that to the feeds.
3. In the camera editor, expand the **Renderer** tab and set the render mode to **Heatmap**.

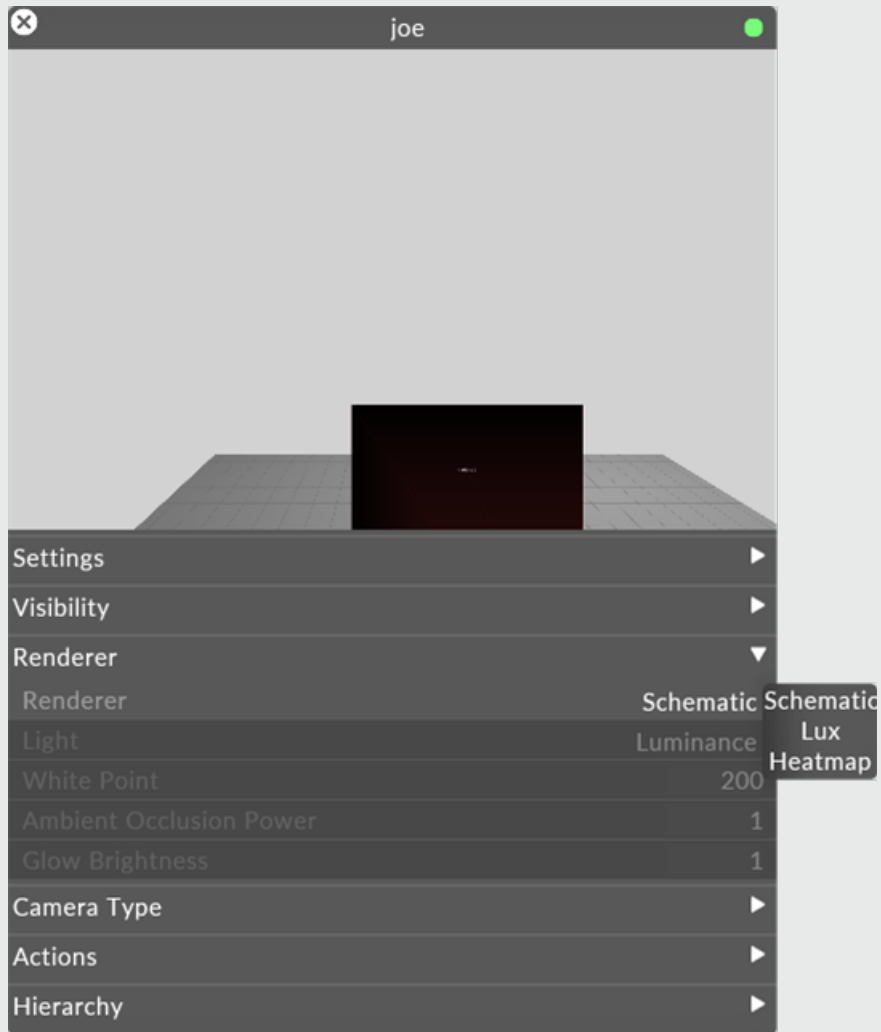

You are now viewing the heatmap visualisation of the photometric quantity specified by the Light field under the render tab within the camera editor.

The key shown in the heatmap editor shows the colour scheme and scale of the heatmap.

# Editing heatmap properties

1. Open the heatmap editor.
2. Set the target value to be the preferred surface illuminance or luminance that you want to achieve.

# Viewing heatmaps through cameras

1. Position the camera in the visualiser.

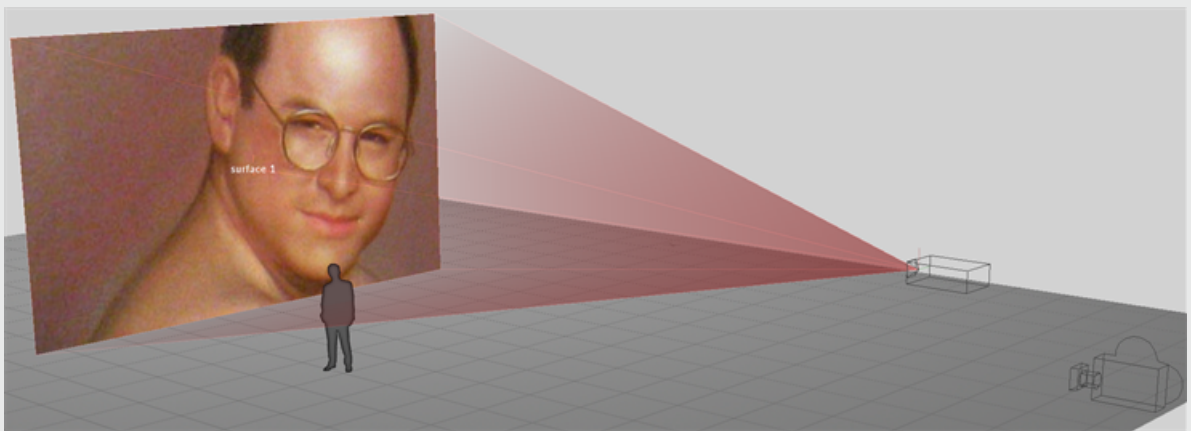

2. Left click **Feed** from the dashboard.
3. Right click on the camera feed at the top of the feed scene and left click **Add feed rectangle** or alternatively hold **ALT**, left click and drag an arrow from the camera feed to an available output head.

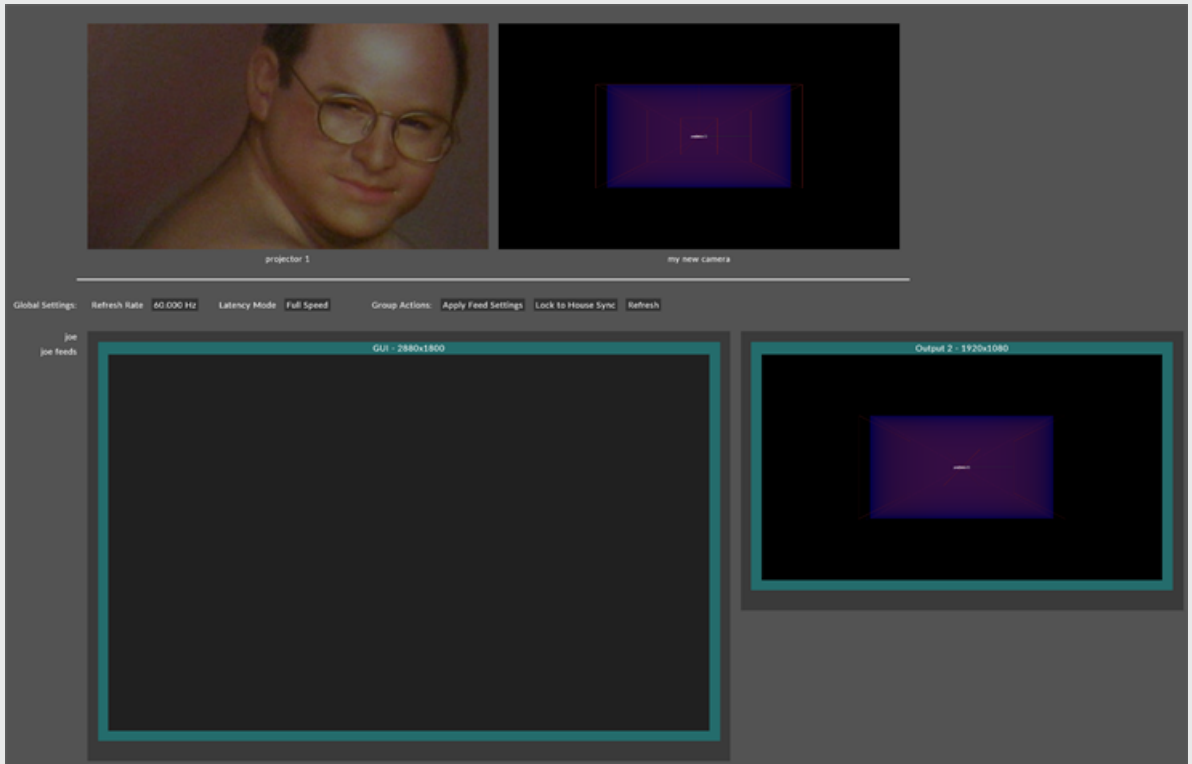

## Heatmap properties

### Target lux/nits

The value that determines the centre of the colour scheme, which is green.

### Heatmap min

Manually sets the minimum value of the scheme.

# Heatmap max

Manually sets the maximum value of the scheme.

**Please note:** When you change target, this will change the minimum & maximum values to be zero for minimum and double for maximum of the target value.

# Projector studies

Projector studies allows you create technical documents from Disguise software that contains photometric heatmaps of the scene and projector properties.

The photometric quantities can be specified as either the luminance of the scene or the illuminance.

The PDF document contains the heatmap from the visualiser cameras view and each projector.

Each page of a projector study will show the following:

- Software version
- Project name
- The photometric quantity used.
- The user specified revision and comment.
- The time stamp the study was created.

In addition, each page that contains a projector view will show the following properties:

- Name
- Resolution
- Brightness (lumens)
- Throw Ratio
- Lens Shift Horizontal
- Lens Shift Vertical
- Position

The final page will show a table of all projector properties.



# Projector Properties Table

This table is a .csv file that contains the properties of the projectors in the stage.

The properties are as follows:

- Name
- Resolution X
- Resolution Y
- Brightness (lumens)
- Throw Ratio
- Lens Shift Horizontal
- Lens Shift Vertical
- Position X - Meters
- Position Y - Meters
- Position Z - Meters

## Considerations

The photometric analysis does not take into account the following

- Atmospheric absorption of light as it passes through space.
- Brightness decay due to projector lamp life.
- Effects of lens focus and distortion.
- Projector brightness uniformity.
- Physical properties of the surface material.

- It assumes a lambertian reflectance of all surfaces, that they are perfectly diffuse and reflect light equally in all directions so that the brightness is the same no matter the viewing angle.
1. Set your project up as normal, placing projectors, screens and other elements.
  2. View the scene lighting in the heatmap rendering mode to see how close the setup matches expectations.
  3. Open the Stage editor.
  4. Define the desired settings in the projector studies editor.
  5. Export the projector study.

## Enabling heatmap

1. Open the stage editor by right clicking **Stage** from the dashboard or by right clicking the **floor** in the visualiser.
2. Expand the Cameras tab, and right click **Visualiser camera** to edit the visualiser camera settings. Alternatively, you can edit another camera and output that to the feeds.
3. In the camera editor, expand the **Renderer** tab and set the render mode to **Heatmap**.

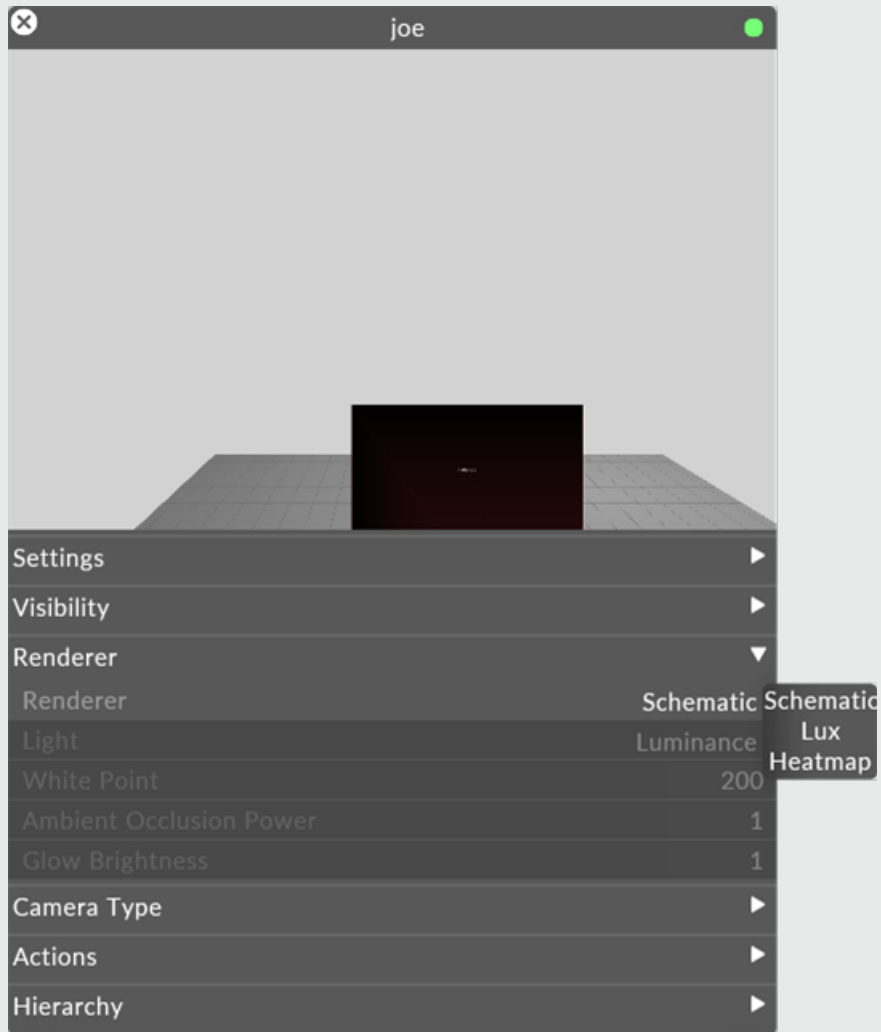

You are now viewing the heatmap visualisation of the photometric quantity specified by the Light field under the render tab within the camera editor.

The key shown in the heatmap editor shows the colour scheme and scale of the heatmap.

# Editing heatmap properties

1. Open the heatmap editor.
2. Set the target value to be the preferred surface illuminance or luminance that you want to achieve.

# Creating a new projector study

1. Open the stage editor by right clicking **Stage** from the dashboard or by right clicking the **floor** in the visualiser.
2. Expand the **Projectors** tab of the stage editor.
3. Left click **Projector studies...** to open the Projector studies editor.
4. Left click **Export projector study** and the projector study will be written to the projectorstudies folder within your project folder.

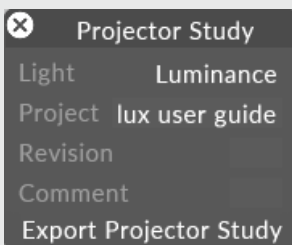

*The projector study editor*

# Light

**Luminance** - Luminance - The intensity of light emitting from an object or surface per meter in a given direction, measured in nits ( $\text{cd}/\text{m}^2$  )

**Illuminance** - The density of incident light in lumens hitting a surface per meter, measured in lux ( $\text{lm}/\text{m}^2$  ).

## Project

The name of the project. This can be changed without affecting the main project name.

## Revision

User definable revision field.

## Comment

User definable comment field.

## Export Projector Study

Clicking **Export Projector Study** will write the projector study to the projectorstudies folder in Disguise software project folder.

# Projector Calibration

Projection Calibration is the process of calibrating your projectors to the 3D space.

## Overview

The Disguise software offers three different calibration methods. Each has their own benefits and draw backs. We recommend planning which form of calibration will be used during pre-production.

1. To learn more about manual calibration see [here](#).
2. To learn more about QuickCal see [here](#).
3. To learn more about OmniCal see [here](#).

# Manual Calibration - Projectors



**Warning:** reset all digital and optical warps inside the projector, including lens-shift, otherwise the lineup features will be interrupted.

- Open the projector editor by either right-clicking the projector directly in the Stage, or by right-clicking the projector from the **screens** list in the Stage editor.
- Familiarize yourself with the properties of a projector. After this follow the instructions explained below.

## Set the correct resolution

Set the **resolution** of the projector to match the corresponding output head's resolution.

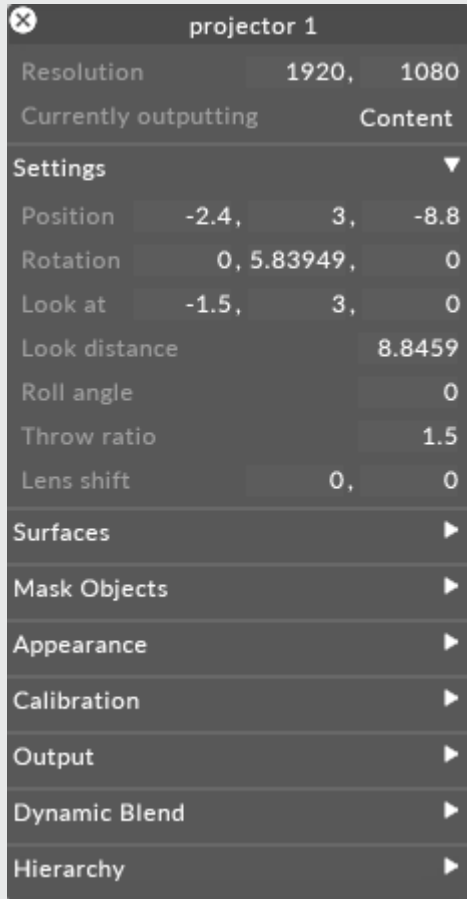

**Warning:** If the resolution of the projector doesn't match the real world output, you will end up with an incorrect calibration.

## Add surfaces

Under the **Surfaces** tab add the projection screens that the particular projector is covering.



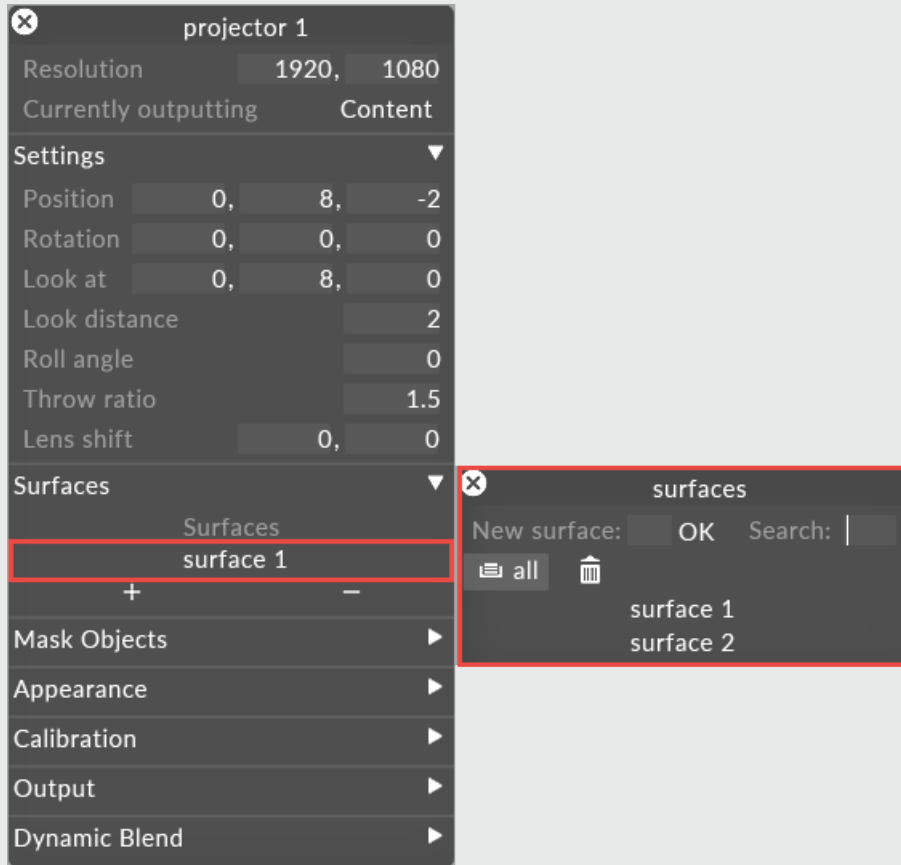

**Warning:** If you don't add a screen to the projector the output will stay black.

## Add the projector outputs to the Output Feeds

Ensure all of the Feed rectangles from the projector outputs have been added to the output heads.

Please see [adding feed rectangles](#) for information how to do this.

# Place the projector correctly

Change the **pos** (projector position) and **the throw ratio** (lens value) properties so that the projector covers the required part of the screen surface. A laser measure may be required to calculate the correct position by measuring the distance from the physical projector to the video surface.

## Adjust the Look at position

The **Look at** position of a projector defines the centre point of its corresponding output feed. When lining up a virtual projector to the physical projector it is therefore crucial to match the Look at position to its corresponding point in the real world.

Disguise has a built-in wireframe feature allowing the system to generate a line-drawing based on the 3D mesh of the projection surface. In the same output frame Disguise will also output a red cross positioned in the centre of the output feed. When the wireframe test pattern is applied, Disguise will output this red cross regardless of the orientation of the projector.

Consequently, if the look at position of the projector is aligned to the red cross on the physical projection surface, the virtual projector and the physical projector are orientated around the same point which is a great starting point for an accurate manual lineup.

## Align the look at position of the projector

- Change the output mode to **wireframe** by clicking the **output** tab at the bottom of the projector editor.
- Return to the Stage level. Set the **step** value of the look at position to 0.01 to enable smoother scrolling of the look at values. To change the step value, right-click the property **name** and change the value in the Step value property.
- Begin aligning the look at position of the projector to the red cross by comparing the look at positions crosshair in the Stage level and the red cross being outputted from the physical projector.



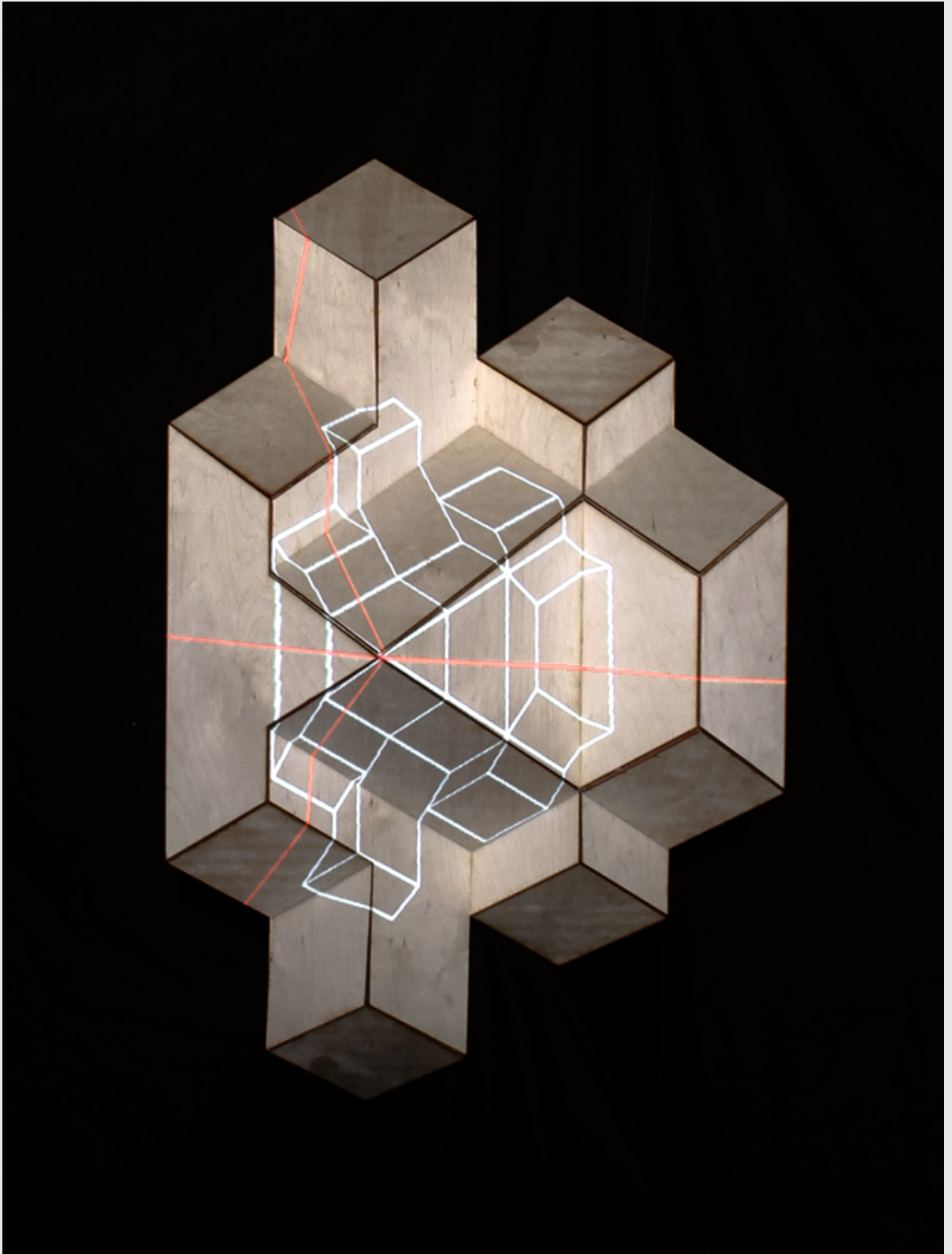

Look at position of the virtual projector now matches its corresponding point on the physical video screen, in this example a wooden sculpture

## Adjust the throw Ratio

- To zoom in on the physical video screens content, change the **throwRatio** value. This value corresponds to the lens size of the physical projector.
- If the exact lens size is known (for example a fixed lens size is being used), type it in.
- If a zoom lens is being used, set the start value to the lowest (or highest) value in the zoom range. Slowly change the value by scrolling the mouse wheel in the property field.

## Fine tune property values

- After setting the initial lens value, try not to edit the position properties. Instead, start adjusting the **rotation** parameters if needed, in particular the x and y rotations. Aim to establish parallel lines mapping onto the video screen **globally** rather than focusing only on one part of the screen. Adjust the **step** value if needed.
- Go back and fine tune the values of the lookAt position to center the output to the physical video screen. **Remember to establish parallel lines.**
- Adjust the throw ratio to zoom in/out of the content on the video screen. Assuming that the 3D mesh is accurate to the physical video screen, the mapping should gradually fall into place.

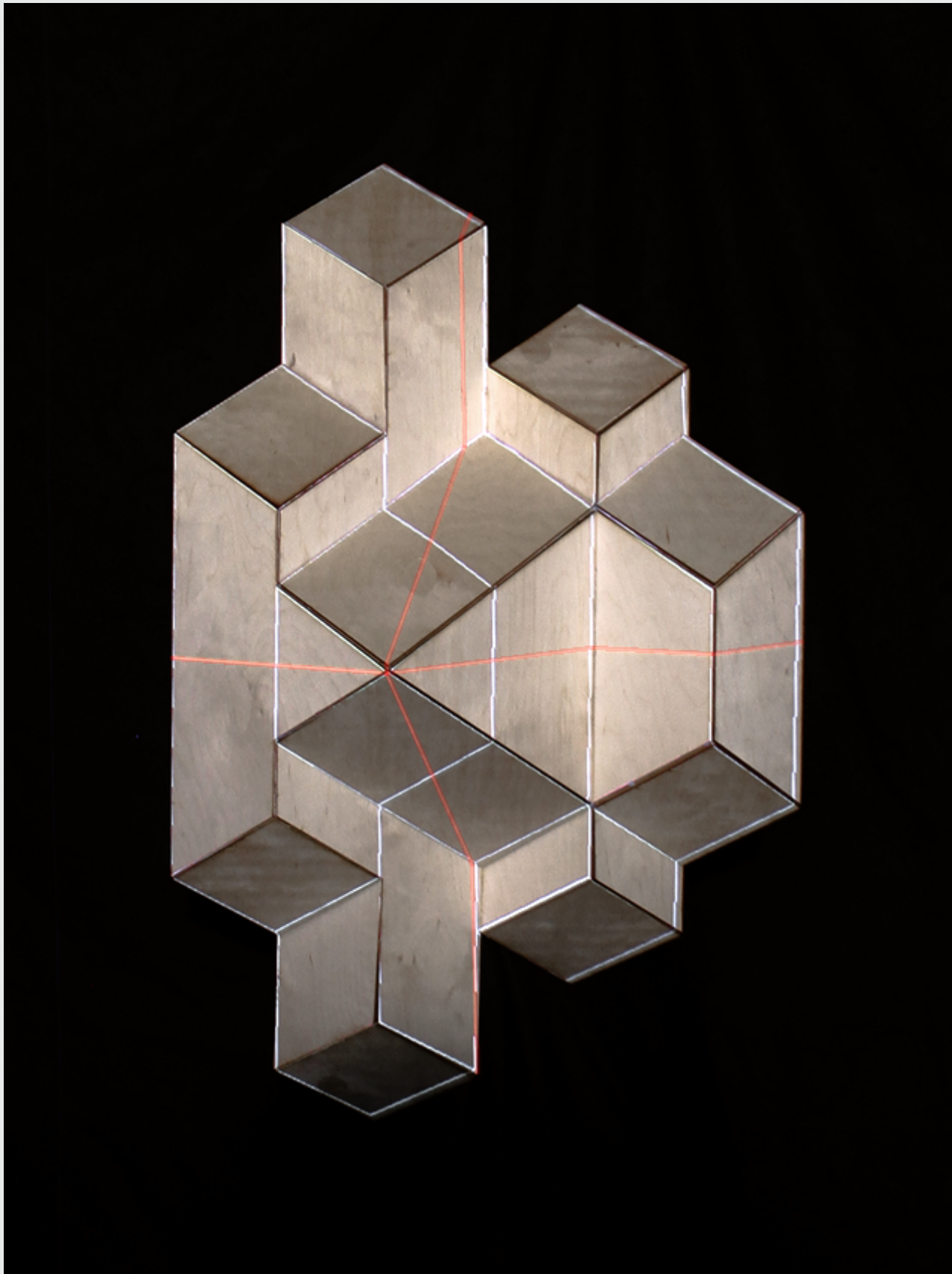

Projector has been manually calibrated; the 3D mesh test pattern now lines up with the wooden sculpture

If the projection surface does not match the 3D model after carrying out manual calibration the lineup may need to be fine-tuned. Please see the sub-chapter [Warping outputs](#) for more information.

# Quick Calibration overview

This sub-chapter explains the process of using QuickCal to line up projectors to real world screens.

## QuickCal overview

QuickCal is a user-driven process of calibrating a virtual projector's position, orientation and lens properties to match the real-world projector. QuickCal is based on reference points on given 3D meshes for a projector's target surfaces, and user-defined 2D image coordinates that are manually assigned to these 3D reference points. As long as the 3D meshes are good matches to the real-world projection surfaces, QuickCal can accurately calculate the projector parameters.

The basic process of QuickCal is relatively simple : drop reference points onto the 3D model of the projection surface, and then 'line up' by dragging each point in the projector's output raster until it hits the corresponding point on the real surface. Once you've done enough points (about 10-15 per projector) Disguise software can work out exactly where the projector is, and what lens qualities it has.

## 3D mesh accuracy

When calibrating projectors using QuickCal it is **crucial** that the 3D mesh object is modelled accurately to the physical model. The reason for this is that Disguise's calibration algorithm assumes that the virtual reference points link exactly to their corresponding real-world points. The best way to generate a highly accurate 3D model is to laser scan the physical model, or to laser cut the physical model based on the same 3D file you later use in Disguise software. For building projections we recommend a mesh with a +/- 5mm error margin.

## Using QuickCal

To start using QuickCal, first move the virtual projector into roughly the right position and orientation, and set up its lens qualities to roughly match the real projector. You don't have to be particularly accurate in this, but when you're trying to select projectors in the visualiser for editing, it's easier when they're in roughly the right place. Then move on to creating reference points, and then line them up.



# Tips & tricks

## General QuickCal background information

The calibration goal is to calculate a projector's projection matrix so that it produces physically valid projections on its assigned projection surfaces in the real world (the scene). This means that the matrix does not need to be absolutely physically correct, but should be correct for at least this projection area (or rather volume). Indeed, it helps to think of the calibration as a process that works on a volume in space, rather than on 2-dimensional surfaces.

The calibration process uses as main inputs:

### **3D Reference Points (in world space)**

These are usually created from vertices of the mesh/object. Note that the mesh needs to match the real object, at least in the vertices used for creating Reference Points. In d3 Reference Points are 3D objects themselves, and a certain point can be used by several Projectors.

### **2D coordinates (in the projector image plane)**

These are created during line up of a Reference Point in a given Projector. In Disguise software the Projector Configuration stores a pair that links the 2D coordinate to the 3D Reference Point.

## Projection matrix

The projection matrix is a linear transformation that represents the projector's position, orientation and internal sensor and lens properties. Note that Disguise software currently does not support correction of non-linear lens distortion in QuickCal. Lens distortion is only calculated and compensated for in OmniCal.

In Disguise software the projection matrix is applied to all 3D meshes in the Surfaces list, so they get transformed and projected on to the virtual Projector's image plane. This creates the projector's output image that is visible in the Feed Scene.

# Choice of Reference Points and Order of line-ups

A Reference Point and the 2D line-up coordinate together form a correspondence point pair. Several such pairs are required for a calibration. QuickCal supports several algorithms that have different requirements on the minimum number of points (e.g. 4, 6, or more).

It doesn't matter for the calibration itself which object/mesh the Reference Points come from, as long as that 3D point exists in the real world as a recognisable feature. Object corners are usually good choices.

It is possible to use Reference Points from several objects for a single Projector.

Important requirements are:

- The real-world equivalents of the Reference Points are actually visible by the physical projector (lie inside its light cone).
- All Reference Points that are used for a projector:
  - » span a large enough 3D volume. Often this is referred to as "adding enough depth". The main issue is to ensure that the Reference Points do not all lie on the same (virtual) plane in 3D space.
  - » should evenly cover a large enough area in the Projector's image. It's a good idea to use Reference Points that get lined-up in all four corners of the projector output image.

Additionally, if you want to verify the wireframe of an object during QuickCal line-up, then the objects needs to be added to the Projector's Surfaces list.

It is worth to keep in mind that calibrating creates a working volume for a projector, using the 3D Reference Points as a helper. So the volume in which the projector "is valid in" is always limited by the extent of Reference Points you have lined up. As an example, lining up 6 points that are all in the same image corner of the projector will likely produce a calibrated matrix that doesn't work well for the rest of the image. The same goes for points that are in close proximity in the real world, i.e. the calibrated matrix will only be valid in the small volume within those points.

The order in which Reference Points are created and lined up does not affect the calculation of the projection matrix. The calibration will produce the same result no matter what points are lined up first.

However, to help the calibration work out things faster, it makes sense to line up Reference Points from extreme parts of the scene first, before adding points that are closer to each other. Otherwise there may not be a good visual output until enough points are lined up so that they cover the whole scene with enough depth.

## Short QuickCal Rules

1. Leave the Calibration Method setting at Auto, unless you really have a good reason to force a specific algorithm. Auto will choose the best algorithm based on how many Reference Points you have, and what their 3D relationship is.
2. Don't "cheat" with your line-up coordinates unless you absolutely have to.
3. Never "cheat" until all Reference Points have been added and lined-up.
4. Line up the extreme parts of the mesh(es) and projector image first (e.g. image corners Left/Right/Top/Bottom and Close/Far in the scene). Then improve on that by adding more points. E.g. concentrate on Reference Points in areas where the projected images are still "off" when looking at the real object.

## Limited Scene Depth and number of Reference Points

Meshes/Objects that are flat or have little depth are more difficult to use for calibration. This is even more problematic if the real world object has few or no visible features, like a wall where only 4 corners are easily usable as Reference Points.

However, with 4 correspondence point pairs it's already possible to do a simple calibration (usually IterLM algorithm). This calibration is not able to calculate internal lens parameters such as lens shift or throw ratio. It will take values for these parameters from the manual projector settings. Note that these settings are still editable when using QuickCal with under 6 points, or if certain algorithms are set. It

can be difficult to get these values right by hand, but if the throw ratio and lens shift of the physical projector is roughly known, then adjusting this can help improve the calibration significantly.

With 6 or more correspondence point pairs a different algorithm is used (usually Zhang algorithm), which also calculates lens shift and throw ratio parameters automatically. If the Reference Points provide little or no depth, then this algorithm has problems finding a good projector matrix. This is because mathematically it is very difficult to differentiate between some internal lens parameters and 3D parameters. For example throw ratio (or focal length, if you prefer) and distance to an object are interchangeable to a certain degree. Think of the famous Dolly Zoom effect used by Hitchcock in the film "Vertigo", where the face always stays the same size, only fore- and background objects get smaller or disappear). This ambiguity can only be resolved by more depth. It is necessary to line up more points from the scene background/foreground to constrain the calibration better, essentially thereby increasing the calibration volume.

In practice, it may be preferable in certain rare situations to stick with 4 or 5 points, rather than adding a 6th, because the switch to the different algorithm may make the visual result worse rather than better.

## Correspondence Point influence on calibration

A correspondence point pair is not like guide points for splines, or a fixed warp or rule that associates the two to each other.

Instead, they are inputs into an iterative algorithm that tries to solve a matrix so that all of these point pair conditions are (more or less) satisfied. But due to mesh/ reality discrepancies, line-up inaccuracies, constraints of the optical model, even rounding errors, etc. there will never be a perfect matrix that fits all these pairs. There are many matrices though that will be good enough, so that the error for each of these point pairs is small (e.g. ideally below 1 pixel). If the inaccuracies in the input data are high, then some correspondence point pairs will basically contradict each other strongly. In that case the overall error will be high, too (e.g. 5-10 pixels, or even more). If the error is due to mesh/object discrepancies, then "cheating" might help (see below).

## Cheating

If the 3D model and the physical object don't match exactly, then QuickCal allows to "cheat" a bit. "Cheating" isn't recommended, but often it's not possible to get a better 3D model while being on-site.

There are several ways to "cheat":

- Moving the line-up cursor slightly off from where it should be, so that the overall calibration looks better and the reprojection error gets smaller.

Note that the advanced option 'Disable reference point bounds' allows moving the 2D line-up coordinate outside of the projector's image, e.g. to a negative value.

- Moving a 3D Reference Point away from its original vertex position. In QuickCal this can be done in "Manage" mode by holding the Shift key and moving the 3D Reference Point left, right, up or down. This will move the point in 3D space according to the current visualiser view, and allows placing the point in a non-vertex position. By default, Reference Points snap to the nearest mesh vertex, indicated by a green cross.

The problem with any of these tricks is to know which Reference Points to cheat with, and how it eventually affects the calibration.

# Creating & deleting reference points

## To create reference points:

1. Open the projector editor.
2. Locate the **Calibration** tab.

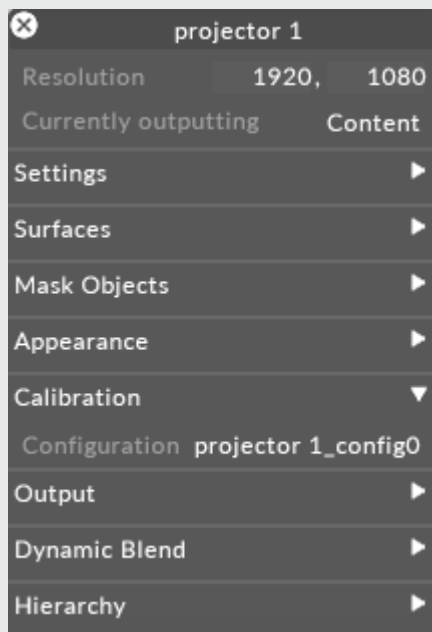

Projector config editor selecting the configuration tab.

3. click the configuration file to open the QuickCal editor. If **left-clicking** you will instead open the Projector Configuration manager which stores all the configuration files for the existing projectors.

4. Select **manage points**.

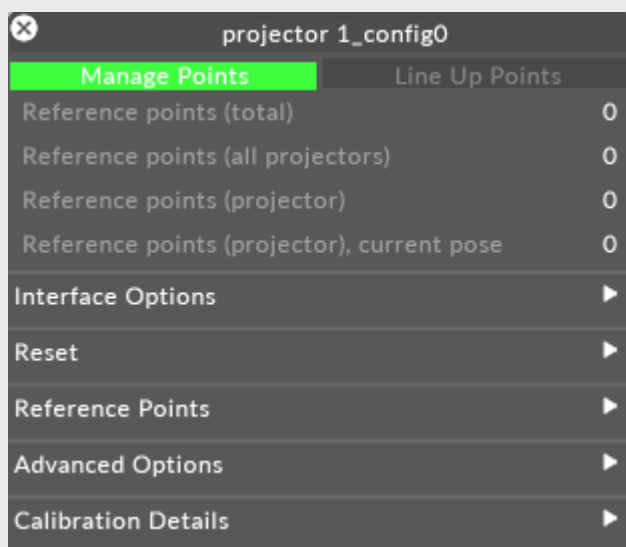

Projector config editor, Selecting manage points.

5. The d3 cursor will now turn in a circle. This indicates that you are in **manage points** mode and when you click on the model a reference point will be created at that location.

**Please note:** The reference points will automatically snap to a vertex near to where you clicked. If you have a really complicated model they may not snap to the correct position select the point you wish to move and hold down the left mouse button to drag it to the desired location.

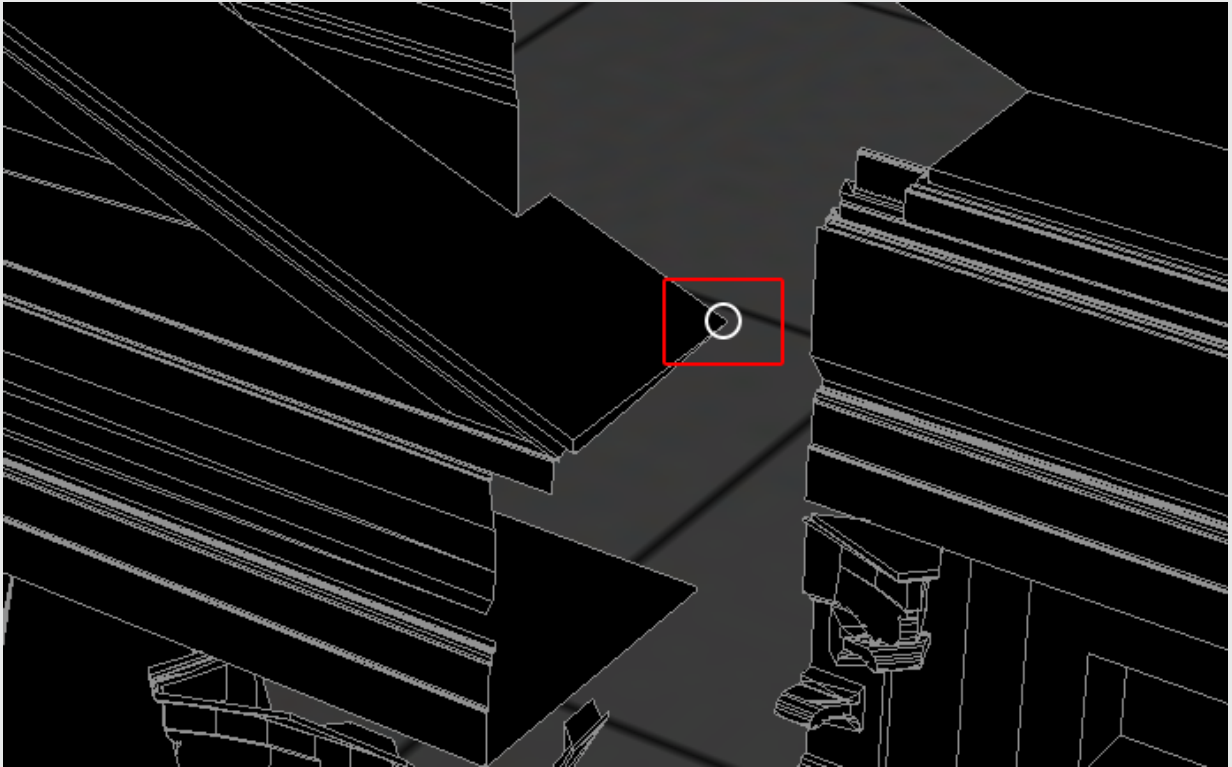

Point creation cursor, Adding a point.

6. Create a minimum of 6 reference points and place them on **clearly** identifiable real-world reference points. This is to make it easier to link the virtual reference points to the corresponding real-world points at a later stage in the lineup process. Usually, there is no need to create more than 6-12 reference points per virtual projector but for more complex geometry it may be necessary to create more. Some complex building mapping projects have required up to 30 reference points per projector.
7. Notice that multiple projectors can use the same reference points.





## To delete a reference point

1. Right-click on the point that you wish to delete.  
The options menu will open.

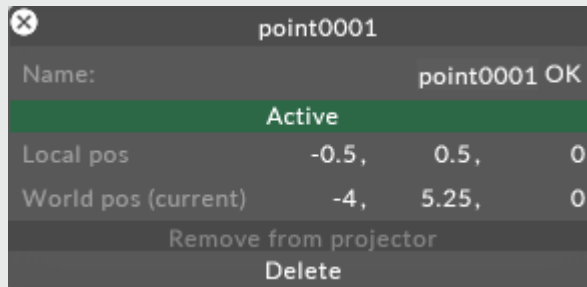

Delete a reference point from the virtual model.

2. Left-click on the **delete** button.



**Warning:** reference points that are lined up in another projector cannot be deleted (since this would affect the other projector's calibration).

# Quick Calibrating - Projectors

## Quick calibrating projectors

1. Right-click the projector you wish to line up.
2. Right-click the configuration file to open the QuickCal editor.

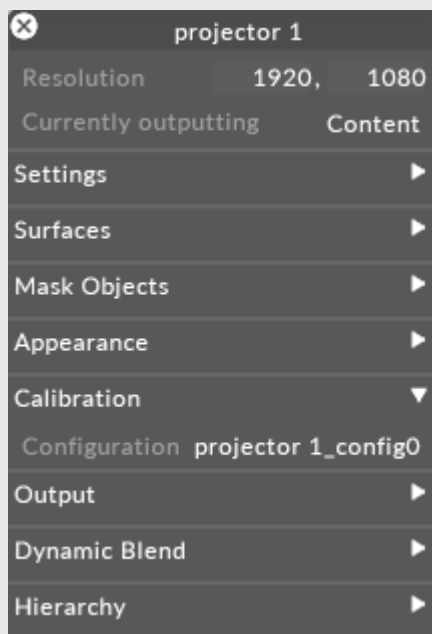

Projector configuration menu.

- At the top of the QuickCal editor select **line up points**.

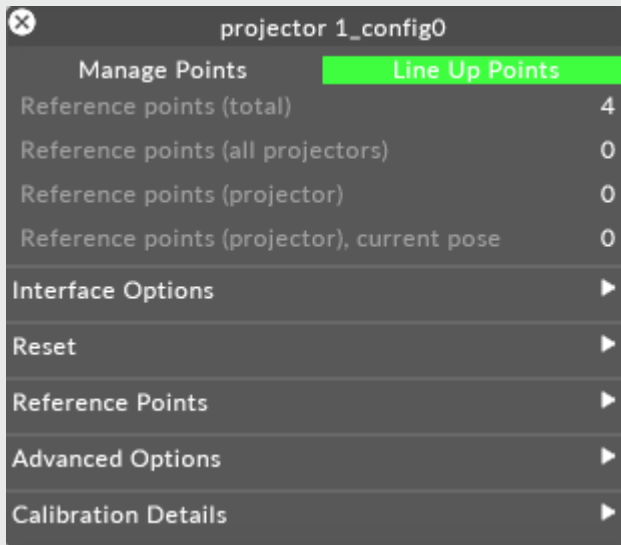

Line up point selection.

**Please note:** You must have the projector you're configuring assigned to an output otherwise the button is greyed-out

- Left-click a point (representing a reference point on the video screen), hold the left-click and drag the cursor in the output and match it to its physical corresponding point.  
Note: The output of the projector you working with will tinted the colour that you have set in the **appearance** tab in the projectors configuration.
- Once the point is in the right position release the point and now its set.
- To adjust cursor location using finer increments use the arrow keys to adjust in 1px movements.

When you have adjusted a point it will be displayed in the colour that matches the projectors colour.



Buckingham Palace with points calibrated.

## Remove a reference point from the projector

This will remove the 2D lineup between the selected reference point and the current projector. The reference point itself will not be deleted.

### To remove a reference point:

- Right-click on the reference point that you wish to remove from the projector lineup. The options menu will open.

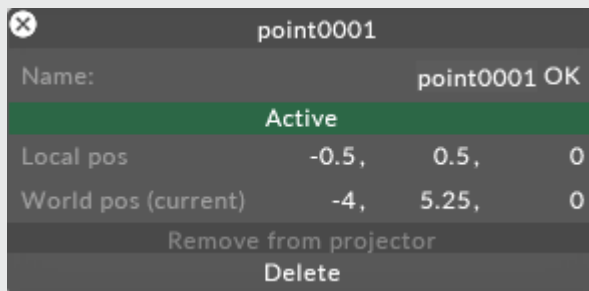

### To remove a reference point from a projector.

- Left-click on the remove from projector button.

## Rotate Controls

This option allows you to rotate your controls whilst lining up, This is especially useful when your projectors are rotated for example if they are portrait in orientation rather than landscape.

There are four options:

- None: Mouse and keyboard operate normally.
- 90 degrees clockwise: mouse and keyboard are rotated 90 degrees clockwise
- 180 degrees: mouse and keyboard are rotated 180 degrees.
- 180 degrees anti-clockwise: mouse and keyboard are rotated 180 degrees anti-clockwise.

## Lineup output mode

Lineup output mode allows you to change what is applied to the output whilst lining up.

**Please note:** During QuickCal lineup all lined up reference points will be drawn on top of the selected output.

You can choose between the following output modes:

- **Content:** Outputs the content that's on the timeline.

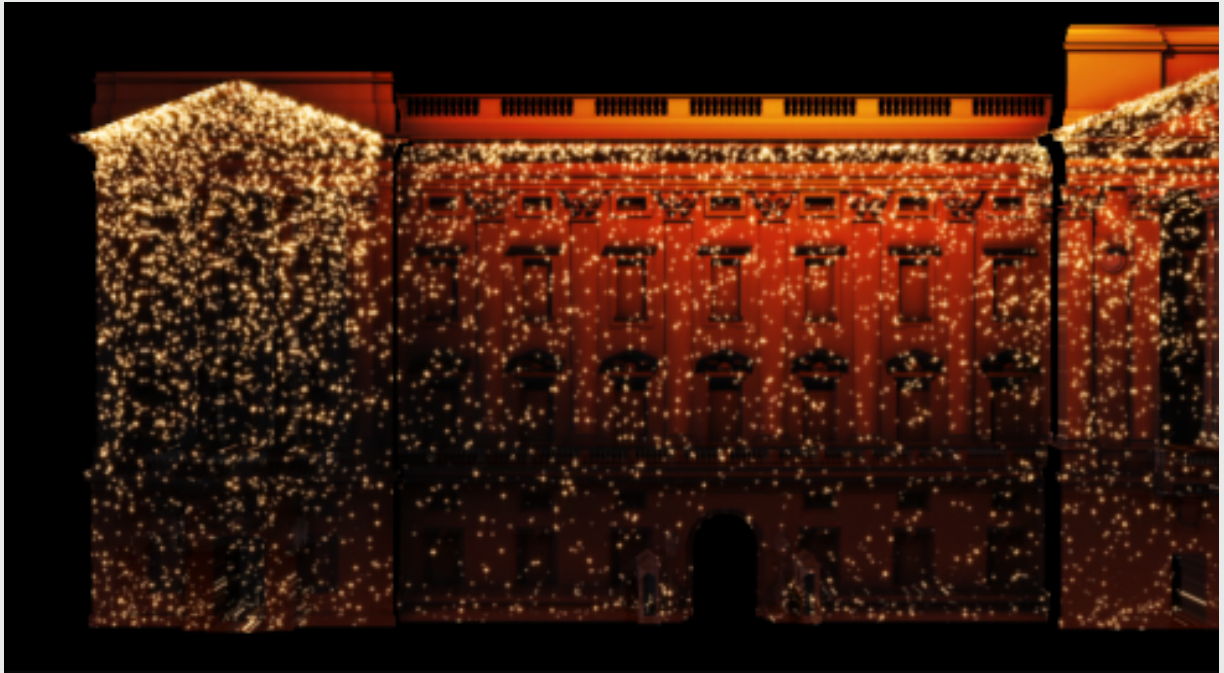

- **Wireframe:** Outputs the wire frame of the model.

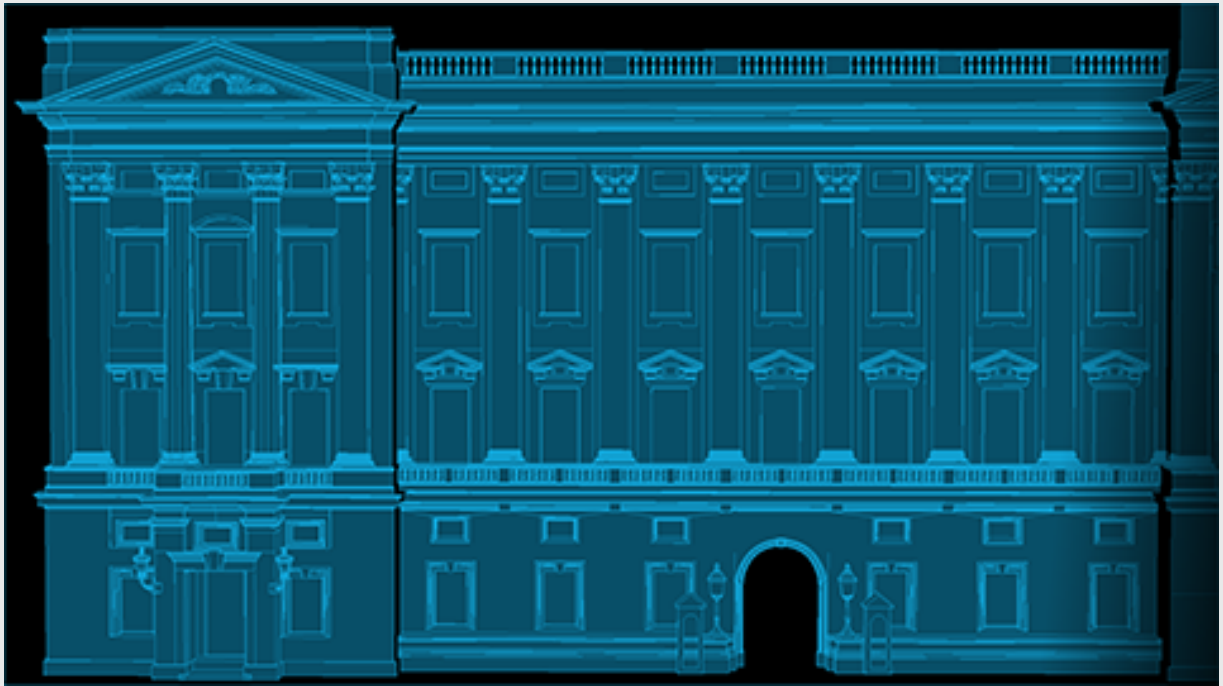

Image of wireframe applied to Buckingham Palace.

- **Identify:** Outputs a full colour grid that has the projectors name on it.



- **Grid:** Outputs a grid that is applied to the model

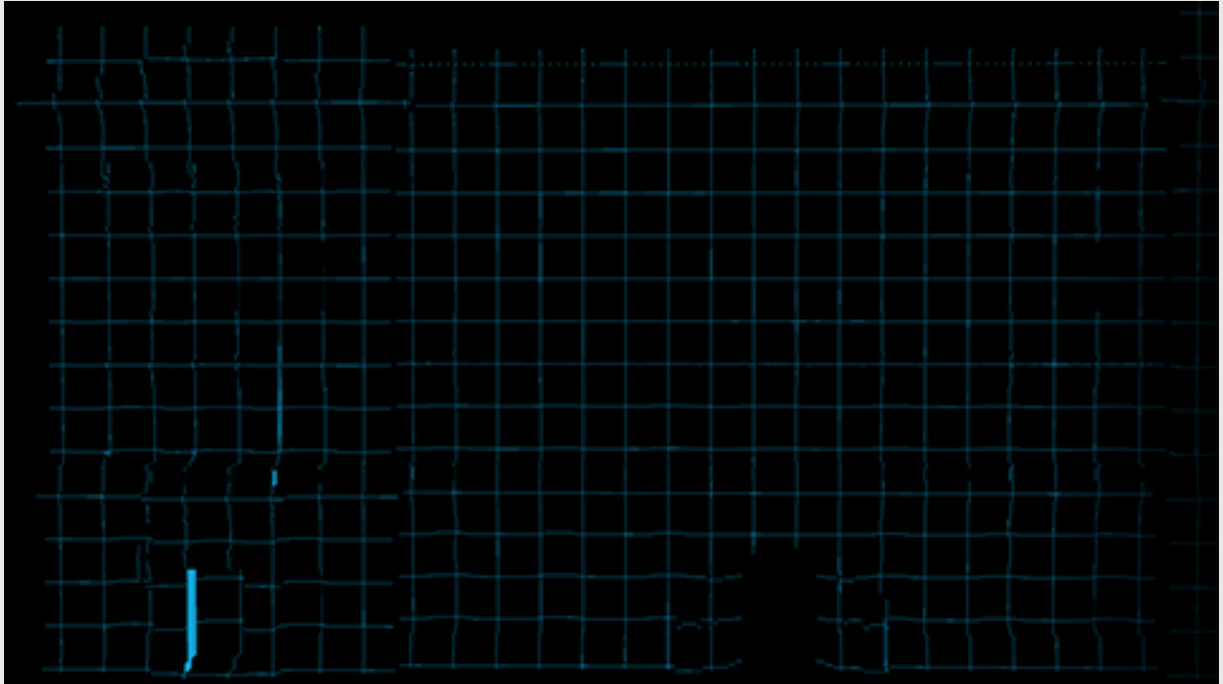

Image of grid pattern applied to Buckingham Palace.

- **None:** Outputs nothing but the line up points.

## Cursor Types

There are four cursor types to choose from:

Horizontal

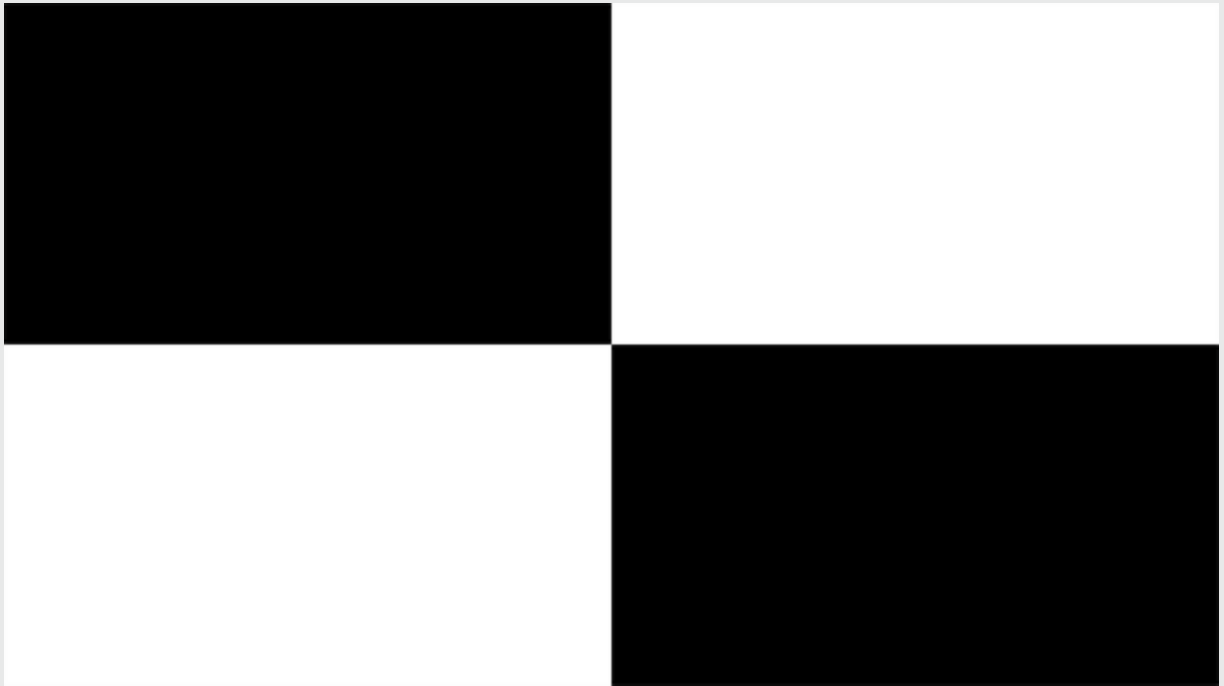

Image of horizontal lineup cursor.

Diagonal

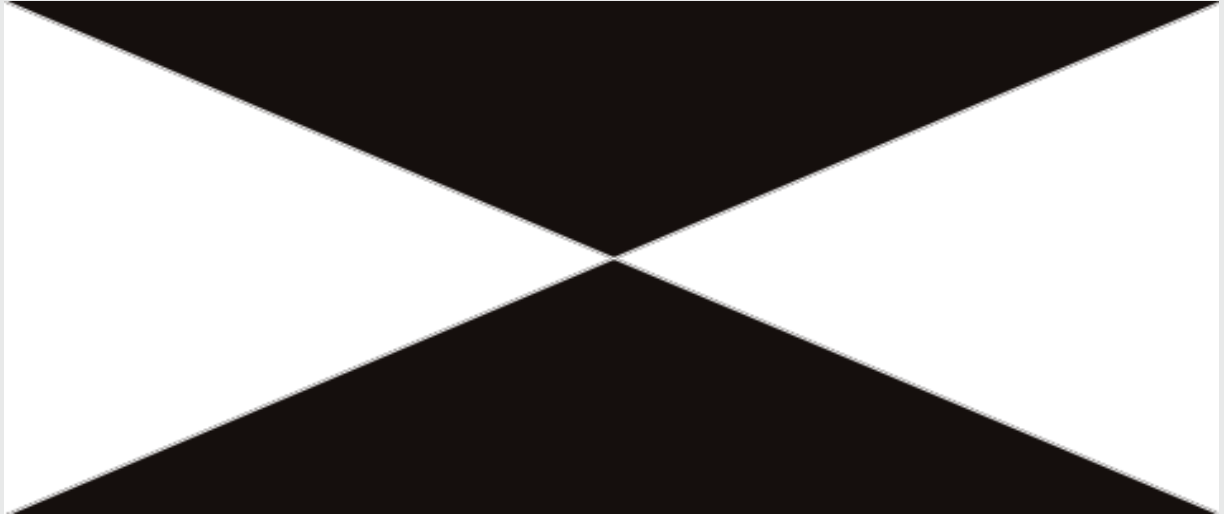

Image of horizontal diagonal cursor.



## Horizontal Lines

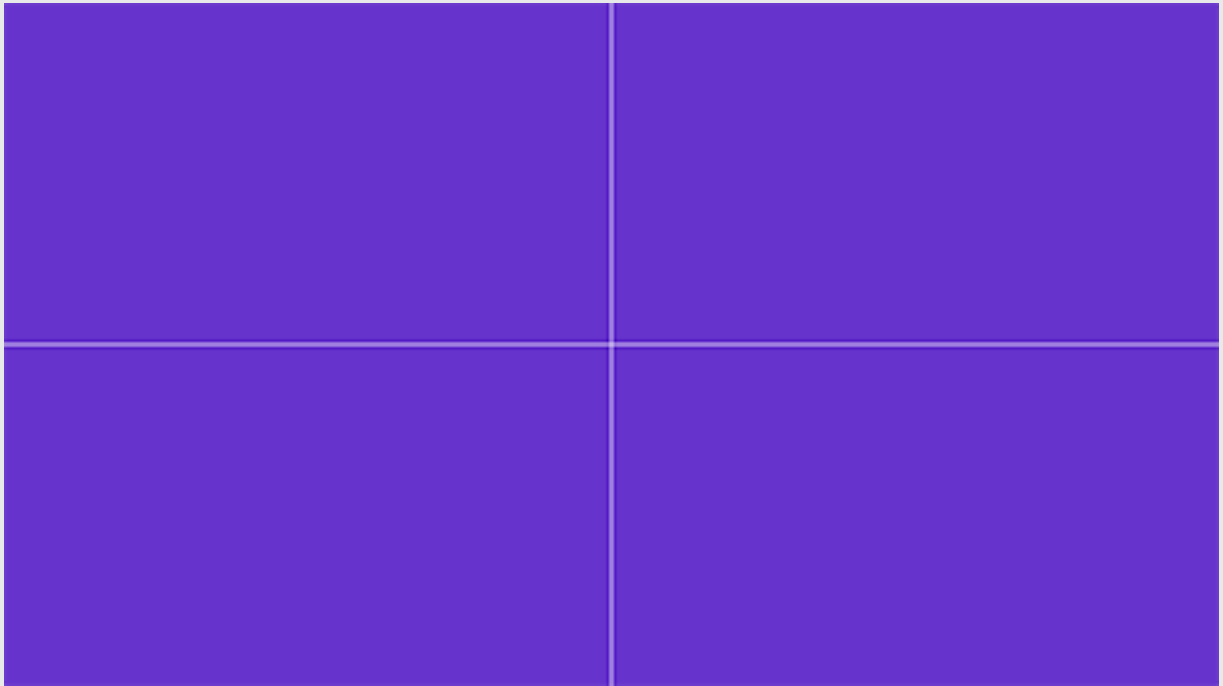

Image of horizontal lines cursor.

## Diagonal Lines



Image of diagonal lines cursor.

## Marker Size

This setting allows you to adjust the size of the marker that's left behind once you have calibrated a point. The default marker size is 16.

## Reset options

To reset the projector so no points have been selected or calibrated either:

- select **reset reference point lineup (current pose)** to reset the points for that pose in a multi-pose line up (see the [Multi-pose calibration](#) sub-chapter for more info on this topic)
- select **reset reference point lineup**

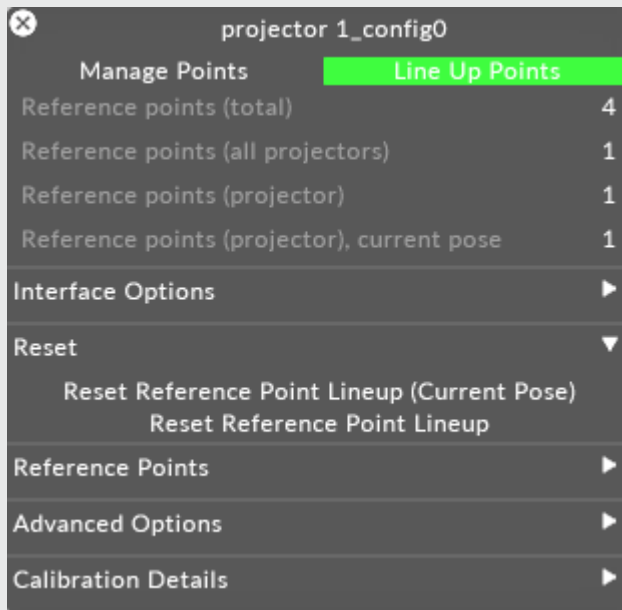

Reset reference point lineup.

- A warning message will pop up when you select **reset projector config**, Click **yes** to **reset projector config**.

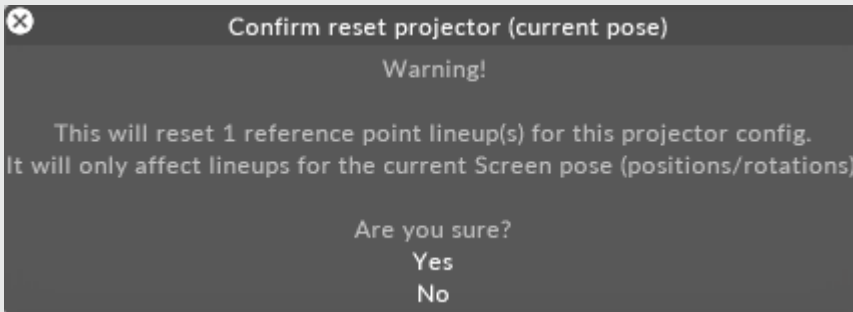

Confirm reset projection config.

## Removing reference points

There are 3 options for removing reference points under the **Reference points** tab:

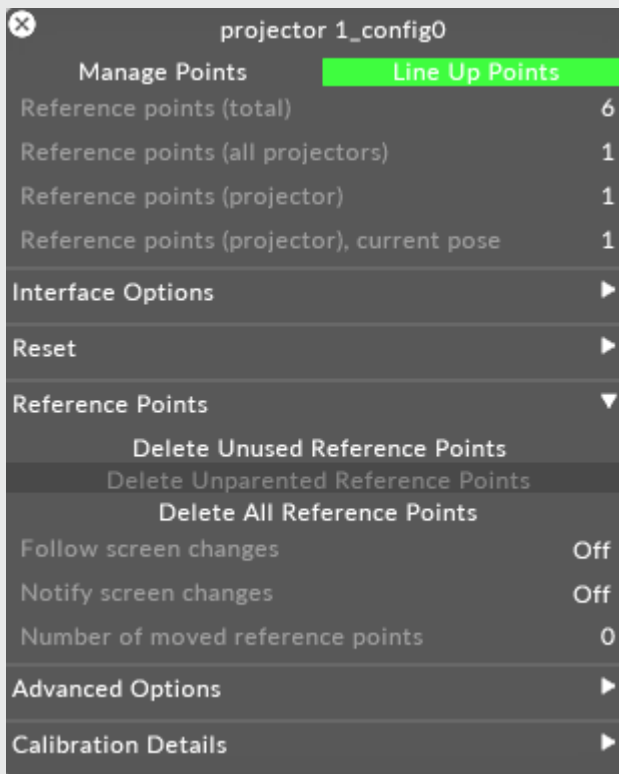

Deleting reference points.

### Delete unused reference points

This option deletes reference points which have not been associated with a projector lineup.

### Delete unparented reference points

This option deletes reference points which are not parented to a screen

### Delete all reference points

This option deletes all reference points from the virtual stage.

A warning message will pop up when you select **delete all reference points**, **Click yes to delete all reference points**.

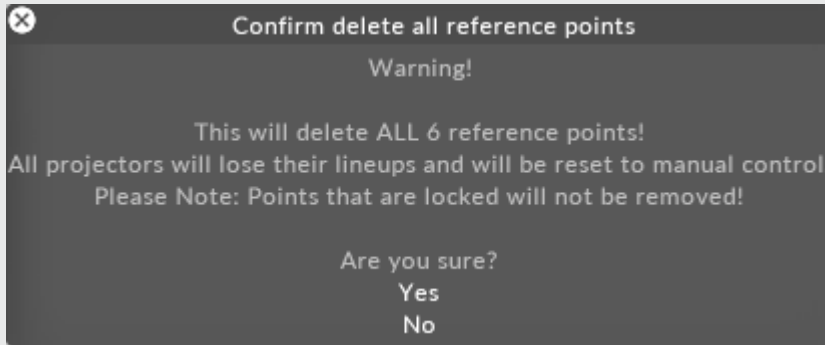

Confirm delete of all reference points.



**Warning:** Delete all reference points is a global action, It will affect all the reference points on the model not just the ones associated with the current projector.

## Advanced options

### Follow screen changes

This option allows you to choose if the reference points follow screen changes. For example if you change your screen position the reference points will move with the screen.



**Warning:** This will automatically update any projector's QuickCal calibration using the new 3D positions of the reference points

## Notify screen changes

This options allows you to choose if you want to be notified of screen changes. For example if the screen position changes and the points move with the screen you will be notified. The notification will ask you whether you want to update the QuickCal calibration with the new 3D positions. It will also show by how much each reference point has moved.

## No. of moved reference points

This informs you how many points have moved with a screen position change for example.

## Auto z-clipping

If auto z-clipping doesn't work, this means some parts of a Screen, which are either very close or very distant, may only be partially visible. then manually adjusting these near/far values can make sure that the projector renders the whole screen.

## Lineup Result

Here is a real world photo of a lineup of Buckingham Palace without the edge blending.



# Multi-Pose Projection

## Calibration Overview

The QuickCal configuration includes a Multi-Pose workflow to allow for the calibration of objects that move.

### Multi-Pose Projection Workflow

1. place the moveable object in a particular position (the “pose”) and then perform a standard quick-calibration.
2. Then rotate the object to a second position.
3. Drag the existing markers to the correct positions and add new ones if necessary, until the projected image is correct and sharp.
4. This process is then repeated for as many poses as are required.

Unlike in the single-pose workflow, we see the dropped calibration points rotate along with the model.

### Example

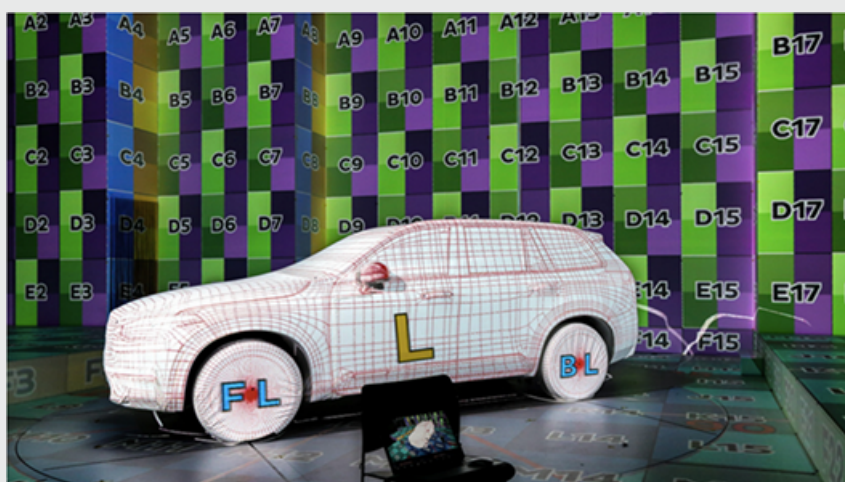

Example application : a car on a rotating turntable, with encoder

In this image, is an example of a car on a motorised turntable. During configuration as the car rotates, the calibrated points gradually drift from their locations on the real model, showing that the calibration isn't perfect across the space. Once the car is in a new pose, we simply drag the existing markers to the correct positions, and add new ones if necessary, until the projected image is correct and sharp.

# OmniCal Overview

OmniCal is a camera based calibration system which gives disguise the ability to “see”.

## Overview

One of the big frustrations of our powerful 3D workflow has always been achieving accurate 3D models and calibrating those - solutions so far have been based around laser scanning or having a skilled CAD person on site who can modify the CAD model when inconsistencies are found between the 3D mesh and reality.

OmniCal removes the requirement to have accurate 3D models using its powerful calibration and Mesh Deform tools.





# Workflow

## Features

- OmniCal uses structured light patterns to calibrate the relationship between projection surfaces, projectors and cameras.
- The captured images are used to construct a 3D representation of projection surfaces as a point cloud.
- Users then use the QuickAlign tool to manually align projection surfaces in the Disguise project to match their real world positions and proportions. This is an “offline” process which doesn’t require access to the physical stage.
- We provide a single click Mesh Deform tool which deforms a 3D Model to match the real world (using the point cloud data)
- Single click recalibration is supported if only projectors have moved. If cameras or projection surfaces have moved then an operator will need to adjust the previous alignment using current camera images.
- The Disguise simulator also allows you to simulate cameras, view their coverage and perform test calibrations to ensure that the system will perform as required on site.



**Warning:** The simulator should be used as part of the production workflow to assess project suitability.

- Supports 360° projection environments.
- Designed for calibration of surfaces and scenes with 3D depth.

View the [OmniCal Product](#) page.

One camera option is available:

- OmniCal MV system: For fixed installs. Reliable, continuous Ethernet camera connection; choice of lenses for three different fields-of-view; cameras only need setting up once.

# Current limitations

- The quality of the calibration will depend on having suitable lighting conditions.
- Requires constant light levels during capture process.
- Works best with low ambient light levels.
- As mentioned above a Simulation must be run first to check project suitability. For large projects we recommend doing separate calibrations with groups of projectors and manually blending overlaps between the groups.
- Requires non-reflective, opaque projection surfaces (no gauzes or mirrors).
- Needs a few clearly defined feature points on the 3D mesh and real object, which can be visually identified on the camera images. Projection surfaces with sharp corners work well for example, but NOT smooth surfaces with no features.
- OmniCal requires depth from the projectors point of view. Scene depth is particularly important when using moving elements such as Automation.

## For a trained OmniCal operator

### 1. Create a simulated Camera Plan

- a. Use the Disguise simulator to check project suitability.
  - a. You can place virtual cameras and simulate a capture and calibration. You will need to have a project file with projectors and projection surfaces in the same configurations and positions as they will be on-site.
  - b. The basic rule for camera placement is that at least 2 cameras need to see every point on your projection surface(s). Also cameras should also have a large angular separation. i.e the directions they face should not be parallel.
  - c. The simulation will help you determine how many cameras are needed, their positions and lenses and the calibration parameters. It will also show you the ideal calibration results you should expect on-site. Note that these ideal results are without real-world influences like unsuitable lighting conditions, reflections, occlusions, movement in the scene during capture etc.

### 2. Setup Cameras On-site

- a. You will need to make sure the position, orientation and field-of-view of your real cameras matches your simulated Camera Plan. To help you with this, there is a camera setup editor that shows what the cameras are looking at.
- b. When mounting the OmniCal MV system, you need to manually adjust the physical focus and aperture (iris) on the lens, so that the images of the scene are sharp and well exposed. Exposure time can be controlled from within Disguise.
- c. From the Camera Setup tool you check how well Blob Detection is working (the dots that we project in the structured light patterns).
- d. You may need to adjust camera parameters (like exposure time) according to the light level to get the best results.

### 3. Capture



**Warning:** A clear stage without movement or major lighting changes is required for this.

- a. Capture is an automatic 'one-button' process that typically takes less than a minute. Exact duration depends on number of projectors, cameras and the resolution of the structured light pattern (number of blobs).
- b. Once this is complete, the physical stage is free. The next steps can be done "offline".

### 4. Calibration

- a. You can view the point cloud after this stage and see check the calibration errors in pixels for each projector.
- b. You may need to adjust calibration parameters to get the best results, but usually these will be chosen automatically.

### 5. Alignment

- a. This is a manual step which aligns the point cloud with the projection surfaces in Disguise.
- b. Users add alignment points to camera images to line up wireframe views of the projection surfaces with reality.
- c. This only needs to be done once as long as cameras or projection surfaces do not move.

- d. Re-shape points can also be added to correct the shape of the mesh. This can be thought of as a 3D warp from the camera's point of view.

## 6. **Mesh Deform**

- a. This is a final key step which deforms a mesh in Disguise software to match the real world by using the depth information from the point cloud.

# For an untrained operator (recalibration)

## 1. **Select Camera Plan**

- a. A user would select a Camera Plan previously created by a trained operator which contains known good settings for Capture, Calibration and Alignment.

## 2. **Rig Check**

- a. This tool allows a user to compare live camera images to those from a previous Capture to check whether cameras or projection surfaces have moved. If so, the user can adjust the alignment reference points by dragging them into the correct positions.

## 3. **Execute**

- a. A button which triggers a new Capture and Calibration using the settings from the Camera Plan.
- b. No user interaction is required after this point. Projectors will automatically be calibrated at the end of this process.

# Hardware

OmniCal Machine vision camera kit

The OmniCal MV system come in kits up to 4 or 8 (depending on kit size) and are perfect for fixed installs. They are powered via PoE, so only require a single Ethernet connection.

Lenses including 6, 8 and 12mm are incorporated into the kit depending on your project needs with a total of 24 lenses available, allowing for on the fly customisation to ensure the perfect setup.

## Small Kit

**Upper Foam**

---

Up to 4 disguise MV Cameras

#### **Lower Foam**

Up to 12 Lenses

Options Include:

- Fujinon 6mm Lens
- Fujinon 8mm Lens
- Fujinon 12mm Lens

## Large Kit

#### **Upper Foam**

Up to 8 disguise MV Cameras

#### **Lower Foam**

Up to 24 Lenses

Options Include:

- Fujinon 6mm Lens
- Fujinon 8mm Lens
- Fujinon 12mm Lens

## Not included:

The kits do not contain network equipment like cables, switches or PoE injectors. The Disguise MV cameras require a switch that provides at least 1 GBit/s bandwidth and supports PoE to power the cameras.

## Field of View options

The Disguise OmniCal kits offer camera and lens options to provide various needs in terms of camera coverage and Field of View angles (FOV).

The widest Field of View is with a disguise machine vision camera on a 6mm lens. The most narrow / tele option is with a 12mm lens.

Please note that the Field of View / opening angle depends on the focal length of the lens, and also the physical size of the image sensor. For example, the camera inside an iPod has a much smaller image sensor compared to the disguise MV cameras. Given a certain focal length, a smaller sensor will result in a smaller FOV than a larger sensor.

The focal length mentioned in a lens data sheet is usually the actual value, not the 35mm-film-equivalent. Therefore focal length values can only be directly compared for cameras with the same sensor size.

In our d3 software all information regarding focal length, 35mm-equivalents and FOV is either editable or automatically calculated, when editing a Camera in an OmniCal plan.

An overview of OmniCal camera and lens combinations and the resulting field of view:

Disguise G-507 machine vision cameras have a 3.908 crop factor (compared to 35mm film) when used with approved C-mount lenses.

<b>Focal length</b>	<b>Focal length 35mm equivalent</b>	<b>Horizontal Field of View angle</b>
<b>6 mm</b>	<b>23.4mm</b>	<b>~70.6 degrees</b>
<b>8 mm</b>	<b>31.3 mm</b>	<b>~56 degrees</b>
<b>12 mm</b>	<b>46.9 mm</b>	<b>~39 degrees</b>
<b>25 mm</b>	<b>97.7 mm</b>	<b>~19.3 degrees</b>

## Tips & tricks

- The fast way to tell if you have a good calibration is to look at the reprojection scores for each projector and camera in the calibration report (this is found at the very bottom) - any score below 1 pixel is considered good, similar to the error margin that would be accepted when using QuickCal.
- Anything above 1 pixel usually indicates that something went wrong. In simulations you will normally see errors of around 0.5 pixels or below.
- Avoid reflective surfaces as they can cause issues with calibration

- Use surfaces with a lot of depth features as they make the calibration more accurate. It is especially important to have depth from each projector's "point of view". For example, if all the visible blobs from a projector land on a flat surface it will not be calibrated correctly. One way to fix this is to place an object in your environment temporarily during a capture to provide depth information.
- Each blob needs to be seen by at least 2 cameras to be used in a calibration
- Ensure blobs from across a projectors output can be seen. For example, if only blobs from the top left of a projector are detected it won't be calibrated correctly.
- Ensure a large difference in angles of attack between cameras.
- Capture Setup is important for good blob detection - you will most likely have to change the blob size, grid density and camera exposure to suit your environment.
- Blobs should be as small as possible while still being detected by cameras. This improves the calibration accuracy. Also if they are too large they won't be detected at all.
- Elongated blobs can cause higher calibration errors. Try reducing the blob size to handle this. Avoid large angles between the projector and projection surface normal e.g 45 degrees
- More blobs doesn't mean a better calibration. Usually the default of grid size of 32 is sufficient. Use more blobs if you require a detailed point cloud for Mesh Deform.
- Avoid lighting gradients, if the light level changes across an image blob detection may not work as well.
- If you are calibrating a perfectly flat surface and getting strange results, toggle the epipolar/homography camera calibration algorithm under the Plan's Calibration Setup window and see if you get a better result.
- If most blobs are landing on a flat surface this can skew the calibration results in favour of those areas. Enabling planar point removal in the Plan's Calibration Setup window may improve your results.
- It can be difficult to line up geometrically symmetrical shapes (cubes / pyramids / bowl shapes). You could embed features or identification letters and numbers into the OBJ. You can also name reference points in the Quick Align window.
- Surfaces without corners or visible reference points such as domes and cylinders are difficult to line up.
- If you need to use mesh deform, use the point cloud visualisation mode to preview the results

- Point cloud visualization affects performance, once you have verified the validity of your calibration, turn it off to ensure good performance.



# Troubleshooting

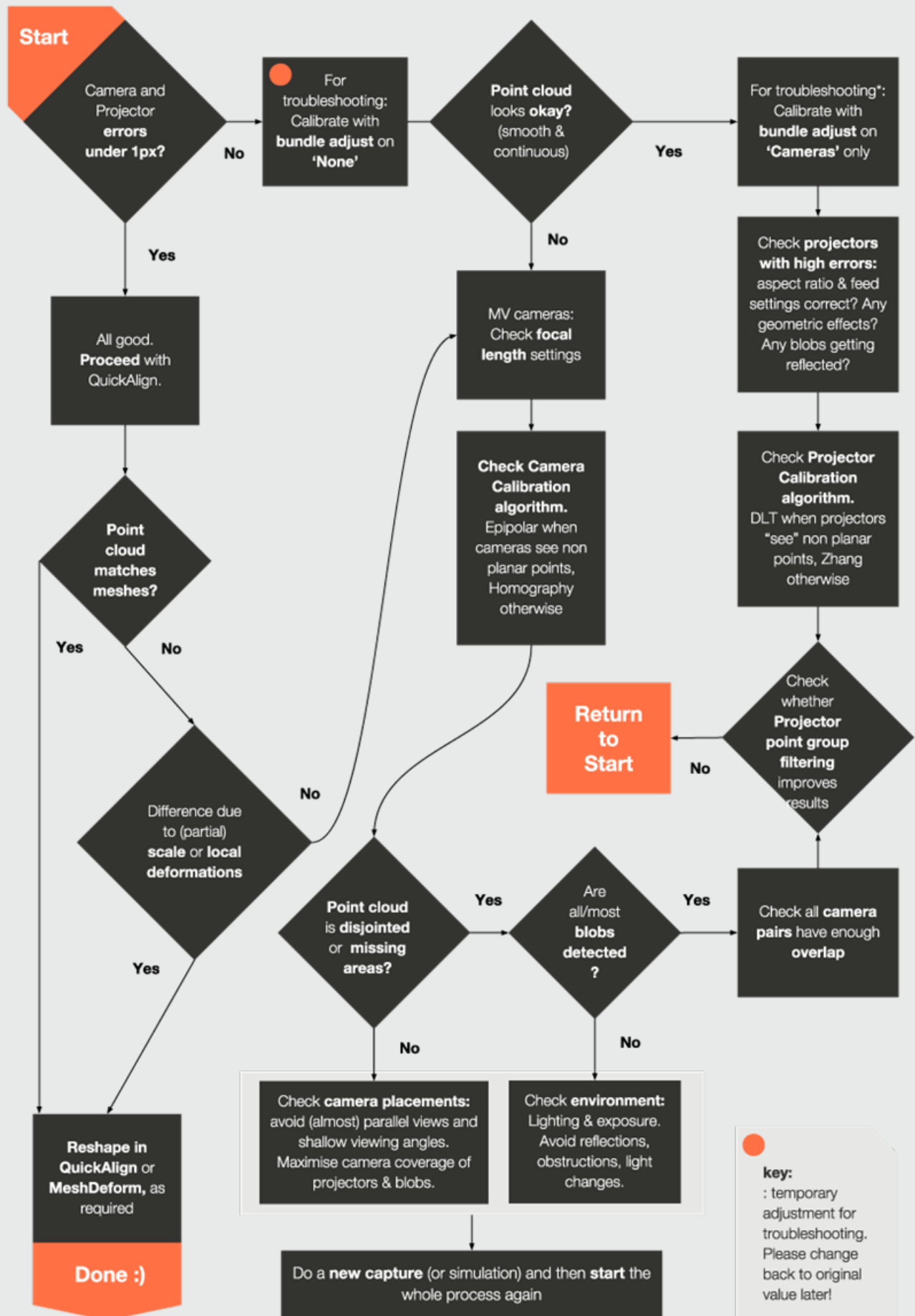

# OmniCal Camera setup

This camera setup must be done before you run Disguise software.



**Warning:** OmniCal camera networks must use a separate network adapter to all other network traffic.

## Overview

1. Download [Vimba for Windows](#).
2. Install Vimba Viewer to configure the cameras.
3. Network setup.
4. Verify camera connections.
5. Adjust exposure & focal length.

## OmniCal MV system

### Network setup



**Warning:** OmniCal MV system cameras use all the available network bandwidth, so they must always remain on a dedicated network, away from any other traffic.

**Please note:** When Camera Discovery is enabled, machine vision cameras continuously capture images and send them to master. This only affects the camera network and not disguise directly, however it consumes CPU time processing these packets.

**Please note:** Camera Discovery can be disabled explicitly in the OmniCal Calibrator window and is also turned off automatically when the OmniCalCalibrator and Plan windows are not open.

## Network infrastructure:

The OmniCal MV system is based on the GigE Vision (R) standard and requires a bandwidth of 1 Gb/s or higher. For example, on 10 Gb/s setups the discovery of Disguise MV cameras and the transmission of captured images will be faster.

The Disguise MV cameras are powered via PoE, which needs to be provided either by the network switch or a PoE injector. The power requirement over PoE is quite low at 2.8W.

Make sure that all parts of the network infrastructure (switches, cables...) match the desired bandwidth and power specifications.

In case of wired cables (as opposed to fibre), we recommend using at least Cat6 cables, because they are more reliable than Cat5e over longer distances or in the presence of electromagnetic interference (EMI).

## Network Adapter Setup

You may need to update to the latest drivers to see some of these advanced options.

- Jumbo Frames: Enabled, with packet size (MTU) 8228 bytes or larger (e.g. 9000 or 9014, depending if the adapter counts the packet header or not).
- DMA Coalescing: Disabled (since it may increase latency)
- Flow Control:
  - » Can be left in default setting. (In most network situations enabling it for Rx/Tx is beneficial, but it will not have an impact on GigE Vision performance).
- Interrupt Moderation Rate: Extreme
- Transmit buffers: 256 bytes
- Receive buffers: max setting available, e.g. 4096 bytes
- See [here](#) for further explanation.

# Setting up the Network adapter

1. Navigate to the **Network and Sharing Center** and click to open the **D - Media 10Gbit adapter**.

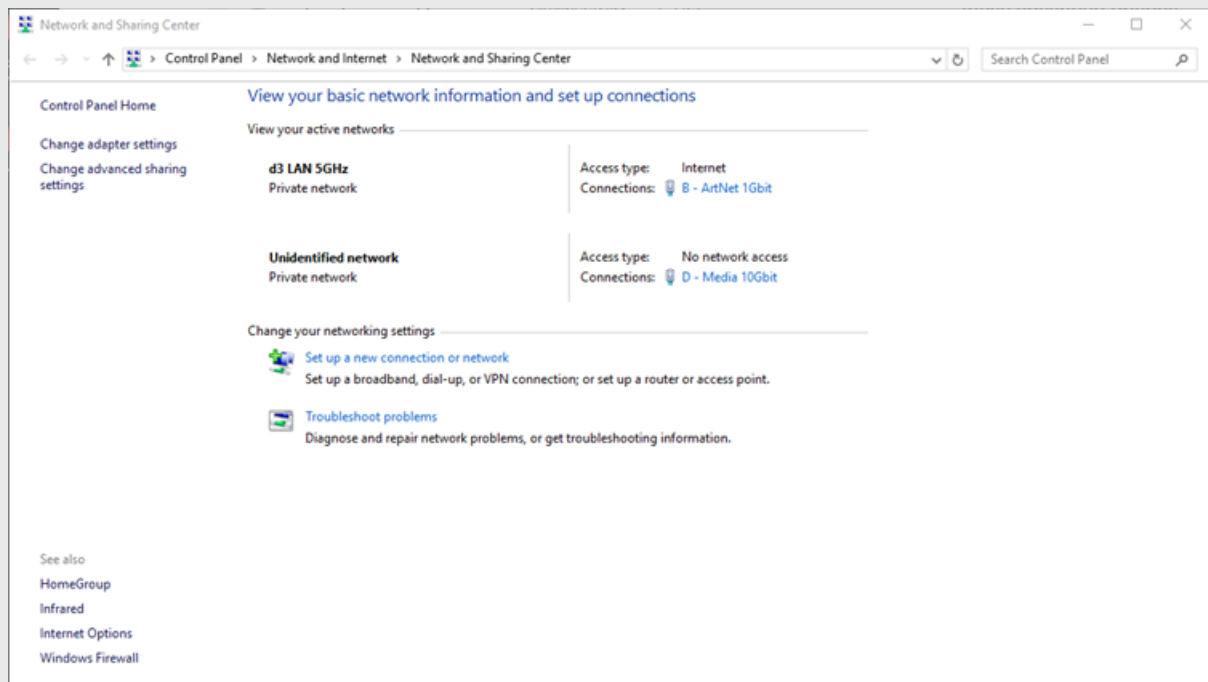

2. On the General tab, click to open **Properties**.

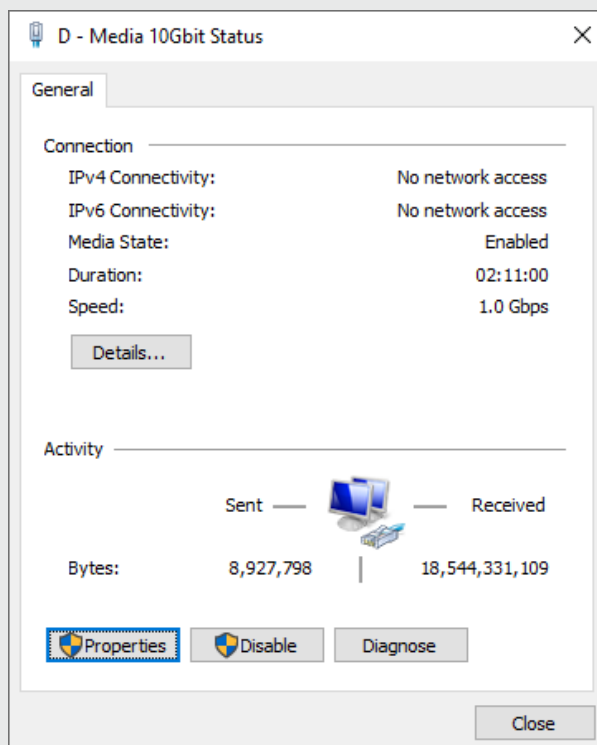

3. Enable the following settings and click **Configure**.

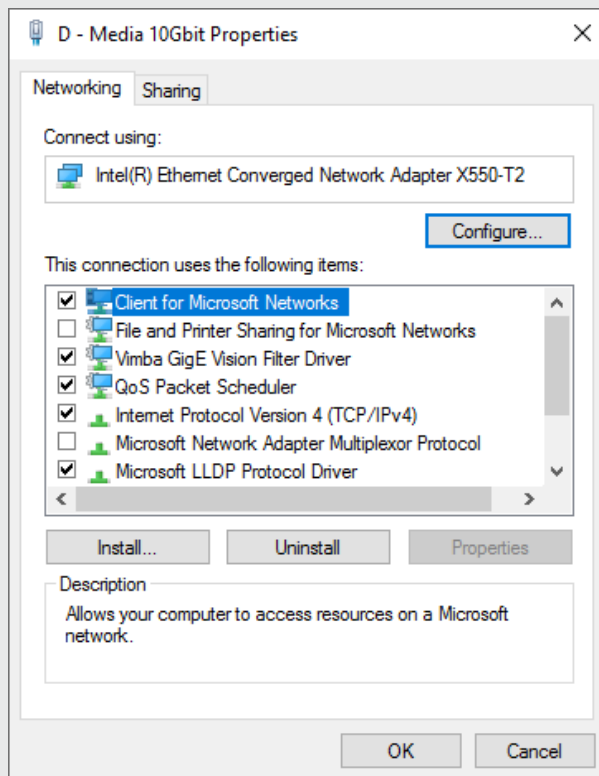

4. Select **Jumbo Packet** and assign it a value of **9014 bytes**.

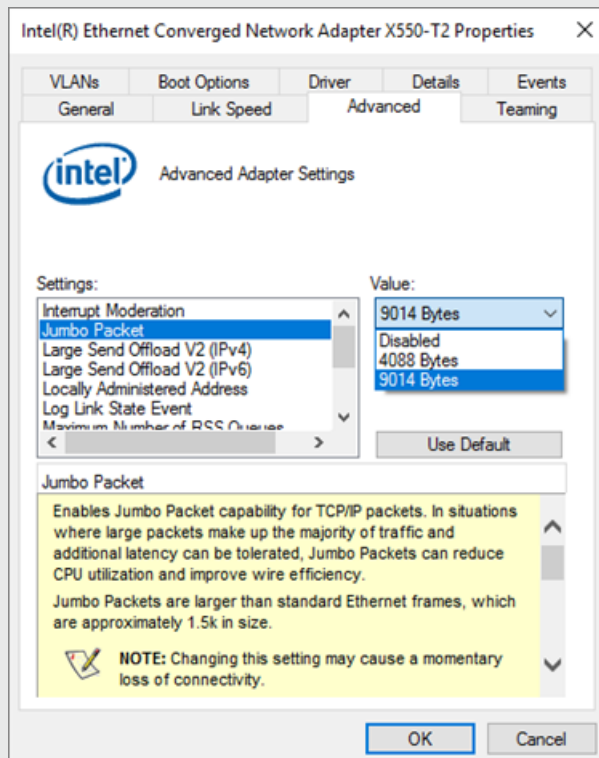

- On the Advanced tab, select **Performance Options**.

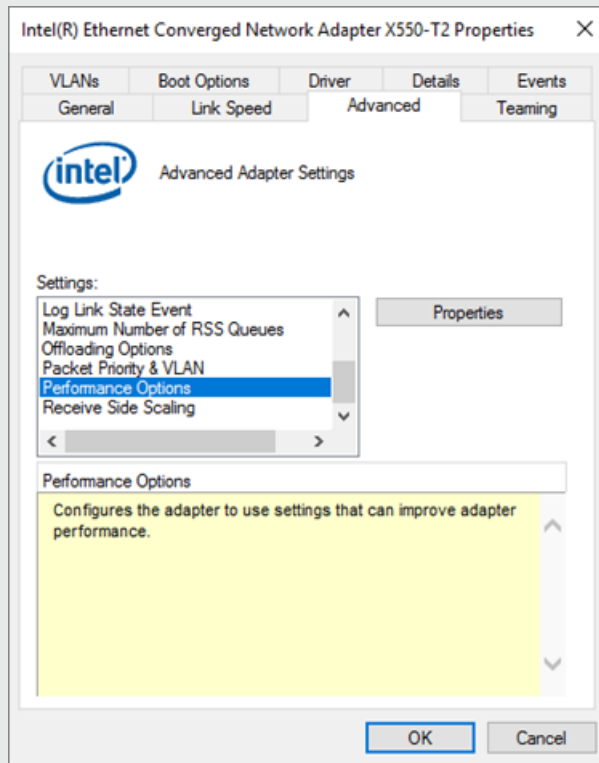

- Select **Flow Control** and click **Disabled**.

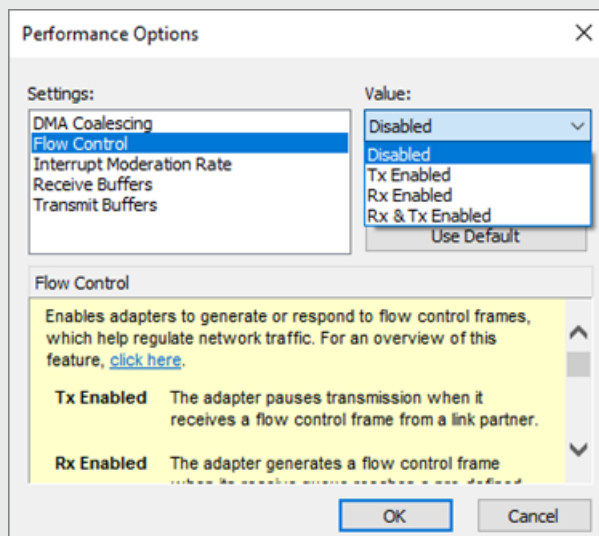

7. Set the **Interrupt Moderation Rate** to **Extreme**.

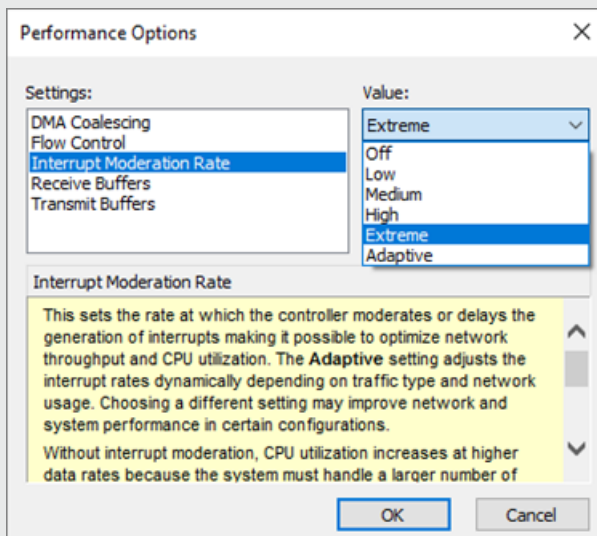

8. Select **Receive Buffers** and set it to **4096**.

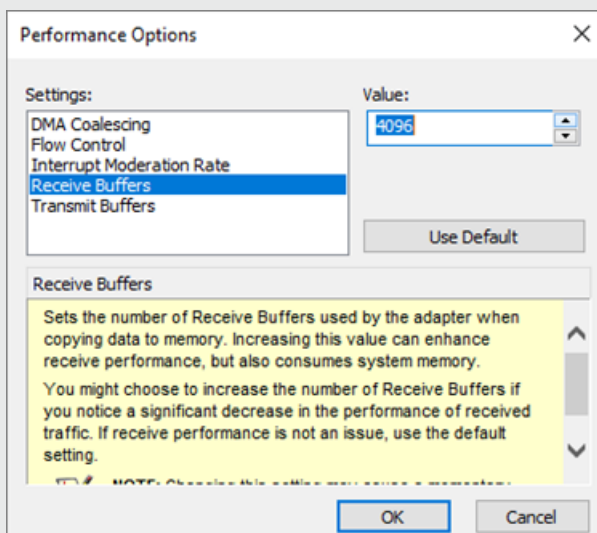



9. Select **Transmit Buffers**, set it to **256** and click **OK**.

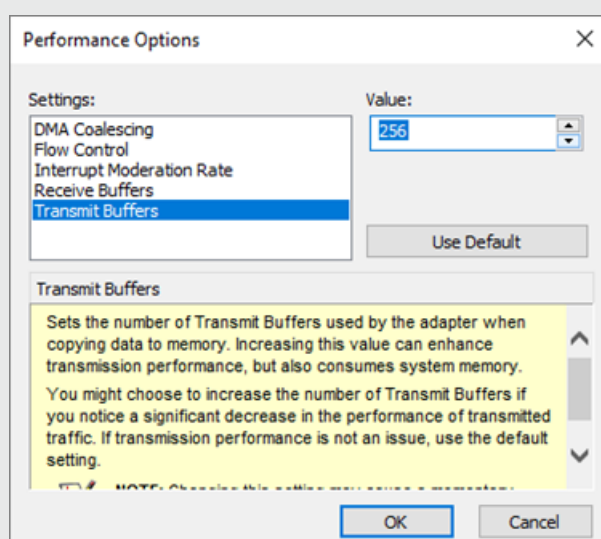

**Please note:** A 1 Gb port should work fine but we normally use a 10 Gb port when available as the max receive buffer size is larger. Some network adapters may show some of the above settings under an Advanced button. Others may not provide some at all. E.g. the external Promise SANLink3 adapter only offers the Jumbo Frames setting.

## Switch Setup

1. Connect a PoE network switch with bandwidth 1 Gb/s or higher.
2. Enable jumbo frames/packets by setting the max packet size to the highest it will go (usually around 9k).

## OmniCal MV system setup (in windows)

The Vimba software installs camera drivers, SDK and the Vimba Viewer application used for testing and trouble shooting.

1. Install Vimba for windows SDK from [here](#).

**Please note:** We recommend Vimba Viewer v2.1.3

2. In the Vimba installer, select **Application Development**.
3. Keep **install drivers** checked and complete the installation as normal.
4. Hit Start.

## Open **Vimba Viewer**

5. Plug your cameras in if they are not already.
  - a. They will show up in the Detected Cameras list in Vimba, in white.
  - b. These may have a red lock icon on them if Disguise software is running. Camera access is exclusive to each application. I.e. if you have a camera capturing in Disguise software you will not be able to view it in Vimba and vice versa.

## Verify camera communication

1. Open Vimba and select a camera.
2. Press play button and verify images are streaming

**Please note:** In case camera connections are lost, and replugged, the software should detect them again, but in case they don't you can press the refresh button in the top left corner.

## Troubleshooting

- No image is displayed in Vimba Viewer: try disabling jumbo frames on the network adapter. We've seen this can be an issue on 4x4s. When using jumbo frames over 2034 bytes we aren't able to get complete images from the cameras (due to packet loss). The other workaround is to limit the packet size on the switch. Use Vimba Viewer to verify the GVSP packet size setting is 2034 or below. This is negotiated automatically so you don't set this directly.
- Network adapter becomes disabled after applying the above settings: try reverting the interrupt moderation rate to the default.
- Capturing images is very slow / cameras become unresponsive: try reverting the interrupt moderation rate to the default.

## Configuring cameras in Vimba

You can right-click or double-click on the cameras to see and adjust metadata of the camera.

This window also shows the Play button in the top left hand corner, on pressing this the camera image should appear in this window, this can be zoomed using the mouse scroll button.

## Focus, aperture and focal length

Align the cameras to look at the object that is to be projected onto. Adjust focus as needed. We recommend that you open the aperture as far as it can go, so you can use the exposure time to control the amount of light that comes in. Make note of the focal lengths used by the cameras, you will need these later.

## The Brightness Tab

### Exposure time

Exposure time will heavily depend on the light levels in the calibration environment. On the right hand side you will see a value in milliseconds that allows you to calculate roughly the FPS the camera is producing. High exposure time will make it slow.

The other parameter we will not touch. The only other tab we'll interface with is the All tab.

### All

Here we can type in a filter pattern and search through settings. We might need to change the DeviceUserID here. Just type it in and click search. The ID will be visible inside disguise.

## Connecting to cameras in Disguise software

Part of Disguise software is a separate program called VimbaCamServer.exe which is used to discover and connect to one or more OmniCal MV system cameras on a network.

- In Disguise software the **OmniCal Calibration editor** configures and enables camera discovery on the network.
- Usually, the VimbaCamServer is launched automatically from within disguise, as soon as the Discovery Adapter is set to the localhost Loopback adapter. In that case, the network switch with the cameras needs to be connected directly to a separate network adapter on the disguise server.
- The VimbaCamServer can also be run separately, e.g. on a standalone computer. In that case the Discovery Adapter inside disguise needs to be selected as the network port with which the disguise server machine is connected to this other computer. The disguise server then does not need a direct connection to the OmniCal MV system cameras or the network switch they are on.
- In other words, the Discovery Adapter needs to be set to the network adapter that the camera server app is on. For an OmniCal MV system the VimbaCamServer can be anywhere as long as it can somehow see and connect to the cameras.

The Mobile Cameras button opens a list of cameras that are currently connected to disguise. If you have many MV cameras on a network (especially if it is only 1Gb/s), then the cameras may appear one by one over the course of several seconds.

# Renaming cameras in Vimba Viewer

It is recommended to add unique names for each camera for easier identification within Disguise software. Follow these steps to set this up:

1. Open Vimba Viewer.
2. Locate the setting "DeviceUserID" (not to be confused with a similar setting labelled "DeviceID" which can not be changed).
3. Rename the camera as desired.

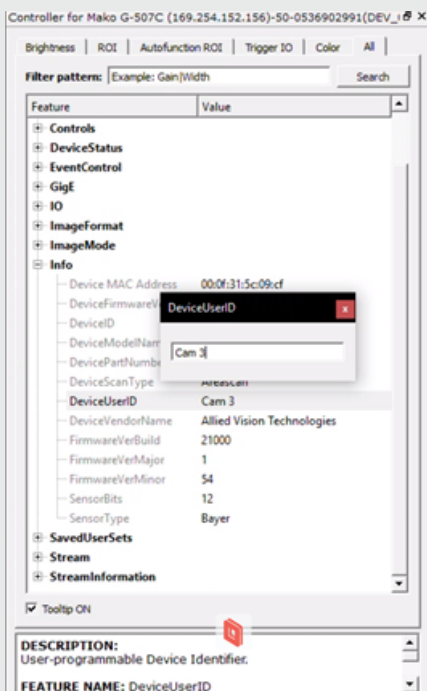

4. Press Enter and close this window. Note that Vimba must be closed in order for the re-name to be visible.

## Further Reading

[GeniCam Network Card Performance Settings](#)

[Advanced Driver Settings for Intel®Ethernet 10 Gigabit Server Adapters](#)

# OmniCal Capture

Capture is the process of projecting structured light patterns and taking images of these to later use in the calibration process.

## Overview

OmniCal Capture is the process of projecting structured light patterns, taking images of these and detecting blobs within these images.

1. Define the position & properties of cameras and projectors.
2. Setup the Capture.
3. Perform the Capture.

## Workflow Example

### Defining cameras & projectors

1. Left click the OmniCal calibration editor from the stage editor to open it.
2. Create a new Capture Plan by right clicking the capture plan to open the **capture plan manager**, entering a name in the new plan field and clicking **OK**.
3. Right click the newly created capture plan.
4. At this point, if you wish to do a simulated capture, set **Use simulated cameras** to Yes.
5. Click the **+** icon to add each of your cameras to the plan.
6. Right click on each of the plan cameras. This will open up the Camera plan editor.

- a. Left click Mobile Camera and select the required camera from the list of available cameras.
  - b. If you are doing a simulation, you can choose your virtual camera settings here.
7. Click the + icon to add your projectors to the plan.

## Setup capture

1. Left click **Setup Capture** to open the Capture editor
2. Set the blob size and the grid size.
  - a. The blob is the size of the blobs we are projecting in pixels.
  - b. The grid size is the number of blobs projected horizontally.

**Please note:** Generally speaking, blobs should be as small as possible whilst still remaining detected by all cameras. More blobs does not necessarily mean better calibration, but will increase calibration time. 32 blobs across should be sufficient for most use cases. More blobs can be useful in a scenario where mesh deform needs to be used.

3. Left click **Grid** to see how many blobs are projected, and how well they cover the surfaces you are calibrating.
4. Left click on **Blobs**. A test blob detection will be performed highlighted in the camera views. The colour coding of the blobs is based on the colour of the projector wireframe. The blobs should be made as small as possible, whilst still being detected in this view.
  - a. At this stage, you may need to adjust camera exposure for better blob detection.
  - b. To adjust exposure, left click on the camera name and adjust exposure time in the camera plan editor.

**Please note:** A good way of getting setting a suitable exposure time, is turning continuous capture on, selecting grid mode and adjusting the exposure time and turning continuous capture off when you are happy the blob levels are clearly visible.

5. Ensure your **Alignment level** in the Capture setup is at a level where you can see the detail on your models clearly, as this image is the one that will be shown in Alignment.

## Performing a capture



**Warning:** The stage should be clear.

**Warning:** No changing light levels.

**Warning:** No people walking across stage.

1. Click **Capture** from the OmniCal plan editor
2. The system will perform a capture, the time taken will depend on number of projectors & cameras and whether projectors are converging or not. For example, 4 cameras & 4 projectors non converging takes roughly a minute.
3. Verify the results of the capture by clicking **View Capture**.
4. Left click **Blobs** from the **View Capture Editor**.
5. Verify the blob detection results are as expected. These results should be consistent with what you saw in the capture setup. If something went wrong with the capture (change in light levels, people walking across stage), then perform the Capture process again.

# Camera Diagnostics

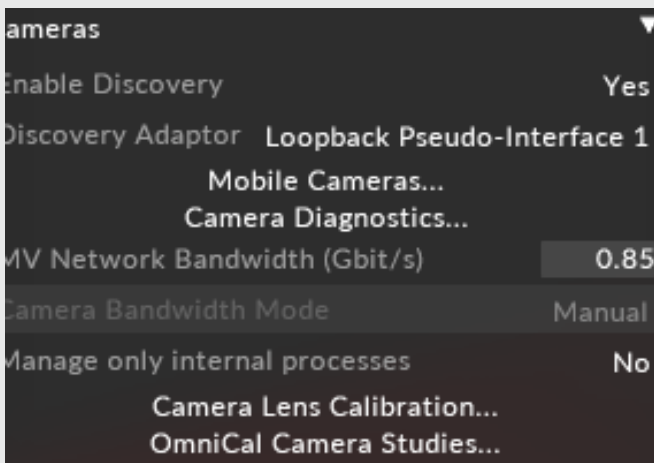

Available in the camera collapsible widget.

1. This will only be enabled if there is a plan and there are plan cameras mapped to MV cameras.

The following is shown for info:

User Name	Device Name	IP Address	Frames Delivered [c]	Frames Incomplete [c]	FPS Camera	Frames Delivered	BW (Bytes Per Second)	Test	Graph
cam 1	gnc_01	192.168.0.135	0	0	0	0	0	Start	Open
cam 2	gnc_02	192.168.0.108	0	0	0	0	0	Start	Open

2. Right click header to show columns:

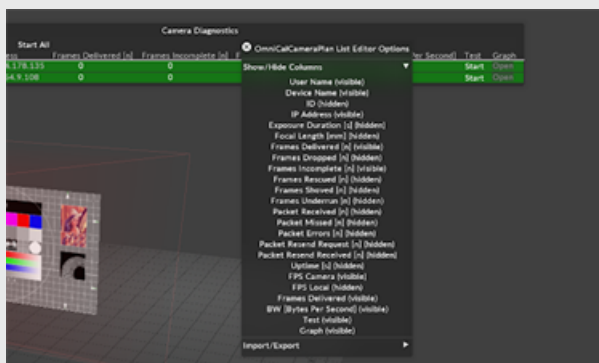



3. This displays camera stats and feedback of settings (such as IP, name). Disguise software only displays plan cameras.
4. Click **Start Per Cam** to enable stats feedback.

Visit this [link](#) for additional information about each of the specific stats.

## Column descriptions

- **Frames incomplete** is the only one measured by Disguise and provides some feedback to the user as to the stability of the cameras in vimbacamserver.  
  
This setting indicates that Disguise software failed to validate the frame data or there may have been an exception when handling frame data from vimba api.
- **Green** means cameras are ok and receiving data from vimbacamserver (with respect to the stats measuring incomplete frames between each receipt of stats).
- **Red** means there have been incomplete frames between the last read and the current read.  
  
The count of incomplete frames will continue to increase .  
  
The red colour will reset if there have been no incomplete frames between each read of the stats.
- Grey indicates the camera has been disabled.
- **Brown** indicates the camera is disconnected/ offline.
- Change mv camera BW to adjust bw per camera. This is split between cameras.
- The graph button will show the stats in graph format.
- Bandwidth allocation can be adjusted while diagnostics are running.
- Dropped packets means you need to lower the bandwidth settings or there is a physical problem like a bad cable

# OmniCal Calibration & alignment

## Overview

The calibration process triangulates the position of the blobs detected in a capture as well as the relative positions of cameras & projectors and their lens intrinsics.

Alignment is the process of marrying the point cloud coordinate system with that of Disguise software.

## Workflow

### Calibration

- Once the calibration is completed, you can view the point cloud and check the error in pixels, for each projector.
- You may need to adjust the calibration parameters to get the best results, but usually these are chosen automatically.

### Alignment

1. Manually align the point cloud with the projection surfaces in Disguise software.
2. Add alignment points to the camera images to line up wireframe views of the projection surfaces with reality.
3. This only needs to be done once as long as cameras or projection surfaces do not move.
4. Re-shape points can also be added to correct the shape of the mesh, this can be thought of as a 3D warp from the cameras point of view.

## Example

# Calibration



**Warning:** From this point, you no longer need access to the physical stage to continue the calibration process.

1. Click **Calibrate**

The system runs the calibration and reports the calibration results in the calibration results widget. The pixel error per camera & projector will be displayed at the bottom of this widget. Values below 1px are considered good, and above 1px usually points to something going wrong in the process.

The generated point cloud will appear in the Disguise stage visualiser at this point but will not be aligned to the stage, unless you previously performed an alignment.

## Alignment

1. The generated point cloud will be aligned to the stage based on the previously performed simulated calibration. If no simulated calibration has been performed, the point cloud will be unaligned with the stage.

There are some automatic options to automatically align the point cloud to the stage. Click **Quick Align**, and choose **Alignment Estimate** which is automatic alignment estimation based on point cloud and all projection surfaces.

**Align to plan cameras** which is the automatic alignment based on positions of plan cameras.

**Align to plan** which aligns to plan cameras and projectors.

**Align to point cloud** is useful for alignment using 2D camera reference points. Use this option when you want to apply the current alignment data to the stage.

If the Alignment assistance tools do not work, proceed to the next step.

2. Manually align the point cloud with the stage using **Initial position**, **Initial rotation** and **Initial scale** settings.
3. Once the point cloud is roughly aligned, you can perform a **Quick Align**.
  - a. Left-click **Quick Align** to open the Quick Align editor.
  - b. The top two views relate to cameras which can be chosen from the view tab.  
The bottom two views relate to the cursor location in the camera view. This is essentially a zoomed in view, for better view finding.
  - c. Left-click a point on the wireframe.

- d. Drag it to the corresponding point in the image. Do the same for the corresponding point in the second camera view.
- e. Repeat this process for a minimum of three points.
  - i. Red point means this point is not being used as part of the alignment, but has been added to the view.
  - ii. Yellow means it has been aligned in the current camera, but it is not being used in the calculations.
  - iii. Orange means it has been aligned in a different camera.
  - iv. Green means it has been aligned in both cameras and is being used in the calculation.
  - v. Selected points flash, and you can use the arrow keys to move them around.
  - vi. When points are selected, use **SHIFT** + arrow keys to move the point around & hold **CTRL** & left-click for fine control.

## Alignment re-shape

If the proportions of the model are correct, the alignment should fit perfectly. If the proportions are not correct, you will need to perform a reshape. This can be done by holding **SHIFT** and left-clicking a point which will turn it into a reshape point. Left-clicking the point again will turn it back to a alignment point. A reshape does not use the point cloud, and simply adjusts the proportions of the model to match.

## Multi-screen alignment

- The master screen should be aligned first.
- It not moved on the stage. It acts as a registration point for other screens. Reshaping or scaling of the Master screen will therefore affect all other screens.
- When aligning secondary screens, they will be moved to the correct position relative the Master screen.
- Its best to choose a screen that does not move, for a master screen.

## Mesh deform



**Warning:** This may take a while, depending on mesh size, number of verticies and point cloud size.

If the depth of the mesh in Disguise software does not match the real world object, it will require mesh deforming. Mesh deform will deform the mesh to match the point cloud.

It is a good idea to try the default settings for mesh deform first, to see if you get a good deform. If not, proceed to tweak the settings as required.

You can quickly preview Mesh deform results by changing the Point Cloud visualisation mode to Deform in the OmniCal calibration editor. The results are updated in real-time so you can try out different deform settings using this. The lines indicate where each point on the mesh would be moved to.

**Please note:** You must have added re-shape points to the screens for Mesh deform to work.

1. To perform a Mesh deform, click **Mesh deform** from the Alignment tab of the Plan editor
2. Select the screen you wish to deform by left-clicking the **screen property** in the deform editor.
3. Left-click **Deform**

# OmniCal Multi-pose alignment

Multi-pose alignment improves the way OmniCal works with objects controlled by automation.

## Overview

OmniCal QuickAlign currently positions secondary (non-master) objects. Multi-pose adds the ability to do this in multiple positions, or “poses”. The automation system can then be given information about these poses and interpolate between them when moving objects.

Currently only movement along a linear path is supported, which requires 2 poses per object.

## Prerequisites

- A master screen is required as well as the objects that are moving. The master screen must be stationary.
- Accurate Meshes: Multi-pose is designed to interpolate between object poses. These poses are determined by reference points, therefore an accurate model is required.
- It is recommended that the master screen matches the scale in the real world as this will define the scale for the whole calibration. If your master screen scale is incorrect, you may have to adjust the scale of all secondary screens.

## Limitations

- Only supports linear paths, with a single input value from the automation system.
- Does not support calculating rotation pivot points. If an object rotates between poses, the system will simply linearly interpolate between these rotations, which may not be what is desired.
- Multi-pose alignment only uses a single calibration (it is not multi-pose calibration like QuickCal). Therefore there are some important requirements for projector calibration:
  - » Projectors need to be calibrated with depth using the DLT algorithm. Blobs cannot be on a single plane.

- » Projection will only be accurate within the calibrated "space". ie around same place where blobs land. Surface movement should be limited to this area.

- No mesh interpolation is done

- Mult-pose alignment is not supported by the Rig Check workflow. It shouldn't normally be necessary to use multipose on a regular basis. It should only be necessary to redo it when there are changes to the automation system causing screens to move along a different path.

## Workflow

1. Extract good Meshes.
2. Setup automation axes for all moving screens.
3. Perform a capture and calibration.
4. Align master screen and all static screens in base pose.
5. Create 2 poses for each moving screen.

## Example

### Extract Good Meshes

The multi-pose workflow requires that you have accurate meshes. You can skip this step if you already have these or if you are in a simulation

Please see "Extracting a mesh using OmniCal" for further information

Setup automation axes for all moving screens

1. Create an automation device and driver using the regular workflow. For information on creating automation devices, visit [this link](#).
  - Create 6 axes all with the same input ID from automation, for XYZ position and XYZ rotation of the object as follows.



**Warning:** Note that all 6 axes are required even if the object is moving in a single dimension and no rotation is expected. This is because QuickAlign will calculate a composite rotation and translation of the surface. Ignoring rotation will mean the



translation will not be correct. This will become especially apparent when local origin of the mesh is far way from its centroid.

Perform a capture and calibration

Follow the regular OmniCal workflow capture and calibrate.

Open the Quick Align editor.

Align master screen and all static screens in base pose

1. Align the Master screen.
  - a. Make sure the Current Pose is set to base, the Master Screen and Current Screen are set to the actual master screen object in the visualiser.
  - b. Perform an alignment.
  - c. Repeat for all static screens
    - i. You can only use reshape tools in the base pose. In min and max poses, the current mesh is being moved, but no reshaping is supported. Note that the UI does not yet prevent you from turning alignment points into reshape points.
    - ii. If you need to reshape a mesh for which you need to use the Multi-Pose workflow, then you can either do this by aligning and reshaping in the base pose, or doing it in a separate step, and export+re-import the mesh (probably preferred).

## Create poses for each moving screen

1. With the Quick Align editor open, ask automation to move the moving piece to its minimum position.
2. Create min pose
  - a. Click Create Pose
  - b. This will take a capture and present the camera images for the user to align to. It will also take a snapshot of the current automation input values.
  - c. Select the Current Screen as the object which has just been moved by automation to be aligned.



- d. Perform an alignment of the screen at the minimum position.
  - e. Each pose can contain multiple screens so you can repeat this for each screen that is visible. Alternatively you could create a separate pose per screen.
  - f. Click the Set Min Range in the automation section of the Quick Align editor.
  - g. The minimum pose has now been set.
  - h. You can right click on a pose to view the screens and automation data contained within it.
3. Keeping the Quick Align editor open, ask automation to move the moving piece to its maximum position.
  4. Create max Pose
    - a. Repeat the same pose creation steps and instead select Set Max Range in the automation section of the Quick Align editor.
  5. Click Normalise Rotation (always required unless a rotation of  $\geq 180$  degrees is required between the poses)
    - a. For example, after a multi-pose alignment, if you get  $-0.2\text{deg}$  as the min output and  $359.7\text{deg}$  as the max output, then the min output should be set to  $359.7$  or the max output should be set to  $-0.3\text{deg}$ . This is because the direction of rotation is ambiguous.
  6. Close the Quick Align editor and ensure automation is engaged.

# OmniCal Rig-check

## Overview

Rig check is the tool for quickly re-calibrating without advanced knowledge of the rest of the OmniCal system. It is primarily used by touring operators to re-calibrate shows moving into new venues.

## Workflow

The Rig Check workflow is used after a full OmniCal calibration & alignment has been completed. The plan is used as a template to repeat the calibration with the same settings. The plan is not modified in this workflow.

1. Ensure that you have a plan already calibrated by a Trained user. It should be selected in the OmniCal Calibrator editor.
2. Left-click **Check Cameras** in the OmniCal Calibrator editor.
3. Verify there are no errors when the **Check Cameras** window opens. Errors can include the following:
  - a. Cameras are unavailable
  - b. Camera names have been modified in the plan. The plan capture is used as a reference for Rig Check. Any changes to cameras names after the plan capture was done will invalidate it.
4. The **Check Cameras** window will open which shows camera pairs consisting of the original plan capture and a snapshot capture of the current stage. You can take a new snapshot using the Refresh Camera Views button.
5. Ensure that the camera views match:
  - a. They don't need to be identical, but the coverage of projection surfaces should match and they should be in approximately the same positions.

- b. The brightness of the images should also match. The exact camera settings specified in the plan (like exposure time) will be used here, so any differences would be either due to the physical aperture or focus of the camera lens (for machine vision cameras) or the lighting environment. It is therefore recommended that the focus and aperture of machine vision cameras be locked in place for repeatability
  6. Once you are happy with the camera views, close the **Check Cameras** window.
  7. Left-click **Execute Plan**. This will perform a capture, calibration, alignment and optionally a mesh deform if it was configured to run automatically in the plan's deform settings. A new **Result** object is created which contains the capture and calibration.
  8. Ensure that the correct **Plan** and **Result** are selected in the **OmniCal Calibrator** editor.
  9. Left-click **Check Result** in the **OmniCal Calibrator** editor. Note that this will apply the result's alignment to the stage (if it hasn't been applied already). This will update both projectors and projection surfaces if they have alignment points. If **Check Result** is greyed out a tool tip should tell you the reason, which can include the following:
    - a. The **Plan** has no capture or calibration
    - b. The **Result** has no capture or calibration
  10. Verify there are no errors when the **Check Result** window opens. Errors can include the following:
    - a. The camera names in the **Plan** and **Result** don't match. The **Plan** may have been modified since the **Result** was created.
  11. The **Check Result** window will open which shows camera pairs consisting of the original **Plan** capture and the **Result** capture that was taken.
  12. Left-click on a camera image to open the **Result Aligner** window. If an **Mesh Deforms** have been applied these will be undone in order for alignment points to be editable.
  13. On the left hand side is the camera view from the original **Plan** (read only) and on the right the **Result**. You can then update the alignment points on the right to match the left. This will update the alignment on the stage as you do it. The controls are identical to **Quick Align**.
  14. Select the next screen by pressing the button at the bottom of the camera views or selecting it from the surfaces drop down and repeat the process of checking and adjusting alignment points.
  15. Repeat this for all cameras. You could in theory only check cameras or projection surfaces which you know to have moved.
-

16. Close the Check Result window. You will be asked if you'd like to re-apply the mesh deform



**Warning:** The stage should be clear

**Warning:** No changing light levels

**Warning:** No people walking across stage

## Example

### Accessing rig-check

1. Open the stage editor by right-clicking Stage in the dashboard, or by right-clicking the floor in the visualiser.
2. Left-click **OmniCal Calibration** to open the OmniCal editor.
3. Ensure that you have a plan already calibrated by a Trained user.
4. Left-click **Check cameras**.

### Using rig-check

1. Ensure that you have a plan already calibrated by a Trained user. It should be selected in the OmniCal Calibrator editor.
2. Left-click Check Cameras in the OmniCal Calibrator editor.
3. Verify there are no errors when the rig-check editor opens.

Errors can include the following:

- Cameras are unavailable
  - Camera names have been modified in the plan. The plan capture is used as a reference for Rig Check. Any changes to cameras names after the plan capture was done will invalidate it.
4. The **Check Cameras** window will open which shows camera pairs consisting of the original plan capture and a snapshot capture of the current stage. You can take a new snapshot using the Refresh Camera Views button.

5. Ensure that the camera views match:
    - a. They don't need to be identical, but the coverage of projection surfaces should match and they should be in approximately the same positions.
    - b. The brightness of the images should also match. The exact camera settings specified in the plan (like exposure time) will be used here, so any differences would be either due to the physical aperture or focus of the camera lens (for machine vision cameras) or the lighting environment. It is therefore recommended that the focus and aperture of machine vision cameras be locked in place for repeatability
  6. Once you are happy with the camera views, close the Check Cameras window.
  7. Left-click **Execute Plan**. This will perform a capture, calibration, alignment and optionally a mesh deform if it was configured to run automatically in the plan's deform settings. A new Result object is created which contains the capture and calibration.
  8. Ensure that the correct Plan and Result are selected in the OmniCal Calibrator editor.
  9. Left-click **Check Result** in the OmniCal Calibrator editor. Note that this will apply the Result's alignment to the stage (if it hasn't been applied already). This will update both projectors and projection surfaces if they have alignment points. If Check Result is greyed out a tool tip should tell you the reason, which can include the following:
    - a. The Plan has no capture or calibration
    - b. The Result has no capture or calibration
  10. Verify there are no errors when the Check Result window opens. Errors can include the following:
    - a. The camera names in the Plan and Result don't match. The Plan may have been modified since the Result was created.
  11. The Check Result window will open which shows camera pairs consisting of the original Plan capture and the Result capture that was taken.
  12. Left-click on a camera image to open the Result Aligner window. If an Mesh Deforms have been applied these will be undone in order for alignment points to be editable.
  13. On the left hand side is the camera view from the original Plan (read only) and on the right the Result. You can then update the alignment points on the right to match the left. This will update the alignment on the stage as you do it. The controls are identical to Quick Align.
-

14. Select the next screen by pressing the button at the bottom of the camera views or selecting it from the surfaces drop down and repeat the process of checking and adjusting alignment points.
15. Repeat this for all cameras. You could in theory only check cameras or projection surfaces which you know to have moved.
16. Close the Check Result window. You will be asked if you'd like to re-apply the mesh deform.

Warning:



The stage should be clear.

With no changing light levels.

And no people walking across stage.

# Sequencing Overview

This section explains how to sequence the d3 timeline, layers & content mappings.

# Sequencing Overview

This section explains how to sequence the d3 timeline, layers & content mappings.



# Timeline overview

## What is the Timeline?

The terms **Timeline** and **Track Player** both refer to the section at the bottom of the interface. The reason for using two different names to describe the same section is that they suggest different meanings; whilst **Timeline** conveys a **sense** of time, **Track Player** refers to the **function** of playing a track. Therefore both names are used synonymously within the User Guide depending on their context.

## Objects within the Track Player

The Track Player is a specialised object editor used to play and edit **tracks**. All sequencing and Timeline information is organised into tracks. The Track Player is constructed from a series of properties explained below to make playing and editing tracks more intuitive.

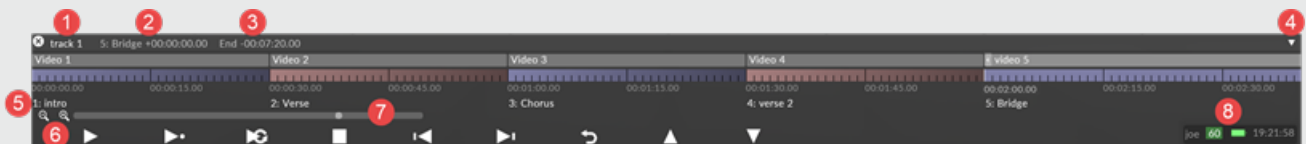

## Track Anatomy

- Track name (1)
- Time passed since the section started (2)
- Section name & time remaining within the section (3)
- Track collapser, makes a mini version of the Track where only Transport controls are visible (4)
- Notes & Cues on the Timeline (5)
- Timeline zoom controls allowing users to toggle between zoom levels on the timeline (6)

- Track scroll bar which allows you to scroll the length of the Track as well as view the current location of the playhead (7)
- Machine status including name, current FPS, battery monitor and local time (8)

Please see the sub-chapter [Tracks overview](#) for information on tracks.

## Closing/re-opening the Track Player

1. Left-click the x icon in the top left corner of the Track Player to close the Track Player.
2. Right-click **track** in the dashboard (bar at the top of the screen) to re-open the Track Player.

This is a useful feature, particularly when you want to make [screenshots](#) and the Track Player is obscuring part of your view.

## Controlling the Timeline from external sources

The Disguise software can be configured to control the Timeline with SMTPE, MTC, Art-Net, MIDI notes, OSC and more. Read the [Transports](#) chapter for more information.

# Transport controls

## Transport controls



There are three play modes: **Play** , **Play-to-end-of-section** , and **Loop-section**. When you are using any of these modes, switching to a different mode happens seamlessly, without disturbing the progress of the Playhead

## Move the Playhead

The Playhead selects a position on the Timeline. When entering a play mode, the track will play from the current position of the Playhead.

To move the Playhead:

1. Left-click anywhere on a coloured Track bar to move the Play cursor to that point.
2. Hit the left and right **Arrow** keys to move the Play cursor one Track bar to the left or right.

## Play



- **Normal** play can be triggered by pressing the **Enter** key. Hitting **Enter** again will stop the cursor.

**Normal** play mode does not respect section boundaries; when the end of a section is reached, the playhead continues into the next section, stopping only at the end of the track. The Play button will flash to indicate which mode you are using.

## Play-to-end-of-section



1. **Play-to-end-of-section** mode can be triggered by hitting the **Space bar**. Hitting the **Space bar** again will stop the playhead.

In this mode, the playhead will only progress until it reaches the end of a section (i.e. just before the next cue point). When this happens, Disguise software enters in a holding state. To indicate this, the button will flash at twice the normal speed and the playhead will remain static, although video and other content will continue to play.

2. When this happens, you can use the Next and Previous Section jump buttons to advance to the next section (i.e. trigger the next cue).

## Loop-section



- **Loop-section** play mode can be triggered by hitting the right hand **Shift** key. Hitting the right-hand **Shift** key again will stop the cursor.

In this mode, the playhead will progress until it reaches the end of a section, i.e. just before the next cue point. At this point, the playhead will loop back immediately to the beginning of the section and will continue playing from there.

# Stop



- Left-clicking the **Stop** button on screen will stop the playhead regardless of which play mode you are in. If you are using the keyboard, press the shortcut key for the play mode you are in to stop the cursor (i.e. the play keys act as toggles).

# Previous / Next section



- Left-clicking the **Previous-section** button will make the cursor jump to the previous section if the cursor is on the first bar of the current section; otherwise the playhead will jump to the first bar of the current section.
- You can also jump to the previous section using the **comma [ , ]** key on the keyboard.



- Left-clicking the **Next-section** button will make the playhead advance to the start of the next section. If the playhead is in holding mode at the end of the section, Disguise software returns to Play-to-end-of-section mode. This button is therefore the equivalent of hitting the next cue.
- You can also jump to the next section using the **period [ . ]** key on the keyboard.

## Return-to-start-of-track



- Left-clicking **Return-to-start-of-track** brings the playhead back to the very beginning of the track. Note that the software will stop playing when you click this button.

## Next / Previous track



- Once you have created a set-list and selected it, left-clicking the **Next-track** and **Previous-track** buttons will make you step through the selected set-list.

# Tracks overview

## What is a track?

All disguise sequencing and Timeline information is organised into tracks. Tracks provide a method for organising content and control commands for the show; the entire show may be placed into one track, or can be divided into multiple tracks. Better performance can be expected from dividing long tracks into individual ones.

[The Track editor](#) is used to play and edit each tracks within a project, as well as adjust each tracks individual settings like total length, and universal crossfade duration.

[The Overview of the Timeline](#) topic explains how to manage and edit the sequencing of individual tracks. Layers of content are placed on the Timeline in each track, which is explained in depth in the [Working with Layers](#) section.

Multiple tracks can be controlled at once through the use of Multitransports, to better organise content and control layers. More information on the use and creation of Multitransports can be found [here](#).

## Using tracks to sequence content to the beat

As described above in the [Overview of the Timeline](#) sub-chapter, the Track Player is used to play and edit tracks. This chapter explains how to create, manage and edit tracks. However, what is not discussed are **layers** and **audio files**. Layers are placed on the Timeline in the currently active track for Disguise sequencing. This is fully explained in the [Working with Layers](#) chapter. Audio files are inserted into a track, enabling content to be sequenced to the beat. For more information please see the [Audio](#) chapter.

# The track editor

Right-click the Transport controls title bar. This will open up a Track editor that lets you edit various track properties.

## Special Settings

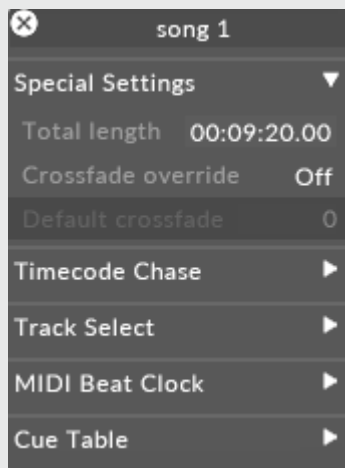

## Total Length

This property defines the total length of the track in Hours Minutes Seconds & Frames (HMSF).

**Please note:** Note that when the Timeline is Quantised, the legacy BPM options return to the dialog.



## Crossfade Override

Turns on the crossfade function for this track. For further information see the [Universal Crossfade](#) section.

## Crossfade Duration

When enabled, this controls the crossfade time in beats. For further information see the [Universal Crossfade](#) section.

## Timecode Chase

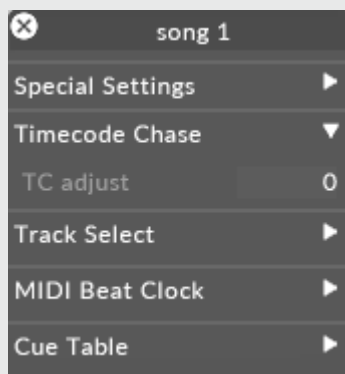

If for any reason you need to delay various tracks differently, you can do this by right-clicking the track titlebar to open up the **timecode chase** tab and editing the **MTC adjust** property.

For more information on timecode chasing please see the sub-chapter [Triggering cues with timecode](#).

# Track-select

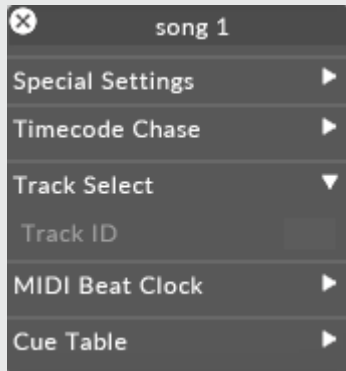

## Track ID

To select tracks based on an external MIDI note event, type in the **track ID** property in the text field with either a note number or note name (eg. C#1). When Disguise software receives a MIDI note, it will scan all tracks in the current active set-list. If it finds a match, it will trigger the track. For more information on MIDI notes please see the sub-chapter [Midi notes](#).

For step-by-step instructions on how to use the **track ID** property to change tracks with artnet visit [Changing tracks with artnet from the sub-chapter Controlling the Timeline with Artnet](#).

## Midi Beat-Clock

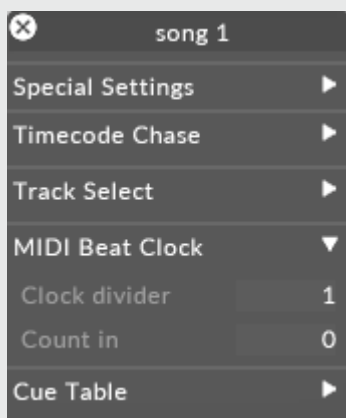

## Clock Divider

This property is used when synchronising to MIDI beatclock (as opposed to using timecode). It sometimes happens that the clock received is a multiple of the track bpm. For example, the track may originally be 60 bpm, but the input clock is received at 120 bpm. Setting the **clock divider** property allows you to scale the input clock; in this example, setting the divider to 2 will achieve the desired result.

## Count In

The **count in** property is also used only when synchronising to MIDI beatclock. When the clock starts for the first time, d3 will wait for the specified number of beats before triggering track play.

Scroll down to the section MIDI beat-clock track settings in the [MIDI beat-clock](#) topic for more information.

## Cue Table

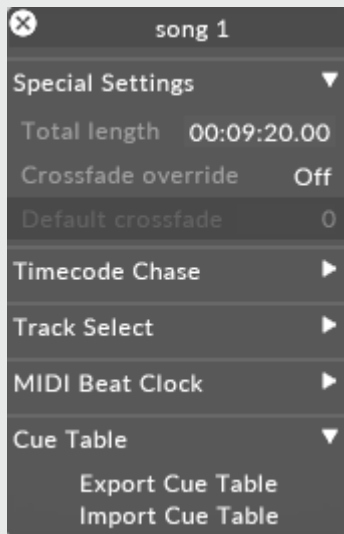

Disguise software allows you to export Track Cue notes to a table, allowing you to edit them en masse in a word processor or spreadsheet.

## Export Cue Table

Left-clicking **export cue table** opens up a tab separated text file in a folder called **objects/table**.

## Import Cue Table

Edit the cue names in the text file. Then go back to the Cue Table and left-click **import cue table** to load and apply the cue names.

# Creating and managing tracks

## Creating a track

1. Left-click **track** in the d3 State editor (bar at the top of the screen). This will open up the Track manager.
2. Type in the name of the new track in the **new track** text field and hit **Enter**. The new track will be created, added to Track manager and activated on the Timeline.

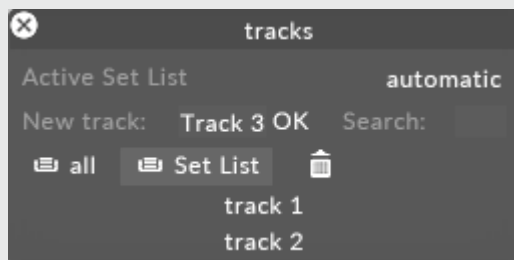

## Switching from one track to another

Select the track you want to switch to from the Track manager. The currently active track in the Timeline will immediately update.

## Creating a set-list

A show often uses many tracks. To make this easier to manage the tracks can be organised into **Set List**. A Set List can be created from either the [Cue List](#) or the [transport manager](#).

It is important to use the Set List functionality to effectively manage what data the Cue List is showing.

1. Open the Cue List either through the Transport Manager, or by pressing CTRL G.
2. Left click the **Set List** tab.
3. Right click the Set List, the Set List manager opens.

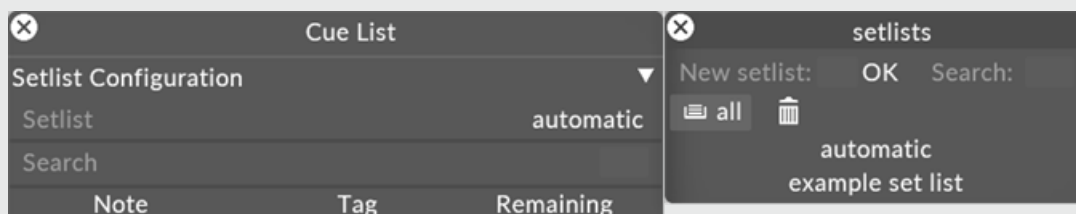

4. Create a new Set List in the manager or select an already created Set List.
5. Add the desired tracks to the Set List.

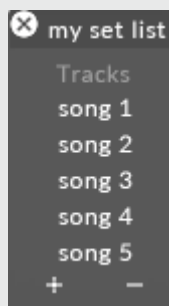

# Adding and removing sections

## Adding a section

1. Right-click the bar at the point where you want to the start a new section and select **split section** from the popup menu.
2. You can also hit **Alt+S** , which creates a section break at the current cursor position.

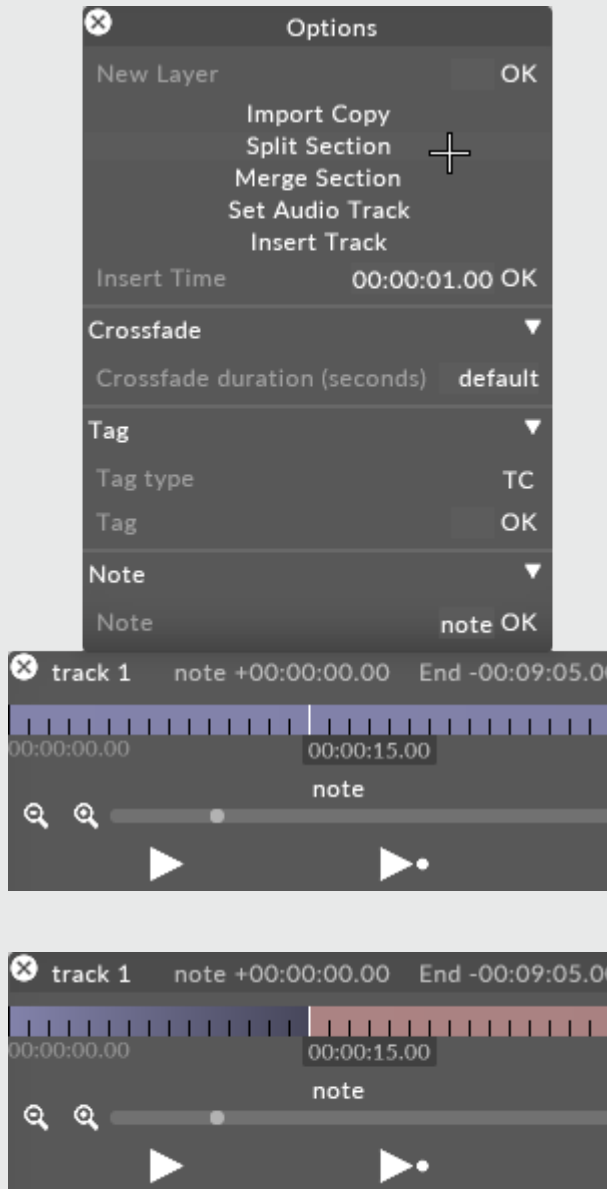

## Removing a section

1. Right-click a bar within the section and select the **merge section** option from the popup menu. As a result, the current section will merge with the previous section.



2. You can also hit **Alt+M** , which merges the section containing the current cursor position with the previous section.

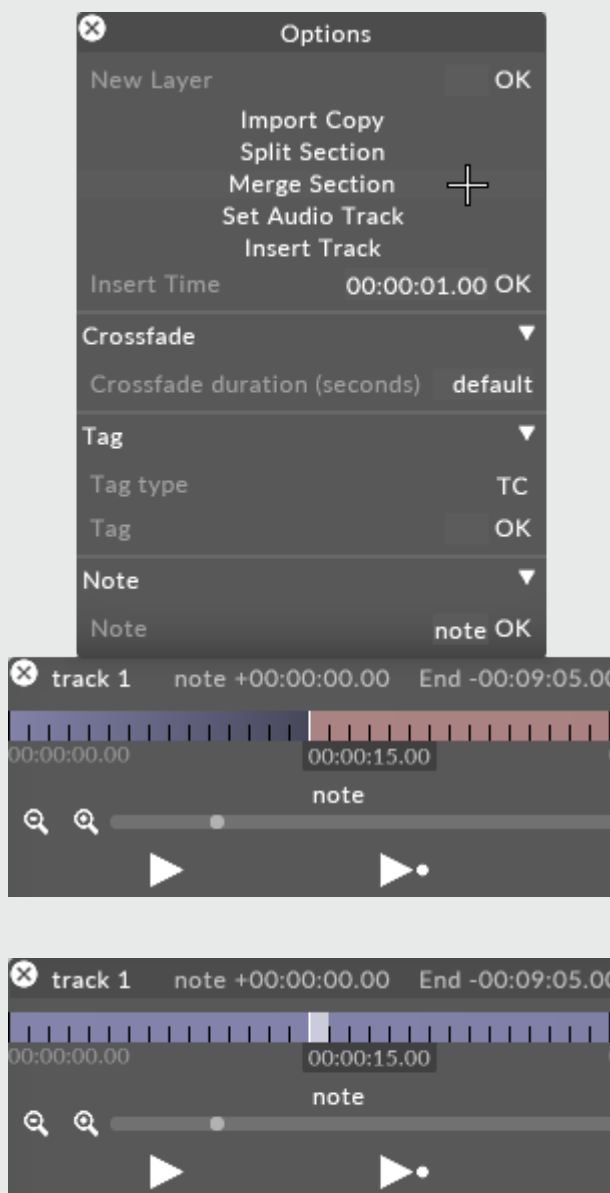

# Working with Notes

Notes are items of text added to the timeline to aid the user in identifying parts of the track.

## Adding a note to the track

- Right-click the bar where you want to add a note, left-click the **note** text field and type in the text you want to add.

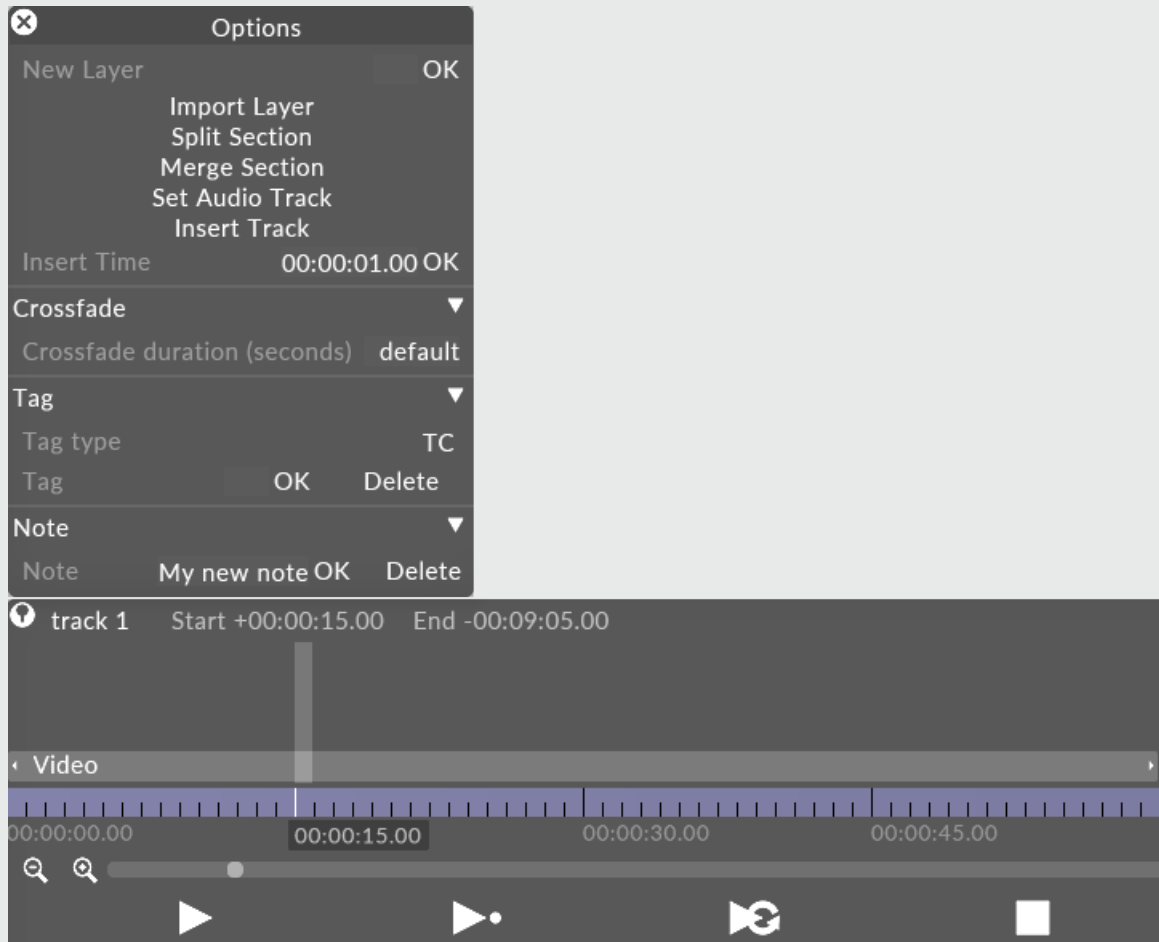

*Note field complete. Click OK to add the note to the track.*

Alternatively, you can hit **Ctrl+N**, which lets you type in or edit the note for the current cursor position.

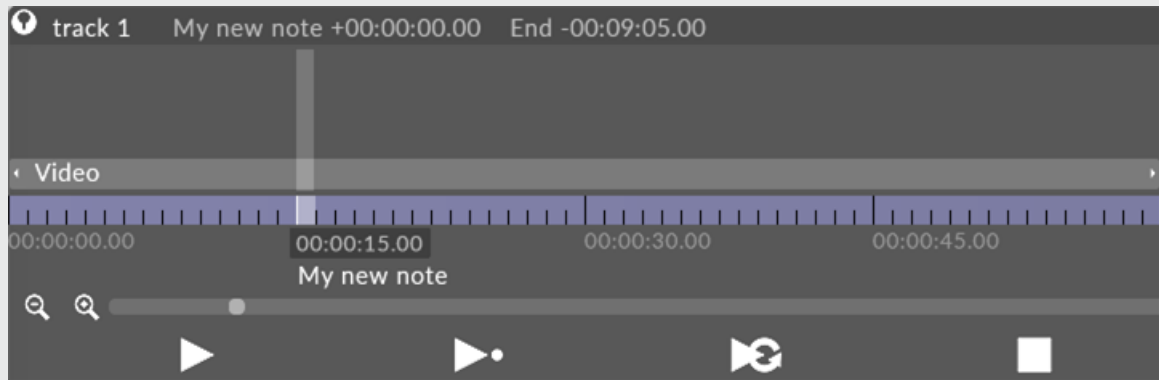

*Note added to the track.*

## Removing a note from the track

- Select the already added text in the note data field and press the **Backspace** key followed by **Enter** or left click the **OK** button.
- Alternatively, right click on the note and left click **Delete** in the track options editor.

### Remove all Notes

It is also possible to remove all tags from a track or section of a track by selecting the section of timeline where the tags are to be deleted, then right click in the shaded area to open the Track Options window; once open, select **Remove Notes**

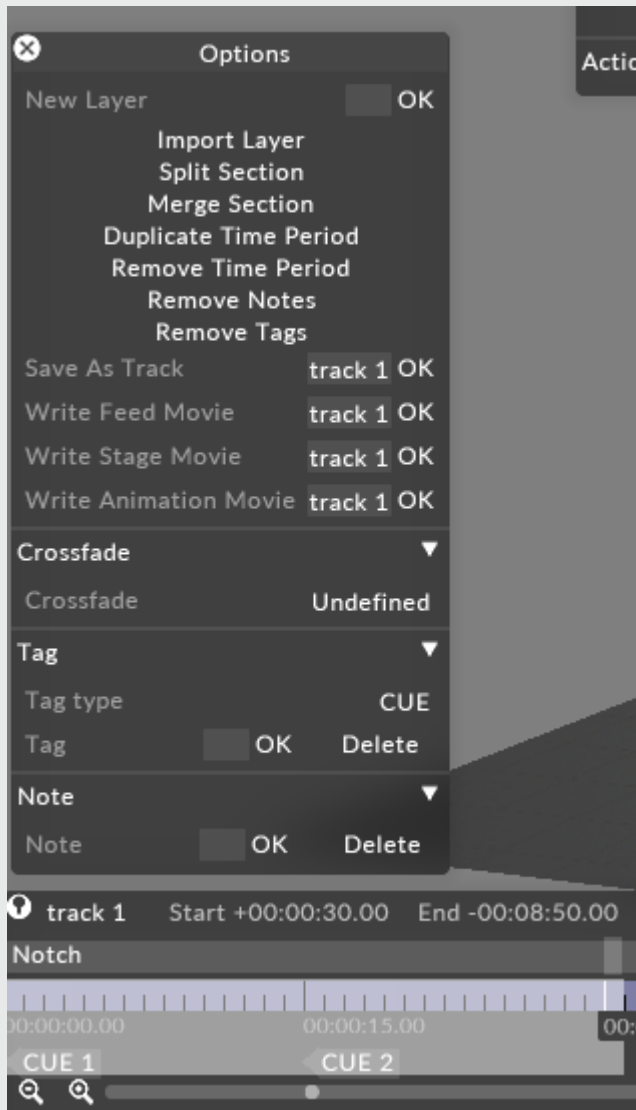

## Moving a note on the track

- Hold Alt & left click and drag the note horizontally along the track.

# Cue List

The Cue List shows a list of all sections & tags on the tracks within the currently active set list, allows users to trigger specific tags with a 'go' button, view where they are in the Set List, create new Set Lists and trigger the show from one single interface.

## Opening the Cue List

The Cue List can be opened in two ways.

### Option 1

- Right click Transport in the dashboard
- Expand the Set List tab

Left click the **Open Cue List** button

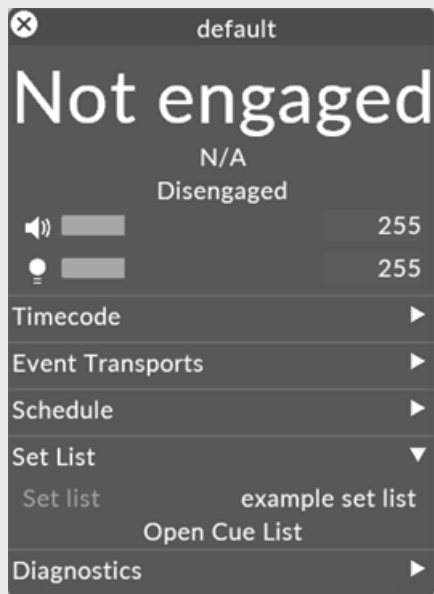

## Option 2

Use the keyboard shortcut - CTRL G to open the Cue List.

## Using the Cue List

### Auto scroll

The Cue List will scroll as the user plays through the timeline to allow the user to track where in the Cue List they are, without needing to manually scroll.

### Track jump

Left clicking on a track name in Cue List will take you to the beginning of that track in timeline.

### Active selection

The active Section will be highlighted in green, and the most recent cue will be highlighted in a lighter green.

## Row selection

- The row selection follows much the same behaviour as list editor. Users can select a track for playback by hovering over cue row and selecting it with a click, users can then click the GO button to trigger that cue, or the note or tag columns to edit.
- Users cannot select more than one row
- Once a track is selected users can select other tracks by pressing up and down.
- User can press CTRL + UP to jump to top of list.
- User can press CTRL + DOWN to jump to bottom of list.

## Adjustable size

Users can adjust the width as well as height of widget by hovering over the edge, then left clicking and dragging when the arrow icon is visible. The note column will truncate text (in the middle of the text) if there are large strings in the note column.

## Removing tracks from the Cue List

If the Set List is set to Automatic, then all tracks in the project will display in the Cue List. However this is inefficient and can cause performance issues with large projects, therefore we recommend the use of [Set Lists](#).

Removing a track from the Cue List can be done by specifying a Set List that does not contain that particular track.

## Set List configuration

A show often uses many tracks. To make this easier to manage the tracks can be organised into **Set List**. A Set List can be created from either the [Cue List](#) or the [transport manager](#).

It is important to use the Set List functionality to effectively manage what data the Cue List is showing.



1. Open the Cue List either through the [Transport Manager](#), or by pressing CTRL G.
2. Left click the **Set List** tab.
3. Right click the Set List, the Set List manager opens.

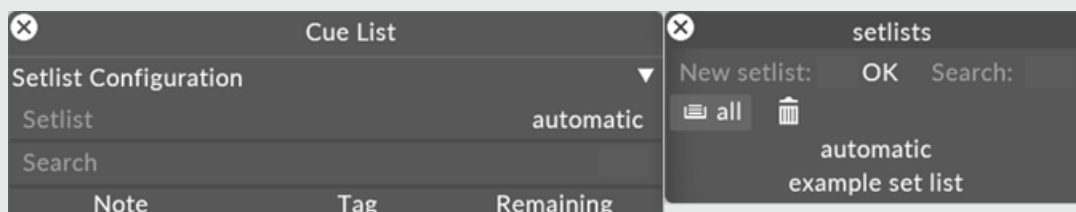

4. Create a new Set List in the manager or select an already created Set List.
5. Add the desired tracks to the Set List.

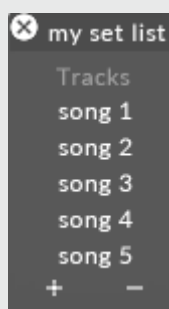

## Editing items within the Cue List

- Double click the note field to edit or add a note to the track.
- Double click the tag field to edit the tag after it has been added to the timeline. Once a tag has been added using the traditional tag workflow specified in the [tags topic](#), users can edit that tag in the Cue List. Double clicking the tag column when before a tag is added will do nothing.

# Searching the Cue List

As well as the standard text search (looking for matches in track name, notes and tags), you can filter your search by type, with the following syntax:

**track: name** will return only tracks that match the search text.

**note: name** will return only notes that match the search text.

**tag: name** will return only tags that match the search text.

**cue: name** will return notes and tags that match the search text.

# Jumping track bars

## Jumping units of time on the Timeline using keyboard arrows

You can control how to jump Track bars on the Timeline. This is useful if you want to, for example, find and create a cue point on the track from when the chorus is about to start later in a music video. To do this:

1. Right-click the d3 icon at the top left corner to open up the Program Settings menu.
2. Select **project settings** and open the **timeline control** tab
3. Left-click **deferred jump**. This will point to two options.
4. Left-click yes to activate **deferred jump**. With this feature activated, you can now hit the left or right **Arrow** keys (while playing) to jump Track bars without losing sight of the original bar you jumped from (this bar will also continue to flash).

5. Left-clicking **no** will deactivate this feature.

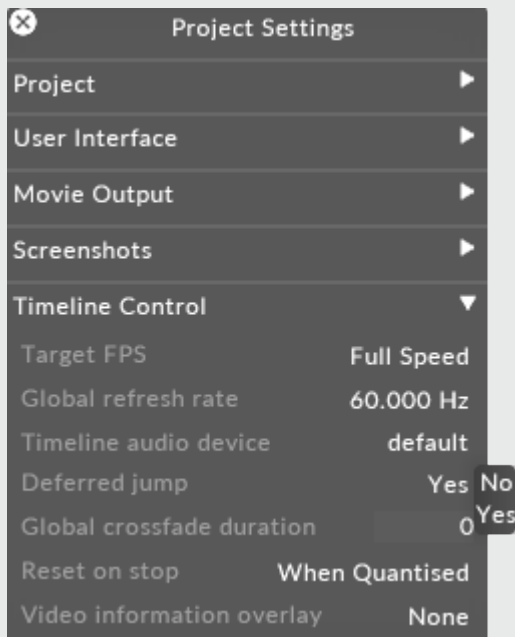

## Jump to the next section using the angle bracket keys

- To jump to the next section rather than the next bar, click the **greater than angle bracket (>)** key.
- To jump to the previous section click the **Less than angle bracket (<)** key.

## Jumping to cues from a cue-list

After creating sections and adding notes you can open a cue-list from which you can jump to a specific cue.

1. Hit **Ctrl+G** to open the cue-list.
2. Left-click the Go button, next to the name of the cue (the note name) to jump to the selected cue.



Cue Set List			
Search			
	Note	Tag	Remaining
song 1			
GO			(00:09:20.00)
	Intro	1	(00:00:15.00)
	Verse	2	(00:00:45.00)
	Chorus	3	(00:01:15.00)
	Outro	4	(00:01:45.00)
song 2			
GO			(00:09:20.00)
	Intro	1	(00:00:15.00)
	Verse	2	(00:00:45.00)
	Chorus	3	(00:01:15.00)
	Outro	4	(00:01:45.00)
song 3			
GO			(00:09:20.00)
song 4			
GO			(00:09:20.00)
song 5			
GO			(00:09:20.00)

# Content mapping Overview

Mapping is the process of copying content from the Timeline level to the screens in the Stage level.

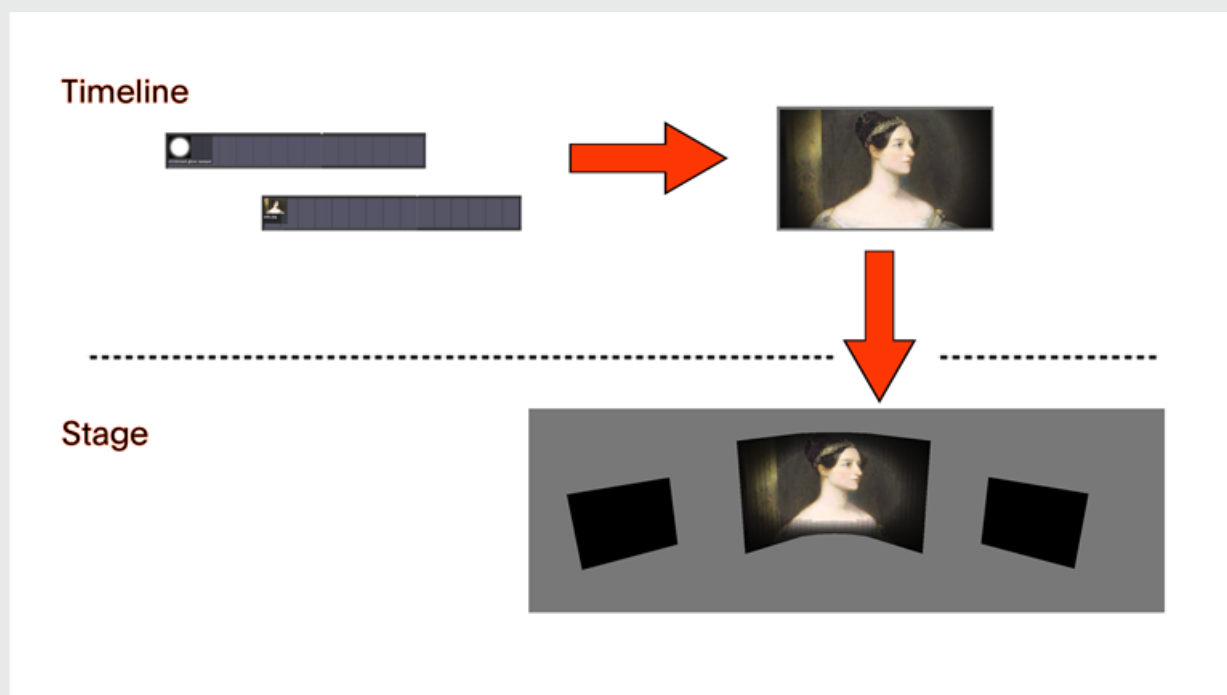

*Conceptual diagram illustrating how mapping is used to control how content is copied from the Timeline to the Stage level.*

All visual layers contain the property mapping, which is used to direct the layer output to the screens on the stage. For information on how to use the mapping property, please see the sub-chapter creating a new mapping.

## Types of mappings

Several mapping types in the disguise software: Direct mapping, Feed mapping, Parallel mapping, Perspective mapping, Cylindrical mapping, Radial mapping, Spherical mapping, CameraPlate mapping, Spatial mapping, and PreComps.

These mapping types are able to: sample content across single or multiple screens with pixel perfect accuracy; map content onto 3D objects of any form; accurately project content onto static or moving screens; and project geometrically from virtual cameras in a number of different ways. For more detailed information on the mapping types please read the following topic Mapping types overview.

All visual layers contain the property **mapping**, which is used to redirect the layer output to the screen(s) in the stage. For information on how to use the **mapping** property please see the topic [Creating a new mapping](#).

# Content mapping Overview

Mapping is the process of copying content from the Timeline level to the screens in the Stage level.

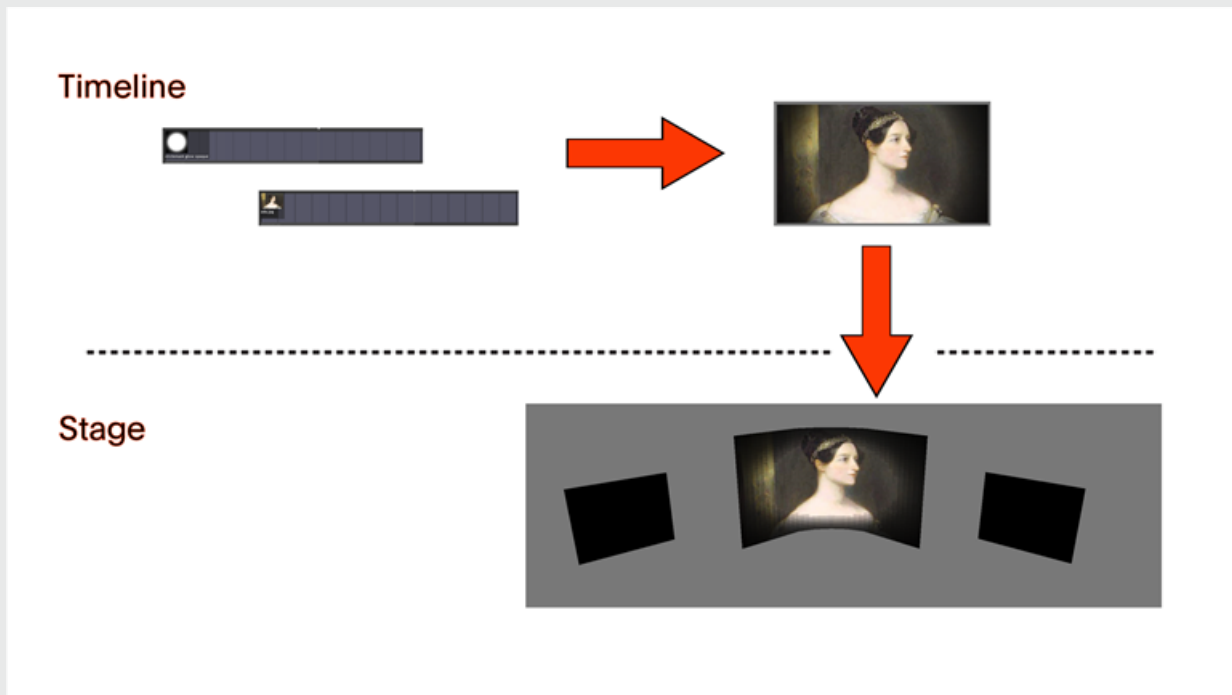

*Conceptual diagram illustrating how mapping is used to control how content is copied from the Timeline to the Stage level.*

All visual layers contain the property mapping, which is used to direct the layer output to the screens on the stage. For information on how to use the mapping property, please see the sub-chapter creating a new mapping.

## Types of mappings

Several mapping types in the disguise software: Direct mapping, Feed mapping, Parallel mapping, Perspective mapping, Cylindrical mapping, Radial mapping, Spherical mapping, CameraPlate mapping, Spatial mapping, and PreComps.

These mapping types are able to: sample content across single or multiple screens with pixel perfect accuracy; map content onto 3D objects of any form; accurately project content onto static or moving screens; and project geometrically from virtual cameras in a number of different ways. For more detailed information on the mapping types please read the following topic Mapping types overview.



All visual layers contain the property **mapping**, which is used to redirect the layer output to the screen(s) in the stage. For information on how to use the **mapping** property please see the topic [Creating a new mapping](#).

# Mapping types overview

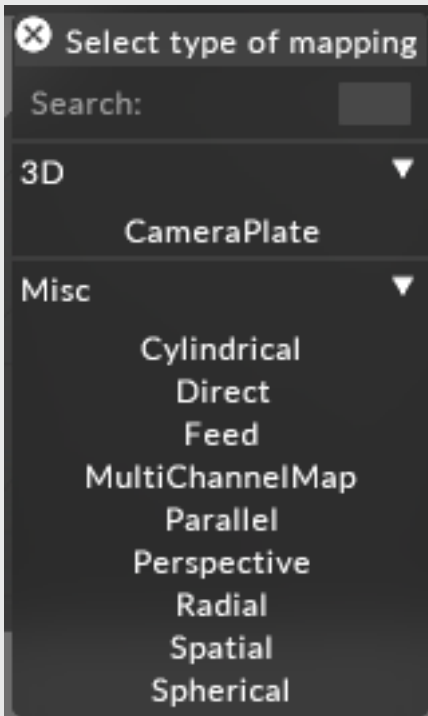

## Direct

Direct mapping is the easiest form of mapping. Simply select a piece of content and apply it directly onto some or all of your screens. If the content aspect is different from the screen aspect ratio, you can choose to crop, fit, stretch or apply the content pixel-perfect onto the screens.

## Feed mapping

Feed mapping lets you specify an arbitrary number of rectangles within your content frame and map them to arbitrary rectangles on your screens. With Feed mapping, all your screens can easily be turned into one canvas, with pixel-perfect content applied. Individually move, scale, crop, chop or flip your sample rectangles to compensate for differences in pixel-density or to create interesting mapping effects.

# Parallel

Parallel mapping allows you to position your content in a virtual emitter rectangle anywhere within the stage and to choose which screens and fixtures this affects. The Disguise software then virtually projects the content out onto those fixtures. The content keeps the same size as it gets further away from the emitter.

# Perspective

Perspective mapping is similar to Parallel mapping, except that the content originates from an emitter point and gets larger as you get further away from the emitter, similar to a real projector. You can use perspective mapping to map 3D content onto a surface that looks perfect from the specified point of view.

# Cylindrical mapping

Cylindrical mapping is similar to Parallel mapping, except that the Cylindrical mapping wraps content around a cylinder and fires it outwards (or inwards) at the screens you assign to it. It does not matter if the screen is moving or expanding, the Cylindrical mapping feature re-maps the content in real-time.

# Radial

Radial mapping is similar to the Cylindrical mapping, except that the emitter surface runs from the central axis to the cylinder rim, rather than being wrapped around the outside of the cylinder. The pixels inside the cylinder will therefore be mapped according to their height within the cylinder and their distance from the central axis.

# Spherical

Spherical Mapping works similarly to the Cylindrical mapping, except the top and bottom are 'pinched' to create a sphere.

# CameraPlate

A CameraPlate mapping is a 3D Camera based mapping that is fixed to the plate of the camera. Using a CameraPlate mapping is necessary when doing color adjusts on the set extension.

# Spatial

A Spatial mapping is a 3D Camera based mapping that maps into 3D space; it has a "space" or location so it can be moved around 3D environments.

# MultiChannelMap

The default mapping for the RenderStream layer, the [MultiChannelMap](#) allows you to assign multiple mappings to multiple unique RenderStream channels so you can manage all within the same mapping.

# Creating a new mapping

## Process used to create a new mapping

1. In your track, create a new visual layer. These layer types can include content layers, generative layers, and effect layers.
2. Left click on the layer in the track to open the Layer Editor on the left side of the GUI.
3. Under the **Default** tab, left click on the Mapping parameter to display a list of the mappings in the project.
4. A manager titled **mappings** will appear – this is a list of all mappings within your project. By default, all screens will be populated with a direct mapping sharing the same name, and all cameras will be populated with a perspective mapping sharing the same name.
5. Type directly into the **New mapping:** text field to create a new mapping. A list will appear prompting to you select the mapping type.

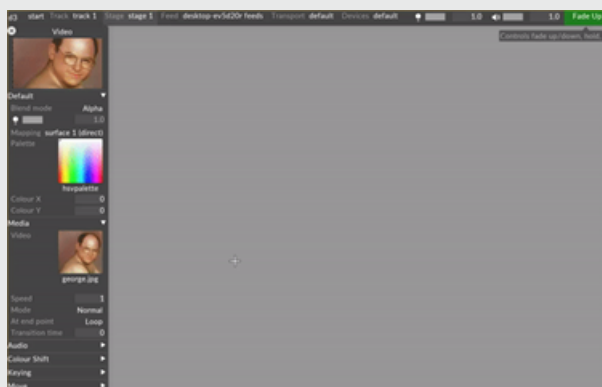

6. An editor with the user assigned name of the mapping will appear once a mapping type is selected.
7. Assign all screens that will be used for the mapping and enter the resolution of the content that will be displayed on the screens.
8. Edit the specific properties of the chosen mapping type.
9. Assign a piece of content to the layer in the track, and the content will be displayed on the assigned screens of the mapping in the stage and the feed output window.

Note: In the Mapping keyframe editor that will appear across the screen, move the playhead and assign multiple mappings sequentially for each layer by left clicking in the editor.

Remove mappings from your project by left clicking on the name of the mapping and dragging to the trash can icon within this menu. All mappings that are assigned to a screen or camera within the project but have been moved to the trash will appear highlighted in red.

**Please note:** it is useful to organise the different mappings in boxes, particularly if there are a very large number of mappings. For information on how to create, edit and organise objects within boxes, please see the section 'Organising objects in boxes' in the [Object libraries](#) sub-chapter.

# Common mapping properties

This section explains the properties that are shared by the six different mapping types.

## Filtering

**Nearest** - Nearest neighbor filtering. Use nearest-neighbour sampling, to disable blending between pixels when scaling. Can be used to create pixellated looks, or to ensure hard edges on certain types of content.

**Bilinear** - Bilinear filtering is a texture filtering method used to smooth textures when displayed larger or smaller than they actually are.

**2x Multi-sample** - Multi-Sample filtering can help fix issues with scaled content, but can introduce some blurriness.

## Resolution

This controls the canvas size the layer renders into, in pixels. The Direct mapping type starts with a 256x256 pixel canvas and automatically sets the canvas size to that of the first screen you add.

## Screens

This is a list of screens that the selected mapping type can copy content to.

1. Left-click **+** to open the Screens manager.
2. Left-click the Screens you want to map. This will copy the individual canvas content onto these three Screens simultaneously and will add the Screen names to the mapping object editor.
3. Left-click and drag the Screens listed in the mapping object editor to **-**. This will remove the canvas content from the Screens and delete the Screen names from the mapping object editor.

## Mask

This points to the Texture file that defines a Mask bitmap. You can use this property to apply a Mask bitmap to the mapping canvas. Selecting this property will open the Texture object library, which shows all of the still image files saved on your local hard-drive in the **DxTexture** folder.

To apply a mapping mask you will need to create and import a custom still image file.

- The step-by-step instructions on how to create and import a custom Population mask can be used to create a custom mapping mask. The only difference is that the mapping masks resolution should be the same as the mapping canvas. For step-by-step instructions on how to create and import a Population mask into a d3 project visit to the section Population mask in the [Editing screens](#) sub-chapter.
- Alternatively, set any layers blend mode to **mask** to channel the layer content into the mapping mask.



# Mapping types overview

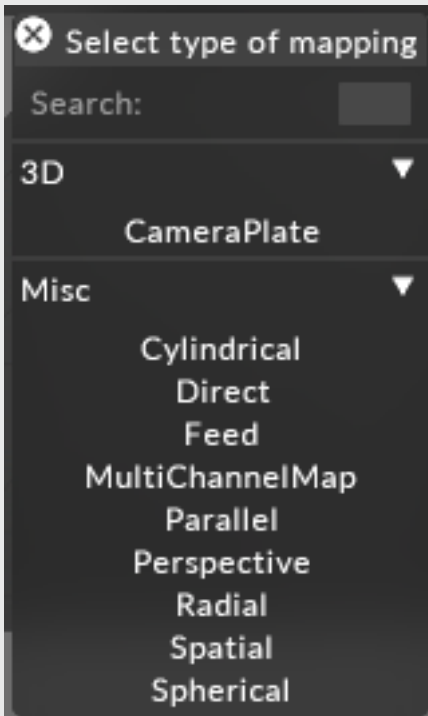

## Direct

Direct mapping is the easiest form of mapping. Simply select a piece of content and apply it directly onto some or all of your screens. If the content aspect is different from the screen aspect ratio, you can choose to crop, fit, stretch or apply the content pixel-perfect onto the screens.

## Feed mapping

Feed mapping lets you specify an arbitrary number of rectangles within your content frame and map them to arbitrary rectangles on your screens. With Feed mapping, all your screens can easily be turned into one canvas, with pixel-perfect content applied. Individually move, scale, crop, chop or flip your sample rectangles to compensate for differences in pixel-density or to create interesting mapping effects.

# Parallel

Parallel mapping allows you to position your content in a virtual emitter rectangle anywhere within the stage and to choose which screens and fixtures this affects. The Disguise software then virtually projects the content out onto those fixtures. The content keeps the same size as it gets further away from the emitter.

# Perspective

Perspective mapping is similar to Parallel mapping, except that the content originates from an emitter point and gets larger as you get further away from the emitter, similar to a real projector. You can use perspective mapping to map 3D content onto a surface that looks perfect from the specified point of view.

# Cylindrical mapping

Cylindrical mapping is similar to Parallel mapping, except that the Cylindrical mapping wraps content around a cylinder and fires it outwards (or inwards) at the screens you assign to it. It does not matter if the screen is moving or expanding, the Cylindrical mapping feature re-maps the content in real-time.

# Radial

Radial mapping is similar to the Cylindrical mapping, except that the emitter surface runs from the central axis to the cylinder rim, rather than being wrapped around the outside of the cylinder. The pixels inside the cylinder will therefore be mapped according to their height within the cylinder and their distance from the central axis.

# Spherical

Spherical Mapping works similarly to the Cylindrical mapping, except the top and bottom are 'pinched' to create a sphere.

# CameraPlate

A CameraPlate mapping is a 3D Camera based mapping that is fixed to the plate of the camera. Using a CameraPlate mapping is necessary when doing color adjusts on the set extension.

# Spatial

A Spatial mapping is a 3D Camera based mapping that maps into 3D space; it has a "space" or location so it can be moved around 3D environments.

# MultiChannelMap

The default mapping for the RenderStream layer, the [MultiChannelMap](#) allows you to assign multiple mappings to multiple unique RenderStream channels so you can manage all within the same mapping.

# Direct mapping

Direct mapping is the easiest mapping type. It specifies a canvas size (in pixels) and a list of screens where the canvas content will be copied onto.

Direct mapping is the default mapping applied to all screens and is a 1:1 ratio of content to screen. The content will stretch and shrink to the size and resolution of the assigned screen. You can choose to crop, fit, stretch or apply the content pixel-perfect onto the one or multiple screens, all within one direct mapping.

[image of direct mapping titled DirectMapping1.png]

When you create a new screen, Disguise software automatically creates a new Direct mapping with the same name as the screen and only includes that screen.

The resolution of the Direct mapping type is automatically set to the highest resolution screen of the screens included in the Direct mapping.



# Creating a Direct mapping

1. In your track, create a new visual layer. These layer types can include content layers, generative layers, and effect layers.
2. Left click on the layer in the track to open the Layer Editor on the left side of the GUI.
3. Under the **Default** tab, left click on the Mapping parameter to display a list of the mappings in the project.
4. A manager titled **mappings** will appear – this is a list of all mappings within your project. By default, all screens will be populated with a direct mapping sharing the same name, and all cameras will be populated with a perspective mapping sharing the same name.
5. Type directly into the **New mapping:** text field to create a new mapping. A list will appear prompting to you select the mapping type.



6. An editor with the user assigned name of the mapping will appear once a mapping type is selected.
7. Assign all screens that will be used for the mapping and enter the resolution of the content that will be displayed on the screens.
8. Edit the specific properties of the chosen mapping type.

9. Assign a piece of content to the layer in the track, and the content will be displayed on the assigned screens of the mapping in the stage and the feed output window.

## Common Mapping Properties

This section explains the properties that are shared by the six different mapping types.

### Filtering

**Nearest** - Nearest neighbor filtering. Use nearest-neighbour sampling, to disable blending between pixels when scaling. Can be used to create pixellated looks, or to ensure hard edges on certain types of content.

**Bilinear** - Bilinear filtering is a texture filtering method used to smooth textures when displayed larger or smaller than they actually are.

**2x Multi-sample** - Multi-Sample filtering can help fix issues with scaled content, but can introduce some blurriness.

### Resolution

This controls the canvas size the layer renders into, in pixels. The Direct mapping type starts with a 256x256 pixel canvas and automatically sets the canvas size to that of the first screen you add.

### Screens

This is a list of screens that the selected mapping type can copy content to.

1. Left-click **+** to open the Screens manager.
2. Left-click the Screens you want to map. This will copy the individual canvas content onto these three Screens simultaneously and will add the Screen names to the mapping object editor.
3. Left-click and drag the Screens listed in the mapping object editor to **-**. This will remove the canvas content from the Screens and delete the Screen names from the mapping object editor.

# Mask

This points to the Texture file that defines a Mask bitmap. You can use this property to apply a Mask bitmap to the mapping canvas. Selecting this property will open the Texture object library, which shows all of the still image files saved on your local hard-drive in the **DxTexture** folder.

To apply a mapping mask you will need to create and import a custom still image file.

- The step-by-step instructions on how to create and import a custom Population mask can be used to create a custom mapping mask. The only difference is that the mapping masks resolution should be the same as the mapping canvas. For step-by-step instructions on how to create and import a Population mask into a d3 project visit to the section Population mask in the [Editing screens](#) sub-chapter.
- Alternatively, set any layers blend mode to **mask** to channel the layer content into the mapping mask.

# Feed Mapping

The Feed mapping type allows you to sub-sample rectangular areas in a content area (referred to as the Mapping canvas) and copy that content onto rectangles inside one or multiple screens.

Feed mapping lets you specify any number of source rectangles within your content and map them individually to multiple surfaces. With Feed mapping, all your screens can easily be turned into one overall raster, and content applied to each surface with pixel-perfect accuracy. Individually move, scale, crop, chop or flip your source rectangles to compensate for differences in pixel density or to create interesting mapping effects.

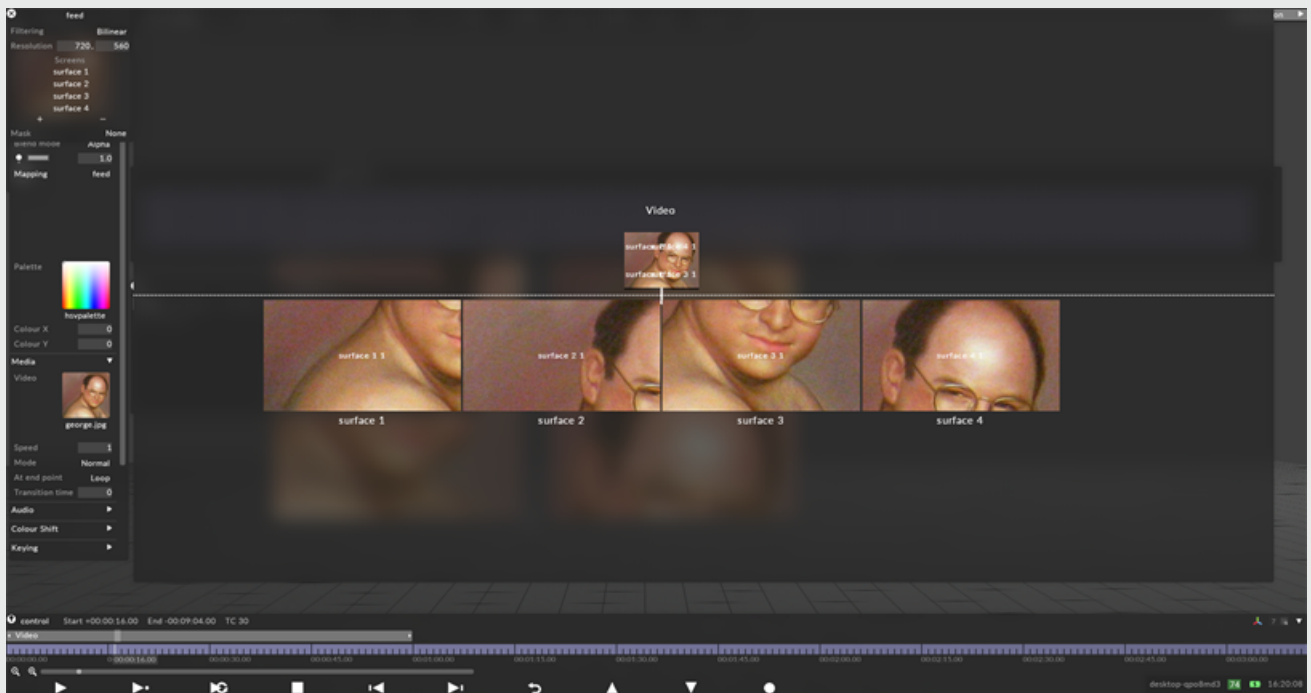



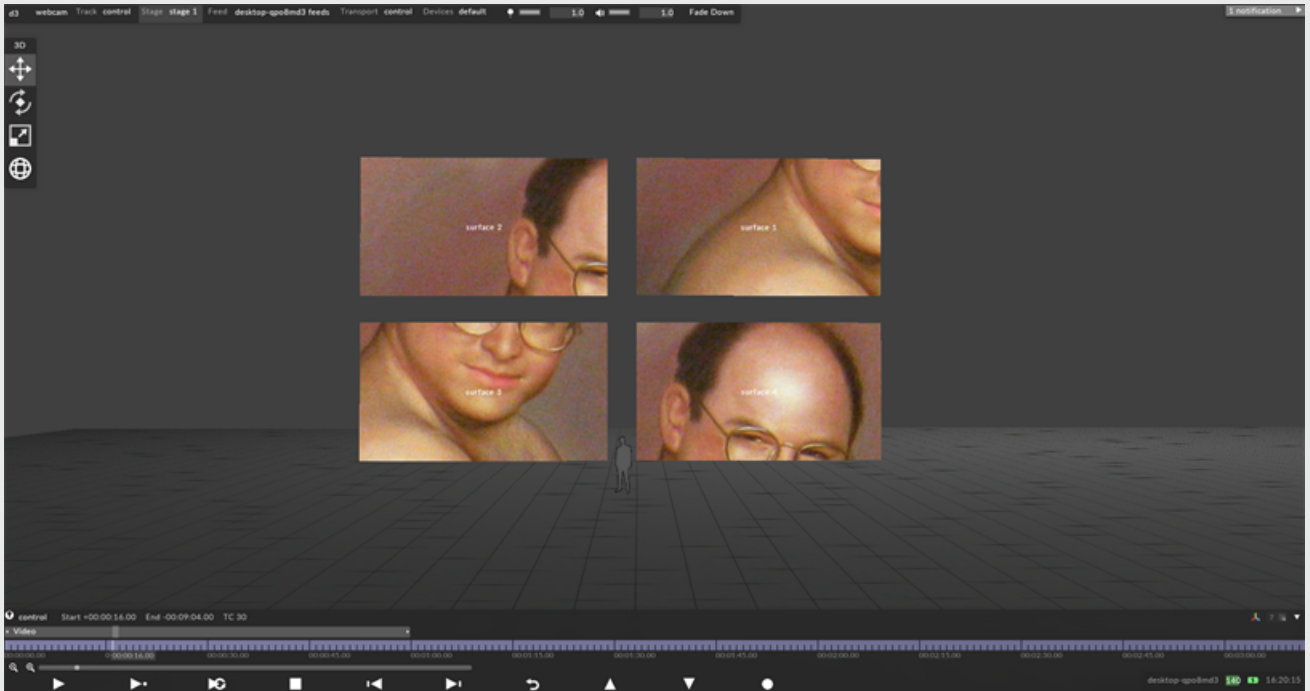

## Creating a Feed Mapping

1. In your track, create a new visual layer. These layer types can include content layers, generative layers, and effect layers.
2. Left click on the layer in the track to open the Layer Editor on the left side of the GUI.
3. Under the **Default** tab, left click on the Mapping parameter to display a list of the mappings in the project.
4. A manager titled **mappings** will appear – this is a list of all mappings within your project. By default, all screens will be populated with a direct mapping sharing the same name, and all cameras will be populated with a perspective mapping sharing the same name.
5. Type directly into the **New mapping:** text field to create a new mapping. A list will appear prompting to you select the mapping type.



6. An editor with the user assigned name of the mapping will appear once a mapping type is selected.
7. Assign all screens that will be used for the mapping and enter the resolution of the content that will be displayed on the screens.
8. Edit the specific properties of the chosen mapping type.
9. Assign a piece of content to the layer in the track, and the content will be displayed on the assigned screens of the mapping in the stage and the feed output window.

## Feed Mapping Properties

This section explains the properties that are shared by the six different mapping types.

### Filtering

**Nearest** - Nearest neighbor filtering. Use nearest-neighbour sampling, to disable blending between pixels when scaling. Can be used to create pixellated looks, or to ensure hard edges on certain types of content.

**Bilinear** - Bilinear filtering is a texture filtering method used to smooth textures when displayed larger or smaller than they actually are.

**2x Multi-sample** - Multi-Sample filtering can help fix issues with scaled content, but can introduce some blurriness.

## Resolution

This controls the canvas size the layer renders into, in pixels. The Direct mapping type starts with a 256x256 pixel canvas and automatically sets the canvas size to that of the first screen you add.

## Screens

This is a list of screens that the selected mapping type can copy content to.

1. Left-click **+** to open the Screens manager.
2. Left-click the Screens you want to map. This will copy the individual canvas content onto these three Screens simultaneously and will add the Screen names to the mapping object editor.
3. Left-click and drag the Screens listed in the mapping object editor to **-**. This will remove the canvas content from the Screens and delete the Screen names from the mapping object editor.

## Mask

This points to the Texture file that defines a Mask bitmap. You can use this property to apply a Mask bitmap to the mapping canvas. Selecting this property will open the Texture object library, which shows all of the still image files saved on your local hard-drive in the **DxTexture** folder.

To apply a mapping mask you will need to create and import a custom still image file.

- The step-by-step instructions on how to create and import a custom Population mask can be used to create a custom mapping mask. The only difference is that the mapping masks resolution should be the same as the mapping canvas. For step-by-step instructions on how to create and import a Population mask into a d3 project visit to the section Population mask in the [Editing screens](#) sub-chapter.
- Alternatively, set any layers blend mode to **mask** to channel the layer content into the mapping mask.

# Using the Feed mapping type

In addition to the property explanations provided in the sub-chapter Common mapping type properties, it is important to:

1. Set the resolution of the Feed mapping to the same resolution as the content intended to be used for that Feed mapping. If the content is of a higher resolution than the resolution of the Feed mapping mapping canvas, Disguise software will by default crop away the sides of the content. If the content is of lower resolution, Disguise software will scale up the content inside the mapping canvas.
2. Add the screens to the Feed mapping in the same order as they appear in the visualiser, from left to right. If the screens are not listed in that order yet, you can re-order the screens in the screens list by selecting and dragging a screen up or down.

## Adding a Feed rectangle to the mapping canvas

To add a Feed rectangle to the mapping canvas:

1. Right-click the red screen canvas and select **Add feed rectangle** .

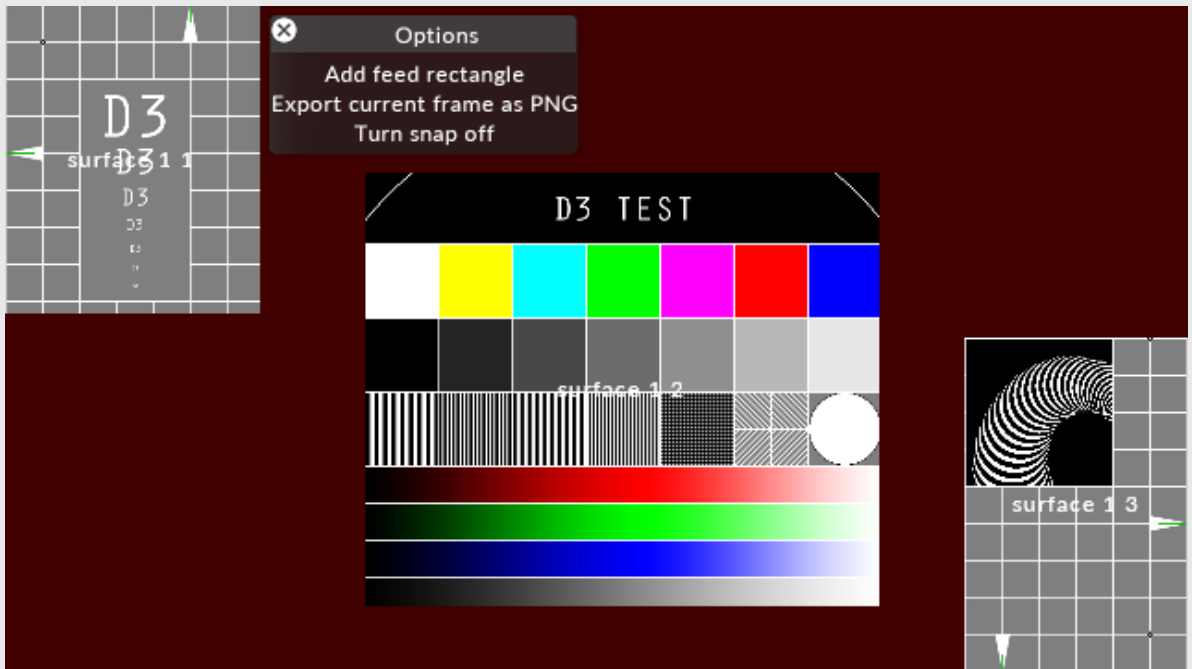

View of the Feed mapping editor when adding a new Feed rectangle

Note that the Feed rectangle is by default positioned in the top left corner of the mapping canvas. To change the position of the Feed rectangle, left-click it once, place the cursor in the middle and start moving it.

## Editing a Feed rectangle

The Feed rectangle has a number of options for scaling, flipping and chopping the rectangle. These options are very similar to those used when editing a Feed rectangle in the Output Feeds level. For more information please see the sub-chapter [Quick editing controls](#).

This image explains the various options associated with a Feed rectangle in the Stage level.

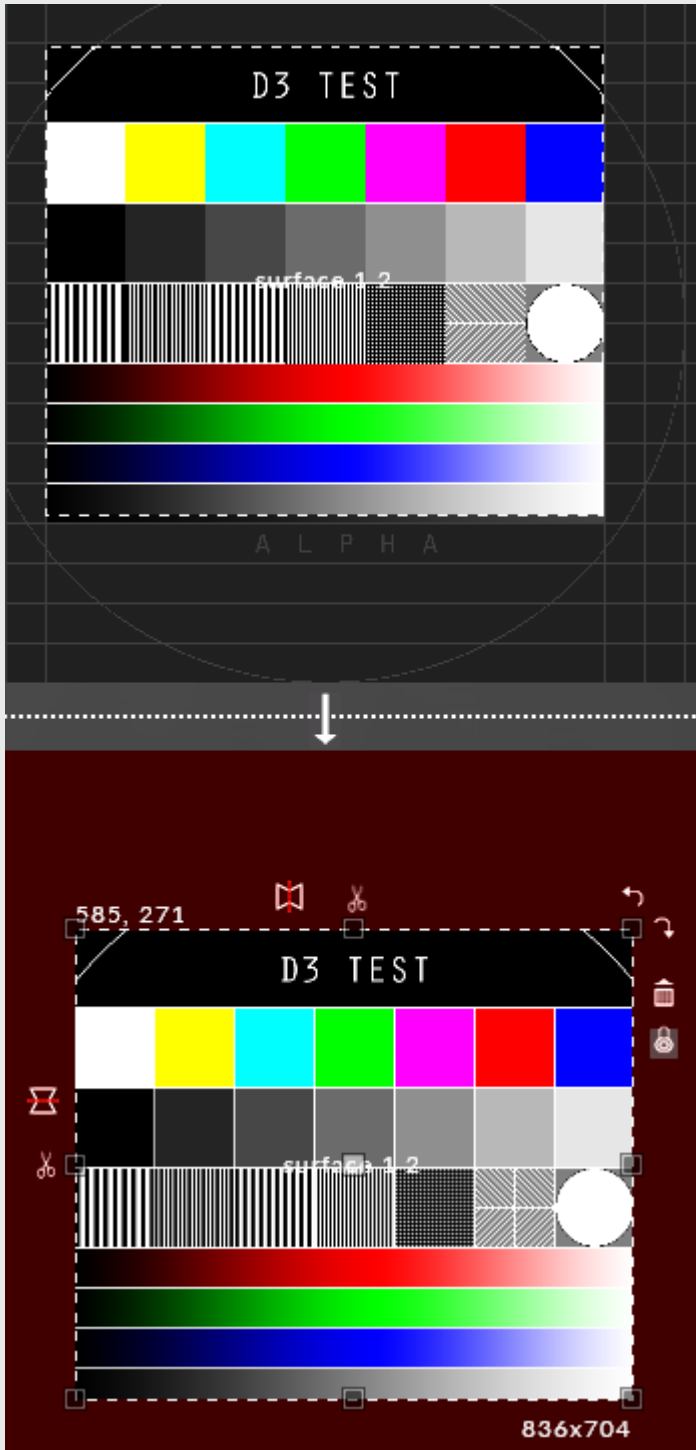

## Item

## Explanation

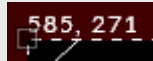

The position of the sample rectangle placed on the Mapping Canvas, in pixels



The **Scissor tool** on the sample rectangle for vertical cuts. Left-click and hold down the mouse button to move the cut horizontally.



The **Scissor tool** on the sample rectangle for horizontal cuts. Left-click and hold down the mouse button to move the cut vertically.



The **Bin**. Left-click the bin icon once to delete the sample rectangle (and the Feed rectangle).

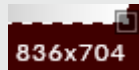

The size of the sample rectangle in pixels.



The **Flipping tool** to flip the sample rectangle horizontally.



The **Scissor tool** on the Feed rectangle for vertical cuts. Left-click and hold down the mouse button to move the cut horizontally.



The **Rotate tool** on the Feed rectangle for rotating the Feed rectangle 90 degree clock/anti-clockwise.



The **Scissor tool** on the Feed rectangle for horizontal cuts. Left-click and hold down the mouse button to move the cut vertically.



The **Flipping tool** to flip the sample rectangle vertically.



The **Bin**. Left-click the bin icon once to delete the Feed rectangle (and the sample rectangle).



The **Lock button** locks the size of the sample rectangle to the size of the Feed rectangle and vice versa. Left-click the Lock button once to unlock the dependency.

## Item

## Explanation



The name of the screen.

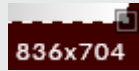

The size of the Feed rectangle in pixels.

Using these tools gives you a lot of freedom for configuring the Feed mapping on the screens in the Stage. Below, you can see an extreme example of this (for demonstration purposes only). Note that the red color in the background on the left hand side will only show up if the Feed mapping editor is open. When closed, the background will remain black.

## Feed rectangle properties

Right clicking a feed rectangle offers the following properties.

### Add feed rectangle

This option adds another feed rectangle to the canvas.

### Export current frame as PNG

A PNG of the feed rectangle is exported to the **screenshots** folder of your project folder. For more information see [project structure](#).

### Edit feed warping

This option allows you to draw a 2D warp on an individual feed rectangle. Useful for warping within the mapping layer as oppose to the feed level.

### Select mask

This option allows you to add a mask to the feed rectangle. Masks are read from the **DxTexture** folder of your Objects folder within your project folder. For more information see [project structure](#).

### Duplicate

This allows you to create a duplicate of the feed rectangle.



## Duplicate multiple

This allows you to duplicated multiple source and destination feed rectangles to create arrays of feed rectangles within the mapping.

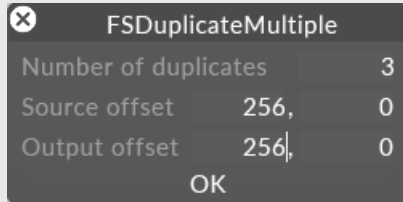

*The duplicate multiple editor.*

## Turn snap off

This option toggles feed rectangle snapping on and off. When on, feed rectangle edges will snap to one another, and when off they do not do this (note the rulers still show with snapping off).

## Import & Export feed maps

The easiest way to import and export feed maps from projects is via a table. A feed map can be exported to a text file from Disguise software and then imported to another project.

### Export

1. In your feedmap, right click and choose **Export to table**.
2. Enter a name
3. Hit **OK**

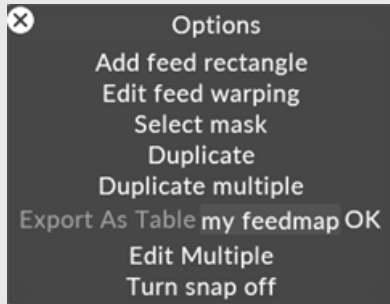

- The feed map is now exported to a newly created table folder in the objects folder.

The table that is exported will look similar to this example:

	A	B	C	D	E	F	G	H	I	J	K	L
1	screen name	head	output rect x pos	output rect y pos	output rect width	output rect height	source rect x pos	source rect y pos	source rect width	source rect height	locked	rotation
2	left	2	0	0	960	540	0	0	960	540	1	0
3	right	2	960	0	960	540	0	0	960	540	1	0
4												
5												

"Screen Name" refers to the name of the feed rectangle while "Head" refers to the number of the output slot.

## Import

- In your new project, create a feed mapping. The mapping does not need to share the same name as the one you are importing.
- Left click the Import from table option, this will only appear if there is a table folder present in the project folder.

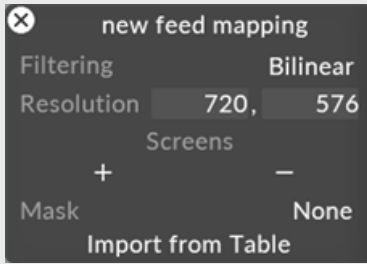

3. Left click your table from the available list.

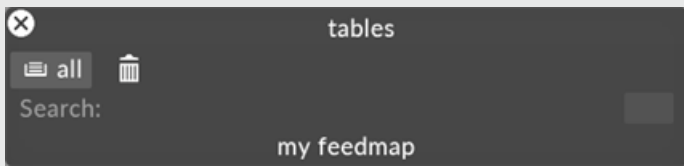

4. Choose yes when prompted to overwrite existing feed rectangles.



# Parallel mapping

The Parallel mapping type projects content geometrically into the scene, as if 'virtually shooting content from an emitting rectangle. The mapped image does not increase in size the further away you go from the emitting rectangle. Instead, the image remains the same size, hence the term parallel.

Parallel mapping will emit content over multiple screens and treat the configuration as a single canvas, projecting one unified image over all assigned surfaces. There is no more need to calculate the exact distance and pixel density of the empty space between screens, Disguise software will maintain the correct content sampling even across moving surfaces.



Parallel mapping is also very useful when you want to apply content onto moving screens. As long as Disguise software receives the correct tracking signal, the system will automatically map the content onto the moving screens. See more about screen tracking in the sub-chapter [Motion control systems](#).

Furthermore, Parallel mapping is a great tool for combining not only LED technology of various pixel-pitches, but also to combine LED , projection and DMX lighting into one canvas. As Disguise considers

all screens to be made up of pixels, regardless if they are LED, projection or DMX-based screens (including moving heads), it is very easy to combine these different type of screens into one canvas.

**Please note:** the Parallel mapping may not be useful when the screens are facing awkward angles in relation to the emitting rectangle of the Parallel mapping. The more they rotate away from the emitting rectangle, the more stretched the pixels will be on the screens. Ideally, the Parallel mapping should be used for straight-facing rectangular screens. For low-res sculptural screens, this is however not a problem.

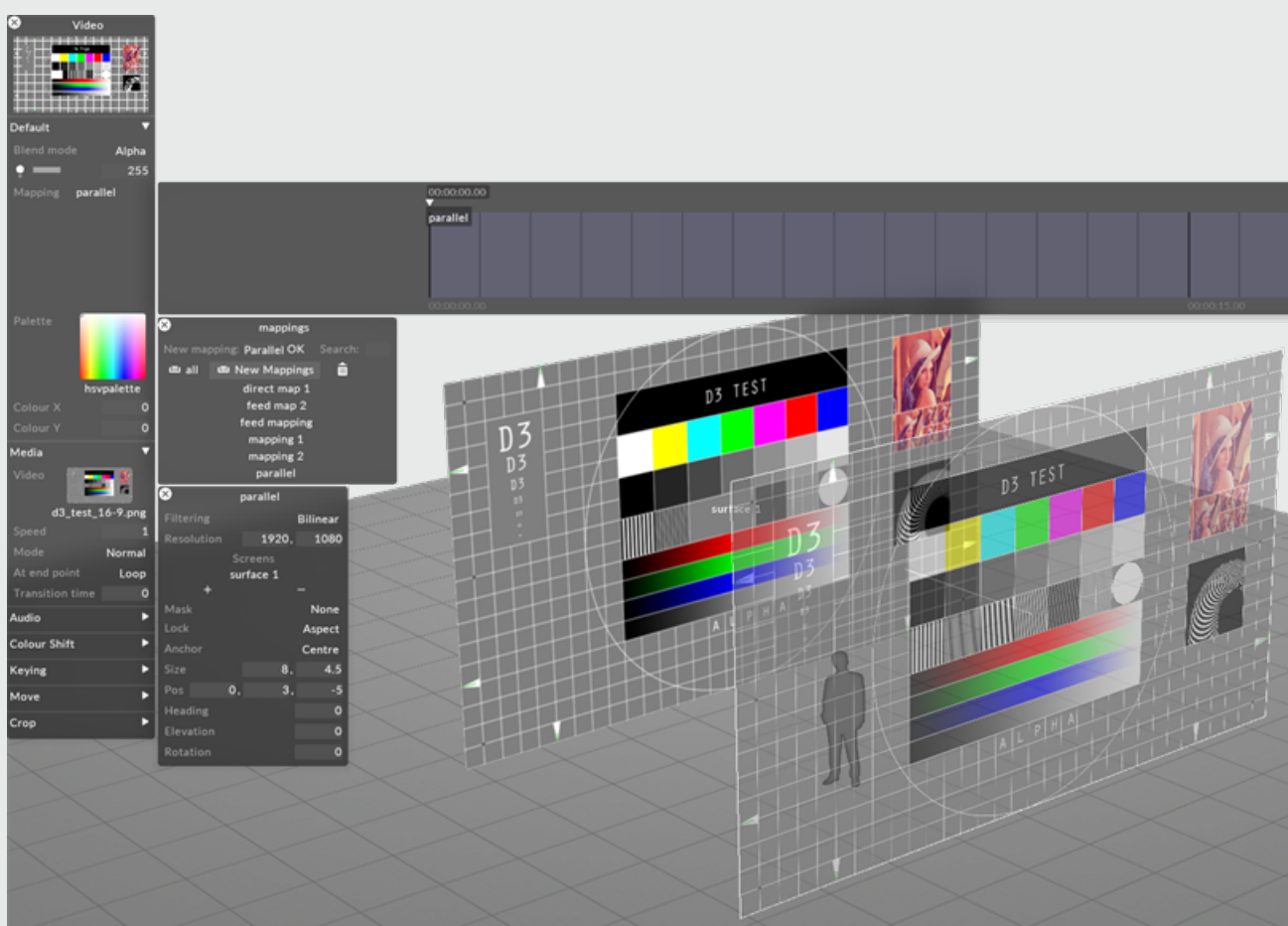

# Creating a Parallel Mapping

1. In your track, create a new visual layer. These layer types can include content layers, generative layers, and effect layers.
2. Left click on the layer in the track to open the Layer Editor on the left side of the GUI.
3. Under the **Default** tab, left click on the Mapping parameter to display a list of the mappings in the project.
4. A manager titled **mappings** will appear – this is a list of all mappings within your project. By default, all screens will be populated with a direct mapping sharing the same name, and all cameras will be populated with a perspective mapping sharing the same name.
5. Type directly into the **New mapping:** text field to create a new mapping. A list will appear prompting to you select the mapping type.



6. An editor with the user assigned name of the mapping will appear once a mapping type is selected.
7. Assign all screens that will be used for the mapping and enter the resolution of the content that will be displayed on the screens.
8. Edit the specific properties of the chosen mapping type.

9. Assign a piece of content to the layer in the track, and the content will be displayed on the assigned screens of the mapping in the stage and the feed output window.

When the Parallel mapping editor initially opens, and assuming that the screens have been added, Disguise software will colour the region outside the projected image red and will give you the location and orientation details of the image source.

## Common Mapping Properties

This section explains the properties that are shared by the six different mapping types.

### Filtering

**Nearest** - Nearest neighbor filtering. Use nearest-neighbour sampling, to disable blending between pixels when scaling. Can be used to create pixellated looks, or to ensure hard edges on certain types of content.

**Bilinear** - Bilinear filtering is a texture filtering method used to smooth textures when displayed larger or smaller than they actually are.

**2x Multi-sample** - Multi-Sample filtering can help fix issues with scaled content, but can introduce some blurriness.

### Resolution

This controls the canvas size the layer renders into, in pixels. The Direct mapping type starts with a 256x256 pixel canvas and automatically sets the canvas size to that of the first screen you add.

### Screens

This is a list of screens that the selected mapping type can copy content to.

1. Left-click **+** to open the Screens manager.
2. Left-click the Screens you want to map. This will copy the individual canvas content onto these three Screens simultaneously and will add the Screen names to the mapping object editor.

3. Left-click and drag the Screens listed in the mapping object editor to -. This will remove the canvas content from the Screens and delete the Screen names from the mapping object editor.

## Mask

This points to the Texture file that defines a Mask bitmap. You can use this property to apply a Mask bitmap to the mapping canvas. Selecting this property will open the Texture object library, which shows all of the still image files saved on your local hard-drive in the **DxTexture** folder.

To apply a mapping mask you will need to create and import a custom still image file.

- The step-by-step instructions on how to create and import a custom Population mask can be used to create a custom mapping mask. The only difference is that the mapping masks resolution should be the same as the mapping canvas. For step-by-step instructions on how to create and import a Population mask into a d3 project visit to the section [Population mask in the Editing screens sub-chapter](#).
- Alternatively, set any layers blend mode to **mask** to channel the layer content into the mapping mask.

## Parallel Mapping Properties

### Lock

For convenience while editing, the mapping can either maintain its aspect ratio, which changes vertical size or resolution when you change horizontal size or resolution, and vice versa. The pixel density, which changes the vertical or horizontal size when you change the vertical or horizontal resolution can also be locked.

**Please note:** if the aspect or the density of the source content is not locked the Parallel mapping may project stretched pixels onto the screens



## Anchor

This controls the anchor point around which the mapping surface moves, scales and rotates. Select either **centre** to specify the position of the centre of the projection image or select **corner** to specify the bottom left corner of the image.

## Size

This controls the size of the mapped image, in meters (horizontal and vertical).

## Position

The position, in stage space (i.e. in meters) of the anchor point of the mapping source. This can be either the centre of the image or the bottom left corner of the image.

## Heading

This controls the direction of the mapping in the horizontal space, in degrees: 0 degrees points north (i.e. in the positive z axis direction). Increasing the angles will make the direction to rotate clockwise, so 90 degrees is west (i.e. the negative x direction), 180 degrees is south (negative z direction) and 270 degrees is east (positive x direction).

## Elevation

This controls the vertical elevation, in degrees, of the projection direction: 0 degrees is horizontal (i.e. parallel to the floor), 90 degrees is straight up and 90 degrees is straight down.

## Rotation

This controls the rotation of the image around the mapping axis, clockwise in degrees.

## Using the Parallel mapping type

In addition to the property explanations provided in the sub-chapter Common mapping type properties, it is important to:

1. Set the **aspect** property to **off** and set the resolution to match the resolution of the content intended to be used for this specific Parallel mapping.

2. Set the size of the emitting rectangle of the Parallel mapping to match the aspect of the resolution (and thereby the aspect of the content) and then set the aspect to **locked** . For example, if your content is 1920x1080, set the size to 19.2 10.8 and then set the aspect to **lock** . If the aspect or the density of the source content is not locked the Parallel mapping may project stretched pixels onto the screens.
3. Re-size the x or y coordinates to cover all areas of the screens (the red areas will gradually disappear as you re-size the emitting rectangle).
4. Make sure to specify content which has the same, or a slightly higher pixel density than the screen with the **highest** pixel density.

# CameraPlate mapping

The CameraPlate mapping always targets a specific camera.

The CameraPlate mapping was added for the Augmented Reality (AR) workflow, where virtual objects can be mapped within the scene. The CameraPlate mapping will essentially “stick” the content to the perceived lens of the camera and adjust the content to always appear in proportion despite the position or movement of the camera.

## Creating a CameraPlate Mapping

1. In your track, create a new visual layer. These layer types can include content layers, generative layers, and effect layers.
2. Left click on the layer in the track to open the Layer Editor on the left side of the GUI.
3. Under the **Default** tab, left click on the Mapping parameter to display a list of the mappings in the project.
4. A manager titled **mappings** will appear – this is a list of all mappings within your project. By default, all screens will be populated with a direct mapping sharing the same name, and all cameras will be populated with a perspective mapping sharing the same name.
5. Type directly into the **New mapping:** text field to create a new mapping. A list will appear prompting to you select the mapping type.



6. An editor with the user assigned name of the mapping will appear once a mapping type is selected.
7. Assign all screens that will be used for the mapping and enter the resolution of the content that will be displayed on the screens.
8. Edit the specific properties of the chosen mapping type.
9. Assign a piece of content to the layer in the track, and the content will be displayed on the assigned screens of the mapping in the stage and the feed output window.

## Common Mapping Properties

This section explains the properties that are shared by the six different mapping types.

### Filtering

**Nearest** - Nearest neighbor filtering. Use nearest-neighbour sampling, to disable blending between pixels when scaling. Can be used to create pixellated looks, or to ensure hard edges on certain types of content.

**Bilinear** - Bilinear filtering is a texture filtering method used to smooth textures when displayed larger or smaller than they actually are.

**2x Multi-sample** - Multi-Sample filtering can help fix issues with scaled content, but can introduce some blurriness.

## Resolution

This controls the canvas size the layer renders into, in pixels. The Direct mapping type starts with a 256x256 pixel canvas and automatically sets the canvas size to that of the first screen you add.

## Screens

This is a list of screens that the selected mapping type can copy content to.

1. Left-click **+** to open the Screens manager.
2. Left-click the Screens you want to map. This will copy the individual canvas content onto these three Screens simultaneously and will add the Screen names to the mapping object editor.
3. Left-click and drag the Screens listed in the mapping object editor to **-**. This will remove the canvas content from the Screens and delete the Screen names from the mapping object editor.

## Mask

This points to the Texture file that defines a Mask bitmap. You can use this property to apply a Mask bitmap to the mapping canvas. Selecting this property will open the Texture object library, which shows all of the still image files saved on your local hard-drive in the **DxTexture** folder.

To apply a mapping mask you will need to create and import a custom still image file.

- The step-by-step instructions on how to create and import a custom Population mask can be used to create a custom mapping mask. The only difference is that the mapping masks resolution should be the same as the mapping canvas. For step-by-step instructions on how to create and import a Population mask into a d3 project visit to the section Population mask in the [Editing screens](#) sub-chapter.
- Alternatively, set any layers blend mode to **mask** to channel the layer content into the mapping mask.

# Cylindrical mapping

The Cylindrical mapping type wraps content around a cylinder and fires it outwards (or inwards) onto the selected screens. Similar to the [Parallel mapping](#) and the [Perspective mapping](#) types, the content is being virtually projected from the surfaces of the cylinder, both inwards and outwards.

Cylindrical mapping wraps content around a cylinder and emits it inward or outward towards the screens assigned to it. It does not matter if the screen is moving or expanding, the Cylindrical mapping re-maps the content in real-time to accommodate for the movement, similar to parallel mapping.

## Creating a Cylindrical mapping

1. In your track, create a new visual layer. These layer types can include content layers, generative layers, and effect layers.
2. Left click on the layer in the track to open the Layer Editor on the left side of the GUI.
3. Under the **Default** tab, left click on the Mapping parameter to display a list of the mappings in the project.
4. A manager titled **mappings** will appear – this is a list of all mappings within your project. By default, all screens will be populated with a direct mapping sharing the same name, and all cameras will be populated with a perspective mapping sharing the same name.
5. Type directly into the **New mapping:** text field to create a new mapping. A list will appear prompting to you select the mapping type.

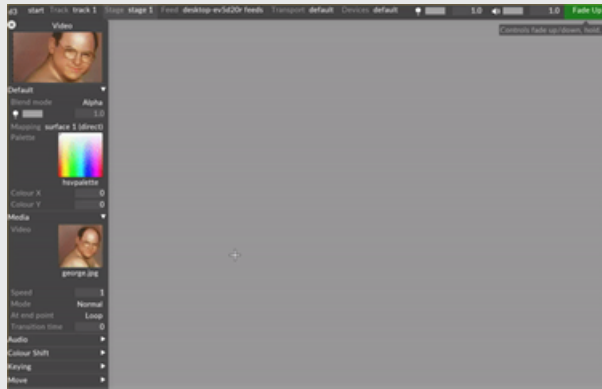

6. An editor with the user assigned name of the mapping will appear once a mapping type is selected.
7. Assign all screens that will be used for the mapping and enter the resolution of the content that will be displayed on the screens.
8. Edit the specific properties of the chosen mapping type.
9. Assign a piece of content to the layer in the track, and the content will be displayed on the assigned screens of the mapping in the stage and the feed output window.

## Common Mapping Properties

This section explains the properties that are shared by the six different mapping types.

### Filtering

**Nearest** - Nearest neighbor filtering. Use nearest-neighbour sampling, to disable blending between pixels when scaling. Can be used to create pixellated looks, or to ensure hard edges on certain types of content.

**Bilinear** - Bilinear filtering is a texture filtering method used to smooth textures when displayed larger or smaller than they actually are.

**2x Multi-sample** - Multi-Sample filtering can help fix issues with scaled content, but can introduce some blurriness.

## Resolution

This controls the canvas size the layer renders into, in pixels. The Direct mapping type starts with a 256x256 pixel canvas and automatically sets the canvas size to that of the first screen you add.

## Screens

This is a list of screens that the selected mapping type can copy content to.

1. Left-click **+** to open the Screens manager.
2. Left-click the Screens you want to map. This will copy the individual canvas content onto these three Screens simultaneously and will add the Screen names to the mapping object editor.
3. Left-click and drag the Screens listed in the mapping object editor to **-**. This will remove the canvas content from the Screens and delete the Screen names from the mapping object editor.

## Mask

This points to the Texture file that defines a Mask bitmap. You can use this property to apply a Mask bitmap to the mapping canvas. Selecting this property will open the Texture object library, which shows all of the still image files saved on your local hard-drive in the **DxTexture** folder.

To apply a mapping mask you will need to create and import a custom still image file.

- The step-by-step instructions on how to create and import a custom Population mask can be used to create a custom mapping mask. The only difference is that the mapping masks resolution should be the same as the mapping canvas. For step-by-step instructions on how to create and import a Population mask into a d3 project visit to the section Population mask in the [Editing screens](#) sub-chapter.
- Alternatively, set any layers blend mode to **mask** to channel the layer content into the mapping mask.



# Cylindrical mapping properties

## Output

By default, this is set to **colour**. This implies that red, green and blue content channels are sent to the red/green/blue colour output channels of the screen (or converted to cyan, magenta and yellow if the output fixtures are CMY). However, content can also be channelled to other channels in the case of DMX-based fixtures. Currently, this is a beta functionality, so for the moment you are advised to leave this set to **colour**.

## Anchor

As with the Parallel mapping type, you can anchor the cylinder around the centre, or the top or bottom points. Resize and rotation operations will keep the anchor point in the same place.

## Centre

This controls the stage position of the centre of the cylinder (in other words, its anchor point).

## Size

This controls the size of the cylinder in meters, on the x, y and z axes respectively. The y property (the second value) controls the height; the two other properties control the radii in the x and z axes. Setting x and z to the same value keeps the cylinders crosssection circular; setting them to different values makes it elliptical.

## Rotation

This rotates the cylinder around the anchor point; specified in degrees of rotation around the x, y and z axes respectively.

## Using the cylindrical mapping type

In addition to the property explanations provided in the sub-chapter Common mapping type properties, it is important to:

— Base the resolution of the Cylindrical mapping on the aspect between the circumference of the cylinder and the height of the screen. The circumference can be calculated by taking the **diameter \* pi, = size \* 3.14** . Set the size x and z to the same value to establish as perfect circular shape.

# Perspective mapping

Perspective mapping is similar to Parallel mapping, except that the content originates at an emitter point and gets larger in size as you go further away from the emitter, similar to a real projector. You can use Perspective mapping to make 2D content appear as 3D (not stereoscopic but rather as a 3D effect), but only from a specific point of view which is the same point as the position of the emitter.

Perspective mapping can map 3D content onto a surface from a specified vantage point of a virtual camera. This camera can be linked to a virtual camera in a generative software such as Notch to create an immersive 3D environment. The content being displayed by the mapping will begin emitting at the vantage point and get larger as that surfaces moves farther from it, similar to a real projector.

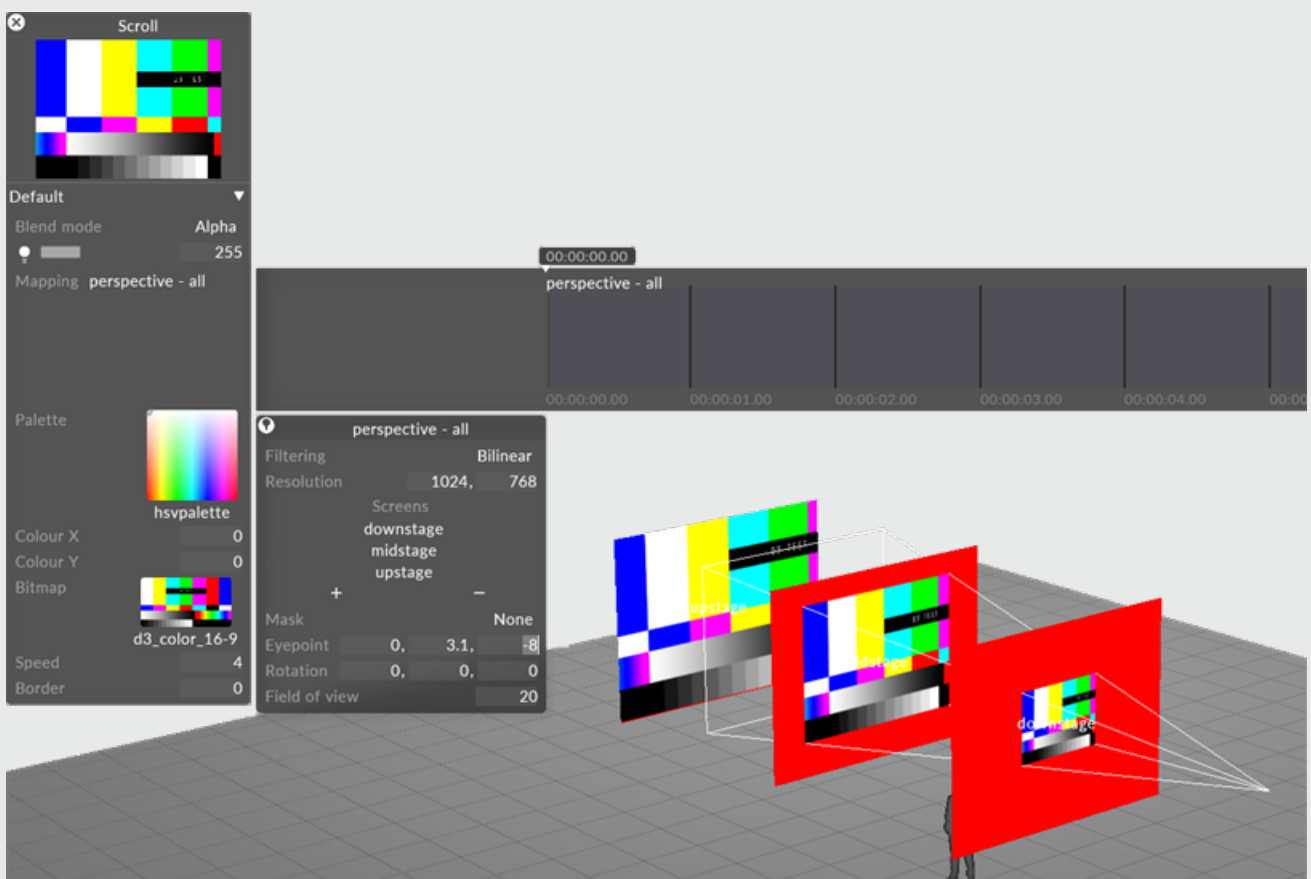

*Perspective mapping type being used to project content onto three Screens, notice the content becomes larger as the Screens move further away from the emitter point*

# Creating a Perspective Mapping

1. In your track, create a new visual layer. These layer types can include content layers, generative layers, and effect layers.
2. Left click on the layer in the track to open the Layer Editor on the left side of the GUI.
3. Under the **Default** tab, left click on the Mapping parameter to display a list of the mappings in the project.
4. A manager titled **mappings** will appear – this is a list of all mappings within your project. By default, all screens will be populated with a direct mapping sharing the same name, and all cameras will be populated with a perspective mapping sharing the same name.
5. Type directly into the **New mapping:** text field to create a new mapping. A list will appear prompting to you select the mapping type.



6. An editor with the user assigned name of the mapping will appear once a mapping type is selected.
7. Assign all screens that will be used for the mapping and enter the resolution of the content that will be displayed on the screens.
8. Edit the specific properties of the chosen mapping type.

9. Assign a piece of content to the layer in the track, and the content will be displayed on the assigned screens of the mapping in the stage and the feed output window.

## Common Mapping Properties

This section explains the properties that are shared by the six different mapping types.

### Filtering

**Nearest** - Nearest neighbor filtering. Use nearest-neighbour sampling, to disable blending between pixels when scaling. Can be used to create pixellated looks, or to ensure hard edges on certain types of content.

**Bilinear** - Bilinear filtering is a texture filtering method used to smooth textures when displayed larger or smaller than they actually are.

**2x Multi-sample** - Multi-Sample filtering can help fix issues with scaled content, but can introduce some blurriness.

### Resolution

This controls the canvas size the layer renders into, in pixels. The Direct mapping type starts with a 256x256 pixel canvas and automatically sets the canvas size to that of the first screen you add.

### Screens

This is a list of screens that the selected mapping type can copy content to.

1. Left-click **+** to open the Screens manager.
2. Left-click the Screens you want to map. This will copy the individual canvas content onto these three Screens simultaneously and will add the Screen names to the mapping object editor.
3. Left-click and drag the Screens listed in the mapping object editor to **-**. This will remove the canvas content from the Screens and delete the Screen names from the mapping object editor.

## Mask

This points to the Texture file that defines a Mask bitmap. You can use this property to apply a Mask bitmap to the mapping canvas. Selecting this property will open the Texture object library, which shows all of the still image files saved on your local hard-drive in the **DxTexture** folder.

To apply a mapping mask you will need to create and import a custom still image file.

- The step-by-step instructions on how to create and import a custom Population mask can be used to create a custom mapping mask. The only difference is that the mapping masks resolution should be the same as the mapping canvas. For step-by-step instructions on how to create and import a Population mask into a d3 project visit to the section Population mask in the [Editing screens](#) sub-chapter.
- Alternatively, set any layers blend mode to **mask** to channel the layer content into the mapping mask.

## Perspective Mapping Properties

### Eye point

The Eye point specifies the source point (emitting point) of the Perspective mapping.

### Rotation

The Rotation parameter specifies the rotation of the frustum of the Perspective mapping (i.e. the aiming point of the Perspective mapping).

### Field of view

Defines the field of view of the Perspective mapping, in degrees (i.e. the size of the mapping coverage).

# PreComp

A PreComp (or pre composition) in Disguise software acts as a virtual screen for you to write content to which can then be used as an input to another effect or composition. It also provides an alternative to the arrowing system which was limited to a one to one input, whereas a PreComp can be one to many.

A PreComp (or pre composited texture) acts as a container for multiple textures, which can then be used as an input source to another effect or composition. It also expands the capabilities of the arrow/piping system, which was limited to a one input per source. A PreComp can be many inputs to many sources.

The PreComp is applied as a mapping to all the texture/content inputs of the composition.

## Creating a PreComp

A PreComp is created just like other textures in Disguise software, from the location where you will be using it. You cannot create a PreComp in some texture fields (such as a palette).

A PreComp is created like other textures in the disguise software such as masks, from the Textures menu, which can be accessed from any layer that utilizes a texture input. Like any other texture, once it is created, it will be stored in the Textures menu and can be used in other locations.

1. Create a new layer and select a layer type that has a **Texture source** property, such as an Effect layer or Legacy Bitmaplayer.
2. In the new texture field, enter a name for your PreComp. Choose PreComp Texture as the texture type.
3. Set the desired resolution for the PreComp (just as you would do if this was a real, physical screen. This should correspond to the resolution of the screen it will be mapped to.

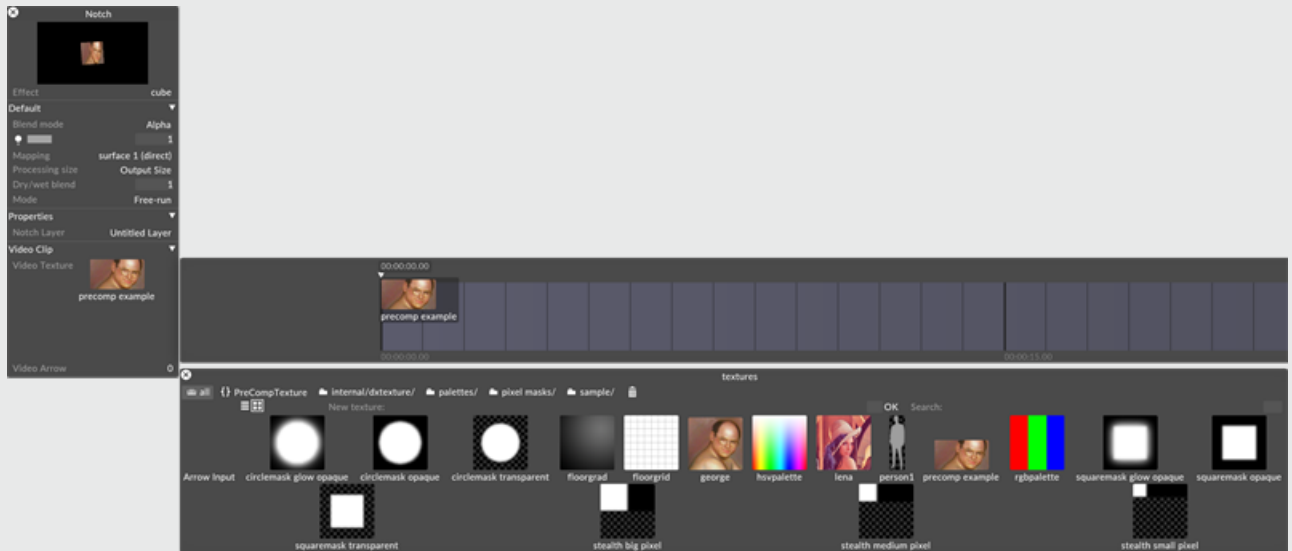

## Building the PreComp

Once you have created a PreComp, a new default Direct mapping will now be present in the Mappings Manager, allowing you to route content into the PreComp from a content layer. Content layers include other texture layers as listed above, Video layers, and Generative layers.

1. Create a content layer and left click on the content layer in the timeline to open the layer's properties.
2. Set the layer to display the desired content.
3. Under the Mapping properties field, select the mapping with the same name as the newly created PreComp.
4. Repeat these steps with as many content layers as will be used in the PreComp.



**Please note:** A PreComp cannot be chained, i.e. a PreComp cannot feed into another PreComp.

## Using the PreComp as a source for an Effect Layer

The PreComp can be used as the Source texture input to an effect layer.

1. Create an Effect Layer and position it above the source PreComp layers.
2. Set the Effects layer mapping to the screens the content will be shown on (do not choose the PreComp mapping).
3. From the Source Input field under the Default tab, select the PreComp.
4. All of the individual content layers will now be piped into the Effect layer simultaneously.
5. Hold down shift and left click to select all of the source layers used in the PreComp.
6. Right click on the layers and name a group for the source layers.
7. Note that the source layers must be underneath the Effect layer for the PreComp to show up.



**Please note:** The source layers that make up the PreComp have to be positioned under the Layer that is referencing the PreComp texture. To reuse the same PreComp in multiple places, the source layers must be duplicated.

# Using the PreComp in multiple tracks

In order to use the PreComp in multiple locations, all of the layers that are contained in the PreComp stack need to be copied as well. One way to do this is to create a Group for the PreComp and all of its layers.

1. Select all of the layers that are contained in the PreComp stack; once all have been selected, then right click on the group while they are selected. Type in a name for the group of layers in the Group field and click OK.



2. Next, right click on the name of the newly created PreComp group in the timeline; click OK next to the **Save As** field; this will add the group of layers to the **Layer Library**

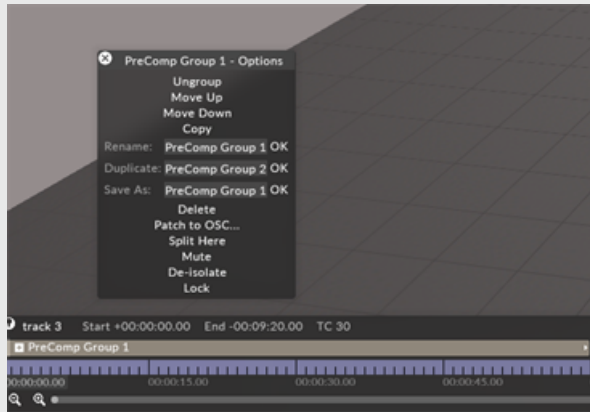

3. Switch to the desired track.
4. Right click in the timeline for the track.
5. Select Import Layer.

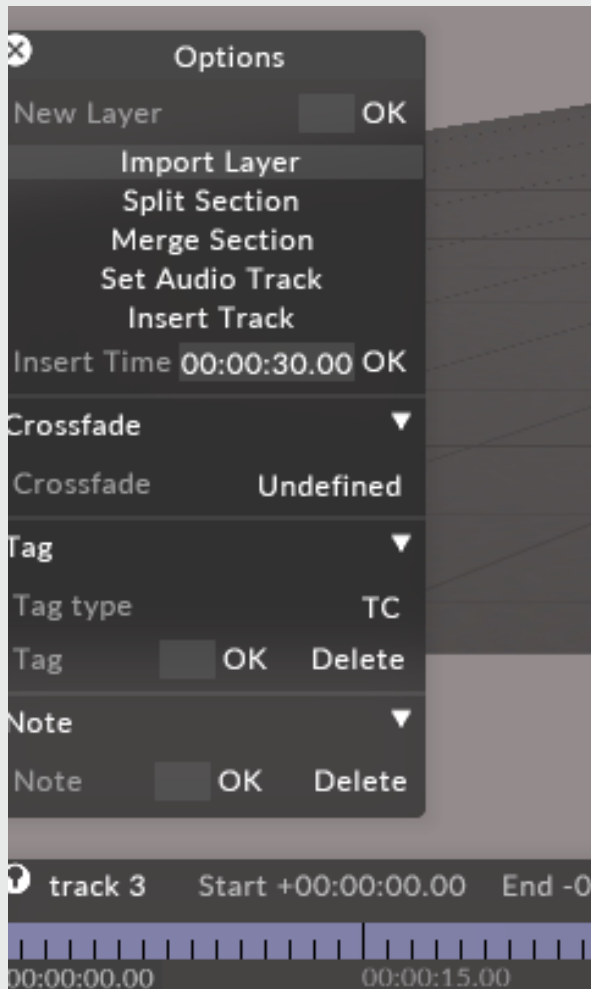

6. Select the name of the group of layers you wish to import from the **Layer Library**.

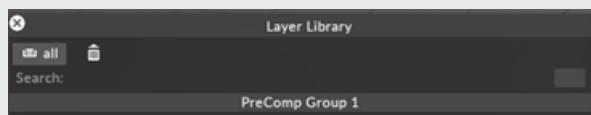

Now you can use the same PreComp many times throughout the project.

# Previewing a PreComp

1. Right click on the PreComp thumbnail in the Layer properties window.
2. Use middle mouse button to pan around the expanded preview.

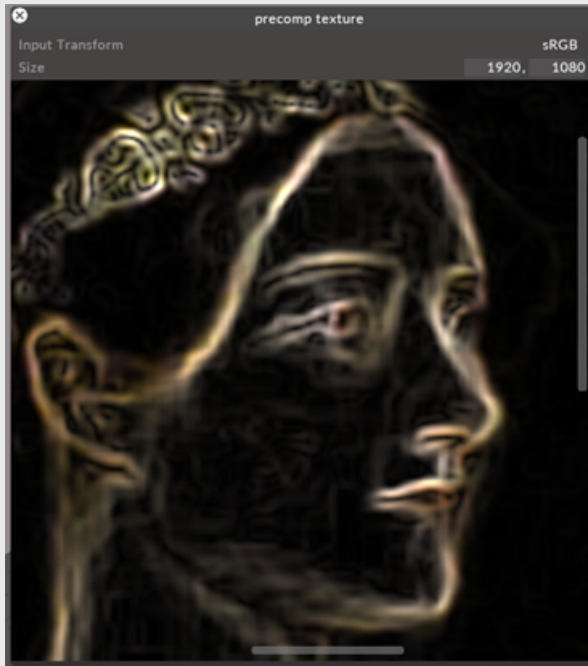

# Radial mapping

The Radial mapping is similar to the Cylindrical mapping type, except that the content surface runs from the central axis to the cylinder rim, rather than being wrapped around the outside of the cylinder. Any fixtures or pixels inside the cylinder will therefore be mapped according to their height within the cylinder (y coordinate) and their distance from the cylinders axis (x coordinate). Fixtures outside of the cylinder are not affected.

Radial mapping is similar to the Cylindrical mapping, except that the emitter surface runs from the central axis to the cylinder rim, rather than being wrapped around the outside of the cylinder. The pixels inside the cylinder will therefore be mapped according to their height within the cylinder and their distance from the central axis.

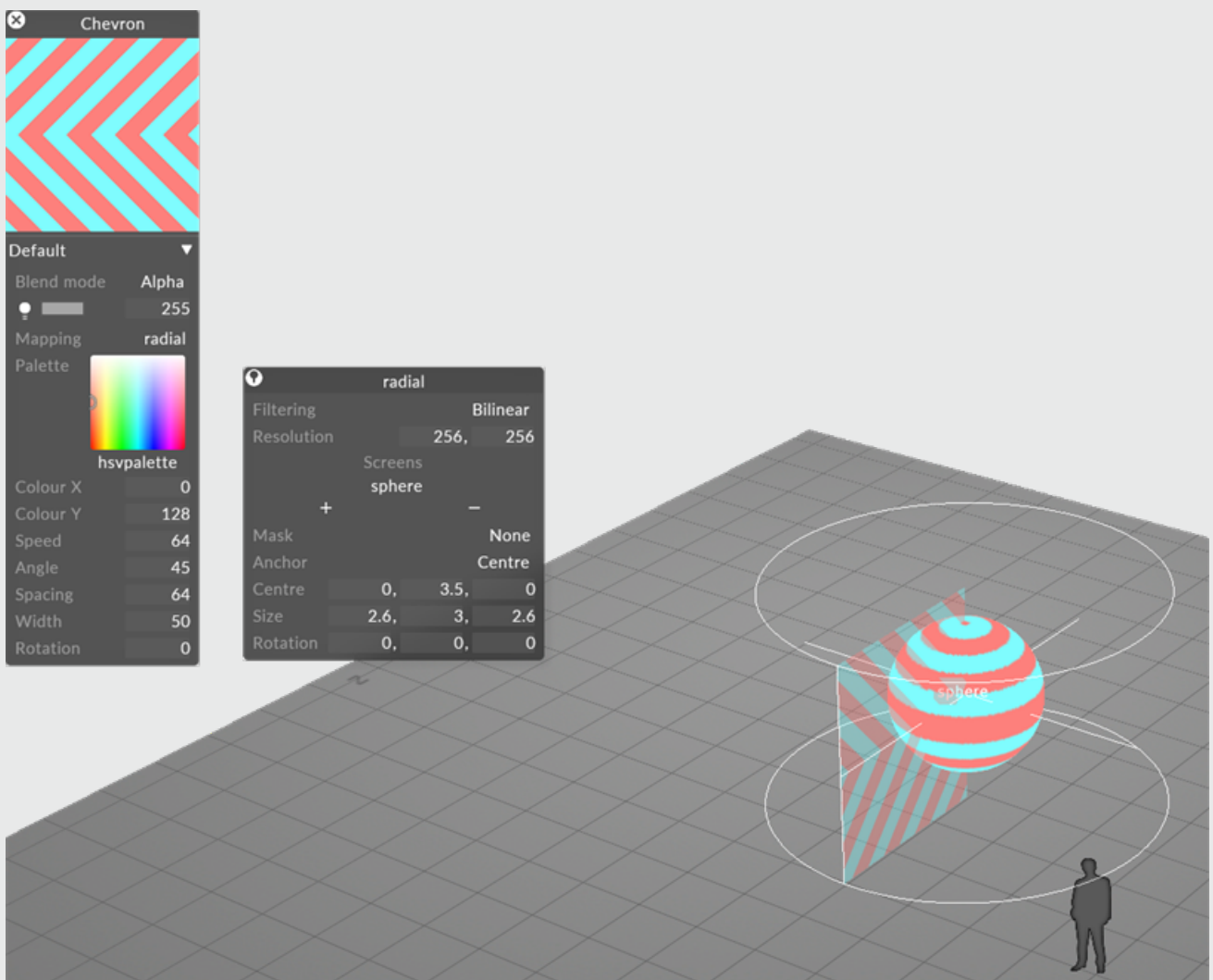

Radial mapping type is similar to Cylindrical mapping except that the content surface runs from the central axis to the cylinder rim

## Creating a Radial Mapping

1. In your track, create a new visual layer. These layer types can include content layers, generative layers, and effect layers.
2. Left click on the layer in the track to open the Layer Editor on the left side of the GUI.
3. Under the **Default** tab, left click on the Mapping parameter to display a list of the mappings in the project.
4. A manager titled **mappings** will appear – this is a list of all mappings within your project. By default, all screens will be populated with a direct mapping sharing the same name, and all cameras will be populated with a perspective mapping sharing the same name.
5. Type directly into the **New mapping:** text field to create a new mapping. A list will appear prompting to you select the mapping type.



6. An editor with the user assigned name of the mapping will appear once a mapping type is selected.
7. Assign all screens that will be used for the mapping and enter the resolution of the content that will be displayed on the screens.

8. Edit the specific properties of the chosen mapping type.
9. Assign a piece of content to the layer in the track, and the content will be displayed on the assigned screens of the mapping in the stage and the feed output window.

## Common Mapping Properties

This section explains the properties that are shared by the six different mapping types.

### Filtering

**Nearest** - Nearest neighbor filtering. Use nearest-neighbour sampling, to disable blending between pixels when scaling. Can be used to create pixellated looks, or to ensure hard edges on certain types of content.

**Bilinear** - Bilinear filtering is a texture filtering method used to smooth textures when displayed larger or smaller than they actually are.

**2x Multi-sample** - Multi-Sample filtering can help fix issues with scaled content, but can introduce some blurriness.

### Resolution

This controls the canvas size the layer renders into, in pixels. The Direct mapping type starts with a 256x256 pixel canvas and automatically sets the canvas size to that of the first screen you add.

### Screens

This is a list of screens that the selected mapping type can copy content to.

1. Left-click **+** to open the Screens manager.
2. Left-click the Screens you want to map. This will copy the individual canvas content onto these three Screens simultaneously and will add the Screen names to the mapping object editor.
3. Left-click and drag the Screens listed in the mapping object editor to **-**. This will remove the canvas content from the Screens and delete the Screen names from the mapping object editor.



## Mask

This points to the Texture file that defines a Mask bitmap. You can use this property to apply a Mask bitmap to the mapping canvas. Selecting this property will open the Texture object library, which shows all of the still image files saved on your local hard-drive in the **DxTexture** folder.

To apply a mapping mask you will need to create and import a custom still image file.

- The step-by-step instructions on how to create and import a custom Population mask can be used to create a custom mapping mask. The only difference is that the mapping masks resolution should be the same as the mapping canvas. For step-by-step instructions on how to create and import a Population mask into a d3 project visit to the section Population mask in the [Editing screens](#) sub-chapter.
- Alternatively, set any layers blend mode to **mask** to channel the layer content into the mapping mask.

## Radial Mapping Properties

### Anchor

Base point from which the scale of the Radial mapping has its origin.

### Centre

Position of the Radial mapping based on the centre point of the cylinder.

### Size

The size of the Radial mapping. The x and z values represent the diameter of the cylinder.

### Rotation

The x, y, z rotation of the cylinder.

# Spatial mapping

The Spatial map targets an MRset so it understands camera tally, and also allows for world offset between the d3 world and the content world.

The Spatial mapping was introduced for the AR & xR workflows, and allows for the camera's perspective and position to be relative to the virtual scene. The camera can travel around the 3D environment and accurately render it from any perspective

## Creating a Spatial Mapping

1. In your track, create a new visual layer. These layer types can include content layers, generative layers, and effect layers.
2. Left click on the layer in the track to open the Layer Editor on the left side of the GUI.
3. Under the **Default** tab, left click on the Mapping parameter to display a list of the mappings in the project.
4. A manager titled **mappings** will appear – this is a list of all mappings within your project. By default, all screens will be populated with a direct mapping sharing the same name, and all cameras will be populated with a perspective mapping sharing the same name.
5. Type directly into the **New mapping:** text field to create a new mapping. A list will appear prompting to you select the mapping type.



6. An editor with the user assigned name of the mapping will appear once a mapping type is selected.
7. Assign all screens that will be used for the mapping and enter the resolution of the content that will be displayed on the screens.
8. Edit the specific properties of the chosen mapping type.
9. Assign a piece of content to the layer in the track, and the content will be displayed on the assigned screens of the mapping in the stage and the feed output window.

## Common Mapping Properties

This section explains the properties that are shared by the six different mapping types.

### Filtering

**Nearest** - Nearest neighbor filtering. Use nearest-neighbour sampling, to disable blending between pixels when scaling. Can be used to create pixellated looks, or to ensure hard edges on certain types of content.

**Bilinear** - Bilinear filtering is a texture filtering method used to smooth textures when displayed larger or smaller than they actually are.

**2x Multi-sample** - Multi-Sample filtering can help fix issues with scaled content, but can introduce some blurriness.

## Resolution

This controls the canvas size the layer renders into, in pixels. The Direct mapping type starts with a 256x256 pixel canvas and automatically sets the canvas size to that of the first screen you add.

## Screens

This is a list of screens that the selected mapping type can copy content to.

1. Left-click **+** to open the Screens manager.
2. Left-click the Screens you want to map. This will copy the individual canvas content onto these three Screens simultaneously and will add the Screen names to the mapping object editor.
3. Left-click and drag the Screens listed in the mapping object editor to **-**. This will remove the canvas content from the Screens and delete the Screen names from the mapping object editor.

## Mask

This points to the Texture file that defines a Mask bitmap. You can use this property to apply a Mask bitmap to the mapping canvas. Selecting this property will open the Texture object library, which shows all of the still image files saved on your local hard-drive in the **DxTexture** folder.

To apply a mapping mask you will need to create and import a custom still image file.

- The step-by-step instructions on how to create and import a custom Population mask can be used to create a custom mapping mask. The only difference is that the mapping masks resolution should be the same as the mapping canvas. For step-by-step instructions on how to create and import a Population mask into a d3 project visit to the section Population mask in the [Editing screens](#) sub-chapter.
- Alternatively, set any layers blend mode to **mask** to channel the layer content into the mapping mask.

# Spatial Mapping Properties

## Initial

### Initial Origin

Defines the origin of the bounding box before any offset is applied.

### Initial Rotation

Defines the rotation of the bounding box before any rotation is applied.

### Initial Size

Defines the size of the bounding box before any scaling is applied.

# Spherical Mapping

The Spherical Mapping works similarly to the Cylindrical mapping, except the top and bottom are 'pinched' to create a sphere.

Spherical Mapping works similarly to the Cylindrical mapping, except the top and bottom are 'pinched' to create a sphere.

**Video**

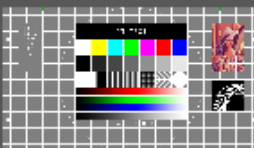

Default

Blend mode Alpha

255

Mapping spherical

Palette



hsvpalette

Colour X 0

Colour Y 0

Media

Video



d3\_test\_16-9.png

Speed 1

Mode Normal

At end point Loop

Transition time 0

Audio

Colour Shift

Keying

Move

Crop

00:00:00.00

spherical

00:00:00.00

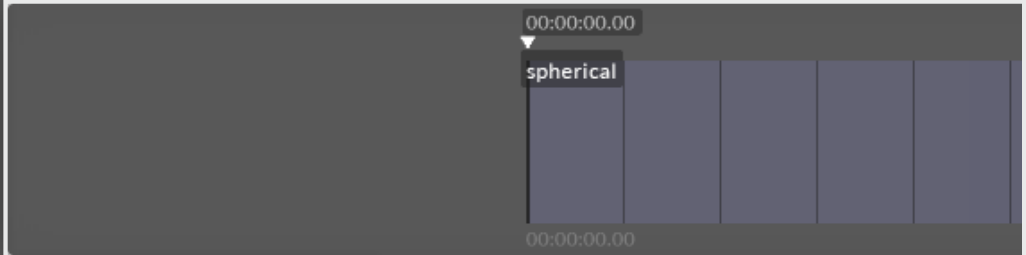

**spherical**

Filtering Bilinear

Resolution 1920, 1080

Screens surface 1

Mask None

pos 0, 2, 0

rot 0, 0, 0

horizontalAngle 360

verticalAngle 180

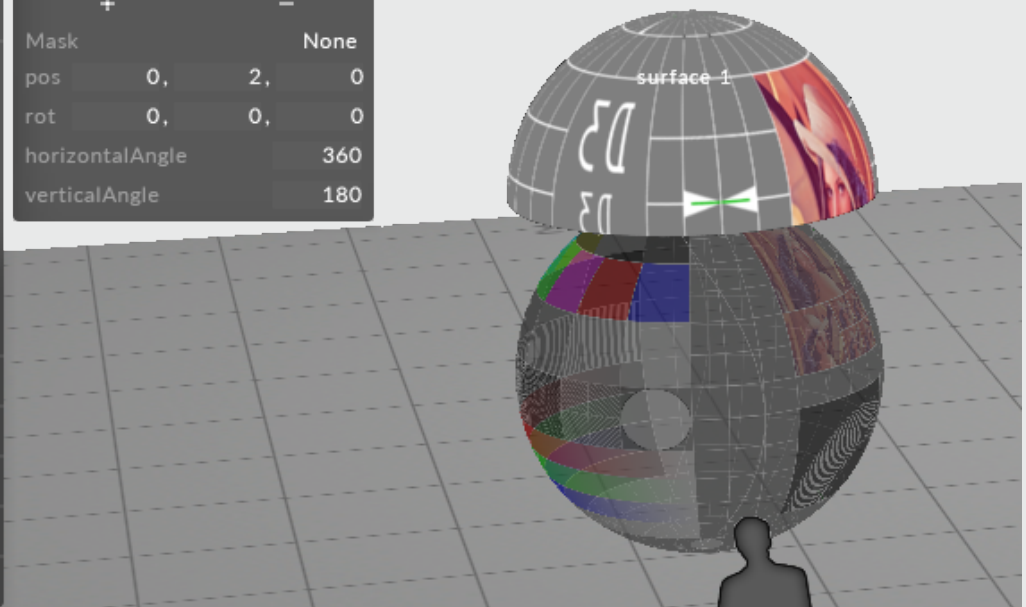

# Creating a Spherical Mapping

1. In your track, create a new visual layer. These layer types can include content layers, generative layers, and effect layers.
2. Left click on the layer in the track to open the Layer Editor on the left side of the GUI.
3. Under the **Default** tab, left click on the Mapping parameter to display a list of the mappings in the project.
4. A manager titled **mappings** will appear – this is a list of all mappings within your project. By default, all screens will be populated with a direct mapping sharing the same name, and all cameras will be populated with a perspective mapping sharing the same name.
5. Type directly into the **New mapping:** text field to create a new mapping. A list will appear prompting to you select the mapping type.

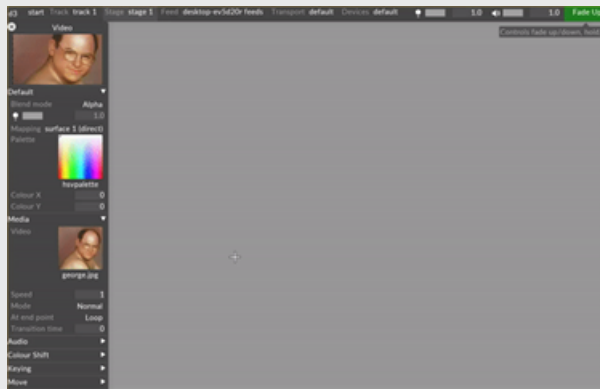

6. An editor with the user assigned name of the mapping will appear once a mapping type is selected.
7. Assign all screens that will be used for the mapping and enter the resolution of the content that will be displayed on the screens.
8. Edit the specific properties of the chosen mapping type.



9. Assign a piece of content to the layer in the track, and the content will be displayed on the assigned screens of the mapping in the stage and the feed output window.

## Common Mapping Properties

This section explains the properties that are shared by the six different mapping types.

### Filtering

**Nearest** - Nearest neighbor filtering. Use nearest-neighbour sampling, to disable blending between pixels when scaling. Can be used to create pixellated looks, or to ensure hard edges on certain types of content.

**Bilinear** - Bilinear filtering is a texture filtering method used to smooth textures when displayed larger or smaller than they actually are.

**2x Multi-sample** - Multi-Sample filtering can help fix issues with scaled content, but can introduce some blurriness.

### Resolution

This controls the canvas size the layer renders into, in pixels. The Direct mapping type starts with a 256x256 pixel canvas and automatically sets the canvas size to that of the first screen you add.

### Screens

This is a list of screens that the selected mapping type can copy content to.

1. Left-click **+** to open the Screens manager.
2. Left-click the Screens you want to map. This will copy the individual canvas content onto these three Screens simultaneously and will add the Screen names to the mapping object editor.
3. Left-click and drag the Screens listed in the mapping object editor to **-**. This will remove the canvas content from the Screens and delete the Screen names from the mapping object editor.

## Mask

This points to the Texture file that defines a Mask bitmap. You can use this property to apply a Mask bitmap to the mapping canvas. Selecting this property will open the Texture object library, which shows all of the still image files saved on your local hard-drive in the **DxTexture** folder.

To apply a mapping mask you will need to create and import a custom still image file.

- The step-by-step instructions on how to create and import a custom Population mask can be used to create a custom mapping mask. The only difference is that the mapping masks resolution should be the same as the mapping canvas. For step-by-step instructions on how to create and import a Population mask into a d3 project visit to the section Population mask in the [Editing screens](#) sub-chapter.
- Alternatively, set any layers blend mode to **mask** to channel the layer content into the mapping mask.

## Spherical Mapping Properties

### Horizontal Angle

Defines the horizontal angle of the mapping to map what the content was created to.

### Vertical Angle

Defines the vertical angle of the mapping to map what the content was created to.

# Layers overview

A layer is an object which renders content in response to certain inputs.

Layers can generate colours or gradients, play video or display still bitmap images. Content is generated by creating layers, placing them on the Timeline, and animating their properties using Disguise's keyframe editor within the layer editor.

The Disguise software uses **mappings** to control how layer content is copied from the Timeline to the screens in the Stage level. Please see the chapter [Content Mapping](#) for a full explanation of this powerful feature.

## Types of layers

There are five main layer types in Disguise: content layers, generative layers, pre-visualisation layers, effects layers and control layers. For more detailed information on layer types please read the sub-chapter [Overview of layer types](#).

## Controlling layer properties with Artnet

Disguise can be configured to control layer properties with Artnet. For step-by-step instructions on how to do this please read the sub-chapter [Controlling layer properties with Artnet](#). You may also be interested in the [Sockpuppet workflow](#).

## Controlling layer properties with OSC

Disguise can be configured to control layer properties with OSC. For step-by-step instructions on how to do this please read the sub-chapter [Controlling layer properties with Artnet](#).

# Creating layers

A layer can be created using two methods.

Please note: You can create a layer without a name, but it is recommended that you name your layers so that the Timeline is easier to understand.

## Option 1

1. Right-click the Track bar at the point on the Timeline where you want to create the layer. This will open the Track bars menu.
2. Type the name of the layer in the **new layer** text field and hit **Enter**.

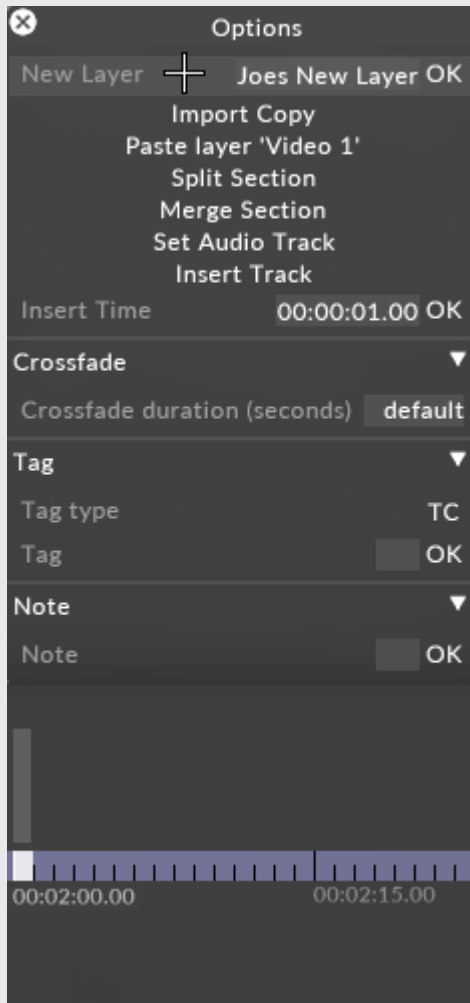

A good format for naming your layers is **Layer-type description**, for example **Bitmap-layer front screen projection**. This will open a list of all of the layers available in Disguise software.

3. The layer menu is separated into different layer categories (content, control, effects, generative and previsualisation) with each category grouped under a collapsible separator.
4. Typing into the search box opens up separators automatically to show you matching layer types.

5. Left-click the layer you want to create. This will create the new layer at the point on the Timeline you selected. The layers editor should also open in the top-left corner of your screen. You can now edit the layer or restructure the layer.

## Option 2

1. Select a Track bar at the point on the Timeline where you want to create a layer.
2. Hit **Ctrl+L**. A list of all of the layers available in Disguise software will open.
3. Left-click the layer you want to create. This will create the new layer at the point on the Timeline you selected. You can now edit the layer or restructure the layer.

# Editing layers

Editing layers involves using the Layer editor and the [Keyframe editor](#)

## What is the Layer editor?

The Layer editor contains a series of properties which are specifically set for each individual layer. All of these properties can be edited.

## Opening / closing the Layer editor

To open the Layer editor:

- Left-click the layer from the Timeline.

For information on how to create a layer please see the sub-chapter [Creating layers](#).

If the currently selected Track bar is underneath the extent of the layer (not including the extender tabs on either side), the Layer editor will open at the top left of your screen. If the currently selected Track bar is outside the extent of the layer, Disguise software will close the editor. This is to ensure that you only see editors for layers that are active.

The layer editor looks like a standard object editor, except that it has a small preview window at the top of the editor showing you what the layer output looks like.

To close the Layer editor:

- Left-click the layer in the Timeline, or left-click the close button (x icon) in the top-left corner of the Layer editor.

Please note: hit **Ctrl** whilst left-clicking a layer in the Timeline to view multiple Layer editors simultaneously.

## Layer properties

Each layer in Disguise software has a specific set of properties. Please read the chapter [Layer types](#) to understand each layer types individual properties. In addition, please read the next sub-chapter [Common layer properties](#) which explains the properties that are shared by most layers that produce visual output.

# MultiLayer Editor

In r17.3 multiple layers can be edited simultaneously making it easier to assign common values or objects across a selection of layers in one action.

## Using the MultiLayerEditor

1. Hold **Shift**, left click and drag a selection over multiple layers
2. Left click your selection and a MultiLayerEditor will open that contains all common values to the layers selected

## Tips for using the MultiLayerEditor

- Shift + Click to add an un-selected layer to the selection, or remove a layer from the selection.
- A MultiLayerEditor is created for a layer selection, when more than one layer is selected
- A MultiLayerEditor is also created when a single GroupLayer is selected.
- If a selection contains only GroupLayers, a MultiLayerEditor is not created.
- If a selection contains Layers and GroupLayers, a MultiLayerEditor is created for the Layers only.
- Opening a MultiLayerEditor will not close existing Layer editors for the selected layers.
- Adding a layer to the selection or removing one from the selection will create a new MultiLayerEditor with the new selection.



- A MultiLayerEditor can only be opened for layers when the track cursor is within all of the selected layers.
- The MultiLayerEditor will show all the common fields of all selected layers. The fields will be under the same tabs.
- The fields in the MultiLayerEditor show an aggregation of all the values of the selected layers.
- The tooltip of the ValueBox will contain the current values and associated layer names.
- Dropping a new keyframe will create a new keyframe in all selected layers.
- Modifying an existing keyframe will modify the keyframe in the layers where the keyframe exists.
- Deleting a keyframe will delete the keyframe in the layers the keyframe exists.
- Popup menu actions in the keywidget, like changing interpolation type apply to all selected layers.
- Keyframe navigation is the same as the Layer editor

## Limitations

- Keyframes for each layer are all visible in the same keyframe editor, which can make it hard to know which keyframe belongs to which layer.
- There is no preview in the MultiLayerEditor
- Keyframes for each layer are all visible in the same keyframe editor, which can make it hard to know which keyframe belongs to which layer.
- Some fields may have the same display name but different internal names and will therefore not appear. Some fields may also have the same name but different values, these should not appear. An example is: multi-selecting audio and video layers misses volume control and at-endpoint control.
- The MultiLayerEditor cannot aggregate fields that are dynamically created by a custom layer editor. Therefore OpenModule is not compatible and neither are dynamic fields of a notch

block.

- Some fields may have the same name, but represent different things and therefore appear when they shouldn't. An example is: TimecodeReadout and Gradient Position X and Position Y parameters are incompatible with one another.

# Dynamic Layer Naming

## Dynamic Layer Naming

First available in r24, this feature allows users to rename layers with dynamic tags that will be automatically replaced in the rename process by specific values in the layer.

## Workflow

When renaming a layer either by right-clicking on the layer or pressing alt+r this feature is available.

1. In the layer's **Rename** field insert words between curly braces { } to create a dynamic tag.



*{blend mode}*

2. Press **Enter** or click **OK**

The text is automatically replaced with special values based on the tags entered.

**Note:** Typing in a layer name with mis-matching { } tags will stop renaming and make the 'Rename' widget turn **red** with the error explained in a tooltip.

### Renaming multiple layers:

1. When renaming multiple layers the user is presented with a confirmation dialog that shows of a preview of the renames to be generated. At this stage the user can either abort or finish the rename
2. This dialog can be toggled off with a toggle.

**Note:** The feature does not keep updating the names as you sequence, the rename is a one-time action.

## Documentation & Utility

Right-clicking on the field will bring up the documentation as described above as well as some text boxes that save the last rename you did and some places for the user to store renames that they would like to use frequently.

The tags that are supported are:

**{type}** is replaced by the type of the layer.

**{index}** is replaced by an incrementing index starting from 1.

You can append a number after \"index\" as the start number (e.g. {index5}).

**{currentname}** is replaced by the current name of the layer.

**<field>** will be replaced with the name of the first keyframe in the layer with the name <field>

Examples: {mapping}, {speed}, {blend mode}.

If a field is not present in the layer the {<field>} text will be removed from the final name.

# Layer Stack

As of r20, there is a new time-independent feature designed to allow you to easily assign and manage layers of treatments to a live video input.

With the time-independent Layer Stack, you can conveniently add input transforms, video overlays, masking, stylistic effects, colour effects, or even a colour keyer directly to a live video input. Once done, you can stack, compose and order your effect layers as well.

## Workflow

1. Open the Video Input Patch Editor and assign a camera to the Input field of a video input.
2. Click "Start Preview" to confirm your input is connected.
3. In the Layer Stack field, create a new Layer Stack by left clicking the 'None' field and adding a new Layer Stack to the list.

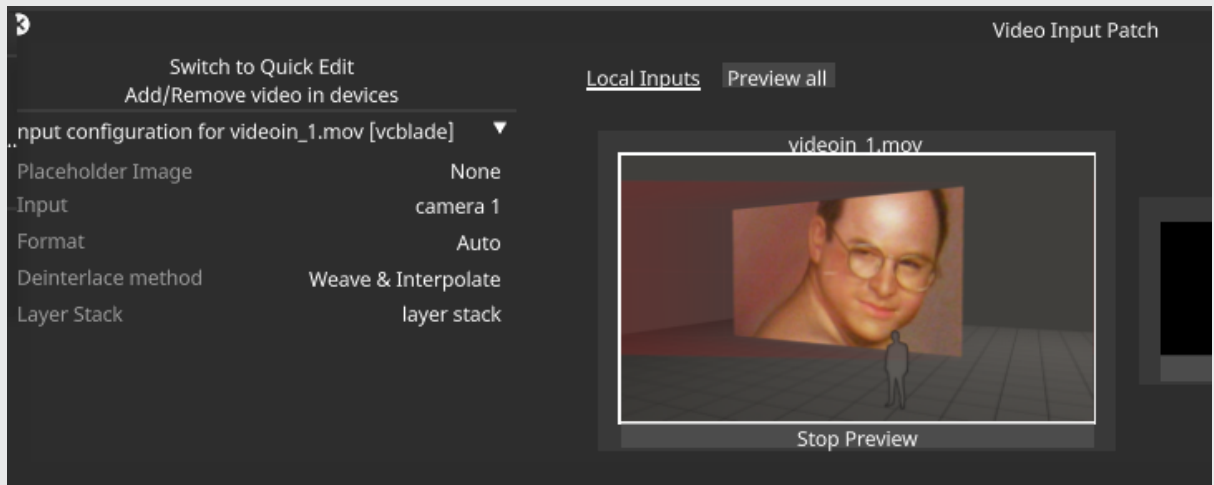

4. Next, right click on the Layer Stack and add a new layer.

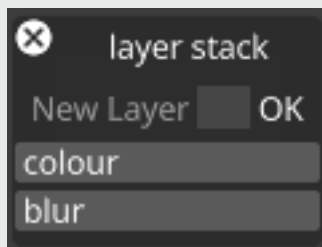

5. Once the new layer has been added, Left click on the layer to open its Layer Editor
6. Select the video input that you are creating the Layer Stack for as the Source Texture and then edit the properties of the layer as needed.
7. Add additional layers to the Layer Stack as desired.
8. Once all layers in the stack have been configured, close the Video Input Patch editor and add a new Video layer to the timeline. In the new Video layer, simply select the same Video input that you configured as the Media source. At that point, you will see the composition of the Video Input with its layer stack.

# Common layer properties

Most of the Disguise layers share the same properties.

These are:

- Preview Thumbnail
- Blendmode
- Brightness
- Mapping
- Palette
- xCol, yCol
- Content
- Colourshift

# Preview Thumbnail

This property is a small preview window at the top of the editor showing you what the layer output looks like.





# Brightness

This property (which appears as a light bulb icon) controls the brightness of the layer output.

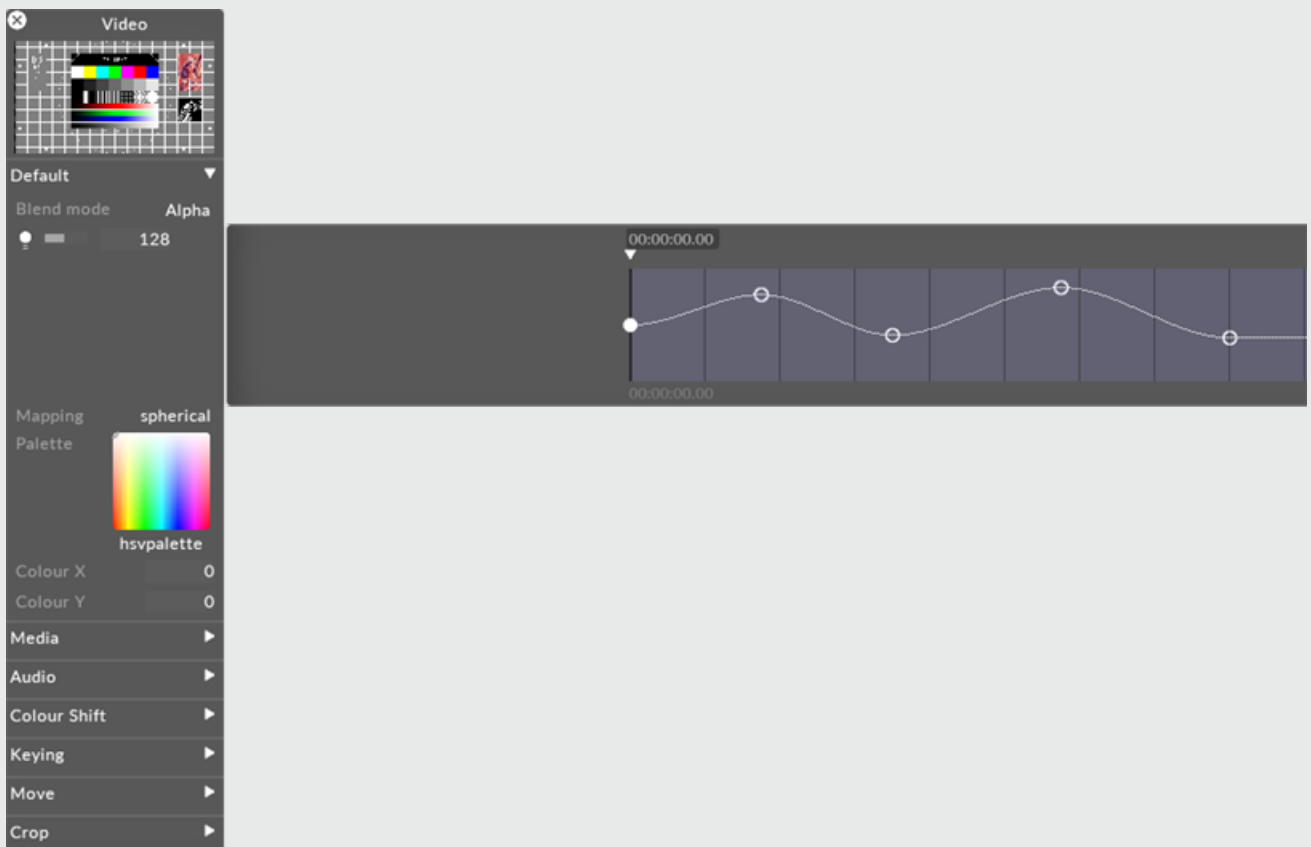

If the layers blend mode is set to Alpha, then reducing the brightness to 0 also reduces the opacity of the layer to 0. This can be useful when you want to dissolve from one layer to the next. In that case, you can place the new layer above the old layer and increase its brightness level.

# Content

This points to the still image/video file (depending on the layer type) that defines the Bitmap/Video layers content. Selecting this property will open the Texture/Videoclip object library, which shows all of the still image/video files saved on your local hard-drive in the DxTexture/VideoFile folder.

To change the content inputted into the layer:

1. Left-click bitmap / video (depending on the layer type) to open the Texture/Videoclip object library.
2. Left-click the still image/video file you want to input into the layer.

**Please note:** Disguise software does not provide video clips by default. If you want to use video or content other than the standard still images provided in Disguise software, you will need to import a custom still image/video file.

See the [Placing media files for a project](#) sub-chapter to understand where to place a custom still image file/video file and how to access it in Disguise software. Also save the file to a [supported file format](#).

# Mapping

The mapping property controls how the layer output is mapped onto the screen(s) in the Stage level.

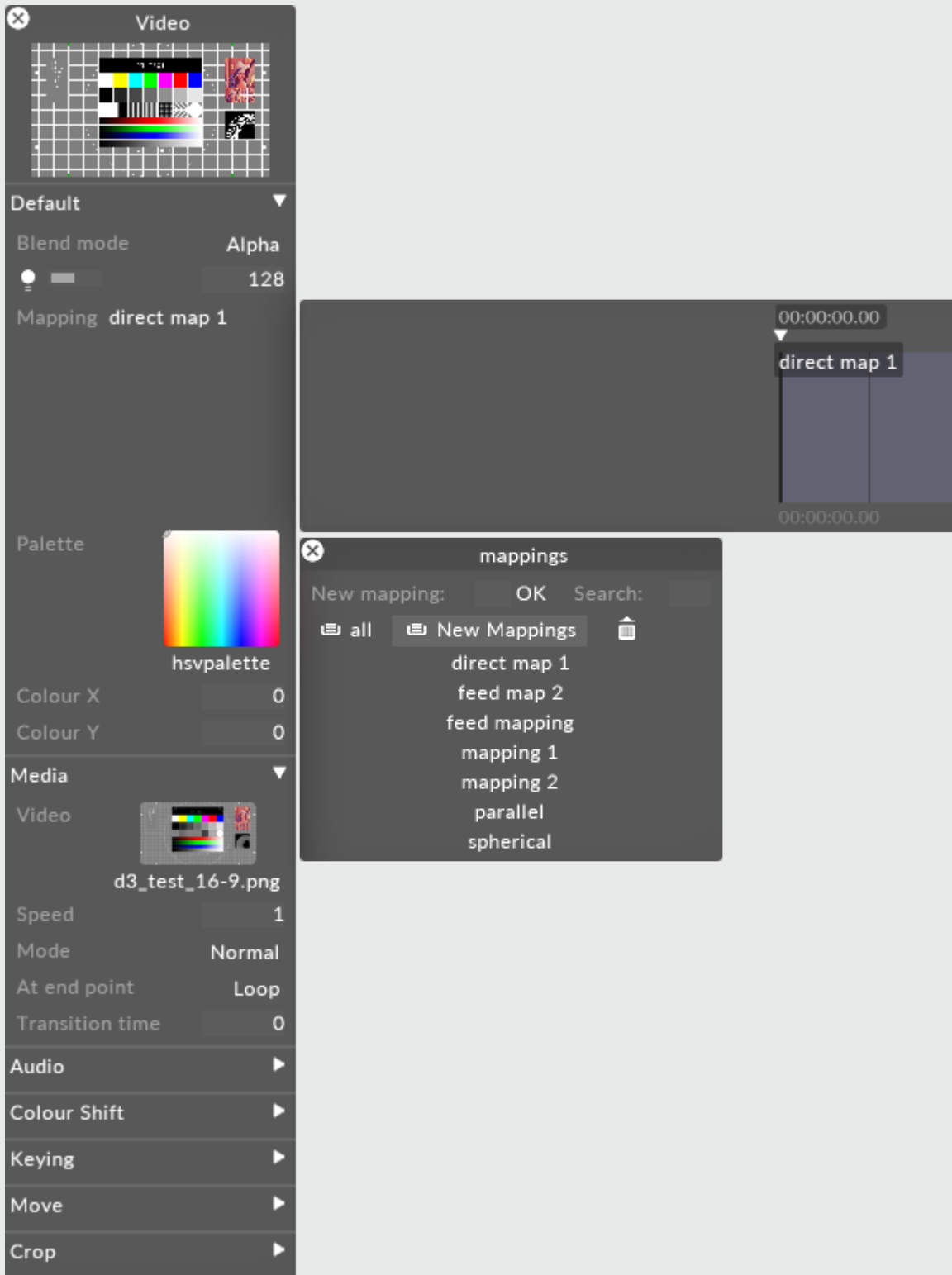

For information on mapping, including how to use the different mapping types offered by Disguise software, please see the chapter [Content Mapping](#).

# Blend Mode

BlendMode controls how the output of the layer is composited with the layers below. Layers are rendered in a bottom-up order: layers at the top can modify the output of the layers below.

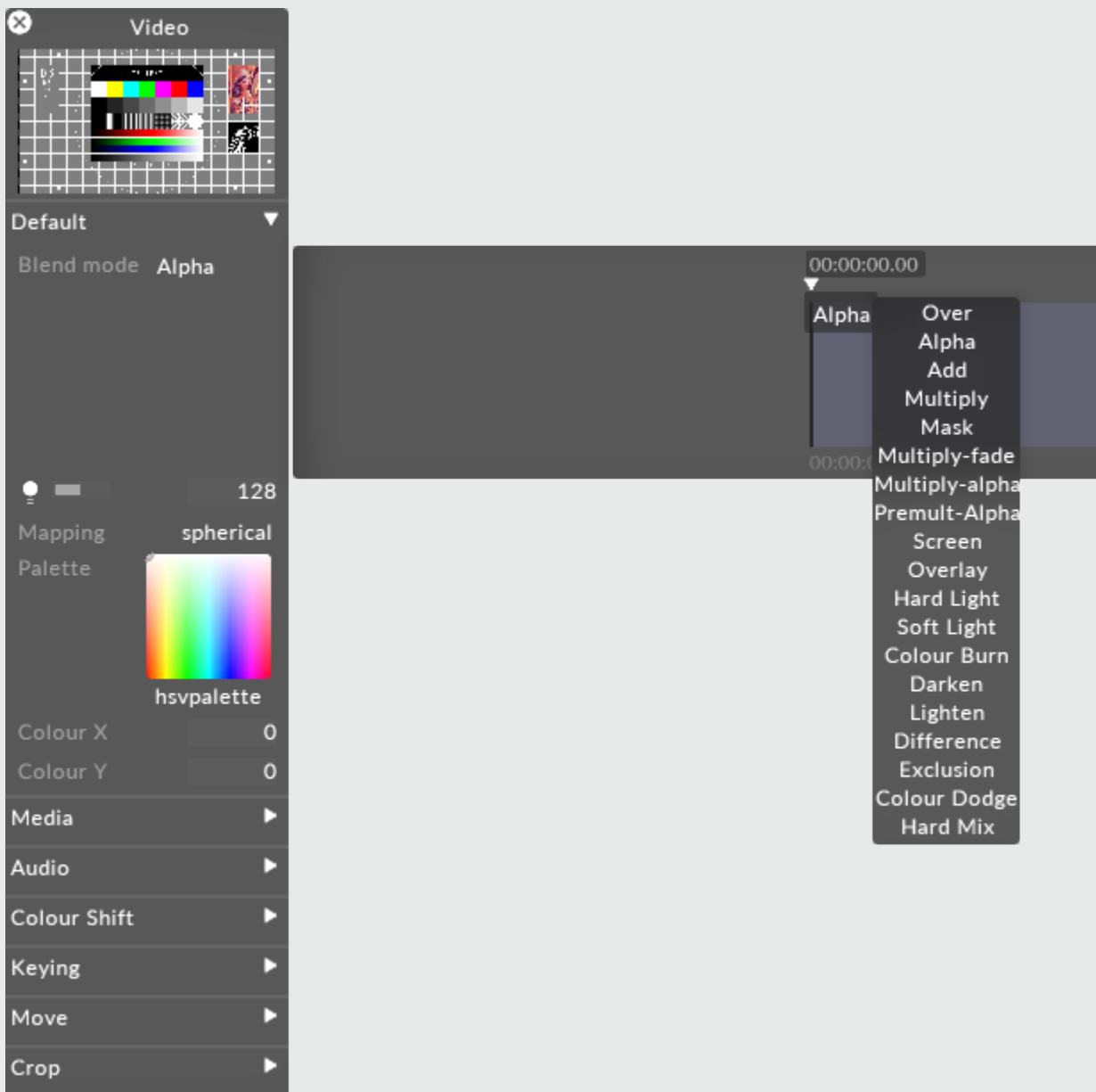

Changing brightness of a content layer in Disguise software is actually controlling the value of the alpha of the layer. Even when displaying a HAP video, the software will composite the layer with a controllable layer of alpha - one per layer.

There are two ways of expressing alpha in an image:

Straight alpha is an alpha channel which functions just like RGB. Alpha acts as a fourth channel of information per pixel which is as independent of the other three as R, G and B are of each other. For example, with straight alpha it is possible to have RGB = 255 (white) and alpha = 0 (fully transparent) on the same pixel. Internally generated content, such as gradient layer, are generated with straight alpha. This is the preferable style of alpha and considering the cleaner method of the two.

Premultiplied alpha takes the alpha and applies it to the values of the RGB channels per pixel. The more transparent something gets with premultiplied alpha, the closer it gets to black - as if the content is sitting on a black table. Premultiplied is the default output of Adobe Photoshop or AfterEffects. the result is our pixel at 255 RGB (full white) with 0 alpha would be calculated as a black pixel in the final image.

Here are explanations of what each individual blend mode will do.

## Over

Makes a layer fully opaque. Premultiplies all alpha onto the RGB value of each pixel. Alpha = black, so adjusting the brightness of a layer in Over blend mode makes it darker.

## Alpha

Default blend mode. It will apply alpha values as a transparency if the alpha is present. Brightness changes will make the layer more or less transparent.

## Add

Adds the value of each RGB pixel together. Always creates a brighter result. Values clamp at 255.

## Multiply

Reads the level of each subpixel as a level between 0.0 and 1.0, and multiplies source with blend. The result is always a darker image overall. For example: white x grey = 0.5. White turns transparent, black takes precedence. Alpha is applied in the same fashion as the Over Blend mode.

## Mask

Choose mask when you want to multiple out content upwards in the stack of layers, rather than downwards. In order to make this work you have to use the same mapping on the layer set to mask and the layer on top.

## Multiply-Fade

The same as Multiply, but will make use of the alpha channel to calculate transparency in the source and blend layers. Since maximum transparency is premultiplied, alpha results in black. This will ignore black created through premultiplying.

## Multiply-Alpha

Multiply with straight alpha. This mode assumes that the alpha has not been premultiplied onto the RGB values and will not apply a correction to the semi-transparent pixels.

## Premultiply Alpha

Like how Multiply-fade will ignore the darkening caused by premultiplying, this blend mode will do the same with Alpha.

## Colour Burn

Blend mode increases the contrast to darken the base colour while reflecting the blend colour. The darker the blend colour, the more intensely the colour will be applied in the base image. White as the blend colour produces no change. Using the colour burn blend mode can produce some harsh results at full opacity.

The colour burn blend mode can be used to make tonal and colour adjustments to a layer.

## Screen

This blend mode looks at each channels colour information and multiplies the inverse of the blend and base colour. The result is always a lighter colour. Screening with black leaves the colour unchanged. Screening with white produces white. The effect is similar to projecting multiple images on top of each other - where bright white is fully opaque, black is fully transparent and 50% grey is 50% transparent.

## Overlay

Multiplies or screens the colours, depending on the base colour. Patterns or colours overlay the existing pixels while preserving the highlights and shadows of the base colour. The base colour is not replaced, but mixed with the blend colour to reflect the lightness or darkness of the original colour.

## Hard Light

Multiplies or screens the colours, depending on the blend colour. The effects is similar to shining a harsh spotlight on the image. If the blend colour (light source/top layer) is lighter than 50% grey, the image is lightened as if it were screened. This is useful for adding highlights to an image. If the blend colour is darker than 50% grey, the image is darkened as if it were multiplied. This is useful for adding shadows to an image. Painting with pure black or white results in pure black or white.

## Soft Light

Darkens or lightens the colours, depending on the blend colour. The effect is similar to shining a diffused spotlight on the image. If the blend colour (light source/top layer) is lighter than 50% grey, the image is lightened as if it were dodged. If the blend colour is darker than 50% grey, the image is darkened as if it were burned in. Painting with pure black or white produces a distinctly darker or lighter area, but does not result in pure black or white.

## Darken

Looks at the colour information in each channel and selects the base or blend colour - whichever is darker - as the result colour. Pixels lighter than the blend colour are replaced and pixels darker than the blend colour do not change.

## Lighten

Looks at the colour information in each channel and selects the base or blend colour - whichever is lighter - as the result colour. Pixels darker than the blend colour are replaced and pixels lighter than the blend colour do not change.

## Difference

Looks at the colour information in each channel and subtracts either the blend colour from the base colour or the base colour from the blend colour depending on which has the greater brightness value. Blending with white inverts the base colour values and blending with black produces no change.

## Exclusion

Creates an effects similar to but lower in contrast than the difference mode. Blending with white inverts the base colour values. Blending with black produces no change.

## Colour Dodge

Looks at the colour information in each channel and brightens the base colour to reflect the blend colour by decreasing contrast between the two. Blending with black produces no change.

## Hard Mix

Adds the RGB channels of the blend colour to the RGB values of the base colour. If the resulting sum for a channel is 255 or greater, it receives a value of 255; if it is less than 255 it receives a value of 0. Therefore all blended pixels have RGB channels of either 0 or 255. This changes all pixels to primary additive colours (RGB), white or black.



# Colour Shift

The colour shift property allows you to perform a number of colour-correction operations on the output of a layer.

Colour Shift objects can also be attached to individual video files within the Video layer.

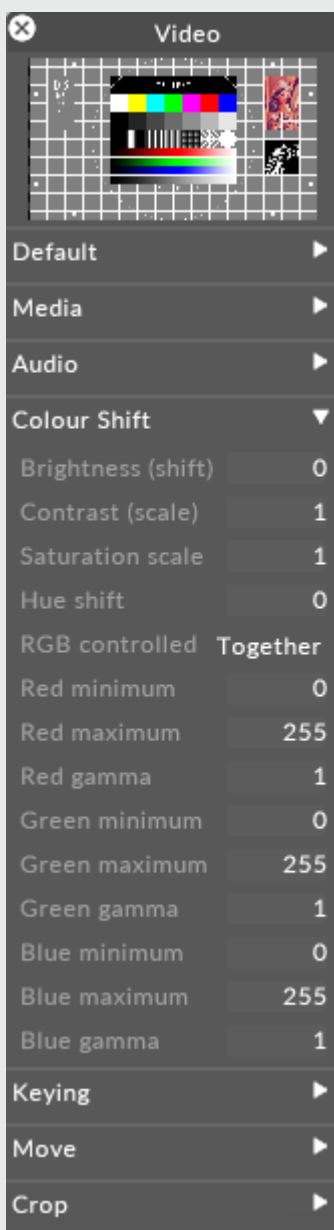

Colour Shift property performs colour-corrections on the output of a visual layer

Colour Shift properties are:

---

# Saturation scale

When set to 1, no change is applied to the image. When set to 0, the image is desaturated to black and white. When set higher than 1, the image is hypersaturated.

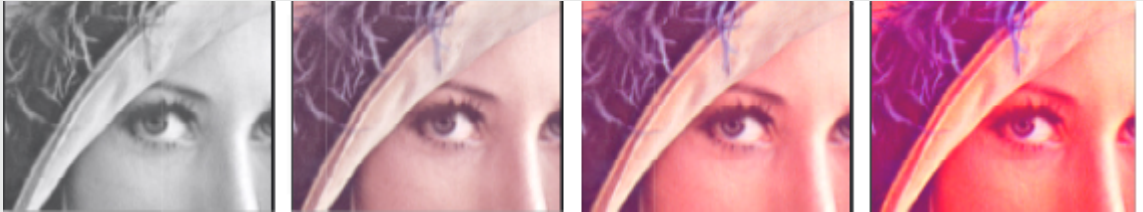

Saturation scale (from left to right):  $s=0$ ,  $s=0.5$ ,  $s=1$ ,  $s=2$

# Hue shift

## RGB controlled

This property controls how the min/max levels and gamma corrections are applied. If set to *together*, then the min, max and gamma values are the same for the red, green and blue channels. If set to *separate*, the min,max and gamma values can be controlled separately for red, green and blue. The latter setting allows you to apply fine colour balance controls to the image.

## Min

This sets the lowest brightness level found in the image. All pixels at this level are scaled down to zero brightness. Increasing this value enforces shadows and dark levels in the image and can be used to reduce low-level compression artifacts in an image or video frame.

Increasing *min* equally across red, green and blue enforces shadows, whereas increasing *min* on an individual channel has the effect of shifting the colour balance away from that colour. For example, increasing *red min* shifts the image towards cyan.

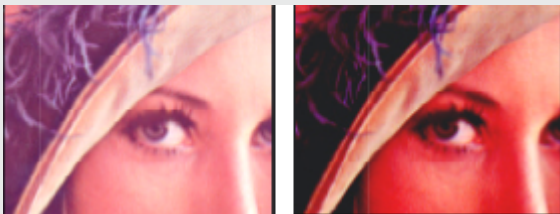

min = 00 (left), min = 96 (right)

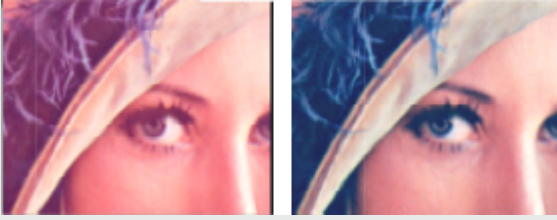

red.min = 0 (left), red.min = 96 (right)

## Max

This sets the highest brightness level found in the image. All pixels at this level are scaled up to the maximum level, i.e. 255. Decreasing this value brightens any highlights in the image. This is useful when the source image is too dark.

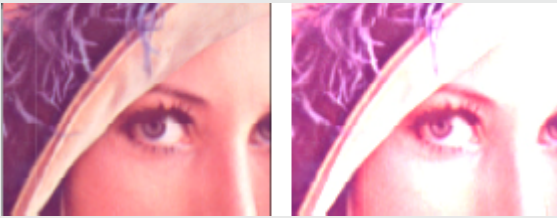

max = 255 (left), max = 260 (right)

If you set min to 255 and max to 0, the image (or single channel) will be inverted.

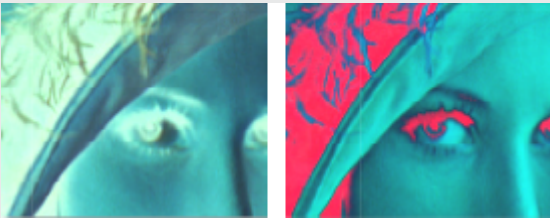

Invert all (left), invert red (right)

## Gamma

When *gamma* is set to 1, no change is made to the image. Reducing gamma brightens highlights while increasing gamma darkens lowlights. The maximum and minimum brightness levels remain the same.

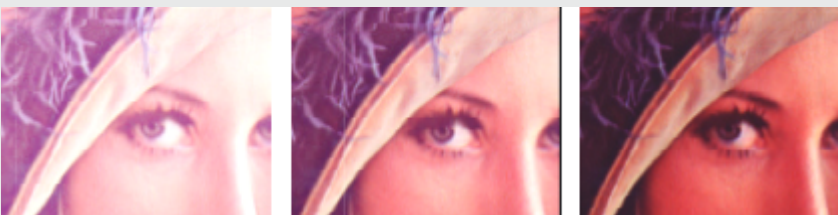

Gamma scale (from left to right):  $g=0.5$ ,  $g=1$ ,  $g=1.5$

# Palette

This points to the still image file that defines the bitmap from which the tint colour is taken. The default palette ( HSVPAL ) consists of the complete range of hues and saturations. Selecting this property will open the Texture object library, which shows all of the still image files saved on your local hard-drive in the **DxTexture** folder.

To control the location within the current palette bitmap, and thus control the colour, you have to edit the **xCol** and **yCol** values (see the section for xCol, yCol).

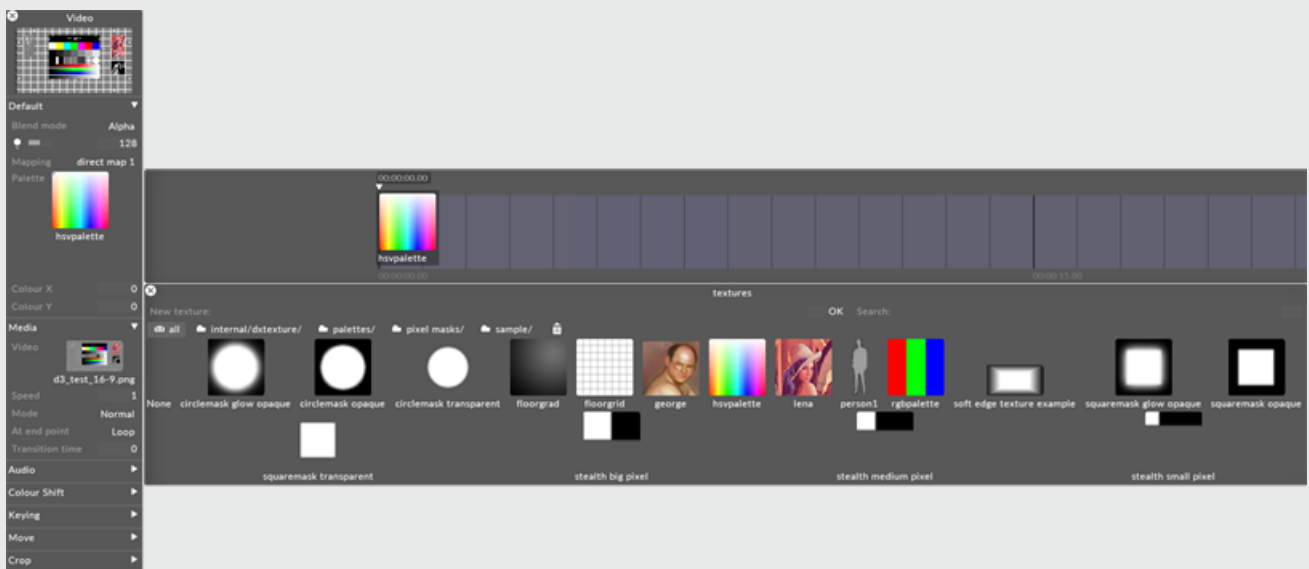

To change the current palette bitmap:

1. Left-click **palette** to open the Texture object library.
2. Left-click the still image file you want to use for the palette bitmap.

If you want to use a palette bitmap other than the standard still images provided in Disguise software, you will need to use a custom still image file.

See the [Placing media files for a project](#) sub-chapter to understand where to place a custom still image file and how to access it in Disguise software. Also save the file to a [supported file format](#).

# xCol yCol

These properties control the coordinates within the current palette bitmap where the output colour is sampled from. The default value is 0,0 which points at the color white (if you are using the HSVPAL palette). Multiplying white with the colors of the chosen content simply generates the original content colors. **Colour X** controls the horizontal position, where 0 is the leftmost edge and 255 is the rightmost edge. **Colour Y** controls the vertical position, where 0 is the top edge and 255 is the bottom edge.

For example, to saturate the video clip red, change the **Colour Y** value to 255 and use 0 for the **Colour X** value. These coordinates refer to the color red in the palette which is being multiplied with the colors of the existing content.

When you are using the default palette HSVPAL , **Colour Y** controls saturation, and **Colour X** controls hue.

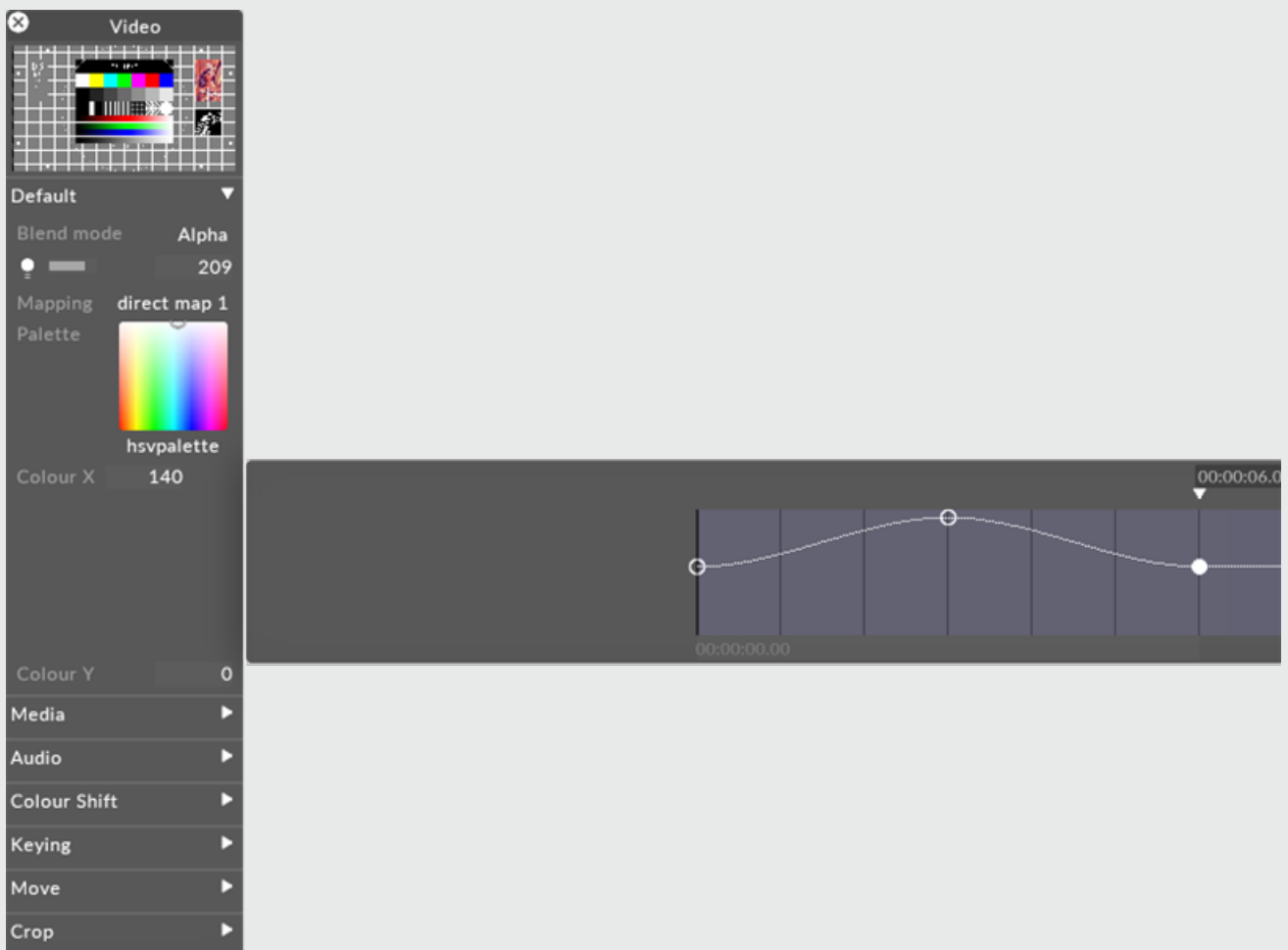

# Controlling layers with Art-Net

This sub-chapter explains how to use expressions to control layer properties with Art-Net.

## How to control layer properties with Art-Net

1. Open the layers editor. Please see the chapter [Working with Layers](#) for information on creating and editing layers.
2. Right-click the layer property you want to make Art-Net controllable. This will open a small editor.
3. Type the Art-Net expression into the **Expression** text field according to the format:

```
dmx:universe.channel
```

For example,

```
dmx:7.19
```

When the expression has been accepted the layer property will turn green.

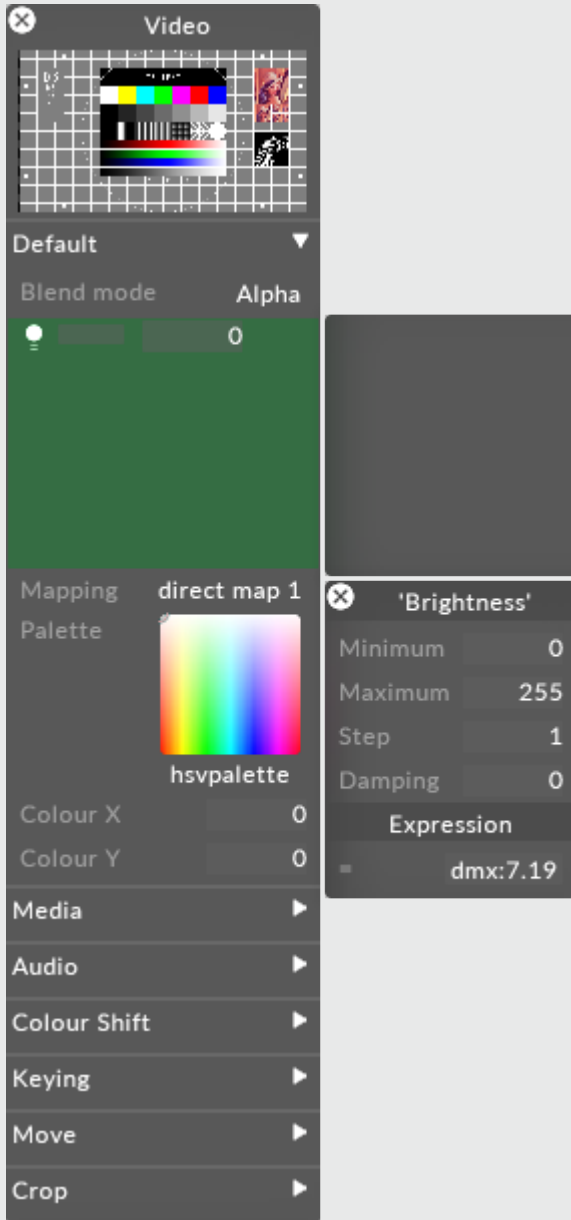

Art-Net expression (dmx:universe.channel) is used to make a layer property, in this example Brightness, Art-Net controllable

This expression assumes each property to work within the 0-255 range. This is good for properties in Disguise software such as **brightness** and **red min** but for other properties such as **saturation** in a Video layer, the range should only be from 0-1 (you can set the saturation to more than 1 but it is not recommended).

## How to enable the layer property to work only between the range 0-1

1. Set the **min** property to 0 and the **max** property to 1.
2. Type the following Art-Net expression into the **untitled Expression** text field:

```
(dmx:7.19/255) * (max-min) + min
```

This expression will automatically take the min and max values into account and will be fully controllable from the lighting desk with incoming DMX values between 0-255.

3. Set the default start value for the parameter in the lighting desk.



# Controlling layers with OSC

To control a numerical OSC parameter in a layer, create an expression:

- Right-click a parameter and type in the following syntax:

```
osc:.d3.parameterName
```

## Tips for Setting up OSC

**Base Address:** check the base address in Disguise software matches the OSC path from the OSC sender/application.

Tip 1: The base address syntax within Disguise software omits the layer name but this should be included in the OSC path from the OSC sender/application.

Syntax : /d3/layer/[layer\_name]/[layer\_property], e.g. /d3/layer/show\_intro/video

Companion: configure a 'GenericOscSender' and 'Send String'.

Tip 2: The base address in disguise defaults to the original layer name. After patching the layer, the layer can be renamed.

## Example

For example, if you wish to control the brightness of a video layer type in:

```
osc:.d3.brightness
```

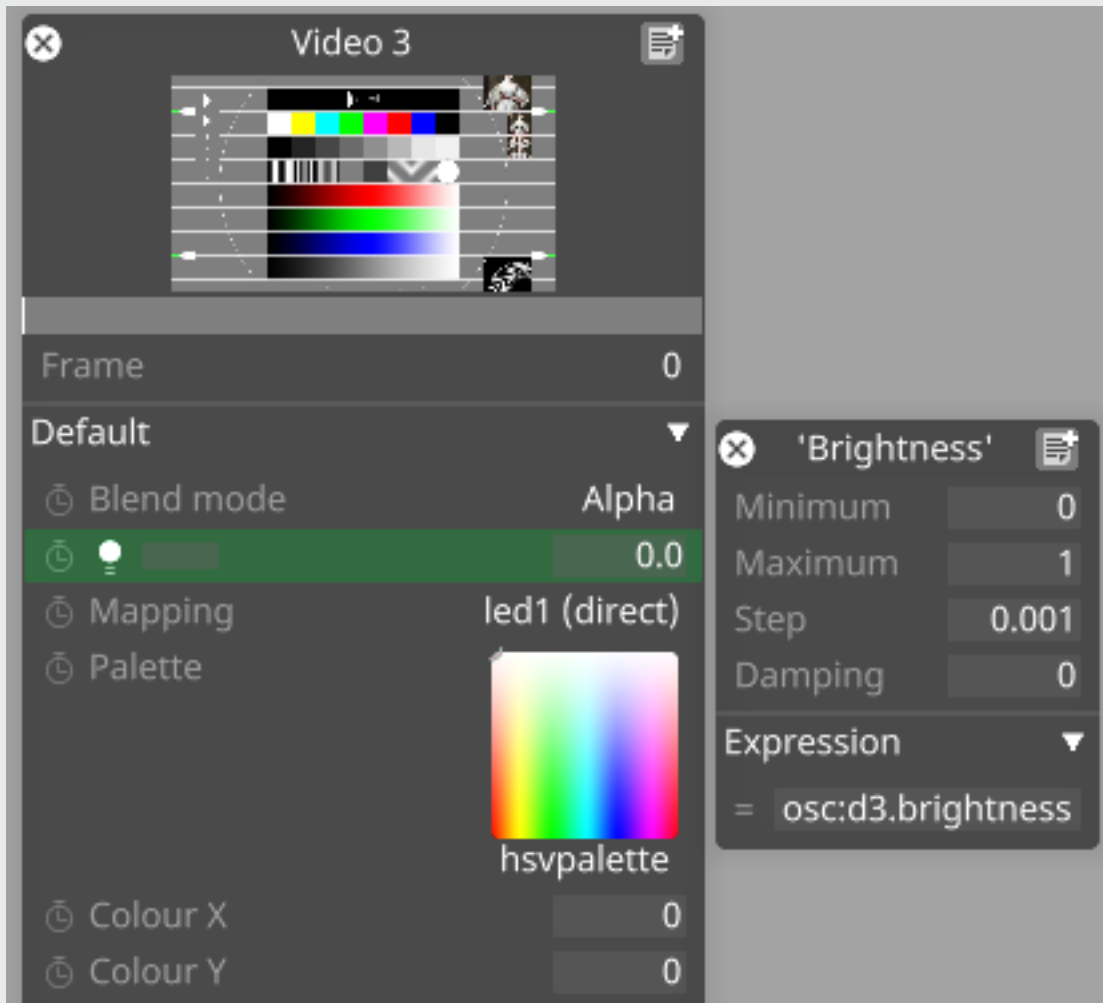

The corresponding syntax for the brightness slider in TouchOSC is:

`/d3/showcontrol/brightness`

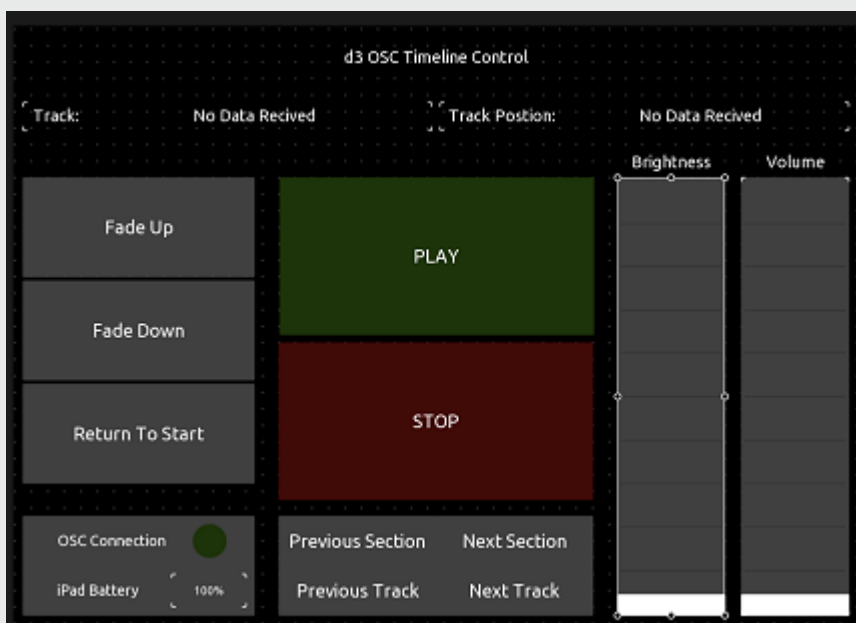

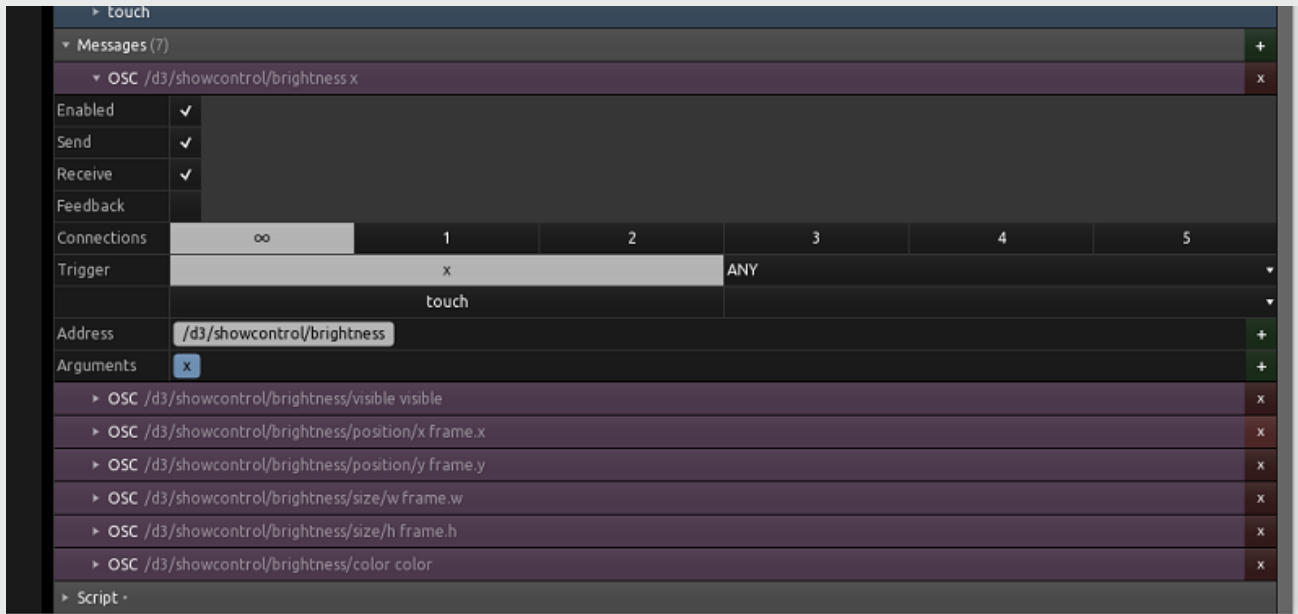

To enable OSC control, first make sure to set up the OSC input in Disguise software as described in the [OSC Devices](#) sub-chapter.

# Layer Types Overview

There are five main layer types in Disguise software: content layers, generative layers, pre-visualisation layers, effects layers and control layers.

## Types of layers

### Content layers

The function of **content layers** is to play back pre-rendered content, map them onto screens and, if needed, apply a number of effects built into the layer.

[Audio](#)

[RenderStream](#)

[TestPattern](#)

[Video](#)

[VideoTrigger](#)

[VirtualLineup](#)

[Web](#)

### Generative layers

**Generative layers** are packets of algorithms inside Disguise software that produce visuals based on a number of animatable properties. They share some of the same properties as all the other layer types such as the Mapping property.

[Bugs](#)

[Chevron](#)

[Colour](#)

[Gradient](#)

[Notch](#)

[RGBColour](#)

[Radar](#)

[Readout](#)

[Scan](#)

[Strobe](#)

[Tennis](#)

[TestPattern](#)

[Text](#)

[TrackingModule](#)

## Pre-visualisation layers

**Pre-visualisation layers** are usually used during the design and pre-production phases of the project when accurate visualisation is required, for example animating screens or creating camera fly-throughs.

[AnimateCameraControl](#)

[AnimateObjectPreset](#)

[AnimateObjectPreset](#)

[TargetControl](#)

[TargetPreset](#)

# Effects layers

Input a bitmap, a video or an output from another content layer into Disguise software **effects layers**. For example spin, pixelate, blur images, video, or other inputs to create a new look.

[Blur](#)

[ChannelRouter](#)

[ColourAdjust](#)

[Compose](#)

[EdgeFilter](#)

[Fade](#)

[FilmicGrain](#)

[Kaleidoscope](#)

[Lut](#)

[MotionBlur](#)

[Noise](#)

[PixelMap](#)

[Pixelate](#)

[Scroll](#)

[SpinBitmap](#)

[Trigger](#)

[VideoTransition](#)

# Control layers

**Control layers** are technical layers that control other equipment in the show; for example DVI matrices, switchers or unusual DMX controlled equipment.

[CameraControl](#)

[Control](#)

[MatrixControl](#)

[DMXLightsControl](#)

[DMXShare](#)

[TimecodeMode](#)

[MasterBrightness](#)

[MTC](#)

[MDC](#)

[MidiNote](#)

[Open](#)

[OscControl](#)

[PlayMode](#)

[ProjectorControl](#)

[TargetObject](#)

[TrackJump](#)

[TransportControl](#)

[TransportBrightnessLocal](#)

[TransportVolumeLocal](#)

## Legacy layers

Legacy layers are kept in the software for compatability purposes but have been replaced with more up to date layers.

[Bitmap](#)

[Legacy video](#)

# Working with layers

It is highly recommended that the previous chapter [Working with layers](#) is read before reading this chapter. This is because creating/structuring/editing layers involves many processes, for example placing key-frames on the Key-frame editor, which are all explained in the previous chapter.



# Audio

The Audio layer allows you to play audio files from disguise, without the need for embedding those files into a video file first.

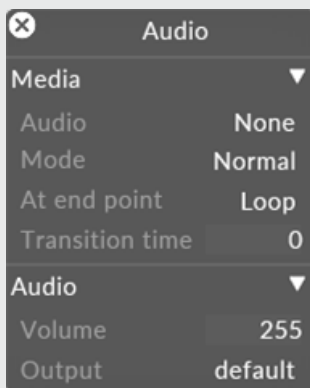

## Workflow

1. Add the audio files to the audiofile folder in the disguise project folder.
2. Add an audio layer to the timeline.
3. Assign the layer an audio patch (assuming a logical audio out has already been configured).

## Media

## Audio

Opens the audio file list

## Mode

### **Normal**

When the play head stops, the audio will also stop and the frame number will lock to the timeline position. When the play head continues to play or holds at the end of a section, the audio will play continuously. Jumping around the timeline while playing does not affect which part of the audio is being played.

### **Locked**

If the play cursor continues to play or stops at the end of a section, the audio locks to the timeline and thus stops playing.

## At End Point

### **Loop**

When playback reaches the end of the video clip, the clip will loop immediately back to the beginning and will start playing again from there.

### **Ping-pong**

When playback reaches the end of the video clip, the clip will play in reverse back to the beginning.

### **Pause**

When playback reaches the end of the video clip, the clip will pause on the last frame.

## Transition Time

The transition property specifies the dissolve time, in seconds, when switching from one audio clip to the next on the timeline. By default, this is set to 0, so the player cuts immediately from one clip to the

next. Setting this value to 1 causes the player to dissolve from one clip to the next over 1 second.

# Audio

## **Volume**

You can specify any number between 0 (mute) and 255 (full) in the text field to set a constant volume, or open the properties key-frame editor to fade volume in or out.

## **Balance**

You can balance the playback of a file to either right or left by altering the value of the parameter.

## **Output**

This controls which audio output device the audio is played to.

# Bitmap

Using the Bitmap layer is the easiest way to display still images. The Bitmap layer takes over certain properties from the [Colour layer](#) and the [Videolayer](#). To see where to place media files in Windows see the [Placing media files for a project](#) page. To see what video file formats Disguise software support see the [Supported file formats](#) page.

Please note: In release r13 onwards it is recommended to use a video layer for still images. For more information see the [Placing media files for a project](#) page.

The Bitmap layer supports the use of Arrows, allowing content layers to be piped into the Bitmap layer. For more information please see the sub-chapter [Composing layers using Arrows](#).

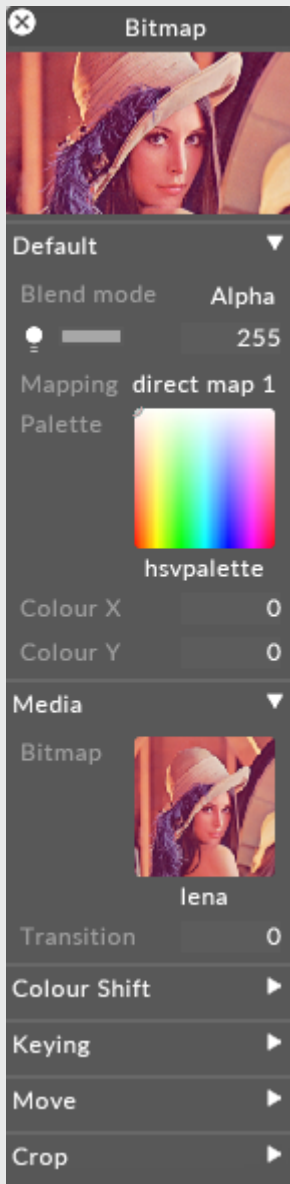

## Preview Thumbnail

This property is a small preview window at the top of the editor showing you what the layer output looks like.

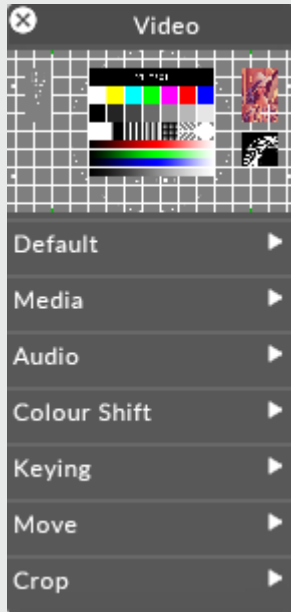

## Blend Mode

BlendMode controls how the output of the layer is composited with the layers below. Layers are rendered in a bottom-up order: layers at the top can modify the output of the layers below.

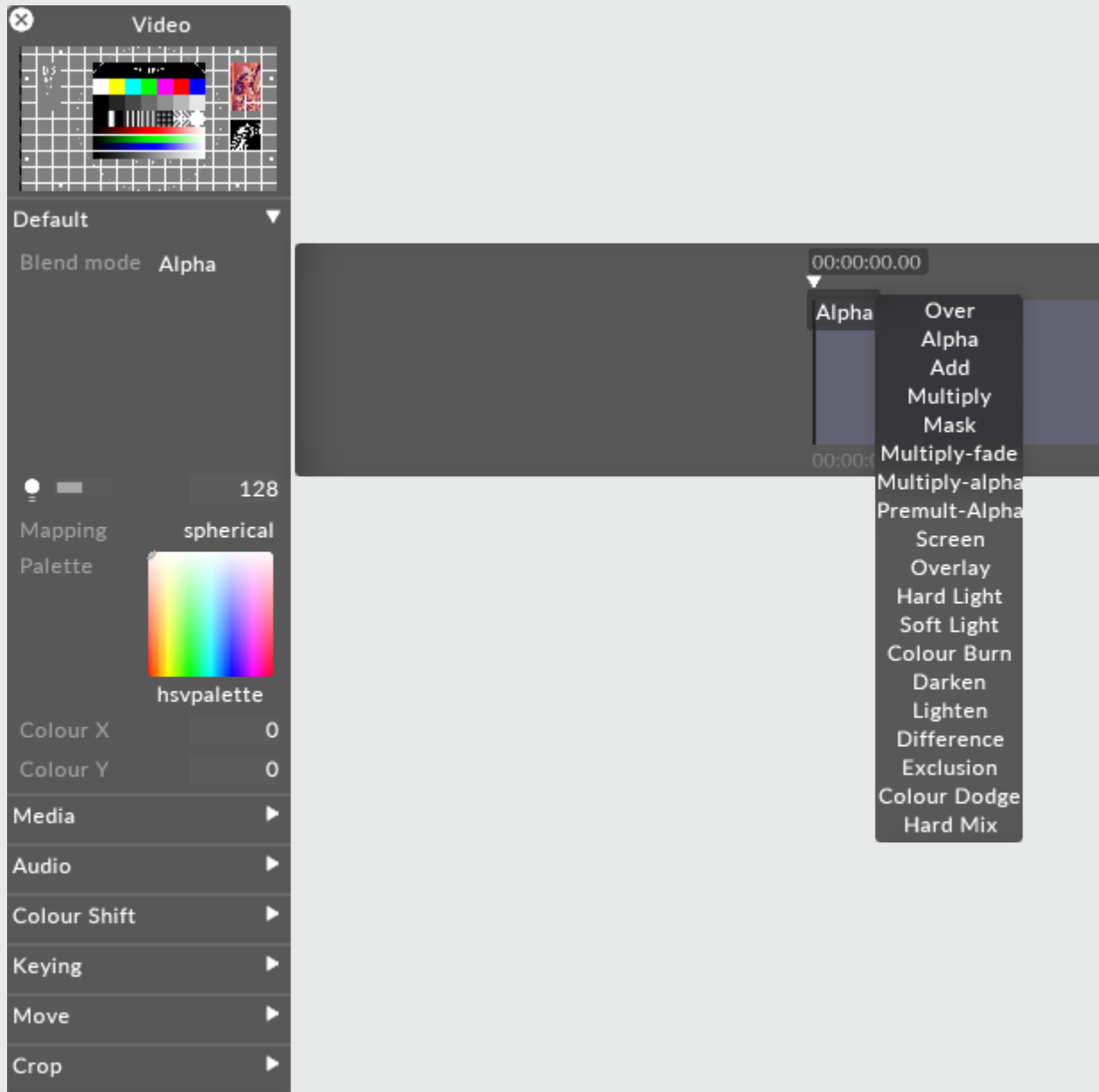

Changing brightness of a content layer in Disguise software is actually controlling the value of the alpha of the layer. Even when displaying a HAP video, the software will composite the layer with a controllable layer of alpha - one per layer.

There are two ways of expressing alpha in an image:

Straight alpha is an alpha channel which functions just like RGB. Alpha acts as a fourth channel of information per pixel which is as independent of the other three as R, G and B are of each other. For example, with straight alpha it is possible to have RGB = 255 (white) and alpha = 0 (fully transparent) on the same pixel. Internally generated content, such as gradient layer, are generated with straight alpha. This is the preferable style of alpha and considering the cleaner method of the two.

Premultiplied alpha takes the alpha and applies it to the values of the RGB channels per pixel. The more transparent something gets with premultiplied alpha, the closer it gets to black - as if the content is sitting on a black table. Premultiplied is the default output of Adobe Photoshop or AfterEffects. the result is our pixel at 255 RGB (full white) with 0 alpha would be calculated as a black pixel in the final image.

Here are explanations of what each individual blend mode will do.

## Over

Makes a layer fully opaque. Premultiplies all alpha onto the RGB value of each pixel. Alpha = black, so adjusting the brightness of a layer in Over blend mode makes it darker.

## Alpha

Default blend mode. It will apply alpha values as a transparency if the alpha is present. Brightness changes will make the layer more or less transparent.

## Add

Adds the value of each RGB pixel together. Always creates a brighter result. Values clamp at 255.

## Multiply

Reads the level of each subpixel as a level between 0.0 and 1.0, and multiplies source with blend. The result is always a darker image overall. For example: white x grey = 0.5. White turns transparent, black takes precedence. Alpha is applied in the same fashion as the Over Blend mode.



## Mask

Choose mask when you want to multiple out content upwards in the stack of layers, rather than downwards. In order to make this work you have to use the same mapping on the layer set to mask and the layer on top.

## Multiply-Fade

The same as Multiply, but will make use of the alpha channel to calculate transparency in the source and blend layers. Since maximum transparency is premultiplied, alpha results in black. This will ignore black created through premultiplying.

## Multiply-Alpha

Multiply with straight alpha. This mode assumes that the alpha has not been premultiplied onto the RGB values and will not apply a correction to the semi-transparent pixels.

## Premultiply Alpha

Like how Multiply-fade will ignore the darkening caused by premultiplying, this blend mode will do the same with Alpha.

## Colour Burn

Blend mode increases the contrast to darken the base colour while reflecting the blend colour. The darker the blend colour, the more intensely the colour will be applied in the base image. White as the blend colour produces no change. Using the colour burn blend mode can produce some harsh results at full opacity.

The colour burn blend mode can be used to make tonal and colour adjustments to a layer.

## Screen

This blend mode looks at each channels colour information and multiplies the inverse of the blend and base colour. The result is always a lighter colour. Screening with black leaves the colour unchanged. Screening with white produces white. The effect is similar to projecting multiple images on top of each other - where bright white is fully opaque, black is fully transparent and 50% grey is 50% transparent.

## Overlay

Multiplies or screens the colours, depending on the base colour. Patterns or colours overlay the existing pixels while preserving the highlights and shadows of the base colour. The base colour is not replaced, but mixed with the blend colour to reflect the lightness or darkness of the original colour.

## Hard Light

Multiplies or screens the colours, depending on the blend colour. The effect is similar to shining a harsh spotlight on the image. If the blend colour (light source/top layer) is lighter than 50% grey, the image is lightened as if it were screened. This is useful for adding highlights to an image. If the blend colour is darker than 50% grey, the image is darkened as if it were multiplied. This is useful for adding shadows to an image. Painting with pure black or white results in pure black or white.

## Soft Light

Darkens or lightens the colours, depending on the blend colour. The effect is similar to shining a diffused spotlight on the image. If the blend colour (light source/top layer) is lighter than 50% grey, the image is lightened as if it were dodged. If the blend colour is darker than 50% grey, the image is darkened as if it were burned in. Painting with pure black or white produces a distinctly darker or lighter area, but does not result in pure black or white.

## Darken

Looks at the colour information in each channel and selects the base or blend colour - whichever is darker - as the result colour. Pixels lighter than the blend colour are replaced and pixels darker than the blend colour do not change.

## Lighten

Looks at the colour information in each channel and selects the base or blend colour - whichever is lighter - as the result colour. Pixels darker than the blend colour are replaced and pixels lighter than the blend colour do not change.

## Difference

Looks at the colour information in each channel and subtracts either the blend colour from the base colour or the base colour from the blend colour depending on which has the greater brightness value.

Blending with white inverts the base colour values and blending with black produces no change.

## Exclusion

Creates an effects similar to but lower in contrast than the difference mode. Blending with white inverts the base colour values. Blending with black produces no change.

## Colour Dodge

Looks at the colour information in each channel and brightens the base colour to reflect the blend colour by decreasing contrast between the two. Blending with black produces no change.

## Hard Mix

Adds the RGB channels of the blend colour to the RGB values of the base colour. If the resulting sum for a channel is 255 or greater, it receives a value of 255; if it is less than 255 it receives a value of 0. Therefore all blended pixels have RGB channels of either 0 or 255. This changes all pixels to primary additive colours (RGB), white or black.

## Brightness

This property (which appears as a light bulb icon) controls the brightness of the layer output.

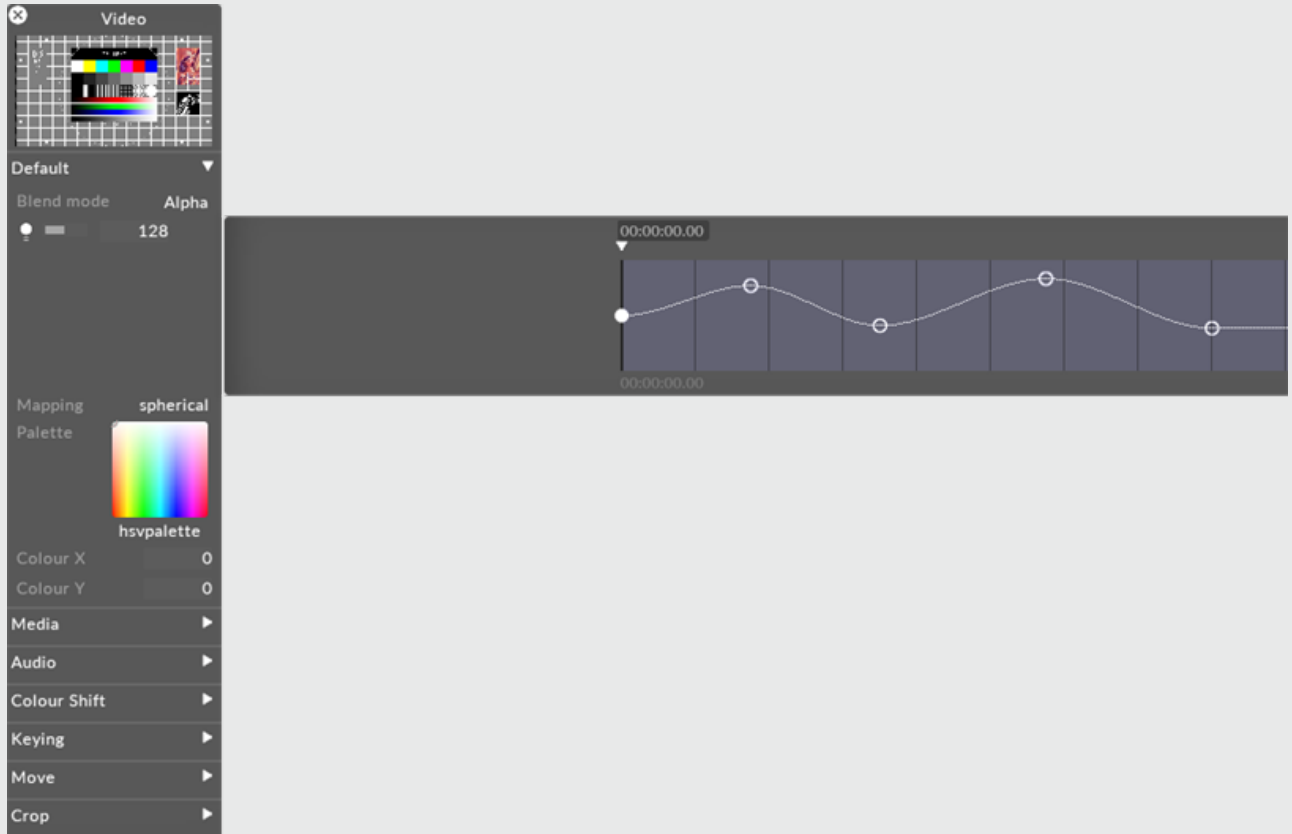

If the layers blend mode is set to Alpha, then reducing the brightness to 0 also reduces the opacity of the layer to 0. This can be useful when you want to dissolve from one layer to the next. In that case, you can place the new layer above the old layer and increase its brightness level.

## Mapping

The mapping property controls how the layer output is mapped onto the screen(s) in the Stage level.

**Video**

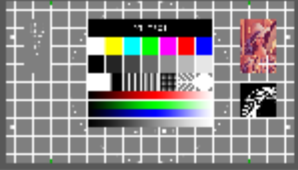

Default ▾

Blend mode Alpha

128

Mapping direct map 1

Palette



hsvpalette

Colour X 0

Colour Y 0

Media ▾

Video



d3\_test\_16-9.png

Speed 1

Mode Normal

At end point Loop

Transition time 0

Audio ▶

Colour Shift ▶

Keying ▶

Move ▶

Crop ▶

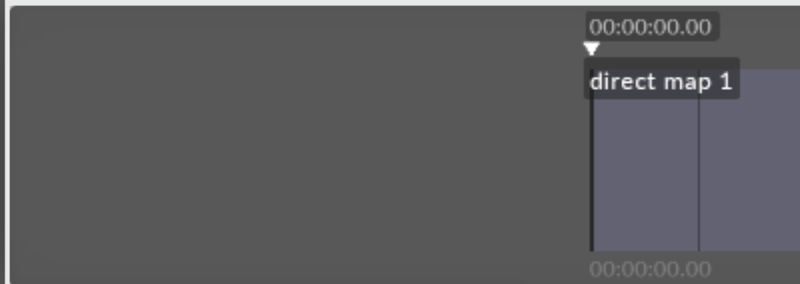

00:00:00.00

direct map 1

00:00:00.00

**mappings**

New mapping: OK Search:

all New Mappings

- direct map 1
- feed map 2
- feed mapping
- mapping 1
- mapping 2
- parallel
- spherical

For information on mapping, including how to use the different mapping types offered by Disguise software, please see the chapter [Content Mapping](#).

## Palette

This points to the still image file that defines the bitmap from which the tint colour is taken. The default palette ( HSVPAL ) consists of the complete range of hues and saturations. Selecting this property will open the Texture object library, which shows all of the still image files saved on your local hard-drive in the **DxTexture** folder.

To control the location within the current palette bitmap, and thus control the colour, you have to edit the **xCol** and **yCol** values (see the section for xCol, yCol).

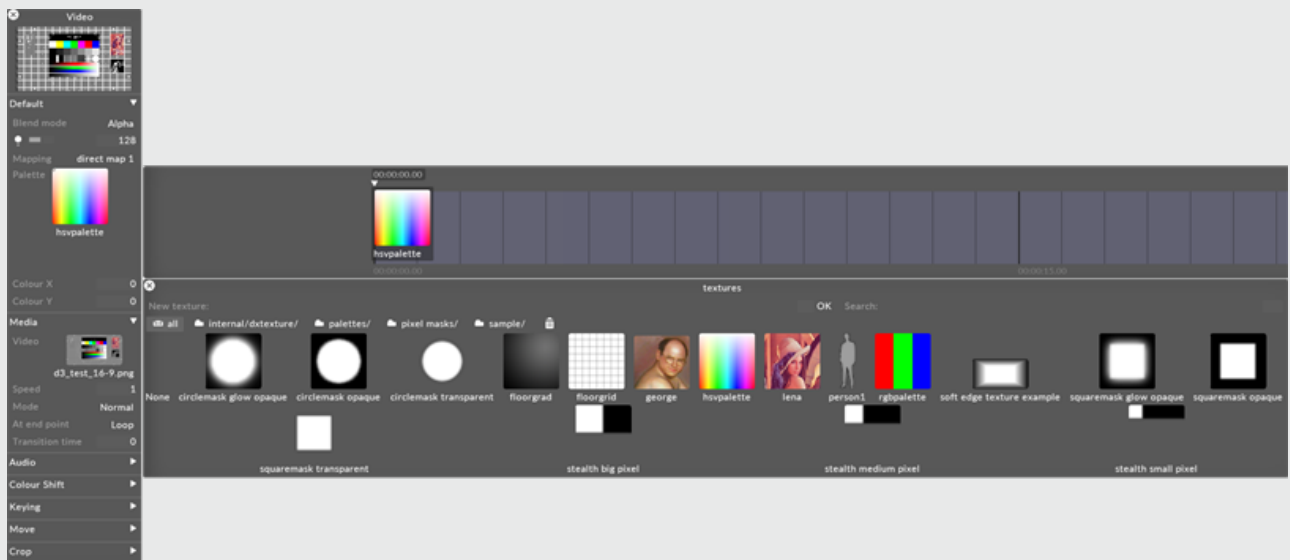

To change the current palette bitmap:

1. Left-click **palette** to open the Texture object library.
2. Left-click the still image file you want to use for the palette bitmap.

If you want to use a palette bitmap other than the standard still images provided in Disguise software, you will need to use a custom still image file.

See the [Placing media files for a project](#) sub-chapter to understand where to place a custom still image file and how to access it in Disguise software. Also save the file to a [supported file format](#).

## xCol, yCol

These properties control the coordinates within the current palette bitmap where the output colour is sampled from. The default value is 0,0 which points at the color white (if you are using the HSVPAL palette). Multiplying white with the colors of the chosen content simply generates the original content colors. **Colour X** controls the horizontal position, where 0 is the leftmost edge and 255 is the rightmost edge. **Colour Y** controls the vertical position, where 0 is the top edge and 255 is the bottom edge.

For example, to saturate the video clip red, change the **Colour Y** value to 255 and use 0 for the **Colour X** value. These coordinates refer to the color red in the palette which is being multiplied with the colors of the existing content.

When you are using the default palette HSVPAL , **Colour Y** controls saturation, and **Colour X** controls hue.

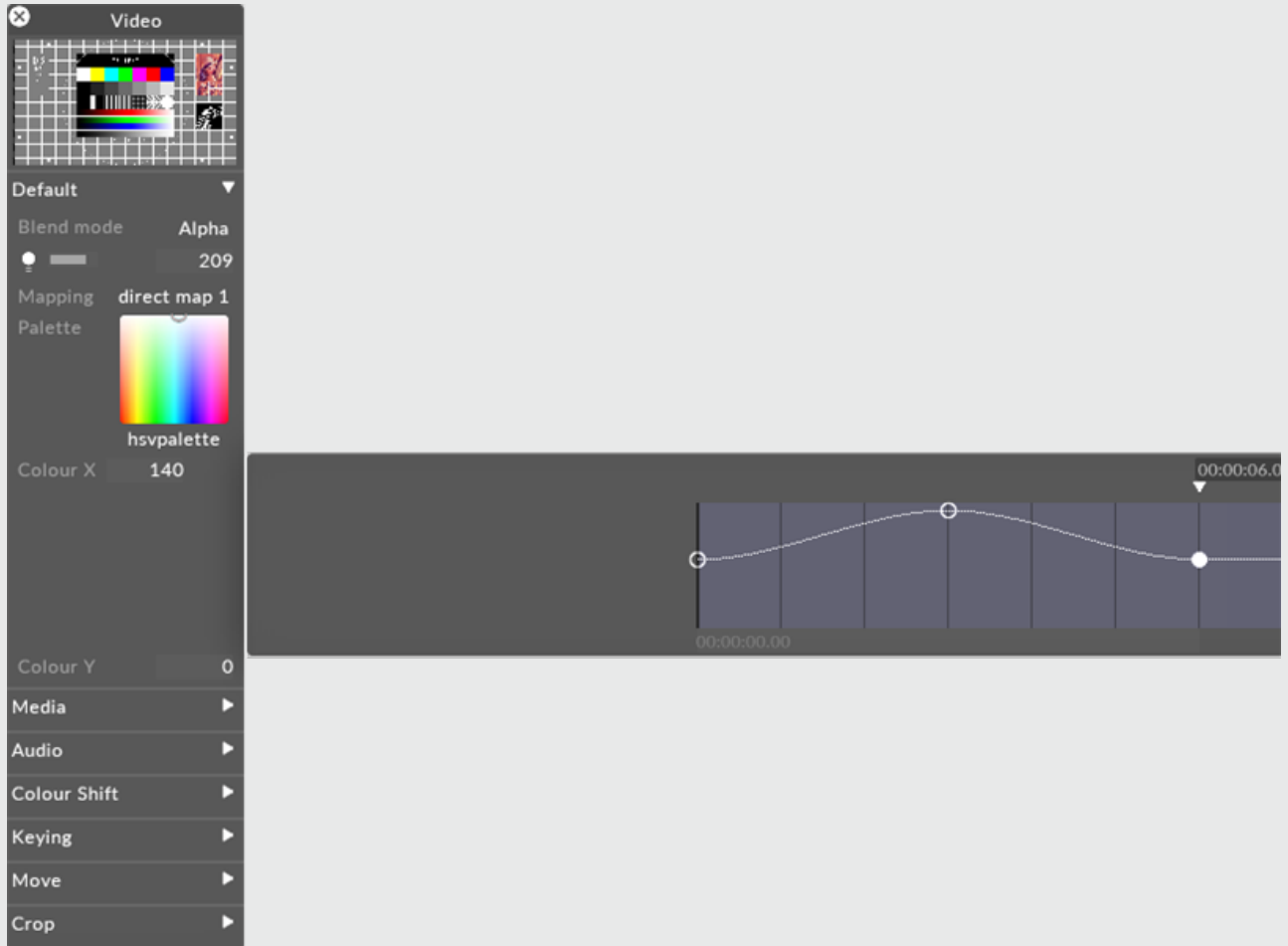

## Colour Shift

The colour shift property allows you to perform a number of colour-correction operations on the output of a layer.

Colour Shift objects can also be attached to individual video files within the Video layer.





Colour Shift property performs colour-corrections on the output of a visual layer

Colour Shift properties are:

# Saturation scale

When set to 1, no change is applied to the image. When set to 0, the image is desaturated to black and white. When set higher than 1, the image is hypersaturated.

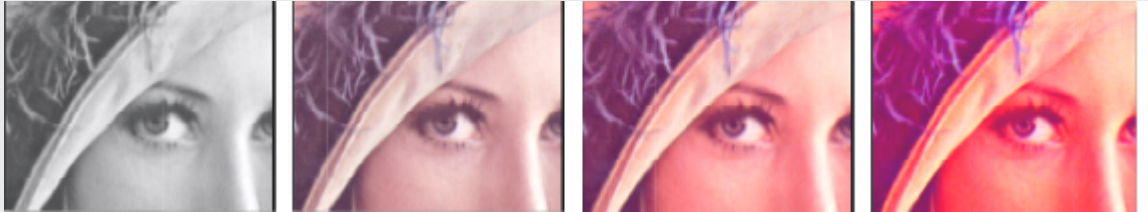

Saturation scale (from left to right):  $s=0$ ,  $s=0.5$ ,  $s=1$ ,  $s=2$

# Hue shift

## RGB controlled

This property controls how the min/max levels and gamma corrections are applied. If set to *together*, then the min, max and gamma values are the same for the red, green and blue channels. If set to *separate*, the min,max and gamma values can be controlled separately for red, green and blue. The latter setting allows you to apply fine colour balance controls to the image.

## Min

This sets the lowest brightness level found in the image. All pixels at this level are scaled down to zero brightness. Increasing this value enforces shadows and dark levels in the image and can be used to reduce low-level compression artifacts in an image or video frame.

Increasing *min* equally across red, green and blue enforces shadows, whereas increasing *min* on an individual channel has the effect of shifting the colour balance away from that colour. For example, increasing *red min* shifts the image towards cyan.

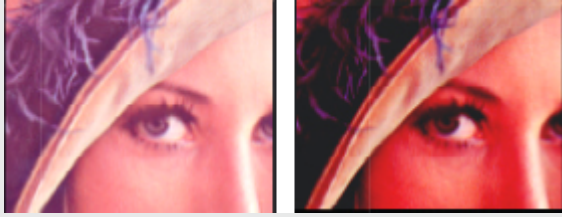

min = 00 (left), min = 96 (right)

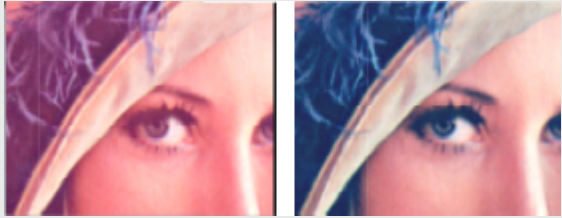

red.min = 0 (left), red.min = 96 (right)

## Max

This sets the highest brightness level found in the image. All pixels at this level are scaled up to the maximum level, i.e. 255. Decreasing this value brightens any highlights in the image. This is useful when the source image is too dark.

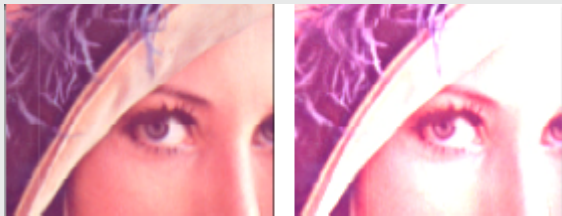

max = 255 (left), max = 260 (right)

If you set min to 255 and max to 0, the image (or single channel) will be inverted.

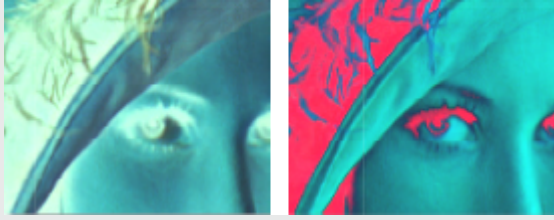

Invert all (left), invert red (right)

## Gamma

When *gamma* is set to 1, no change is made to the image. Reducing gamma brightens highlights while increasing gamma darkens lowlights. The maximum and minimum brightness levels remain the same.

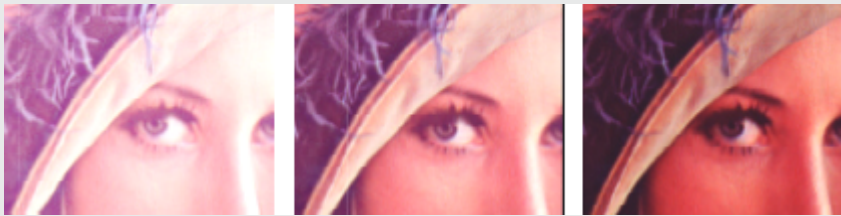

Gamma scale (from left to right):  $g=0.5$ ,  $g=1$ ,  $g=1.5$

## Transition

Determines the crossfade (in seconds) between two adjacent bitmaps placed in the keyframe editor of the Bitmap layer.

## Threshold

The threshold of the keying. Colours closer than (threshold) to the key colour become transparent.

## Hardness

The hardness of the keying. Lower numbers produce softer edges and higher numbers produce harder edges between transparent and opaque areas.

## Key colour rgb

The value of the key colour, 0 255, causing the key colour to become transparent.

## Scale mode

Provides mapping options to apply to content of a certain resolution which does not match the resolution of the targeted canvas.

## Scale

This controls the size of the image. When set to 1, the image is displayed at its normal size. Increasing the scale increases the size of the image; to display at double size, set **scale** to 2. To halve the image size, set **scale** to 0.5.

## Aspect

This controls the aspect ratio of the image. When set to 1, the image is displayed at a 1:1 aspect ratio. Increasing the **aspect** value increases the height of the image in relation to its width.

## Position

This controls the horizontal (x) and vertical (y) position of the image. When both are set to 0, the centre of the image is centered in the output canvas. Setting x to 1 moves the center to the left edge of the canvas; setting it to +1 moves the center to the right edge of the canvas. Setting y to 1 moves the center

to the top edge of the canvas; setting it to +1 moves the center to the bottom edge of the canvas.

## Rotation

This controls the rotation of the bitmap, in degrees.

## Crop

The **crop** pulldown tab contains a set of properties (**top** , **left**, **bottom** , **right**) that allow you to remove pixels from the edges of the bitmap. Each property specifies the number of pixels you want to remove from the corresponding edge. For example, setting top to 10 will clip 10 pixels off the top edge.

# TestPattern

The TestPattern layer allows users to generate basic test patterns within Disguise software.

## Workflow

- Create a new TestPattern layer
- Assign the layer to a mapping

**Please note:** The test-pattern layer is unique in that it fills the entire area of the surface it's mapped to, thus any mapping type applied to this layer will function as a direct map.

Define the circles & lines parameters to suit

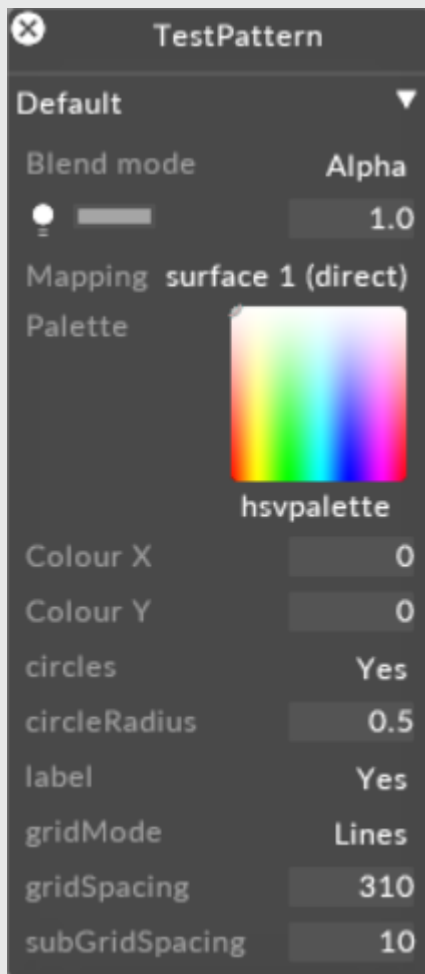

TestPattern common layer properties



# Preview Thumbnail

This property is a small preview window at the top of the editor showing you what the layer output looks like.

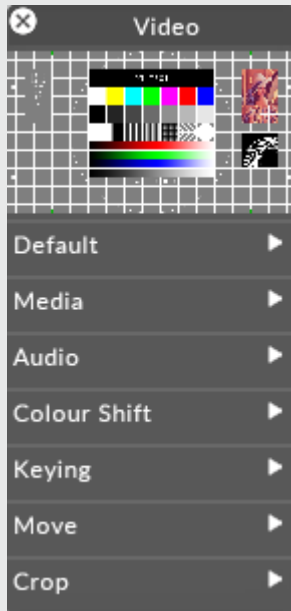

# Blend Mode

BlendMode controls how the output of the layer is composited with the layers below. Layers are rendered in a bottom-up order: layers at the top can modify the output of the layers below.

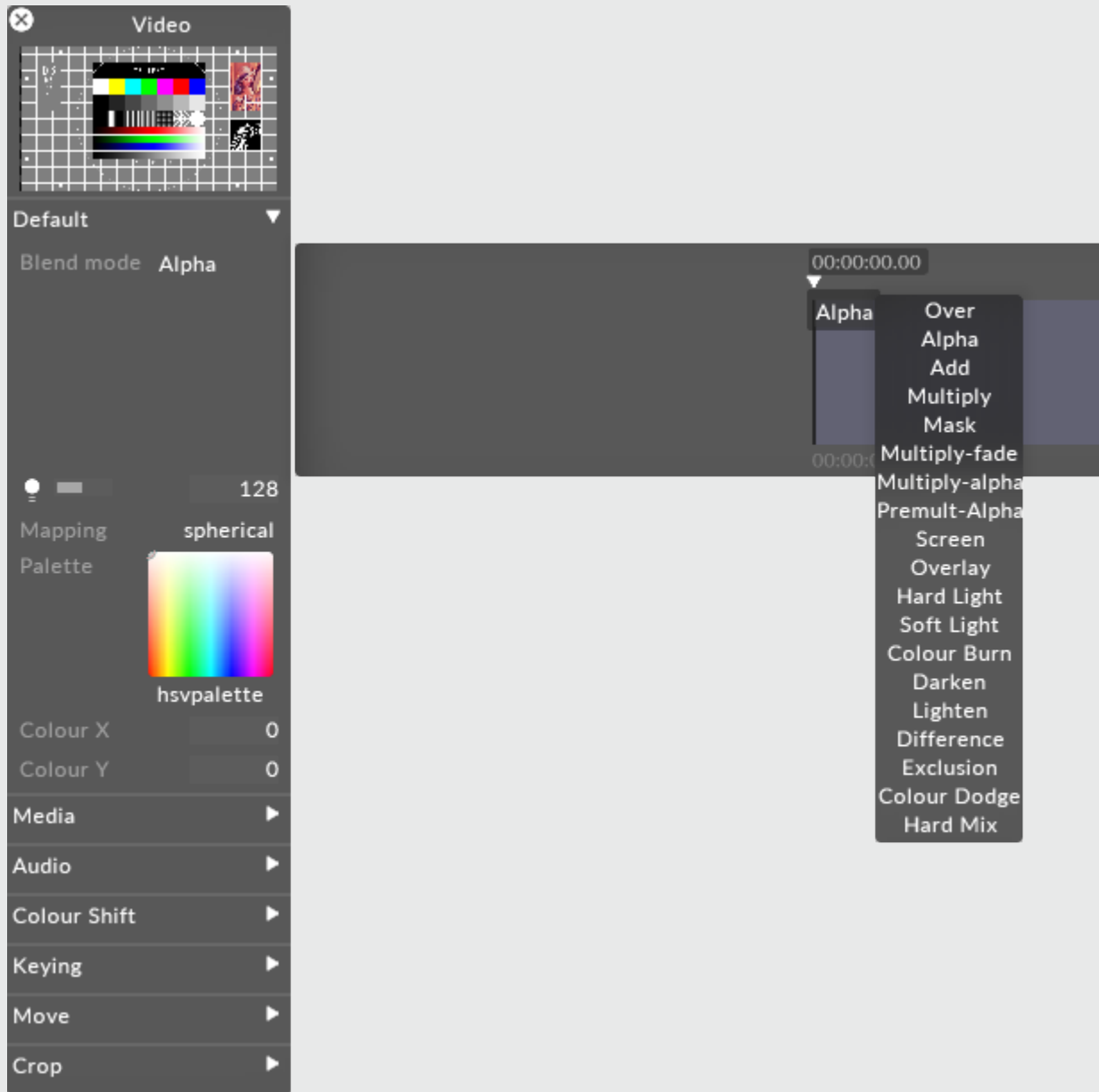

Changing brightness of a content layer in Disguise software is actually controlling the value of the alpha of the layer. Even when displaying a HAP video, the software will composite the layer with a controllable layer of alpha - one per layer.

There are two ways of expressing alpha in an image:

Straight alpha is an alpha channel which functions just like RGB. Alpha acts as a fourth channel of information per pixel which is as independent of the other three as R, G and B are of each other. For example, with straight alpha it is possible to have RGB = 255 (white) and alpha = 0 (fully transparent) on the same pixel. Internally generated content, such as gradient layer, are generated with straight alpha. This is the preferable style of alpha and considering the cleaner method of the two.

Premultiplied alpha takes the alpha and applies it to the values of the RGB channels per pixel. The more transparent something gets with premultiplied alpha, the closer it gets to black - as if the content is sitting on a black table. Premultiplied is the default output of Adobe Photoshop or AfterEffects. The result is our pixel at 255 RGB (full white) with 0 alpha would be calculated as a black pixel in the final image.

Here are explanations of what each individual blend mode will do.

## Over

Makes a layer fully opaque. Premultiplies all alpha onto the RGB value of each pixel. Alpha = black, so adjusting the brightness of a layer in Over blend mode makes it darker.

## Alpha

Default blend mode. It will apply alpha values as a transparency if the alpha is present. Brightness changes will make the layer more or less transparent.

## Add

Adds the value of each RGB pixel together. Always creates a brighter result. Values clamp at 255.

## Multiply

Reads the level of each subpixel as a level between 0.0 and 1.0, and multiplies source with blend. The result is always a darker image overall. For example: white x grey = 0.5. White turns transparent, black takes precedence. Alpha is applied in the same fashion as the Over Blend mode.

## Mask

Choose mask when you want to multiple out content upwards in the stack of layers, rather than downwards. In order to make this work you have to use the same mapping on the layer set to mask and the layer on top.

## Multiply-Fade

The same as Multiply, but will make use of the alpha channel to calculate transparency in the source and blend layers. Since maximum transparency is premultiplied, alpha results in black. This will ignore black created through premultiplying.

## Multiply-Alpha

Multiply with straight alpha. This mode assumes that the alpha has not been premultiplied onto the RGB values and will not apply a correction to the semi-transparent pixels.

## Premultiply Alpha

Like how Multiply-fade will ignore the darkening caused by premultiplying, this blend mode will do the same with Alpha.

## Colour Burn

Blend mode increases the contrast to darken the base colour while reflecting the blend colour. The darker the blend colour, the more intensely the colour will be applied in the base image. White as the blend colour produces no change. Using the colour burn blend mode can produce some harsh results at full opacity.

The colour burn blend mode can be used to make tonal and colour adjustments to a layer.

## Screen

This blend mode looks at each channels colour information and multiplies the inverse of the blend and base colour. The result is always a lighter colour. Screening with black leaves the colour unchanged. Screening with white produces white. The effect is similar to projecting multiple images on top of each other - where bright white is fully opaque, black is fully transparent and 50% grey is 50% transparent.

## Overlay

Multiplies or screens the colours, depending on the base colour. Patterns or colours overlay the existing pixels while preserving the highlights and shadows of the base colour. The base colour is not replaced, but mixed with the blend colour to reflect the lightness or darkness of the original colour.

## Hard Light

Multiplies or screens the colours, depending on the blend colour. The effect is similar to shining a harsh spotlight on the image. If the blend colour (light source/top layer) is lighter than 50% grey, the image is lightened as if it were screened. This is useful for adding highlights to an image. If the blend colour is darker than 50% grey, the image is darkened as if it were multiplied. This is useful for adding shadows to an image. Painting with pure black or white results in pure black or white.

## Soft Light

Darkens or lightens the colours, depending on the blend colour. The effect is similar to shining a diffused spotlight on the image. If the blend colour (light source/top layer) is lighter than 50% grey, the image is lightened as if it were dodged. If the blend colour is darker than 50% grey, the image is darkened as if it were burned in. Painting with pure black or white produces a distinctly darker or lighter area, but does not result in pure black or white.

## Darken

Looks at the colour information in each channel and selects the base or blend colour - whichever is darker - as the result colour. Pixels lighter than the blend colour are replaced and pixels darker than the blend colour do not change.

## Lighten

Looks at the colour information in each channel and selects the base or blend colour - whichever is lighter - as the result colour. Pixels darker than the blend colour are replaced and pixels lighter than the blend colour do not change.

## Difference

Looks at the colour information in each channel and subtracts either the blend colour from the base colour or the base colour from the blend colour depending on which has the greater brightness value.

Blending with white inverts the base colour values and blending with black produces no change.

## Exclusion

Creates an effects similar to but lower in contrast than the difference mode. Blending with white inverts the base colour values. Blending with black produces no change.

## Colour Dodge

Looks at the colour information in each channel and brightens the base colour to reflect the blend colour by decreasing contrast between the two. Blending with black produces no change.

## Hard Mix

Adds the RGB channels of the blend colour to the RGB values of the base colour. If the resulting sum for a channel is 255 or greater, it receives a value of 255; if it is less than 255 it receives a value of 0. Therefore all blended pixels have RGB channels of either 0 or 255. This changes all pixels to primary additive colours (RGB), white or black.

## Brightness

This property (which appears as a light bulb icon) controls the brightness of the layer output.

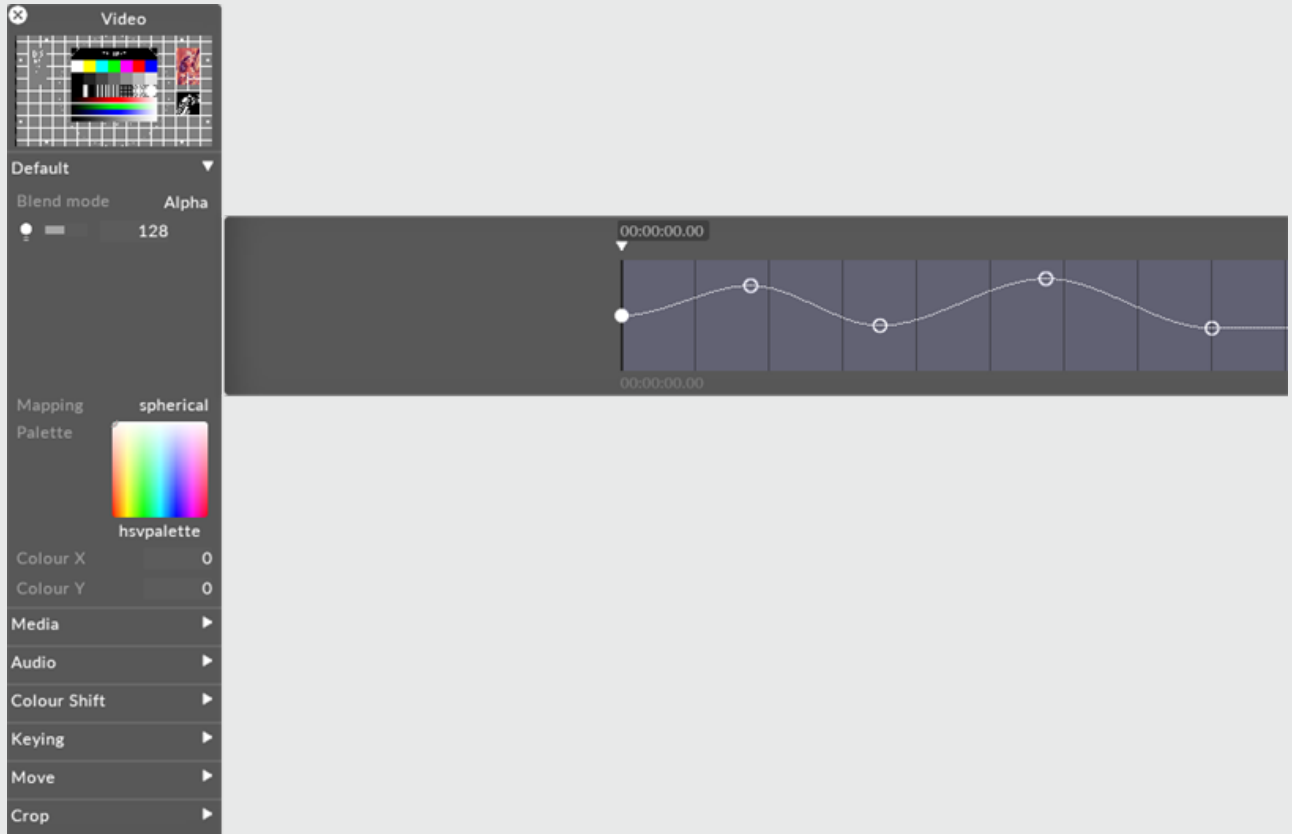

If the layers blend mode is set to Alpha, then reducing the brightness to 0 also reduces the opacity of the layer to 0. This can be useful when you want to dissolve from one layer to the next. In that case, you can place the new layer above the old layer and increase its brightness level.

## Mapping

The mapping property controls how the layer output is mapped onto the screen(s) in the Stage level.

**Video**

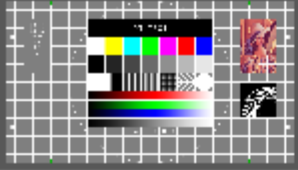

Default ▾

Blend mode Alpha

128

Mapping direct map 1

Palette



hsvpalette

Colour X 0

Colour Y 0

Media ▾

Video



d3\_test\_16-9.png

Speed 1

Mode Normal

At end point Loop

Transition time 0

Audio ▶

Colour Shift ▶

Keying ▶

Move ▶

Crop ▶



**mappings**

New mapping: OK Search:

all New Mappings

- direct map 1
- feed map 2
- feed mapping
- mapping 1
- mapping 2
- parallel
- spherical



For information on mapping, including how to use the different mapping types offered by Disguise software, please see the chapter [Content Mapping](#).

## Palette

This points to the still image file that defines the bitmap from which the tint colour is taken. The default palette ( HSVPAL ) consists of the complete range of hues and saturations. Selecting this property will open the Texture object library, which shows all of the still image files saved on your local hard-drive in the **DxTexture** folder.

To control the location within the current palette bitmap, and thus control the colour, you have to edit the **xCol** and **yCol** values (see the section for xCol, yCol).

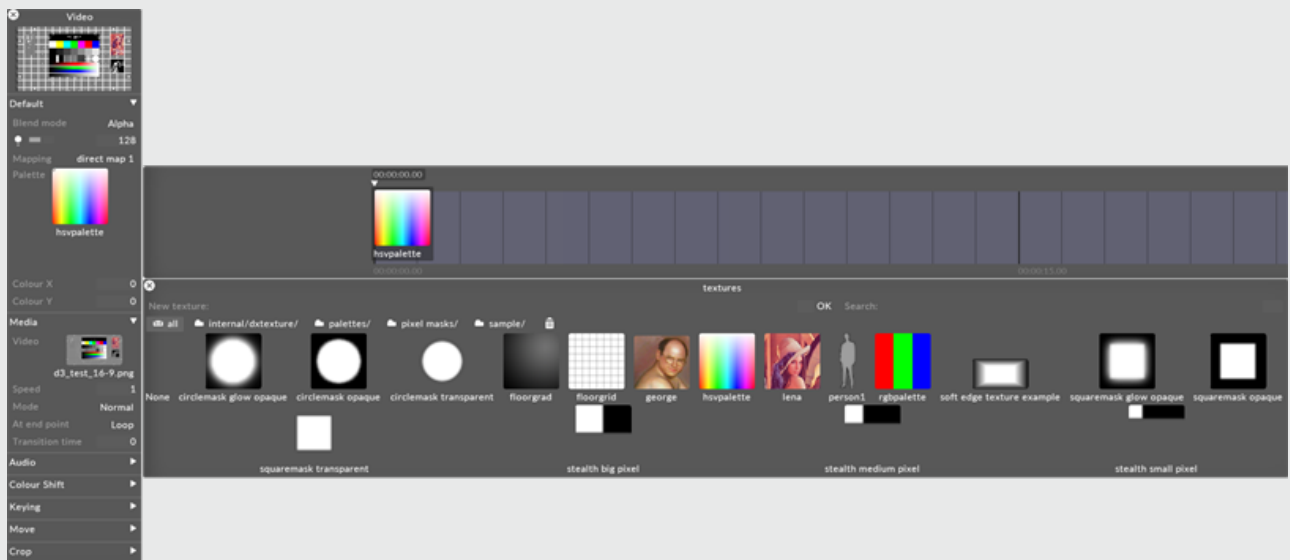

To change the current palette bitmap:

1. Left-click **palette** to open the Texture object library.
2. Left-click the still image file you want to use for the palette bitmap.

If you want to use a palette bitmap other than the standard still images provided in Disguise software, you will need to use a custom still image file.

See the [Placing media files for a project](#) sub-chapter to understand where to place a custom still image file and how to access it in Disguise software. Also save the file to a [supported file format](#).

## xCol, yCol

These properties control the coordinates within the current palette bitmap where the output colour is sampled from. The default value is 0,0 which points at the color white (if you are using the HSVPAL palette). Multiplying white with the colors of the chosen content simply generates the original content colors. **Colour X** controls the horizontal position, where 0 is the leftmost edge and 255 is the rightmost edge. **Colour Y** controls the vertical position, where 0 is the top edge and 255 is the bottom edge.

For example, to saturate the video clip red, change the **Colour Y** value to 255 and use 0 for the **Colour X** value. These coordinates refer to the color red in the palette which is being multiplied with the colors of the existing content.

When you are using the default palette HSVPAL , **Colour Y** controls saturation, and **Colour X** controls hue.

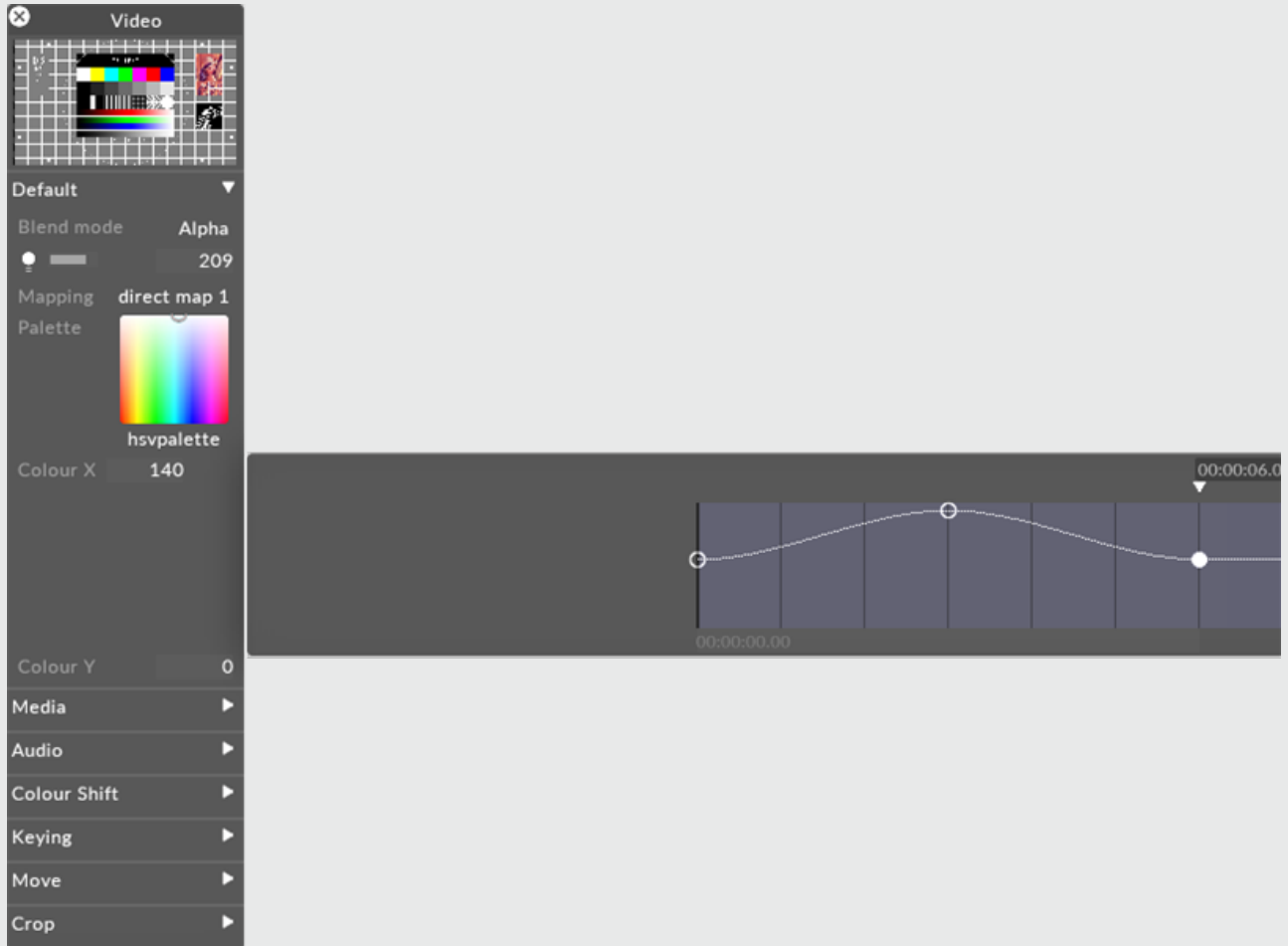

## Colour Shift

The colour shift property allows you to perform a number of colour-correction operations on the output of a layer.

Colour Shift objects can also be attached to individual video files within the Video layer.



Colour Shift property performs colour-corrections on the output of a visual layer

Colour Shift properties are:

# Saturation scale

When set to 1, no change is applied to the image. When set to 0, the image is desaturated to black and white. When set higher than 1, the image is hypersaturated.

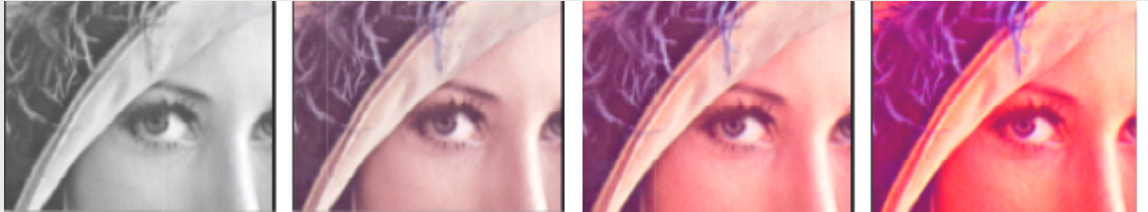

Saturation scale (from left to right):  $s=0$ ,  $s=0.5$ ,  $s=1$ ,  $s=2$

# Hue shift

## RGB controlled

This property controls how the min/max levels and gamma corrections are applied. If set to *together*, then the min, max and gamma values are the same for the red, green and blue channels. If set to *separate*, the min,max and gamma values can be controlled separately for red, green and blue. The latter setting allows you to apply fine colour balance controls to the image.

## Min

This sets the lowest brightness level found in the image. All pixels at this level are scaled down to zero brightness. Increasing this value enforces shadows and dark levels in the image and can be used to reduce low-level compression artifacts in an image or video frame.

Increasing *min* equally across red, green and blue enforces shadows, whereas increasing *min* on an individual channel has the effect of shifting the colour balance away from that colour. For example, increasing *red min* shifts the image towards cyan.

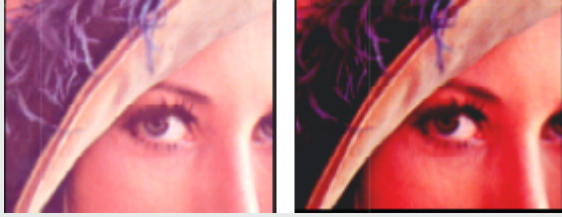

min = 00 (left), min = 96 (right)

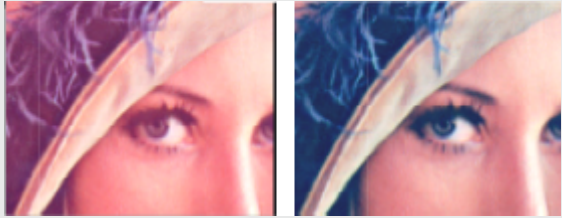

red.min = 0 (left), red.min = 96 (right)

## Max

This sets the highest brightness level found in the image. All pixels at this level are scaled up to the maximum level, i.e. 255. Decreasing this value brightens any highlights in the image. This is useful when the source image is too dark.

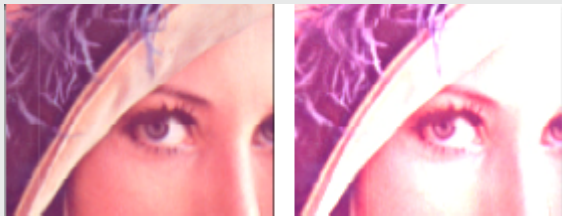

max = 255 (left), max = 260 (right)

If you set min to 255 and max to 0, the image (or single channel) will be inverted.

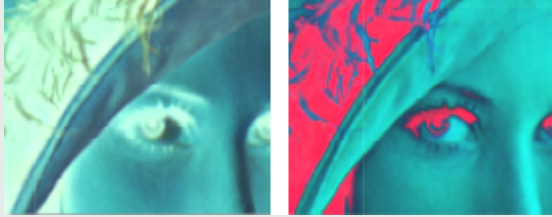

Invert all (left), invert red (right)

## Gamma

When *gamma* is set to 1, no change is made to the image. Reducing gamma brightens highlights while increasing gamma darkens lowlights. The maximum and minimum brightness levels remain the same.

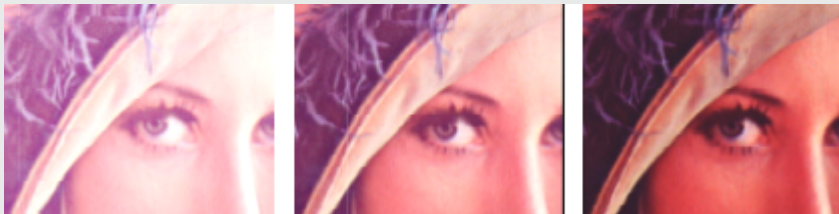

Gamma scale (from left to right):  $g=0.5$ ,  $g=1$ ,  $g=1.5$

## TestPattern layer properties

### Circles

Defines whether the test pattern has circles or not.

### Circle radius

Defines the radius of the circles.

## Label

Defines whether to show the screen/projector label in the pattern.

## GridMode

Defines whether the pattern uses grids.

## GridSpacing

Defines the spacing between the grid squares.

## SubGridSpacing

Defines the spacing between the second layer of grid squares.



# Video

The Video layer works in the same way to the Legacy video layer with the only exception of the speed property.

With the Video layer it is possible to adjust the speed of the video clip whilst the clip is playing. The playback speed will vary between the keyframe points unlike in the video layer.

## Preview Thumbnail

This property is a small preview window at the top of the editor showing you what the layer output looks like.

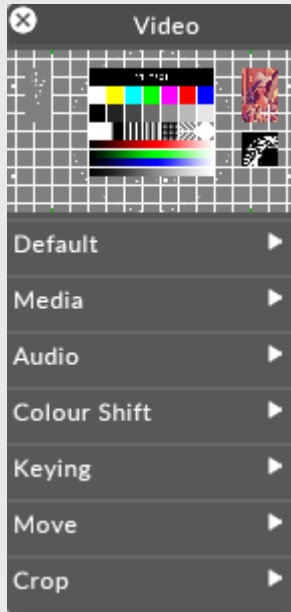

## Blend Mode

BlendMode controls how the output of the layer is composited with the layers below. Layers are rendered in a bottom-up order: layers at the top can modify the output of the layers below.

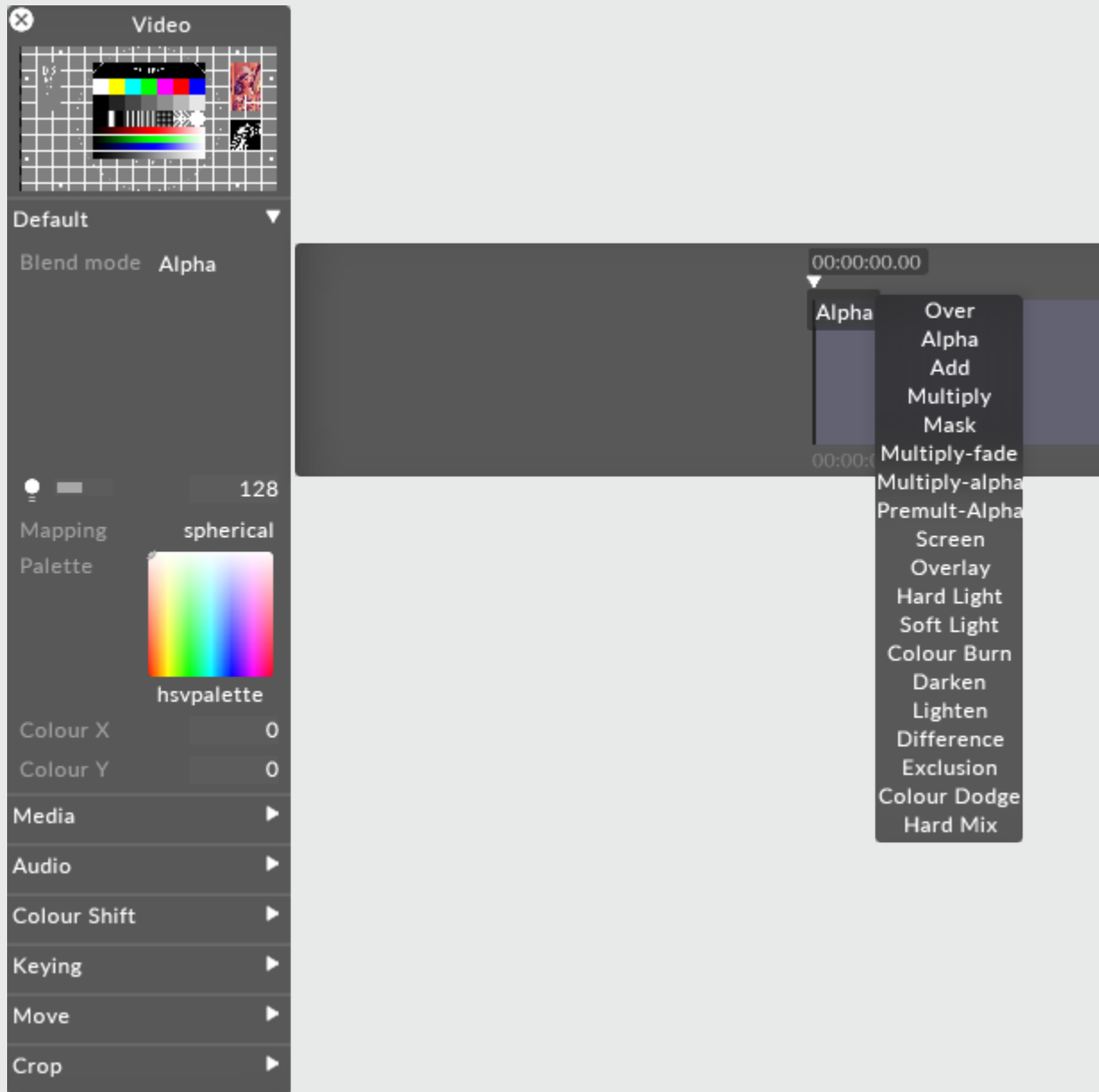

Changing brightness of a content layer in Disguise software is actually controlling the value of the alpha of the layer. Even when displaying a HAP video, the software will composite the layer with a controllable layer of alpha - one per layer.

There are two ways of expressing alpha in an image:

Straight alpha is an alpha channel which functions just like RGB. Alpha acts as a fourth channel of information per pixel which is as independent of the other three as R, G and B are of each other. For example, with straight alpha it is possible to have RGB = 255 (white) and alpha = 0 (fully transparent) on the same pixel. Internally generated content, such as gradient layer, are generated with straight alpha. This is the preferable style of alpha and considering the cleaner method of the two.

Premultiplied alpha takes the alpha and applies it to the values of the RGB channels per pixel. The more transparent something gets with premultiplied alpha, the closer it gets to black - as if the content is sitting on a black table. Premultiplied is the default output of Adobe Photoshop or AfterEffects. the result is our pixel at 255 RGB (full white) with 0 alpha would be calculated as a black pixel in the final image.

Here are explanations of what each individual blend mode will do.

## Over

Makes a layer fully opaque. Premultiplies all alpha onto the RGB value of each pixel. Alpha = black, so adjusting the brightness of a layer in Over blend mode makes it darker.

## Alpha

Default blend mode. It will apply alpha values as a transparency if the alpha is present. Brightness changes will make the layer more or less transparent.

## Add

Adds the value of each RGB pixel together. Always creates a brighter result. Values clamp at 255.

## Multiply

Reads the level of each subpixel as a level between 0.0 and 1.0, and multiplies source with blend. The result is always a darker image overall. For example: white x grey = 0.5. White turns transparent, black takes precedence. Alpha is applied in the same fashion as the Over Blend mode.

## Mask

Choose mask when you want to multiple out content upwards in the stack of layers, rather than downwards. In order to make this work you have to use the same mapping on the layer set to mask and the layer on top.

## Multiply-Fade

The same as Multiply, but will make use of the alpha channel to calculate transparency in the source and blend layers. Since maximum transparency is premultiplied, alpha results in black. This will ignore black created through premultiplying.

## Multiply-Alpha

Multiply with straight alpha. This mode assumes that the alpha has not been premultiplied onto the RGB values and will not apply a correction to the semi-transparent pixels.

## Premultiply Alpha

Like how Multiply-fade will ignore the darkening caused by premultiplying, this blend mode will do the same with Alpha.

## Colour Burn

Blend mode increases the contrast to darken the base colour while reflecting the blend colour. The darker the blend colour, the more intensely the colour will be applied in the base image. White as the blend colour produces no change. Using the colour burn blend mode can produce some harsh results at full opacity.

The colour burn blend mode can be used to make tonal and colour adjustments to a layer.

## Screen

This blend mode looks at each channels colour information and multiplies the inverse of the blend and base colour. The result is always a lighter colour. Screening with black leaves the colour unchanged. Screening with white produces white. The effect is similar to projecting multiple images on top of each other - where bright white is fully opaque, black is fully transparent and 50% grey is 50% transparent.

## Overlay

Multiplies or screens the colours, depending on the base colour. Patterns or colours overlay the existing pixels while preserving the highlights and shadows of the base colour. The base colour is not replaced, but mixed with the blend colour to reflect the lightness or darkness of the original colour.

## Hard Light

Multiplies or screens the colours, depending on the blend colour. The effect is similar to shining a harsh spotlight on the image. If the blend colour (light source/top layer) is lighter than 50% grey, the image is lightened as if it were screened. This is useful for adding highlights to an image. If the blend colour is darker than 50% grey, the image is darkened as if it were multiplied. This is useful for adding shadows to an image. Painting with pure black or white results in pure black or white.

## Soft Light

Darkens or lightens the colours, depending on the blend colour. The effect is similar to shining a diffused spotlight on the image. If the blend colour (light source/top layer) is lighter than 50% grey, the image is lightened as if it were dodged. If the blend colour is darker than 50% grey, the image is darkened as if it were burned in. Painting with pure black or white produces a distinctly darker or lighter area, but does not result in pure black or white.

## Darken

Looks at the colour information in each channel and selects the base or blend colour - whichever is darker - as the result colour. Pixels lighter than the blend colour are replaced and pixels darker than the blend colour do not change.

## Lighten

Looks at the colour information in each channel and selects the base or blend colour - whichever is lighter - as the result colour. Pixels darker than the blend colour are replaced and pixels lighter than the blend colour do not change.

## Difference

Looks at the colour information in each channel and subtracts either the blend colour from the base colour or the base colour from the blend colour depending on which has the greater brightness value.

Blending with white inverts the base colour values and blending with black produces no change.

## Exclusion

Creates an effects similar to but lower in contrast than the difference mode. Blending with white inverts the base colour values. Blending with black produces no change.

## Colour Dodge

Looks at the colour information in each channel and brightens the base colour to reflect the blend colour by decreasing contrast between the two. Blending with black produces no change.

## Hard Mix

Adds the RGB channels of the blend colour to the RGB values of the base colour. If the resulting sum for a channel is 255 or greater, it receives a value of 255; if it is less than 255 it receives a value of 0. Therefore all blended pixels have RGB channels of either 0 or 255. This changes all pixels to primary additive colours (RGB), white or black.

## Brightness

This property (which appears as a light bulb icon) controls the brightness of the layer output.

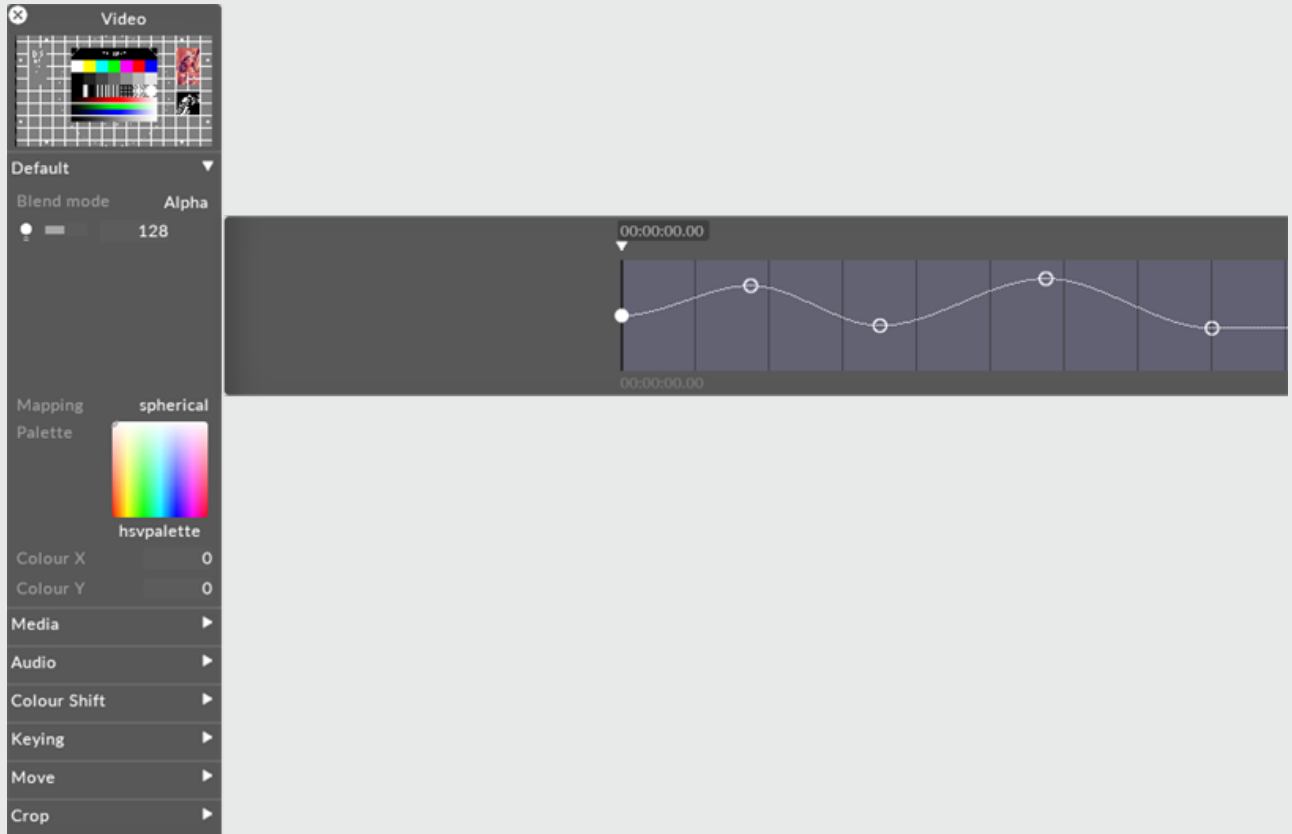

If the layers blend mode is set to Alpha, then reducing the brightness to 0 also reduces the opacity of the layer to 0. This can be useful when you want to dissolve from one layer to the next. In that case, you can place the new layer above the old layer and increase its brightness level.

## Mapping

The mapping property controls how the layer output is mapped onto the screen(s) in the Stage level.



**Video**

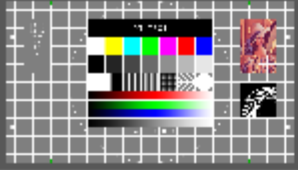

Default ▾

Blend mode Alpha

128

Mapping direct map 1

Palette



hsvpalette

Colour X 0

Colour Y 0

Media ▾

Video



d3\_test\_16-9.png

Speed 1

Mode Normal

At end point Loop

Transition time 0

Audio ▶

Colour Shift ▶

Keying ▶

Move ▶

Crop ▶



**mappings**

New mapping: OK Search:

all New Mappings

- direct map 1
- feed map 2
- feed mapping
- mapping 1
- mapping 2
- parallel
- spherical

For information on mapping, including how to use the different mapping types offered by Disguise software, please see the chapter [Content Mapping](#).

## Palette

This points to the still image file that defines the bitmap from which the tint colour is taken. The default palette ( HSVPAL ) consists of the complete range of hues and saturations. Selecting this property will open the Texture object library, which shows all of the still image files saved on your local hard-drive in the **DxTexture** folder.

To control the location within the current palette bitmap, and thus control the colour, you have to edit the **xCol** and **yCol** values (see the section for xCol, yCol).

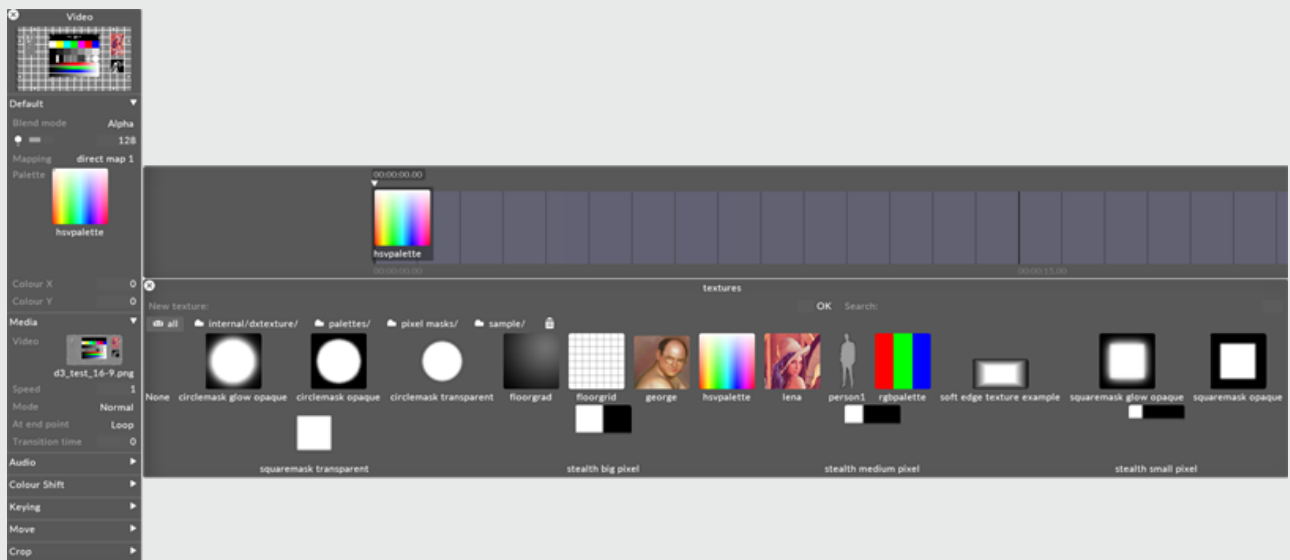

To change the current palette bitmap:

1. Left-click **palette** to open the Texture object library.
2. Left-click the still image file you want to use for the palette bitmap.

If you want to use a palette bitmap other than the standard still images provided in Disguise software, you will need to use a custom still image file.

See the [Placing media files for a project](#) sub-chapter to understand where to place a custom still image file and how to access it in Disguise software. Also save the file to a [supported file format](#).

## xCol, yCol

These properties control the coordinates within the current palette bitmap where the output colour is sampled from. The default value is 0,0 which points at the color white (if you are using the HSVPAL palette). Multiplying white with the colors of the chosen content simply generates the original content colors. **Colour X** controls the horizontal position, where 0 is the leftmost edge and 255 is the rightmost edge. **Colour Y** controls the vertical position, where 0 is the top edge and 255 is the bottom edge.

For example, to saturate the video clip red, change the **Colour Y** value to 255 and use 0 for the **Colour X** value. These coordinates refer to the color red in the palette which is being multiplied with the colors of the existing content.

When you are using the default palette HSVPAL , **Colour Y** controls saturation, and **Colour X** controls hue.

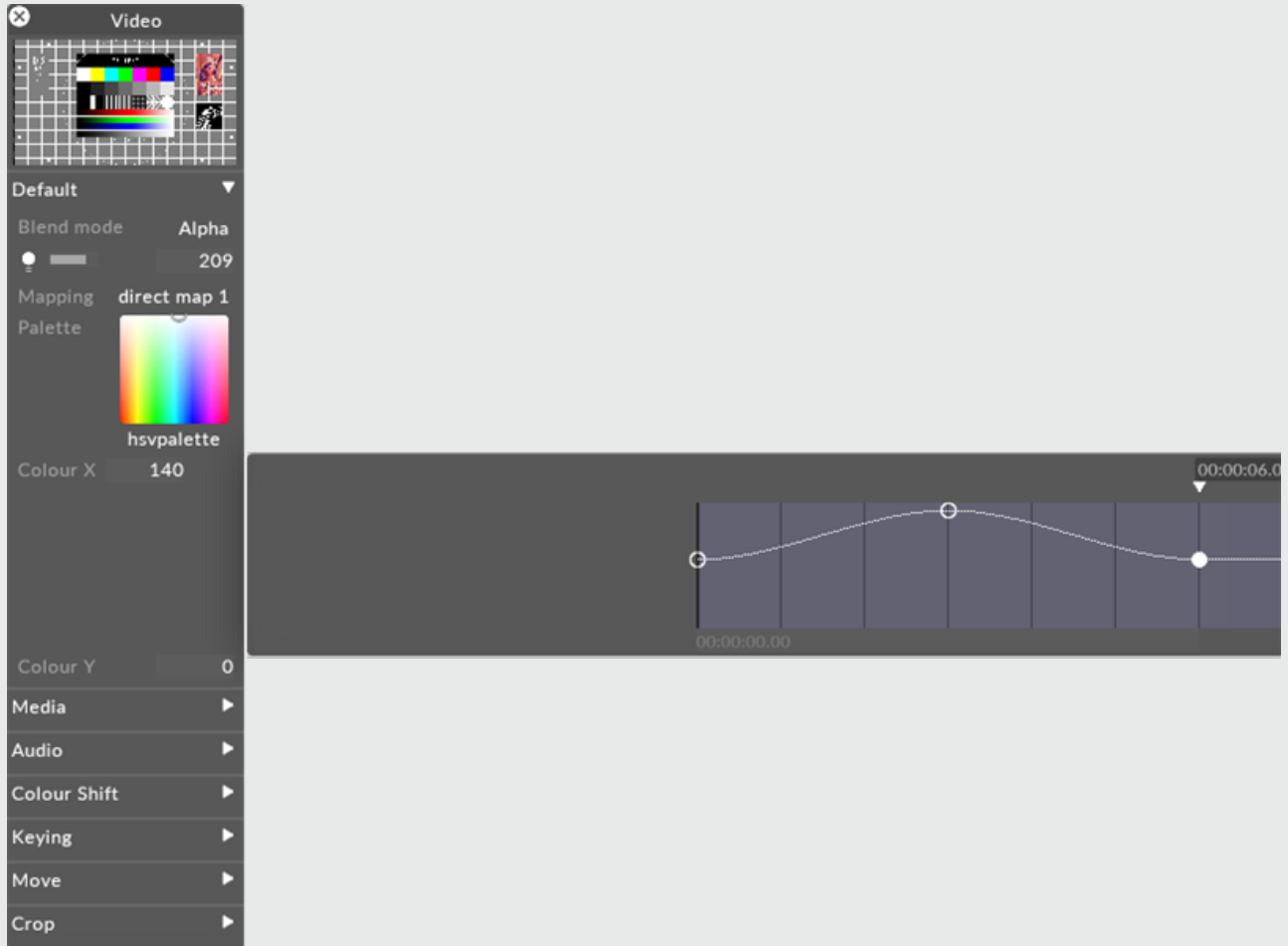

## Colour Shift

The colour shift property allows you to perform a number of colour-correction operations on the output of a layer.

Colour Shift objects can also be attached to individual video files within the Video layer.

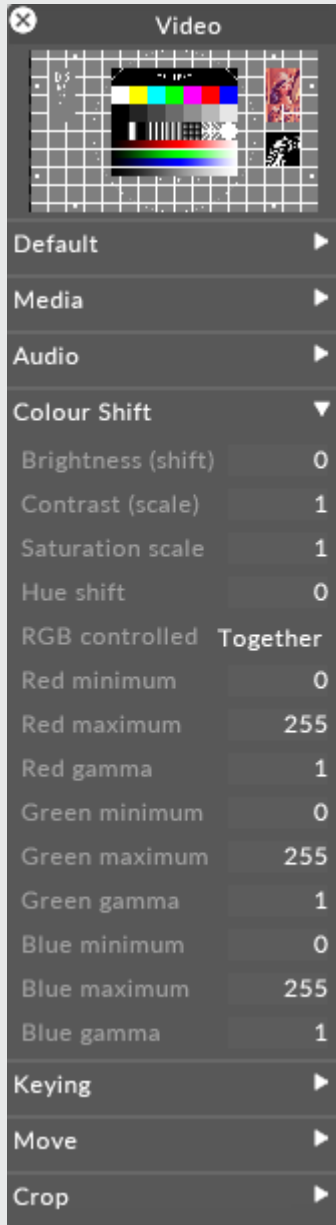

Colour Shift property performs colour-corrections on the output of a visual layer

Colour Shift properties are:

# Saturation scale

When set to 1, no change is applied to the image. When set to 0, the image is desaturated to black and white. When set higher than 1, the image is hypersaturated.

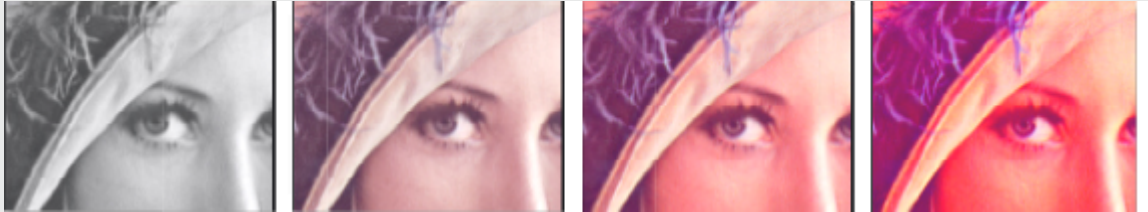

Saturation scale (from left to right):  $s=0$ ,  $s=0.5$ ,  $s=1$ ,  $s=2$

# Hue shift

## RGB controlled

This property controls how the min/max levels and gamma corrections are applied. If set to *together*, then the min, max and gamma values are the same for the red, green and blue channels. If set to *separate*, the min,max and gamma values can be controlled separately for red, green and blue. The latter setting allows you to apply fine colour balance controls to the image.

## Min

This sets the lowest brightness level found in the image. All pixels at this level are scaled down to zero brightness. Increasing this value enforces shadows and dark levels in the image and can be used to reduce low-level compression artifacts in an image or video frame.

Increasing *min* equally across red, green and blue enforces shadows, whereas increasing *min* on an individual channel has the effect of shifting the colour balance away from that colour. For example, increasing *red min* shifts the image towards cyan.

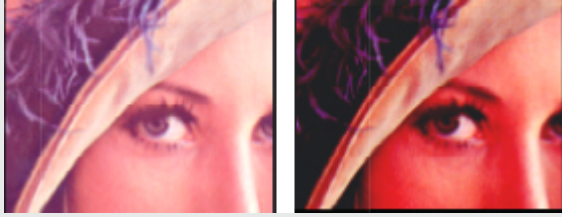

min = 00 (left), min = 96 (right)

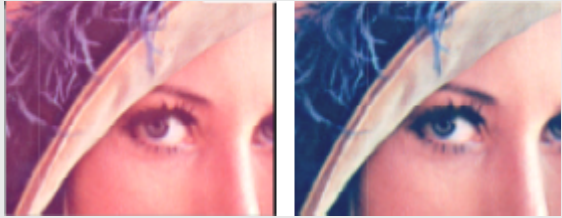

red.min = 0 (left), red.min = 96 (right)

## Max

This sets the highest brightness level found in the image. All pixels at this level are scaled up to the maximum level, i.e. 255. Decreasing this value brightens any highlights in the image. This is useful when the source image is too dark.

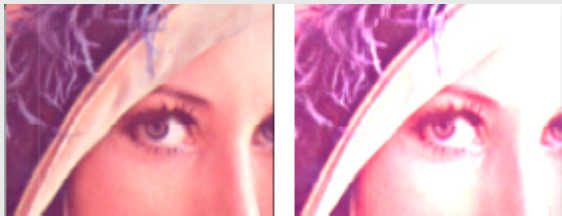

max = 255 (left), max = 260 (right)

If you set min to 255 and max to 0, the image (or single channel) will be inverted.

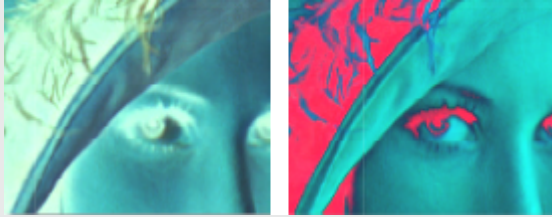

Invert all (left), invert red (right)

## Gamma

When *gamma* is set to 1, no change is made to the image. Reducing gamma brightens highlights while increasing gamma darkens lowlights. The maximum and minimum brightness levels remain the same.

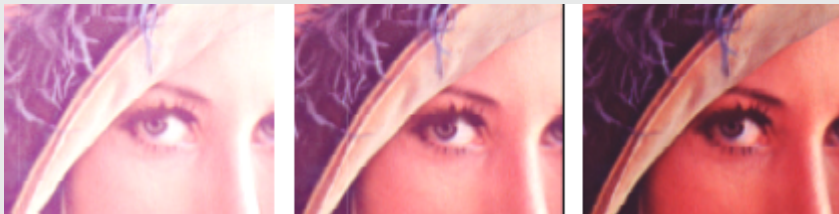

Gamma scale (from left to right):  $g=0.5$ ,  $g=1$ ,  $g=1.5$

## Media

The Video property points to the still media file that defines the content to be used on the layer. Selecting this property will open the VideoClip object library, which shows all of the still image files saved on your local hard-drive in the **VideoFile** folder.

To change the current piece of content:



1. Left-click **Video** to open the VideoClip object library.
2. Left-click the media file you want to use.

See the [Placing media files for a project](#) sub-chapter to understand where to place your content and how to access it in Disguise software. Also save the file to a [supported file format](#).

## Speed

Selects playback speed. When this is set to 1, the video is played at its normal framerate; when set to 2, the video is played at double speed, when set to -1, the video is played at normal framerate in reverse and so on.

## Mode

This specifies the playback mode. There are three modes; each one has a specific behaviour that is useful for a different situation.

### Normal

When the play cursor stops, the video will also stop and the frame number will lock to the timeline position. When the cursor continues to play or holds at the end of a section, the video will play continuously. Jumping around the timeline while playing does not affect which frame is being played.

### Locked

If the play cursor continues to play or stops at the end of a section, the video frame number is locked to the playhead position on the timeline

## At end point

This specifies what happens when playback reaches the end of the video clip. There are three options to choose from:

## Loop

When playback reaches the end of the video clip, the clip will loop immediately back to the beginning and will start playing again from there.

## Ping-pong

When playback reaches the end of the video clip, the clip will play in reverse back to the beginning.

## Pause

When playback reaches the end of the video clip, the clip will pause on the last frame.

## Transition Time

The transition property specifies the dissolve time, in seconds, when switching from one video clip to the next on the timeline. By default, this is set to 0, so the player cuts immediately from one clip to the next. Setting this value to 1 causes the player to dissolve from one clip to the next over 1 second.

## Volume

Some video clips may contain audio. You can fill in any number between 0 (mute) and 255 (full) in the text field to set a constant volume, or open the property's key-frame editor to fade volume in or out.

## Output

If the video has an audio track, this controls which audio output device the audio is played to.

## Threshold

The threshold of the keying. Colours closer than (threshold) to the key colour become transparent.

## Hardness

The hardness of the keying. Lower numbers produce softer edges and higher numbers produce harder edges between transparent and opaque areas.

## Key colour rgb

The value of the key colour, 0 255, causing the key colour to become transparent.

## Scale

Controls the size of the video.

## Aspect

Controls the aspect ratio of the video, higher numbers make the frame taller.

## Pos xy

Position of the video; x = horizontal position, y = vertical position. 0 = centre of canvas, -1 = top edge of canvas, +1 = bottom edge

## Rotation

Rotation (in degrees) of the video.

## Crop left, right, top, bottom

Crops the frame from the respective edge. 0 = no crop, 1 = entire frame crop.

# Vignette

Adds a vignette effect by softening the edges of the crop.

# Legacy video

The Legacy video layer is used to play pre-rendered Quicktime video files. To see what video file formats Disguise software support see the [Supported file formats](#) page.

To see where to place media files in Windows see the [Placing media files for a project](#) page.

## Preview Thumbnail

This property is a small preview window at the top of the editor showing you what the layer output looks like.

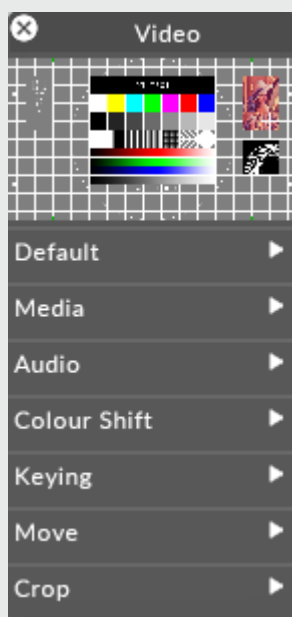

# Blend Mode

BlendMode controls how the output of the layer is composited with the layers below. Layers are rendered in a bottom-up order: layers at the top can modify the output of the layers below.

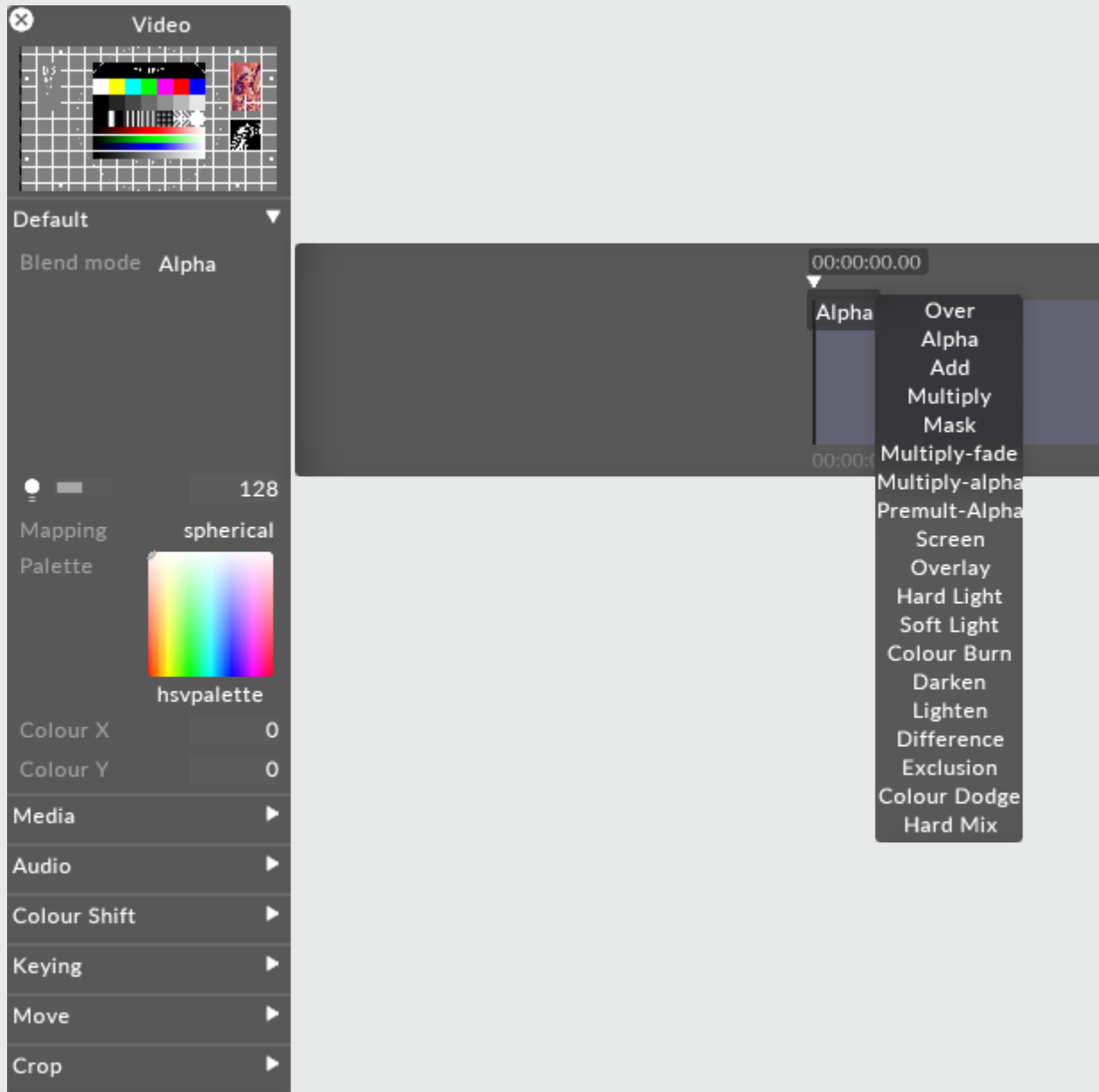

Changing brightness of a content layer in Disguise software is actually controlling the value of the alpha of the layer. Even when displaying a HAP video, the software will composite the layer with a controllable layer of alpha - one per layer.

There are two ways of expressing alpha in an image:

Straight alpha is an alpha channel which functions just like RGB. Alpha acts as a fourth channel of information per pixel which is as independent of the other three as R, G and B are of each other. For example, with straight alpha it is possible to have RGB = 255 (white) and alpha = 0 (fully transparent) on the same pixel. Internally generated content, such as gradient layer, are generated with straight alpha. This is the preferable style of alpha and considering the cleaner method of the two.

Premultiplied alpha takes the alpha and applies it to the values of the RGB channels per pixel. The more transparent something gets with premultiplied alpha, the closer it gets to black - as if the content is sitting on a black table. Premultiplied is the default output of Adobe Photoshop or AfterEffects. The result is our pixel at 255 RGB (full white) with 0 alpha would be calculated as a black pixel in the final image.

Here are explanations of what each individual blend mode will do.

## Over

Makes a layer fully opaque. Premultiplies all alpha onto the RGB value of each pixel. Alpha = black, so adjusting the brightness of a layer in Over blend mode makes it darker.

## Alpha

Default blend mode. It will apply alpha values as a transparency if the alpha is present. Brightness changes will make the layer more or less transparent.

## Add

Adds the value of each RGB pixel together. Always creates a brighter result. Values clamp at 255.

## Multiply

Reads the level of each subpixel as a level between 0.0 and 1.0, and multiplies source with blend. The result is always a darker image overall. For example: white x grey = 0.5. White turns transparent, black takes precedence. Alpha is applied in the same fashion as the Over Blend mode.



## Mask

Choose mask when you want to multiple out content upwards in the stack of layers, rather than downwards. In order to make this work you have to use the same mapping on the layer set to mask and the layer on top.

## Multiply-Fade

The same as Multiply, but will make use of the alpha channel to calculate transparency in the source and blend layers. Since maximum transparency is premultiplied, alpha results in black. This will ignore black created through premultiplying.

## Multiply-Alpha

Multiply with straight alpha. This mode assumes that the alpha has not been premultiplied onto the RGB values and will not apply a correction to the semi-transparent pixels.

## Premultiply Alpha

Like how Multiply-fade will ignore the darkening caused by premultiplying, this blend mode will do the same with Alpha.

## Colour Burn

Blend mode increases the contrast to darken the base colour while reflecting the blend colour. The darker the blend colour, the more intensely the colour will be applied in the base image. White as the blend colour produces no change. Using the colour burn blend mode can produce some harsh results at full opacity.

The colour burn blend mode can be used to make tonal and colour adjustments to a layer.

## Screen

This blend mode looks at each channels colour information and multiplies the inverse of the blend and base colour. The result is always a lighter colour. Screening with black leaves the colour unchanged. Screening with white produces white. The effect is similar to projecting multiple images on top of each other - where bright white is fully opaque, black is fully transparent and 50% grey is 50% transparent.

## Overlay

Multiplies or screens the colours, depending on the base colour. Patterns or colours overlay the existing pixels while preserving the highlights and shadows of the base colour. The base colour is not replaced, but mixed with the blend colour to reflect the lightness or darkness of the original colour.

## Hard Light

Multiplies or screens the colours, depending on the blend colour. The effect is similar to shining a harsh spotlight on the image. If the blend colour (light source/top layer) is lighter than 50% grey, the image is lightened as if it were screened. This is useful for adding highlights to an image. If the blend colour is darker than 50% grey, the image is darkened as if it were multiplied. This is useful for adding shadows to an image. Painting with pure black or white results in pure black or white.

## Soft Light

Darkens or lightens the colours, depending on the blend colour. The effect is similar to shining a diffused spotlight on the image. If the blend colour (light source/top layer) is lighter than 50% grey, the image is lightened as if it were dodged. If the blend colour is darker than 50% grey, the image is darkened as if it were burned in. Painting with pure black or white produces a distinctly darker or lighter area, but does not result in pure black or white.

## Darken

Looks at the colour information in each channel and selects the base or blend colour - whichever is darker - as the result colour. Pixels lighter than the blend colour are replaced and pixels darker than the blend colour do not change.

## Lighten

Looks at the colour information in each channel and selects the base or blend colour - whichever is lighter - as the result colour. Pixels darker than the blend colour are replaced and pixels lighter than the blend colour do not change.

## Difference

Looks at the colour information in each channel and subtracts either the blend colour from the base colour or the base colour from the blend colour depending on which has the greater brightness value.

Blending with white inverts the base colour values and blending with black produces no change.

## Exclusion

Creates an effects similar to but lower in contrast than the difference mode. Blending with white inverts the base colour values. Blending with black produces no change.

## Colour Dodge

Looks at the colour information in each channel and brightens the base colour to reflect the blend colour by decreasing contrast between the two. Blending with black produces no change.

## Hard Mix

Adds the RGB channels of the blend colour to the RGB values of the base colour. If the resulting sum for a channel is 255 or greater, it receives a value of 255; if it is less than 255 it receives a value of 0. Therefore all blended pixels have RGB channels of either 0 or 255. This changes all pixels to primary additive colours (RGB), white or black.

## Brightness

This property (which appears as a light bulb icon) controls the brightness of the layer output.

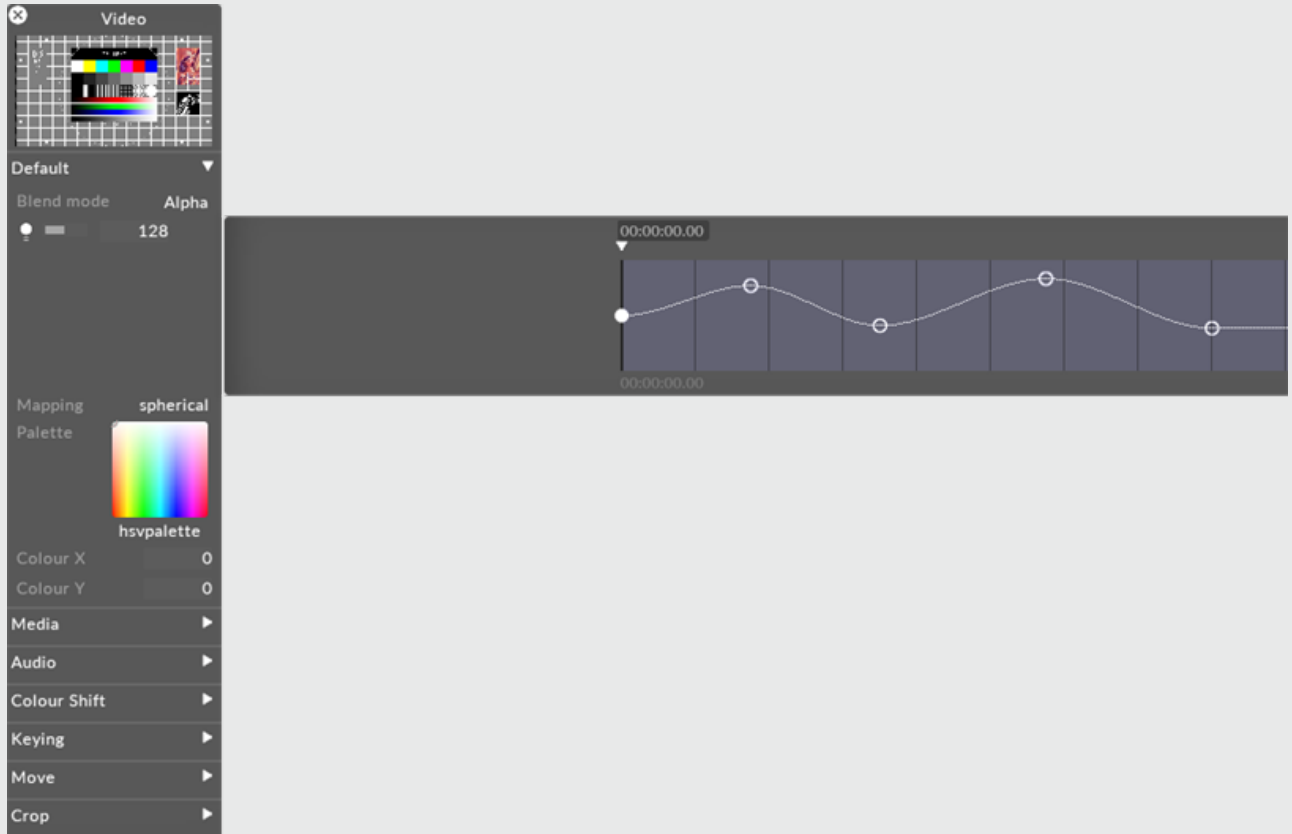

If the layers blend mode is set to Alpha, then reducing the brightness to 0 also reduces the opacity of the layer to 0. This can be useful when you want to dissolve from one layer to the next. In that case, you can place the new layer above the old layer and increase its brightness level.

## Mapping

The mapping property controls how the layer output is mapped onto the screen(s) in the Stage level.

**Video**

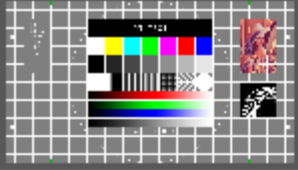

Default ▾

Blend mode Alpha

128

Mapping direct map 1

Palette



hsvpalette

Colour X 0

Colour Y 0

Media ▾

Video



d3\_test\_16-9.png

Speed 1

Mode Normal

At end point Loop

Transition time 0

Audio ▶

Colour Shift ▶

Keying ▶

Move ▶

Crop ▶

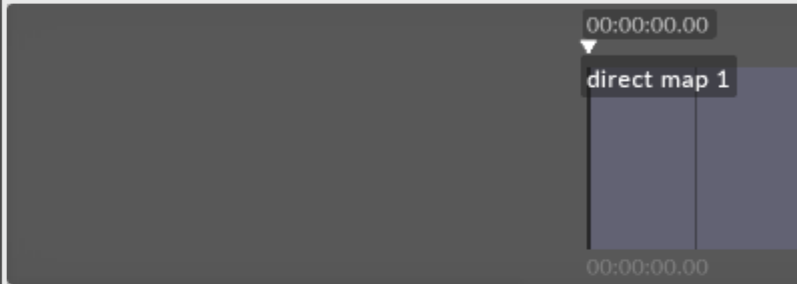

00:00:00.00

direct map 1

00:00:00.00

**mappings**

New mapping: OK Search:

all New Mappings

- direct map 1
- feed map 2
- feed mapping
- mapping 1
- mapping 2
- parallel
- spherical

For information on mapping, including how to use the different mapping types offered by Disguise software, please see the chapter [Content Mapping](#).

## Palette

This points to the still image file that defines the bitmap from which the tint colour is taken. The default palette ( HSVPAL ) consists of the complete range of hues and saturations. Selecting this property will open the Texture object library, which shows all of the still image files saved on your local hard-drive in the **DxTexture** folder.

To control the location within the current palette bitmap, and thus control the colour, you have to edit the **xCol** and **yCol** values (see the section for xCol, yCol).

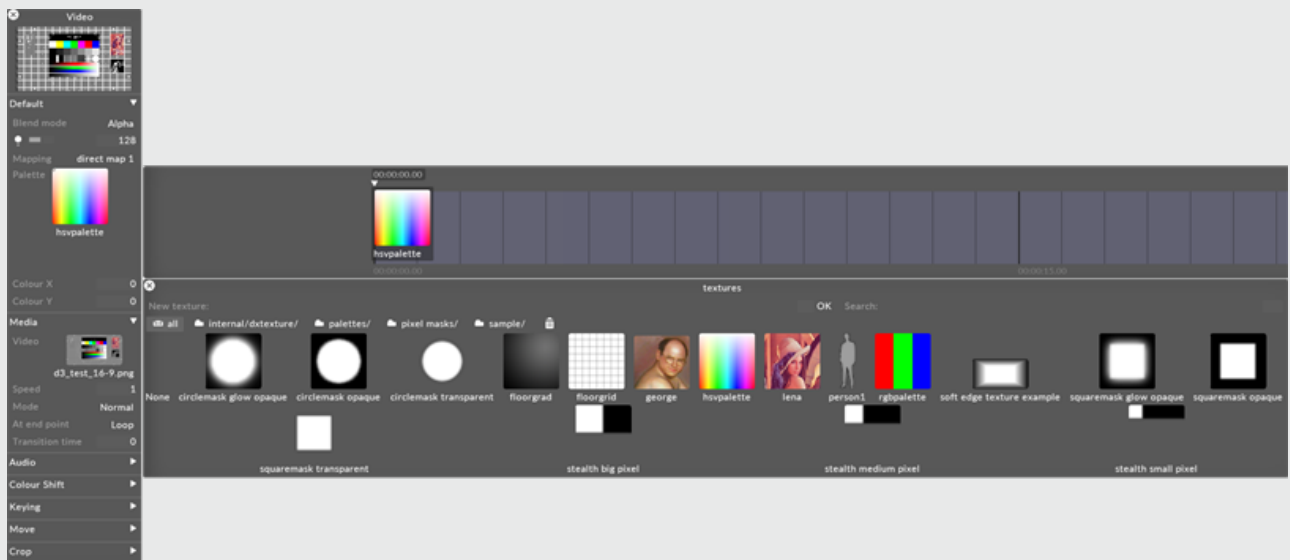

To change the current palette bitmap:

1. Left-click **palette** to open the Texture object library.
2. Left-click the still image file you want to use for the palette bitmap.

If you want to use a palette bitmap other than the standard still images provided in Disguise software, you will need to use a custom still image file.

See the [Placing media files for a project](#) sub-chapter to understand where to place a custom still image file and how to access it in Disguise software. Also save the file to a [supported file format](#).

## xCol, yCol

These properties control the coordinates within the current palette bitmap where the output colour is sampled from. The default value is 0,0 which points at the color white (if you are using the HSVPAL palette). Multiplying white with the colors of the chosen content simply generates the original content colors. **Colour X** controls the horizontal position, where 0 is the leftmost edge and 255 is the rightmost edge. **Colour Y** controls the vertical position, where 0 is the top edge and 255 is the bottom edge.

For example, to saturate the video clip red, change the **Colour Y** value to 255 and use 0 for the **Colour X** value. These coordinates refer to the color red in the palette which is being multiplied with the colors of the existing content.

When you are using the default palette HSVPAL , **Colour Y** controls saturation, and **Colour X** controls hue.

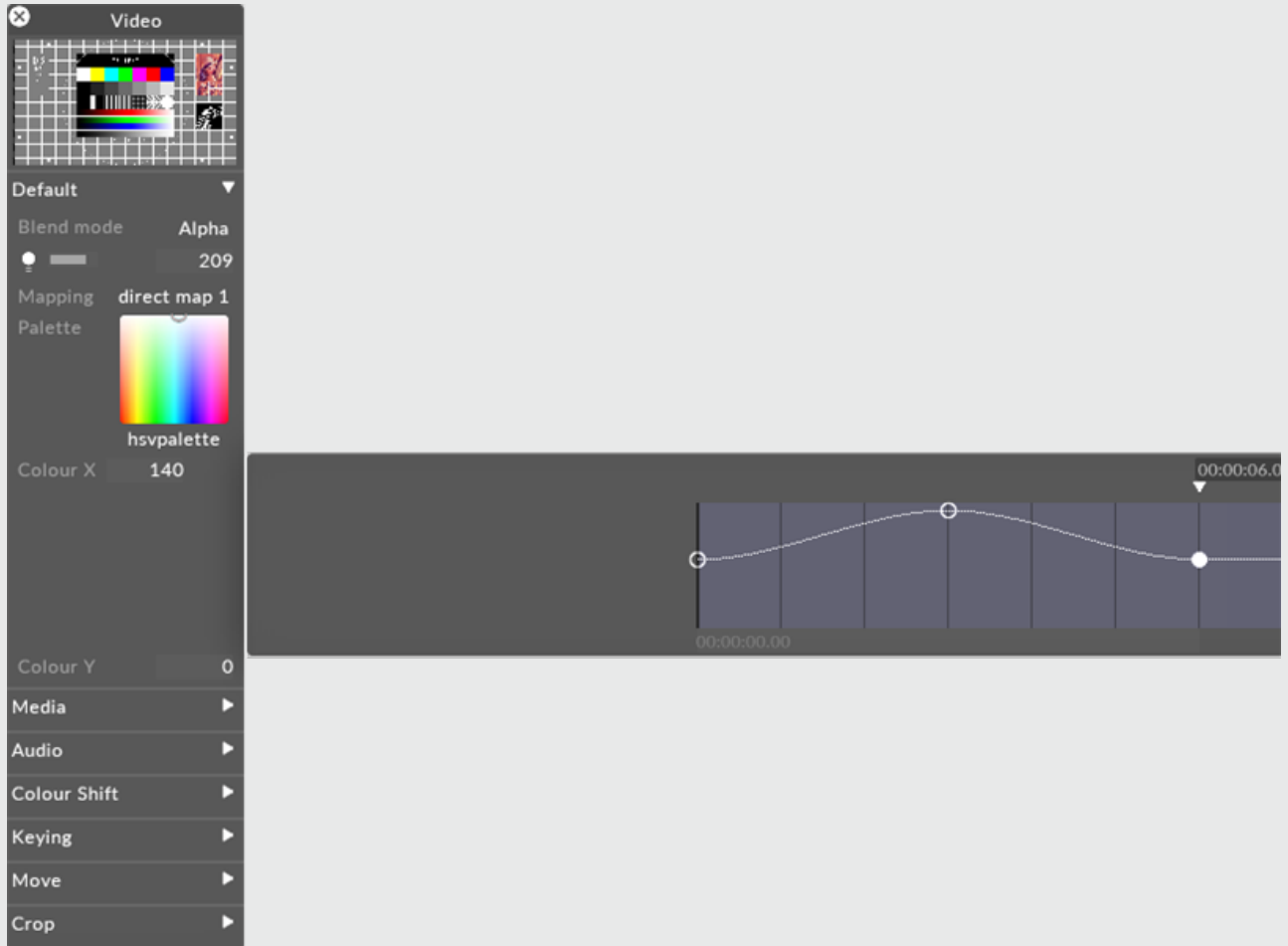

## Colour Shift

The colour shift property allows you to perform a number of colour-correction operations on the output of a layer.

Colour Shift objects can also be attached to individual video files within the Video layer.



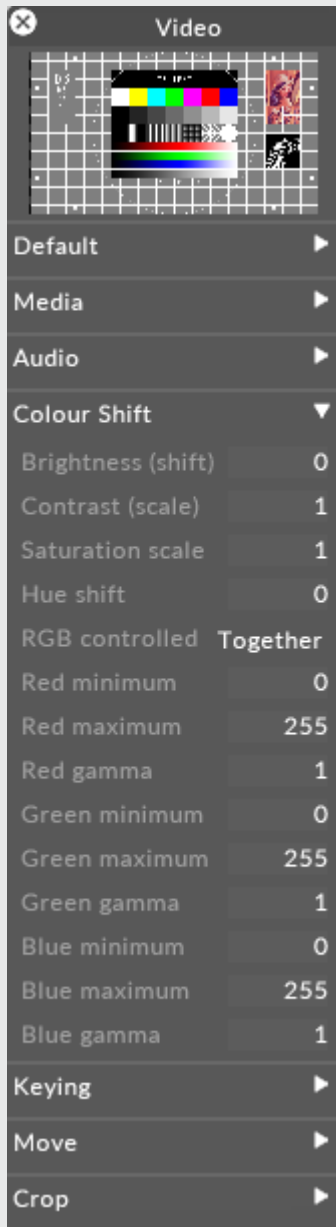

Colour Shift property performs colour-corrections on the output of a visual layer

Colour Shift properties are:

# Saturation scale

When set to 1, no change is applied to the image. When set to 0, the image is desaturated to black and white. When set higher than 1, the image is hypersaturated.

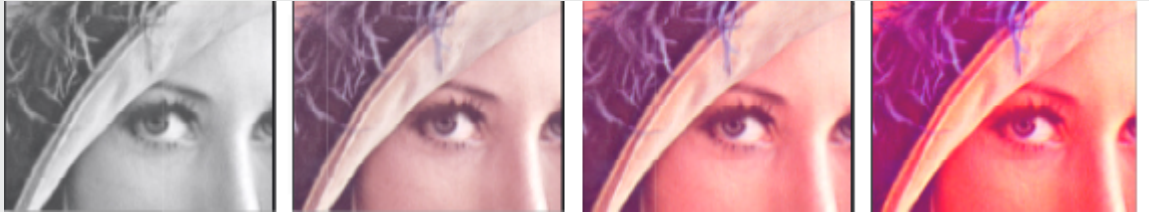

Saturation scale (from left to right):  $s=0$ ,  $s=0.5$ ,  $s=1$ ,  $s=2$

# Hue shift

## RGB controlled

This property controls how the min/max levels and gamma corrections are applied. If set to *together*, then the min, max and gamma values are the same for the red, green and blue channels. If set to *separate*, the min,max and gamma values can be controlled separately for red, green and blue. The latter setting allows you to apply fine colour balance controls to the image.

## Min

This sets the lowest brightness level found in the image. All pixels at this level are scaled down to zero brightness. Increasing this value enforces shadows and dark levels in the image and can be used to reduce low-level compression artifacts in an image or video frame.

Increasing *min* equally across red, green and blue enforces shadows, whereas increasing *min* on an individual channel has the effect of shifting the colour balance away from that colour. For example, increasing *red min* shifts the image towards cyan.

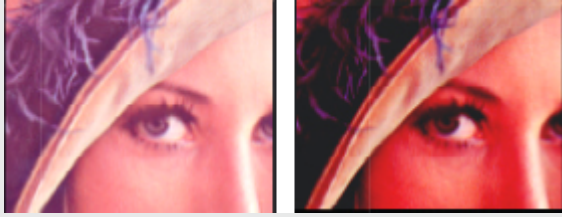

min = 00 (left), min = 96 (right)

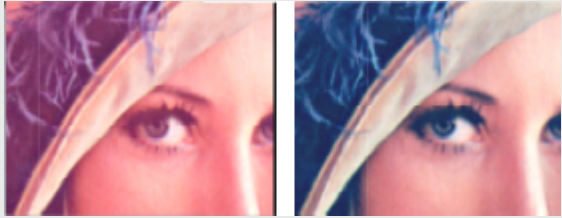

red.min = 0 (left), red.min = 96 (right)

## Max

This sets the highest brightness level found in the image. All pixels at this level are scaled up to the maximum level, i.e. 255. Decreasing this value brightens any highlights in the image. This is useful when the source image is too dark.

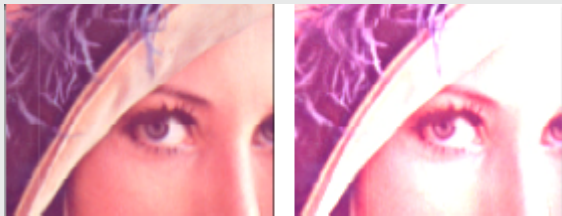

max = 255 (left), max = 260 (right)

If you set min to 255 and max to 0, the image (or single channel) will be inverted.

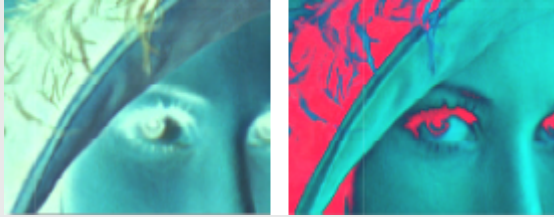

Invert all (left), invert red (right)

## Gamma

When *gamma* is set to 1, no change is made to the image. Reducing gamma brightens highlights while increasing gamma darkens lowlights. The maximum and minimum brightness levels remain the same.

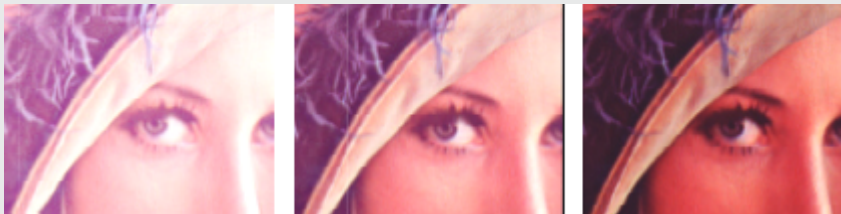

Gamma scale (from left to right):  $g=0.5$ ,  $g=1$ ,  $g=1.5$

## Media

The Video property points to the still media file that defines the content to be used on the layer. Selecting this property will open the VideoClip object library, which shows all of the still image files saved on your local hard-drive in the **VideoFile** folder.

To change the current piece of content:

1. Left-click **Video** to open the VideoClip object library.
2. Left-click the media file you want to use.

See the [Placing media files for a project](#) sub-chapter to understand where to place your content and how to access it in Disguise software. Also save the file to a [supported file format](#).

## Speed

Selects playback speed. When this is set to 1, the video is played at its normal framerate; when set to 2, the video is played at double speed, and so on.

**Please note:** playback speed is set at the point where the video keyframe is encountered in the video keyframe editor. Once this is set, the playback speed does not change, even if it varies over time. To change the playback speed, drop a speed keyframe at the point where the video thumbnail appears in the video keyframe editor.

## Mode

This specifies the playback mode. There are three modes; each one has a specific behaviour that is useful for a different situation.

### Normal

When the play cursor stops, the video will also stop and the frame number will lock to the timeline position. When the cursor continues to play or holds at the end of a section, the video will play continuously. Jumping around the timeline while playing does not affect which frame is being played.

### Locked

If the play cursor continues to play or stops at the end of a section, the video frame number locks to the timeline. When the play cursor holds at the end of a section, the video will play continuously.

## Freerun

If the play cursor continues to play or stops at the end of a section, the video will play continuously. Jumping around the timeline while the cursor is playing or has stopped does not affect which frame is being played.

## At end point

This specifies what happens when playback reaches the end of the video clip. There are three options to choose from:

### Loop

When playback reaches the end of the video clip, the clip will loop immediately back to the beginning and will start playing again from there.

### Ping-pong

When playback reaches the end of the video clip, the clip will play in reverse back to the beginning.

### Pause

When playback reaches the end of the video clip, the clip will pause on the last frame.

## Transition time

The transition property specifies the dissolve time, in beats, when switching from one video clip to the next on the timeline. By default, this is set to 0, so the player cuts immediately from one clip to the next. Setting this value to 1 causes the player to dissolve from one clip to the next over 1 beat.

## Volume

Some video clips may contain audio. You can fill in any number between 0 (mute) and 255 (full) in the text field to set a constant volume, or open the property's key-frame editor to fade volume in or out.

## Output

If the video has an audio track, this controls which audio output device the audio is played to.

## Threshold

The threshold of the keying. Colours closer than (threshold) to the key colour become transparent.

## Hardness

The hardness of the keying. Lower numbers produce softer edges and higher numbers produce harder edges between transparent and opaque areas.

## Key color RGB

The value of the key colour, 0 255, causing the key colour to become transparent.

## Scale

Controls the size of the video

## Aspect

Controls the aspect ration of the video, higher numbers make the frame taller.

## Pos x y

Position of the video; x = horizontal position, y = vertical position. 0 = centre of canvas, -1 = top edge of canvas, +1 = bottom edge

# Rotation

Rotation (in degrees) of the video.

# Crop left, right, top, bottom

Crops the frame from the respective edge. 0 = no crop, 1 = entire frame crop.

# Vignette

Adds a vignette effect by softening the edges of the crop.



# RenderStream

RenderStream is the proprietary disguise protocol for controlling third party render engines from Disguise software.

## Overview

RenderStream allows for the sequencing and sharing of content from a third party render engine to Disguise software, much like how Notch works onboard a gx, albeit running on the rx, our proprietary external render node.

This topic is intended to outline the basic steps involved in configuring RenderStream for use with Unreal Engine, Unity, and Notch. Once the configuration steps explained here are complete, sequencing of the third party render engine can be accomplished via the RenderStream Layer within Disguise software..

## Uncompressed vs. Compressed

RenderStream Uncompressed requires the use of a 25G Mellanox network interface to stream uncompressed, 10bit video data. To test RenderStream Uncompressed appropriately, access to multiple machines and the networking equipment specified is required. Testing RenderStream Uncompressed also requires both a RenderStream Send License and a RenderStream Uncompressed License.

RenderStream Compressed provides consistent content quality with advanced H.265 compression. You can now choose high frequency compression, and ensure that even the finest details of your content are shown via our superior, reliable networking.

# Plugins

In order to communicate with disguise, both Unreal Engine and Unity require the installation of a plugin on the render node. Visit the [disguise Github](#) for the latest plugins.

## Cluster Rendering



**Warning:** For cluster rendering it's recommended to use render nodes from the same disguise product range, e.g. all rx series machines. Mixing of machines from different product ranges is not recommended and is unsupported. It is acceptable to mix rx and rxII types however.

Here are just some of the benefits of using Cluster Rendering:

1. Cluster Rendering allows you to span your render engine content over more than one Disguise server by scaling out real-time content up to an unlimited capacity.
2. Each machine will let you render a fragment of your final content frame to increase the render power and get your content onto your displays at your desired quality.
3. Use Cluster Rendering to render real-time content of the highest quality, detail and framerate without worrying about GPU power.

Cluster Rendering is configured within Disguise software using the [RenderStream Layer](#).

# Video Trigger

The Video layer works in the same way to the Legacy video layer with the main exceptions being that this layer does not support Audio playback, and does not have a playmode, at end point and transition time property.

## Preview Thumbnail

This property is a small preview window at the top of the editor showing you what the layer output looks like.



# Blend Mode

BlendMode controls how the output of the layer is composited with the layers below. Layers are rendered in a bottom-up order: layers at the top can modify the output of the layers below.

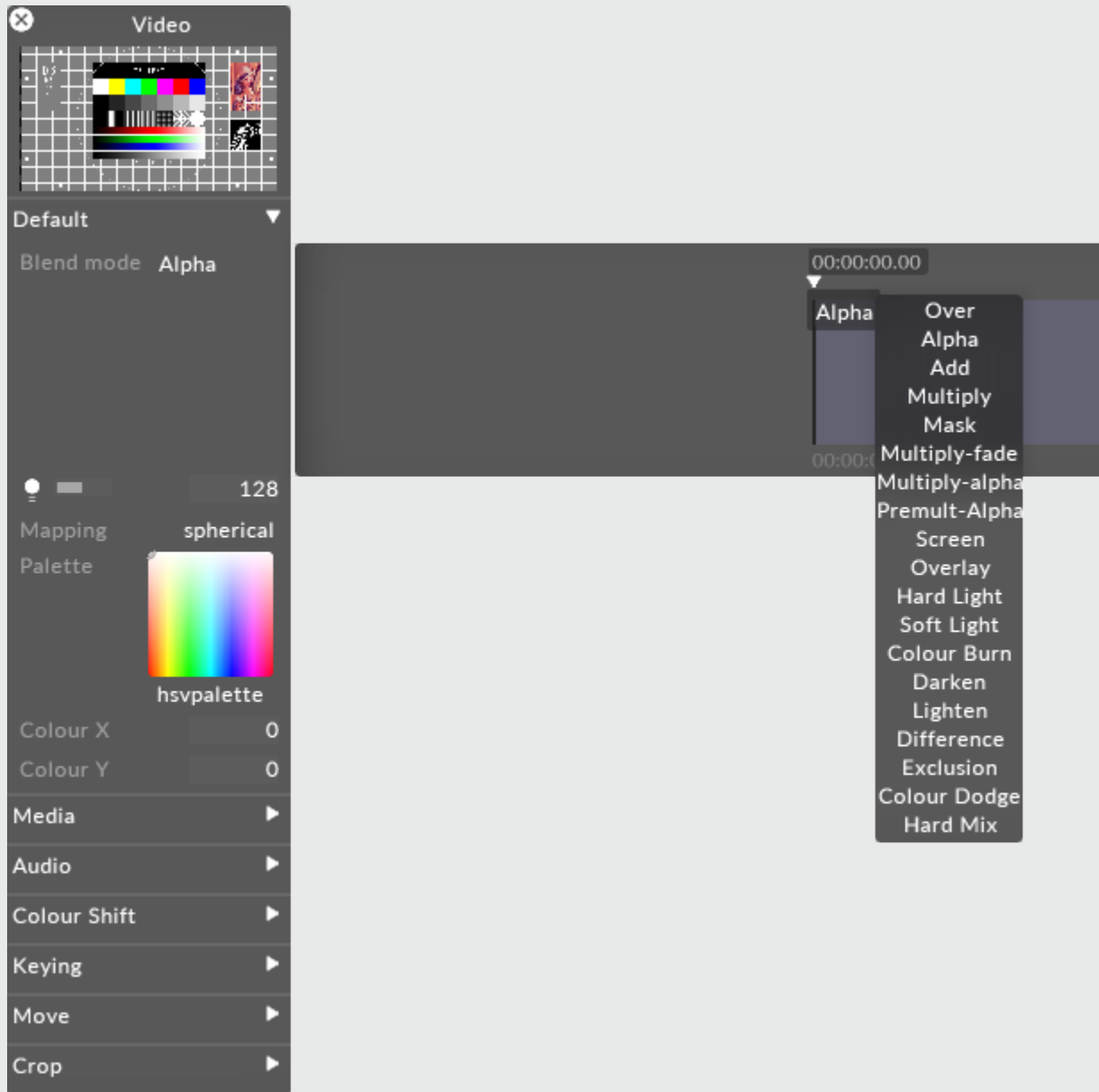

Changing brightness of a content layer in Disguise software is actually controlling the value of the alpha of the layer. Even when displaying a HAP video, the software will composite the layer with a controllable layer of alpha - one per layer.

There are two ways of expressing alpha in an image:

Straight alpha is an alpha channel which functions just like RGB. Alpha acts as a fourth channel of information per pixel which is as independent of the other three as R, G and B are of each other. For example, with straight alpha it is possible to have RGB = 255 (white) and alpha = 0 (fully transparent) on the same pixel. Internally generated content, such as gradient layer, are generated with straight alpha. This is the preferable style of alpha and considering the cleaner method of the two.

Premultiplied alpha takes the alpha and applies it to the values of the RGB channels per pixel. The more transparent something gets with premultiplied alpha, the closer it gets to black - as if the content is sitting on a black table. Premultiplied is the default output of Adobe Photoshop or AfterEffects. the result is our pixel at 255 RGB (full white) with 0 alpha would be calculated as a black pixel in the final image.

Here are explanations of what each individual blend mode will do.

## Over

Makes a layer fully opaque. Premultiplies all alpha onto the RGB value of each pixel. Alpha = black, so adjusting the brightness of a layer in Over blend mode makes it darker.

## Alpha

Default blend mode. It will apply alpha values as a transparency if the alpha is present. Brightness changes will make the layer more or less transparent.

## Add

Adds the value of each RGB pixel together. Always creates a brighter result. Values clamp at 255.

## Multiply

Reads the level of each subpixel as a level between 0.0 and 1.0, and multiplies source with blend. The result is always a darker image overall. For example: white x grey = 0.5. White turns transparent, black takes precedence. Alpha is applied in the same fashion as the Over Blend mode.

## Mask

Choose mask when you want to multiple out content upwards in the stack of layers, rather than downwards. In order to make this work you have to use the same mapping on the layer set to mask and the layer on top.

## Multiply-Fade

The same as Multiply, but will make use of the alpha channel to calculate transparency in the source and blend layers. Since maximum transparency is premultiplied, alpha results in black. This will ignore black created through premultiplying.

## Multiply-Alpha

Multiply with straight alpha. This mode assumes that the alpha has not been premultiplied onto the RGB values and will not apply a correction to the semi-transparent pixels.

## Premultiply Alpha

Like how Multiply-fade will ignore the darkening caused by premultiplying, this blend mode will do the same with Alpha.

## Colour Burn

Blend mode increases the contrast to darken the base colour while reflecting the blend colour. The darker the blend colour, the more intensely the colour will be applied in the base image. White as the blend colour produces no change. Using the colour burn blend mode can produce some harsh results at full opacity.

The colour burn blend mode can be used to make tonal and colour adjustments to a layer.

## Screen

This blend mode looks at each channels colour information and multiplies the inverse of the blend and base colour. The result is always a lighter colour. Screening with black leaves the colour unchanged. Screening with white produces white. The effect is similar to projecting multiple images on top of each other - where bright white is fully opaque, black is fully transparent and 50% grey is 50% transparent.

## Overlay

Multiplies or screens the colours, depending on the base colour. Patterns or colours overlay the existing pixels while preserving the highlights and shadows of the base colour. The base colour is not replaced, but mixed with the blend colour to reflect the lightness or darkness of the original colour.

## Hard Light

Multiplies or screens the colours, depending on the blend colour. The effect is similar to shining a harsh spotlight on the image. If the blend colour (light source/top layer) is lighter than 50% grey, the image is lightened as if it were screened. This is useful for adding highlights to an image. If the blend colour is darker than 50% grey, the image is darkened as if it were multiplied. This is useful for adding shadows to an image. Painting with pure black or white results in pure black or white.

## Soft Light

Darkens or lightens the colours, depending on the blend colour. The effect is similar to shining a diffused spotlight on the image. If the blend colour (light source/top layer) is lighter than 50% grey, the image is lightened as if it were dodged. If the blend colour is darker than 50% grey, the image is darkened as if it were burned in. Painting with pure black or white produces a distinctly darker or lighter area, but does not result in pure black or white.

## Darken

Looks at the colour information in each channel and selects the base or blend colour - whichever is darker - as the result colour. Pixels lighter than the blend colour are replaced and pixels darker than the blend colour do not change.

## Lighten

Looks at the colour information in each channel and selects the base or blend colour - whichever is lighter - as the result colour. Pixels darker than the blend colour are replaced and pixels lighter than the blend colour do not change.

## Difference

Looks at the colour information in each channel and subtracts either the blend colour from the base colour or the base colour from the blend colour depending on which has the greater brightness value.



Blending with white inverts the base colour values and blending with black produces no change.

## Exclusion

Creates an effects similar to but lower in contrast than the difference mode. Blending with white inverts the base colour values. Blending with black produces no change.

## Colour Dodge

Looks at the colour information in each channel and brightens the base colour to reflect the blend colour by decreasing contrast between the two. Blending with black produces no change.

## Hard Mix

Adds the RGB channels of the blend colour to the RGB values of the base colour. If the resulting sum for a channel is 255 or greater, it receives a value of 255; if it is less than 255 it receives a value of 0. Therefore all blended pixels have RGB channels of either 0 or 255. This changes all pixels to primary additive colours (RGB), white or black.

## Brightness

This property (which appears as a light bulb icon) controls the brightness of the layer output.

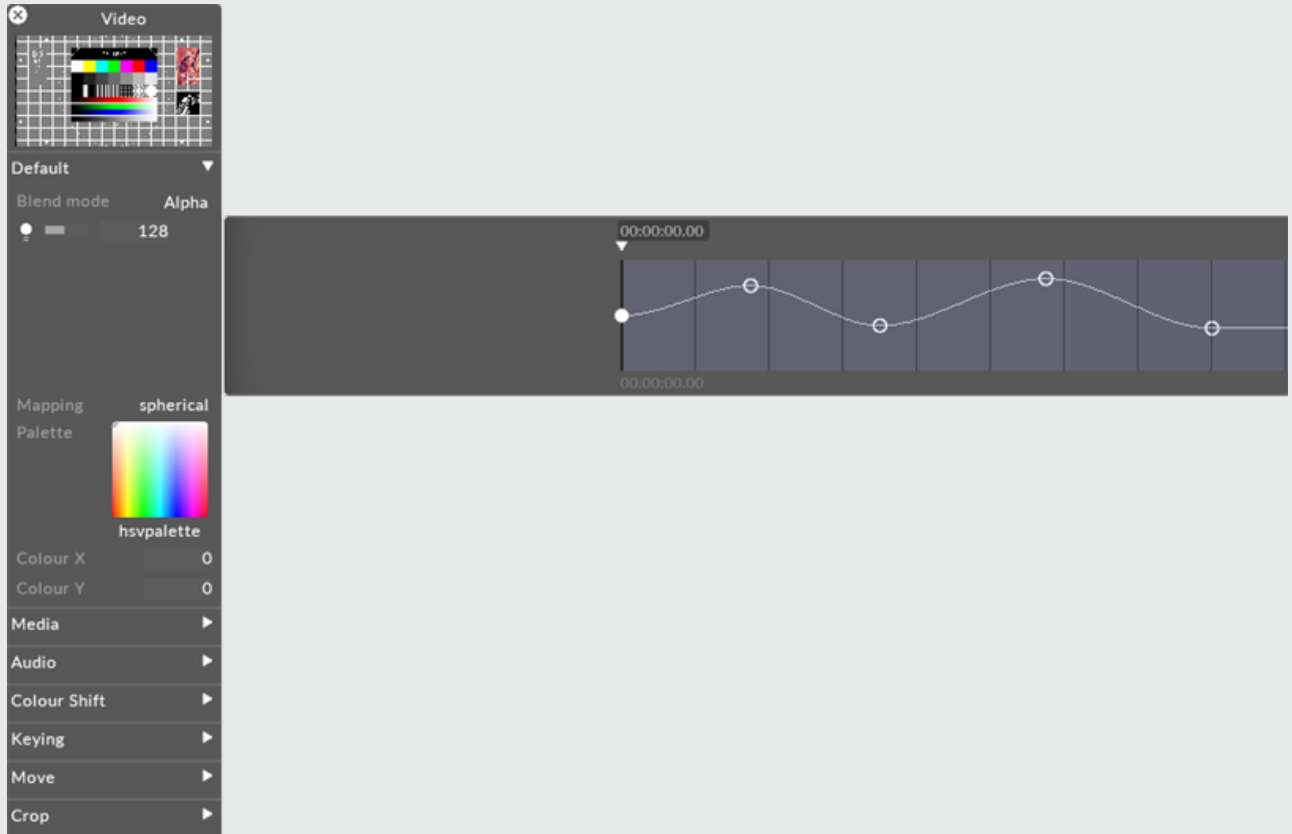

If the layers blend mode is set to Alpha, then reducing the brightness to 0 also reduces the opacity of the layer to 0. This can be useful when you want to dissolve from one layer to the next. In that case, you can place the new layer above the old layer and increase its brightness level.

## Mapping

The mapping property controls how the layer output is mapped onto the screen(s) in the Stage level.

**Video**

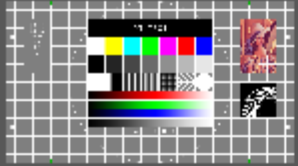

Default ▾

Blend mode Alpha

128

Mapping direct map 1

Palette



hsvpalette

Colour X 0

Colour Y 0

Media ▾

Video



d3\_test\_16-9.png

Speed 1

Mode Normal

At end point Loop

Transition time 0

Audio ▶

Colour Shift ▶

Keying ▶

Move ▶

Crop ▶



00:00:00.00

direct map 1

00:00:00.00

**mappings**

New mapping: OK Search:

all New Mappings

- direct map 1
- feed map 2
- feed mapping
- mapping 1
- mapping 2
- parallel
- spherical

For information on mapping, including how to use the different mapping types offered by Disguise software, please see the chapter [Content Mapping](#).

## Palette

This points to the still image file that defines the bitmap from which the tint colour is taken. The default palette ( HSVPAL ) consists of the complete range of hues and saturations. Selecting this property will open the Texture object library, which shows all of the still image files saved on your local hard-drive in the **DxTexture** folder.

To control the location within the current palette bitmap, and thus control the colour, you have to edit the **xCol** and **yCol** values (see the section for xCol, yCol).

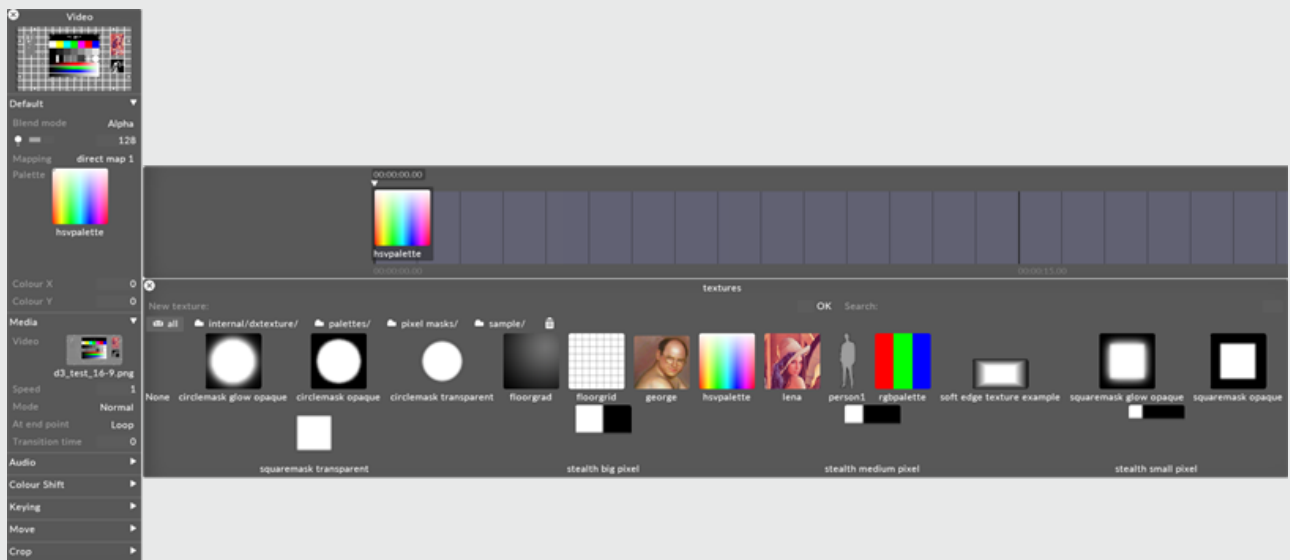

To change the current palette bitmap:

1. Left-click **palette** to open the Texture object library.
2. Left-click the still image file you want to use for the palette bitmap.

If you want to use a palette bitmap other than the standard still images provided in Disguise software, you will need to use a custom still image file.

See the [Placing media files for a project](#) sub-chapter to understand where to place a custom still image file and how to access it in Disguise software. Also save the file to a [supported file format](#).

## xCol, yCol

These properties control the coordinates within the current palette bitmap where the output colour is sampled from. The default value is 0,0 which points at the color white (if you are using the HSVPAL palette). Multiplying white with the colors of the chosen content simply generates the original content colors. **Colour X** controls the horizontal position, where 0 is the leftmost edge and 255 is the rightmost edge. **Colour Y** controls the vertical position, where 0 is the top edge and 255 is the bottom edge.

For example, to saturate the video clip red, change the **Colour Y** value to 255 and use 0 for the **Colour X** value. These coordinates refer to the color red in the palette which is being multiplied with the colors of the existing content.

When you are using the default palette HSVPAL , **Colour Y** controls saturation, and **Colour X** controls hue.

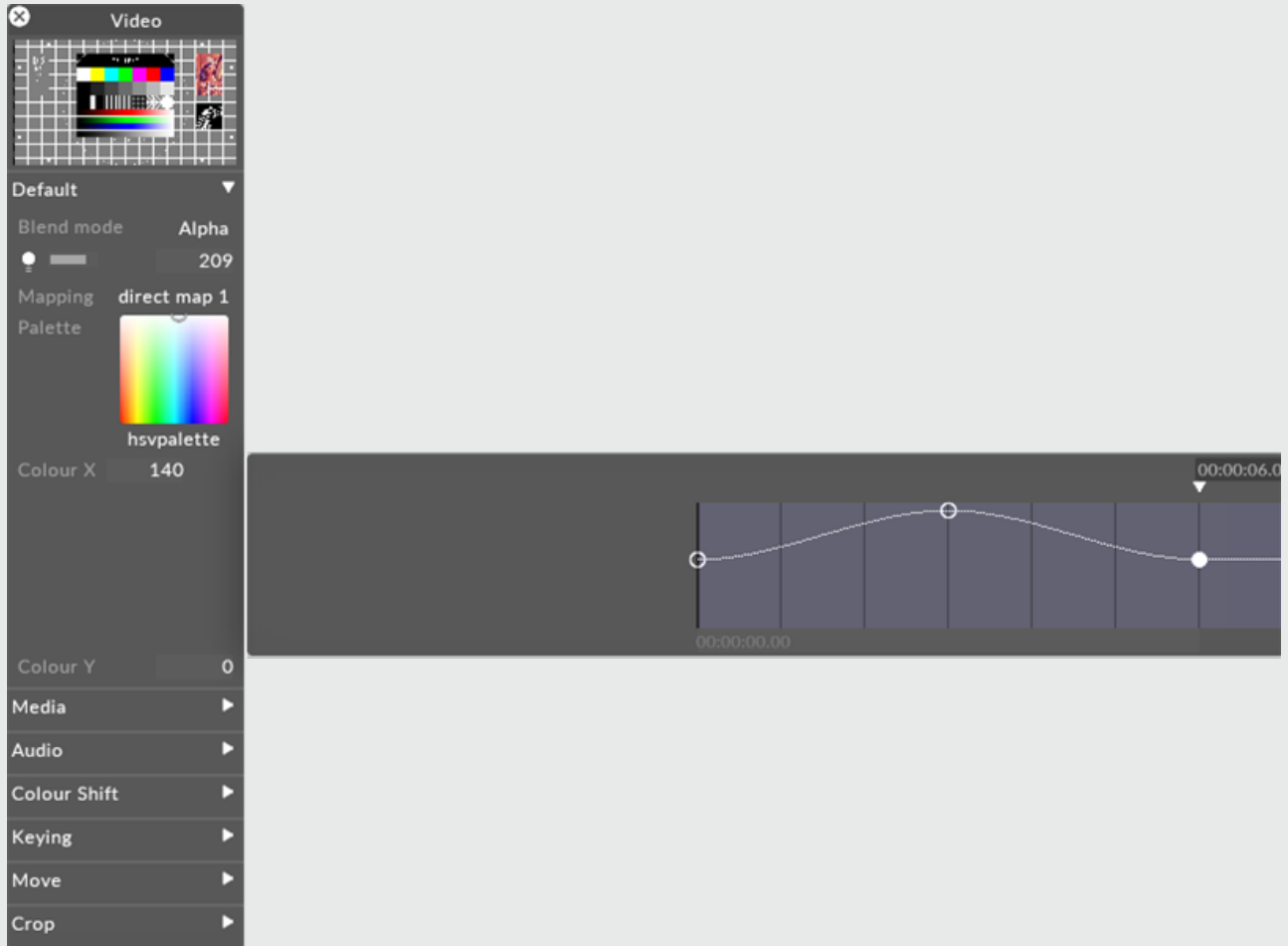

## Colour Shift

The colour shift property allows you to perform a number of colour-correction operations on the output of a layer.

Colour Shift objects can also be attached to individual video files within the Video layer.

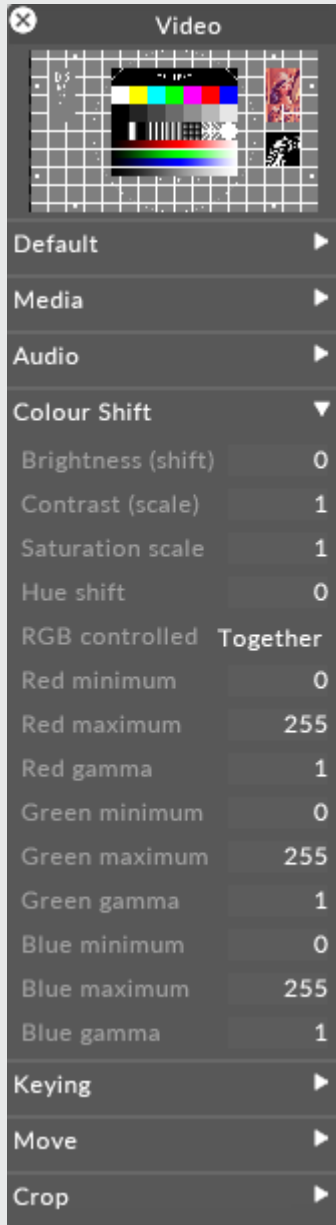

Colour Shift property performs colour-corrections on the output of a visual layer

Colour Shift properties are:

# Saturation scale

When set to 1, no change is applied to the image. When set to 0, the image is desaturated to black and white. When set higher than 1, the image is hypersaturated.

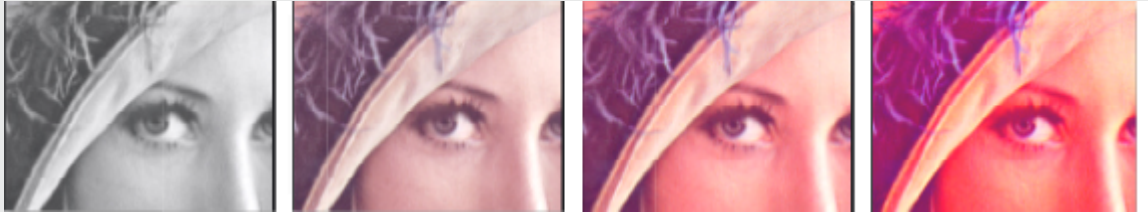

Saturation scale (from left to right):  $s=0$ ,  $s=0.5$ ,  $s=1$ ,  $s=2$

# Hue shift

## RGB controlled

This property controls how the min/max levels and gamma corrections are applied. If set to *together*, then the min, max and gamma values are the same for the red, green and blue channels. If set to *separate*, the min,max and gamma values can be controlled separately for red, green and blue. The latter setting allows you to apply fine colour balance controls to the image.

## Min

This sets the lowest brightness level found in the image. All pixels at this level are scaled down to zero brightness. Increasing this value enforces shadows and dark levels in the image and can be used to reduce low-level compression artifacts in an image or video frame.

Increasing *min* equally across red, green and blue enforces shadows, whereas increasing *min* on an individual channel has the effect of shifting the colour balance away from that colour. For example, increasing *red min* shifts the image towards cyan.



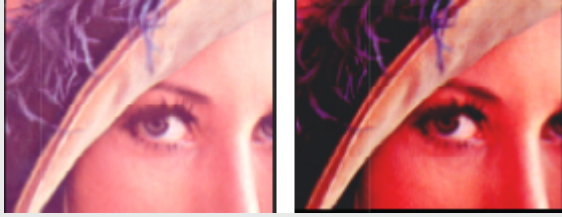

min = 00 (left), min = 96 (right)

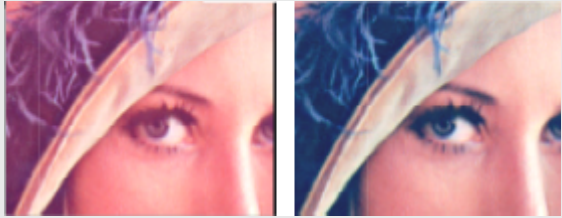

red.min = 0 (left), red.min = 96 (right)

## Max

This sets the highest brightness level found in the image. All pixels at this level are scaled up to the maximum level, i.e. 255. Decreasing this value brightens any highlights in the image. This is useful when the source image is too dark.

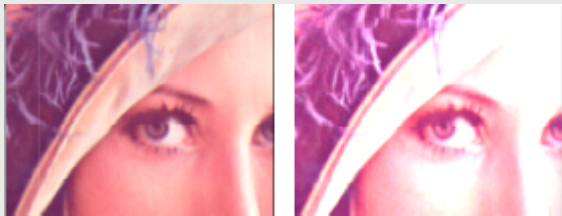

max = 255 (left), max = 260 (right)

If you set min to 255 and max to 0, the image (or single channel) will be inverted.

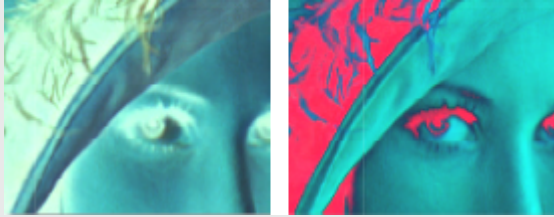

Invert all (left), invert red (right)

## Gamma

When *gamma* is set to 1, no change is made to the image. Reducing gamma brightens highlights while increasing gamma darkens lowlights. The maximum and minimum brightness levels remain the same.

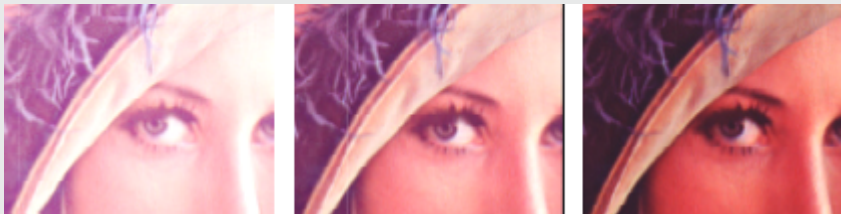

Gamma scale (from left to right):  $g=0.5$ ,  $g=1$ ,  $g=1.5$

## Media

## Trigger

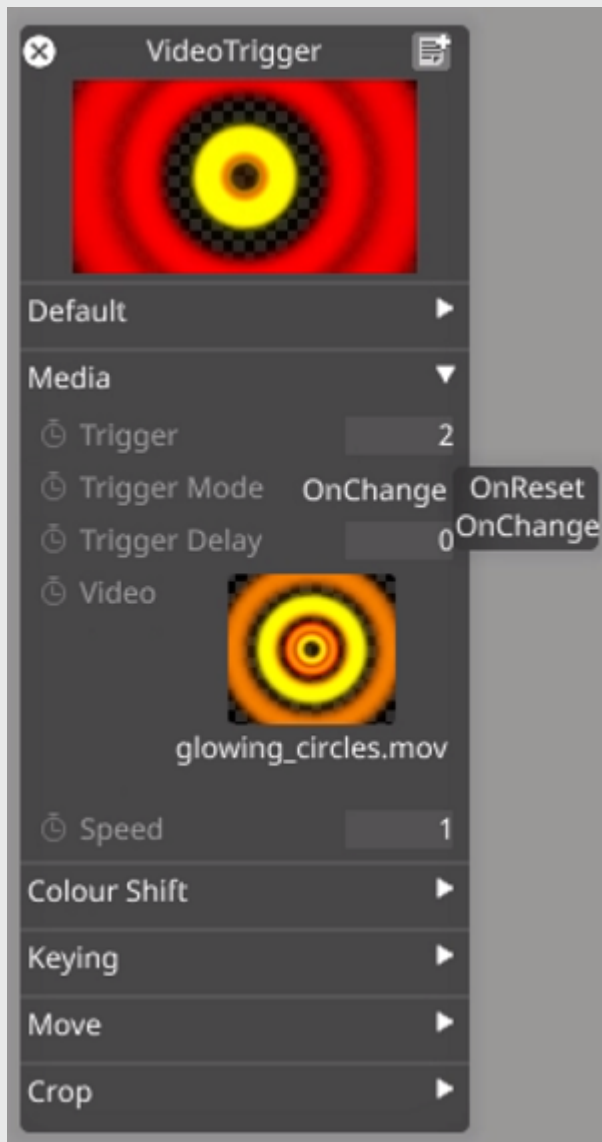

The trigger property allows for a video file to be triggered for playback either when a value changes from 0-1 (or 255 if using a DMX lighting console) (OnReset), or changing to another value (OnChange).

OnReset will cause the video file to playback once before returning to no content being shown. If you wish to trigger the file again, the trigger value needs to be reset to 0 before another value of 1 can be sent.

OnChange will cause the video file to playback when the trigger value changes to a new value.

Trigger Delay time can be added to delay the start of the video until a specific frame count.

## Video

The Video property points to the still media file that defines the content to be used on the layer. Selecting this property will open the VideoClip object library, which shows all of the still image files saved on your local hard-drive in the **VideoFile** folder.

To change the current piece of content:

1. Left-click **Video** to open the VideoClip object library.
2. Left-click the media file you want to use.

See the [Placing media files for a project](#) sub-chapter to understand where to place your content and how to access it in Disguise software. Also save the file to a [supported file format](#).

## Speed

Selects playback speed. When this is set to 1, the video is played at its normal framerate; when set to 2, the video is played at double speed, when set to -1, the video is played at normal framerate in reverse and so on.

## Colour Shift

Colour management controls for the Video trigger layer.

## Keying

The threshold of the keying. Colours closer than (threshold) to the key colour become transparent.

## Hardness

The hardness of the keying. Lower numbers produce softer edges and higher numbers produce harder edges between transparent and opaque areas.

## Key colour rgb

The value of the key colour, 0 255, causing the key colour to become transparent.

## Size

Controls the size of the video.

## Scale x, y

Controls the aspect ratio of the video, higher numbers make the frame taller.

## Pos x,y

Position of the video; x = horizontal position, y = vertical position. 0 = centre of canvas, -1 = top edge of canvas, +1 = bottom edge

## Rotation

Rotation (in degrees) of the video.

## Crop left, right, top, bottom

Crops the frame from the respective edge. 0 = no crop, 1 = entire frame crop.

# VirtualLineup

The VirtualLineup layer is used to line up the virtual world to a test pattern that is simultaneously displayed on the LED walls of an mR set.

## Workflow

- Create a new VirtualLineup layer
- Assign the layer to the mr set (spatial mapping)

✕
VirtualLineup

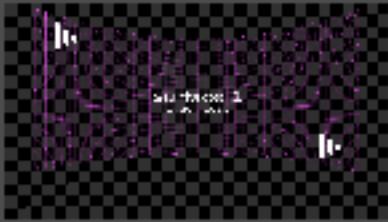

Default ▾

1.0

Mapping mrset1 (spatial)

Palette 

hsvpalette

Colour X

Colour Y

Circles Yes

Circle radius

Label Yes

Grid mode Lines

Grid spacing

Sub grid spacing

Logo top left 

d3logotransparent

Logo bottom right 

d3logotransparent

## VirtualLineup common layer properties

The Virtual Lineup layer has the following common properties:

- Brightness
- Mapping
- Palette
- Colour X
- Colour Y

## VirtualLineup layer properties

The Virtual Lineup layer has the following additional properties:

- Circles
- Circles Radius
- Label
- Grid mode
- Grid spacing
- Sub grid spacing
- Logo top left
- Logo top right



# Web

The Web layer provides the ability to render HTML5 webpages as content in Disguise software. However, Disguise goes further and allows you to 'hook' and integrate your web pages to the time.

## Key features of the Web layer

- Bookmarks for navigation (with thumbnails)
- Ability to send 'Javascript Commands' to the open web page (see field called Command) – i.e. `PageTransitions.nextPage(2, 1)`
- Ability to send 5 custom timeline float values into the page via JavaScript. Provides the ability to animate items in your web page in sequence with the timeline, or change font sizes.
- Ability to send various standard timeline clock information into the page via JavaScript
- Support for transparent background pages. E.g. `body { background-color: rgba(0, 0, 0, 0); }`, hence allowing you to composite items into Disguise (like a twitter feed).
- Support for simple user interaction with the page from Disguise software3 (see the 'Interact' button at the top of the Web Layer).
- Locally hosted HTML5 pages

## Browser feature support

The browser has the following attributes:

- Utilises software renderer (as Disguise software has exclusive lock of the GPU)
- Browsers are 'sand boxed' in separate processes to prevent negative impact on Disguise software
- Supports HTML5
- Utilises WebKit -> Based off Chromium (check "about:version" URL for exact version using this path: Interact → URL: "about:version" → go)
- Adobe Flash is not supported, but the system is capable of running limited Flash Plugin functionality. Flash must be installed independently on the machine in question.
- WebGL is not supported
- three.js and other libraries that utilise hardware GPU rendering are not supported



**Warning:** Layer instances reset every time universal crossfade is triggered. This means that web layers will fade out/into themselves even if the same page is used across sections.

## Preview Thumbnail

This property is a small preview window at the top of the editor showing you what the layer output looks like.



## Blend Mode

BlendMode controls how the output of the layer is composited with the layers below. Layers are rendered in a bottom-up order: layers at the top can modify the output of the layers below.

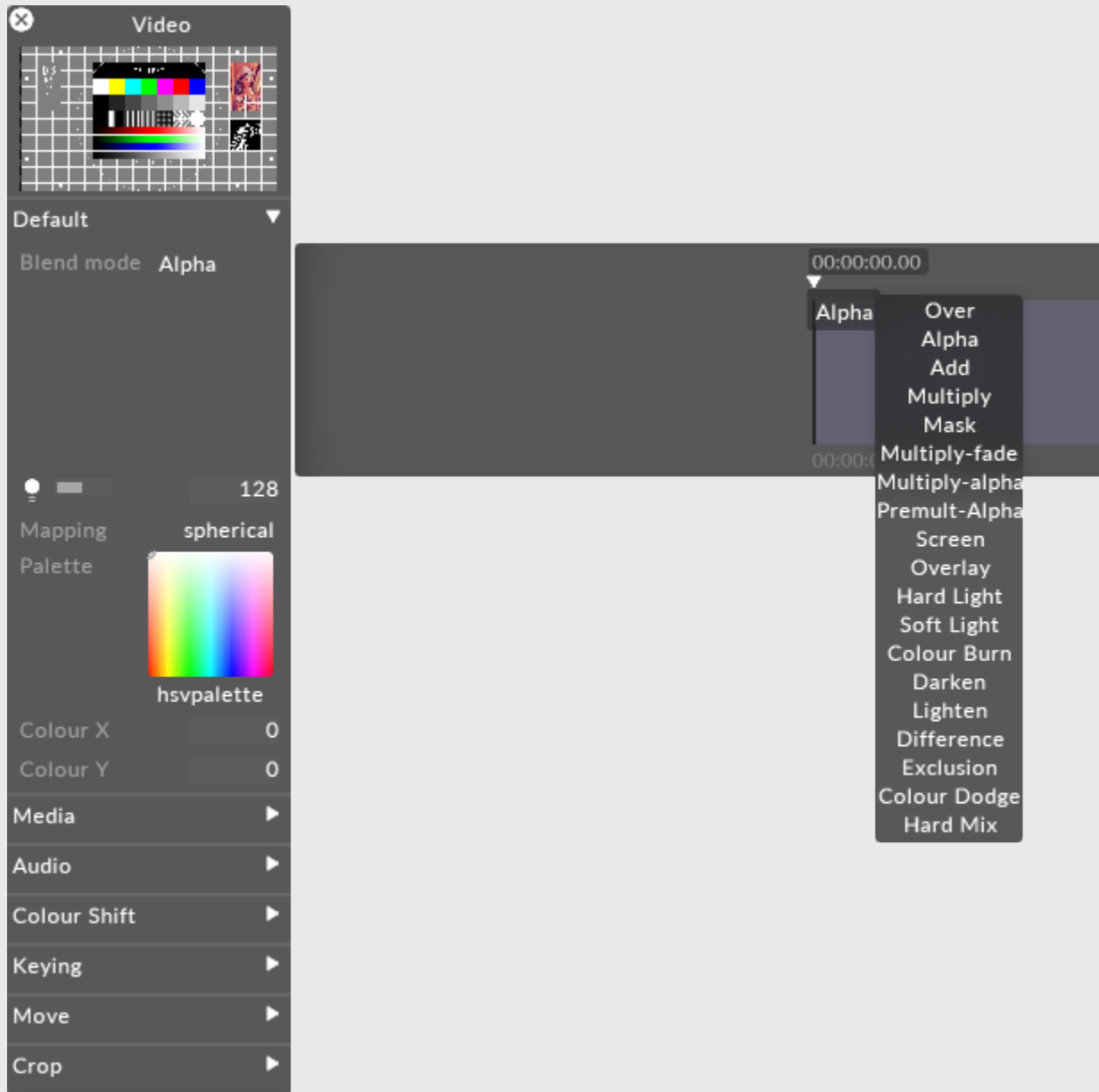

Changing brightness of a content layer in Disguise software is actually controlling the value of the alpha of the layer. Even when displaying a HAP video, the software will composite the layer with a controllable layer of alpha - one per layer.

There are two ways of expressing alpha in an image:

Straight alpha is an alpha channel which functions just like RGB. Alpha acts as a fourth channel of information per pixel which is as independent of the other three as R, G and B are of each other. For example, with straight alpha it is possible to have RGB = 255 (white) and alpha = 0 (fully transparent) on the same pixel. Internally generated content, such as gradient layer, are generated with straight alpha. This is the preferable style of alpha and considering the cleaner method of the two.

Premultiplied alpha takes the alpha and applies it to the values of the RGB channels per pixel. The more transparent something gets with premultiplied alpha, the closer it gets to black - as if the content is sitting on a black table. Premultiplied is the default output of Adobe Photoshop or AfterEffects. The result is our pixel at 255 RGB (full white) with 0 alpha would be calculated as a black pixel in the final image.

Here are explanations of what each individual blend mode will do.

## Over

Makes a layer fully opaque. Premultiplies all alpha onto the RGB value of each pixel. Alpha = black, so adjusting the brightness of a layer in Over blend mode makes it darker.

## Alpha

Default blend mode. It will apply alpha values as a transparency if the alpha is present. Brightness changes will make the layer more or less transparent.

## Add

Adds the value of each RGB pixel together. Always creates a brighter result. Values clamp at 255.

## Multiply

Reads the level of each subpixel as a level between 0.0 and 1.0, and multiplies source with blend. The result is always a darker image overall. For example: white x grey = 0.5. White turns transparent, black takes precedence. Alpha is applied in the same fashion as the Over Blend mode.

## Mask

Choose mask when you want to multiple out content upwards in the stack of layers, rather than downwards. In order to make this work you have to use the same mapping on the layer set to mask and the layer on top.

## Multiply-Fade

The same as Multiply, but will make use of the alpha channel to calculate transparency in the source and blend layers. Since maximum transparency is premultiplied, alpha results in black. This will ignore black created through premultiplying.

## Multiply-Alpha

Multiply with straight alpha. This mode assumes that the alpha has not been premultiplied onto the RGB values and will not apply a correction to the semi-transparent pixels.

## Premultiply Alpha

Like how Multiply-fade will ignore the darkening caused by premultiplying, this blend mode will do the same with Alpha.

## Colour Burn

Blend mode increases the contrast to darken the base colour while reflecting the blend colour. The darker the blend colour, the more intensely the colour will be applied in the base image. White as the blend colour produces no change. Using the colour burn blend mode can produce some harsh results at full opacity.

The colour burn blend mode can be used to make tonal and colour adjustments to a layer.

## Screen

This blend mode looks at each channels colour information and multiplies the inverse of the blend and base colour. The result is always a lighter colour. Screening with black leaves the colour unchanged. Screening with white produces white. The effect is similar to projecting multiple images on top of each other - where bright white is fully opaque, black is fully transparent and 50% grey is 50% transparent.

## Overlay

Multiplies or screens the colours, depending on the base colour. Patterns or colours overlay the existing pixels while preserving the highlights and shadows of the base colour. The base colour is not replaced, but mixed with the blend colour to reflect the lightness or darkness of the original colour.

## Hard Light

Multiplies or screens the colours, depending on the blend colour. The effect is similar to shining a harsh spotlight on the image. If the blend colour (light source/top layer) is lighter than 50% grey, the image is lightened as if it were screened. This is useful for adding highlights to an image. If the blend colour is darker than 50% grey, the image is darkened as if it were multiplied. This is useful for adding shadows to an image. Painting with pure black or white results in pure black or white.

## Soft Light

Darkens or lightens the colours, depending on the blend colour. The effect is similar to shining a diffused spotlight on the image. If the blend colour (light source/top layer) is lighter than 50% grey, the image is lightened as if it were dodged. If the blend colour is darker than 50% grey, the image is darkened as if it were burned in. Painting with pure black or white produces a distinctly darker or lighter area, but does not result in pure black or white.

## Darken

Looks at the colour information in each channel and selects the base or blend colour - whichever is darker - as the result colour. Pixels lighter than the blend colour are replaced and pixels darker than the blend colour do not change.

## Lighten

Looks at the colour information in each channel and selects the base or blend colour - whichever is lighter - as the result colour. Pixels darker than the blend colour are replaced and pixels lighter than the blend colour do not change.

## Difference

Looks at the colour information in each channel and subtracts either the blend colour from the base colour or the base colour from the blend colour depending on which has the greater brightness value.

Blending with white inverts the base colour values and blending with black produces no change.

## Exclusion

Creates an effects similar to but lower in contrast than the difference mode. Blending with white inverts the base colour values. Blending with black produces no change.

## Colour Dodge

Looks at the colour information in each channel and brightens the base colour to reflect the blend colour by decreasing contrast between the two. Blending with black produces no change.

## Hard Mix

Adds the RGB channels of the blend colour to the RGB values of the base colour. If the resulting sum for a channel is 255 or greater, it receives a value of 255; if it is less than 255 it receives a value of 0. Therefore all blended pixels have RGB channels of either 0 or 255. This changes all pixels to primary additive colours (RGB), white or black.

## Brightness

This property (which appears as a light bulb icon) controls the brightness of the layer output.



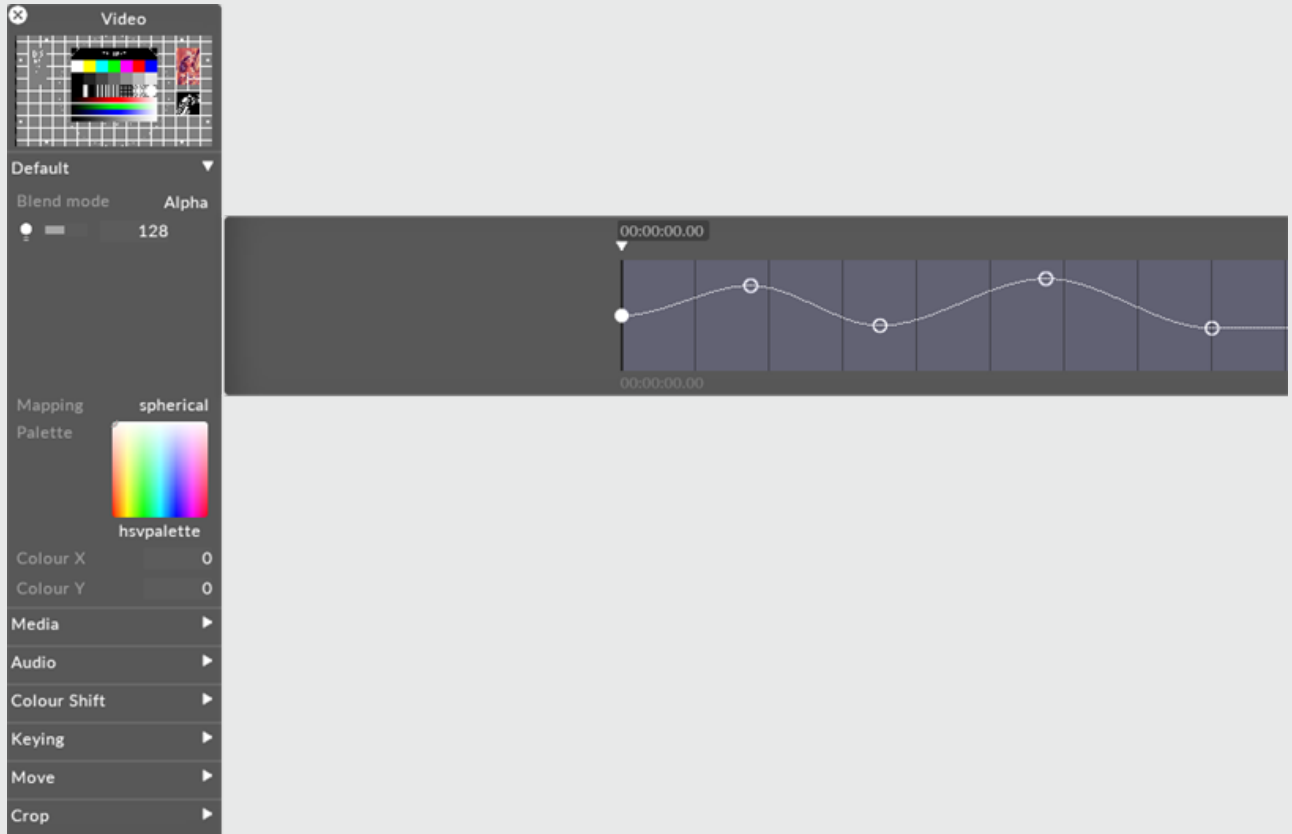

If the layers blend mode is set to Alpha, then reducing the brightness to 0 also reduces the opacity of the layer to 0. This can be useful when you want to dissolve from one layer to the next. In that case, you can place the new layer above the old layer and increase its brightness level.

## Mapping

The mapping property controls how the layer output is mapped onto the screen(s) in the Stage level.

**Video**

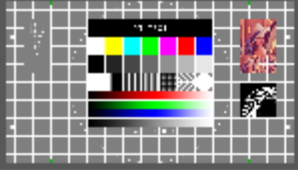

Default ▾

Blend mode Alpha

128

Mapping direct map 1

Palette



hsvpalette

Colour X 0

Colour Y 0

Media ▾

Video



d3\_test\_16-9.png

Speed 1

Mode Normal

At end point Loop

Transition time 0

Audio ▶

Colour Shift ▶

Keying ▶

Move ▶

Crop ▶

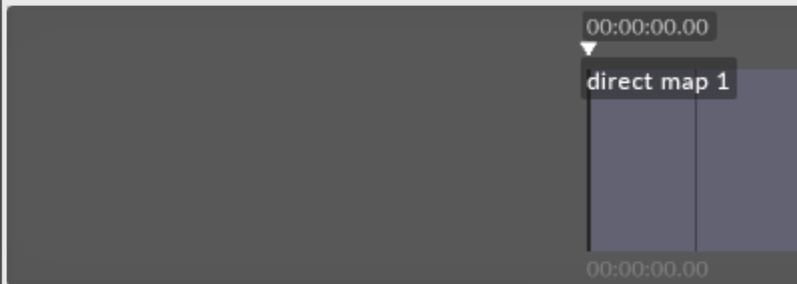

**mappings**

New mapping: OK Search:

all New Mappings

- direct map 1
- feed map 2
- feed mapping
- mapping 1
- mapping 2
- parallel
- spherical

For information on mapping, including how to use the different mapping types offered by Disguise software, please see the chapter [Content Mapping](#).

## Palette

This points to the still image file that defines the bitmap from which the tint colour is taken. The default palette ( HSVPAL ) consists of the complete range of hues and saturations. Selecting this property will open the Texture object library, which shows all of the still image files saved on your local hard-drive in the **DxTexture** folder.

To control the location within the current palette bitmap, and thus control the colour, you have to edit the **xCol** and **yCol** values (see the section for xCol, yCol).

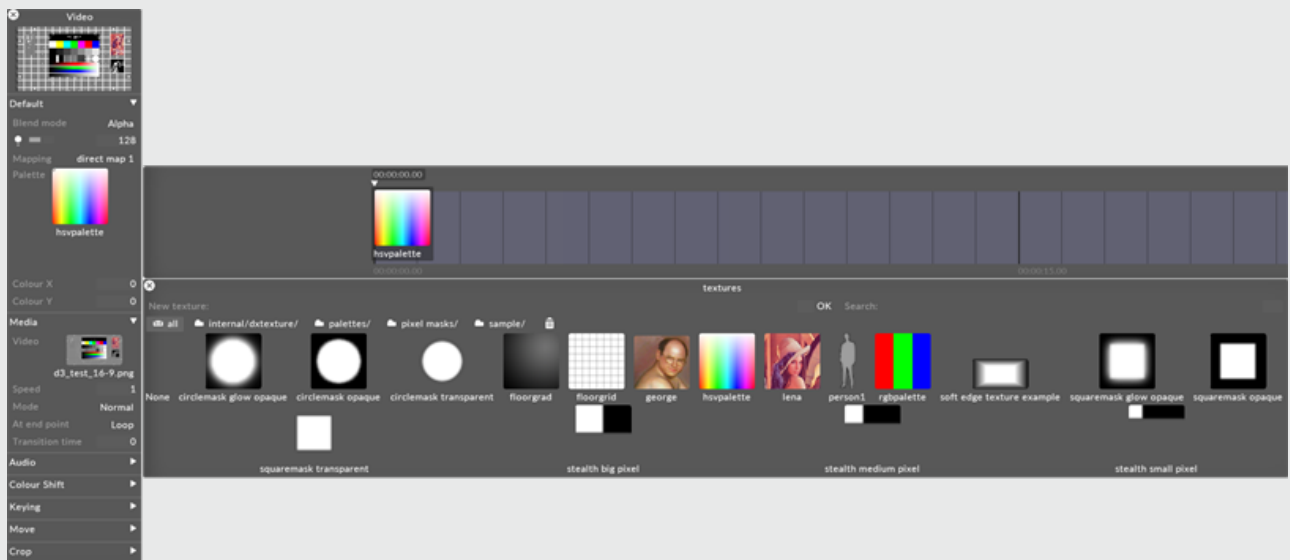

To change the current palette bitmap:

1. Left-click **palette** to open the Texture object library.
2. Left-click the still image file you want to use for the palette bitmap.

If you want to use a palette bitmap other than the standard still images provided in Disguise software, you will need to use a custom still image file.

See the [Placing media files for a project](#) sub-chapter to understand where to place a custom still image file and how to access it in Disguise software. Also save the file to a [supported file format](#).

## xCol, yCol

These properties control the coordinates within the current palette bitmap where the output colour is sampled from. The default value is 0,0 which points at the color white (if you are using the HSVPAL palette). Multiplying white with the colors of the chosen content simply generates the original content colors. **Colour X** controls the horizontal position, where 0 is the leftmost edge and 255 is the rightmost edge. **Colour Y** controls the vertical position, where 0 is the top edge and 255 is the bottom edge.

For example, to saturate the video clip red, change the **Colour Y** value to 255 and use 0 for the **Colour X** value. These coordinates refer to the color red in the palette which is being multiplied with the colors of the existing content.

When you are using the default palette HSVPAL , **Colour Y** controls saturation, and **Colour X** controls hue.

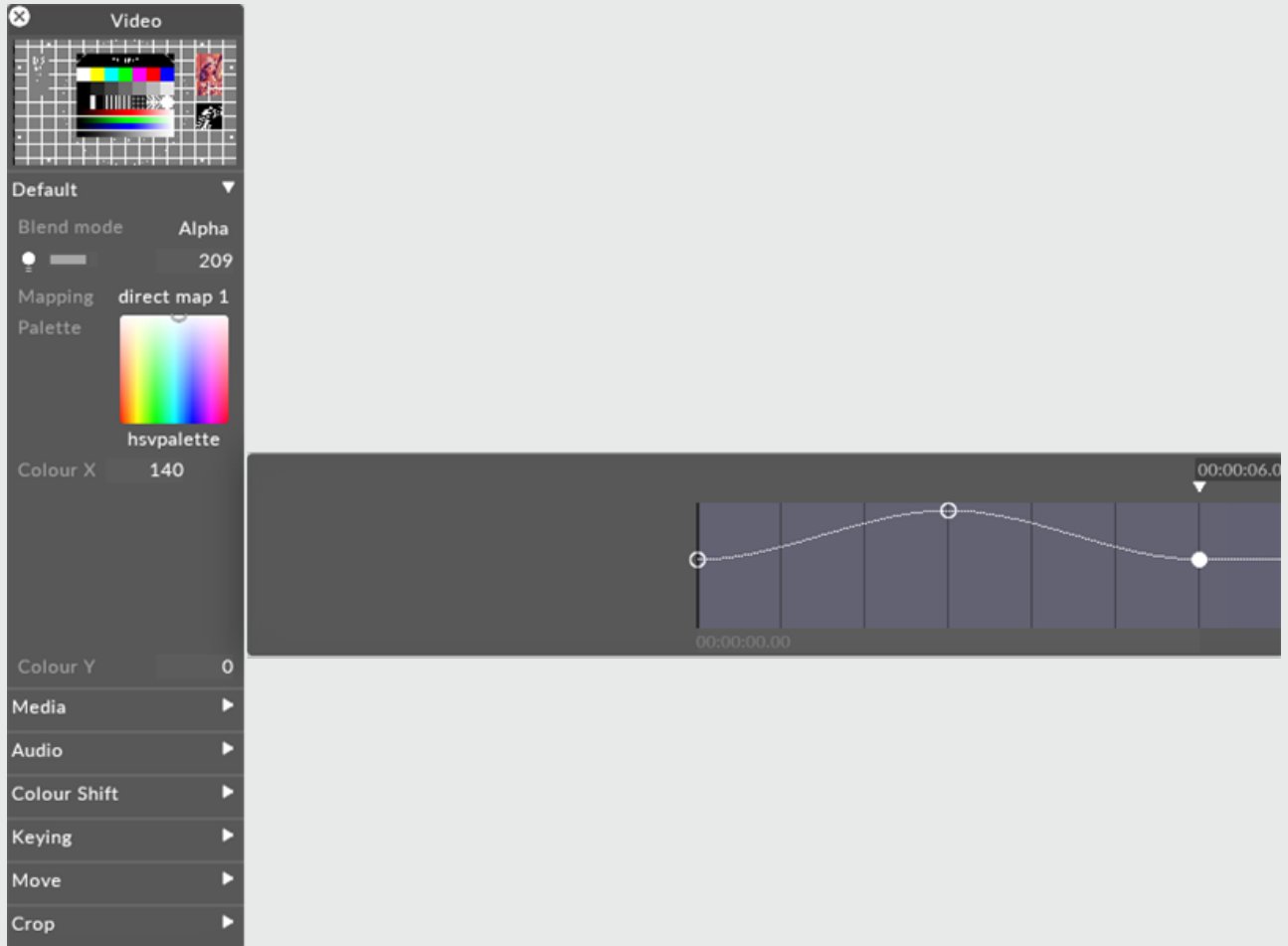

## Colour Shift

The colour shift property allows you to perform a number of colour-correction operations on the output of a layer.

Colour Shift objects can also be attached to individual video files within the Video layer.

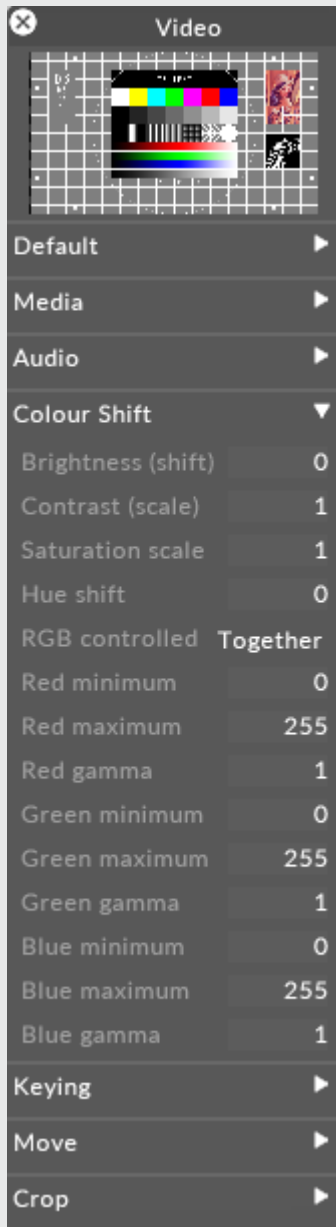

Colour Shift property performs colour-corrections on the output of a visual layer

Colour Shift properties are:

# Saturation scale

When set to 1, no change is applied to the image. When set to 0, the image is desaturated to black and white. When set higher than 1, the image is hypersaturated.

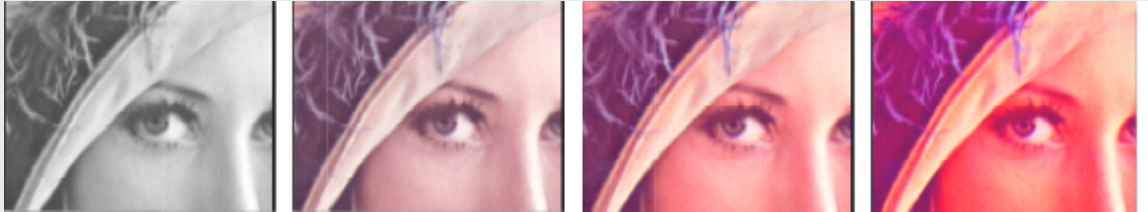

Saturation scale (from left to right):  $s=0$ ,  $s=0.5$ ,  $s=1$ ,  $s=2$

# Hue shift

## RGB controlled

This property controls how the min/max levels and gamma corrections are applied. If set to *together*, then the min, max and gamma values are the same for the red, green and blue channels. If set to *separate*, the min,max and gamma values can be controlled separately for red, green and blue. The latter setting allows you to apply fine colour balance controls to the image.

## Min

This sets the lowest brightness level found in the image. All pixels at this level are scaled down to zero brightness. Increasing this value enforces shadows and dark levels in the image and can be used to reduce low-level compression artifacts in an image or video frame.

Increasing *min* equally across red, green and blue enforces shadows, whereas increasing *min* on an individual channel has the effect of shifting the colour balance away from that colour. For example, increasing *red min* shifts the image towards cyan.

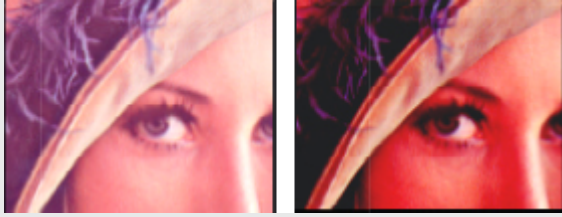

min = 00 (left), min = 96 (right)

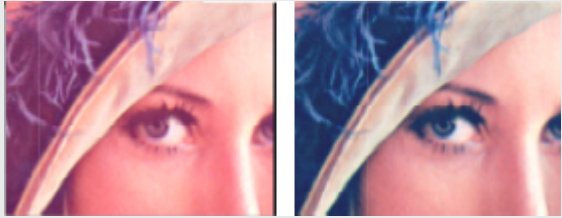

red.min = 0 (left), red.min = 96 (right)

## Max

This sets the highest brightness level found in the image. All pixels at this level are scaled up to the maximum level, i.e. 255. Decreasing this value brightens any highlights in the image. This is useful when the source image is too dark.

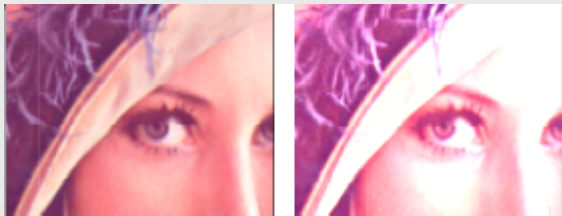

max = 255 (left), max = 260 (right)

If you set min to 255 and max to 0, the image (or single channel) will be inverted.



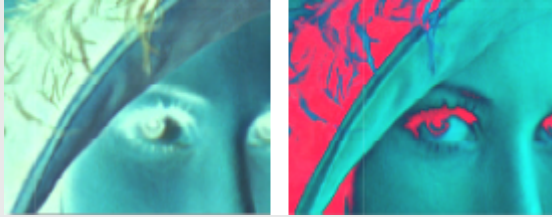

Invert all (left), invert red (right)

## Gamma

When *gamma* is set to 1, no change is made to the image. Reducing gamma brightens highlights while increasing gamma darkens lowlights. The maximum and minimum brightness levels remain the same.

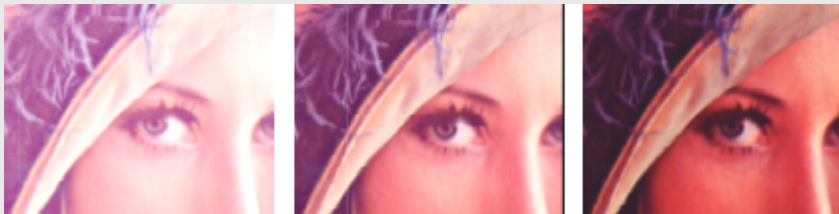

Gamma scale (from left to right):  $g=0.5$ ,  $g=1$ ,  $g=1.5$

## Interact

Opens an interaction window so that you can control the web page in real time.

## Bookmark

The bookmark for the web page you wish to browse. If you change the bookmark along the timeline, the new webpage will load in the background and then be presented.

# Command

The Javascript command you wish to issue. You can fire commands along a timeline that manipulate the site, such as turning the page, etc.

# Size

Two modes:

Match Mapping - this sets the size of the website canvas to match that of the Mapping it is being applied to.

Custom - allows you to manually set the size (Width/Height) of the web browser. The browser canvas will then be scaled up to match the Mapping.

# Custom Parameters

Name X: The name of the JavaScript function you wish to call every frame. The function name in Javascript will be `d3.customParam 1(x)`

Value X: The value you wish to pass into the JavaScript function.

# Clear Cache

Clears the web browsers cache

# Reset Browser

Tears down and resets the web browsing session

# Bookmarks

Bookmarks are the way you select your web layers content.

The options in a bookmark are:

## URL

This address can be a web address or file address.

- Web addresses are prefixed with `http://` or `https://`
- File addresses relate to HTML5 files contained within your d3 project folder structure. All locally stored html5 files should be under `project_folder/objects/Web/sub_folder`. For example, a sample page is located in every new project at `"file:///sample pages/slide heading.html"`.

**Please note:** To check the chromium version on your machine, create a web bookmark that points to `chrome://version/`

## Background

The web layer is capable of rendering pages with transparent backgrounds to allow you to composite, or with white backgrounds.

For transparent backgrounds to function correctly, the web page must set its background to be transparent.

Example CSS:

```
body { background-color: rgba(0, 0, 0, 0); }
```

## Zoom

Allows you to text zoom with correctly rendered fonts. This is similar to pressing `Ctrl+/-` in a regular browser.

# Interact

You are able to directly interact with web pages using a small browser. To open the browser, click the interact button.

While this window has focus, you are able to interact with the webpage including:

- Typing
- Clicking links
- Scrolling with the mouse wheel

You can change the size of the interaction window with the Scale or 50%/ 100% buttons.

## JavaScript Commands

Creating JS commands is very straightforward.

1. Create a JS Command and fill in the javascript you want executed in the browser.
2. Place the command on the timeline at the time you want it executed.

When the timeline is playing and crosses over the keyframe for the command, it will be executed.

## JavaScript Functions

The Web layer contains five pairs of Name/Value.

Every frame Disguise will call a function in your web page with 'Name' entered in that string (in the 'd3.' namespace), passing it a single float 'Value'.

```
d3.customParam1(1.0)
```

Essentially Disguise is 'pushing' the data into your webpage.

You can then write the corresponding function to do with as you please. NB: functions must be in the d3 namespace.

```
var g_size = 0 // here's an example global variable which d3 will set

var d3 =
{

/* You can specify the names of custom functions in d3. Below are some defaults.
*/

/* Every function is called every frame */

customParam1: function(myVal) { g_size = myVal }, // set the global variable in
this function

customParam2: function(myVal) {},

customParam3: function(myVal) {},

customParam4: function(myVal) {},

customParam5: function(myVal) {},

/* Below are the inbuilt d3 functions that give your custom HTML5 content a
context */

lockedTime: function(tBeats) {

},

normalTime: function(tBeats) {

},

globalTime: function(tBeats) {

},

bpm: function(tBeats) {

},
```

```
status: function(statusString) {  
  
},  
  
dmxUniverses: function(universe, data) {  
  
}  
  
}  
  
function setup() {  
  
createCanvas(1920, 1080);  
  
background(222);  
  
}  
  
function draw() {  
  
ellipse(mouseX, mouseY, 50 + 50 * g_size, 50 + 50 * g_size); // use the global  
variable to modify content.  
  
}
```

You can download an example project using JS/HTML from our Resources page in the Web Interaction section at [this link](#).

## Standard JavaScript Functions

These javascript functions are designed to allow the web page to respond to changes to the Disguise timeline. They are called every frame on the web browser. If the HTML5 page has been coded to respond to these functions, then it will accordingly.

`d3.lockedTime(float)` -- Time in beats within the current layer.

`d3.normalTime(float)` -- Time in beats within the current layer, but carries on counting up. (See video player behaviour to get the idea)

`d3.globalTime(float)` -- Time in beats within the whole track

`d3.bpm(float)` -- Current BPM of the track

`d3.status(string)` -- Provides the play head status. Either: "playing", "holding", "stopped"

`d3.dmxUniverses(array[int], array[array[int]])` -- Provides a dump of the universes selected in the layer editor

Proprietary video codecs (like h264) are not supported currently.



# Control Layers Overview

Control Layers can be used for executing custom commands on 3rd party products and controlling specific internal functions.

## Types of Control layers

There are several types of Control layers available within Disguise software:

[CameraControl](#)

[CameraCutControl](#)

[Control](#)

[DMXLightsControl](#)

[DMXShare](#)

[HTTPControl](#)

[IndirectionControl](#)

[MDC](#)

[MTC](#)

[MasterBrightness](#)

[MatrixControl](#)

[MidiNote](#)

[Open](#)

[OscControl](#)

[PlayMode](#)

[ProjectorControl](#)

[TargetObject.html](#)

TimecodeMode

TrackJump

TransportBrightnessLocal

TransportControl

TransportVolumeLocal

# Control

The Control layer is tool for executing custom commands on 3rd party products via the following protocols - Serial, Telnet or UDP.

The Control layer allow for the definition of custom commands that can be sequenced on the timeline to perform functions at certain times. The custom commands are command strings which can be written in normal character format (ASCII) or in Hex.

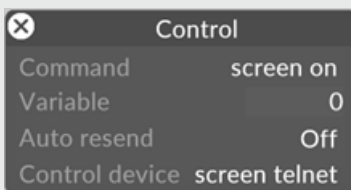

## Command

The selected command to be executed at this point on the timeline.

The **variable** to be passed into the command, if the command syntax contains the use of variables. The values can be sequenced on the timeline. Use **Auto Resend** to control when values are sent.

## Auto resend

When set to 'On' the command will be executed everytime the **variable** changes, as well as on normal command issuing.

## Control Device

The protocol device through which the command should be issued, either a Serial, Telnet or UDP device.

**Please note:** Ensure you that your protocol device is in the Device manager. Often it is better to create the devices from the manager and then select them in your layers, to avoid confusion.

## Command Syntax

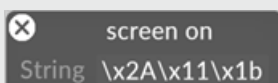

Commands are made up of a string. The string can be ascii or hex. The \ escape character is used to send special data.

The command can contain a variable set in the Control Layer, which is a timed event.

Special Characters	Description
\\$	Variable value as string
\%	Variable value as binary byte
\13	Carriage return
\10	New Line
\xYY	Send YY as hex value, example, \xF5
\	Send special <u>ASCII</u> character (0-255). Used to send characters outside the normal range, e.g 1-31, 96 and up. Example, \37 will send '%' character.

A useful ASCII/Hex lookup table can be found here, <http://www.ascii-code.com/>.

## Ascii examples

- To send the command "START 568" followed by the enter key we would use the command  
string: START 568\13
- To send the command "CUE XXX" where XXX is the variable value, we would use the command  
string: CUE \\$

## Hex examples

- To send the byte values of 42, 62, 93 in sequence, you would use the string: `\x2A\x3E\x5D`
- If you wished for the last value to be the variable value in a byte/uchar fashion you would use: `\x2A\x3E\%`

## Real World Example

To control a Lightware matrix you would use the following examples:

- Load preset (using a variable) via telnet: `{%\$}`
- To route a particular input (using a variable) to output 1: `{1@\$}`

# CameraControl

The CameraControl layer controls Sony Visca Cameras configuration.



## CameraControl layer properties

### Camera

The camera object to use.

### Command

The camera command to send.

## Creating/sequencing CameraControl commands

The process used to create/sequence CameraControl commands is done by placing key-frames onto the Command key-frame editor, and is therefore the same as any other layer type that uses key-frame editors, for example the AnimateCameraPreset layer. For an example on how to create and animate key-frames using the key-frame editor please follow the step-by-step instructions in the [AnimateCameraPreset](#) sub-chapter.

There are three types of CameraControl commands:

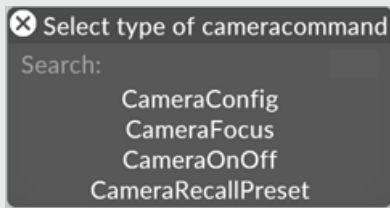

## Editing CameraControl commands

Each CameraControl command type opens a specific camera command editor.

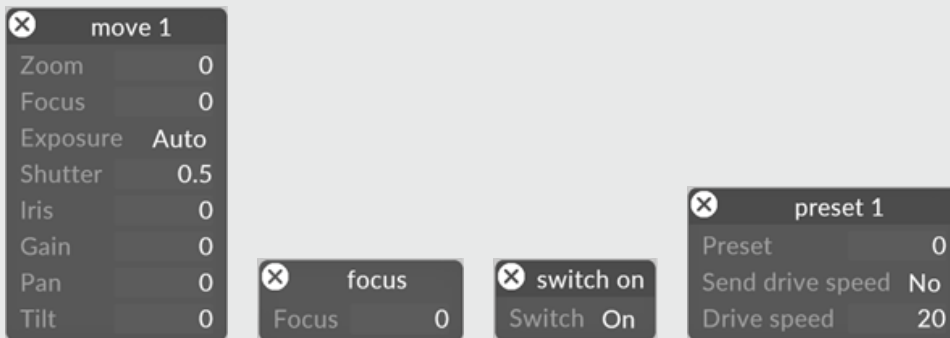

### CameraConfig editor

**Zoom** : sets the cameras zoom, 0 100%

**Focus** : sets the cameras focus, 0 100%

**Exposure mode** : sets the exposure mode to auto, manual, iris or shutter.

**Shutter** : sets the shutter value, 0 100%. Only valid in shutter mode.

**Iris** : sets iris value, 0 100%. Only valid in iris mode.

**Gain** : sets the cameras gain, 0 100%.

**Pan** : sets the cameras pan, in degrees.

**Tilt** : sets the cameras tilt, in degrees.

## Camera Focus

sets the cameras focus, 0 100%

## CameraOnOff editor

**Switch** : turns the camera on or off .

## CameraRecallPreset editor

**Preset** : sets the preset number assigned to the Sony Visca Camera. A Sony Visca Camera can have up to four presets.



# CameraCutControl

The camera cut control module allows camera switches to be sequenced on the timeline for XR workflows. It takes account of the calibrated delays to ensure that the switch happens on the keyframed beat.

The CameraCutControl module is a subclass of the Indirection Control Module. It calculates the total switching delay for any given frame, and uses that to work out when to trigger the indirection change so that it lands on the correct beat. The most complex scenario occurs when modules are rendering at fractional frame rates. Ordinarily switches are not possible on every frame in this case.

Therefore the CameraCutControl module uses

`MixedRealitySet::applySwitchRenderOffset` to tell the MR set to delay the switch until the correct frame.

## CameraCutControl Layer Properties

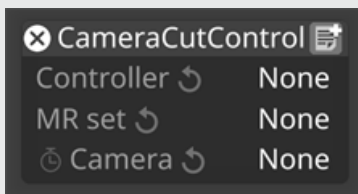

## Request

This requires a new `HttpRequest`. When a new `HttpRequest` is created, it has the properties `Url`, `Method`, `Headers` and `Body`.

## Trigger

The trigger options available are **Always** and **When Playing**. Expressions can also be used to extend the functionality.

## Creating CameraCutControl commands

To sequence camera switches:

1. Set up and fully calibrate an XR stage.
2. Add a `SequencedIndirectionController` as the camera indirection controller in the MR set.
3. Add a `CameraCutControl` module to the timeline.
4. Select the controller and MR set.

5. Add keyframes to the Camera property.

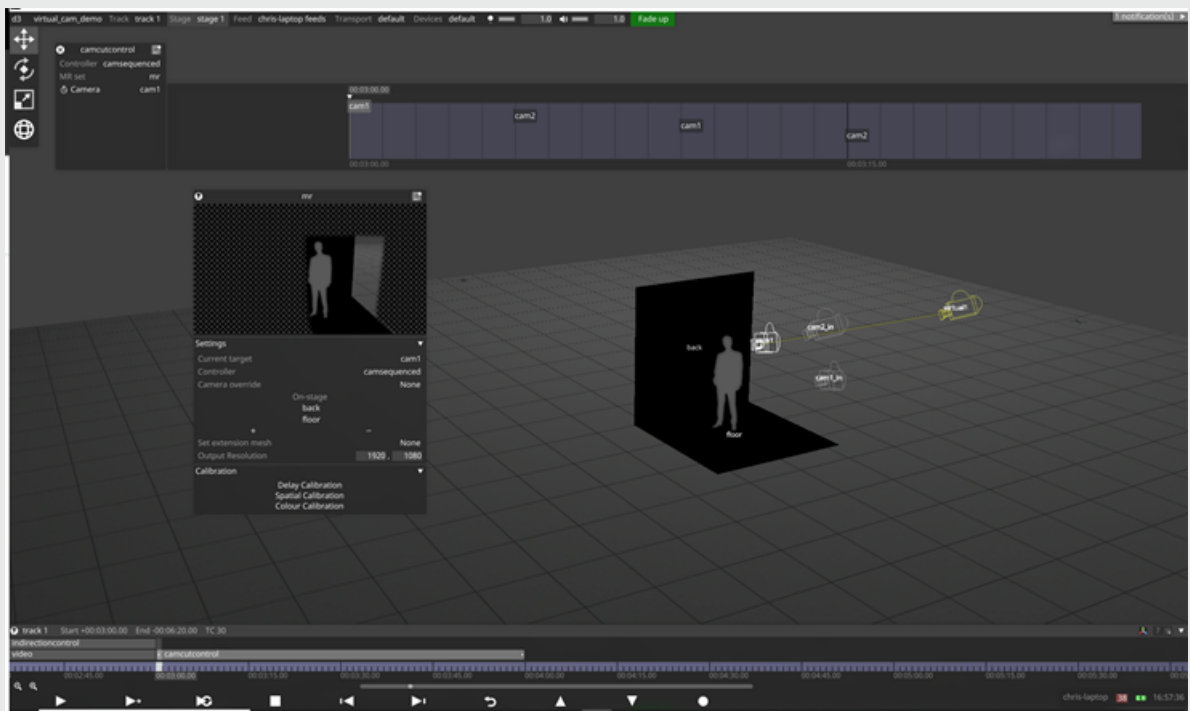

# DMXLightsControl

The DMXLightsControl layer can add DMX commands and animate their values using a key-frame editor.



**Warning:** the DMXLightsControl layer can only output DMX when a DMX device is set up. See [DMX devices](#) for information on setting up a device.

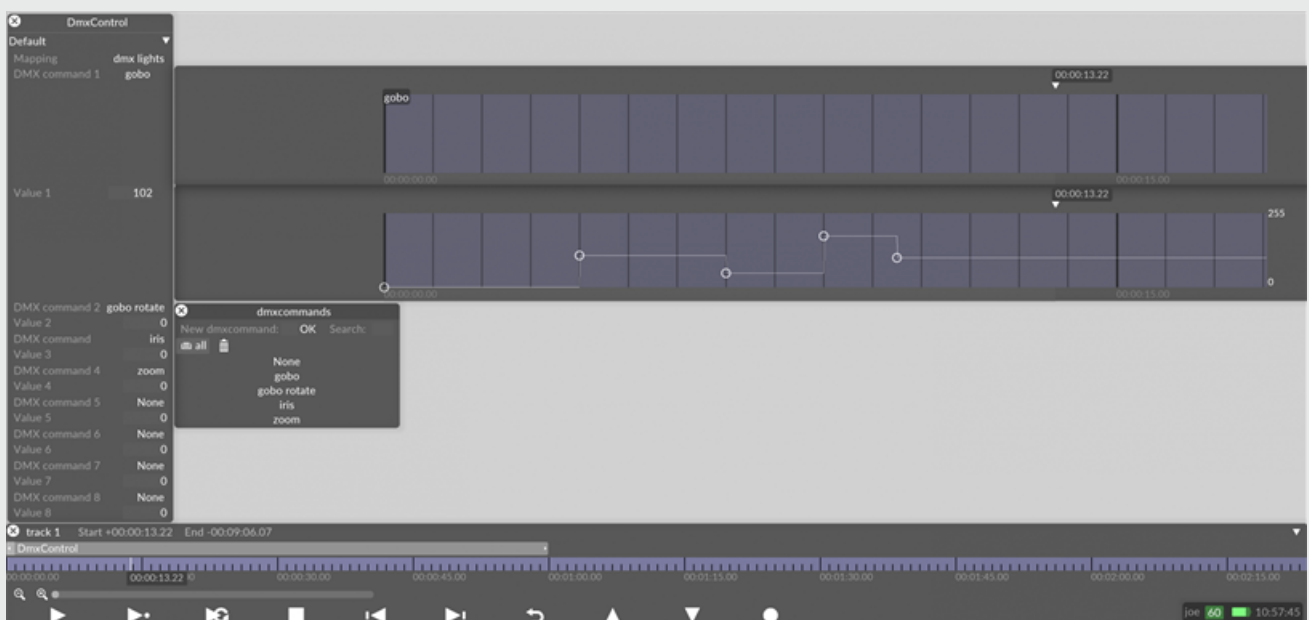

## DMXLightsControl layer properties

### Dmx Command 1-8

The DMX command to send.

The image above shows that the DMXLightsControl layer has eight *dmx command* properties. By left-clicking the property a key-frame editor will open. It is important to note that only one DMX command can be added per key-frame editor, so a maximum of eight different DMX commands can be added in one DMXLightsControl layer.

However, multiple DMXLightsControl layers can each contain a set of specific DMX commands. For example, one DMXLightsControl layer can include DMX commands that control the beam effects of a particular fixture, whilst another DMXLightsControl layer can control the strobe options, etc.

## Value 1-8

The animated value to substitute into the command.

The image below shows that the gobo DMX command is set to send a value of 128 on channel 8 to the mac2k lighting fixtures. However, by using the Value 1 key-frame editor, as shown in the image above, the value of the gobo DMX command is able to change over time.

## Creating DMXLightsControl commands

The process used to create DMX commands is done by placing key-frames onto the Dmx Command key-frame editor, and is therefore the same as any other layer type that uses key-frame editors, for example the AnimateCameraPreset layer. For an example on how to create and place key-frames using the key-frame editor please follow the step-by-step instructions in the [AnimateCameraPreset](#) topic.

## Editing DMXLightsControl commands

- Right-click a DMX command from the DmxCommands manager to open the DmxCommands editor.

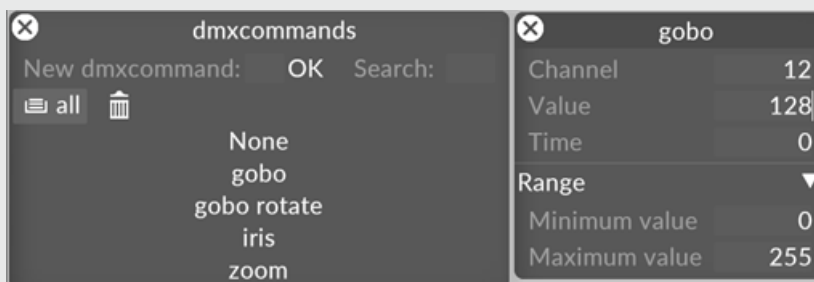

Lamp or fixture commands require you to send a particular value on a particular channel to, for example, control the focus, iris or gobo. These commands are created using the DmxCommands manager which displays a list of all of your DMX commands, and configured using the DmxCommands editor inside the driver editor of the fixture. Therefore for information on the properties of the DmxCommands editor please scroll down to the section DmxCommand in the [GenericLampDrivers](#) section.

# DMXShare

The DMXShare layer enables you to specify whether you want to:

- control all DMX channels from Disguise software
- control the colour of the DMX fixture only
- control the position and orientation of the DMX fixture only

The advantage of the DMXShare layer is that in some shows you may want to control lights using both a conventional lighting desk and Disguise software. For example, Disguise is an extremely useful tool for creating pixel mapping content for the lights using the advanced content mapping system, but also for sequencing lights exactly to the beat by quantising an audio track. The Disguise software is also very good for controlling the movements of groups of lights. However, lighting desks give you more control over the movement of individual lights and are specialised to control lights very quickly. Based on these facts, there is a requirement to share the control of the lights between Disguise software and a lighting desk.

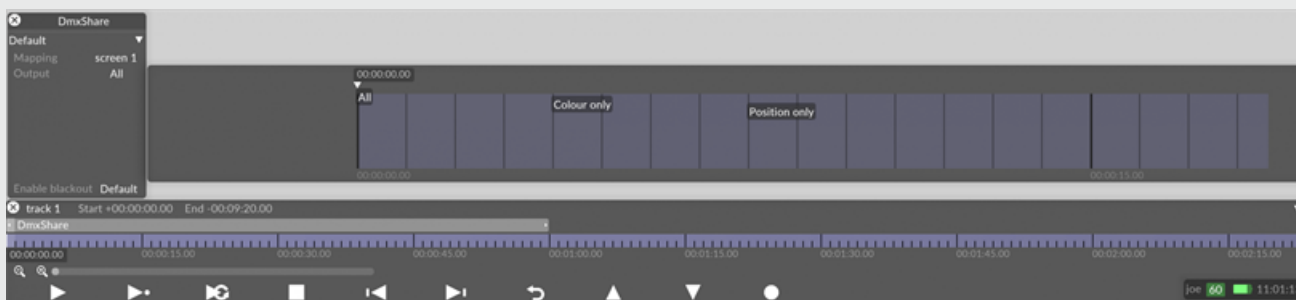

## DMXShare layer properties

### Output

Controls what properties of a DMX fixture Disguise software should control and output. Options are **all** control all properties of the fixture; **colour only** control the colour of the fixture only; and **position only** control the position and orientation of the fixture only (applies to moving head fixtures).

### Enable blackout

Controls whether the DMX fixture/screen is muted (blacked out) from within Disguise software.

For advice on what hardware to use for merging DMX, please contact the Support team.

# MatrixControl

The MatrixControl layer allows you to animate matrix presets on the Timeline. Currently, Disguise software has built in matrix devices for a number of matrices.



## MatrixControl layer properties

### Matrix

The matrix device you want to control.

### Command

The preset you want to trigger.

# Creating & sequencing MatrixControl commands

The process used to create/sequence DVI matrix presets is done by placing keyframes onto the Command keyframe editor, and is therefore the same as any other layer type that uses keyframe editors, for example the AnimateCameraPreset layer.

There are three types of matrix presets:

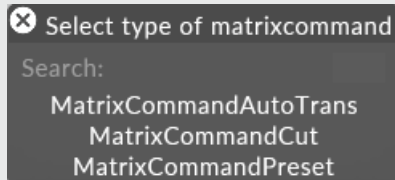

## Editing MatrixControl commands

Each MatrixControl command type opens a specific command editor.

### MatrixCommandAutoTrans

Transition with a specified **transition time** . Only applicable for the Barco Encore.

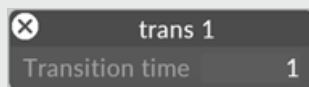

### MatrixCommandCut

Transitions with a hard cut. Only applicable for the Barco Encore.





## MatrixCommandPreset

Changes the **preset** of the matrix. This will only work if you already configured a DVI matrix.



## Using the MatrixControl layer

1. First, create a new matrix device in the [Device manager](#), for example Lightware matrix or BarcoMatrixPro. Make sure the ip-address of the matrix device is in the same network as your Director/ Actor network.
2. Create a new MatrixControl layer.
3. Choose the matrix device you just created.
4. Create a new command. For a matrix preset, choose the **MatrixCommandPreset**
5. Type in the number of the preset.
6. To animate presets, drag and drop them onto the keyframe editor.

# HTTPControl

HTTPControl module is designed to interface with APIs.

HTTPControl module is designed to interface with APIs. The Http Patch within the HttpControl module has been enabled to support the integration with partner APIs.

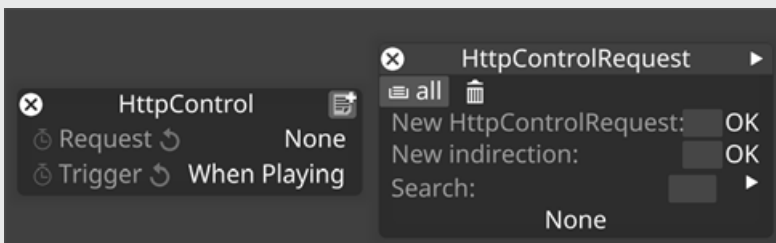

## HTTPControl Layer Properties

### Request

This requires a new HttpControlRequest. When a new HttpControlRequest is created, it has the properties Url, Method, Headers and Body.

### Trigger

The trigger options available are **Always** and **When Playing**. Expressions can also be used to extend the functionality.

# IndirectionControl

The indirection control module allows indirections to be sequenced on the timeline. One Indirection control module controls one indirection.

The indirection control module is implemented with two new classes:

- **SequencedIndirectionController:** The controller added to control the indirection
- **IndirectionControl module:** The module used for sequencing the indirection on the timeline

The indirection control module updates the selected SequencedIndirectionController when it hits a new keyframe.

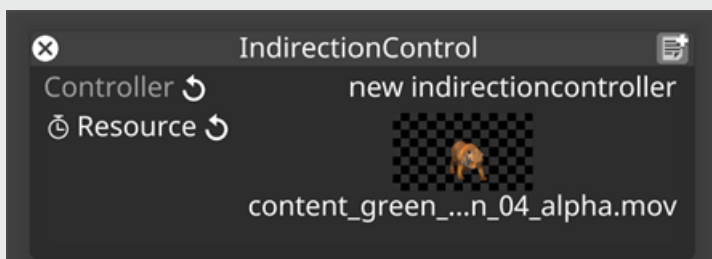

## IndirectionControl Layer Properties

### Controller

The SequencedIndirectionController.

## Resource

The content, such as video or 2D image.

# Sequencing IndirectionController commands

The process used to create/sequence IndirectionControl commands is done by placing keyframes on the Resource keyframe editor.

1. Add a video layer.
2. In the video layer editor, expand the **Media** section and left-click **None** to open the VideoClip editor.
3. Create a **New indirection** by typing in the input field and clicking OK.
4. Add a controller by clicking **None** and by typing in the input field and clicking OK.
5. Select **SequenceIndirectionController**.
6. Create an **IndirectionControl** layer on the timeline in the same section as the video layer.
7. Select the **SequenceIndirectionController**.
8. Activate the **Resource** property keyframe editor.
9. Add media to the keyframe editor.

# TimecodeMode

The TimecodeMode layer allows you to control whether Disguise software is chasing timecode or ignoring timecode. If it is set to default then the TimecodeMode layer will have no effect.

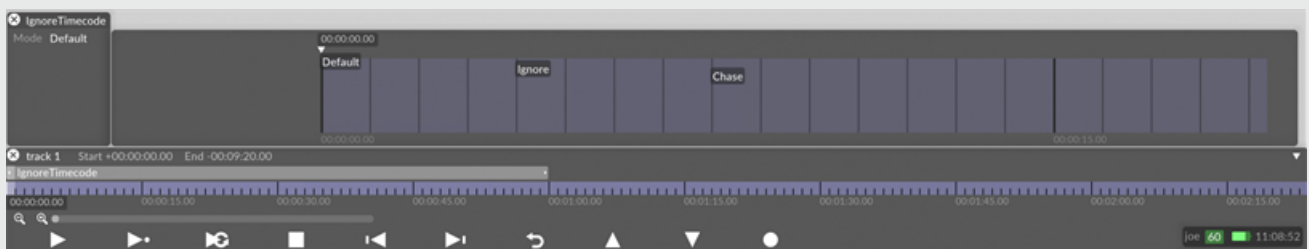

The layer allows you to change between the following timecode modes:

**Default** - The layer will have no effect.

**Ignore** - The layer will ignore incoming timecode for the duration of where the layer covers.

**Chase** - The layer will chase timecode. The chase mode is effectively saying "The timecode tags on this area of the timeline will be triggered".

# MasterBrightness

The MasterBrightness layer allows you to control the output (master) brightness of a number of layers without having to individually change their brightness levels. You can also use it to control the output brightness of any Screen or collection of Screens.



**Warning:** once the master brightness of a screen is set, it will retain that value until another MasterBrightness layer resets it. A common mistake is to set the master brightness of a screen to 0, then jump to another part of the timeline without a MasterBrightness layer and wonder why there is no output on the screen. For this reason, the use of the MasterBrightness layer is discouraged except in emergencies.

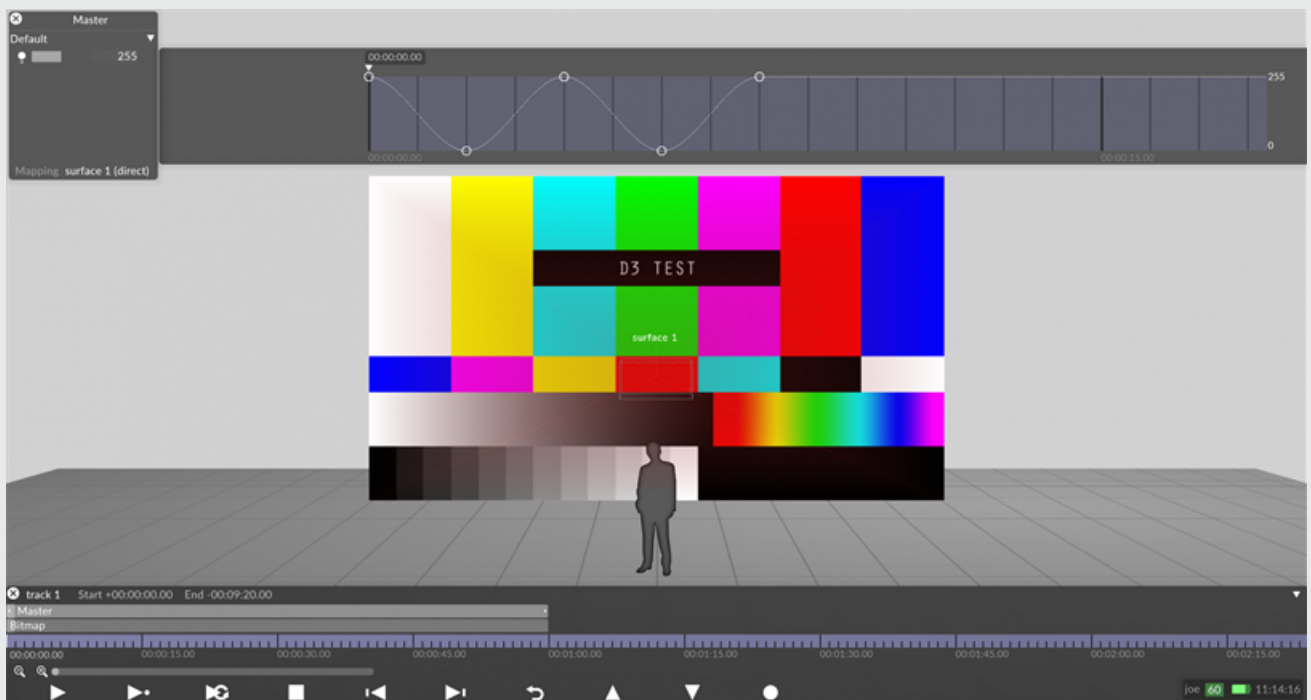

As you can see below, the output brightness is only visualised in the Output Feeds level.

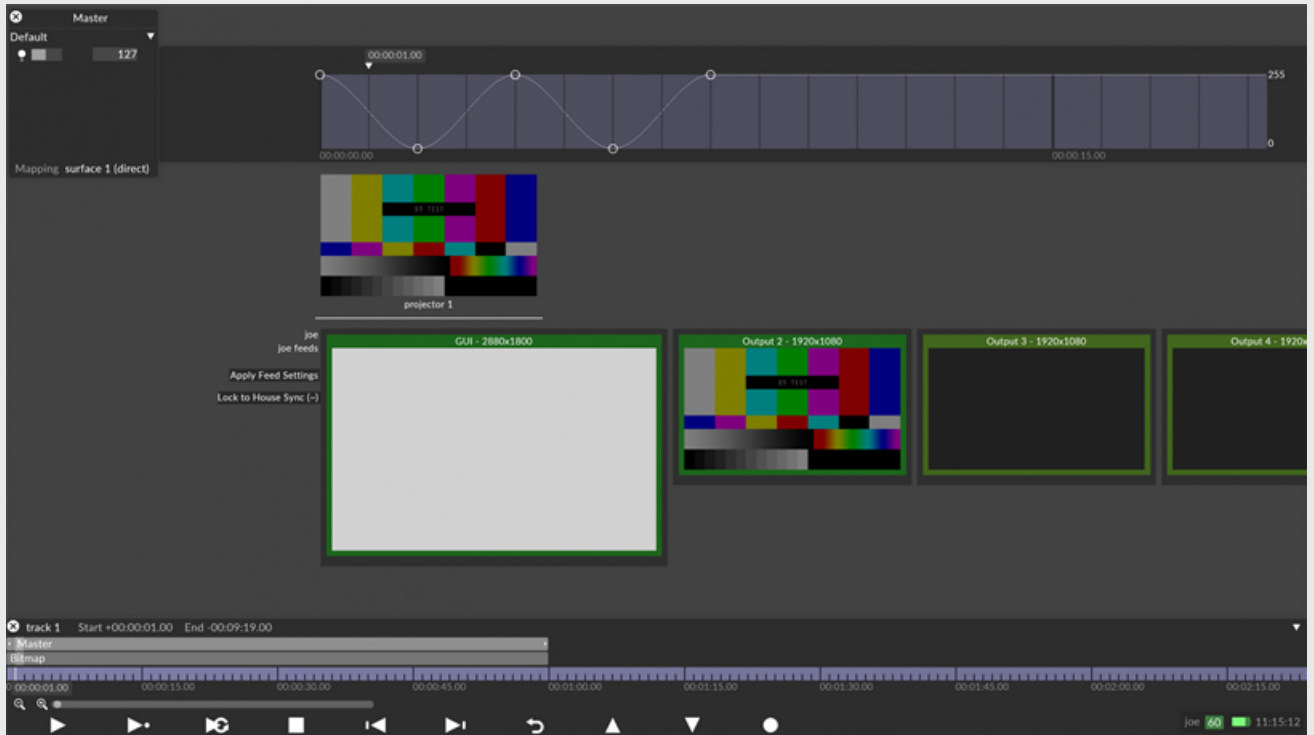

## MasterBrightness layer properties

### Brightness

This property (which appears as a light bulb icon) controls the brightness of the layer output.

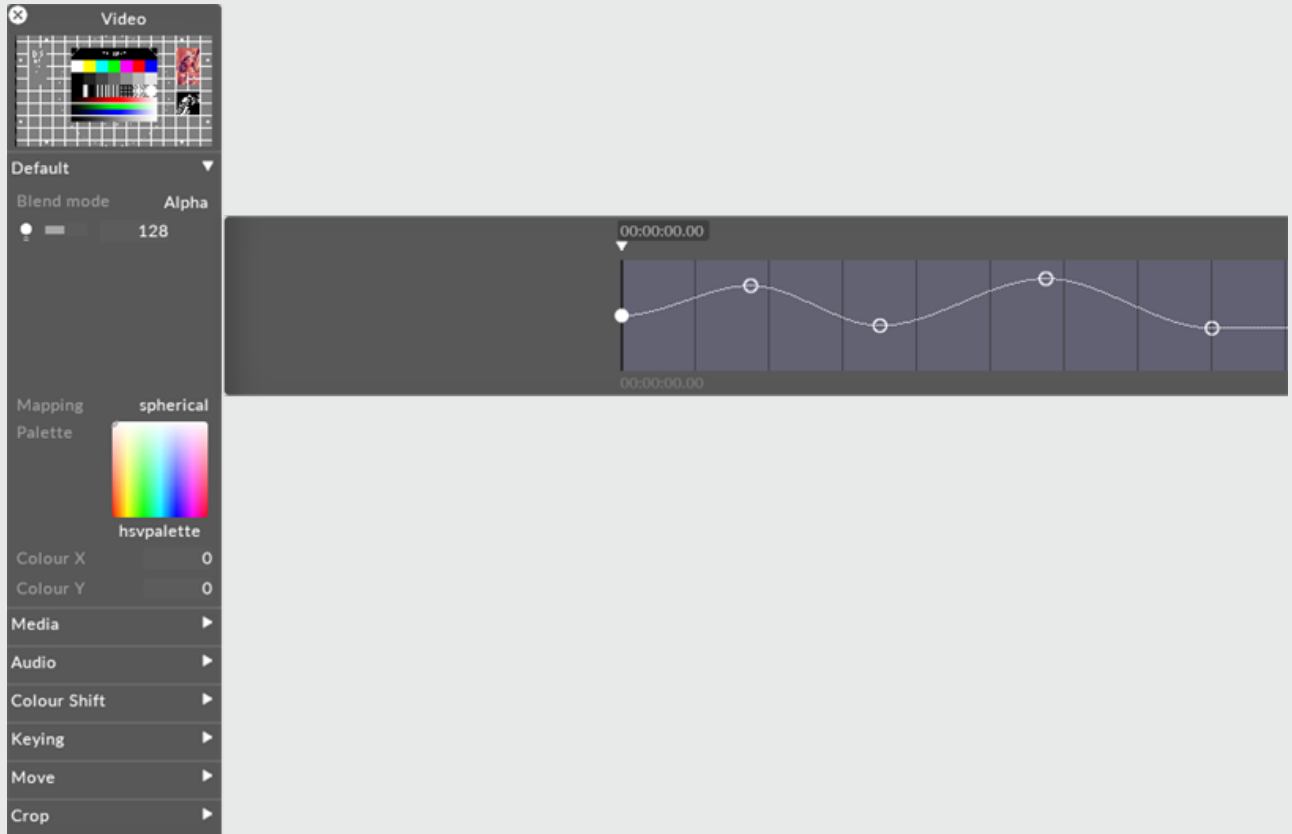

If the layers blend mode is set to Alpha, then reducing the brightness to 0 also reduces the opacity of the layer to 0. This can be useful when you want to dissolve from one layer to the next. In that case, you can place the new layer above the old layer and increase its brightness level.

## Mapping

The mapping property controls how the layer output is mapped onto the screen(s) in the Stage level.



**Video**

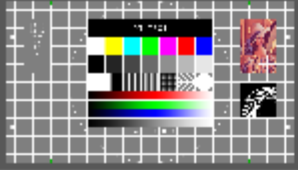

Default ▾

Blend mode Alpha

128

Mapping direct map 1

Palette



hsvpalette

Colour X 0

Colour Y 0

Media ▾

Video



d3\_test\_16-9.png

Speed 1

Mode Normal

At end point Loop

Transition time 0

Audio ▶

Colour Shift ▶

Keying ▶

Move ▶

Crop ▶

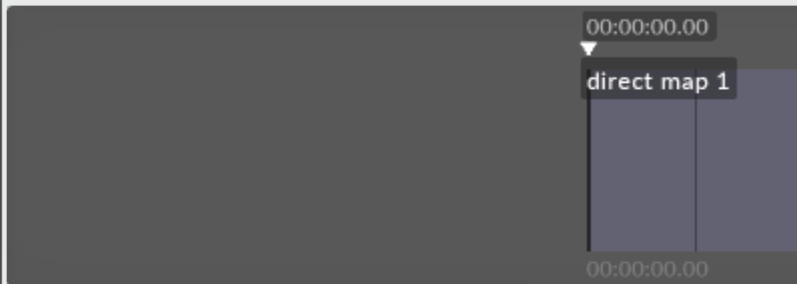

00:00:00.00

direct map 1

00:00:00.00

**mappings**

New mapping: OK Search:

all New Mappings

- direct map 1
- feed map 2
- feed mapping
- mapping 1
- mapping 2
- parallel
- spherical

For information on mapping, including how to use the different mapping types offered by Disguise software, please see the chapter [Content Mapping](#).

# MatrixControl

The MatrixControl layer allows you to animate matrix presets on the Timeline. Currently, Disguise software has built in matrix devices for a number of matrices.



## MatrixControl layer properties

### Matrix

The matrix device you want to control.

### Command

The preset you want to trigger.

# Creating & sequencing MatrixControl commands

The process used to create/sequence DVI matrix presets is done by placing keyframes onto the Command keyframe editor, and is therefore the same as any other layer type that uses keyframe editors, for example the [AnimateCameraPreset](#) layer.

There are three types of matrix presets:

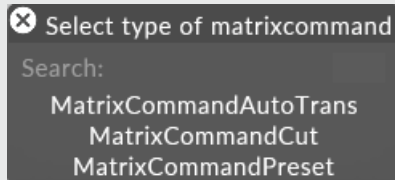

## Editing MatrixControl commands

Each MatrixControl command type opens a specific command editor.

### MatrixCommandAutoTrans

Transition with a specified **transition time** . Only applicable for the Barco Encore.

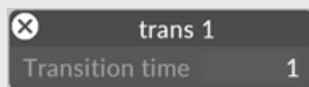

### MatrixCommandCut

Transitions with a hard cut. Only applicable for the Barco Encore.



## MatrixCommandPreset

Changes the **preset** of the matrix. This will only work if you already configured a DVI matrix.

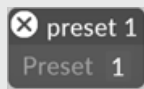

## Using the MatrixControl layer

1. First, create a new matrix device in the Device manager, for example Lightware matrix or BarcoMatrixPro. Make sure the ip-address of the matrix device is in the same network as your Director/ Actor network.
2. Create a new MatrixControl layer.
3. Choose the matrix device you just created.
4. Create a new command. For a matrix preset, choose the **MatrixCommandPreset**
5. Type in the number of the preset.
6. To animate presets, drag and drop them onto the keyframe editor.

# MDC

The MDC layer allows you to control a system of multiple displays over a serial connection, TelNet or UDP from within Disguise software.

MDC, the free multi-display control software created by [Samsung](#), is used to control and exchange information between a variety of different sources including Samsung displays and the networked computers used to control the displays.

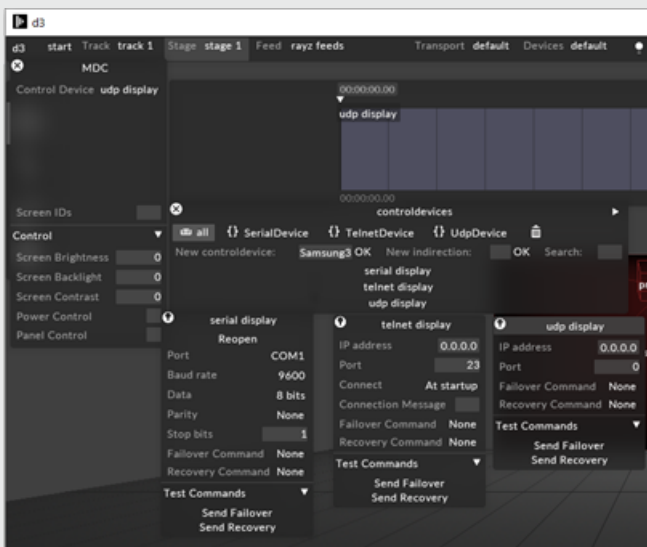

Three types of devices can be configured from the MDC layer:

- Serial
- TelNet
- UDP

# MidiNote

The MidiNote layer sends a midi note.

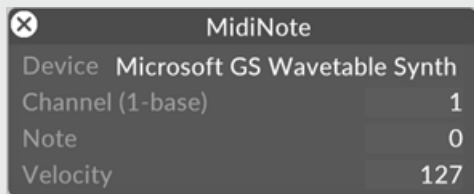

A screenshot of a configuration window titled "MidiNote". The window has a close button (X) in the top-left corner. It contains a table with four rows of configuration data:

Property	Value
Device	Microsoft GS Wavetable Synth
Channel (1-base)	1
Note	0
Velocity	127

## MidiNote layer properties

### Device

The midi port to use.

### Channel (1-base)

The channel to send the note.

### Note

The note to send, in decimal format.

### Velocity

The velocity value of the note.

# MTC

The MTC layer allows you to output MIDI timecode in a controlled way so that external devices such as lighting desks can be synchronised precisely with events on the timeline.

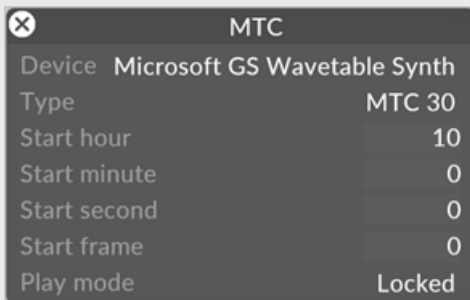

The MTC layer lets you set a timecode start value from the time position on the timeline, a frames-per-second value and an output device. When the play cursor first enters the extent of the layer, Disguise software starts a clock at the value specified and then outputs timecode as long as the play cursor remains under the layer extent.

If moving the play cursor away from under the extent of the layer will stop the output clock. When the play cursor re-enters the layer extent, the clock will restart.

## MTC Layer Properties

### iDevice

This specifies the index of the MIDI device used to output timecode. In the standard Disguise machine, this should always be set to **AIO Midi**. The other option is **Microsoft GS Wavetable Synth**.

### Type

Choose from the following options: 24, 25, or 30 frames per second.



## Start Hour, Min, Sec, Frame

This specifies the start time of the output clock. Whenever the play cursor enters the layer extent, the output clock is reset to this value.

## Play mode

There are two options:

**Locked:** sets the timecode value to the position of the play cursor on the Timeline.

**Normal:** allows the time to ticks upwards regardless of cursor position on the Timeline. For example, if the play mode is set to Play-to-end-of-section, where the Play cursor will only progress until it reaches the end of a section (i.e. just before the next cue point) and Disguise enters in a holding state, the time code will still tick upwards.

# Open

The Open layer is the Swiss army knife of layers. It allows you to control any property of any object in Disguise software, even if that object was not previously animatable using a Key-frame editor. This ability to use a Key-frame editor for properties which were not previously animatable is the key advantage of the Open layer.



**Warning: use the Open layer carefully. A common mistake is to have a short Open layer on the Timeline that changes the value of that property and then move the play cursor somewhere else on the Timeline. You might, for example, change the output master brightness to 0, then move the cursor to another location and wonder why there is no output.**

When you first create an Open layer, all you will see is a title bar, with no properties beneath it.



## To control a property of another object:

1. Right-click an object to open its object editor, in this example Screen 1.
2. If you want to open multiple editors click **Ctrl** on the objects of interest.
3. Hold down **Alt**, left-click and drag from the Open layer title bar, you will see a white arrow appear. For more information on Arrows please see the [Composing layers with Arrows](#) topic.

4. Drag the arrow-head over the property you want to control, in this example **scale** .

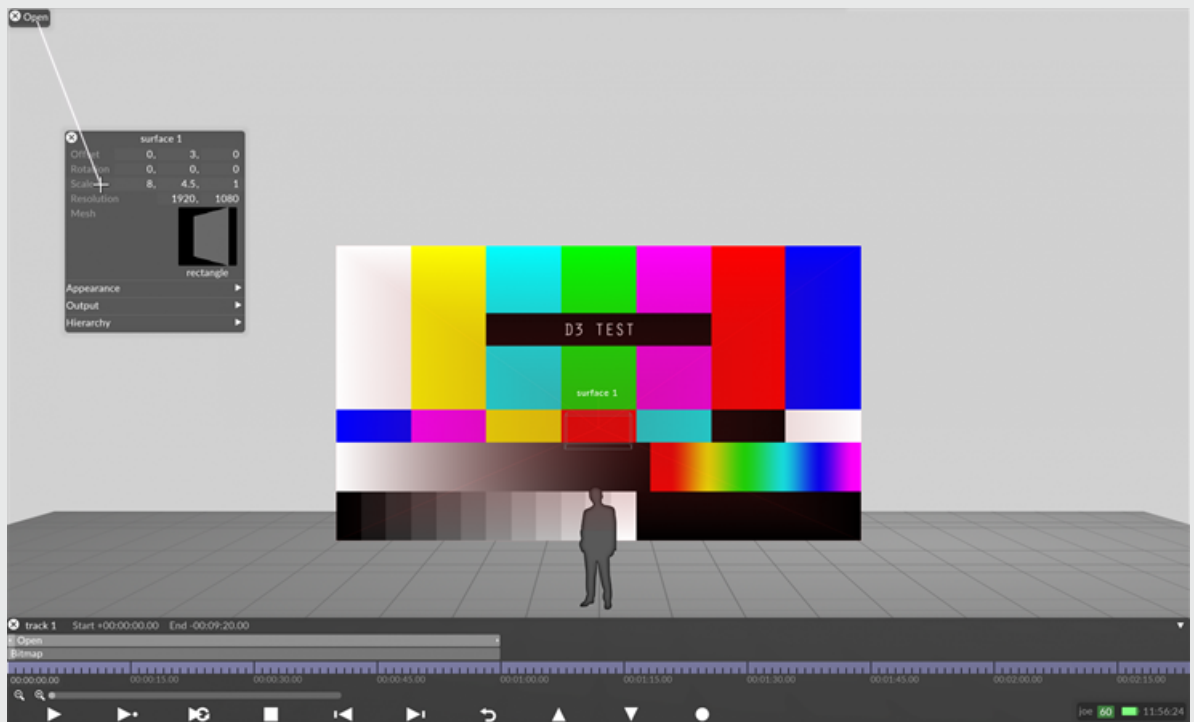

5. Release the mouse button and **Alt** ; the Open layer now has a new property named after the property you dragged the arrow to. By left-clicking the property a key-frame editor will open. This can be used to animate the property.

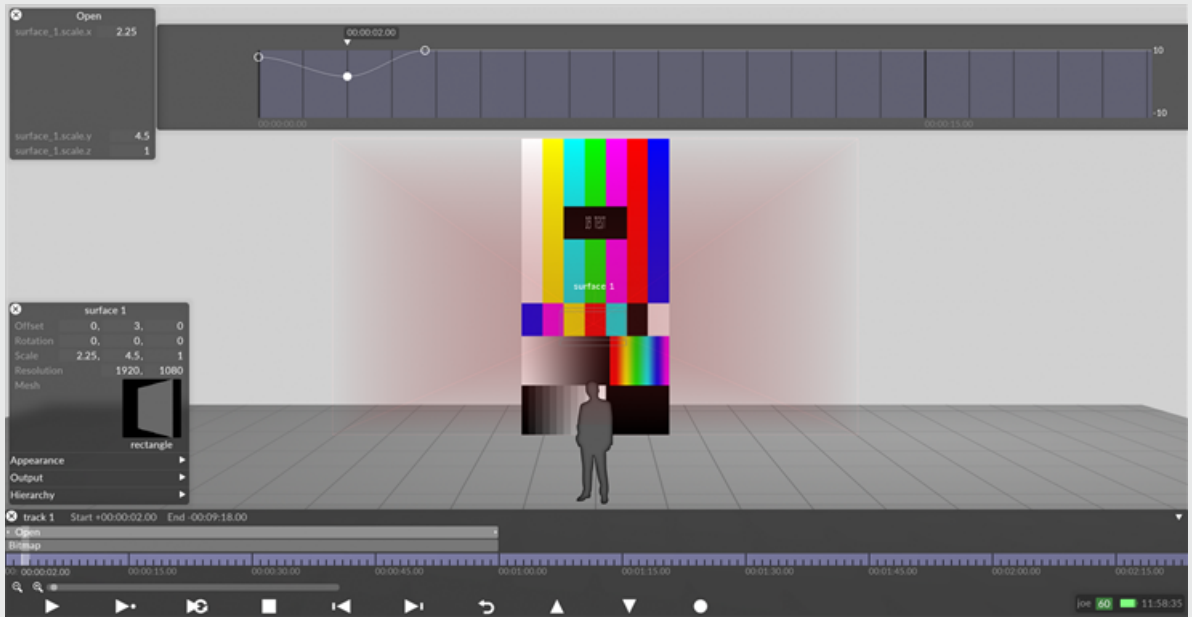

Scale property has now become a property of the Open layer

# OscControl

The OscControl layer is a tool for sending custom commands to 3rd party products via Open Sound Control (OSC).

The OscControl layer allows for the definition of custom commands that can be sequenced on the timeline to perform functions at certain times. The custom commands are OSC messages defined by a fixed OSC address and any amount of OSC arguments (Integer, Float, String, Blob).



## Command

The selected command to be executed at this point on the timeline.

## Variable 1-4

The **variable** to be passed into the command, if the command syntax contains the use of variables. The values can be sequenced on the timeline. Use **Auto Resend** to control when values are sent.

## Auto resend

When set to 'On' the command will be executed everytime the **variable** changes, as well as on normal command issuing.

## OSC Device

The protocol device through which the command should be issued, either a Serial, Telnet or UDP device.

**Please note:** Ensure you that your protocol device is in the Device manager. Often it is better to create the devices from the manager and then select them in your layers, to avoid confusion.

## Command Syntax

Commands are made up of an OSC address and any number of OSC arguments. The arguments have a type (Integer, Float, String or Blob) and a string value.

The string value of Integer and Float arguments can contain a variable set in the Control Layer, which is a timed event, or a fixed numerical value. \$1 through \$4 define which variable to use.

The string value of a Blob argument should be in hex.

# PlayMode

The PlayMode layer overrides the current play mode set in the Timeline.

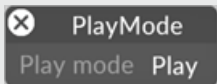

## PlayMode Properties

### Play Mode

The play mode to be in. The options are:

**Any** : this mode has no effect; the current play mode specified in the Timeline will not be overridden.

**Play**: this mode does not respect section boundaries; when the end of a section is reached, the cursor continues into the next section, stopping only at the end of the track.

**Play to end of section**: in this mode the Play cursor will only progress until it reaches the end of a section (i.e. just before the next cue point).

**Loop section**: in this mode, the Play cursor will progress until it reaches the end of a section, i.e. just before the next cue point. At this point, the cursor will loop back immediately to the beginning of the section and will continue playing from there.

For more information on these play modes see the sub-chapter [Navigating the Timeline](#).

# ProjectorControl

The ProjectorControl layer animates projector parameters in the stage, and in turn, those parameters can be output to real projectors.

## ProjectorControl layer properties

### Mapping

The projector(s) being controlled by the layer.

### Presets

The preset the projector(s) get their data from.

## Creating a preset

The preferred workflow is to create presets in the projector control editor, as detailed in the [projector control device](#) topic. However, this functionality can also be achieved directly through the layer if required.

1. Open the ProjectorControl layer.
2. Choose which mapping (group of projectors) you wish to control using the mapping property.
3. Left click the **presets** parameter.
4. The presets manager will open.
5. In the **New projectorpresets** field enter a name for the preset. For example, position 1.



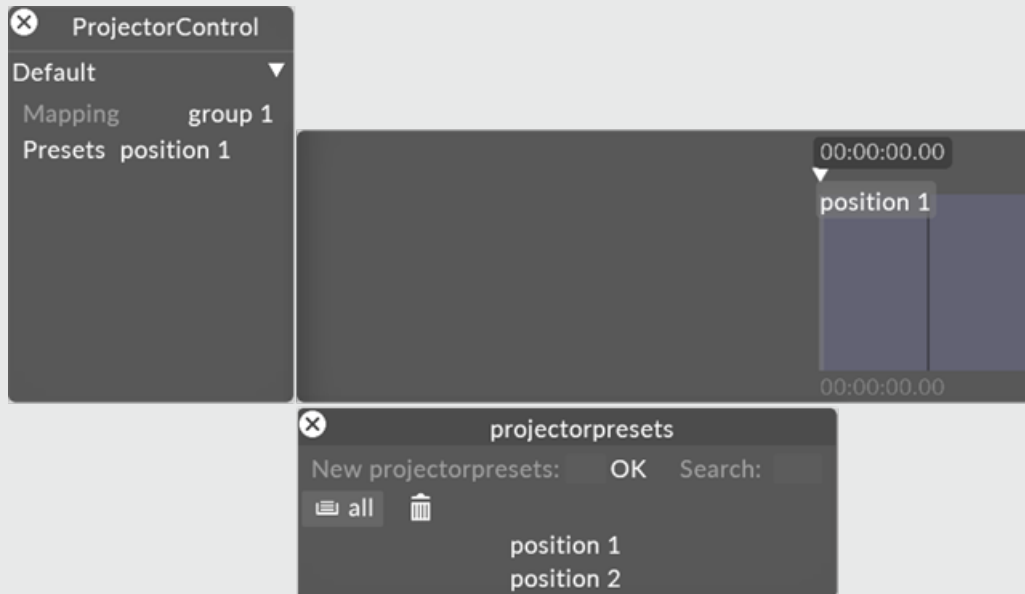

6. Add the desired projectors to the preset using the + and - buttons in the preset editor.
7. Choose values for their Pan/Tilt, Focus, Zoom, Lens Shift (V/H), Intensity, Recall and Configuration properties.

## Outputting to a projector

Once your ProjectorControl layer is animating projectors, the output to the physical projector is controlled via the ProjectorControl device.

# TimecodeMode

The TimecodeMode layer allows you to control whether Disguise software is chasing timecode or ignoring timecode. If it is set to default then the TimecodeMode layer will have no effect.

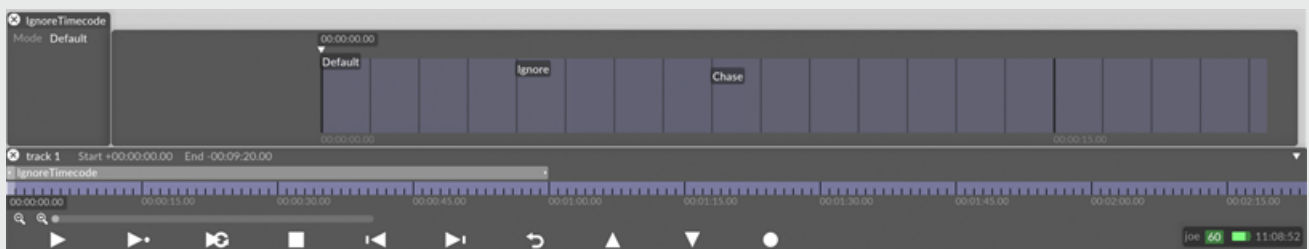

The layer allows you to change between the following timecode modes:

**Default** - The layer will have no effect.

**Ignore** - The layer will ignore incoming timecode for the duration of where the layer covers.

**Chase** - The layer will chase timecode. The chase mode is effectively saying "The timecode tags on this area of the timeline will be triggered".

# TrackJump

The TrackJump layer allows you to automatically jump between tracks. This can be useful in situations where you have a permanent or semi-permanent fixed installation that needs to continue running all day, switching from one track to the next or jumping between sections within the same track.

This layer works as follows: whenever the play cursor enters the extent of the layer and the cursor continues to move forward (and thus does not stop), Disguise software will jump to the track and section specified in the TrackJump layer and perform the specified action.

## TrackJump Layer Properties

### Track

This specifies which track Disguise software should jump to. If set to **None** or left empty, no track jump is issued and Disguise software stays in the same track.

### Section

This specifies which section number Disguise software should jump to; 0 means jump to the first section.

### Play mode

This specifies the transport control mode that Disguise software should enter when jumping to its destination. The options to choose from are **stop**, **play**, **play-to-end-of-section**, and **loop** section.

# TransportControl

The TransportControl layer is tool for triggering secondary transports from another transport.

The **TransportControl** layer is used for triggering other transports from the timeline. One important factor to be aware of with this layer, is that it cannot control it's own transport. Use of this layer requires multiple transport managers, assigned to a different Set List with different sets of tracks within each Set List.

As of r26.0, an additional **Location Type** field has been added to the **Transport Jump Commands**. Previously, you would enter a prefix of **CUE** to specify the location is a cue tag, otherwise it would default to a time relative to the start of the track.

From r26 onwards, the **Location Type** allows you to specify that the property is **MIDI**, **Cue**, **Timecode** or **Time**.

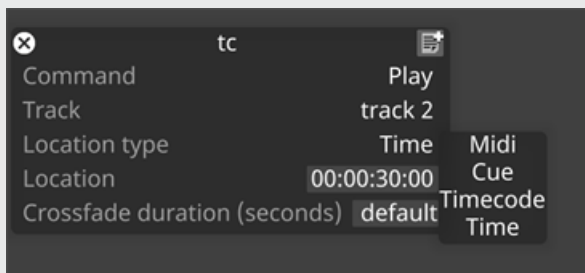

The *Location type* properties work as follows:

- **MIDI**: jump to midi tag <x>
- **Cue**: jump to cue tag <x>
- **Timecode**: jump to track timecode, relative to TC tags <hh:mm:ss:ff>
- **Time**: jump to absolute track timecode, unaffected by TC tags <hh:mm:ss:ff>

Also, prior to r26.0 any timecode values entered in the location field were absolute track time.

# TransportControl properties

**Transport** - defines the transport manager that should be triggered (cannot be the transport manager that contains the track that this layer is on).

**Command** - Allows for sequencing of TransportJumpCommand keyframe objects. This object specifies the Command (Play, Play to end of section, Loop section and Stop), the track to target, the location within the track (by specifying a cue number or timecode tag) and a crossfade duration.

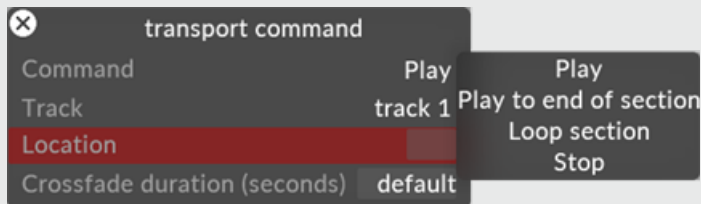

**Trigger** - Defines whether the command is triggered **Always** or **When playing**.

# TransportBrightnessLocal

The TransportBrightnessLocal layer replaces the need to use the Open layer to control the master brightness via keyframes changes on a track. The layer will work whenever it is on a track which is being played by the currently active Transport.

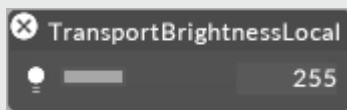

# TransportControl

The TransportControl layer is tool for triggering secondary transports from another transport.

The **TransportControl** layer is used for triggering other transports from the timeline. One important factor to be aware of with this layer, is that it cannot control it's own transport. Use of this layer requires multiple transport managers, assigned to a different Set List with different sets of tracks within each Set List.

As of r26.0, an additional **Location Type** field has been added to the **Transport Jump Commands**. Previously, you would enter a prefix of **CUE** to specify the location is a cue tag, otherwise it would default to a time relative to the start of the track.

From r26 onwards, the **Location Type** allows you to specify that the property is **MIDI**, **Cue**, **Timecode** or **Time**.

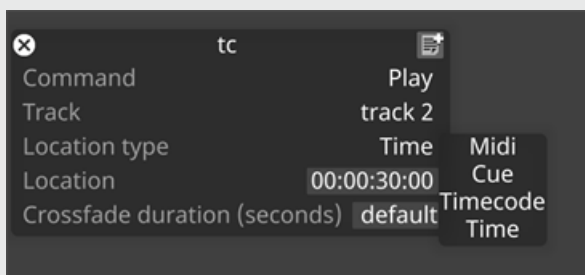

The *Location type* properties work as follows:

- **MIDI**: jump to midi tag <x>
- **Cue**: jump to cue tag <x>
- **Timecode**: jump to track timecode, relative to TC tags <hh:mm:ss:ff>
- **Time**: jump to absolute track timecode, unaffected by TC tags <hh:mm:ss:ff>

Also, prior to r26.0 any timecode values entered in the location field were absolute track time.

# TransportControl properties

**Transport** - defines the transport manager that should be triggered (cannot be the transport manager that contains the track that this layer is on).

**Command** - Allows for sequencing of TransportJumpCommand keyframe objects. This object specifies the Command (Play, Play to end of section, Loop section and Stop), the track to target, the location within the track (by specifying a cue number or timecode tag) and a crossfade duration.

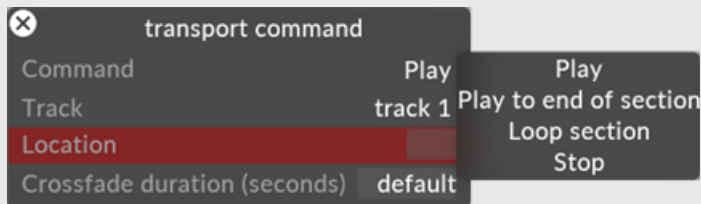

**Trigger** - Defines whether the command is triggered **Always** or **When playing**.



# TransportVolumeLocal

The TransportVolumeLocal layer replaces the need to use the open layer to control the master volume control via keyframes changes on a track. The layer will work whenever it is on a track which is being played by the currently active Transport.

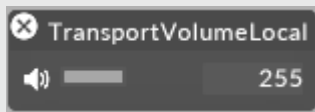

# Effect Layers Overview

Effect Layers can be used to apply visual effects to other layer types such as Video layers.

## Types of Effect layers

There are several types of Effect layers available within Disguise software:

[Blur](#)

[CDL](#)

[ChannelRouter](#)

[ColourAdjust](#)

[Compose](#)

[EdgeFilter](#)

[Fade](#)

[FilmicGrain](#)

[Kaleidoscope](#)

[Lut](#)

[MotionBlur](#)

[Noise](#)

[PixelMap](#)

[Pixelate](#)

[Scroll](#)

[SpinBitmap](#)

[Trigger](#)

[UVLookup](#)

[VideoTransition](#)

# Blur

The Blur layer blurs the content coming from another layers output.

All Effect layers take their source from other layer types - either content or generative - by use of an arrow. Linking two layers with an arrow defines the arrowed from layer as the source, and the arrowed to layer as the destination. If you have an arrow between a content layer and effect layer, it is said that the content layer is being 'piped in' to the effect layer. For more information on arrows, see the [compositing layers](#) topic.

To draw an arrow between two layers, hold down **ALT** and left click & drag between the source and destination layer.

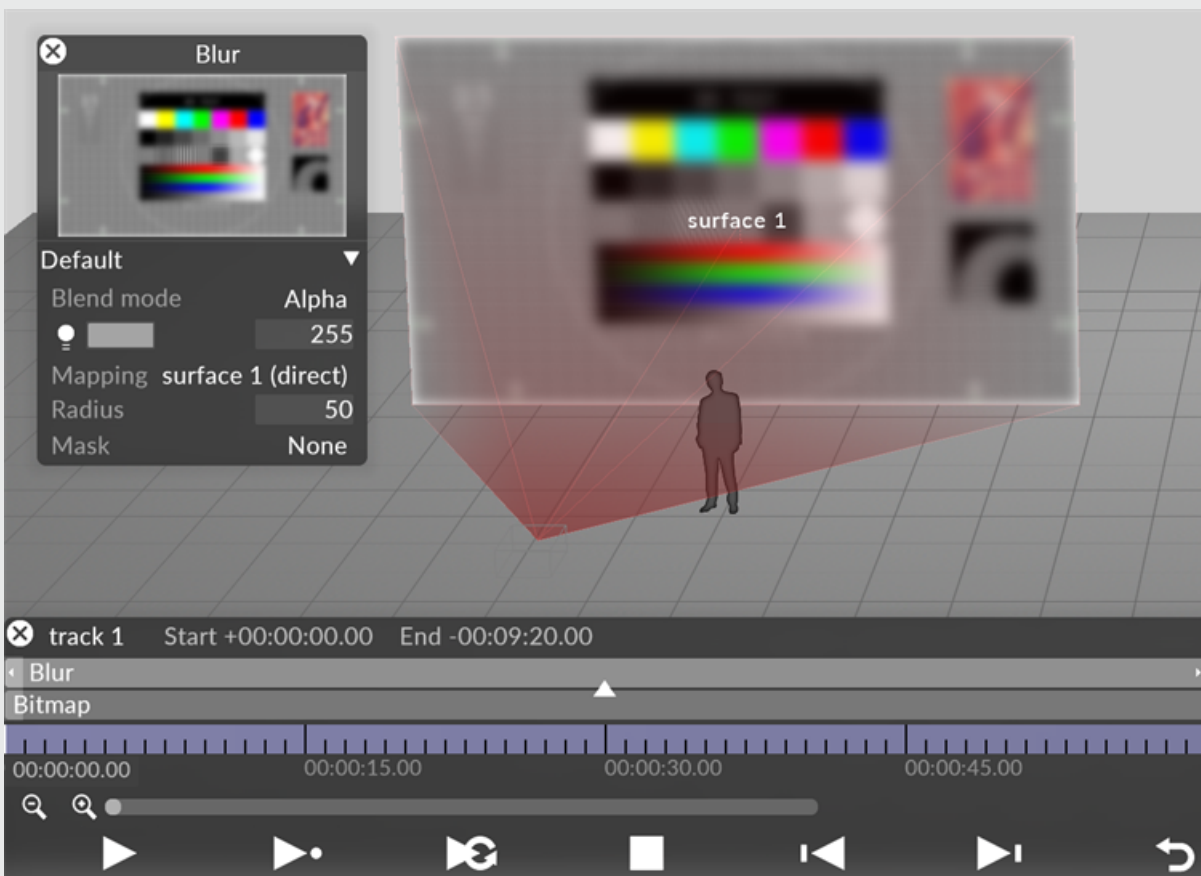

The Blur layer supports the use of Arrows, allowing content layers to be piped into the Blur layer. For more information please see the sub-chapter [Composing layers using Arrows](#).

## Common Layer Properties

BlendMode controls how the output of the layer is composited with the layers below. Layers are rendered in a bottom-up order: layers at the top can modify the output of the layers below.

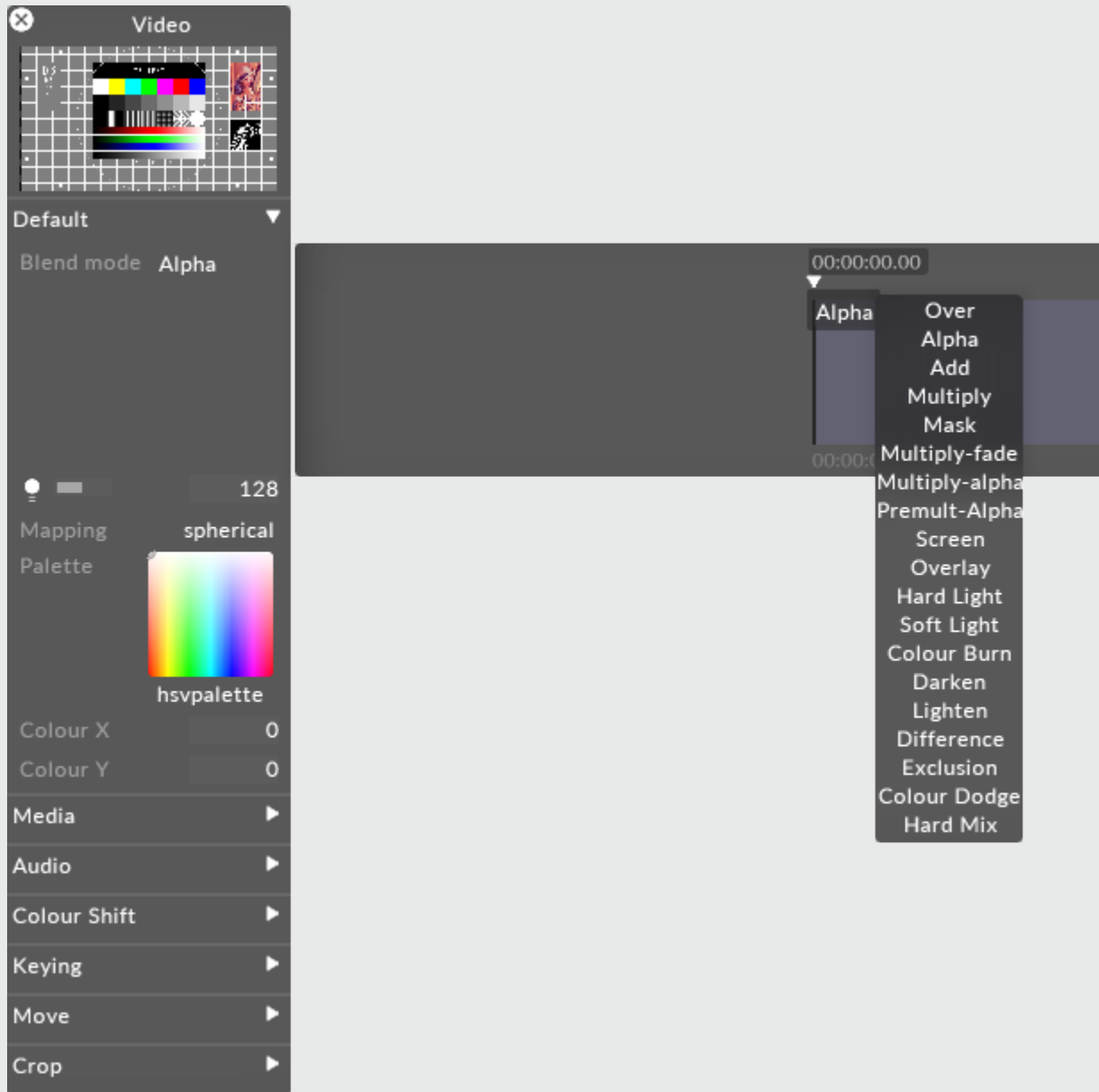

Changing brightness of a content layer in Disguise software is actually controlling the value of the alpha of the layer. Even when displaying a HAP video, the software will composite the layer with a controllable layer of alpha - one per layer.

There are two ways of expressing alpha in an image:

Straight alpha is an alpha channel which functions just like RGB. Alpha acts as a fourth channel of information per pixel which is as independent of the other three as R, G and B are of each other. For example, with straight alpha it is possible to have RGB = 255 (white) and alpha = 0 (fully transparent) on the same pixel. Internally generated content, such as gradient layer, are generated with straight alpha. This is the preferable style of alpha and considering the cleaner method of the two.

Premultiplied alpha takes the alpha and applies it to the values of the RGB channels per pixel. The more transparent something gets with premultiplied alpha, the closer it gets to black - as if the content is sitting on a black table. Premultiplied is the default output of Adobe Photoshop or AfterEffects. The result is our pixel at 255 RGB (full white) with 0 alpha would be calculated as a black pixel in the final image.

Here are explanations of what each individual blend mode will do.

## Over

Makes a layer fully opaque. Premultiplies all alpha onto the RGB value of each pixel. Alpha = black, so adjusting the brightness of a layer in Over blend mode makes it darker.

## Alpha

Default blend mode. It will apply alpha values as a transparency if the alpha is present. Brightness changes will make the layer more or less transparent.

## Add

Adds the value of each RGB pixel together. Always creates a brighter result. Values clamp at 255.

## Multiply

Reads the level of each subpixel as a level between 0.0 and 1.0, and multiplies source with blend. The result is always a darker image overall. For example: white x grey = 0.5. White turns transparent, black takes precedence. Alpha is applied in the same fashion as the Over Blend mode.

## Mask

Choose mask when you want to multiple out content upwards in the stack of layers, rather than downwards. In order to make this work you have to use the same mapping on the layer set to mask and the layer on top.

## Multiply-Fade

The same as Multiply, but will make use of the alpha channel to calculate transparency in the source and blend layers. Since maximum transparency is premultiplied, alpha results in black. This will ignore black created through premultiplying.

## Multiply-Alpha

Multiply with straight alpha. This mode assumes that the alpha has not been premultiplied onto the RGB values and will not apply a correction to the semi-transparent pixels.

## Premultiply Alpha

Like how Multiply-fade will ignore the darkening caused by premultiplying, this blend mode will do the same with Alpha.

## Colour Burn

Blend mode increases the contrast to darken the base colour while reflecting the blend colour. The darker the blend colour, the more intensely the colour will be applied in the base image. White as the blend colour produces no change. Using the colour burn blend mode can produce some harsh results at full opacity.

The colour burn blend mode can be used to make tonal and colour adjustments to a layer.

## Screen

This blend mode looks at each channels colour information and multiplies the inverse of the blend and base colour. The result is always a lighter colour. Screening with black leaves the colour unchanged. Screening with white produces white. The effect is similar to projecting multiple images on top of each other - where bright white is fully opaque, black is fully transparent and 50% grey is 50% transparent.

## Overlay

Multiplies or screens the colours, depending on the base colour. Patterns or colours overlay the existing pixels while preserving the highlights and shadows of the base colour. The base colour is not replaced, but mixed with the blend colour to reflect the lightness or darkness of the original colour.

## Hard Light

Multiplies or screens the colours, depending on the blend colour. The effects is similar to shining a harsh spotlight on the image. If the blend colour (light source/top layer) is lighter than 50% grey, the image is lightened as if it were screened. This is useful for adding highlights to an image. If the blend colour is darker than 50% grey, the image is darkened as if it were multiplied. This is useful for adding shadows to an image. Painting with pure black or white results in pure black or white.

## Soft Light

Darkens or lightens the colours, depending on the blend colour. The effect is similar to shining a diffused spotlight on the image. If the blend colour (light source/top layer) is lighter than 50% grey, the image is lightened as if it were dodged. If the blend colour is darker than 50% grey, the image is darkened as if it were burned in. Painting with pure black or white produces a distinctly darker or lighter area, but does not result in pure black or white.

## Darken

Looks as the colour information in each channel and selects the base or blend colour - whichever is darker - as the result colour. Pixels lighter than the blend colour are replaced and pixels darker than the blend colour do not change.

## Lighten

Looks at the colour information in each channel and selects the base or blend colour - whichever is lighter - as the result colour. Pixels darker than the blend colour are replaced and pixels lighter than the blend colour do not change.

## Difference

Looks at the colour information in each channel and subtracts either the blend colour from the base colour or the base colour from the blend colour depending on which has the greater brightness value. Blending with white inverts the base colour values and blending with black produces no change.

## Exclusion

Creates an effects similar to but lower in contrast than the difference mode. Blending with white inverts the base colour values. Blending with black produces no change.



## Colour Dodge

Looks at the colour information in each channel and brightens the base colour to reflect the blend colour by decreasing contrast between the two. Blending with black produces no change.

## Hard Mix

Adds the RGB channels of the blend colour to the RGB values of the base colour. If the resulting sum for a channel is 255 or greater, it receives a value of 255; if it is less than 255 it receives a value of 0. Therefore all blended pixels have RGB channels of either 0 or 255. This changes all pixels to primary additive colours (RGB), white or black.

## Brightness

This property (which appears as a light bulb icon) controls the brightness of the layer output.

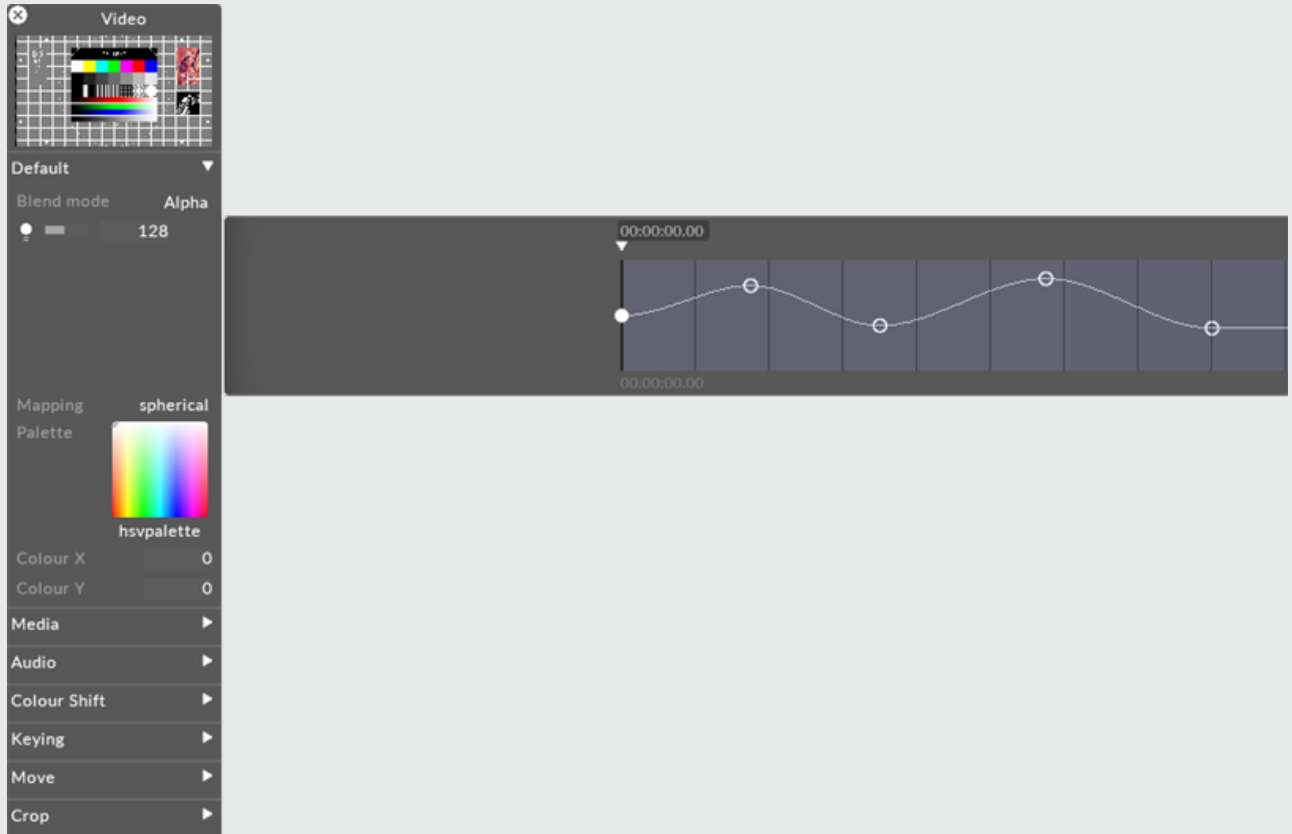

If the layers blend mode is set to Alpha, then reducing the brightness to 0 also reduces the opacity of the layer to 0. This can be useful when you want to dissolve from one layer to the next. In that case, you can place the new layer above the old layer and increase its brightness level.

## Mapping

The mapping property controls how the layer output is mapped onto the screen(s) in the Stage level.

**Video**

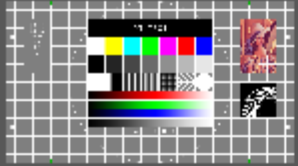

Default ▾

Blend mode Alpha

128

Mapping direct map 1

Palette



hsvpalette

Colour X 0

Colour Y 0

Media ▾

Video



d3\_test\_16-9.png

Speed 1

Mode Normal

At end point Loop

Transition time 0

Audio ▶

Colour Shift ▶

Keying ▶

Move ▶

Crop ▶

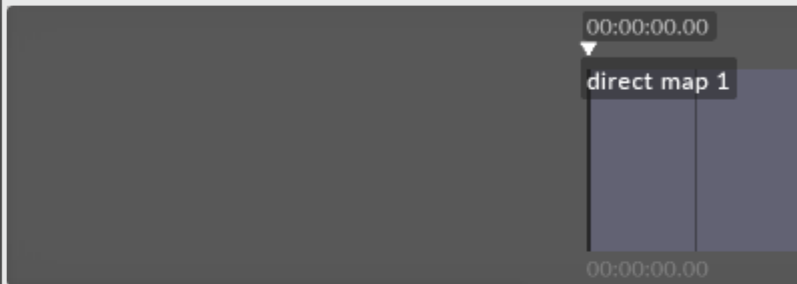

00:00:00.00

direct map 1

00:00:00.00

**mappings**

New mapping: OK Search:

all New Mappings

- direct map 1
- feed map 2
- feed mapping
- mapping 1
- mapping 2
- parallel
- spherical

For information on mapping, including how to use the different mapping types offered by Disguise software, please see the chapter [Content Mapping](#).

## Blur layer properties

### Radius

The amplitude of the blur effect. Default value is 6. This number is a percentage. The min/max values are 0 and 50. Decreasing the value from 6 to 0 will sharpen the content, whilst increasing the value from 6 to 50 will gradually amplify the blurriness of the content.

### BlurMask

Applies blur based on a gray-scale still image. White areas will generate maximum blur; black areas will ignore blur.

# ChannelRouter

The ChannelRouter layer creates an RGBA image made up from any combination of the RGBA components from up to two input sources. This can be used to correct problems with a source image, to verify the components of the input sources or for many artistic purposes.

All Effect layers take their source from other layer types - either content or generative - by use of an arrow. Linking two layers with an arrow defines the arrowed from layer as the source, and the arrowed to layer as the destination. If you have an arrow between a content layer and effect layer, it is said that the content layer is being 'piped in' to the effect layer. For more information on arrows, see the [compositing layers](#) topic.

To draw an arrow between two layers, hold down **ALT** and left click & drag between the source and destination layer.

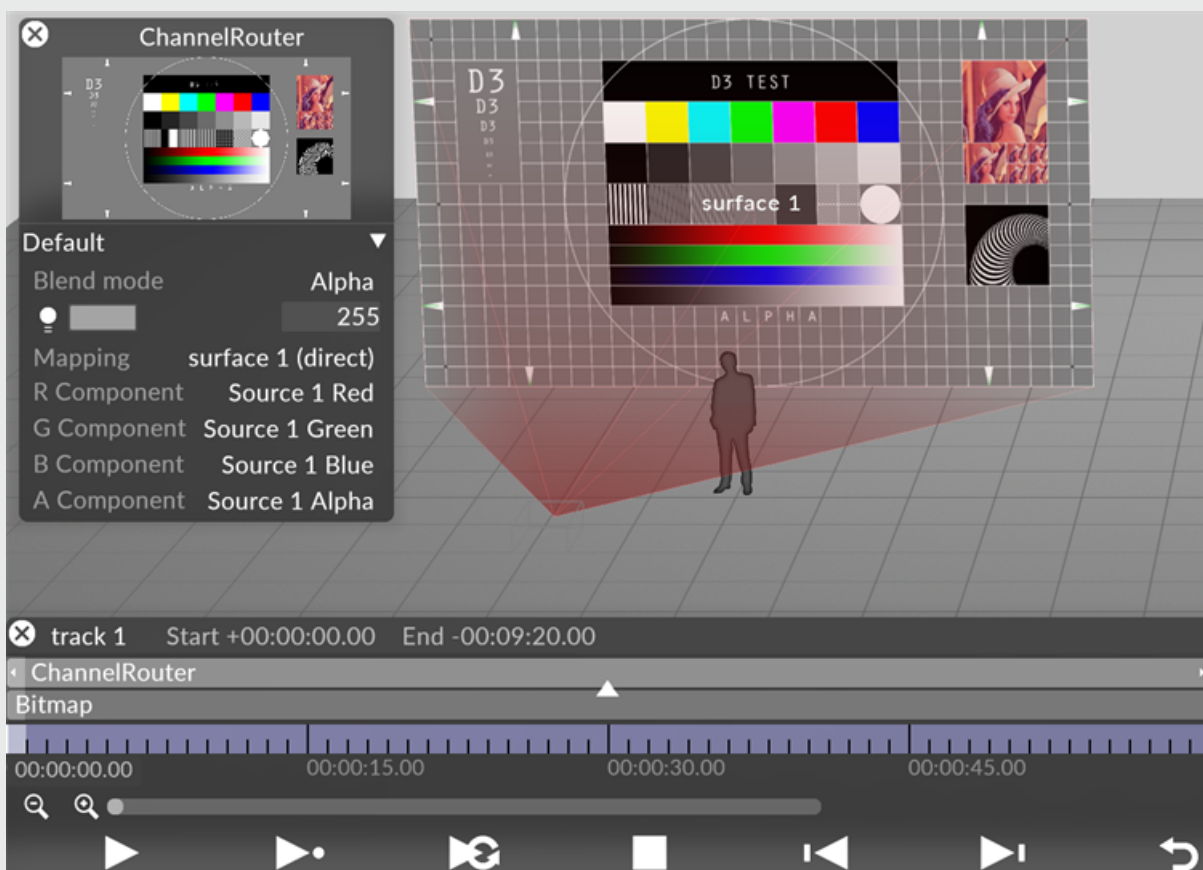

**Please note:** The order and direction of arrowing between layers is important. Drag a pipe from the content source layer into the ChannelRouter layer to achieve the result shown in the image.

## Potential uses for the ChannelRouter Layer

### Alpha channel substitution

- Take the alpha from one input and apply it to the other. This can be used for artistic masking effects. (Settings: R=Source 1 Red, G=Source 1 Green, B=Source 1 Blue, A=Source 2 Alpha)

### Alpha channel removal

- Remove the alpha channel from a source image by setting the layer's alpha component to a constant value of 1. Settings: R=Source 1 Red, G=Source 1 Green, B=Source 1 Blue, A=Constant 1

### Synthesising an alpha channel

- Input sources that you require to have an alpha channel but do not can often have satisfactory alpha channels synthesised from their luma channel. Settings: R=Source 1 Red, G=Source 1 Green, B=Source 1 Blue, A=Luma 1

### Channel correction

- An image supplied in BGR format can be fixed by rearranging it to RGB. Settings: R=Source 1 Blue, G=Source 1 Green, B=Source 1 Red, A=Alpha 1

### Image debugging

- Separately view each component from an input source to verify that they all appear as expected. Settings: R=Source 1 Red, G=Source 1 Red, B=Source 1 Red, A=Constant 1

# Blend Mode

BlendMode controls how the output of the layer is composited with the layers below. Layers are rendered in a bottom-up order: layers at the top can modify the output of the layers below.

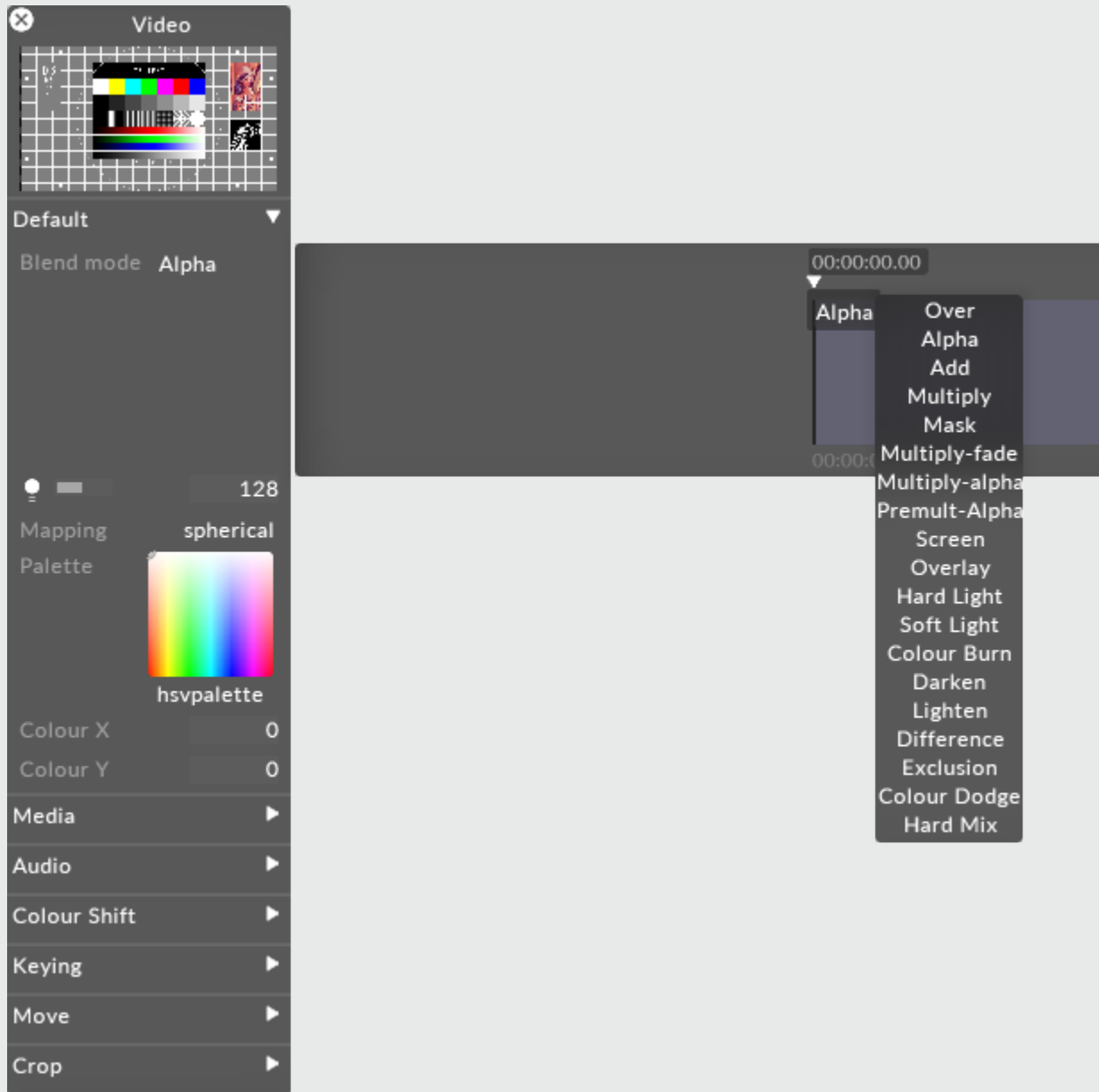

Changing brightness of a content layer in Disguise software is actually controlling the value of the alpha of the layer. Even when displaying a HAP video, the software will composite the layer with a controllable layer of alpha - one per layer.



There are two ways of expressing alpha in an image:

Straight alpha is an alpha channel which functions just like RGB. Alpha acts as a fourth channel of information per pixel which is as independent of the other three as R, G and B are of each other. For example, with straight alpha it is possible to have RGB = 255 (white) and alpha = 0 (fully transparent) on the same pixel. Internally generated content, such as gradient layer, are generated with straight alpha. This is the preferable style of alpha and considering the cleaner method of the two.

Premultiplied alpha takes the alpha and applies it to the values of the RGB channels per pixel. The more transparent something gets with premultiplied alpha, the closer it gets to black - as if the content is sitting on a black table. Premultiplied is the default output of Adobe Photoshop or AfterEffects. The result is our pixel at 255 RGB (full white) with 0 alpha would be calculated as a black pixel in the final image.

Here are explanations of what each individual blend mode will do.

## Over

Makes a layer fully opaque. Premultiplies all alpha onto the RGB value of each pixel. Alpha = black, so adjusting the brightness of a layer in Over blend mode makes it darker.

## Alpha

Default blend mode. It will apply alpha values as a transparency if the alpha is present. Brightness changes will make the layer more or less transparent.

## Add

Adds the value of each RGB pixel together. Always creates a brighter result. Values clamp at 255.

## Multiply

Reads the level of each subpixel as a level between 0.0 and 1.0, and multiplies source with blend. The result is always a darker image overall. For example: white x grey = 0.5. White turns transparent, black takes precedence. Alpha is applied in the same fashion as the Over Blend mode.

## Mask

Choose mask when you want to multiple out content upwards in the stack of layers, rather than downwards. In order to make this work you have to use the same mapping on the layer set to mask and the layer on top.

## Multiply-Fade

The same as Multiply, but will make use of the alpha channel to calculate transparency in the source and blend layers. Since maximum transparency is premultiplied, alpha results in black. This will ignore black created through premultiplying.

## Multiply-Alpha

Multiply with straight alpha. This mode assumes that the alpha has not been premultiplied onto the RGB values and will not apply a correction to the semi-transparent pixels.

## Premultiply Alpha

Like how Multiply-fade will ignore the darkening caused by premultiplying, this blend mode will do the same with Alpha.

## Colour Burn

Blend mode increases the contrast to darken the base colour while reflecting the blend colour. The darker the blend colour, the more intensely the colour will be applied in the base image. White as the blend colour produces no change. Using the colour burn blend mode can produce some harsh results at full opacity.

The colour burn blend mode can be used to make tonal and colour adjustments to a layer.

## Screen

This blend mode looks at each channels colour information and multiplies the inverse of the blend and base colour. The result is always a lighter colour. Screening with black leaves the colour unchanged. Screening with white produces white. The effect is similar to projecting multiple images on top of each other - where bright white is fully opaque, black is fully transparent and 50% grey is 50% transparent.

## Overlay

Multiplies or screens the colours, depending on the base colour. Patterns or colours overlay the existing pixels while preserving the highlights and shadows of the base colour. The base colour is not replaced, but mixed with the blend colour to reflect the lightness or darkness of the original colour.

## Hard Light

Multiplies or screens the colours, depending on the blend colour. The effect is similar to shining a harsh spotlight on the image. If the blend colour (light source/top layer) is lighter than 50% grey, the image is lightened as if it were screened. This is useful for adding highlights to an image. If the blend colour is darker than 50% grey, the image is darkened as if it were multiplied. This is useful for adding shadows to an image. Painting with pure black or white results in pure black or white.

## Soft Light

Darkens or lightens the colours, depending on the blend colour. The effect is similar to shining a diffused spotlight on the image. If the blend colour (light source/top layer) is lighter than 50% grey, the image is lightened as if it were dodged. If the blend colour is darker than 50% grey, the image is darkened as if it were burned in. Painting with pure black or white produces a distinctly darker or lighter area, but does not result in pure black or white.

## Darken

Looks at the colour information in each channel and selects the base or blend colour - whichever is darker - as the result colour. Pixels lighter than the blend colour are replaced and pixels darker than the blend colour do not change.

## Lighten

Looks at the colour information in each channel and selects the base or blend colour - whichever is lighter - as the result colour. Pixels darker than the blend colour are replaced and pixels lighter than the blend colour do not change.

## Difference

Looks at the colour information in each channel and subtracts either the blend colour from the base colour or the base colour from the blend colour depending on which has the greater brightness value.

Blending with white inverts the base colour values and blending with black produces no change.

## Exclusion

Creates an effects similar to but lower in contrast than the difference mode. Blending with white inverts the base colour values. Blending with black produces no change.

## Colour Dodge

Looks at the colour information in each channel and brightens the base colour to reflect the blend colour by decreasing contrast between the two. Blending with black produces no change.

## Hard Mix

Adds the RGB channels of the blend colour to the RGB values of the base colour. If the resulting sum for a channel is 255 or greater, it receives a value of 255; if it is less than 255 it receives a value of 0. Therefore all blended pixels have RGB channels of either 0 or 255. This changes all pixels to primary additive colours (RGB), white or black.

## Brightness

This property (which appears as a light bulb icon) controls the brightness of the layer output.

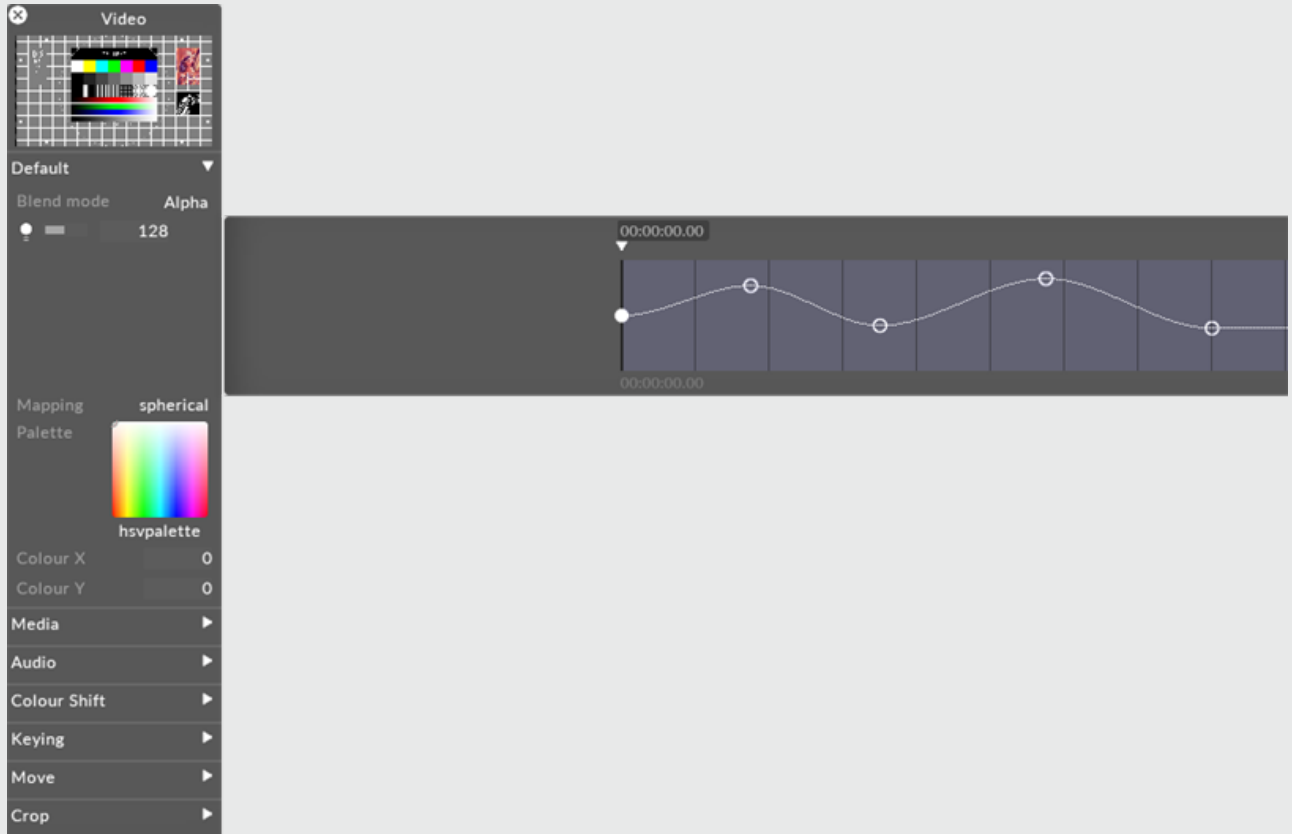

If the layers blend mode is set to Alpha, then reducing the brightness to 0 also reduces the opacity of the layer to 0. This can be useful when you want to dissolve from one layer to the next. In that case, you can place the new layer above the old layer and increase its brightness level.

## Mapping

The mapping property controls how the layer output is mapped onto the screen(s) in the Stage level.

**Video**

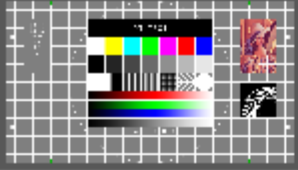

Default ▾

Blend mode Alpha

128

Mapping direct map 1

Palette



hsvpalette

Colour X 0

Colour Y 0

Media ▾

Video



d3\_test\_16-9.png

Speed 1

Mode Normal

At end point Loop

Transition time 0

Audio ▶

Colour Shift ▶

Keying ▶

Move ▶

Crop ▶

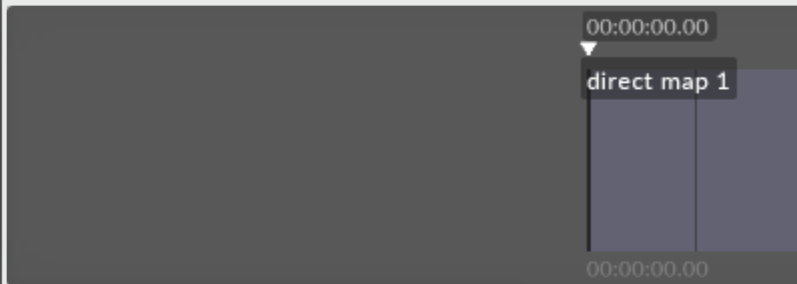

00:00:00.00

direct map 1

00:00:00.00

**mappings**

New mapping: OK Search:

all New Mappings

- direct map 1
- feed map 2
- feed mapping
- mapping 1
- mapping 2
- parallel
- spherical

For information on mapping, including how to use the different mapping types offered by Disguise software, please see the chapter [Content Mapping](#).

## R Component

Determines which input component appears in the red channel of the layer's output.

## G Component

Determines which input component appears in the green channel of the layer's output.

## B Component

Determines which input component appears in the blue channel of the layer's output.

## A Component

Determines which input component appears in the alpha channel of the layer's output.

The value for each of the four component properties above can be selected from the following list:

- Source 1 Red - Red component of source 1
- Source 1 Green - Green component of source 1
- Source 1 Blue - Blue component of source 1
- Source 1 Alpha - Alpha component of source 1
- Source 1 Luma - Luma (effectively similar to greyscale) value of source 1
- Source 1 Max RGB - Strongest of source 1's red, green and blue components

- Source 1 Min RGB - Weakest of source 1's red, green and blue components
- Source 2 Red - Red component of source 2
- Source 2 Green - Green component of source 2
- Source 2 Blue - Blue component of source 2
- Source 2 Alpha - Alpha component of source 2
- Source 2 Luma - Luma (effectively similar to greyscale) value of source 2
- Source 2 Max RGB - Strongest of source 2's red, green and blue components
- Source 2 Min RGB - Weakest of source 2's red, green and blue components
- Constant 0 - A constant value of 0
- Constant 1 - A constant value of 1



# ColourAdjust

The ColourAdjust layer is best suited to changing colour properties in a familiar set values.

## Overview

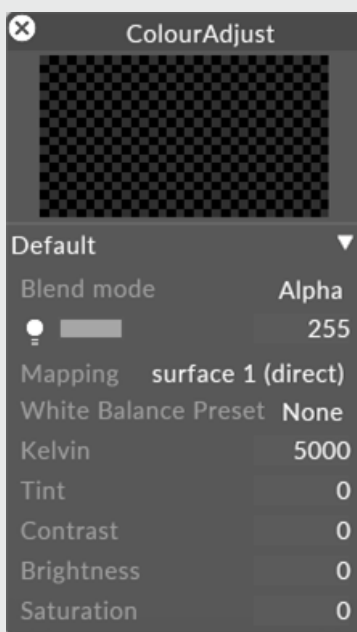

The ColourAdjust layer is designed to control white balance and tint either through presets or discrete amounts.

## Workflow

All Effect layers take their source from other layer types - either content or generative - by use of an arrow. Linking two layers with an arrow defines the arrowed from layer as the source, and the arrowed to layer as the destination. If you have an arrow between a content layer and effect layer, it is said that the content layer is being 'piped in' to the effect layer. For more information on arrows, see the [compositing layers](#) topic.

To draw an arrow between two layers, hold down **ALT** and left click & drag between the source and destination layer.

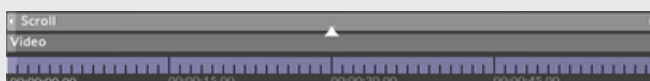

1. Add a ColourAdjust layer to your track. For more information about adding layers see [creating layers](#).
2. Arrow from your media layer to the ColourAdjust layer so the compositing order looks something like the following image.

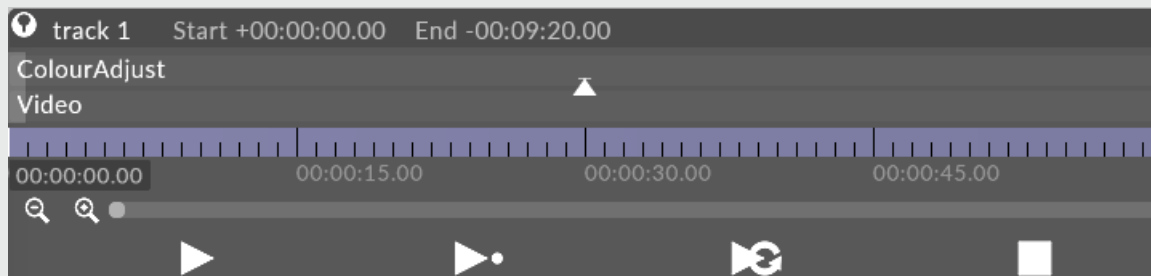

*Video layer piped into a ColourAdjust layer on the timeline.*

For more information on arrowing, see [compositing layers](#).

3. Adjust the ColourAdjust layer properties to suit your desired sequencing.

## Common layer properties

### Blend mode

BlendMode controls how the output of the layer is composited with the layers below. Layers are rendered in a bottom-up order: layers at the top can modify the output of the layers below.

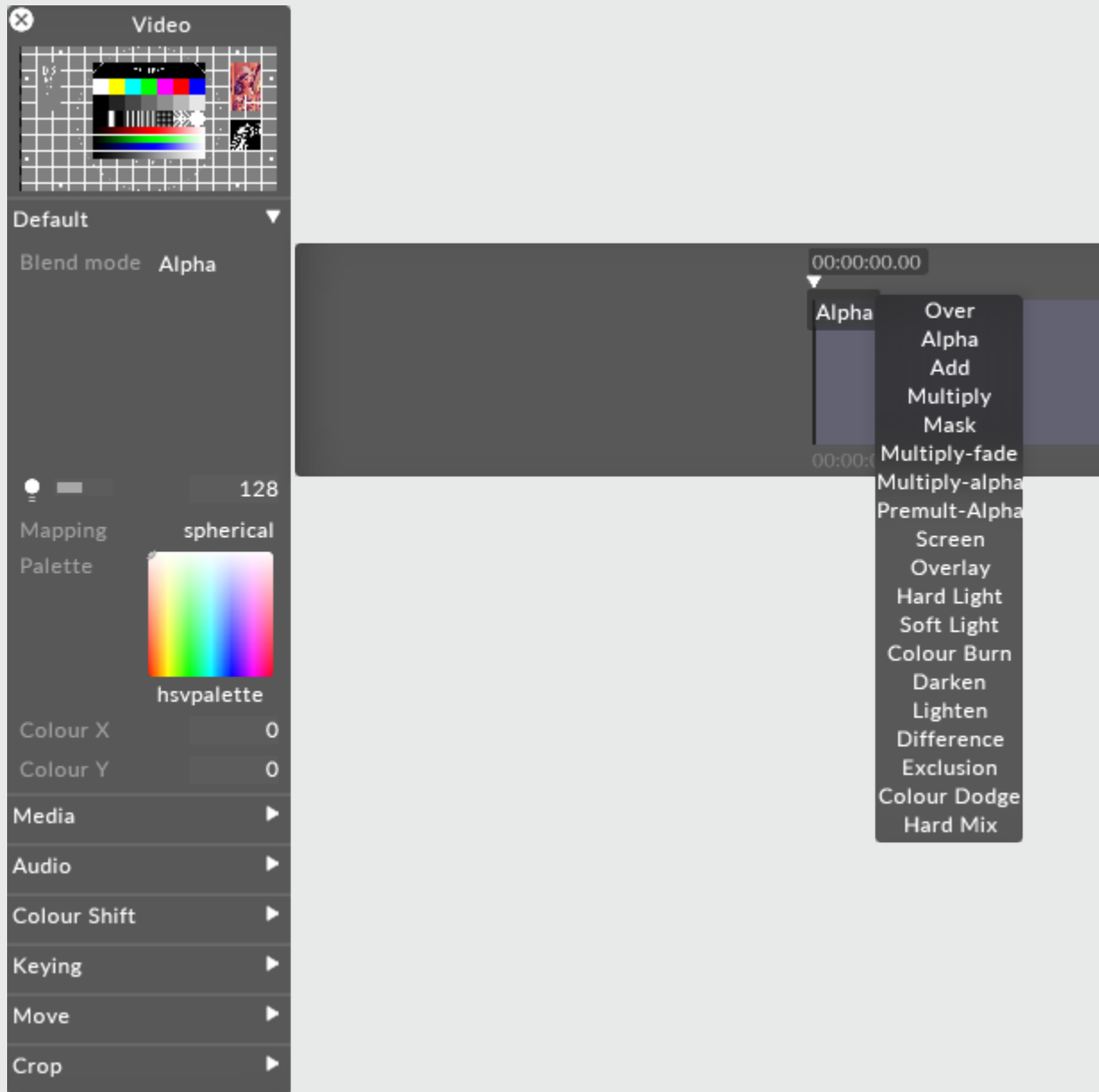

Changing brightness of a content layer in Disguise software is actually controlling the value of the alpha of the layer. Even when displaying a HAP video, the software will composite the layer with a controllable layer of alpha - one per layer.

There are two ways of expressing alpha in an image:

Straight alpha is an alpha channel which functions just like RGB. Alpha acts as a fourth channel of information per pixel which is as independent of the other three as R, G and B are of each other. For example, with straight alpha it is possible to have RGB = 255 (white) and alpha = 0 (fully transparent) on the same pixel. Internally generated content, such as gradient layer, are generated with straight alpha. This is the preferable style of alpha and considering the cleaner method of the two.

Premultiplied alpha takes the alpha and applies it to the values of the RGB channels per pixel. The more transparent something gets with premultiplied alpha, the closer it gets to black - as if the content is sitting on a black table. Premultiplied is the default output of Adobe Photoshop or AfterEffects. The result is our pixel at 255 RGB (full white) with 0 alpha would be calculated as a black pixel in the final image.

Here are explanations of what each individual blend mode will do.

## Over

Makes a layer fully opaque. Premultiplies all alpha onto the RGB value of each pixel. Alpha = black, so adjusting the brightness of a layer in Over blend mode makes it darker.

## Alpha

Default blend mode. It will apply alpha values as a transparency if the alpha is present. Brightness changes will make the layer more or less transparent.

## Add

Adds the value of each RGB pixel together. Always creates a brighter result. Values clamp at 255.

## Multiply

Reads the level of each subpixel as a level between 0.0 and 1.0, and multiplies source with blend. The result is always a darker image overall. For example: white x grey = 0.5. White turns transparent, black takes precedence. Alpha is applied in the same fashion as the Over Blend mode.

## Mask

Choose mask when you want to multiple out content upwards in the stack of layers, rather than downwards. In order to make this work you have to use the same mapping on the layer set to mask and the layer on top.

## Multiply-Fade

The same as Multiply, but will make use of the alpha channel to calculate transparency in the source and blend layers. Since maximum transparency is premultiplied, alpha results in black. This will ignore black created through premultiplying.

## Multiply-Alpha

Multiply with straight alpha. This mode assumes that the alpha has not been premultiplied onto the RGB values and will not apply a correction to the semi-transparent pixels.

## Premultiply Alpha

Like how Multiply-fade will ignore the darkening caused by premultiplying, this blend mode will do the same with Alpha.

## Colour Burn

Blend mode increases the contrast to darken the base colour while reflecting the blend colour. The darker the blend colour, the more intensely the colour will be applied in the base image. White as the blend colour produces no change. Using the colour burn blend mode can produce some harsh results at full opacity.

The colour burn blend mode can be used to make tonal and colour adjustments to a layer.

## Screen

This blend mode looks at each channels colour information and multiplies the inverse of the blend and base colour. The result is always a lighter colour. Screening with black leaves the colour unchanged. Screening with white produces white. The effect is similar to projecting multiple images on top of each other - where bright white is fully opaque, black is fully transparent and 50% grey is 50% transparent.

## Overlay

Multiplies or screens the colours, depending on the base colour. Patterns or colours overlay the existing pixels while preserving the highlights and shadows of the base colour. The base colour is not replaced, but mixed with the blend colour to reflect the lightness or darkness of the original colour.

## Hard Light

Multiplies or screens the colours, depending on the blend colour. The effect is similar to shining a harsh spotlight on the image. If the blend colour (light source/top layer) is lighter than 50% grey, the image is lightened as if it were screened. This is useful for adding highlights to an image. If the blend colour is darker than 50% grey, the image is darkened as if it were multiplied. This is useful for adding shadows to an image. Painting with pure black or white results in pure black or white.

## Soft Light

Darkens or lightens the colours, depending on the blend colour. The effect is similar to shining a diffused spotlight on the image. If the blend colour (light source/top layer) is lighter than 50% grey, the image is lightened as if it were dodged. If the blend colour is darker than 50% grey, the image is darkened as if it were burned in. Painting with pure black or white produces a distinctly darker or lighter area, but does not result in pure black or white.

## Darken

Looks at the colour information in each channel and selects the base or blend colour - whichever is darker - as the result colour. Pixels lighter than the blend colour are replaced and pixels darker than the blend colour do not change.

## Lighten

Looks at the colour information in each channel and selects the base or blend colour - whichever is lighter - as the result colour. Pixels darker than the blend colour are replaced and pixels lighter than the blend colour do not change.

## Difference

Looks at the colour information in each channel and subtracts either the blend colour from the base colour or the base colour from the blend colour depending on which has the greater brightness value.

Blending with white inverts the base colour values and blending with black produces no change.

## Exclusion

Creates an effects similar to but lower in contrast than the difference mode. Blending with white inverts the base colour values. Blending with black produces no change.

## Colour Dodge

Looks at the colour information in each channel and brightens the base colour to reflect the blend colour by decreasing contrast between the two. Blending with black produces no change.

## Hard Mix

Adds the RGB channels of the blend colour to the RGB values of the base colour. If the resulting sum for a channel is 255 or greater, it receives a value of 255; if it is less than 255 it receives a value of 0. Therefore all blended pixels have RGB channels of either 0 or 255. This changes all pixels to primary additive colours (RGB), white or black.

## Brightness

This property (which appears as a light bulb icon) controls the brightness of the layer output.

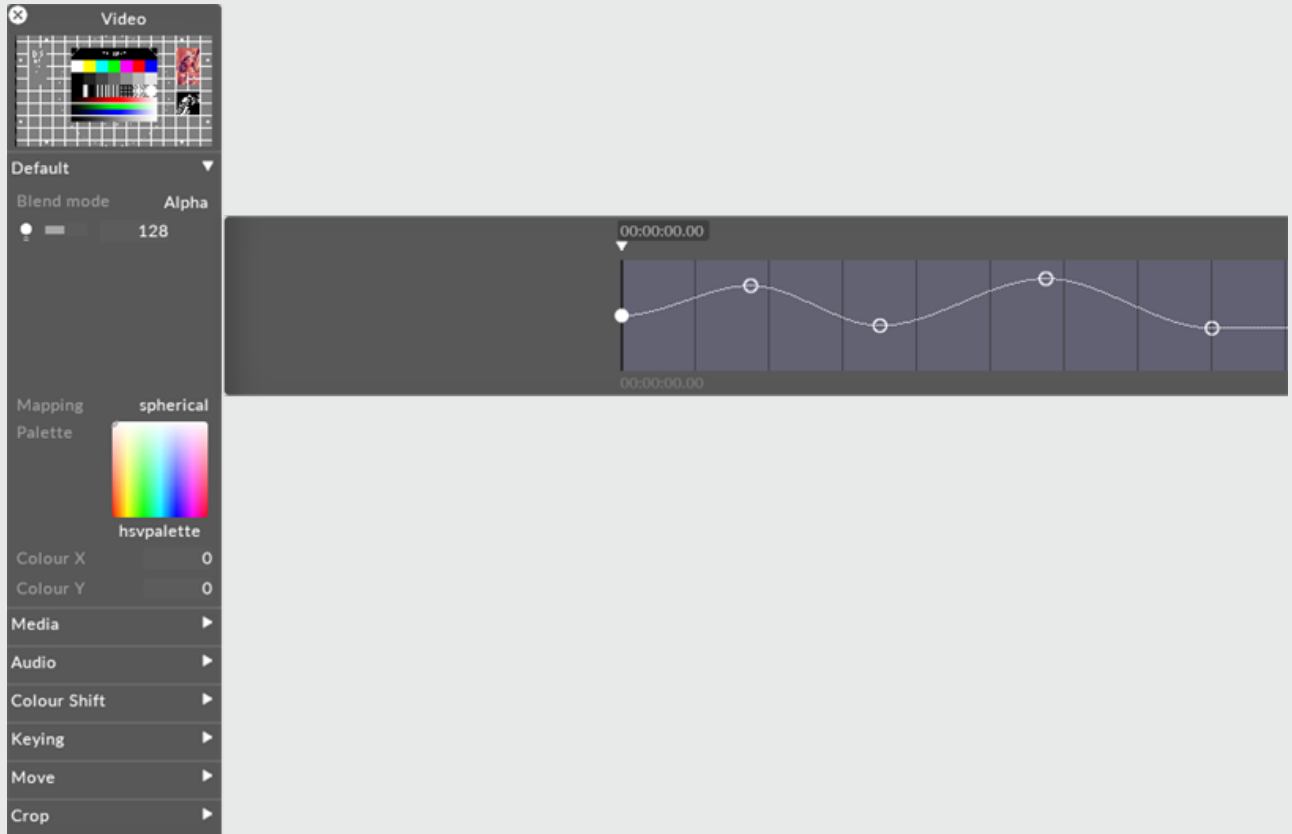

If the layers blend mode is set to Alpha, then reducing the brightness to 0 also reduces the opacity of the layer to 0. This can be useful when you want to dissolve from one layer to the next. In that case, you can place the new layer above the old layer and increase its brightness level.

## Mapping

The mapping property controls how the layer output is mapped onto the screen(s) in the Stage level.



**Video**

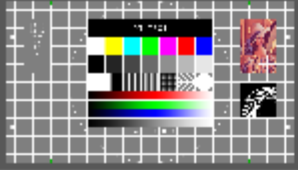

Default ▾

Blend mode Alpha

128

Mapping direct map 1

Palette



hsvpalette

Colour X 0

Colour Y 0

Media ▾

Video



d3\_test\_16-9.png

Speed 1

Mode Normal

At end point Loop

Transition time 0

Audio ▶

Colour Shift ▶

Keying ▶

Move ▶

Crop ▶

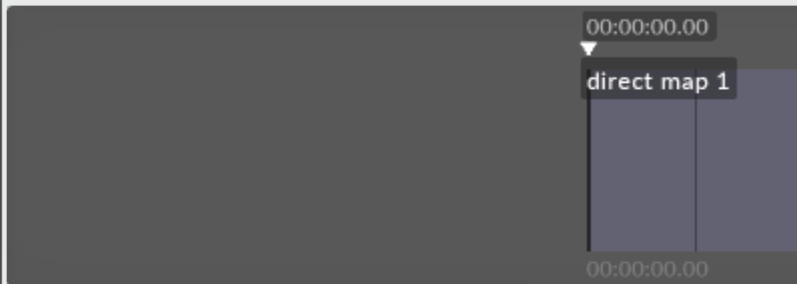

00:00:00.00

direct map 1

00:00:00.00

**mappings**

New mapping: OK Search:

all New Mappings

- direct map 1
- feed map 2
- feed mapping
- mapping 1
- mapping 2
- parallel
- spherical

For information on mapping, including how to use the different mapping types offered by Disguise software, please see the chapter [Content Mapping](#).

## White balance preset

This property defines which White balance preset is used.

The following options are available.

- None
- Custom
- Daylight
- Shade
- Cloudy
- Tungsten
- Florescent
- Flash

Once you have selected a preset, you cannot keyframe Kelvin & Tint.

## Kelvin

This property controls the Kelvin in degrees kelvin.

## Tint

This property controls tint and allows you to fine-tune the green/magenta balance. The scale on the slider represents the actual Kelvin value, which is subject to slight variations from camera to camera.

## Contrast

This property controls contrast.

## Brightness

This property controls brightness.

## Saturation

This property controls saturation.

## Levels

Levels is a tool in the ColourAdjust layer which can move and stretch the brightness levels of an image histogram. It has the power to adjust brightness, contrast, and tonal range by specifying the location of complete black, complete white, and midtones in a histogram. Since every piece of content's histogram is unique, there is no single way to adjust the levels for all your content. A proper understanding of how to adjust the levels of an image histogram will help you better represent tones in the final image.

# Compose

The Compose layer takes multiple inputs, for example live camera input, and composes the inputs next to each other on a screen. The Compose layer can also blur the edges between the inputs enabling seamless edges.

All Effect layers take their source from other layer types - either content or generative - by use of an arrow. Linking two layers with an arrow defines the arrowed from layer as the source, and the arrowed to layer as the destination. If you have an arrow between a content layer and effect layer, it is said that the content layer is being 'piped in' to the effect layer. For more information on arrows, see the [compositing layers](#) topic.

To draw an arrow between two layers, hold down **ALT** and left click & drag between the source and destination layer.



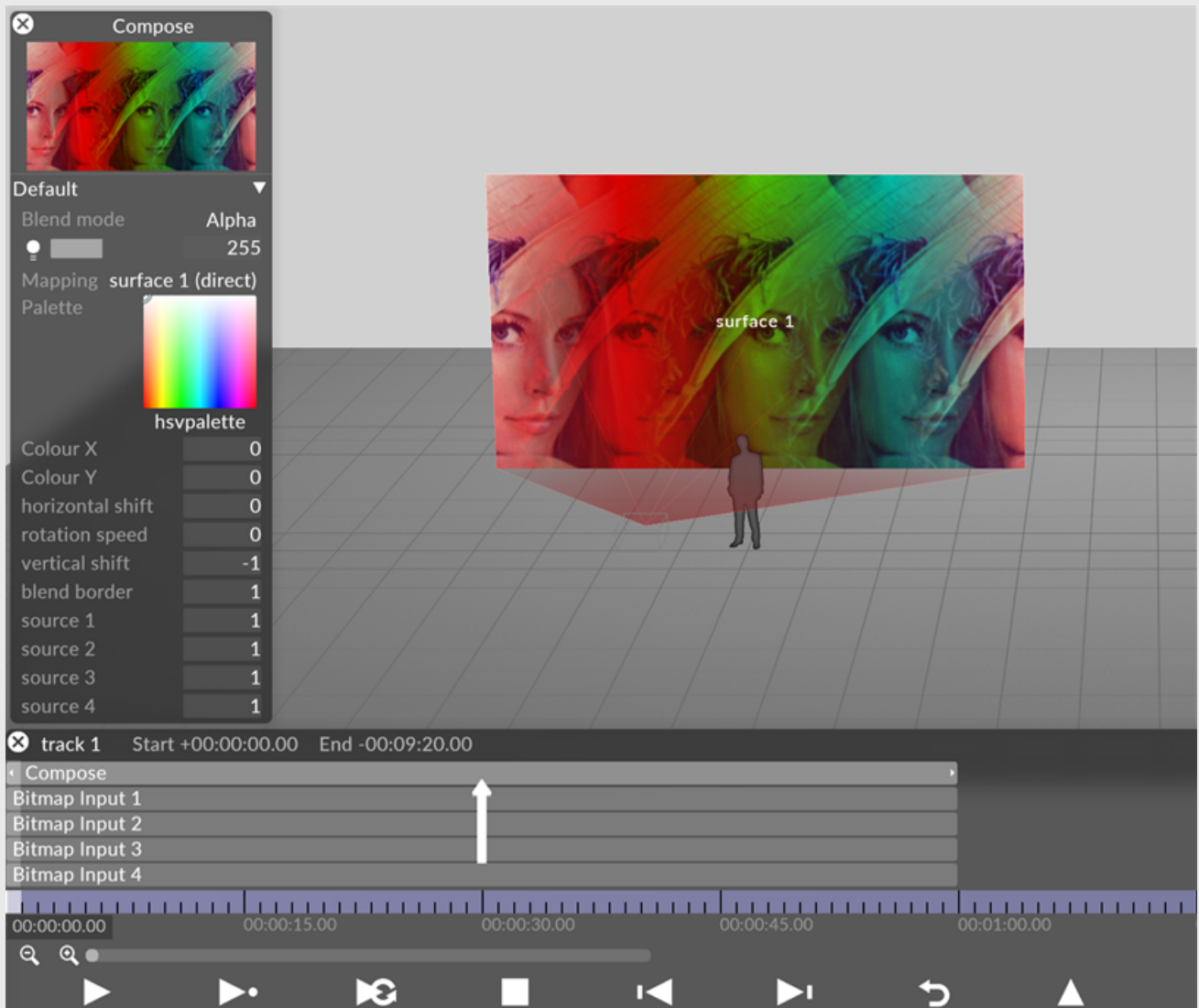

The Compose layer supports the use of Arrows, allowing content layers to be piped into the Compose layer. For more information please see the sub-chapter [Composing layers using Arrows](#).

## Using the Compose layer

1. Create the input layers. These can be any content layer ([Bitmap layer](#), [Video layer](#), etc) or a combination. For the example here we are using Bitmap layers.

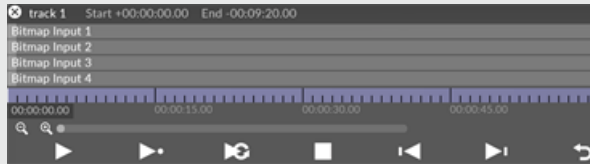

Content layers, in this example four Bitmap layers, will be used as input into a Compose layer

2. Edit the content layers properties as you wish. The content layers used in this example have had their Colour Shift properties edited. For more information on editing Colour Shift properties scroll down to the section [Colour Shift](#) in the [Common layer properties](#) chapter.
3. Create a [Direct mapping](#) with the same resolution as the source content. For example, if the image in the Bitmap layer is 256x256 pixels, create a Direct mapping type with a 256x256 resolution . As the mapping type only acts as a temporary container which is piped into the Compose layer, there is no need to add a screen.
4. Create a Compose layer. Make sure this layer is positioned at the top of your layer order.

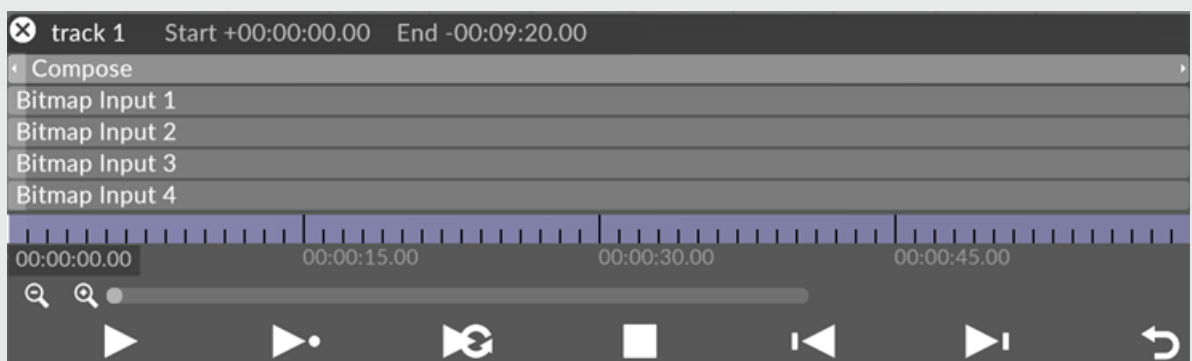

The Compose layer should be positioned at the top of the input layers

5. Drag an Arrow from each input layer into the Compose layer. For information on Arrows please see the sub-chapter [Composing layers using arrows](#). In the Compose layers preview window you can now see the inputs composed next to each other.

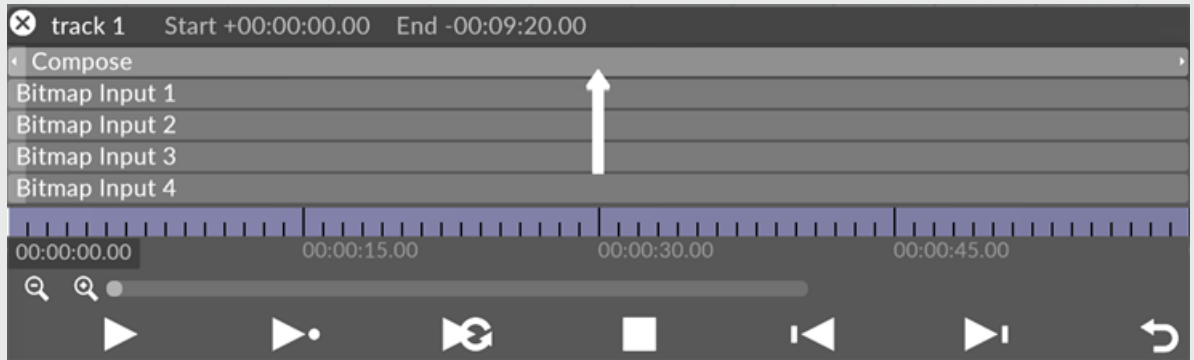

Input layers piped into the Compose layer using Arrows and mapped onto Screen1 using a Direct mapping

6. Edit the Compose layer properties as you wish. It is also possible to blur the edges between the inputs enabling seamless edges, as shown in the first image of this sub-chapter.

## Blend Mode

BlendMode controls how the output of the layer is composited with the layers below. Layers are rendered in a bottom-up order: layers at the top can modify the output of the layers below.

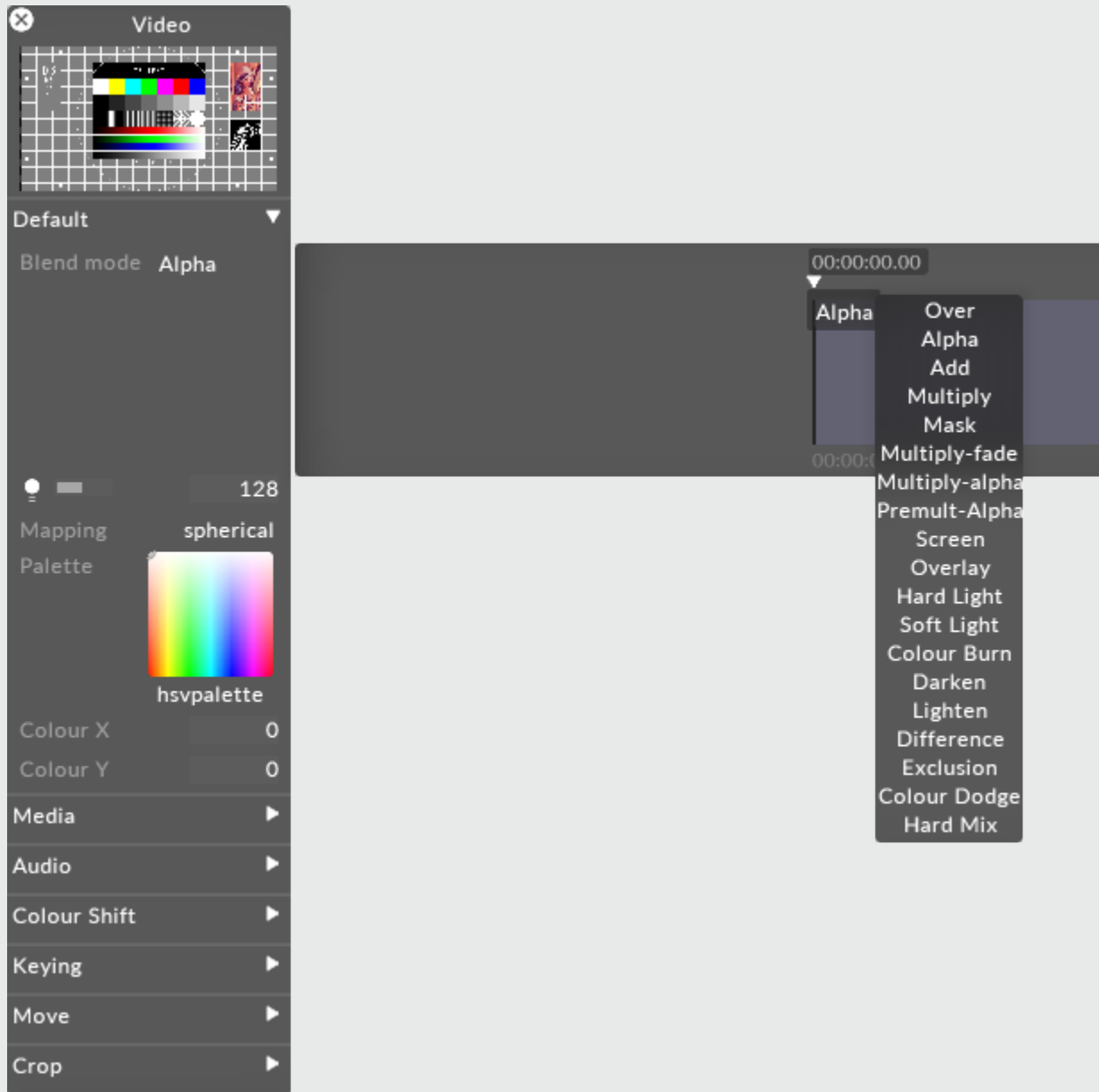

Changing brightness of a content layer in Disguise software is actually controlling the value of the alpha of the layer. Even when displaying a HAP video, the software will composite the layer with a controllable layer of alpha - one per layer.



There are two ways of expressing alpha in an image:

Straight alpha is an alpha channel which functions just like RGB. Alpha acts as a fourth channel of information per pixel which is as independent of the other three as R, G and B are of each other. For example, with straight alpha it is possible to have RGB = 255 (white) and alpha = 0 (fully transparent) on the same pixel. Internally generated content, such as gradient layer, are generated with straight alpha. This is the preferable style of alpha and considering the cleaner method of the two.

Premultiplied alpha takes the alpha and applies it to the values of the RGB channels per pixel. The more transparent something gets with premultiplied alpha, the closer it gets to black - as if the content is sitting on a black table. Premultiplied is the default output of Adobe Photoshop or AfterEffects. The result is our pixel at 255 RGB (full white) with 0 alpha would be calculated as a black pixel in the final image.

Here are explanations of what each individual blend mode will do.

## Over

Makes a layer fully opaque. Premultiplies all alpha onto the RGB value of each pixel. Alpha = black, so adjusting the brightness of a layer in Over blend mode makes it darker.

## Alpha

Default blend mode. It will apply alpha values as a transparency if the alpha is present. Brightness changes will make the layer more or less transparent.

## Add

Adds the value of each RGB pixel together. Always creates a brighter result. Values clamp at 255.

## Multiply

Reads the level of each subpixel as a level between 0.0 and 1.0, and multiplies source with blend. The result is always a darker image overall. For example: white x grey = 0.5. White turns transparent, black takes precedence. Alpha is applied in the same fashion as the Over Blend mode.

## Mask

Choose mask when you want to multiple out content upwards in the stack of layers, rather than downwards. In order to make this work you have to use the same mapping on the layer set to mask and the layer on top.

## Multiply-Fade

The same as Multiply, but will make use of the alpha channel to calculate transparency in the source and blend layers. Since maximum transparency is premultiplied, alpha results in black. This will ignore black created through premultiplying.

## Multiply-Alpha

Multiply with straight alpha. This mode assumes that the alpha has not been premultiplied onto the RGB values and will not apply a correction to the semi-transparent pixels.

## Premultiply Alpha

Like how Multiply-fade will ignore the darkening caused by premultiplying, this blend mode will do the same with Alpha.

## Colour Burn

Blend mode increases the contrast to darken the base colour while reflecting the blend colour. The darker the blend colour, the more intensely the colour will be applied in the base image. White as the blend colour produces no change. Using the colour burn blend mode can produce some harsh results at full opacity.

The colour burn blend mode can be used to make tonal and colour adjustments to a layer.

## Screen

This blend mode looks at each channels colour information and multiplies the inverse of the blend and base colour. The result is always a lighter colour. Screening with black leaves the colour unchanged. Screening with white produces white. The effect is similar to projecting multiple images on top of each other - where bright white is fully opaque, black is fully transparent and 50% grey is 50% transparent.

## Overlay

Multiplies or screens the colours, depending on the base colour. Patterns or colours overlay the existing pixels while preserving the highlights and shadows of the base colour. The base colour is not replaced, but mixed with the blend colour to reflect the lightness or darkness of the original colour.

## Hard Light

Multiplies or screens the colours, depending on the blend colour. The effect is similar to shining a harsh spotlight on the image. If the blend colour (light source/top layer) is lighter than 50% grey, the image is lightened as if it were screened. This is useful for adding highlights to an image. If the blend colour is darker than 50% grey, the image is darkened as if it were multiplied. This is useful for adding shadows to an image. Painting with pure black or white results in pure black or white.

## Soft Light

Darkens or lightens the colours, depending on the blend colour. The effect is similar to shining a diffused spotlight on the image. If the blend colour (light source/top layer) is lighter than 50% grey, the image is lightened as if it were dodged. If the blend colour is darker than 50% grey, the image is darkened as if it were burned in. Painting with pure black or white produces a distinctly darker or lighter area, but does not result in pure black or white.

## Darken

Looks at the colour information in each channel and selects the base or blend colour - whichever is darker - as the result colour. Pixels lighter than the blend colour are replaced and pixels darker than the blend colour do not change.

## Lighten

Looks at the colour information in each channel and selects the base or blend colour - whichever is lighter - as the result colour. Pixels darker than the blend colour are replaced and pixels lighter than the blend colour do not change.

## Difference

Looks at the colour information in each channel and subtracts either the blend colour from the base colour or the base colour from the blend colour depending on which has the greater brightness value.

Blending with white inverts the base colour values and blending with black produces no change.

## Exclusion

Creates an effects similar to but lower in contrast than the difference mode. Blending with white inverts the base colour values. Blending with black produces no change.

## Colour Dodge

Looks at the colour information in each channel and brightens the base colour to reflect the blend colour by decreasing contrast between the two. Blending with black produces no change.

## Hard Mix

Adds the RGB channels of the blend colour to the RGB values of the base colour. If the resulting sum for a channel is 255 or greater, it receives a value of 255; if it is less than 255 it receives a value of 0. Therefore all blended pixels have RGB channels of either 0 or 255. This changes all pixels to primary additive colours (RGB), white or black.

## Brightness

This property (which appears as a light bulb icon) controls the brightness of the layer output.

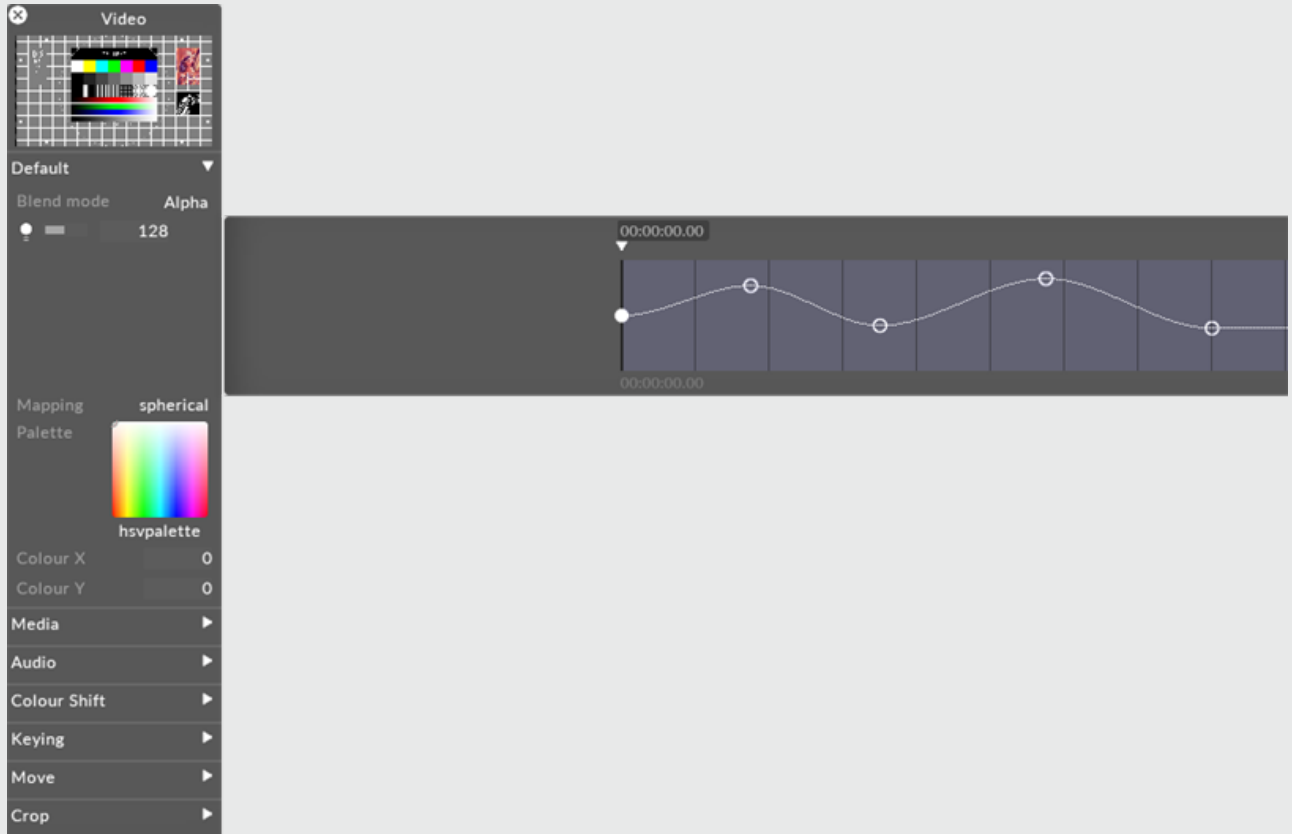

If the layers blend mode is set to Alpha, then reducing the brightness to 0 also reduces the opacity of the layer to 0. This can be useful when you want to dissolve from one layer to the next. In that case, you can place the new layer above the old layer and increase its brightness level.

## Mapping

The mapping property controls how the layer output is mapped onto the screen(s) in the Stage level.

**Video**

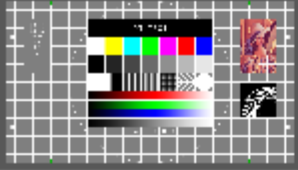

Default ▾

Blend mode Alpha

128

Mapping direct map 1

Palette



hsvpalette

Colour X 0

Colour Y 0

Media ▾

Video



d3\_test\_16-9.png

Speed 1

Mode Normal

At end point Loop

Transition time 0

Audio ▶

Colour Shift ▶

Keying ▶

Move ▶

Crop ▶

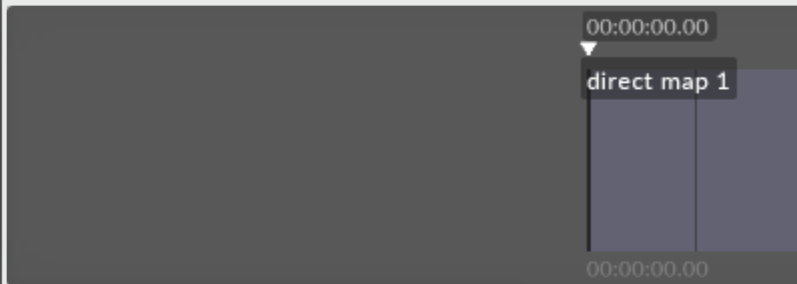

**mappings**

New mapping: OK Search:

all New Mappings

- direct map 1
- feed map 2
- feed mapping
- mapping 1
- mapping 2
- parallel
- spherical

For information on mapping, including how to use the different mapping types offered by Disguise software, please see the chapter [Content Mapping](#).

## Palette

This points to the still image file that defines the bitmap from which the tint colour is taken. The default palette ( HSVPAL ) consists of the complete range of hues and saturations. Selecting this property will open the Texture object library, which shows all of the still image files saved on your local hard-drive in the **DxTexture** folder.

To control the location within the current palette bitmap, and thus control the colour, you have to edit the **xCol** and **yCol** values (see the section for xCol, yCol).

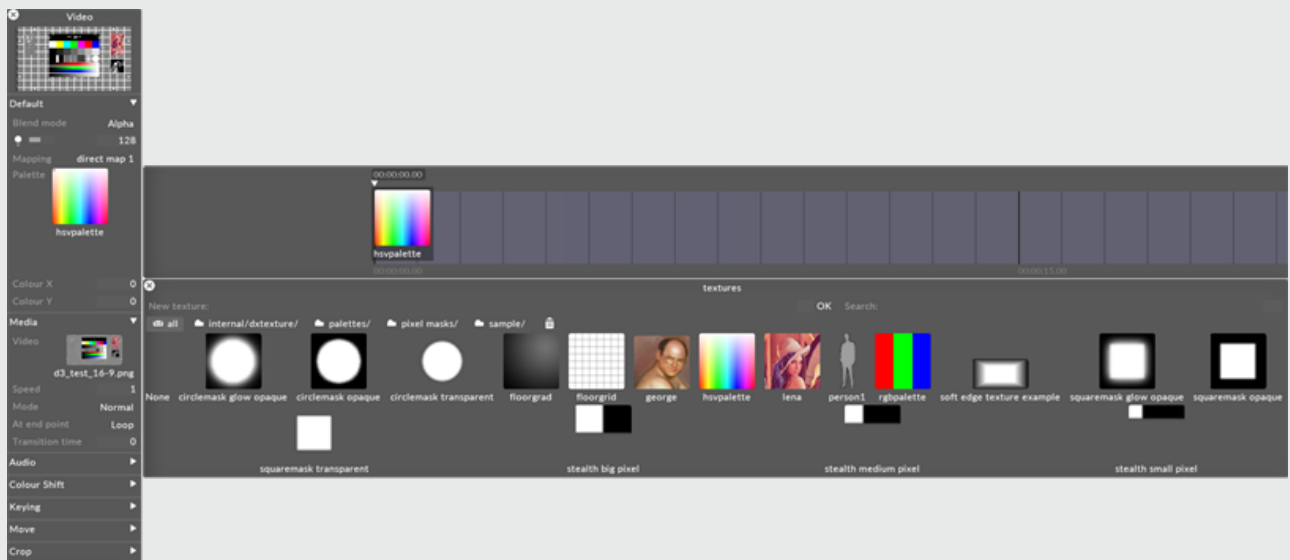

To change the current palette bitmap:

1. Left-click **palette** to open the Texture object library.
2. Left-click the still image file you want to use for the palette bitmap.

If you want to use a palette bitmap other than the standard still images provided in Disguise software, you will need to use a custom still image file.

See the [Placing media files for a project](#) sub-chapter to understand where to place a custom still image file and how to access it in Disguise software. Also save the file to a [supported file format](#).

## xCol yCol

These properties control the coordinates within the current palette bitmap where the output colour is sampled from. The default value is 0,0 which points at the color white (if you are using the HSVPAL palette). Multiplying white with the colors of the chosen content simply generates the original content colors. **Colour X** controls the horizontal position, where 0 is the leftmost edge and 255 is the rightmost edge. **Colour Y** controls the vertical position, where 0 is the top edge and 255 is the bottom edge.

For example, to saturate the video clip red, change the **Colour Y** value to 255 and use 0 for the **Colour X** value. These coordinates refer to the color red in the palette which is being multiplied with the colors of the existing content.

When you are using the default palette HSVPAL , **Colour Y** controls saturation, and **Colour X** controls hue.



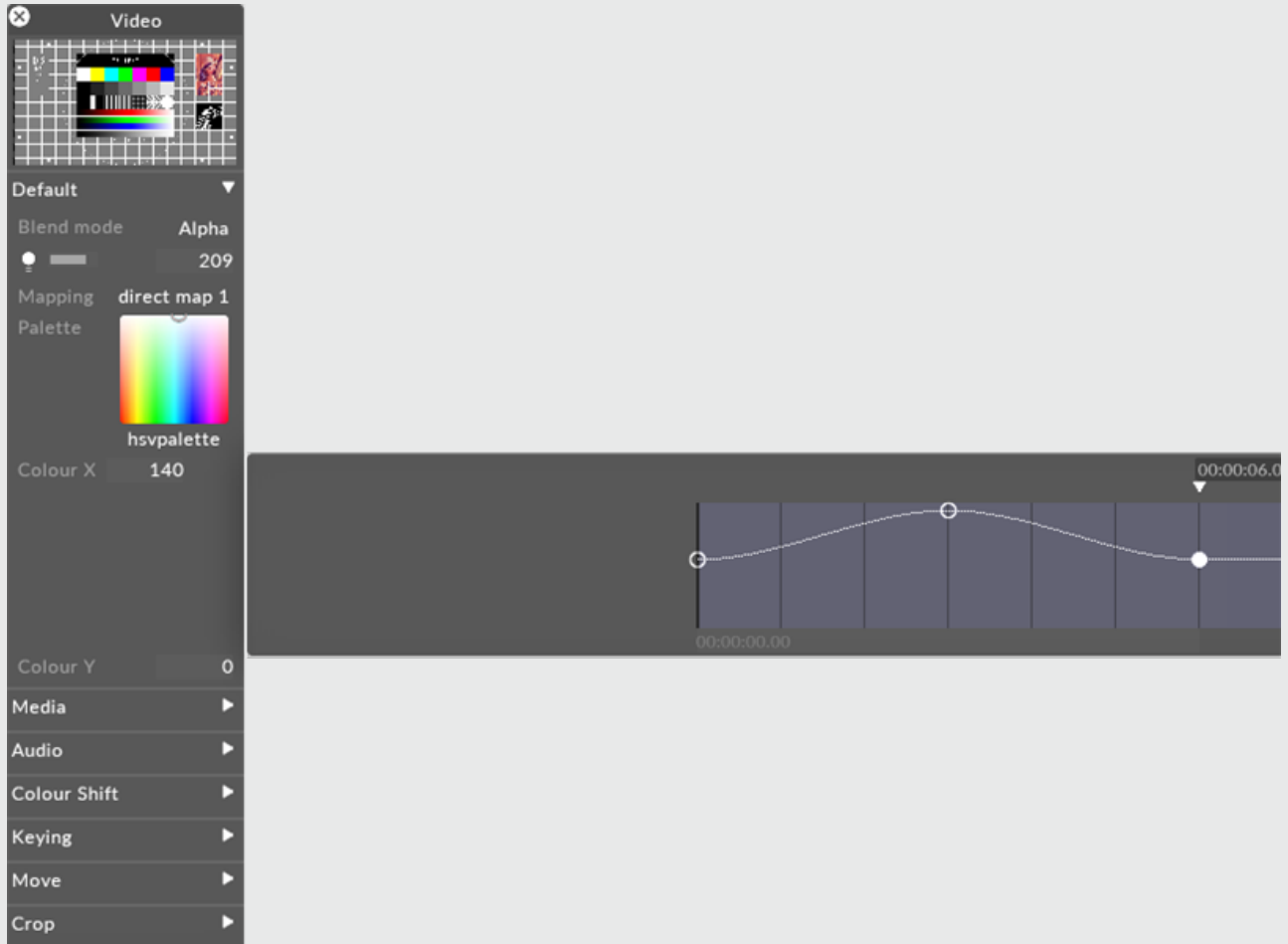

## Horizontal shift

Moves the composed content left or right.

## Rotation speed

Adjusts the horizontal rotation speed of the content.

## Vertical shift

Moves the content up or down.

## Blend border

Adjusts the blending level between the input sources.

## Source 1,2,3,4

Adjust what inputs to show, hide or partially show. When you set the value to 1, it shows the input, 0 hides the input. As inputs are being hidden, note that Disguise software maintains the aspect and therefore scales the inputs on the screen.

# EdgeFilter

The EdgeFilter layer filter can be used to detect the edges within a video/bitmap.

All Effect layers take their source from other layer types - either content or generative - by use of an arrow. Linking two layers with an arrow defines the arrowed from layer as the source, and the arrowed to layer as the destination. If you have an arrow between a content layer and effect layer, it is said that the content layer is being 'piped in' to the effect layer. For more information on arrows, see the [compositing layers](#) topic.

To draw an arrow between two layers, hold down **ALT** and left click & drag between the source and destination layer.



By adjusting the strength parameter you can change how the layer affects the image. Setting the strength to 0 will have no effect. Setting the strength to 1 will highlight the edges and exclude the rest of the image. Setting the strength to -1 will exclude the edges and highlight the rest of the image.

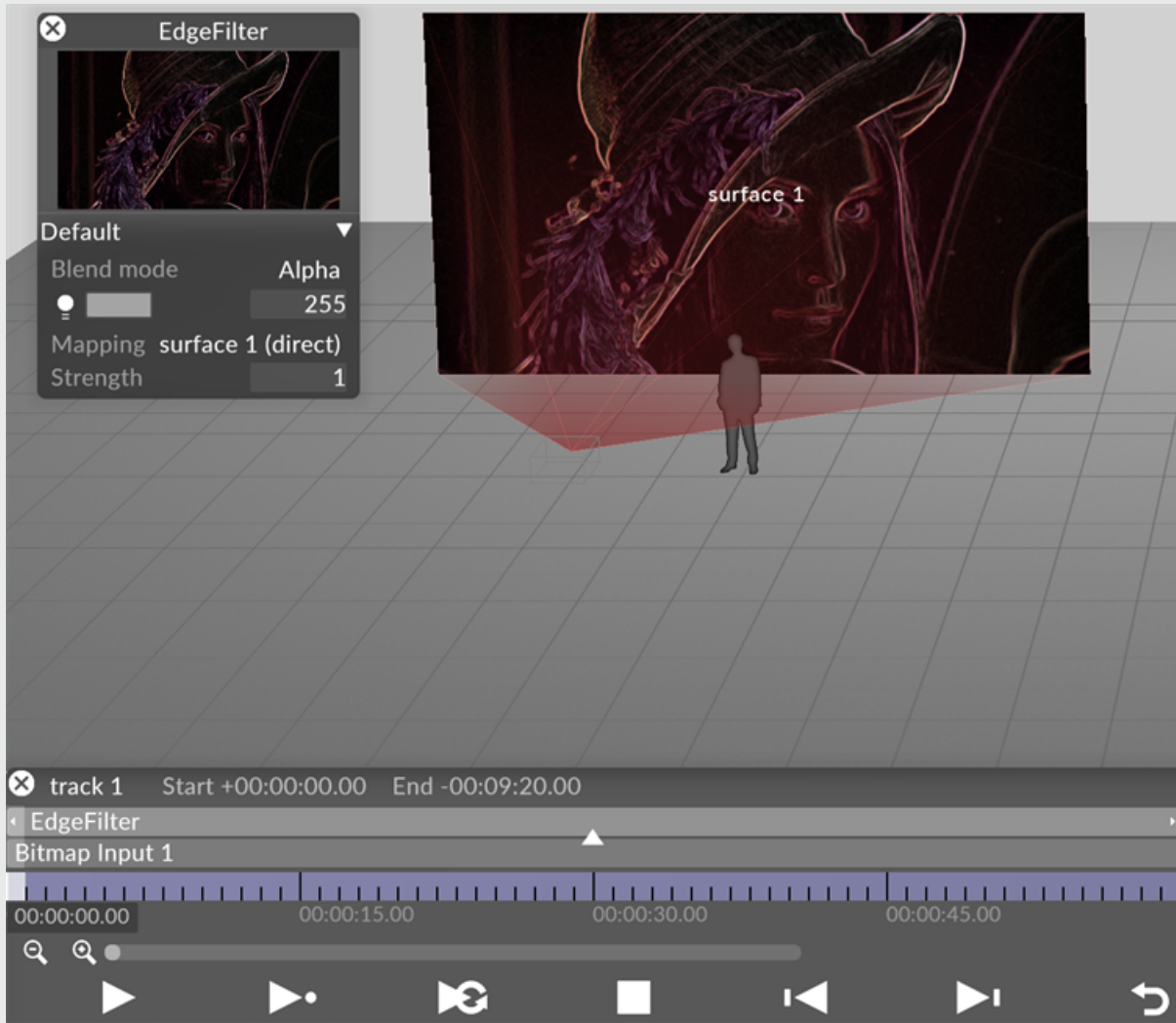

*EdgeFilter layer set to 0.*

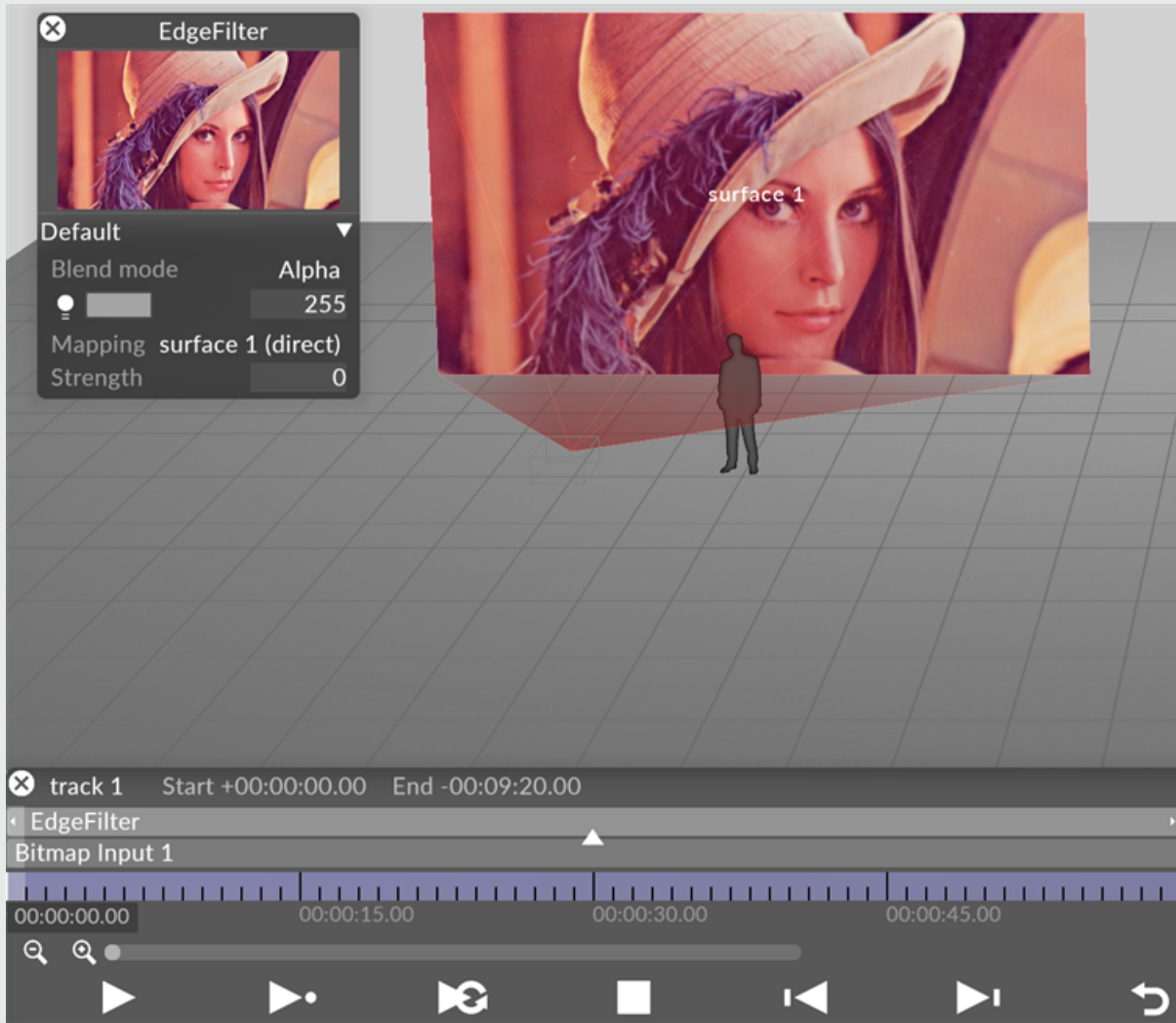

*EdgeFilter layer set to 1.*

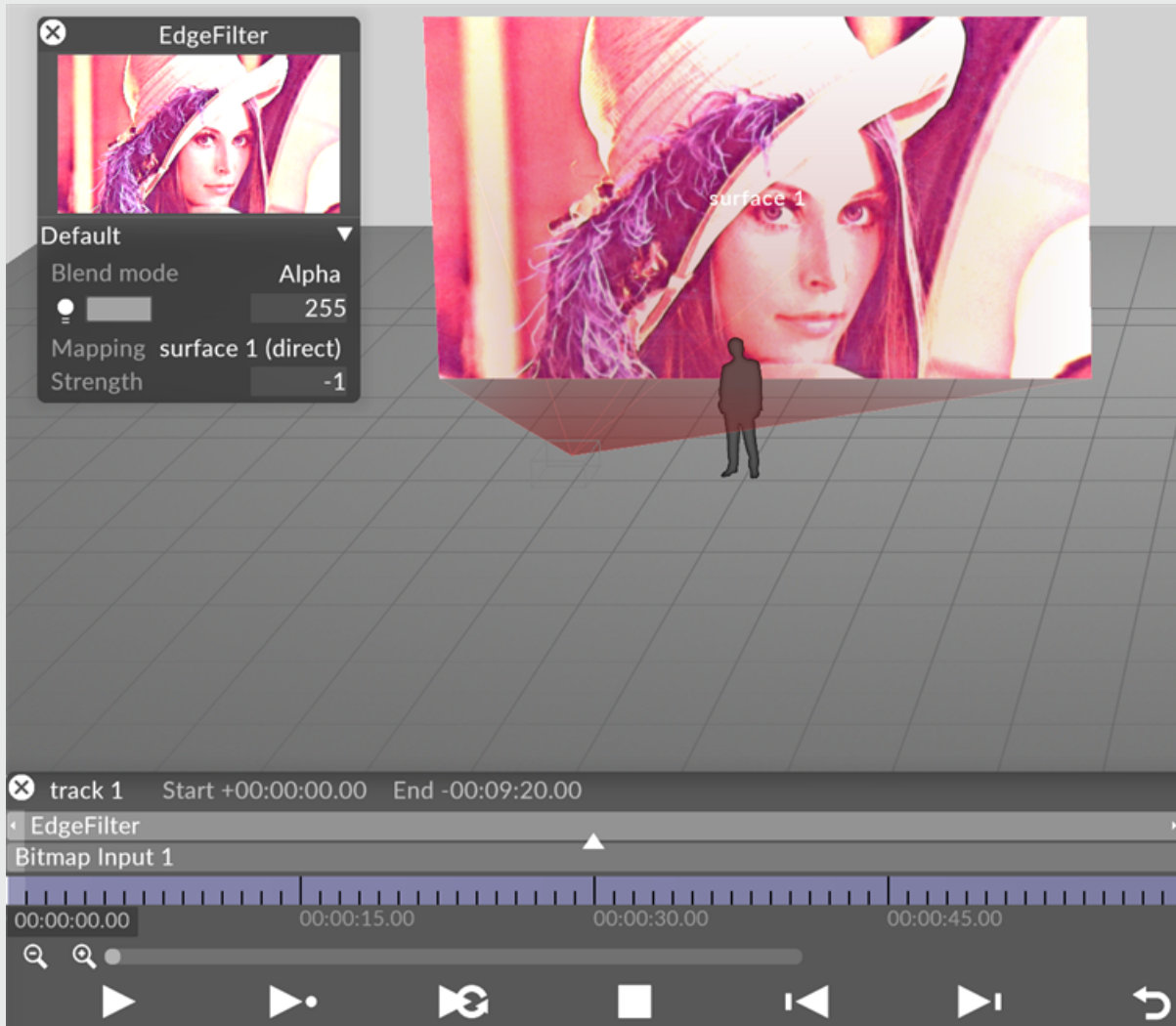

*EdgeFilter layer set to -1.*

## Blend Mode

BlendMode controls how the output of the layer is composited with the layers below. Layers are rendered in a bottom-up order: layers at the top can modify the output of the layers below.

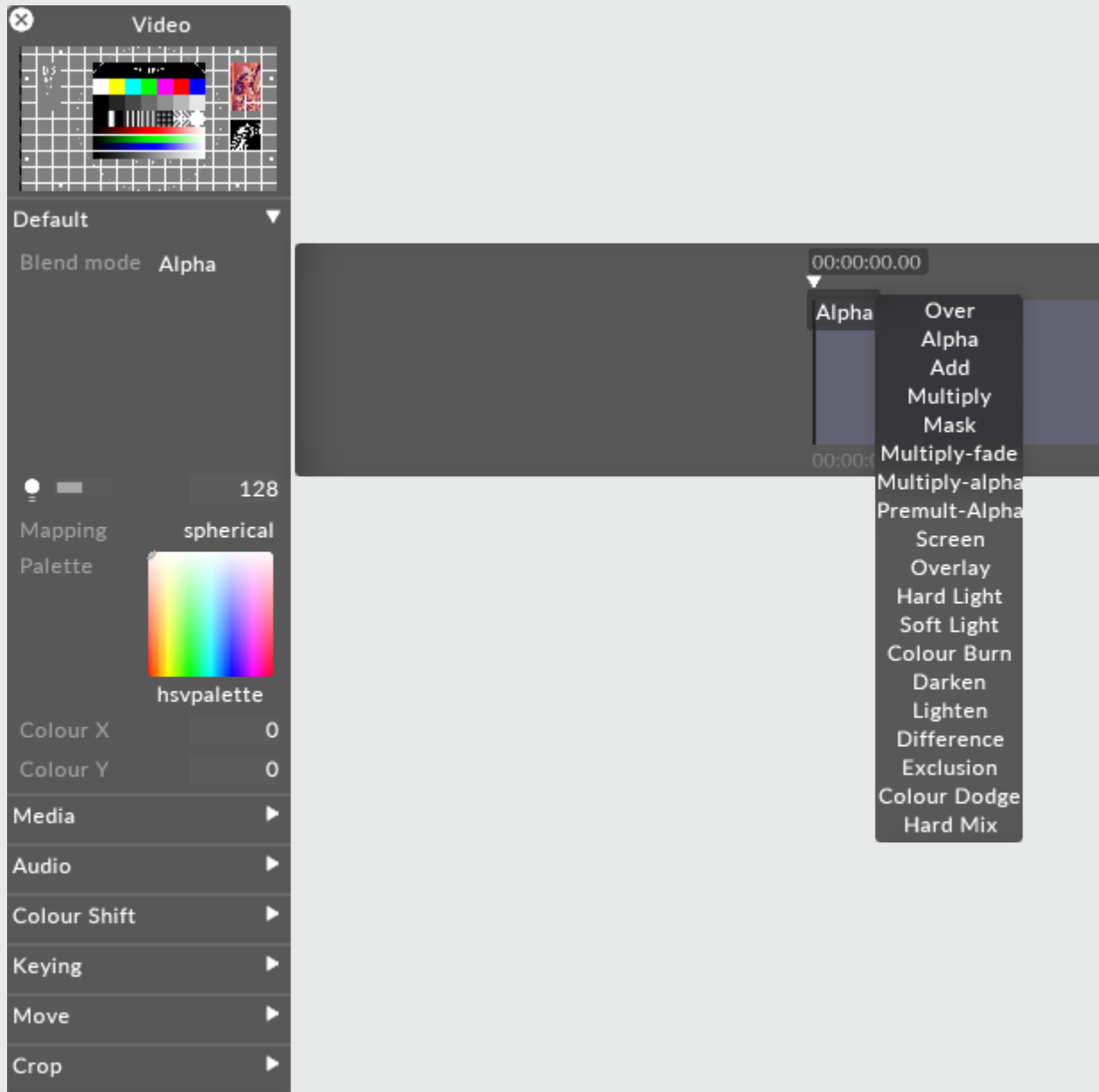

Changing brightness of a content layer in Disguise software is actually controlling the value of the alpha of the layer. Even when displaying a HAP video, the software will composite the layer with a controllable layer of alpha - one per layer.

There are two ways of expressing alpha in an image:

Straight alpha is an alpha channel which functions just like RGB. Alpha acts as a fourth channel of information per pixel which is as independent of the other three as R, G and B are of each other. For example, with straight alpha it is possible to have RGB = 255 (white) and alpha = 0 (fully transparent) on the same pixel. Internally generated content, such as gradient layer, are generated with straight alpha. This is the preferable style of alpha and considering the cleaner method of the two.

Premultiplied alpha takes the alpha and applies it to the values of the RGB channels per pixel. The more transparent something gets with premultiplied alpha, the closer it gets to black - as if the content is sitting on a black table. Premultiplied is the default output of Adobe Photoshop or AfterEffects. The result is our pixel at 255 RGB (full white) with 0 alpha would be calculated as a black pixel in the final image.

Here are explanations of what each individual blend mode will do.

## Over

Makes a layer fully opaque. Premultiplies all alpha onto the RGB value of each pixel. Alpha = black, so adjusting the brightness of a layer in Over blend mode makes it darker.

## Alpha

Default blend mode. It will apply alpha values as a transparency if the alpha is present. Brightness changes will make the layer more or less transparent.

## Add

Adds the value of each RGB pixel together. Always creates a brighter result. Values clamp at 255.

## Multiply

Reads the level of each subpixel as a level between 0.0 and 1.0, and multiplies source with blend. The result is always a darker image overall. For example: white x grey = 0.5. White turns transparent, black takes precedence. Alpha is applied in the same fashion as the Over Blend mode.



## Mask

Choose mask when you want to multiple out content upwards in the stack of layers, rather than downwards. In order to make this work you have to use the same mapping on the layer set to mask and the layer on top.

## Multiply-Fade

The same as Multiply, but will make use of the alpha channel to calculate transparency in the source and blend layers. Since maximum transparency is premultiplied, alpha results in black. This will ignore black created through premultiplying.

## Multiply-Alpha

Multiply with straight alpha. This mode assumes that the alpha has not been premultiplied onto the RGB values and will not apply a correction to the semi-transparent pixels.

## Premultiply Alpha

Like how Multiply-fade will ignore the darkening caused by premultiplying, this blend mode will do the same with Alpha.

## Colour Burn

Blend mode increases the contrast to darken the base colour while reflecting the blend colour. The darker the blend colour, the more intensely the colour will be applied in the base image. White as the blend colour produces no change. Using the colour burn blend mode can produce some harsh results at full opacity.

The colour burn blend mode can be used to make tonal and colour adjustments to a layer.

## Screen

This blend mode looks at each channels colour information and multiplies the inverse of the blend and base colour. The result is always a lighter colour. Screening with black leaves the colour unchanged. Screening with white produces white. The effect is similar to projecting multiple images on top of each other - where bright white is fully opaque, black is fully transparent and 50% grey is 50% transparent.

## Overlay

Multiplies or screens the colours, depending on the base colour. Patterns or colours overlay the existing pixels while preserving the highlights and shadows of the base colour. The base colour is not replaced, but mixed with the blend colour to reflect the lightness or darkness of the original colour.

## Hard Light

Multiplies or screens the colours, depending on the blend colour. The effect is similar to shining a harsh spotlight on the image. If the blend colour (light source/top layer) is lighter than 50% grey, the image is lightened as if it were screened. This is useful for adding highlights to an image. If the blend colour is darker than 50% grey, the image is darkened as if it were multiplied. This is useful for adding shadows to an image. Painting with pure black or white results in pure black or white.

## Soft Light

Darkens or lightens the colours, depending on the blend colour. The effect is similar to shining a diffused spotlight on the image. If the blend colour (light source/top layer) is lighter than 50% grey, the image is lightened as if it were dodged. If the blend colour is darker than 50% grey, the image is darkened as if it were burned in. Painting with pure black or white produces a distinctly darker or lighter area, but does not result in pure black or white.

## Darken

Looks at the colour information in each channel and selects the base or blend colour - whichever is darker - as the result colour. Pixels lighter than the blend colour are replaced and pixels darker than the blend colour do not change.

## Lighten

Looks at the colour information in each channel and selects the base or blend colour - whichever is lighter - as the result colour. Pixels darker than the blend colour are replaced and pixels lighter than the blend colour do not change.

## Difference

Looks at the colour information in each channel and subtracts either the blend colour from the base colour or the base colour from the blend colour depending on which has the greater brightness value.

Blending with white inverts the base colour values and blending with black produces no change.

## Exclusion

Creates an effects similar to but lower in contrast than the difference mode. Blending with white inverts the base colour values. Blending with black produces no change.

## Colour Dodge

Looks at the colour information in each channel and brightens the base colour to reflect the blend colour by decreasing contrast between the two. Blending with black produces no change.

## Hard Mix

Adds the RGB channels of the blend colour to the RGB values of the base colour. If the resulting sum for a channel is 255 or greater, it receives a value of 255; if it is less than 255 it receives a value of 0. Therefore all blended pixels have RGB channels of either 0 or 255. This changes all pixels to primary additive colours (RGB), white or black.

## Brightness

This property (which appears as a light bulb icon) controls the brightness of the layer output.

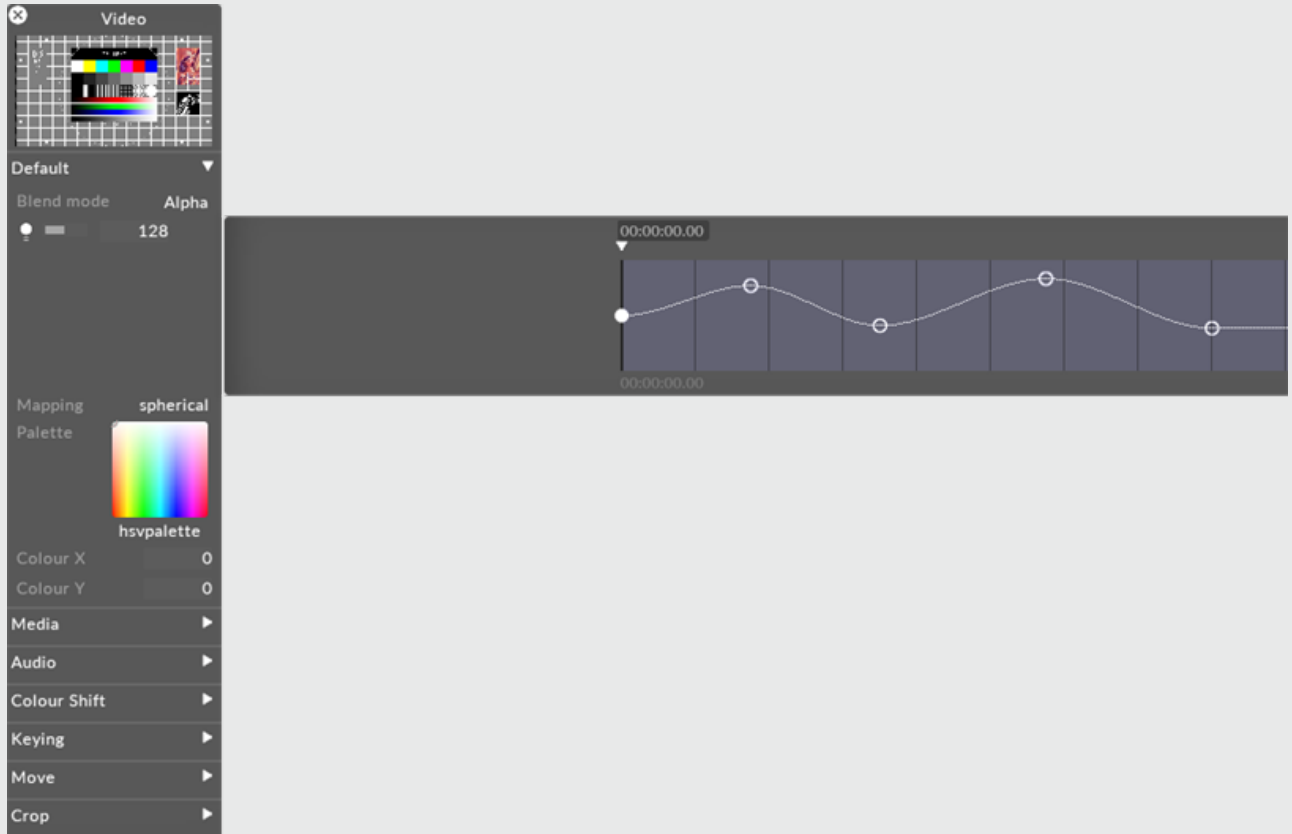

If the layers blend mode is set to Alpha, then reducing the brightness to 0 also reduces the opacity of the layer to 0. This can be useful when you want to dissolve from one layer to the next. In that case, you can place the new layer above the old layer and increase its brightness level.

## Mapping

The mapping property controls how the layer output is mapped onto the screen(s) in the Stage level.

**Video**

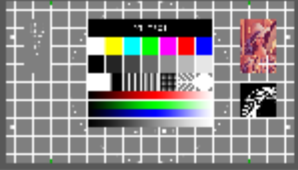

Default ▾

Blend mode Alpha

128

Mapping direct map 1

Palette



hsvpalette

Colour X 0

Colour Y 0

Media ▾

Video



d3\_test\_16-9.png

Speed 1

Mode Normal

At end point Loop

Transition time 0

Audio ▶

Colour Shift ▶

Keying ▶

Move ▶

Crop ▶

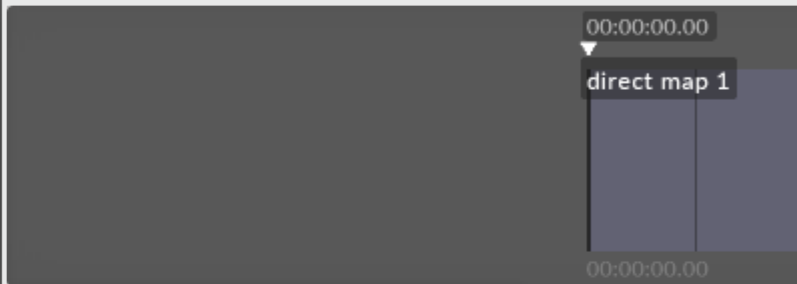

00:00:00.00

direct map 1

00:00:00.00

**mappings**

New mapping: OK Search:

all New Mappings

- direct map 1
- feed map 2
- feed mapping
- mapping 1
- mapping 2
- parallel
- spherical

For information on mapping, including how to use the different mapping types offered by Disguise software, please see the chapter [Content Mapping](#).

## Strength

Strength controls how strong the edge filter is applied.

# Fade

The Fade layer allows control of the brightness of all screens within a mapping.

## Overview

The Fade layer allows control of the brightness of all screens within a mapping.

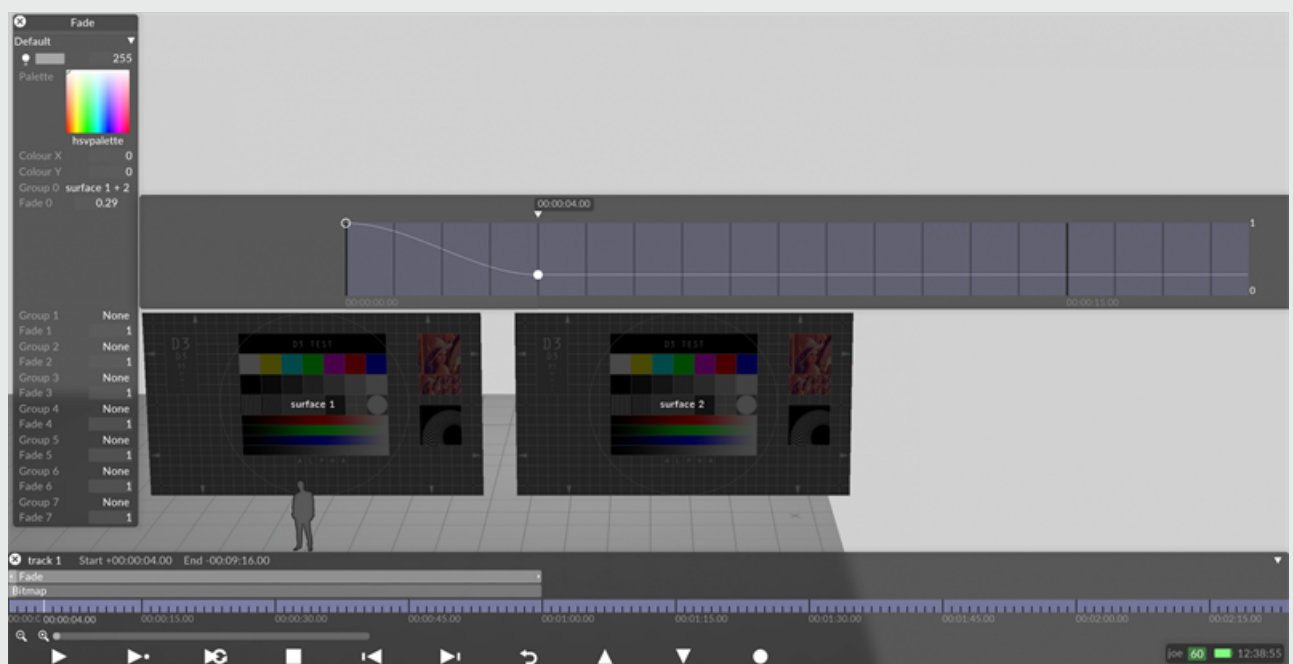

## Fade Layer Properties

### **Group 0..7**

The mapping to use as the group.

### **Fade 0..7**

The brightness of all layers outputting to the mapping. 0 is black, 1 is maximum brightness. The example above shows the Fade layer being used to fade the brightness of two screens.

**Colour x, colour y, and fade** are applied to all screens within all groups.

## Common Layer Properties

### **Brightness**

This property (which appears as a light bulb icon) controls the brightness of the layer output.

### **Palette**

This points to the still image file that defines the bitmap from which the tint colour is taken.

The default palette ( HSVPAL ) consists of the complete range of hues and saturations. Selecting this property will open the Texture object library, which shows all of the still image files saved on your local hard-drive in the DxTexture folder.

To control the location within the current palette bitmap, and thus control the colour, you have to edit the Colour X and Colour Y values.

To change the current palette bitmap:

1. Left-click **palette** to open the Texture object library.
2. Left-click the still image file you want to use for the palette bitmap.

### **Colour X , Colour Y**

These properties control the coordinates within the current palette bitmap where the output colour is sampled from. The default value is 0,0 which points at the color white (if you are using



the HSVPAL palette). Multiplying white with the colors of the chosen content simply generates the original content colors.

Colour X controls the horizontal position, where 0 is the leftmost edge and 255 is the rightmost edge.

Colour Y controls the vertical position, where 0 is the top edge and 255 is the bottom edge. For example, to saturate the video clip red, change the Colour Y value to 255 and use 0 for the Colour X value.

These coordinates refer to the color red in the palette which is being multiplied with the colors of the existing content. When you are using the default palette HSVPAL , Colour Y controls saturation, and Colour X controls hue.

# FilmicGrain

## Overview

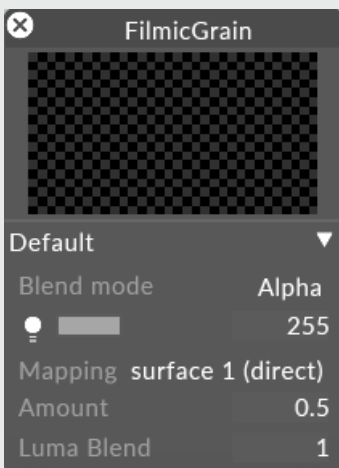

The FilmicGrain layer is designed to add animated, film grain style noise to a piece of content.

## Workflow

All Effect layers take their source from other layer types - either content or generative - by use of an arrow. Linking two layers with an arrow defines the arrowed from layer as the source, and the arrowed to layer as the destination. If you have an arrow between a content layer and effect layer, it is said that the content layer is being 'piped in' to the effect layer. For more information on arrows, see the [compositing layers](#) topic.

To draw an arrow between two layers, hold down **ALT** and left click & drag between the source and destination layer.



1. Add a FilmicGrain layer to your track. For more information about adding layers see [creating layers](#).

2. Arrow from your media layer to the FilmicGrain layer so the compositing order looks something like the following image.

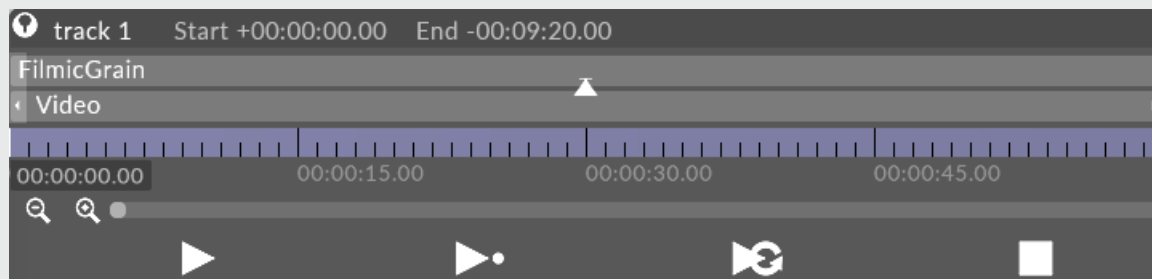

*Video layer piped into a FilmicGrain layer on the timeline.*

For more information on arrowing, see [compositing layers](#).

3. Adjust the FilmicGrain layer properties to suit your desired sequencing.

## Common layer properties

### Blend mode

BlendMode controls how the output of the layer is composited with the layers below. Layers are rendered in a bottom-up order: layers at the top can modify the output of the layers below.

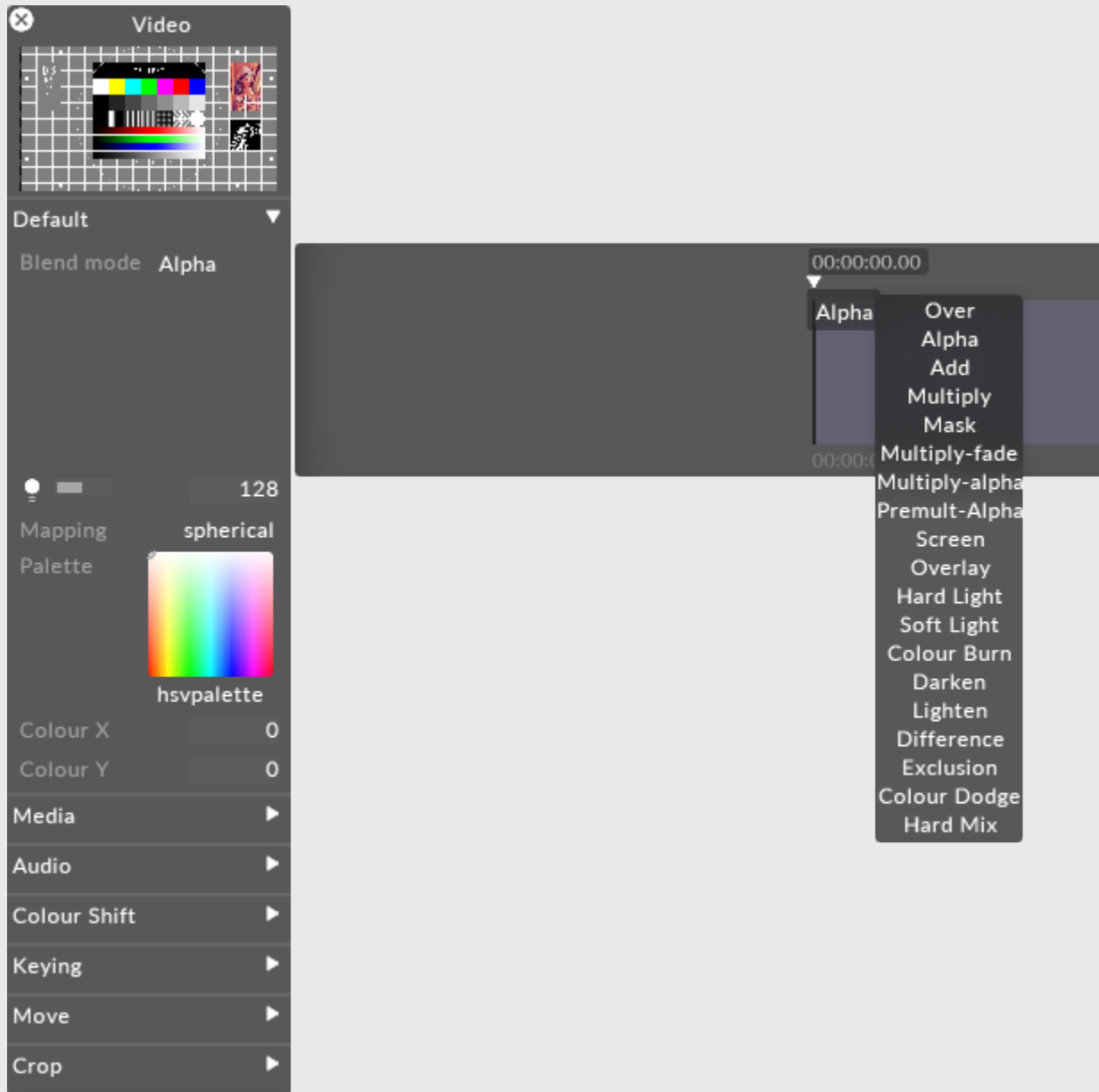

Changing brightness of a content layer in Disguise software is actually controlling the value of the alpha of the layer. Even when displaying a HAP video, the software will composite the layer with a controllable layer of alpha - one per layer.

There are two ways of expressing alpha in an image:

Straight alpha is an alpha channel which functions just like RGB. Alpha acts as a fourth channel of information per pixel which is as independent of the other three as R, G and B are of each other. For example, with straight alpha it is possible to have RGB = 255 (white) and alpha = 0 (fully transparent) on the same pixel. Internally generated content, such as gradient layers, are generated with straight alpha. This is the preferable style of alpha and considering the cleaner method of the two.

Premultiplied alpha takes the alpha and applies it to the values of the RGB channels per pixel. The more transparent something gets with premultiplied alpha, the closer it gets to black - as if the content is sitting on a black table. Premultiplied is the default output of Adobe Photoshop or AfterEffects. The result is our pixel at 255 RGB (full white) with 0 alpha would be calculated as a black pixel in the final image.

Here are explanations of what each individual blend mode will do.

## Over

Makes a layer fully opaque. Premultiplies all alpha onto the RGB value of each pixel. Alpha = black, so adjusting the brightness of a layer in Over blend mode makes it darker.

## Alpha

Default blend mode. It will apply alpha values as a transparency if the alpha is present. Brightness changes will make the layer more or less transparent.

## Add

Adds the value of each RGB pixel together. Always creates a brighter result. Values clamp at 255.

## Multiply

Reads the level of each subpixel as a level between 0.0 and 1.0, and multiplies source with blend. The result is always a darker image overall. For example: white x grey = 0.5. White turns transparent, black takes precedence. Alpha is applied in the same fashion as the Over Blend mode.

## Mask

Choose mask when you want to multiple out content upwards in the stack of layers, rather than downwards. In order to make this work you have to use the same mapping on the layer set to mask and the layer on top.

## Multiply-Fade

The same as Multiply, but will make use of the alpha channel to calculate transparency in the source and blend layers. Since maximum transparency is premultiplied, alpha results in black. This will ignore black created through premultiplying.

## Multiply-Alpha

Multiply with straight alpha. This mode assumes that the alpha has not been premultiplied onto the RGB values and will not apply a correction to the semi-transparent pixels.

## Premultiply Alpha

Like how Multiply-fade will ignore the darkening caused by premultiplying, this blend mode will do the same with Alpha.

## Colour Burn

Blend mode increases the contrast to darken the base colour while reflecting the blend colour. The darker the blend colour, the more intensely the colour will be applied in the base image. White as the blend colour produces no change. Using the colour burn blend mode can produce some harsh results at full opacity.

The colour burn blend mode can be used to make tonal and colour adjustments to a layer.

## Screen

This blend mode looks at each channels colour information and multiplies the inverse of the blend and base colour. The result is always a lighter colour. Screening with black leaves the colour unchanged. Screening with white produces white. The effect is similar to projecting multiple images on top of each other - where bright white is fully opaque, black is fully transparent and 50% grey is 50% transparent.

## Overlay

Multiplies or screens the colours, depending on the base colour. Patterns or colours overlay the existing pixels while preserving the highlights and shadows of the base colour. The base colour is not replaced, but mixed with the blend colour to reflect the lightness or darkness of the original colour.

## Hard Light

Multiplies or screens the colours, depending on the blend colour. The effect is similar to shining a harsh spotlight on the image. If the blend colour (light source/top layer) is lighter than 50% grey, the image is lightened as if it were screened. This is useful for adding highlights to an image. If the blend colour is darker than 50% grey, the image is darkened as if it were multiplied. This is useful for adding shadows to an image. Painting with pure black or white results in pure black or white.

## Soft Light

Darkens or lightens the colours, depending on the blend colour. The effect is similar to shining a diffused spotlight on the image. If the blend colour (light source/top layer) is lighter than 50% grey, the image is lightened as if it were dodged. If the blend colour is darker than 50% grey, the image is darkened as if it were burned in. Painting with pure black or white produces a distinctly darker or lighter area, but does not result in pure black or white.

## Darken

Looks at the colour information in each channel and selects the base or blend colour - whichever is darker - as the result colour. Pixels lighter than the blend colour are replaced and pixels darker than the blend colour do not change.

## Lighten

Looks at the colour information in each channel and selects the base or blend colour - whichever is lighter - as the result colour. Pixels darker than the blend colour are replaced and pixels lighter than the blend colour do not change.

## Difference

Looks at the colour information in each channel and subtracts either the blend colour from the base colour or the base colour from the blend colour depending on which has the greater brightness value.

Blending with white inverts the base colour values and blending with black produces no change.

## Exclusion

Creates an effects similar to but lower in contrast than the difference mode. Blending with white inverts the base colour values. Blending with black produces no change.

## Colour Dodge

Looks at the colour information in each channel and brightens the base colour to reflect the blend colour by decreasing contrast between the two. Blending with black produces no change.

## Hard Mix

Adds the RGB channels of the blend colour to the RGB values of the base colour. If the resulting sum for a channel is 255 or greater, it receives a value of 255; if it is less than 255 it receives a value of 0. Therefore all blended pixels have RGB channels of either 0 or 255. This changes all pixels to primary additive colours (RGB), white or black.

## Brightness

This property (which appears as a light bulb icon) controls the brightness of the layer output.



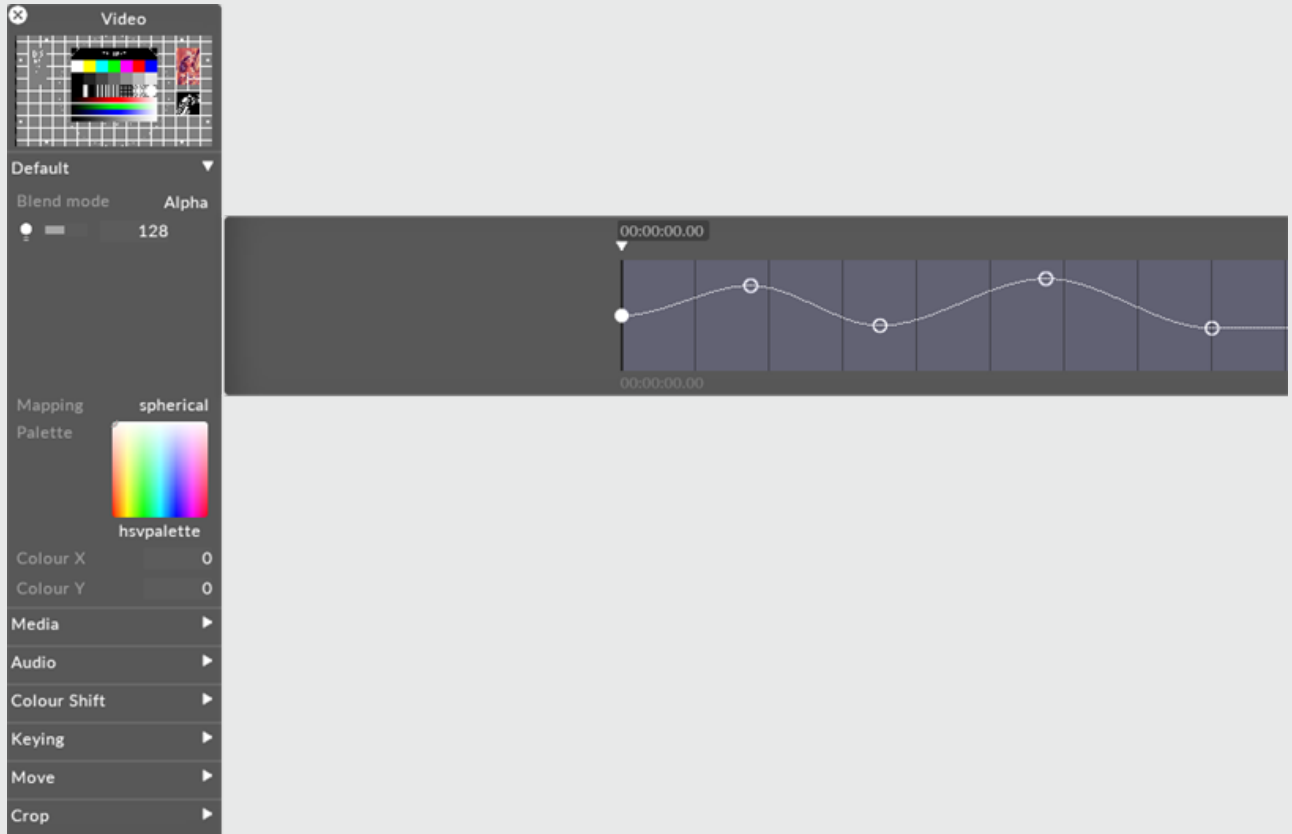

If the layers blend mode is set to Alpha, then reducing the brightness to 0 also reduces the opacity of the layer to 0. This can be useful when you want to dissolve from one layer to the next. In that case, you can place the new layer above the old layer and increase its brightness level.

## Mapping

The mapping property controls how the layer output is mapped onto the screen(s) in the Stage level.

**Video**

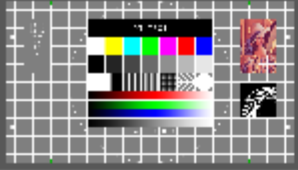

Default ▾

Blend mode Alpha

128

Mapping direct map 1

Palette



hsvpalette

Colour X 0

Colour Y 0

Media ▾

Video



d3\_test\_16-9.png

Speed 1

Mode Normal

At end point Loop

Transition time 0

Audio ▶

Colour Shift ▶

Keying ▶

Move ▶

Crop ▶

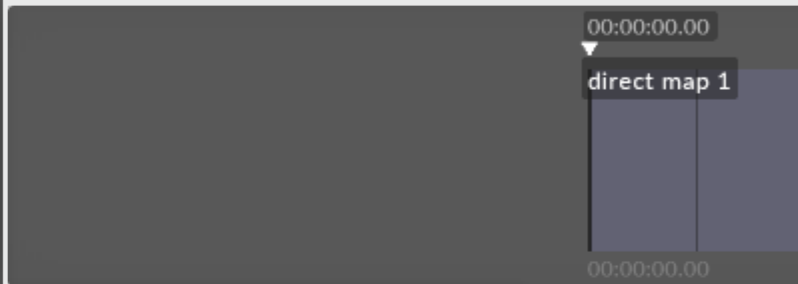

00:00:00.00

direct map 1

00:00:00.00

**mappings**

New mapping: OK Search:

all New Mappings

- direct map 1
- feed map 2
- feed mapping
- mapping 1
- mapping 2
- parallel
- spherical

For information on mapping, including how to use the different mapping types offered by Disguise software, please see the chapter [Content Mapping](#).

## Amount

This property controls the amount grain added to the original content.

## Luma blend

This property controls the Luma blend. The luma controls whether the grain is applied to the mid tones only and not applied in bright highlights. In other words, if it is white, there will be no grain whereas if it is very dark content then it will have lots of grain.

# Kaleidoscope

The Kaleidoscope effect layer can be used to create Kaleidoscope style patterns when it is composed with another content layer.

All Effect layers take their source from other layer types - either content or generative - by use of an arrow. Linking two layers with an arrow defines the arrowed from layer as the source, and the arrowed to layer as the destination. If you have an arrow between a content layer and effect layer, it is said that the content layer is being 'piped in' to the effect layer. For more information on arrows, see the [compositing layers](#) topic.

To draw an arrow between two layers, hold down **ALT** and left click & drag between the source and destination layer.

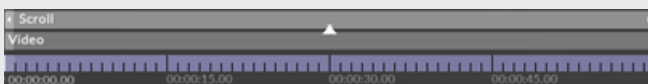

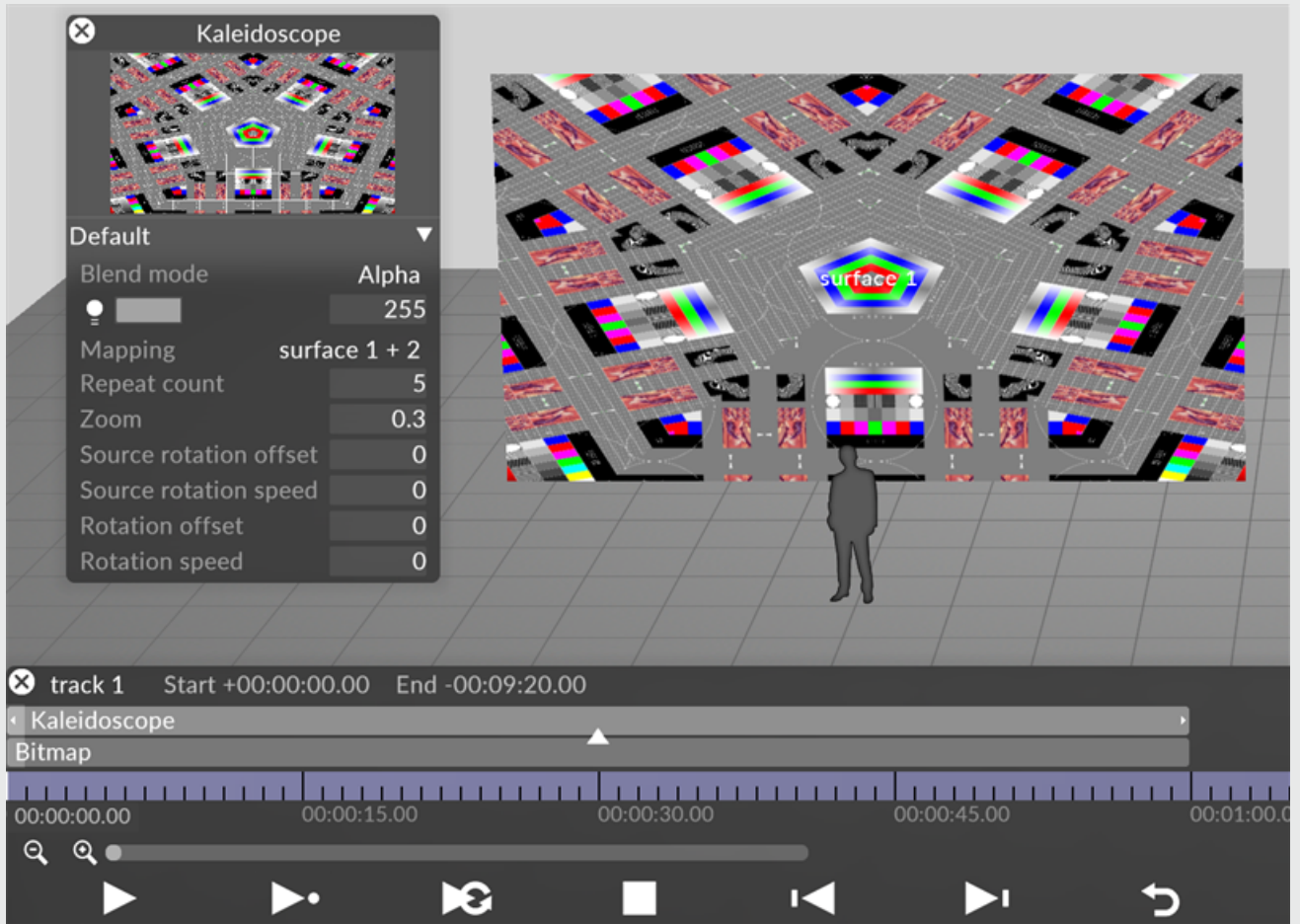

## Blend Mode

BlendMode controls how the output of the layer is composited with the layers below. Layers are rendered in a bottom-up order: layers at the top can modify the output of the layers below.

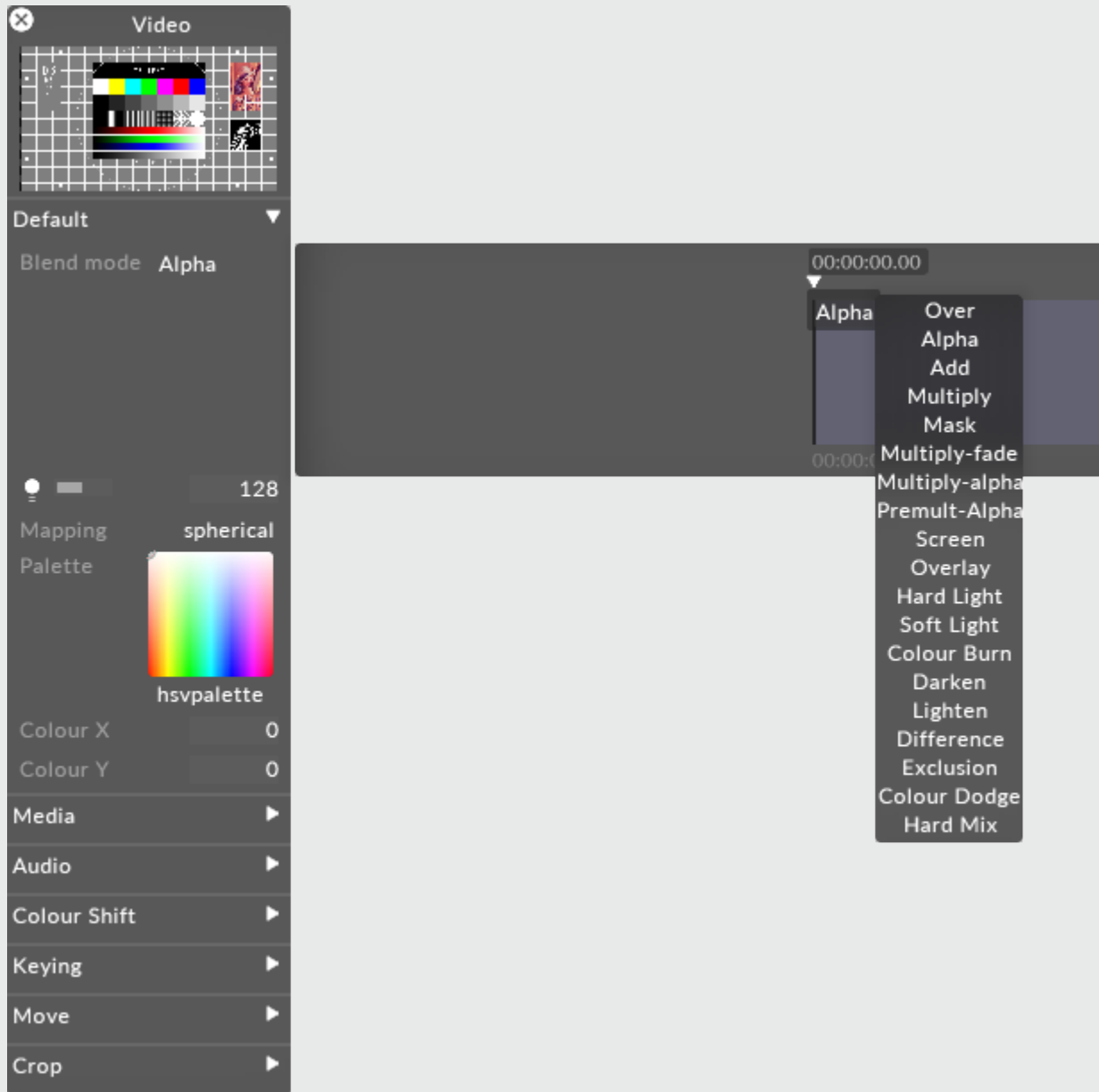

Changing brightness of a content layer in Disguise software is actually controlling the value of the alpha of the layer. Even when displaying a HAP video, the software will composite the layer with a controllable layer of alpha - one per layer.

There are two ways of expressing alpha in an image:

Straight alpha is an alpha channel which functions just like RGB. Alpha acts as a fourth channel of information per pixel which is as independent of the other three as R, G and B are of each other. For example, with straight alpha it is possible to have RGB = 255 (white) and alpha = 0 (fully transparent) on the same pixel. Internally generated content, such as gradient layer, are generated with straight alpha. This is the preferable style of alpha and considering the cleaner method of the two.

Premultiplied alpha takes the alpha and applies it to the values of the RGB channels per pixel. The more transparent something gets with premultiplied alpha, the closer it gets to black - as if the content is sitting on a black table. Premultiplied is the default output of Adobe Photoshop or AfterEffects. the result is our pixel at 255 RGB (full white) with 0 alpha would be calculated as a black pixel in the final image.

Here are explanations of what each individual blend mode will do.

## Over

Makes a layer fully opaque. Premultiplies all alpha onto the RGB value of each pixel. Alpha = black, so adjusting the brightness of a layer in Over blend mode makes it darker.

## Alpha

Default blend mode. It will apply alpha values as a transparency if the alpha is present. Brightness changes will make the layer more or less transparent.

## Add

Adds the value of each RGB pixel together. Always creates a brighter result. Values clamp at 255.

## Multiply

Reads the level of each subpixel as a level between 0.0 and 1.0, and multiplies source with blend. The result is always a darker image overall. For example: white x grey = 0.5. White turns transparent, black takes precedence. Alpha is applied in the same fashion as the Over Blend mode.

## Mask

Choose mask when you want to multiple out content upwards in the stack of layers, rather than downwards. In order to make this work you have to use the same mapping on the layer set to mask and the layer on top.

## Multiply-Fade

The same as Multiply, but will make use of the alpha channel to calculate transparency in the source and blend layers. Since maximum transparency is premultiplied, alpha results in black. This will ignore black created through premultiplying.

## Multiply-Alpha

Multiply with straight alpha. This mode assumes that the alpha has not been premultiplied onto the RGB values and will not apply a correction to the semi-transparent pixels.

## Premultiply Alpha

Like how Multiply-fade will ignore the darkening caused by premultiplying, this blend mode will do the same with Alpha.

## Colour Burn

Blend mode increases the contrast to darken the base colour while reflecting the blend colour. The darker the blend colour, the more intensely the colour will be applied in the base image. White as the blend colour produces no change. Using the colour burn blend mode can produce some harsh results at full opacity.

The colour burn blend mode can be used to make tonal and colour adjustments to a layer.

## Screen

This blend mode looks at each channels colour information and multiplies the inverse of the blend and base colour. The result is always a lighter colour. Screening with black leaves the colour unchanged. Screening with white produces white. The effect is similar to projecting multiple images on top of each other - where bright white is fully opaque, black is fully transparent and 50% grey is 50% transparent.



## Overlay

Multiplies or screens the colours, depending on the base colour. Patterns or colours overlay the existing pixels while preserving the highlights and shadows of the base colour. The base colour is not replaced, but mixed with the blend colour to reflect the lightness or darkness of the original colour.

## Hard Light

Multiplies or screens the colours, depending on the blend colour. The effect is similar to shining a harsh spotlight on the image. If the blend colour (light source/top layer) is lighter than 50% grey, the image is lightened as if it were screened. This is useful for adding highlights to an image. If the blend colour is darker than 50% grey, the image is darkened as if it were multiplied. This is useful for adding shadows to an image. Painting with pure black or white results in pure black or white.

## Soft Light

Darkens or lightens the colours, depending on the blend colour. The effect is similar to shining a diffused spotlight on the image. If the blend colour (light source/top layer) is lighter than 50% grey, the image is lightened as if it were dodged. If the blend colour is darker than 50% grey, the image is darkened as if it were burned in. Painting with pure black or white produces a distinctly darker or lighter area, but does not result in pure black or white.

## Darken

Looks at the colour information in each channel and selects the base or blend colour - whichever is darker - as the result colour. Pixels lighter than the blend colour are replaced and pixels darker than the blend colour do not change.

## Lighten

Looks at the colour information in each channel and selects the base or blend colour - whichever is lighter - as the result colour. Pixels darker than the blend colour are replaced and pixels lighter than the blend colour do not change.

## Difference

Looks at the colour information in each channel and subtracts either the blend colour from the base colour or the base colour from the blend colour depending on which has the greater brightness value.

Blending with white inverts the base colour values and blending with black produces no change.

## Exclusion

Creates an effects similar to but lower in contrast than the difference mode. Blending with white inverts the base colour values. Blending with black produces no change.

## Colour Dodge

Looks at the colour information in each channel and brightens the base colour to reflect the blend colour by decreasing contrast between the two. Blending with black produces no change.

## Hard Mix

Adds the RGB channels of the blend colour to the RGB values of the base colour. If the resulting sum for a channel is 255 or greater, it receives a value of 255; if it is less than 255 it receives a value of 0. Therefore all blended pixels have RGB channels of either 0 or 255. This changes all pixels to primary additive colours (RGB), white or black.

## Brightness

This property (which appears as a light bulb icon) controls the brightness of the layer output.

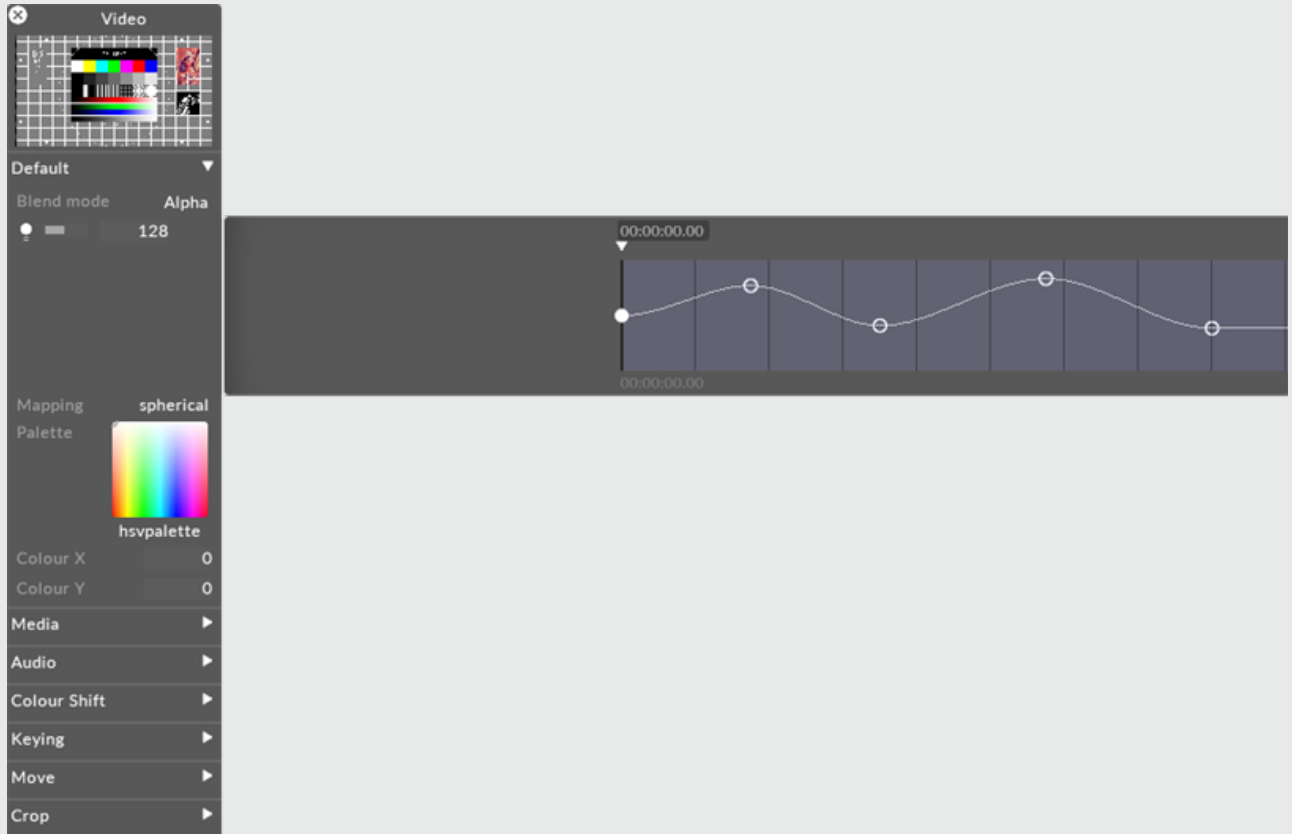

If the layers blend mode is set to Alpha, then reducing the brightness to 0 also reduces the opacity of the layer to 0. This can be useful when you want to dissolve from one layer to the next. In that case, you can place the new layer above the old layer and increase its brightness level.

## Mapping

The mapping property controls how the layer output is mapped onto the screen(s) in the Stage level.

**Video**

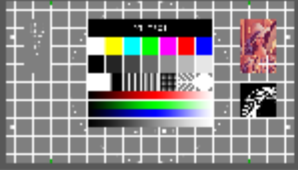

Default ▾

Blend mode Alpha

128

Mapping direct map 1

Palette



hsvpalette

Colour X 0

Colour Y 0

Media ▾

Video



d3\_test\_16-9.png

Speed 1

Mode Normal

At end point Loop

Transition time 0

Audio ▶

Colour Shift ▶

Keying ▶

Move ▶

Crop ▶

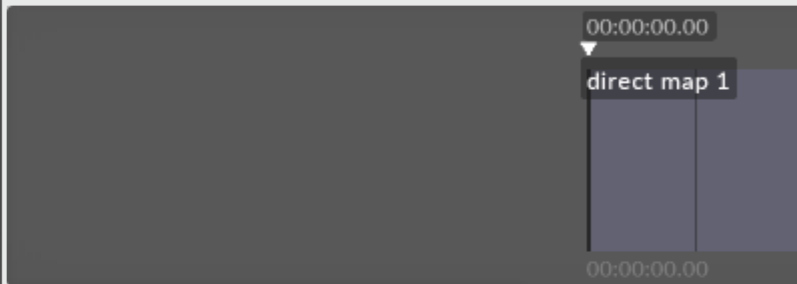

**mappings**

New mapping: OK Search:

all New Mappings

- direct map 1
- feed map 2
- feed mapping
- mapping 1
- mapping 2
- parallel
- spherical

For information on mapping, including how to use the different mapping types offered by Disguise software, please see the chapter [Content Mapping](#).

## Repeat count

The number of times the content is repeated in the pattern

## Zoom

Increase value to zoom in on the content

## Source rotation offset

Increase value to rotate the content offset

## Source rotation speed

The speed of the rotation of the content

## Rotation offset

The rotation offset for the kaleidoscope effect

## Rotation speed

The rotation speed of the kaleidoscope effect

# Lut

The Lut layer allow you to take .cube files and use them to alter the colour grade of content.

## Overview

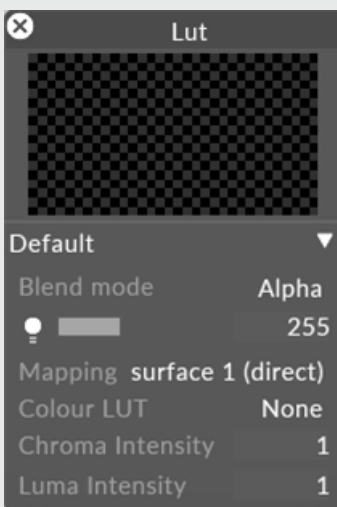

The Lut layer is designed to create movie style looks & for technical Luts to support conversion workflows. Lut files are commonly created and exported from image editing programs and have a .cube file extension.

## Workflow

All Effect layers take their source from other layer types - either content or generative - by use of an arrow. Linking two layers with an arrow defines the arrowed from layer as the source, and the arrowed to layer as the destination. If you have an arrow between a content layer and effect layer, it is said that the content layer is being 'piped in' to the effect layer. For more information on arrows, see the [compositing layers](#) topic.

To draw an arrow between two layers, hold down **ALT** and left click & drag between the source and destination layer.

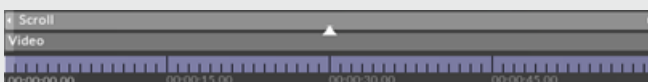

1. Add your Lut files to the LutFile folder inside your project folder. The LutFile folder is contained within the Objects folder. For more information see [placing media files](#).
2. Add a Lut layer to your track. For more information about adding layers see [creating layers](#).
3. Arrow from your media layer to the Lut layer so the compositing order looks something like the following image.

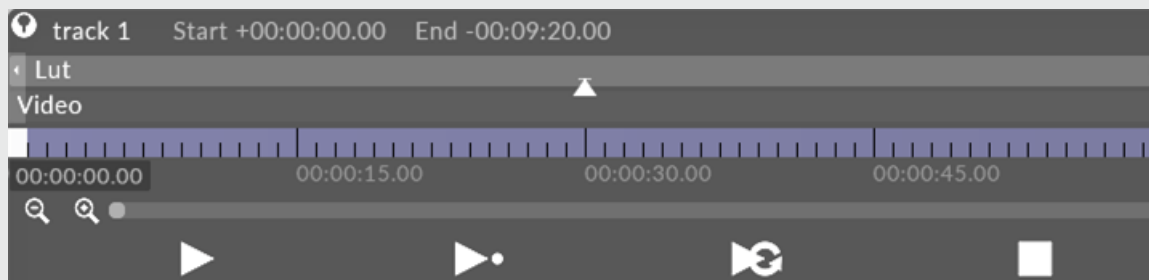

*Video layer piped into a Lut layer on the timeline.*

For more information on arrowing, see [compositing layers](#).

4. Adjust the Lut layer properties to suit your desired sequencing.

## Common layer properties

### Blend mode

BlendMode controls how the output of the layer is composited with the layers below. Layers are rendered in a bottom-up order: layers at the top can modify the output of the layers below.

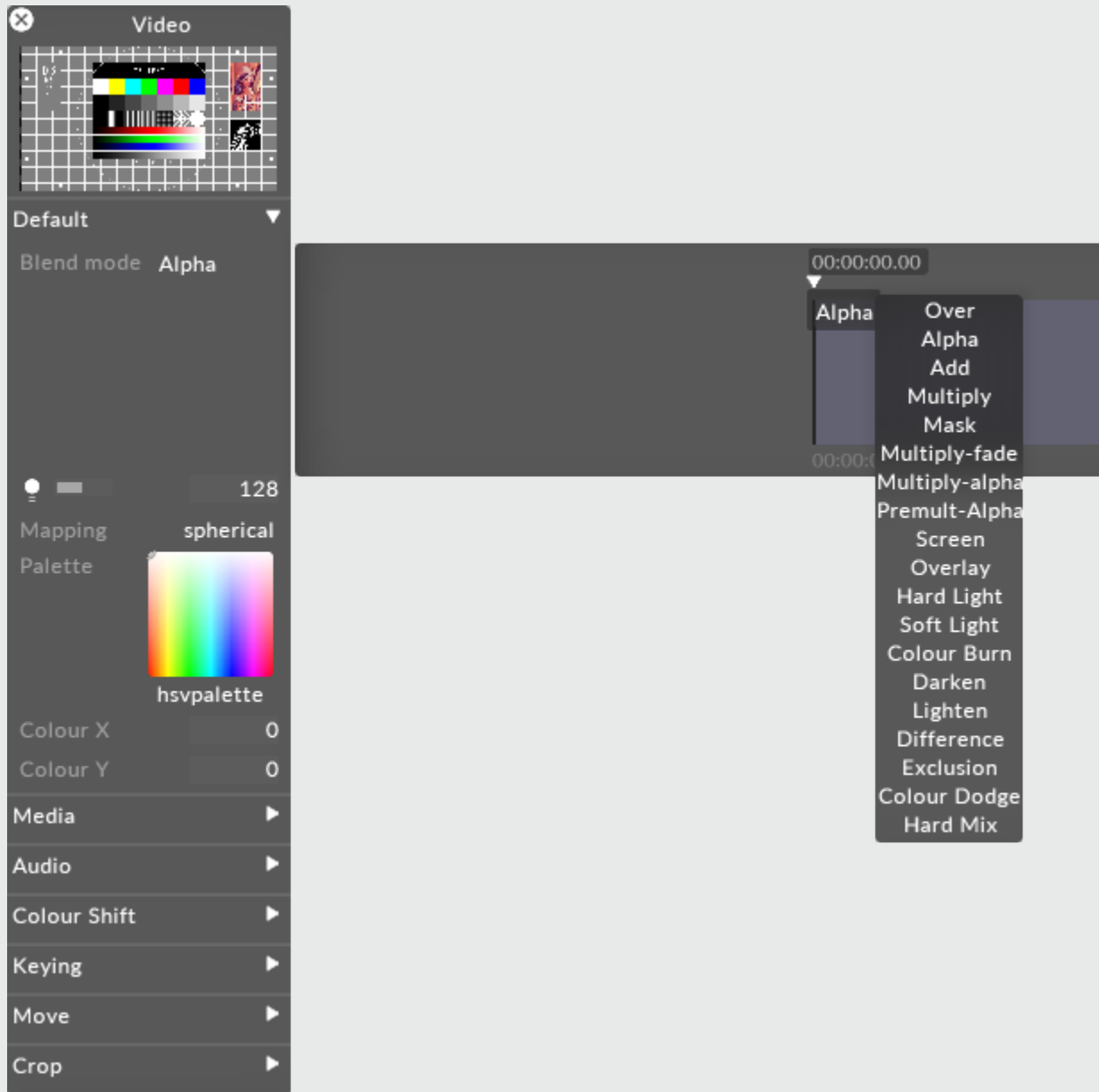

Changing brightness of a content layer in Disguise software is actually controlling the value of the alpha of the layer. Even when displaying a HAP video, the software will composite the layer with a controllable layer of alpha - one per layer.



There are two ways of expressing alpha in an image:

Straight alpha is an alpha channel which functions just like RGB. Alpha acts as a fourth channel of information per pixel which is as independent of the other three as R, G and B are of each other. For example, with straight alpha it is possible to have RGB = 255 (white) and alpha = 0 (fully transparent) on the same pixel. Internally generated content, such as gradient layer, are generated with straight alpha. This is the preferable style of alpha and considering the cleaner method of the two.

Premultiplied alpha takes the alpha and applies it to the values of the RGB channels per pixel. The more transparent something gets with premultiplied alpha, the closer it gets to black - as if the content is sitting on a black table. Premultiplied is the default output of Adobe Photoshop or AfterEffects. the result is our pixel at 255 RGB (full white) with 0 alpha would be calculated as a black pixel in the final image.

Here are explanations of what each individual blend mode will do.

## Over

Makes a layer fully opaque. Premultiplies all alpha onto the RGB value of each pixel. Alpha = black, so adjusting the brightness of a layer in Over blend mode makes it darker.

## Alpha

Default blend mode. It will apply alpha values as a transparency if the alpha is present. Brightness changes will make the layer more or less transparent.

## Add

Adds the value of each RGB pixel together. Always creates a brighter result. Values clamp at 255.

## Multiply

Reads the level of each subpixel as a level between 0.0 and 1.0, and multiplies source with blend. The result is always a darker image overall. For example: white x grey = 0.5. White turns transparent, black takes precedence. Alpha is applied in the same fashion as the Over Blend mode.

## Mask

Choose mask when you want to multiple out content upwards in the stack of layers, rather than downwards. In order to make this work you have to use the same mapping on the layer set to mask and the layer on top.

## Multiply-Fade

The same as Multiply, but will make use of the alpha channel to calculate transparency in the source and blend layers. Since maximum transparency is premultiplied, alpha results in black. This will ignore black created through premultiplying.

## Multiply-Alpha

Multiply with straight alpha. This mode assumes that the alpha has not been premultiplied onto the RGB values and will not apply a correction to the semi-transparent pixels.

## Premultiply Alpha

Like how Multiply-fade will ignore the darkening caused by premultiplying, this blend mode will do the same with Alpha.

## Colour Burn

Blend mode increases the contrast to darken the base colour while reflecting the blend colour. The darker the blend colour, the more intensely the colour will be applied in the base image. White as the blend colour produces no change. Using the colour burn blend mode can produce some harsh results at full opacity.

The colour burn blend mode can be used to make tonal and colour adjustments to a layer.

## Screen

This blend mode looks at each channels colour information and multiplies the inverse of the blend and base colour. The result is always a lighter colour. Screening with black leaves the colour unchanged. Screening with white produces white. The effect is similar to projecting multiple images on top of each other - where bright white is fully opaque, black is fully transparent and 50% grey is 50% transparent.

## Overlay

Multiplies or screens the colours, depending on the base colour. Patterns or colours overlay the existing pixels while preserving the highlights and shadows of the base colour. The base colour is not replaced, but mixed with the blend colour to reflect the lightness or darkness of the original colour.

## Hard Light

Multiplies or screens the colours, depending on the blend colour. The effect is similar to shining a harsh spotlight on the image. If the blend colour (light source/top layer) is lighter than 50% grey, the image is lightened as if it were screened. This is useful for adding highlights to an image. If the blend colour is darker than 50% grey, the image is darkened as if it were multiplied. This is useful for adding shadows to an image. Painting with pure black or white results in pure black or white.

## Soft Light

Darkens or lightens the colours, depending on the blend colour. The effect is similar to shining a diffused spotlight on the image. If the blend colour (light source/top layer) is lighter than 50% grey, the image is lightened as if it were dodged. If the blend colour is darker than 50% grey, the image is darkened as if it were burned in. Painting with pure black or white produces a distinctly darker or lighter area, but does not result in pure black or white.

## Darken

Looks at the colour information in each channel and selects the base or blend colour - whichever is darker - as the result colour. Pixels lighter than the blend colour are replaced and pixels darker than the blend colour do not change.

## Lighten

Looks at the colour information in each channel and selects the base or blend colour - whichever is lighter - as the result colour. Pixels darker than the blend colour are replaced and pixels lighter than the blend colour do not change.

## Difference

Looks at the colour information in each channel and subtracts either the blend colour from the base colour or the base colour from the blend colour depending on which has the greater brightness value.

Blending with white inverts the base colour values and blending with black produces no change.

## Exclusion

Creates an effects similar to but lower in contrast than the difference mode. Blending with white inverts the base colour values. Blending with black produces no change.

## Colour Dodge

Looks at the colour information in each channel and brightens the base colour to reflect the blend colour by decreasing contrast between the two. Blending with black produces no change.

## Hard Mix

Adds the RGB channels of the blend colour to the RGB values of the base colour. If the resulting sum for a channel is 255 or greater, it receives a value of 255; if it is less than 255 it receives a value of 0. Therefore all blended pixels have RGB channels of either 0 or 255. This changes all pixels to primary additive colours (RGB), white or black.

## Brightness

This property (which appears as a light bulb icon) controls the brightness of the layer output.

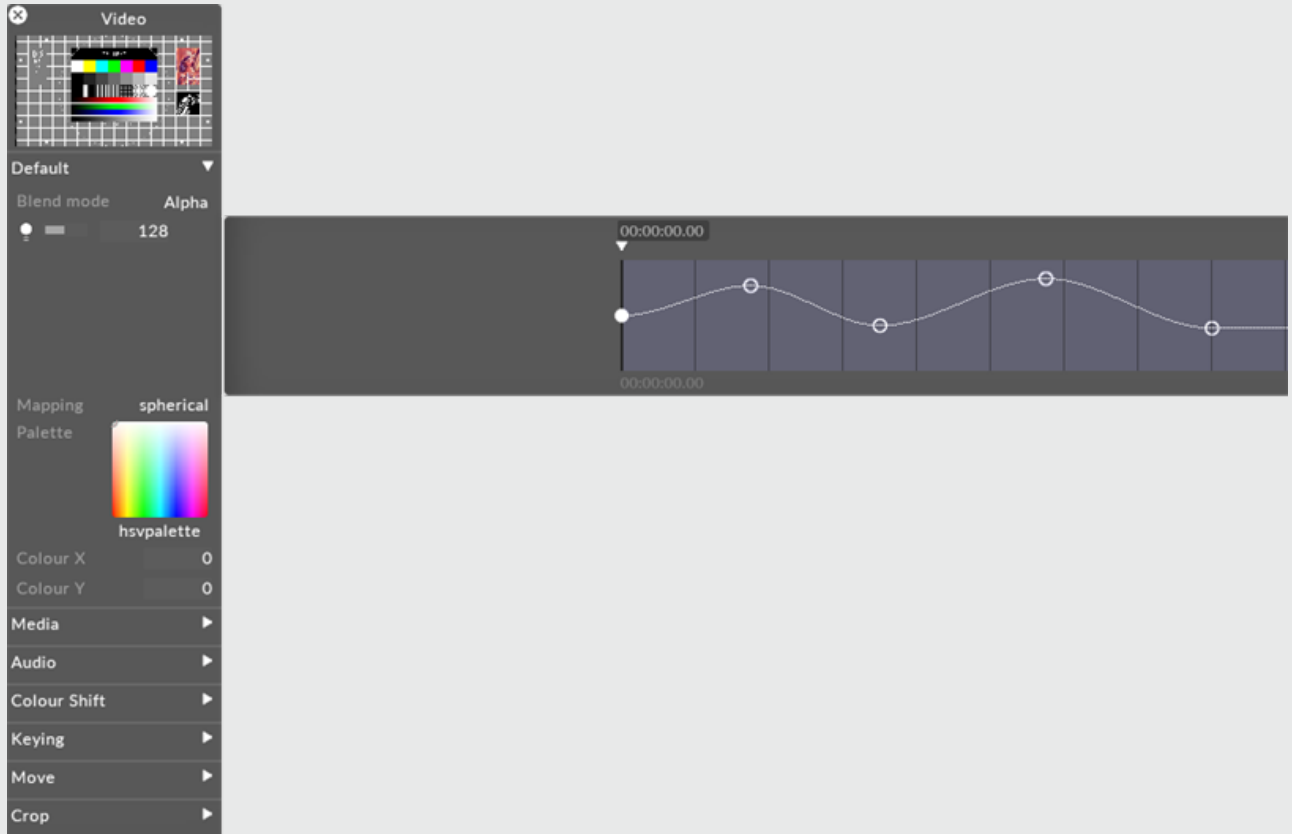

If the layers blend mode is set to Alpha, then reducing the brightness to 0 also reduces the opacity of the layer to 0. This can be useful when you want to dissolve from one layer to the next. In that case, you can place the new layer above the old layer and increase its brightness level.

## Mapping

The mapping property controls how the layer output is mapped onto the screen(s) in the Stage level.

**Video**

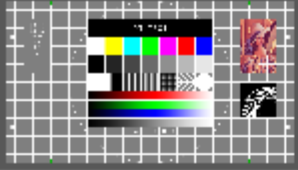

Default ▾

Blend mode Alpha

128

Mapping direct map 1

Palette



hsvpalette

Colour X 0

Colour Y 0

Media ▾

Video



d3\_test\_16-9.png

Speed 1

Mode Normal

At end point Loop

Transition time 0

Audio ▶

Colour Shift ▶

Keying ▶

Move ▶

Crop ▶

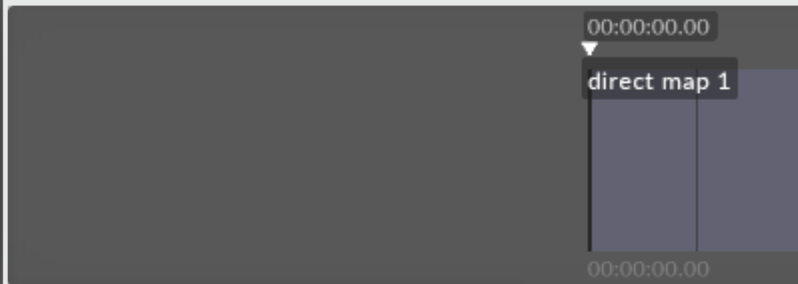

00:00:00.00

direct map 1

00:00:00.00

**mappings**

New mapping: OK Search:

all New Mappings

- direct map 1
- feed map 2
- feed mapping
- mapping 1
- mapping 2
- parallel
- spherical

For information on mapping, including how to use the different mapping types offered by Disguise software, please see the chapter [Content Mapping](#).

## Lut layer properties

### Colour Lut

This property allows you to select a lut file from the project folder. Lut files live in a specified folder inside the Objects folder. For more information see [Project Structure](#).

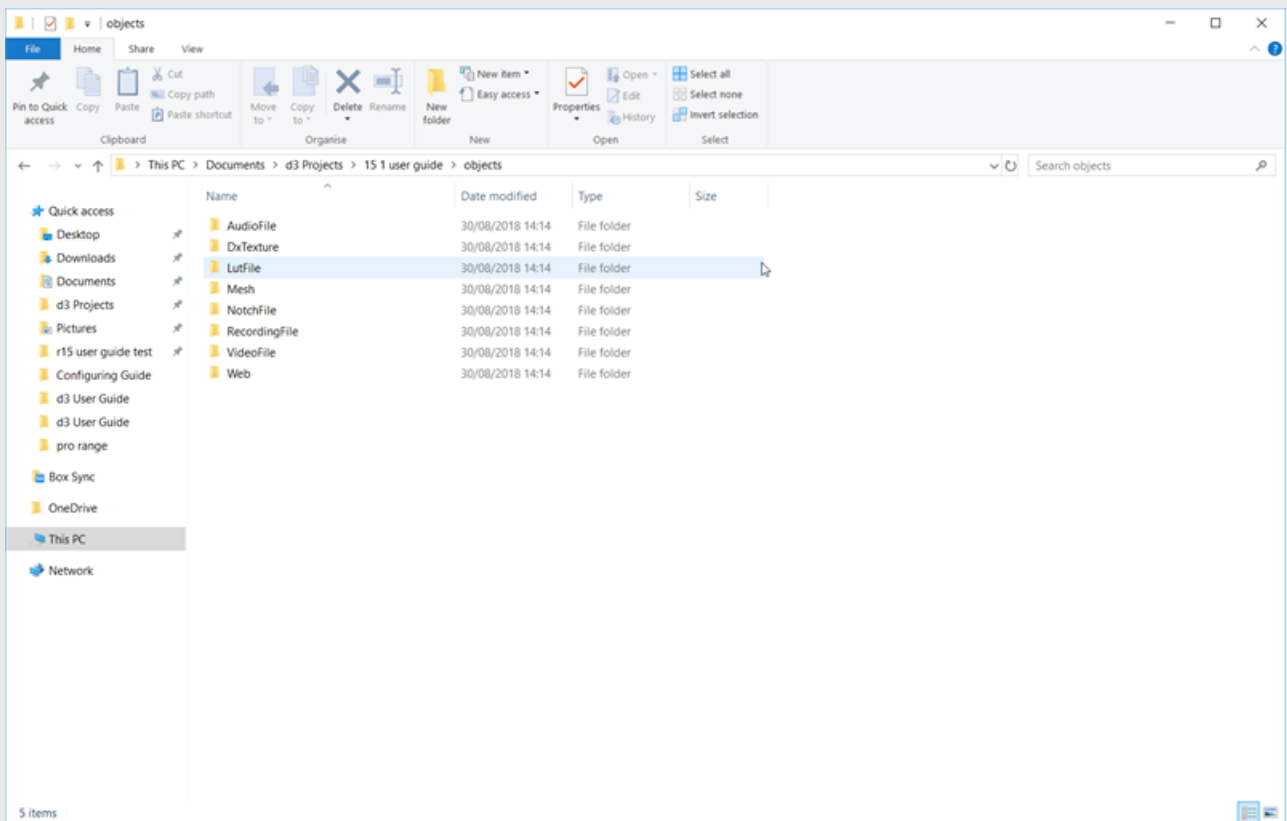

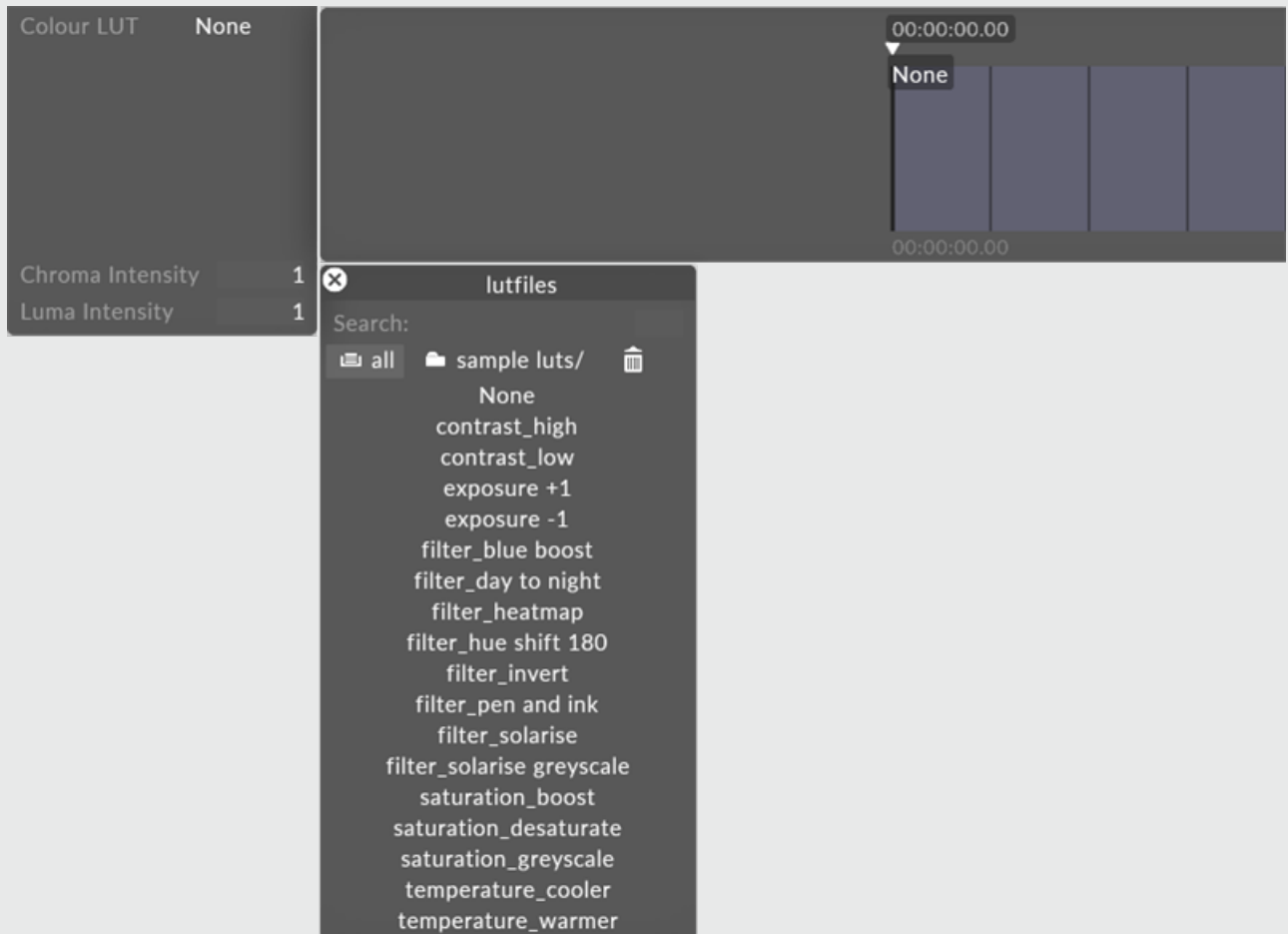

## Chroma intensity

This property controls the chroma intensity. If the Chroma intensity is at 0, then the content is using the original chroma, whereas if it is at 1 its the chroma specified in the lut file. You can alter the max value by right clicking the property which will simply multiply the original Chroma value by the new max value.

## Luma intensity

This property controls the Luma intensity. If the Luma intensity is at 0 then the luminosity will be the same as the original content, where as if it is at 1 then it will be the Luma specified in the lut file. You can



alter the max value by right clicking the property which will simply multiple the original Luma value by the new max value.

# MotionBlur

The MotionBlur layer causes moving objects in the source content to leave trails behind them.

All Effect layers take their source from other layer types - either content or generative - by use of an arrow. Linking two layers with an arrow defines the arrowed from layer as the source, and the arrowed to layer as the destination. If you have an arrow between a content layer and effect layer, it is said that the content layer is being 'piped in' to the effect layer. For more information on arrows, see the [compositing layers topic](#).

To draw an arrow between two layers, hold down **ALT** and left click & drag between the source and destination layer.

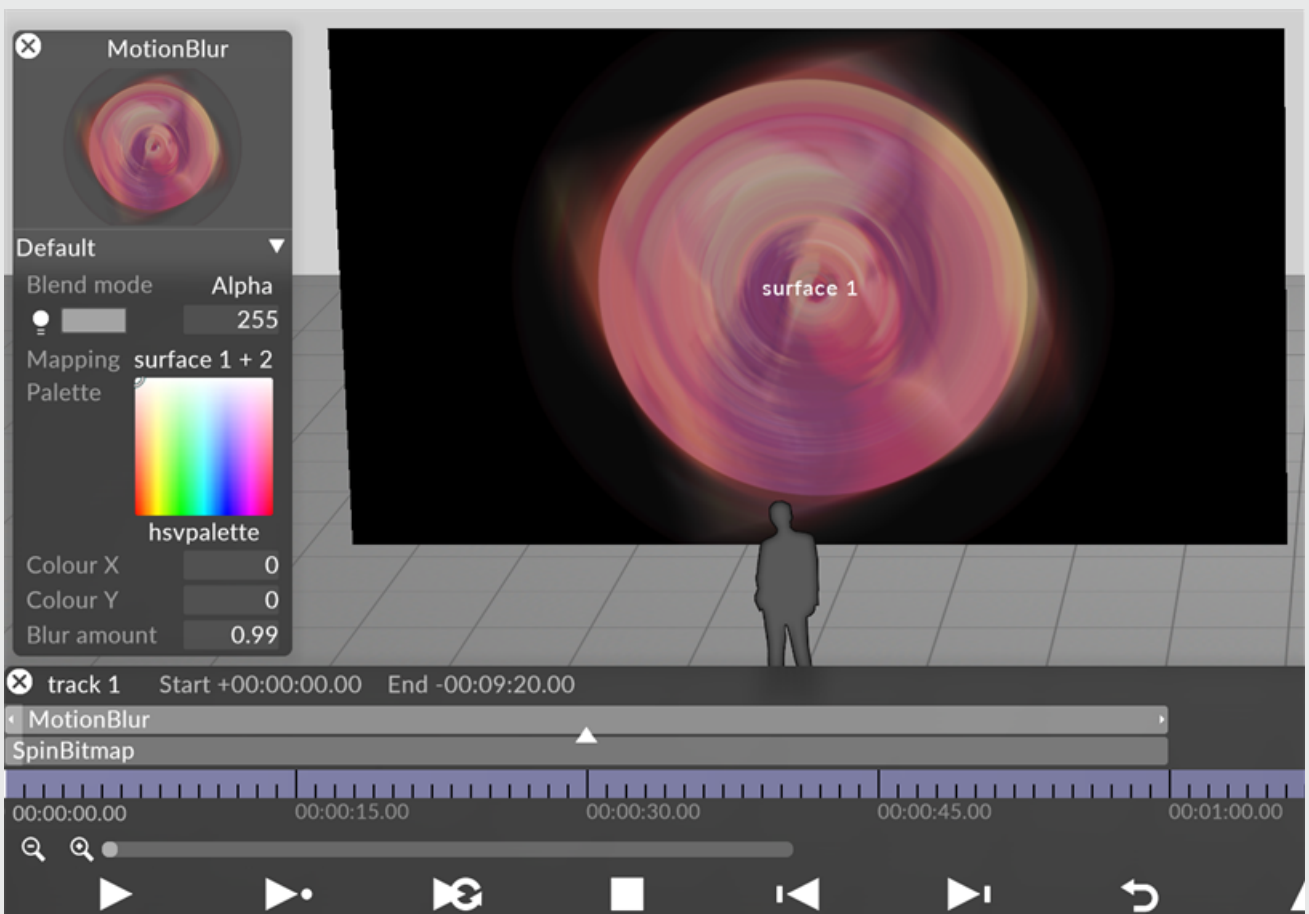

# Blend Mode

BlendMode controls how the output of the layer is composited with the layers below. Layers are rendered in a bottom-up order: layers at the top can modify the output of the layers below.

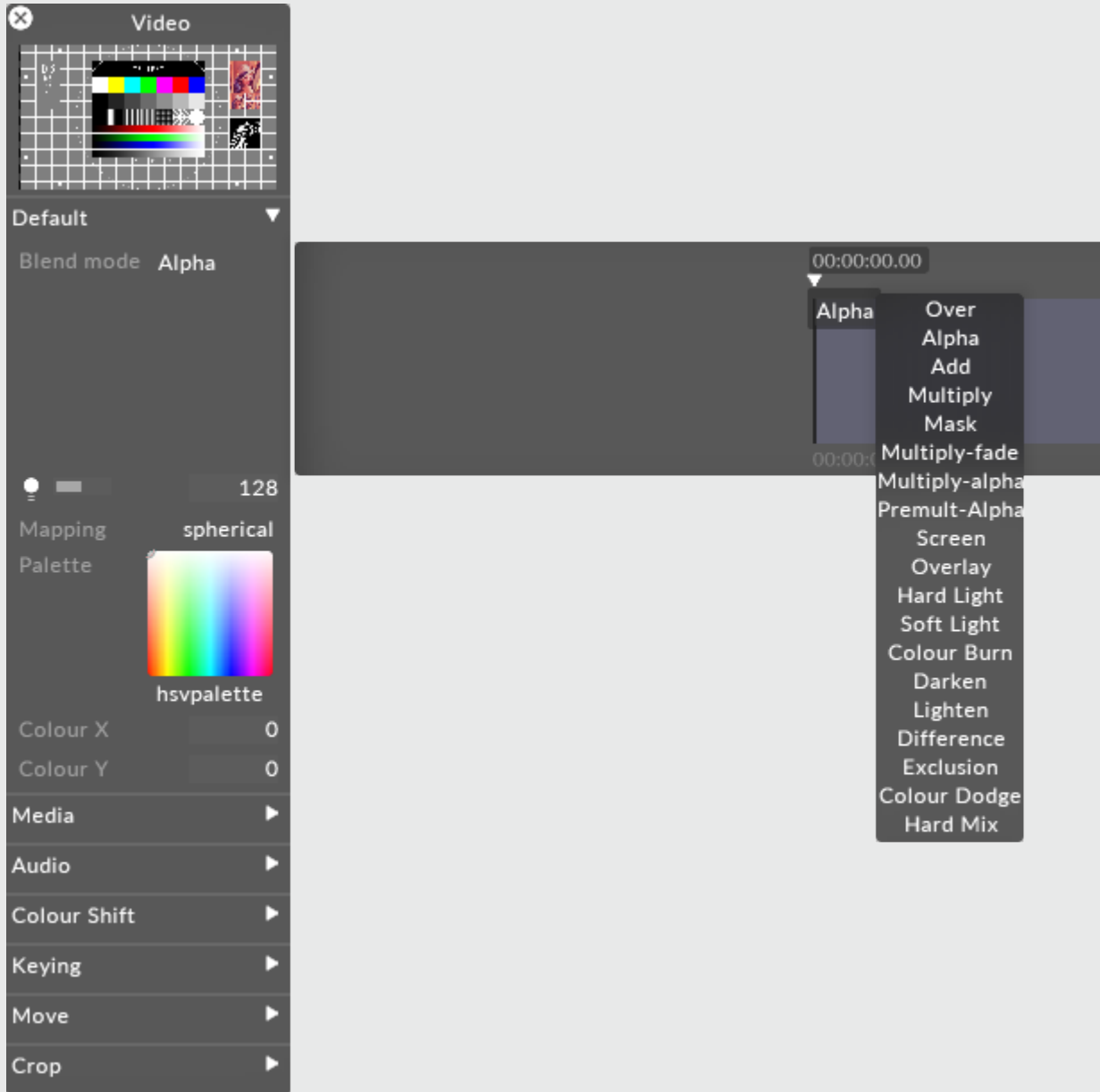

Changing brightness of a content layer in Disguise software is actually controlling the value of the alpha of the layer. Even when displaying a HAP video, the software will composite the layer with a controllable layer of alpha - one per layer.

There are two ways of expressing alpha in an image:

Straight alpha is an alpha channel which functions just like RGB. Alpha acts as a fourth channel of information per pixel which is as independent of the other three as R, G and B are of each other. For example, with straight alpha it is possible to have RGB = 255 (white) and alpha = 0 (fully transparent) on the same pixel. Internally generated content, such as gradient layer, are generated with straight alpha. This is the preferable style of alpha and considering the cleaner method of the two.

Premultiplied alpha takes the alpha and applies it to the values of the RGB channels per pixel. The more transparent something gets with premultiplied alpha, the closer it gets to black - as if the content is sitting on a black table. Premultiplied is the default output of Adobe Photoshop or AfterEffects. the result is our pixel at 255 RGB (full white) with 0 alpha would be calculated as a black pixel in the final image.

Here are explanations of what each individual blend mode will do.

## Over

Makes a layer fully opaque. Premultiplies all alpha onto the RGB value of each pixel. Alpha = black, so adjusting the brightness of a layer in Over blend mode makes it darker.

## Alpha

Default blend mode. It will apply alpha values as a transparency if the alpha is present. Brightness changes will make the layer more or less transparent.

## Add

Adds the value of each RGB pixel together. Always creates a brighter result. Values clamp at 255.

## Multiply

Reads the level of each subpixel as a level between 0.0 and 1.0, and multiplies source with blend. The result is always a darker image overall. For example: white x grey = 0.5. White turns transparent, black takes precedence. Alpha is applied in the same fashion as the Over Blend mode.

## Mask

Choose mask when you want to multiple out content upwards in the stack of layers, rather than downwards. In order to make this work you have to use the same mapping on the layer set to mask and the layer on top.

## Multiply-Fade

The same as Multiply, but will make use of the alpha channel to calculate transparency in the source and blend layers. Since maximum transparency is premultiplied, alpha results in black. This will ignore black created through premultiplying.

## Multiply-Alpha

Multiply with straight alpha. This mode assumes that the alpha has not been premultiplied onto the RGB values and will not apply a correction to the semi-transparent pixels.

## Premultiply Alpha

Like how Multiply-fade will ignore the darkening caused by premultiplying, this blend mode will do the same with Alpha.

## Colour Burn

Blend mode increases the contrast to darken the base colour while reflecting the blend colour. The darker the blend colour, the more intensely the colour will be applied in the base image. White as the blend colour produces no change. Using the colour burn blend mode can produce some harsh results at full opacity.

The colour burn blend mode can be used to make tonal and colour adjustments to a layer.

## Screen

This blend mode looks at each channels colour information and multiplies the inverse of the blend and base colour. The result is always a lighter colour. Screening with black leaves the colour unchanged. Screening with white produces white. The effect is similar to projecting multiple images on top of each other - where bright white is fully opaque, black is fully transparent and 50% grey is 50% transparent.

## Overlay

Multiplies or screens the colours, depending on the base colour. Patterns or colours overlay the existing pixels while preserving the highlights and shadows of the base colour. The base colour is not replaced, but mixed with the blend colour to reflect the lightness or darkness of the original colour.

## Hard Light

Multiplies or screens the colours, depending on the blend colour. The effect is similar to shining a harsh spotlight on the image. If the blend colour (light source/top layer) is lighter than 50% grey, the image is lightened as if it were screened. This is useful for adding highlights to an image. If the blend colour is darker than 50% grey, the image is darkened as if it were multiplied. This is useful for adding shadows to an image. Painting with pure black or white results in pure black or white.

## Soft Light

Darkens or lightens the colours, depending on the blend colour. The effect is similar to shining a diffused spotlight on the image. If the blend colour (light source/top layer) is lighter than 50% grey, the image is lightened as if it were dodged. If the blend colour is darker than 50% grey, the image is darkened as if it were burned in. Painting with pure black or white produces a distinctly darker or lighter area, but does not result in pure black or white.

## Darken

Looks at the colour information in each channel and selects the base or blend colour - whichever is darker - as the result colour. Pixels lighter than the blend colour are replaced and pixels darker than the blend colour do not change.

## Lighten

Looks at the colour information in each channel and selects the base or blend colour - whichever is lighter - as the result colour. Pixels darker than the blend colour are replaced and pixels lighter than the blend colour do not change.

## Difference

Looks at the colour information in each channel and subtracts either the blend colour from the base colour or the base colour from the blend colour depending on which has the greater brightness value.

Blending with white inverts the base colour values and blending with black produces no change.

## Exclusion

Creates an effects similar to but lower in contrast than the difference mode. Blending with white inverts the base colour values. Blending with black produces no change.

## Colour Dodge

Looks at the colour information in each channel and brightens the base colour to reflect the blend colour by decreasing contrast between the two. Blending with black produces no change.

## Hard Mix

Adds the RGB channels of the blend colour to the RGB values of the base colour. If the resulting sum for a channel is 255 or greater, it receives a value of 255; if it is less than 255 it receives a value of 0. Therefore all blended pixels have RGB channels of either 0 or 255. This changes all pixels to primary additive colours (RGB), white or black.

## Brightness

This property (which appears as a light bulb icon) controls the brightness of the layer output.



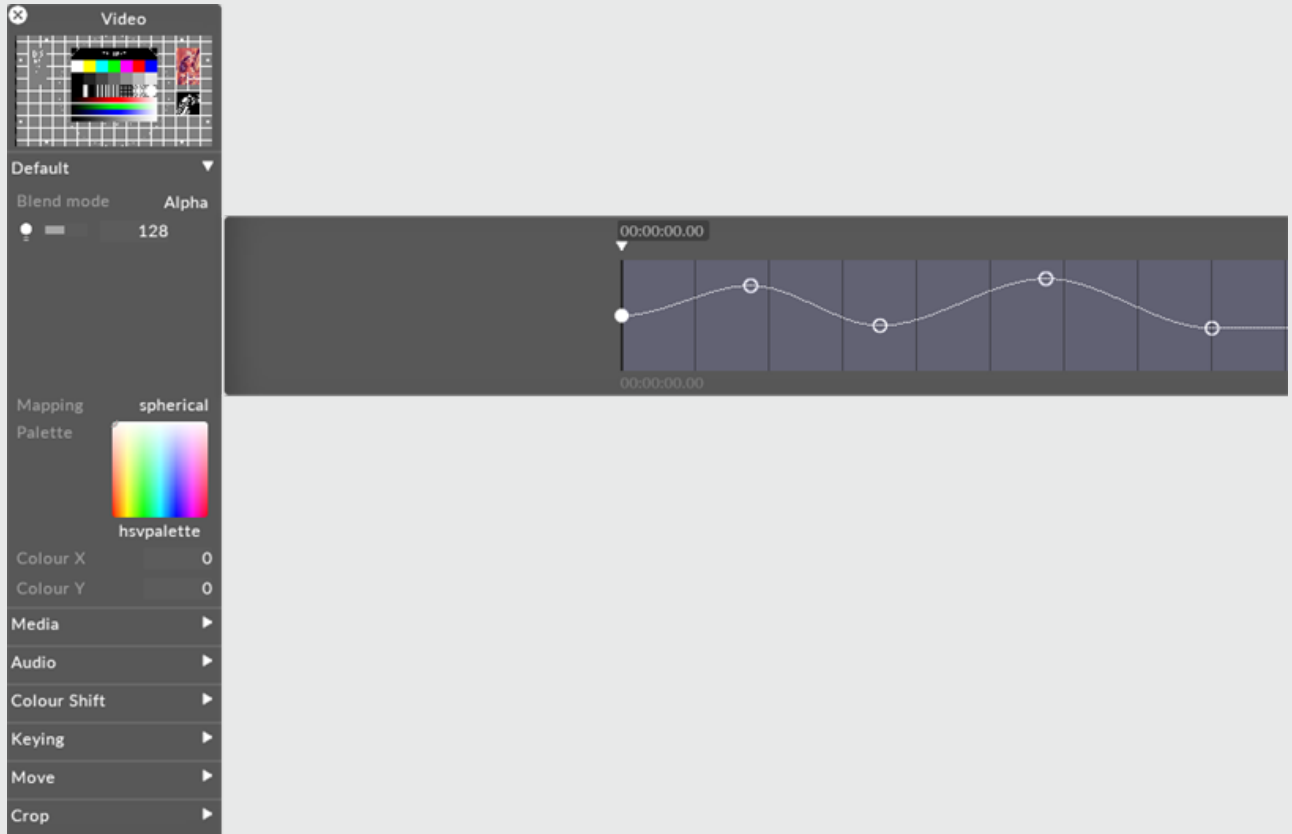

If the layers blend mode is set to Alpha, then reducing the brightness to 0 also reduces the opacity of the layer to 0. This can be useful when you want to dissolve from one layer to the next. In that case, you can place the new layer above the old layer and increase its brightness level.

## Mapping

The mapping property controls how the layer output is mapped onto the screen(s) in the Stage level.

**Video**

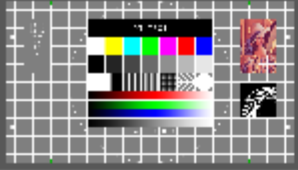

Default ▾

Blend mode Alpha

128

Mapping direct map 1

Palette



hsvpalette

Colour X 0

Colour Y 0

Media ▾

Video



d3\_test\_16-9.png

Speed 1

Mode Normal

At end point Loop

Transition time 0

Audio ▶

Colour Shift ▶

Keying ▶

Move ▶

Crop ▶

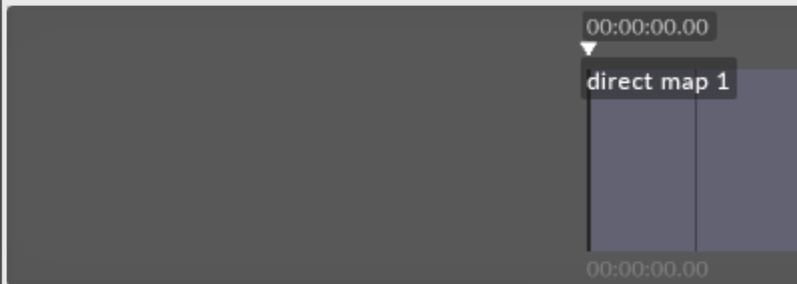

00:00:00.00

direct map 1

00:00:00.00

**mappings**

New mapping: OK Search:

all New Mappings

- direct map 1
- feed map 2
- feed mapping
- mapping 1
- mapping 2
- parallel
- spherical

For information on mapping, including how to use the different mapping types offered by Disguise software, please see the chapter [Content Mapping](#).

## Palette

This points to the still image file that defines the bitmap from which the tint colour is taken. The default palette ( HSVPAL ) consists of the complete range of hues and saturations. Selecting this property will open the Texture object library, which shows all of the still image files saved on your local hard-drive in the **DxTexture** folder.

To control the location within the current palette bitmap, and thus control the colour, you have to edit the **xCol** and **yCol** values (see the section for xCol, yCol).

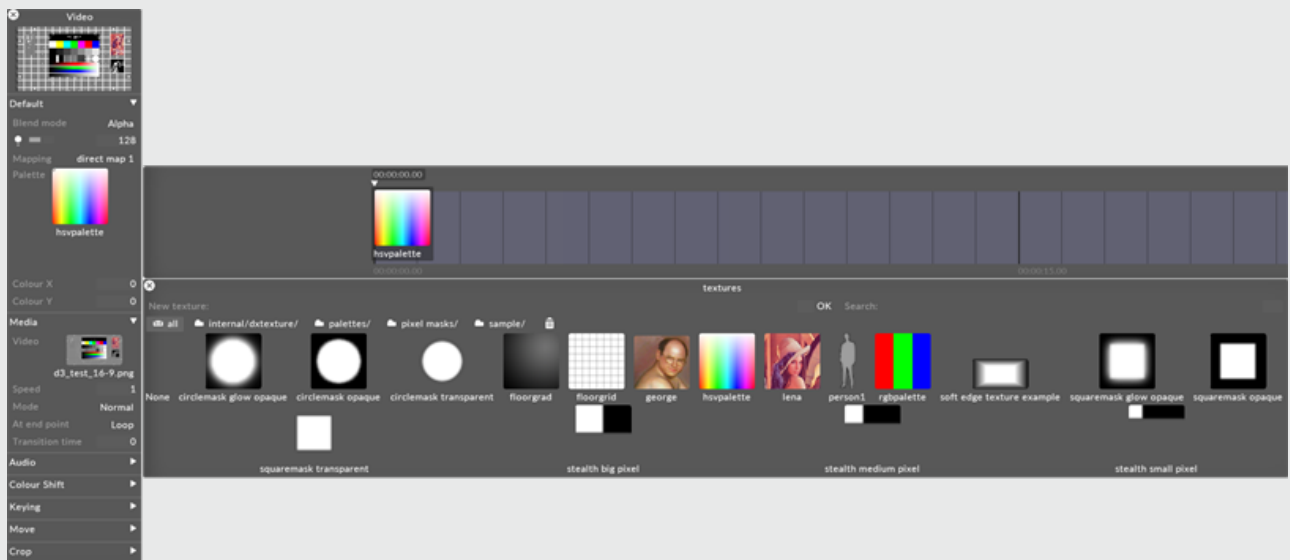

To change the current palette bitmap:

1. Left-click **palette** to open the Texture object library.
2. Left-click the still image file you want to use for the palette bitmap.

If you want to use a palette bitmap other than the standard still images provided in Disguise software, you will need to use a custom still image file.

See the [Placing media files for a project](#) sub-chapter to understand where to place a custom still image file and how to access it in Disguise software. Also save the file to a [supported file format](#).

## xCol yCol

These properties control the coordinates within the current palette bitmap where the output colour is sampled from. The default value is 0,0 which points at the color white (if you are using the HSVPAL palette). Multiplying white with the colors of the chosen content simply generates the original content colors. **Colour X** controls the horizontal position, where 0 is the leftmost edge and 255 is the rightmost edge. **Colour Y** controls the vertical position, where 0 is the top edge and 255 is the bottom edge.

For example, to saturate the video clip red, change the **Colour Y** value to 255 and use 0 for the **Colour X** value. These coordinates refer to the color red in the palette which is being multiplied with the colors of the existing content.

When you are using the default palette HSVPAL , **Colour Y** controls saturation, and **Colour X** controls hue.

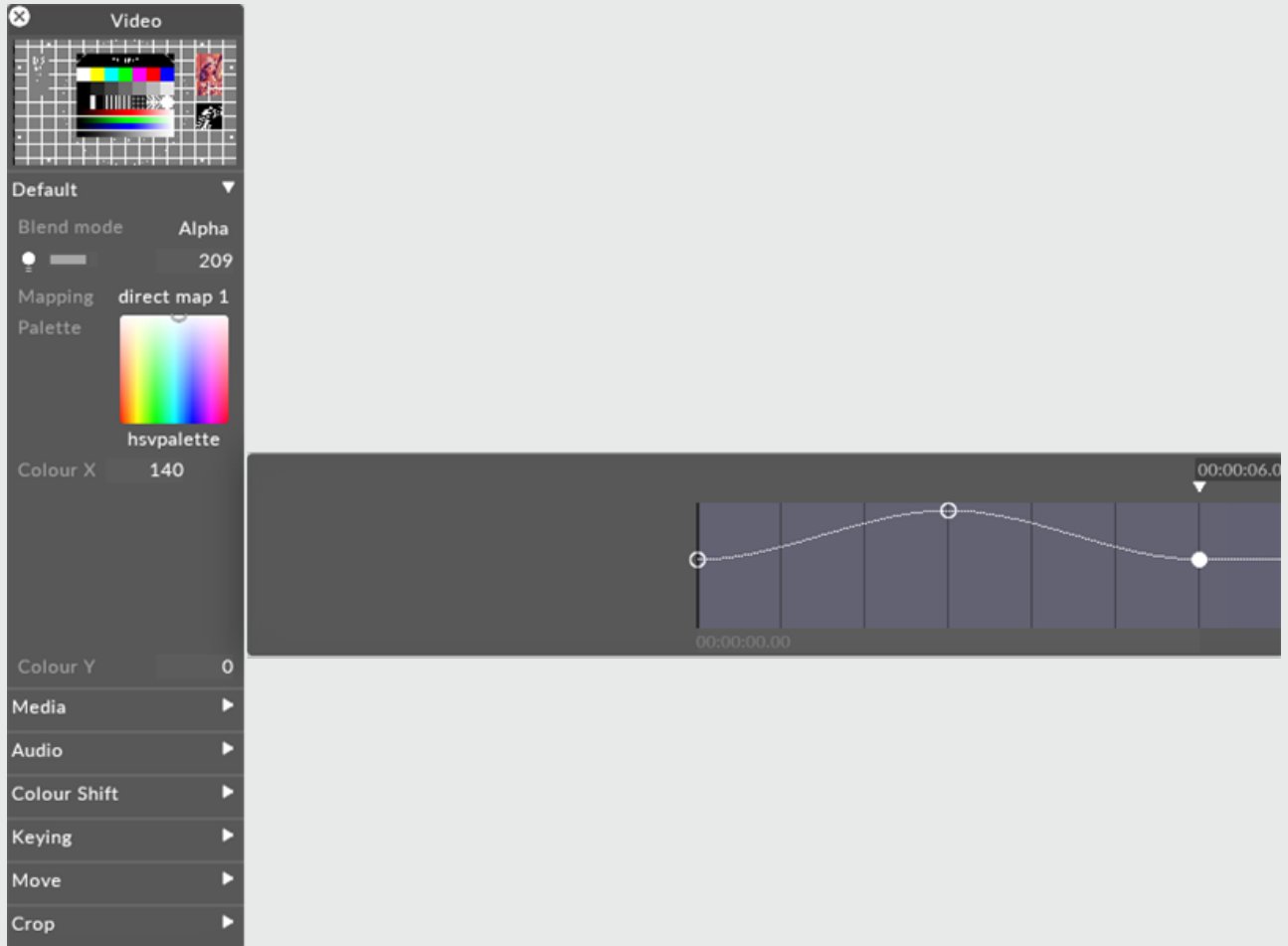

## Blur amount

The amplitude of the blur effect. Default value is 0.5. The min/max values are 0 and 1. Decreasing the value from 0.5 to 0 will sharpen the content, whilst increasing the value from 0.5 to 1 will gradually amplify the blurriness of the content.

# Noise

The Noise layer creates video noise onto content when it is composed with another content layer.

All Effect layers take their source from other layer types - either content or generative - by use of an arrow. Linking two layers with an arrow defines the arrowed from layer as the source, and the arrowed to layer as the destination. If you have an arrow between a content layer and effect layer, it is said that the content layer is being 'piped in' to the effect layer. For more information on arrows, see the [compositing layers](#) topic.

To draw an arrow between two layers, hold down **ALT** and left click & drag between the source and destination layer.

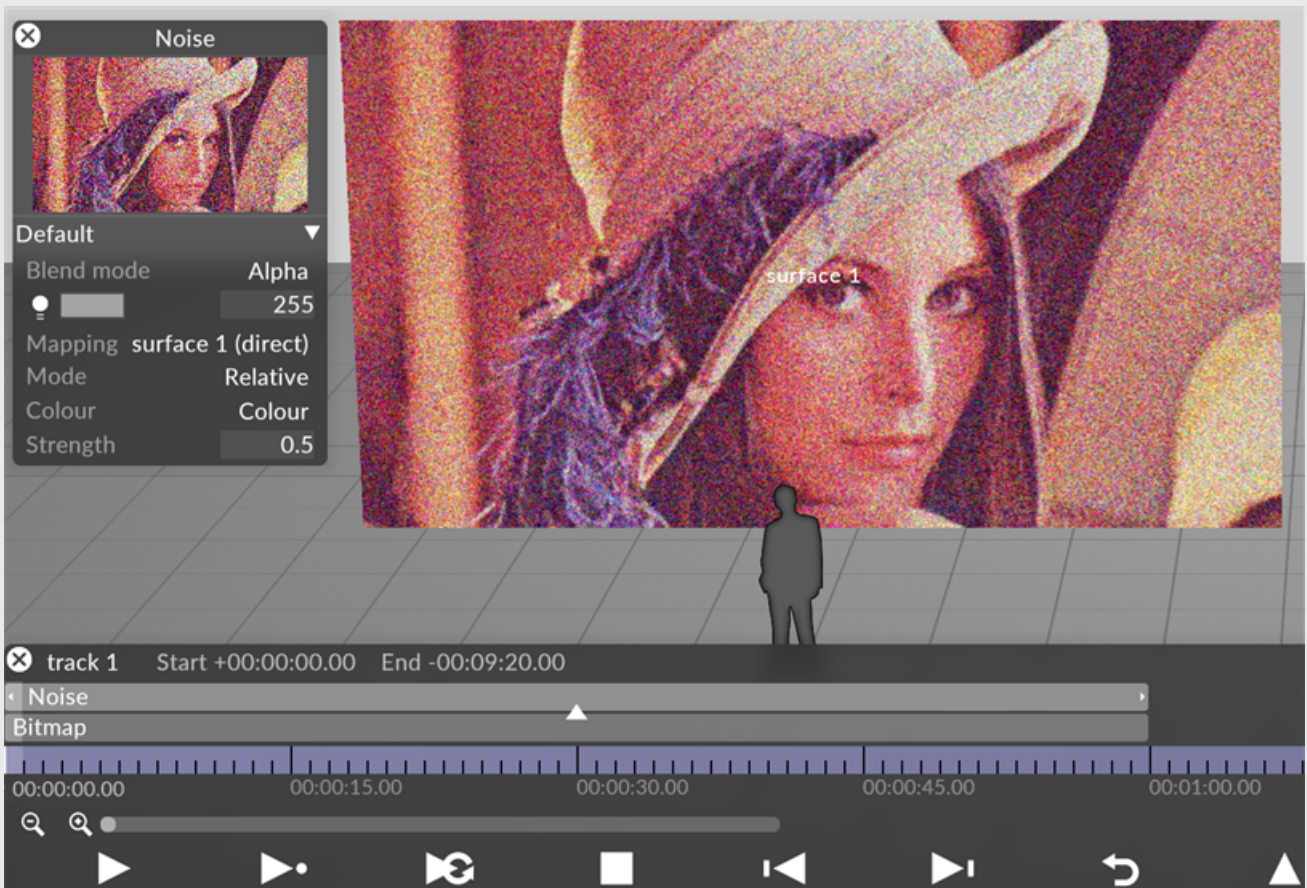

# Blend Mode

BlendMode controls how the output of the layer is composited with the layers below. Layers are rendered in a bottom-up order: layers at the top can modify the output of the layers below.

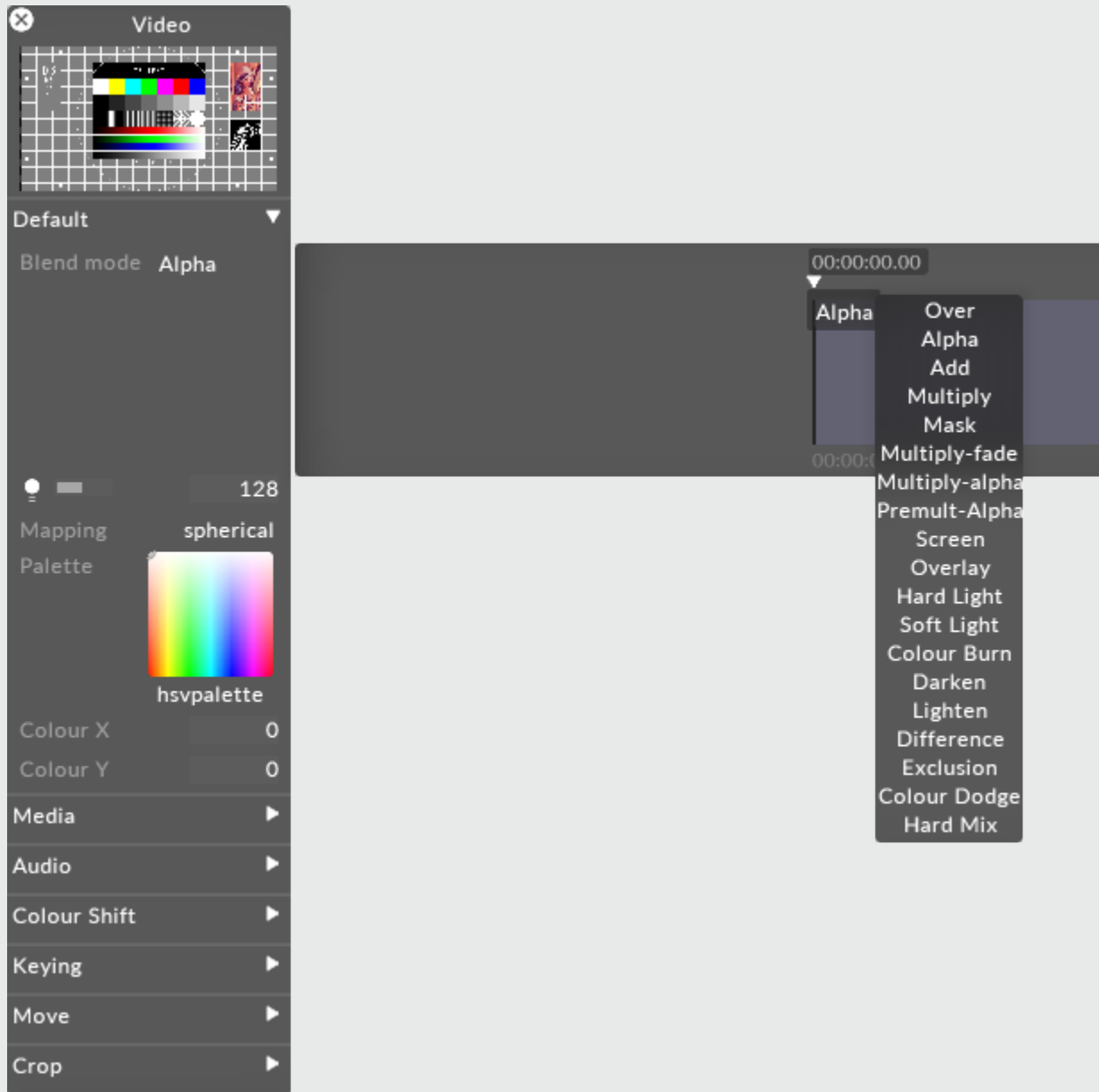

Changing brightness of a content layer in Disguise software is actually controlling the value of the alpha of the layer. Even when displaying a HAP video, the software will composite the layer with a controllable layer of alpha - one per layer.



There are two ways of expressing alpha in an image:

Straight alpha is an alpha channel which functions just like RGB. Alpha acts as a fourth channel of information per pixel which is as independent of the other three as R, G and B are of each other. For example, with straight alpha it is possible to have RGB = 255 (white) and alpha = 0 (fully transparent) on the same pixel. Internally generated content, such as gradient layer, are generated with straight alpha. This is the preferable style of alpha and considering the cleaner method of the two.

Premultiplied alpha takes the alpha and applies it to the values of the RGB channels per pixel. The more transparent something gets with premultiplied alpha, the closer it gets to black - as if the content is sitting on a black table. Premultiplied is the default output of Adobe Photoshop or AfterEffects. The result is our pixel at 255 RGB (full white) with 0 alpha would be calculated as a black pixel in the final image.

Here are explanations of what each individual blend mode will do.

## Over

Makes a layer fully opaque. Premultiplies all alpha onto the RGB value of each pixel. Alpha = black, so adjusting the brightness of a layer in Over blend mode makes it darker.

## Alpha

Default blend mode. It will apply alpha values as a transparency if the alpha is present. Brightness changes will make the layer more or less transparent.

## Add

Adds the value of each RGB pixel together. Always creates a brighter result. Values clamp at 255.

## Multiply

Reads the level of each subpixel as a level between 0.0 and 1.0, and multiplies source with blend. The result is always a darker image overall. For example: white x grey = 0.5. White turns transparent, black takes precedence. Alpha is applied in the same fashion as the Over Blend mode.

## Mask

Choose mask when you want to multiply out content upwards in the stack of layers, rather than downwards. In order to make this work you have to use the same mapping on the layer set to mask and the layer on top.

## Multiply-Fade

The same as Multiply, but will make use of the alpha channel to calculate transparency in the source and blend layers. Since maximum transparency is premultiplied, alpha results in black. This will ignore black created through premultiplying.

## Multiply-Alpha

Multiply with straight alpha. This mode assumes that the alpha has not been premultiplied onto the RGB values and will not apply a correction to the semi-transparent pixels.

## Premultiply Alpha

Like how Multiply-fade will ignore the darkening caused by premultiplying, this blend mode will do the same with Alpha.

## Colour Burn

Blend mode increases the contrast to darken the base colour while reflecting the blend colour. The darker the blend colour, the more intensely the colour will be applied in the base image. White as the blend colour produces no change. Using the colour burn blend mode can produce some harsh results at full opacity.

The colour burn blend mode can be used to make tonal and colour adjustments to a layer.

## Screen

This blend mode looks at each channels colour information and multiplies the inverse of the blend and base colour. The result is always a lighter colour. Screening with black leaves the colour unchanged. Screening with white produces white. The effect is similar to projecting multiple images on top of each other - where bright white is fully opaque, black is fully transparent and 50% grey is 50% transparent.

## Overlay

Multiplies or screens the colours, depending on the base colour. Patterns or colours overlay the existing pixels while preserving the highlights and shadows of the base colour. The base colour is not replaced, but mixed with the blend colour to reflect the lightness or darkness of the original colour.

## Hard Light

Multiplies or screens the colours, depending on the blend colour. The effect is similar to shining a harsh spotlight on the image. If the blend colour (light source/top layer) is lighter than 50% grey, the image is lightened as if it were screened. This is useful for adding highlights to an image. If the blend colour is darker than 50% grey, the image is darkened as if it were multiplied. This is useful for adding shadows to an image. Painting with pure black or white results in pure black or white.

## Soft Light

Darkens or lightens the colours, depending on the blend colour. The effect is similar to shining a diffused spotlight on the image. If the blend colour (light source/top layer) is lighter than 50% grey, the image is lightened as if it were dodged. If the blend colour is darker than 50% grey, the image is darkened as if it were burned in. Painting with pure black or white produces a distinctly darker or lighter area, but does not result in pure black or white.

## Darken

Looks at the colour information in each channel and selects the base or blend colour - whichever is darker - as the result colour. Pixels lighter than the blend colour are replaced and pixels darker than the blend colour do not change.

## Lighten

Looks at the colour information in each channel and selects the base or blend colour - whichever is lighter - as the result colour. Pixels darker than the blend colour are replaced and pixels lighter than the blend colour do not change.

## Difference

Looks at the colour information in each channel and subtracts either the blend colour from the base colour or the base colour from the blend colour depending on which has the greater brightness value.

Blending with white inverts the base colour values and blending with black produces no change.

## Exclusion

Creates an effects similar to but lower in contrast than the difference mode. Blending with white inverts the base colour values. Blending with black produces no change.

## Colour Dodge

Looks at the colour information in each channel and brightens the base colour to reflect the blend colour by decreasing contrast between the two. Blending with black produces no change.

## Hard Mix

Adds the RGB channels of the blend colour to the RGB values of the base colour. If the resulting sum for a channel is 255 or greater, it receives a value of 255; if it is less than 255 it receives a value of 0. Therefore all blended pixels have RGB channels of either 0 or 255. This changes all pixels to primary additive colours (RGB), white or black.

## Brightness

This property (which appears as a light bulb icon) controls the brightness of the layer output.

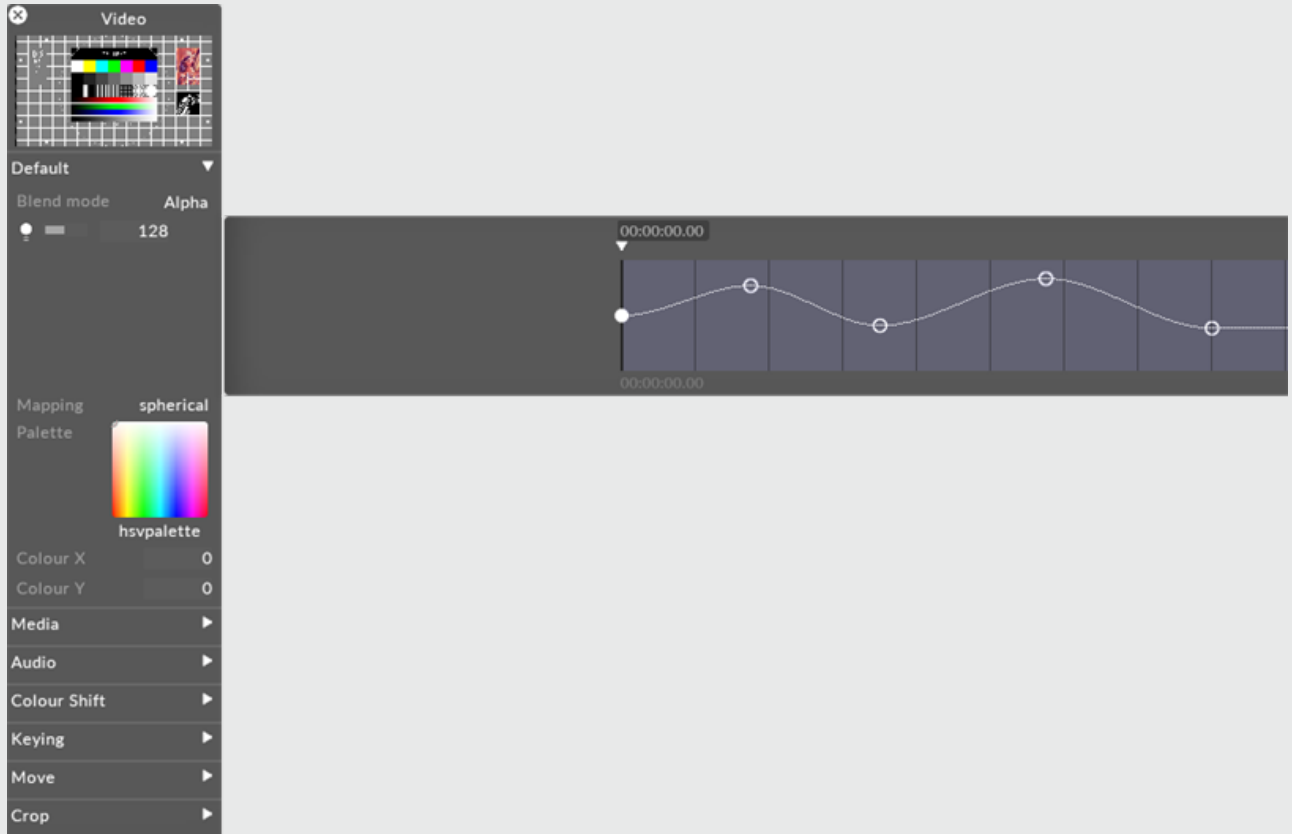

If the layers blend mode is set to Alpha, then reducing the brightness to 0 also reduces the opacity of the layer to 0. This can be useful when you want to dissolve from one layer to the next. In that case, you can place the new layer above the old layer and increase its brightness level.

## Mapping

The mapping property controls how the layer output is mapped onto the screen(s) in the Stage level.

**Video**

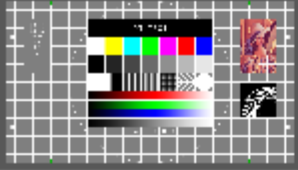

Default ▾

Blend mode Alpha

128

Mapping direct map 1

Palette



hsvpalette

Colour X 0

Colour Y 0

Media ▾

Video



d3\_test\_16-9.png

Speed 1

Mode Normal

At end point Loop

Transition time 0

Audio ▶

Colour Shift ▶

Keying ▶

Move ▶

Crop ▶



00:00:00.00

direct map 1

00:00:00.00

**mappings**

New mapping: OK Search:

all New Mappings

- direct map 1
- feed map 2
- feed mapping
- mapping 1
- mapping 2
- parallel
- spherical

For information on mapping, including how to use the different mapping types offered by Disguise software, please see the chapter [Content Mapping](#).

## Mode

- Relative
- Absolute - Noise value is added to the source image

## Colour

- Colour - Noise is composed of random colour values
- Greyscale - Noise is composed of random greyscale values

## Strength

Adjust the strength of the noise

# Pixelate

The Pixelate layer pixelates whatever content is pumped into it.

All Effect layers take their source from other layer types - either content or generative - by use of an arrow. Linking two layers with an arrow defines the arrowed from layer as the source, and the arrowed to layer as the destination. If you have an arrow between a content layer and effect layer, it is said that the content layer is being 'piped in' to the effect layer. For more information on arrows, see the [compositing layers](#) topic.

To draw an arrow between two layers, hold down **ALT** and left click & drag between the source and destination layer.

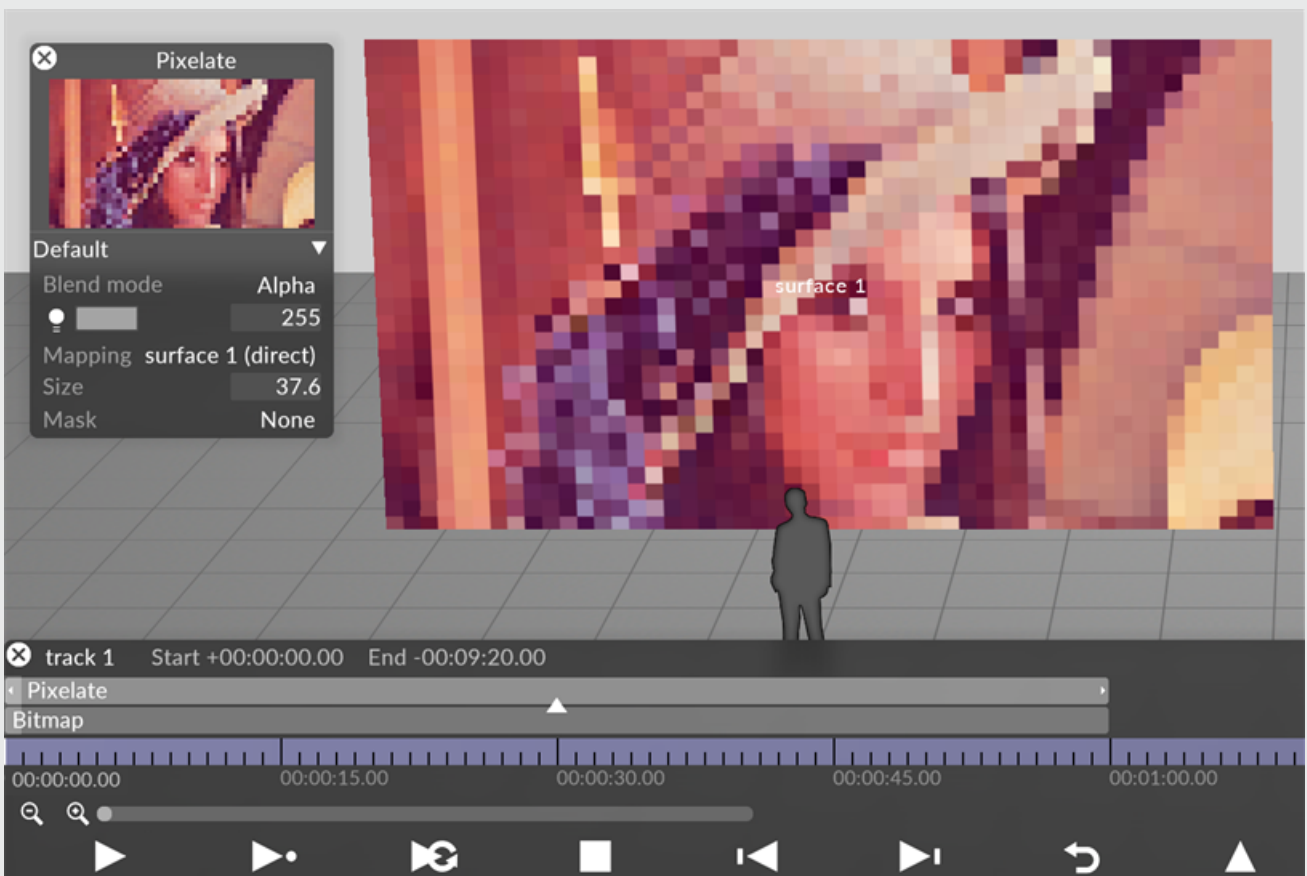

*Pixelate layer and editor*



The Pixelate layer supports the use of Arrows, allowing content layers to be piped into the Pixelate layer. For more information please see the sub-chapter [Composing layers using Arrows](#).

## Preview Thumbnail

This property is a small preview window at the top of the editor showing you what the layer output looks like.



## Blend Mode

BlendMode controls how the output of the layer is composited with the layers below. Layers are rendered in a bottom-up order: layers at the top can modify the output of the layers below.

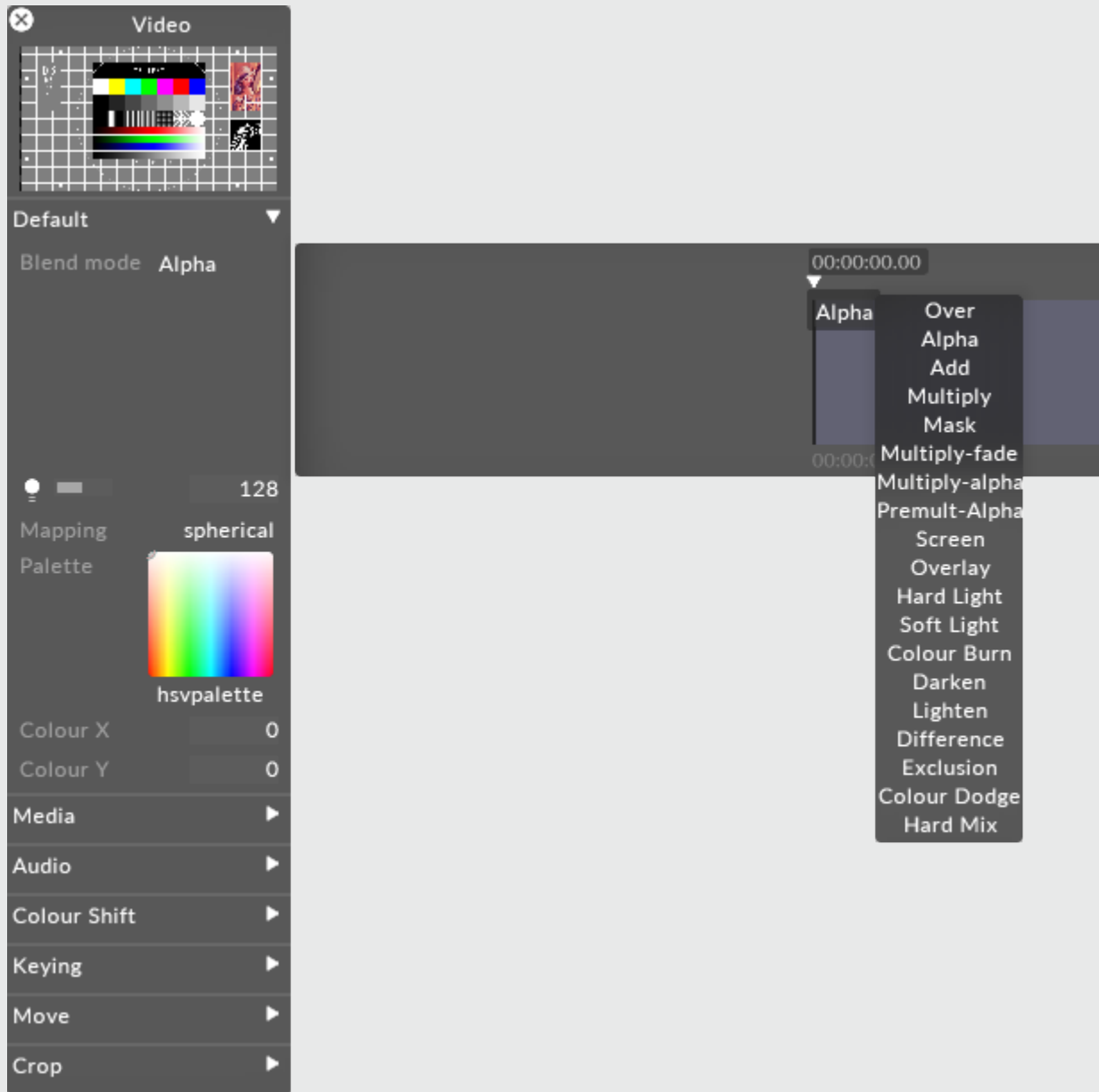

Changing brightness of a content layer in Disguise software is actually controlling the value of the alpha of the layer. Even when displaying a HAP video, the software will composite the layer with a controllable layer of alpha - one per layer.

There are two ways of expressing alpha in an image:

Straight alpha is an alpha channel which functions just like RGB. Alpha acts as a fourth channel of information per pixel which is as independent of the other three as R, G and B are of each other. For example, with straight alpha it is possible to have RGB = 255 (white) and alpha = 0 (fully transparent) on the same pixel. Internally generated content, such as gradient layer, are generated with straight alpha. This is the preferable style of alpha and considering the cleaner method of the two.

Premultiplied alpha takes the alpha and applies it to the values of the RGB channels per pixel. The more transparent something gets with premultiplied alpha, the closer it gets to black - as if the content is sitting on a black table. Premultiplied is the default output of Adobe Photoshop or AfterEffects. the result is our pixel at 255 RGB (full white) with 0 alpha would be calculated as a black pixel in the final image.

Here are explanations of what each individual blend mode will do.

## Over

Makes a layer fully opaque. Premultiplies all alpha onto the RGB value of each pixel. Alpha = black, so adjusting the brightness of a layer in Over blend mode makes it darker.

## Alpha

Default blend mode. It will apply alpha values as a transparency if the alpha is present. Brightness changes will make the layer more or less transparent.

## Add

Adds the value of each RGB pixel together. Always creates a brighter result. Values clamp at 255.

## Multiply

Reads the level of each subpixel as a level between 0.0 and 1.0, and multiplies source with blend. The result is always a darker image overall. For example: white x grey = 0.5. White turns transparent, black takes precedence. Alpha is applied in the same fashion as the Over Blend mode.

## Mask

Choose mask when you want to multiple out content upwards in the stack of layers, rather than downwards. In order to make this work you have to use the same mapping on the layer set to mask and the layer on top.

## Multiply-Fade

The same as Multiply, but will make use of the alpha channel to calculate transparency in the source and blend layers. Since maximum transparency is premultiplied, alpha results in black. This will ignore black created through premultiplying.

## Multiply-Alpha

Multiply with straight alpha. This mode assumes that the alpha has not been premultiplied onto the RGB values and will not apply a correction to the semi-transparent pixels.

## Premultiply Alpha

Like how Multiply-fade will ignore the darkening caused by premultiplying, this blend mode will do the same with Alpha.

## Colour Burn

Blend mode increases the contrast to darken the base colour while reflecting the blend colour. The darker the blend colour, the more intensely the colour will be applied in the base image. White as the blend colour produces no change. Using the colour burn blend mode can produce some harsh results at full opacity.

The colour burn blend mode can be used to make tonal and colour adjustments to a layer.

## Screen

This blend mode looks at each channels colour information and multiplies the inverse of the blend and base colour. The result is always a lighter colour. Screening with black leaves the colour unchanged. Screening with white produces white. The effect is similar to projecting multiple images on top of each other - where bright white is fully opaque, black is fully transparent and 50% grey is 50% transparent.

## Overlay

Multiplies or screens the colours, depending on the base colour. Patterns or colours overlay the existing pixels while preserving the highlights and shadows of the base colour. The base colour is not replaced, but mixed with the blend colour to reflect the lightness or darkness of the original colour.

## Hard Light

Multiplies or screens the colours, depending on the blend colour. The effect is similar to shining a harsh spotlight on the image. If the blend colour (light source/top layer) is lighter than 50% grey, the image is lightened as if it were screened. This is useful for adding highlights to an image. If the blend colour is darker than 50% grey, the image is darkened as if it were multiplied. This is useful for adding shadows to an image. Painting with pure black or white results in pure black or white.

## Soft Light

Darkens or lightens the colours, depending on the blend colour. The effect is similar to shining a diffused spotlight on the image. If the blend colour (light source/top layer) is lighter than 50% grey, the image is lightened as if it were dodged. If the blend colour is darker than 50% grey, the image is darkened as if it were burned in. Painting with pure black or white produces a distinctly darker or lighter area, but does not result in pure black or white.

## Darken

Looks at the colour information in each channel and selects the base or blend colour - whichever is darker - as the result colour. Pixels lighter than the blend colour are replaced and pixels darker than the blend colour do not change.

## Lighten

Looks at the colour information in each channel and selects the base or blend colour - whichever is lighter - as the result colour. Pixels darker than the blend colour are replaced and pixels lighter than the blend colour do not change.

## Difference

Looks at the colour information in each channel and subtracts either the blend colour from the base colour or the base colour from the blend colour depending on which has the greater brightness value.

Blending with white inverts the base colour values and blending with black produces no change.

## Exclusion

Creates an effects similar to but lower in contrast than the difference mode. Blending with white inverts the base colour values. Blending with black produces no change.

## Colour Dodge

Looks at the colour information in each channel and brightens the base colour to reflect the blend colour by decreasing contrast between the two. Blending with black produces no change.

## Hard Mix

Adds the RGB channels of the blend colour to the RGB values of the base colour. If the resulting sum for a channel is 255 or greater, it receives a value of 255; if it is less than 255 it receives a value of 0. Therefore all blended pixels have RGB channels of either 0 or 255. This changes all pixels to primary additive colours (RGB), white or black.

## Brightness

This property (which appears as a light bulb icon) controls the brightness of the layer output.

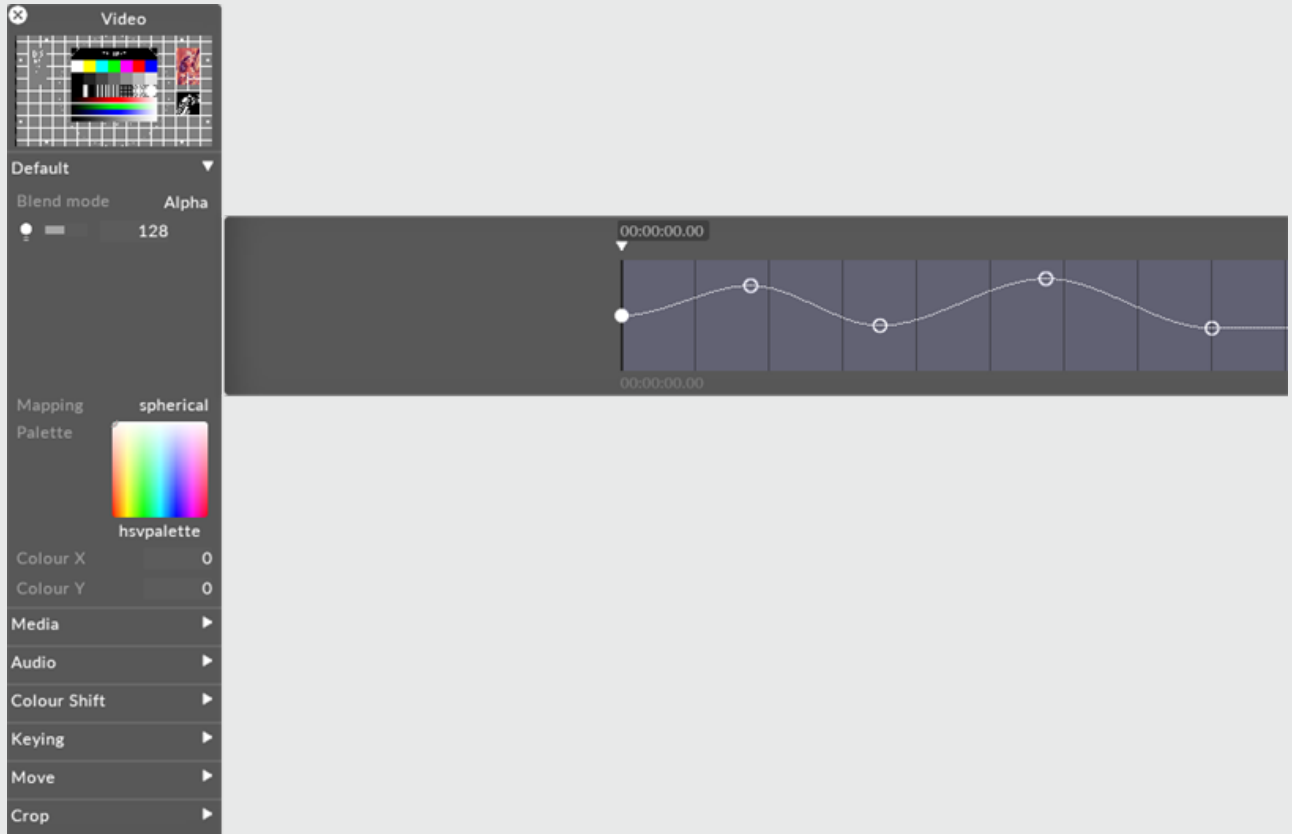

If the layers blend mode is set to Alpha, then reducing the brightness to 0 also reduces the opacity of the layer to 0. This can be useful when you want to dissolve from one layer to the next. In that case, you can place the new layer above the old layer and increase its brightness level.

## Mapping

The mapping property controls how the layer output is mapped onto the screen(s) in the Stage level.

**Video**

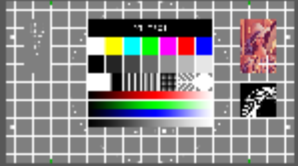

Default ▾

Blend mode Alpha

128

Mapping direct map 1

Palette



hsvpalette

Colour X 0

Colour Y 0

Media ▾

Video



d3\_test\_16-9.png

Speed 1

Mode Normal

At end point Loop

Transition time 0

Audio ▶

Colour Shift ▶

Keying ▶

Move ▶

Crop ▶

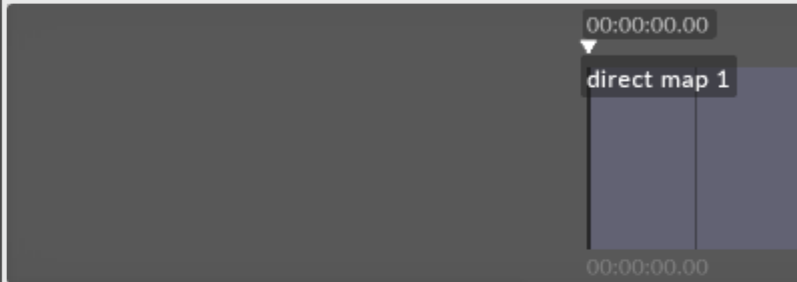

**mappings**

New mapping: OK Search:

all New Mappings

- direct map 1
- feed map 2
- feed mapping
- mapping 1
- mapping 2
- parallel
- spherical



For information on mapping, including how to use the different mapping types offered by Disguise software, please see the chapter [Content Mapping](#).

## Palette

This points to the still image file that defines the bitmap from which the tint colour is taken. The default palette ( HSVPAL ) consists of the complete range of hues and saturations. Selecting this property will open the Texture object library, which shows all of the still image files saved on your local hard-drive in the **DxTexture** folder.

To control the location within the current palette bitmap, and thus control the colour, you have to edit the **xCol** and **yCol** values (see the section for xCol, yCol).

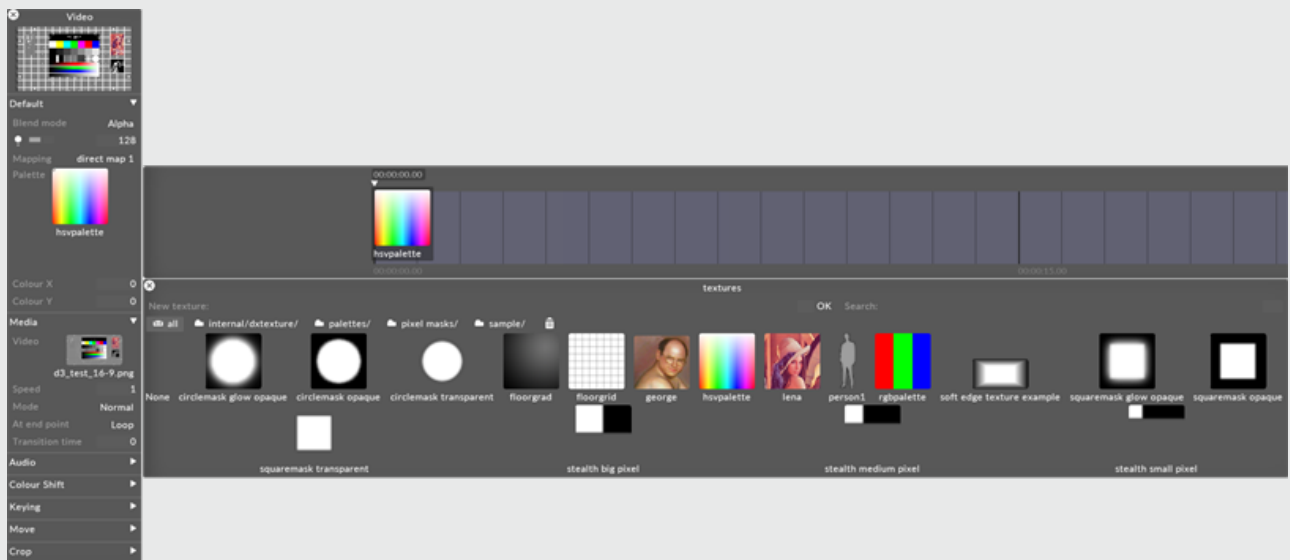

To change the current palette bitmap:

1. Left-click **palette** to open the Texture object library.
2. Left-click the still image file you want to use for the palette bitmap.

If you want to use a palette bitmap other than the standard still images provided in Disguise software, you will need to use a custom still image file.

See the [Placing media files for a project](#) sub-chapter to understand where to place a custom still image file and how to access it in Disguise software. Also save the file to a [supported file format](#).

## xCol, yCol

These properties control the coordinates within the current palette bitmap where the output colour is sampled from. The default value is 0,0 which points at the color white (if you are using the HSVPAL palette). Multiplying white with the colors of the chosen content simply generates the original content colors. **Colour X** controls the horizontal position, where 0 is the leftmost edge and 255 is the rightmost edge. **Colour Y** controls the vertical position, where 0 is the top edge and 255 is the bottom edge.

For example, to saturate the video clip red, change the **Colour Y** value to 255 and use 0 for the **Colour X** value. These coordinates refer to the color red in the palette which is being multiplied with the colors of the existing content.

When you are using the default palette HSVPAL , **Colour Y** controls saturation, and **Colour X** controls hue.

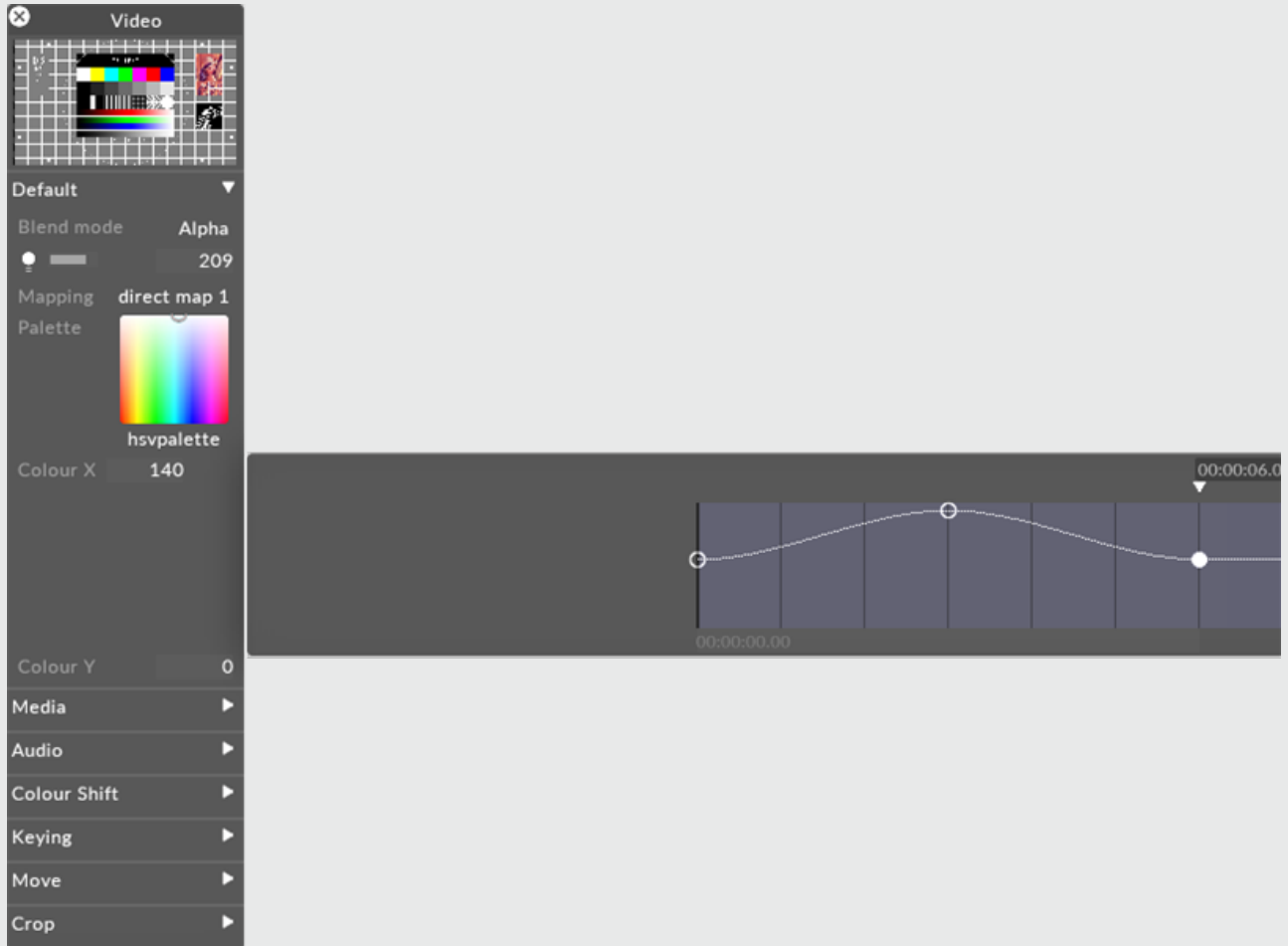

## Colour Shift

The colour shift property allows you to perform a number of colour-correction operations on the output of a layer.

Colour Shift objects can also be attached to individual video files within the Video layer.

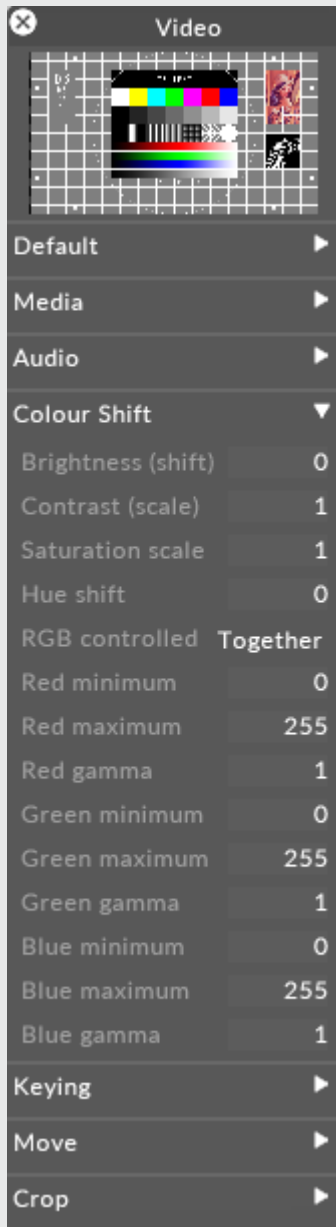

Colour Shift property performs colour-corrections on the output of a visual layer

Colour Shift properties are:

# Saturation scale

When set to 1, no change is applied to the image. When set to 0, the image is desaturated to black and white. When set higher than 1, the image is hypersaturated.

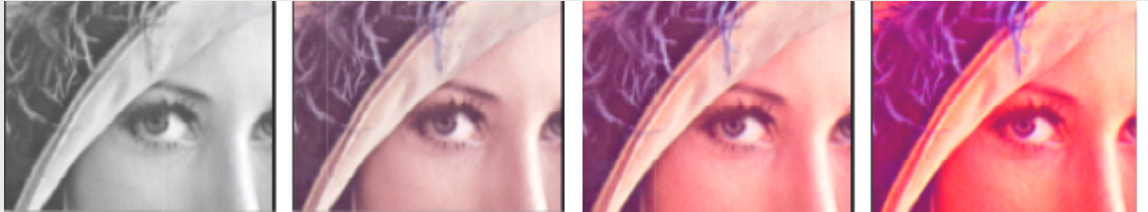

Saturation scale (from left to right):  $s=0$ ,  $s=0.5$ ,  $s=1$ ,  $s=2$

# Hue shift

## RGB controlled

This property controls how the min/max levels and gamma corrections are applied. If set to *together*, then the min, max and gamma values are the same for the red, green and blue channels. If set to *separate*, the min,max and gamma values can be controlled separately for red, green and blue. The latter setting allows you to apply fine colour balance controls to the image.

## Min

This sets the lowest brightness level found in the image. All pixels at this level are scaled down to zero brightness. Increasing this value enforces shadows and dark levels in the image and can be used to reduce low-level compression artifacts in an image or video frame.

Increasing *min* equally across red, green and blue enforces shadows, whereas increasing *min* on an individual channel has the effect of shifting the colour balance away from that colour. For example, increasing *red min* shifts the image towards cyan.

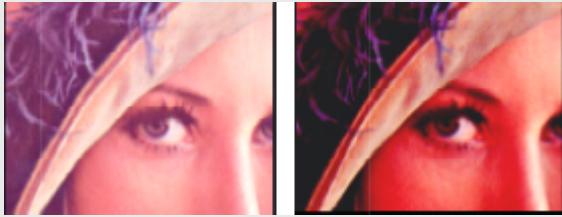

min = 00 (left), min = 96 (right)

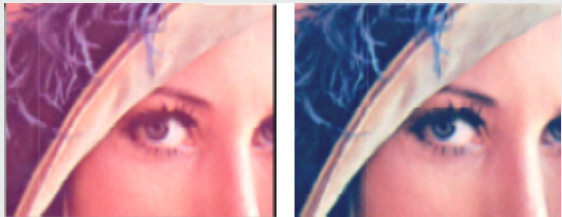

red.min = 0 (left), red.min = 96 (right)

## Max

This sets the highest brightness level found in the image. All pixels at this level are scaled up to the maximum level, i.e. 255. Decreasing this value brightens any highlights in the image. This is useful when the source image is too dark.

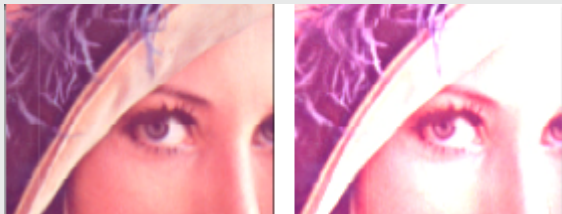

max = 255 (left), max = 260 (right)

If you set min to 255 and max to 0, the image (or single channel) will be inverted.

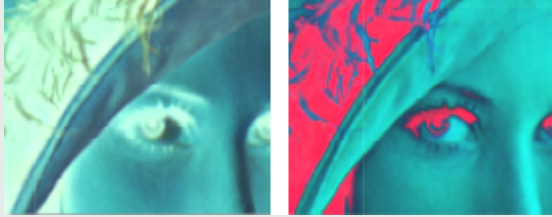

Invert all (left), invert red (right)

## Gamma

When *gamma* is set to 1, no change is made to the image. Reducing gamma brightens highlights while increasing gamma darkens lowlights. The maximum and minimum brightness levels remain the same.

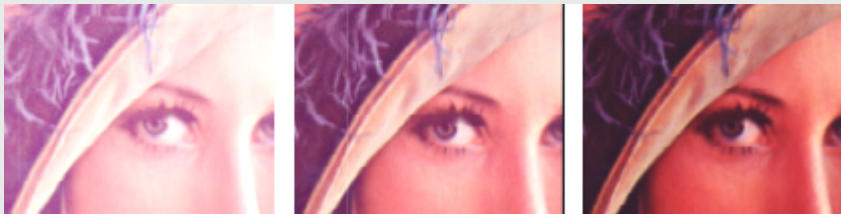

Gamma scale (from left to right):  $g=0.5$ ,  $g=1$ ,  $g=1.5$

## Size

The size of each pixel.

## Mask

Optional bitmap to mask the pixelate effect.

# PixelMap

The PixelMap layer allows for a pixelmap input to be used to create a pixelating effect. The pixel map can be created from an external program, for example Photoshop, allowing you to create and customise your own pixel maps.

The **Pixelmap** Effect layer is used to create a pixelating effect that is based on the input of a pixelmap . The pixelmap determines the tile atlas for the max value of each pixelated pixel which is fixed to a 16 x 16 grid.

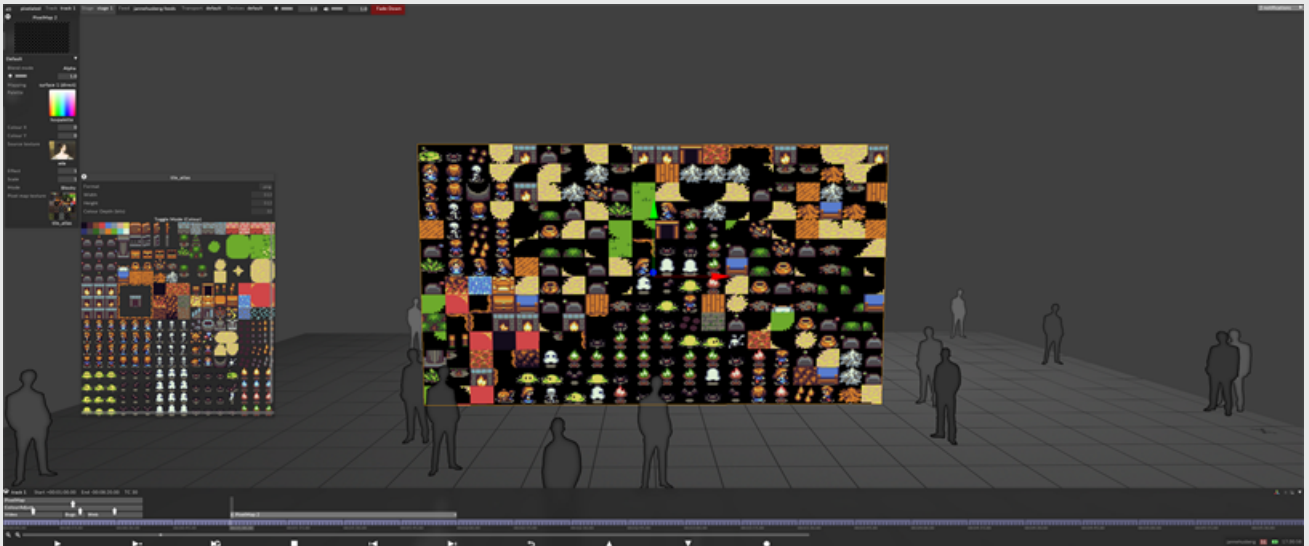

pixel atlas

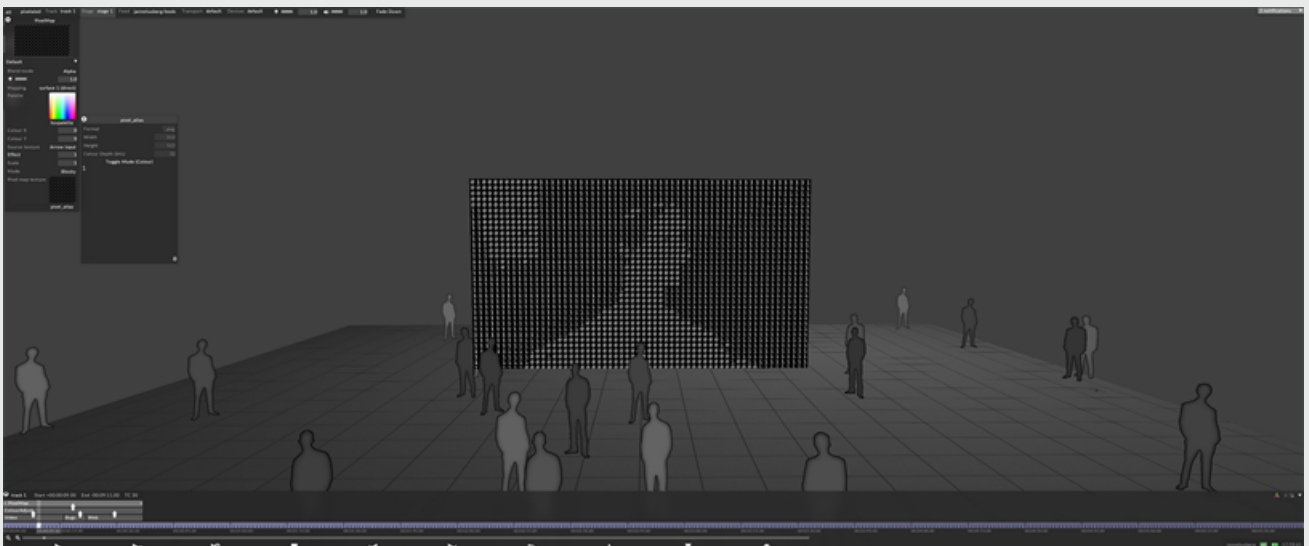

tile atlas



All Effect layers take their source from other layer types - either content or generative - by use of an arrow. Linking two layers with an arrow defines the arrowed from layer as the source, and the arrowed to layer as the destination. If you have an arrow between a content layer and effect layer, it is said that the content layer is being 'piped in' to the effect layer. For more information on arrows, see the [compositing layers](#) topic.

To draw an arrow between two layers, hold down **ALT** and left click & drag between the source and destination layer.

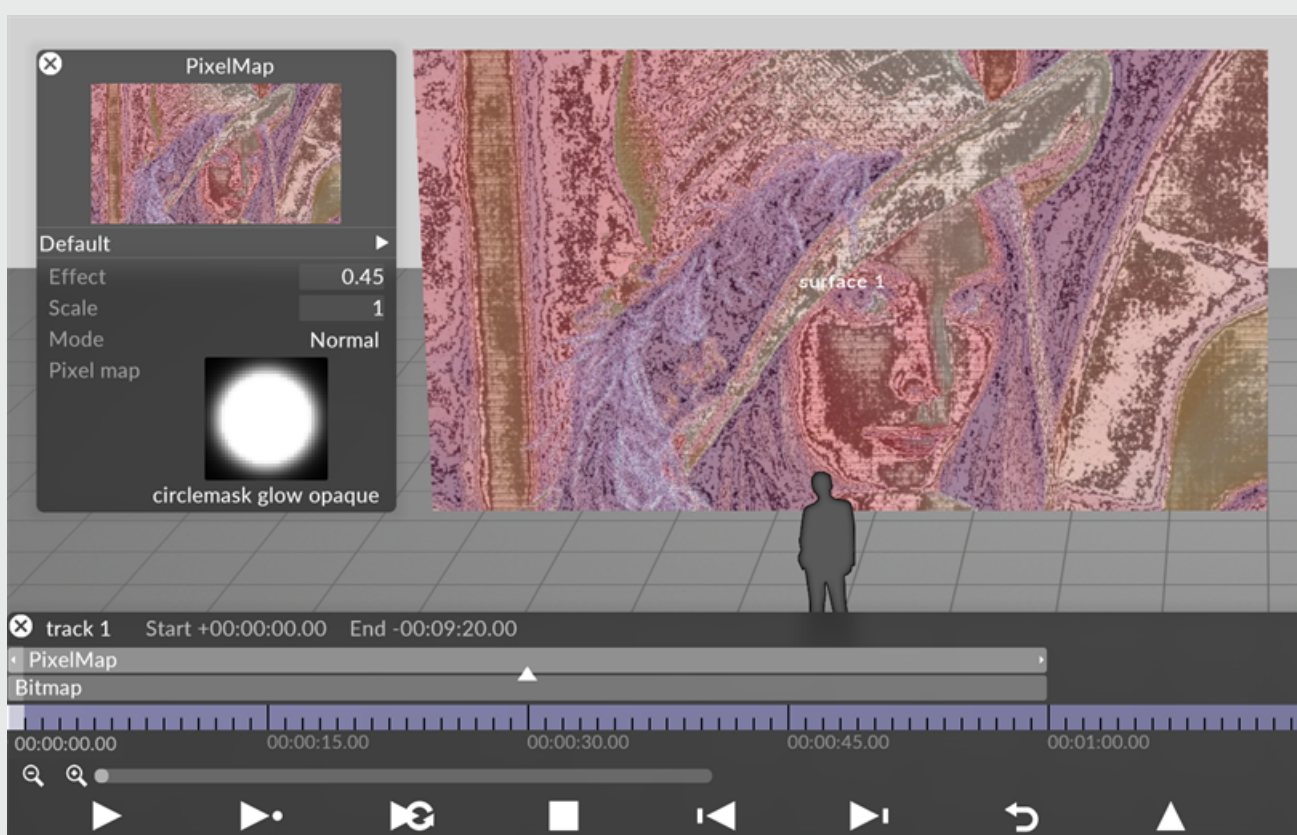

The PixelMap layer supports the use of Arrows, allowing content layers to be piped into the PixelMap layer. For more information please see the sub-chapter [Composing layers using Arrows](#).

# Preview Thumbnail

This property is a small preview window at the top of the editor showing you what the layer output looks like.

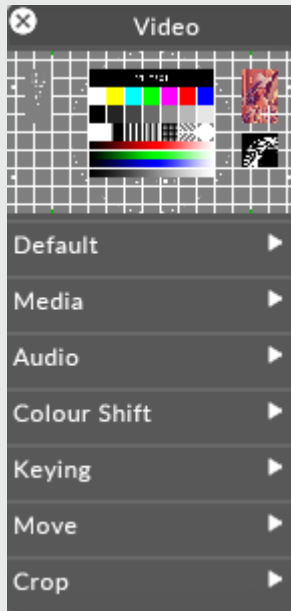

# Blend Mode

BlendMode controls how the output of the layer is composited with the layers below. Layers are rendered in a bottom-up order: layers at the top can modify the output of the layers below.

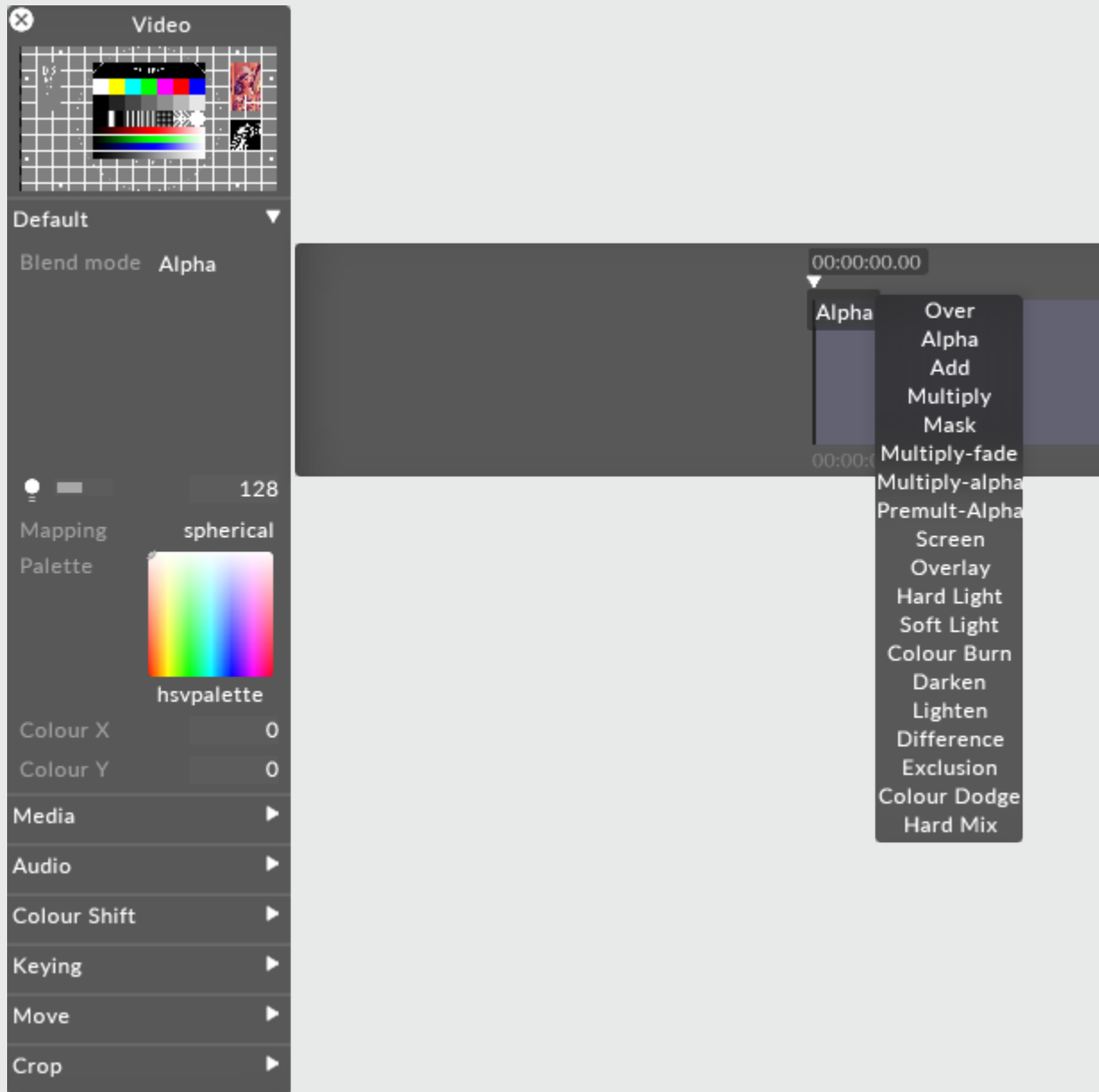

Changing brightness of a content layer in Disguise software is actually controlling the value of the alpha of the layer. Even when displaying a HAP video, the software will composite the layer with a controllable layer of alpha - one per layer.

There are two ways of expressing alpha in an image:

Straight alpha is an alpha channel which functions just like RGB. Alpha acts as a fourth channel of information per pixel which is as independent of the other three as R, G and B are of each other. For example, with straight alpha it is possible to have RGB = 255 (white) and alpha = 0 (fully transparent) on the same pixel. Internally generated content, such as gradient layer, are generated with straight alpha. This is the preferable style of alpha and considering the cleaner method of the two.

Premultiplied alpha takes the alpha and applies it to the values of the RGB channels per pixel. The more transparent something gets with premultiplied alpha, the closer it gets to black - as if the content is sitting on a black table. Premultiplied is the default output of Adobe Photoshop or AfterEffects. the result is our pixel at 255 RGB (full white) with 0 alpha would be calculated as a black pixel in the final image.

Here are explanations of what each individual blend mode will do.

## Over

Makes a layer fully opaque. Premultiplies all alpha onto the RGB value of each pixel. Alpha = black, so adjusting the brightness of a layer in Over blend mode makes it darker.

## Alpha

Default blend mode. It will apply alpha values as a transparency if the alpha is present. Brightness changes will make the layer more or less transparent.

## Add

Adds the value of each RGB pixel together. Always creates a brighter result. Values clamp at 255.

## Multiply

Reads the level of each subpixel as a level between 0.0 and 1.0, and multiplies source with blend. The result is always a darker image overall. For example: white x grey = 0.5. White turns transparent, black takes precedence. Alpha is applied in the same fashion as the Over Blend mode.

## Mask

Choose mask when you want to multiple out content upwards in the stack of layers, rather than downwards. In order to make this work you have to use the same mapping on the layer set to mask and the layer on top.

## Multiply-Fade

The same as Multiply, but will make use of the alpha channel to calculate transparency in the source and blend layers. Since maximum transparency is premultiplied, alpha results in black. This will ignore black created through premultiplying.

## Multiply-Alpha

Multiply with straight alpha. This mode assumes that the alpha has not been premultiplied onto the RGB values and will not apply a correction to the semi-transparent pixels.

## Premultiply Alpha

Like how Multiply-fade will ignore the darkening caused by premultiplying, this blend mode will do the same with Alpha.

## Colour Burn

Blend mode increases the contrast to darken the base colour while reflecting the blend colour. The darker the blend colour, the more intensely the colour will be applied in the base image. White as the blend colour produces no change. Using the colour burn blend mode can produce some harsh results at full opacity.

The colour burn blend mode can be used to make tonal and colour adjustments to a layer.

## Screen

This blend mode looks at each channels colour information and multiplies the inverse of the blend and base colour. The result is always a lighter colour. Screening with black leaves the colour unchanged. Screening with white produces white. The effect is similar to projecting multiple images on top of each other - where bright white is fully opaque, black is fully transparent and 50% grey is 50% transparent.

## Overlay

Multiplies or screens the colours, depending on the base colour. Patterns or colours overlay the existing pixels while preserving the highlights and shadows of the base colour. The base colour is not replaced, but mixed with the blend colour to reflect the lightness or darkness of the original colour.

## Hard Light

Multiplies or screens the colours, depending on the blend colour. The effect is similar to shining a harsh spotlight on the image. If the blend colour (light source/top layer) is lighter than 50% grey, the image is lightened as if it were screened. This is useful for adding highlights to an image. If the blend colour is darker than 50% grey, the image is darkened as if it were multiplied. This is useful for adding shadows to an image. Painting with pure black or white results in pure black or white.

## Soft Light

Darkens or lightens the colours, depending on the blend colour. The effect is similar to shining a diffused spotlight on the image. If the blend colour (light source/top layer) is lighter than 50% grey, the image is lightened as if it were dodged. If the blend colour is darker than 50% grey, the image is darkened as if it were burned in. Painting with pure black or white produces a distinctly darker or lighter area, but does not result in pure black or white.

## Darken

Looks at the colour information in each channel and selects the base or blend colour - whichever is darker - as the result colour. Pixels lighter than the blend colour are replaced and pixels darker than the blend colour do not change.

## Lighten

Looks at the colour information in each channel and selects the base or blend colour - whichever is lighter - as the result colour. Pixels darker than the blend colour are replaced and pixels lighter than the blend colour do not change.

## Difference

Looks at the colour information in each channel and subtracts either the blend colour from the base colour or the base colour from the blend colour depending on which has the greater brightness value.

Blending with white inverts the base colour values and blending with black produces no change.

## Exclusion

Creates an effects similar to but lower in contrast than the difference mode. Blending with white inverts the base colour values. Blending with black produces no change.

## Colour Dodge

Looks at the colour information in each channel and brightens the base colour to reflect the blend colour by decreasing contrast between the two. Blending with black produces no change.

## Hard Mix

Adds the RGB channels of the blend colour to the RGB values of the base colour. If the resulting sum for a channel is 255 or greater, it receives a value of 255; if it is less than 255 it receives a value of 0. Therefore all blended pixels have RGB channels of either 0 or 255. This changes all pixels to primary additive colours (RGB), white or black.

## Brightness

This property (which appears as a light bulb icon) controls the brightness of the layer output.

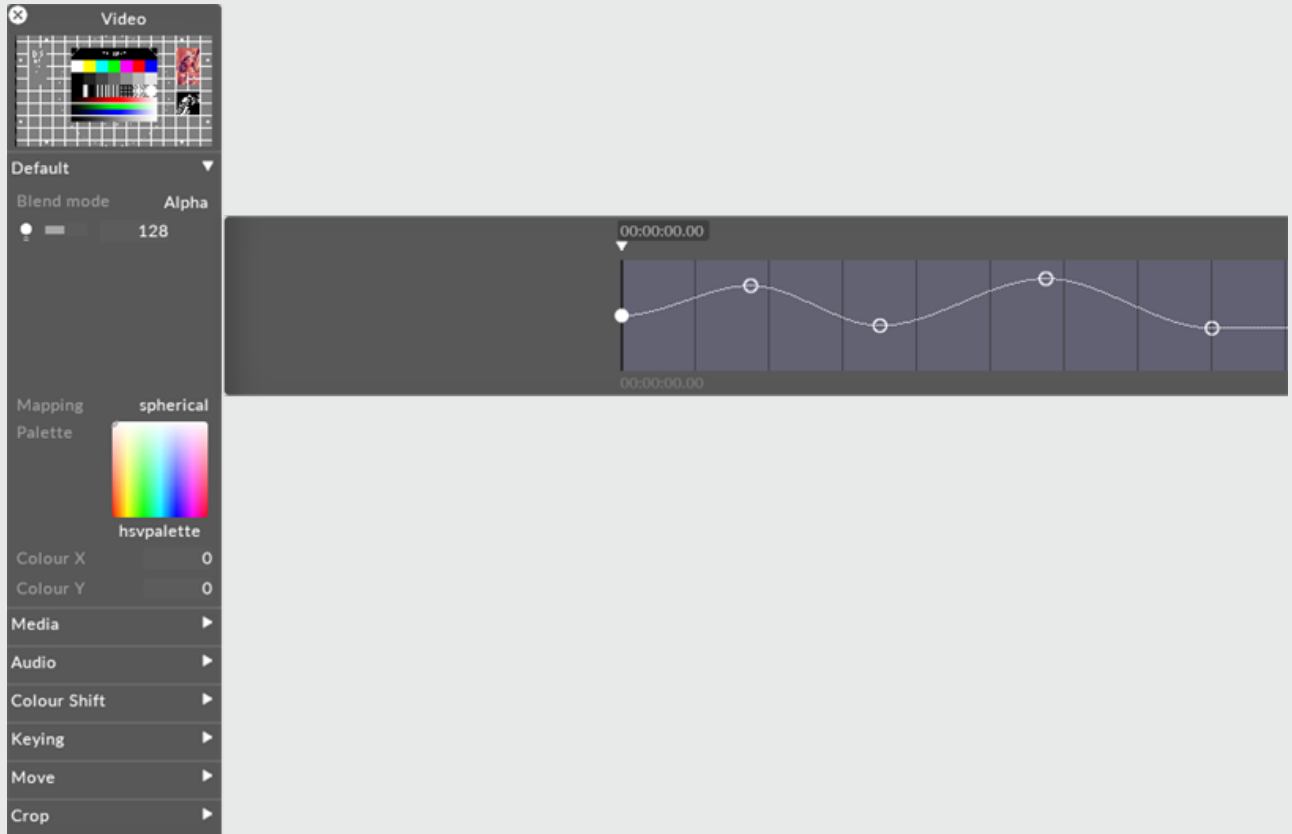

If the layers blend mode is set to Alpha, then reducing the brightness to 0 also reduces the opacity of the layer to 0. This can be useful when you want to dissolve from one layer to the next. In that case, you can place the new layer above the old layer and increase its brightness level.

## Mapping

The mapping property controls how the layer output is mapped onto the screen(s) in the Stage level.



**Video**

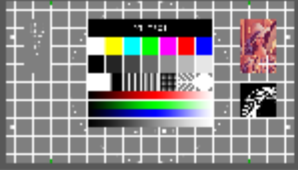

Default ▾

Blend mode Alpha

128

Mapping direct map 1

Palette



hsvpalette

Colour X 0

Colour Y 0

Media ▾

Video



d3\_test\_16-9.png

Speed 1

Mode Normal

At end point Loop

Transition time 0

Audio ▶

Colour Shift ▶

Keying ▶

Move ▶

Crop ▶

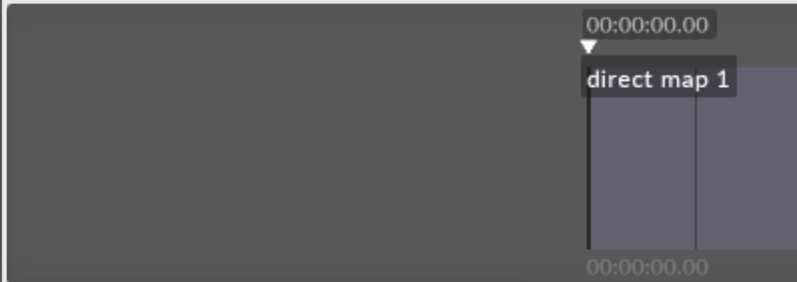

00:00:00.00

direct map 1

00:00:00.00

**mappings**

New mapping: OK Search:

all New Mappings

- direct map 1
- feed map 2
- feed mapping
- mapping 1
- mapping 2
- parallel
- spherical

For information on mapping, including how to use the different mapping types offered by Disguise software, please see the chapter [Content Mapping](#).

## Palette

This points to the still image file that defines the bitmap from which the tint colour is taken. The default palette ( HSVPAL ) consists of the complete range of hues and saturations. Selecting this property will open the Texture object library, which shows all of the still image files saved on your local hard-drive in the **DxTexture** folder.

To control the location within the current palette bitmap, and thus control the colour, you have to edit the **xCol** and **yCol** values (see the section for xCol, yCol).

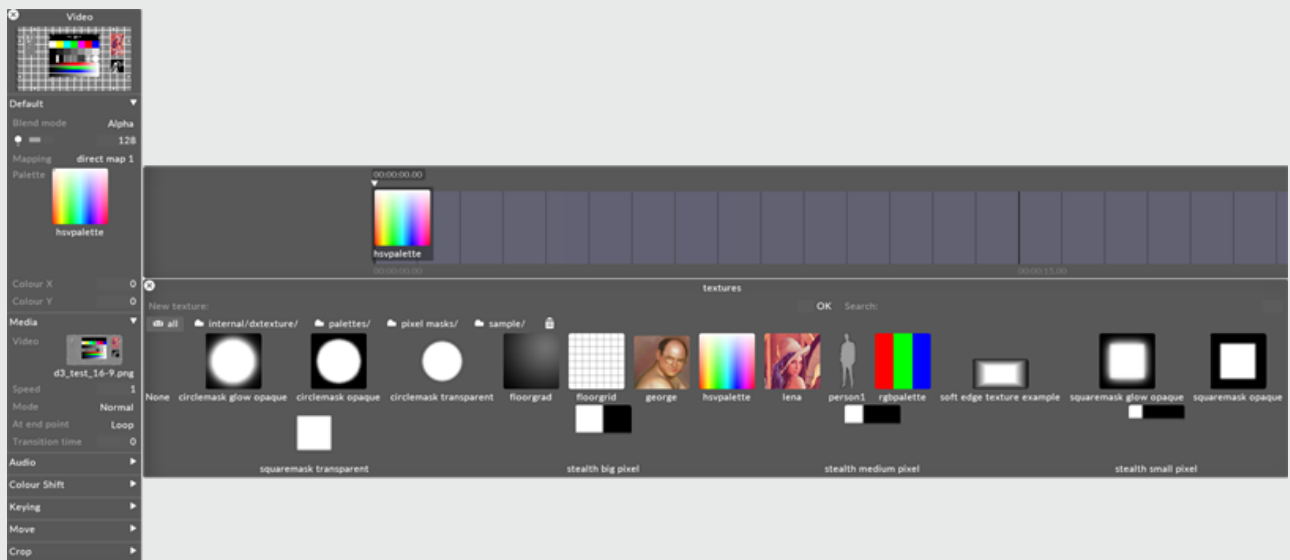

To change the current palette bitmap:

1. Left-click **palette** to open the Texture object library.
2. Left-click the still image file you want to use for the palette bitmap.

If you want to use a palette bitmap other than the standard still images provided in Disguise software, you will need to use a custom still image file.

See the [Placing media files for a project](#) sub-chapter to understand where to place a custom still image file and how to access it in Disguise software. Also save the file to a [supported file format](#).

## xCol yCol

These properties control the coordinates within the current palette bitmap where the output colour is sampled from. The default value is 0,0 which points at the color white (if you are using the HSVPAL palette). Multiplying white with the colors of the chosen content simply generates the original content colors. **Colour X** controls the horizontal position, where 0 is the leftmost edge and 255 is the rightmost edge. **Colour Y** controls the vertical position, where 0 is the top edge and 255 is the bottom edge.

For example, to saturate the video clip red, change the **Colour Y** value to 255 and use 0 for the **Colour X** value. These coordinates refer to the color red in the palette which is being multiplied with the colors of the existing content.

When you are using the default palette HSVPAL , **Colour Y** controls saturation, and **Colour X** controls hue.

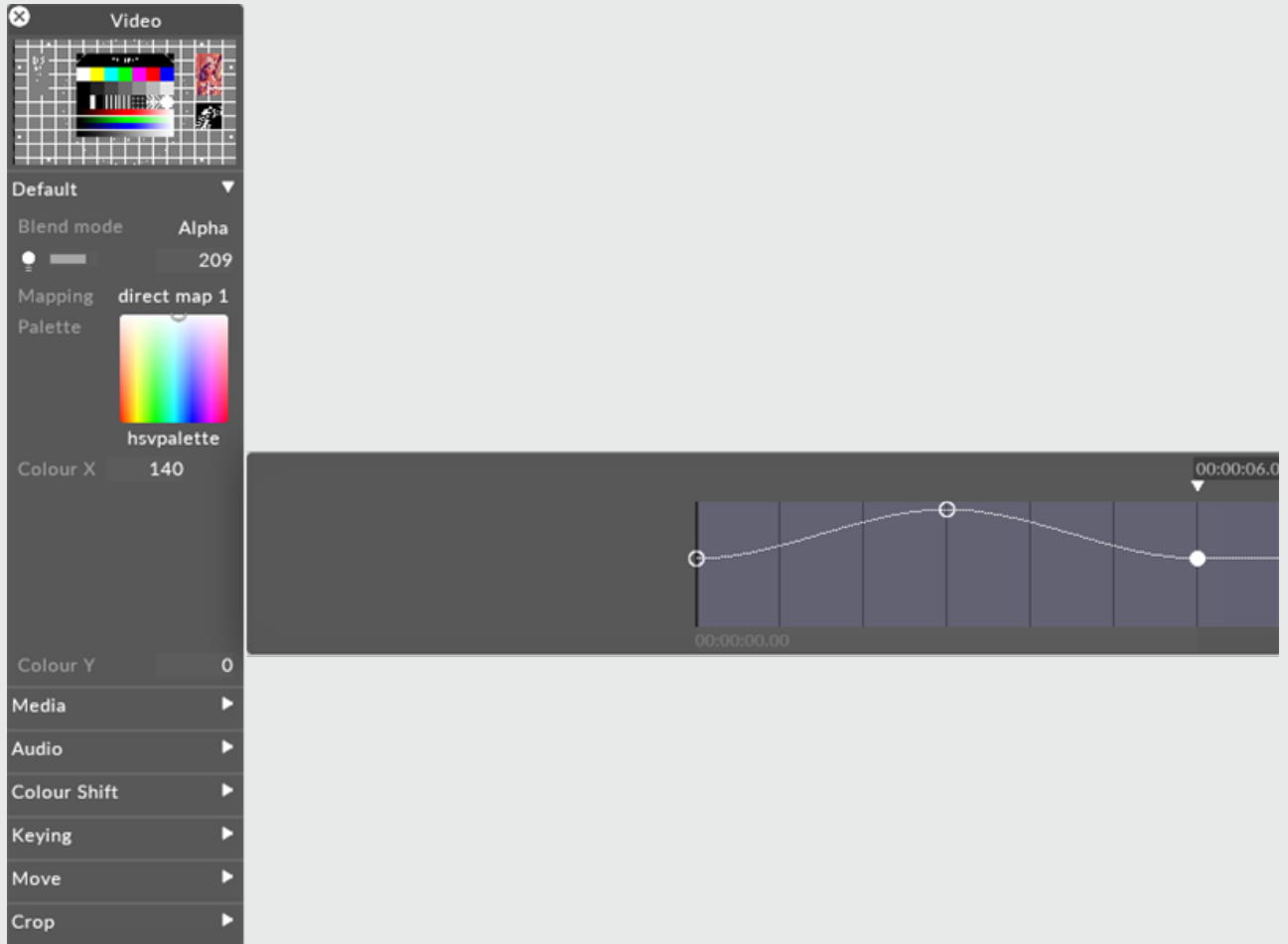

## Effect

Default value is 1. The min/max values are 0 (no effect) and 1 (maximum effect). Decreasing the value from 1 to 0 will reduce the effect of the Pixel map on the content.

# Scale

Default value is 1. The min/max values are 1 and 16. Increasing the value from 1 to 16 will increase the size of the Pixel map by a specific scale factor. For example, a value of two means the PixelMaps width and height will double, a value of three means the Pixel maps width and height will triple etc.

# Mode

**Normal**

**Blocky**

# Pixel map

This points to the still image file that defines the PixelMap. Selecting this property will open the Texture object library, which shows all of the Texture still image files saved on your local hard-drive in the **DxTexture** folder. However, before placing a Pixel map you will need to create it.

To create a Pixel map:

1. Create a **.png** image using a program such as Adobe Photoshop. The Pixel map can only be increased by a maximum scale factor of sixteen so if it is going to be applied to the whole screen make sure the Pixel maps resolution is high enough.
2. Make the areas to be see-through in the screen see-through in the Pixel map.
3. Make the areas to be illuminating in the screen white in the Pixel map.
4. Make the areas to be black in the screen black in the Pixel map.

See the [Placing media files for a project](#) sub-chapter to understand where to place a custom still image file and how to access it in Disguise software Also save the file to a [supported file format](#).

The Pixel map will be applied to the screen on a pixel by pixel basis.

# Scroll

The Scroll layer takes any bitmap and scrolls it in a horizontal direction across the output canvas, repeating it when necessary. It is particularly useful in situations where you want to generate scrolling content and want to modulate the scrolling speed in real time (for instance, so that content moves at the right speed for television cameras). In these situations, the process of making a video containing scrolling content is too slow.

All Effect layers take their source from other layer types - either content or generative - by use of an arrow. Linking two layers with an arrow defines the arrowed from layer as the source, and the arrowed to layer as the destination. If you have an arrow between a content layer and effect layer, it is said that the content layer is being 'piped in' to the effect layer. For more information on arrows, see the [compositing layers topic](#).

To draw an arrow between two layers, hold down **ALT** and left click & drag between the source and destination layer.



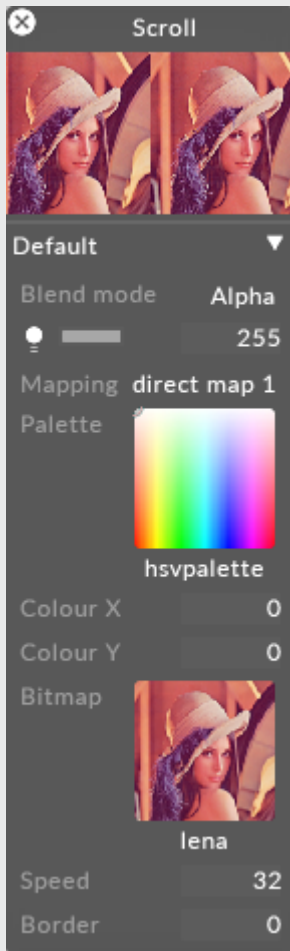

## Blend Mode

BlendMode controls how the output of the layer is composited with the layers below. Layers are rendered in a bottom-up order: layers at the top can modify the output of the layers below.

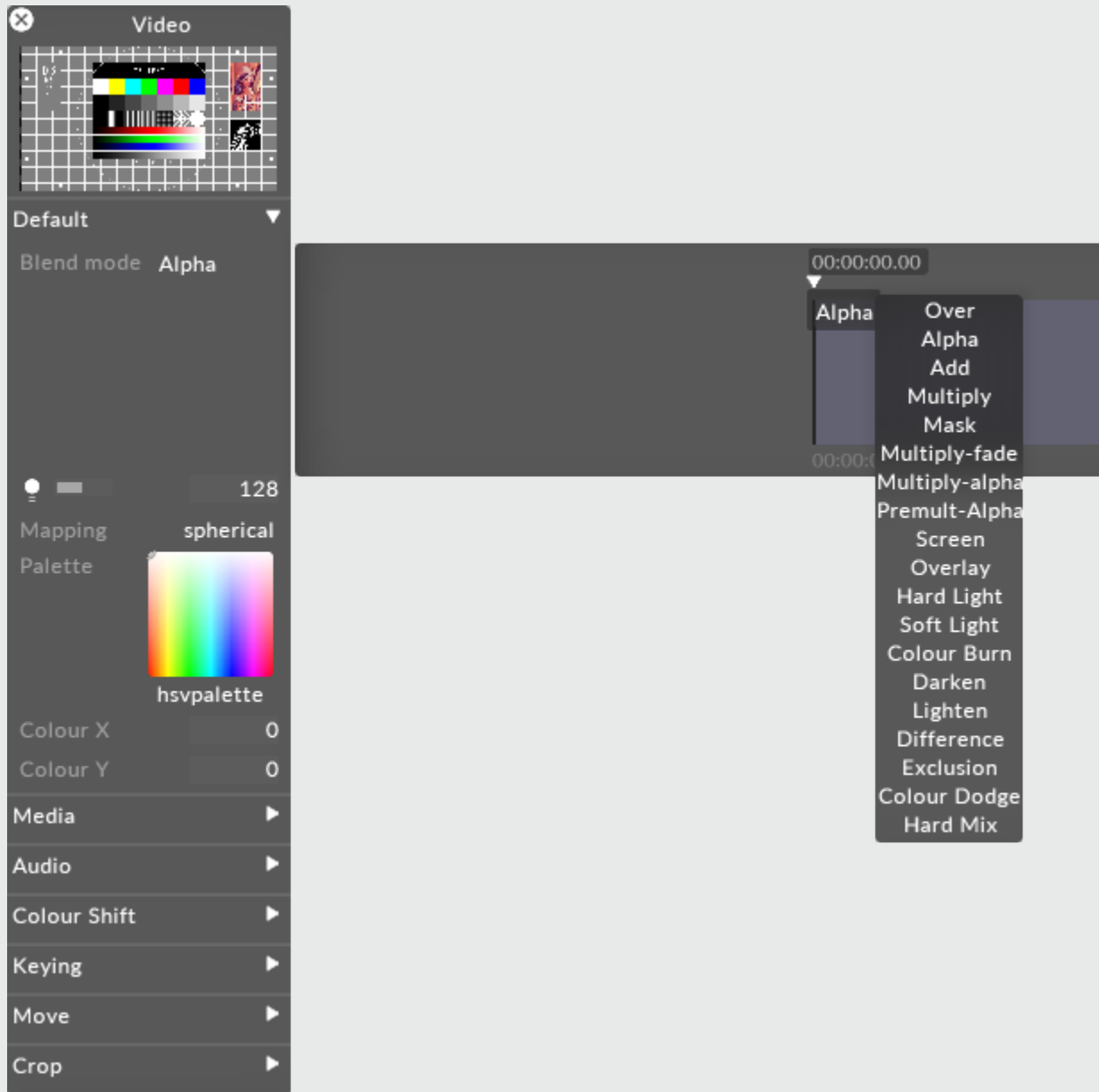

Changing brightness of a content layer in Disguise software is actually controlling the value of the alpha of the layer. Even when displaying a HAP video, the software will composite the layer with a controllable layer of alpha - one per layer.



There are two ways of expressing alpha in an image:

Straight alpha is an alpha channel which functions just like RGB. Alpha acts as a fourth channel of information per pixel which is as independent of the other three as R, G and B are of each other. For example, with straight alpha it is possible to have RGB = 255 (white) and alpha = 0 (fully transparent) on the same pixel. Internally generated content, such as gradient layer, are generated with straight alpha. This is the preferable style of alpha and considering the cleaner method of the two.

Premultiplied alpha takes the alpha and applies it to the values of the RGB channels per pixel. The more transparent something gets with premultiplied alpha, the closer it gets to black - as if the content is sitting on a black table. Premultiplied is the default output of Adobe Photoshop or AfterEffects. The result is our pixel at 255 RGB (full white) with 0 alpha would be calculated as a black pixel in the final image.

Here are explanations of what each individual blend mode will do.

## Over

Makes a layer fully opaque. Premultiplies all alpha onto the RGB value of each pixel. Alpha = black, so adjusting the brightness of a layer in Over blend mode makes it darker.

## Alpha

Default blend mode. It will apply alpha values as a transparency if the alpha is present. Brightness changes will make the layer more or less transparent.

## Add

Adds the value of each RGB pixel together. Always creates a brighter result. Values clamp at 255.

## Multiply

Reads the level of each subpixel as a level between 0.0 and 1.0, and multiplies source with blend. The result is always a darker image overall. For example: white x grey = 0.5. White turns transparent, black takes precedence. Alpha is applied in the same fashion as the Over Blend mode.

## Mask

Choose mask when you want to multiple out content upwards in the stack of layers, rather than downwards. In order to make this work you have to use the same mapping on the layer set to mask and the layer on top.

## Multiply-Fade

The same as Multiply, but will make use of the alpha channel to calculate transparency in the source and blend layers. Since maximum transparency is premultiplied, alpha results in black. This will ignore black created through premultiplying.

## Multiply-Alpha

Multiply with straight alpha. This mode assumes that the alpha has not been premultiplied onto the RGB values and will not apply a correction to the semi-transparent pixels.

## Premultiply Alpha

Like how Multiply-fade will ignore the darkening caused by premultiplying, this blend mode will do the same with Alpha.

## Colour Burn

Blend mode increases the contrast to darken the base colour while reflecting the blend colour. The darker the blend colour, the more intensely the colour will be applied in the base image. White as the blend colour produces no change. Using the colour burn blend mode can produce some harsh results at full opacity.

The colour burn blend mode can be used to make tonal and colour adjustments to a layer.

## Screen

This blend mode looks at each channels colour information and multiplies the inverse of the blend and base colour. The result is always a lighter colour. Screening with black leaves the colour unchanged. Screening with white produces white. The effect is similar to projecting multiple images on top of each other - where bright white is fully opaque, black is fully transparent and 50% grey is 50% transparent.

## Overlay

Multiplies or screens the colours, depending on the base colour. Patterns or colours overlay the existing pixels while preserving the highlights and shadows of the base colour. The base colour is not replaced, but mixed with the blend colour to reflect the lightness or darkness of the original colour.

## Hard Light

Multiplies or screens the colours, depending on the blend colour. The effect is similar to shining a harsh spotlight on the image. If the blend colour (light source/top layer) is lighter than 50% grey, the image is lightened as if it were screened. This is useful for adding highlights to an image. If the blend colour is darker than 50% grey, the image is darkened as if it were multiplied. This is useful for adding shadows to an image. Painting with pure black or white results in pure black or white.

## Soft Light

Darkens or lightens the colours, depending on the blend colour. The effect is similar to shining a diffused spotlight on the image. If the blend colour (light source/top layer) is lighter than 50% grey, the image is lightened as if it were dodged. If the blend colour is darker than 50% grey, the image is darkened as if it were burned in. Painting with pure black or white produces a distinctly darker or lighter area, but does not result in pure black or white.

## Darken

Looks at the colour information in each channel and selects the base or blend colour - whichever is darker - as the result colour. Pixels lighter than the blend colour are replaced and pixels darker than the blend colour do not change.

## Lighten

Looks at the colour information in each channel and selects the base or blend colour - whichever is lighter - as the result colour. Pixels darker than the blend colour are replaced and pixels lighter than the blend colour do not change.

## Difference

Looks at the colour information in each channel and subtracts either the blend colour from the base colour or the base colour from the blend colour depending on which has the greater brightness value.

Blending with white inverts the base colour values and blending with black produces no change.

## Exclusion

Creates an effects similar to but lower in contrast than the difference mode. Blending with white inverts the base colour values. Blending with black produces no change.

## Colour Dodge

Looks at the colour information in each channel and brightens the base colour to reflect the blend colour by decreasing contrast between the two. Blending with black produces no change.

## Hard Mix

Adds the RGB channels of the blend colour to the RGB values of the base colour. If the resulting sum for a channel is 255 or greater, it receives a value of 255; if it is less than 255 it receives a value of 0. Therefore all blended pixels have RGB channels of either 0 or 255. This changes all pixels to primary additive colours (RGB), white or black.

## Brightness

This property (which appears as a light bulb icon) controls the brightness of the layer output.

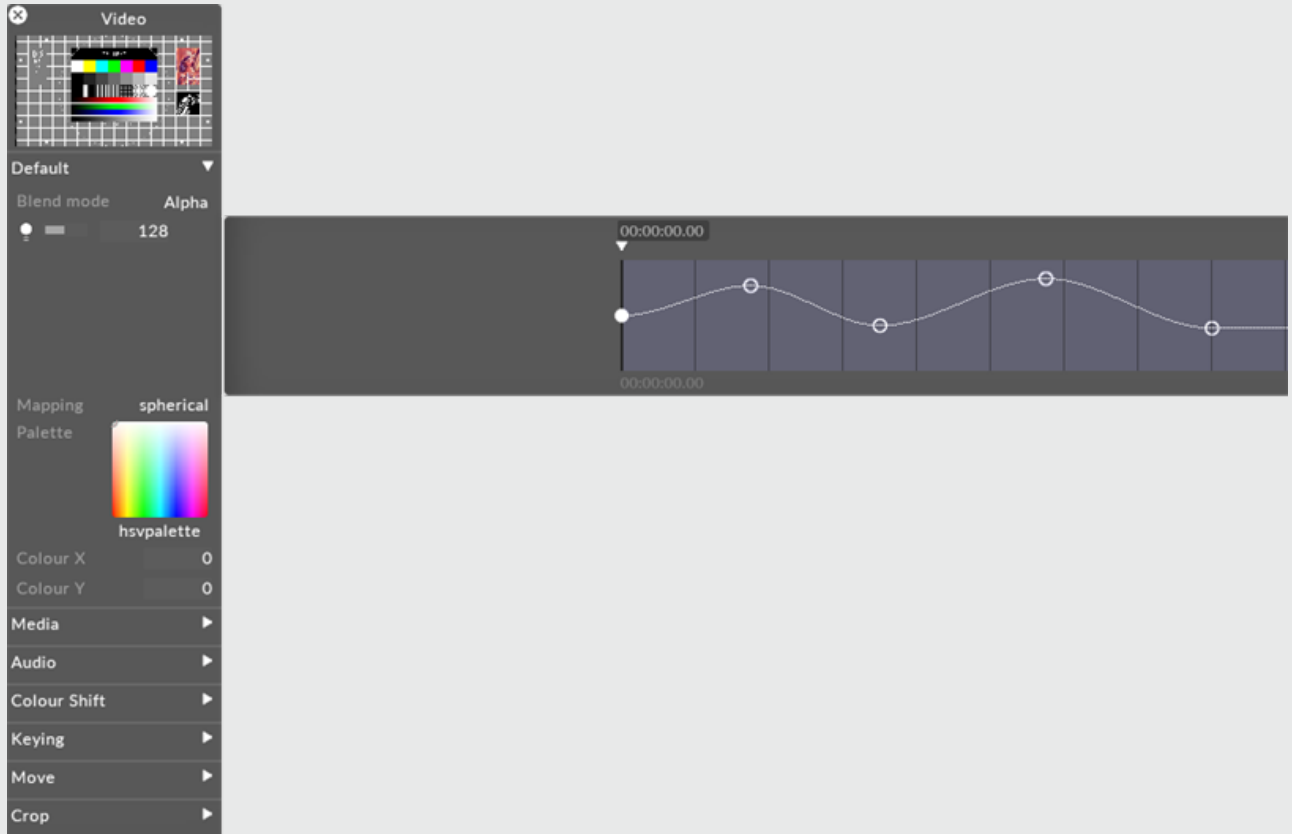

If the layers blend mode is set to Alpha, then reducing the brightness to 0 also reduces the opacity of the layer to 0. This can be useful when you want to dissolve from one layer to the next. In that case, you can place the new layer above the old layer and increase its brightness level.

## Mapping

The mapping property controls how the layer output is mapped onto the screen(s) in the Stage level.

**Video**

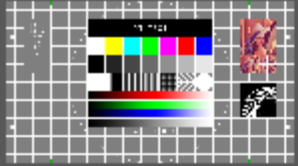

Default ▾

Blend mode Alpha

128

Mapping direct map 1

Palette



hsvpalette

Colour X 0

Colour Y 0

Media ▾

Video



d3\_test\_16-9.png

Speed 1

Mode Normal

At end point Loop

Transition time 0

Audio ▶

Colour Shift ▶

Keying ▶

Move ▶

Crop ▶

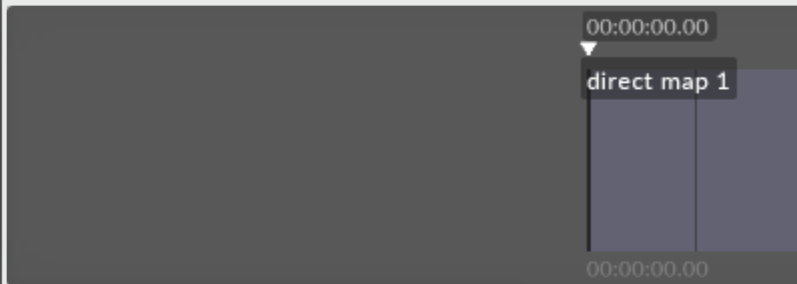

00:00:00.00

direct map 1

00:00:00.00

**mappings**

New mapping: OK Search:

all New Mappings

- direct map 1
- feed map 2
- feed mapping
- mapping 1
- mapping 2
- parallel
- spherical

For information on mapping, including how to use the different mapping types offered by Disguise software, please see the chapter [Content Mapping](#).

## Palette

This points to the still image file that defines the bitmap from which the tint colour is taken. The default palette ( HSVPAL ) consists of the complete range of hues and saturations. Selecting this property will open the Texture object library, which shows all of the still image files saved on your local hard-drive in the **DxTexture** folder.

To control the location within the current palette bitmap, and thus control the colour, you have to edit the **xCol** and **yCol** values (see the section for xCol, yCol).

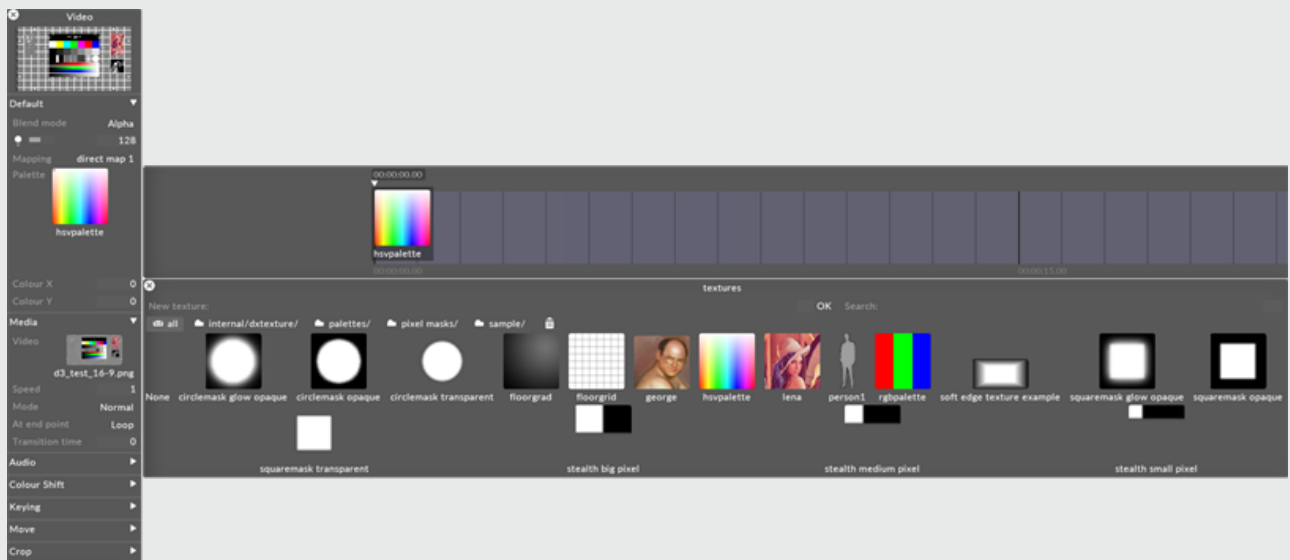

To change the current palette bitmap:

1. Left-click **palette** to open the Texture object library.
2. Left-click the still image file you want to use for the palette bitmap.

If you want to use a palette bitmap other than the standard still images provided in Disguise software, you will need to use a custom still image file.

See the [Placing media files for a project](#) sub-chapter to understand where to place a custom still image file and how to access it in Disguise software. Also save the file to a [supported file format](#).

## xCol yCol

These properties control the coordinates within the current palette bitmap where the output colour is sampled from. The default value is 0,0 which points at the color white (if you are using the HSVPAL palette). Multiplying white with the colors of the chosen content simply generates the original content colors. **Colour X** controls the horizontal position, where 0 is the leftmost edge and 255 is the rightmost edge. **Colour Y** controls the vertical position, where 0 is the top edge and 255 is the bottom edge.

For example, to saturate the video clip red, change the **Colour Y** value to 255 and use 0 for the **Colour X** value. These coordinates refer to the color red in the palette which is being multiplied with the colors of the existing content.

When you are using the default palette HSVPAL , **Colour Y** controls saturation, and **Colour X** controls hue.



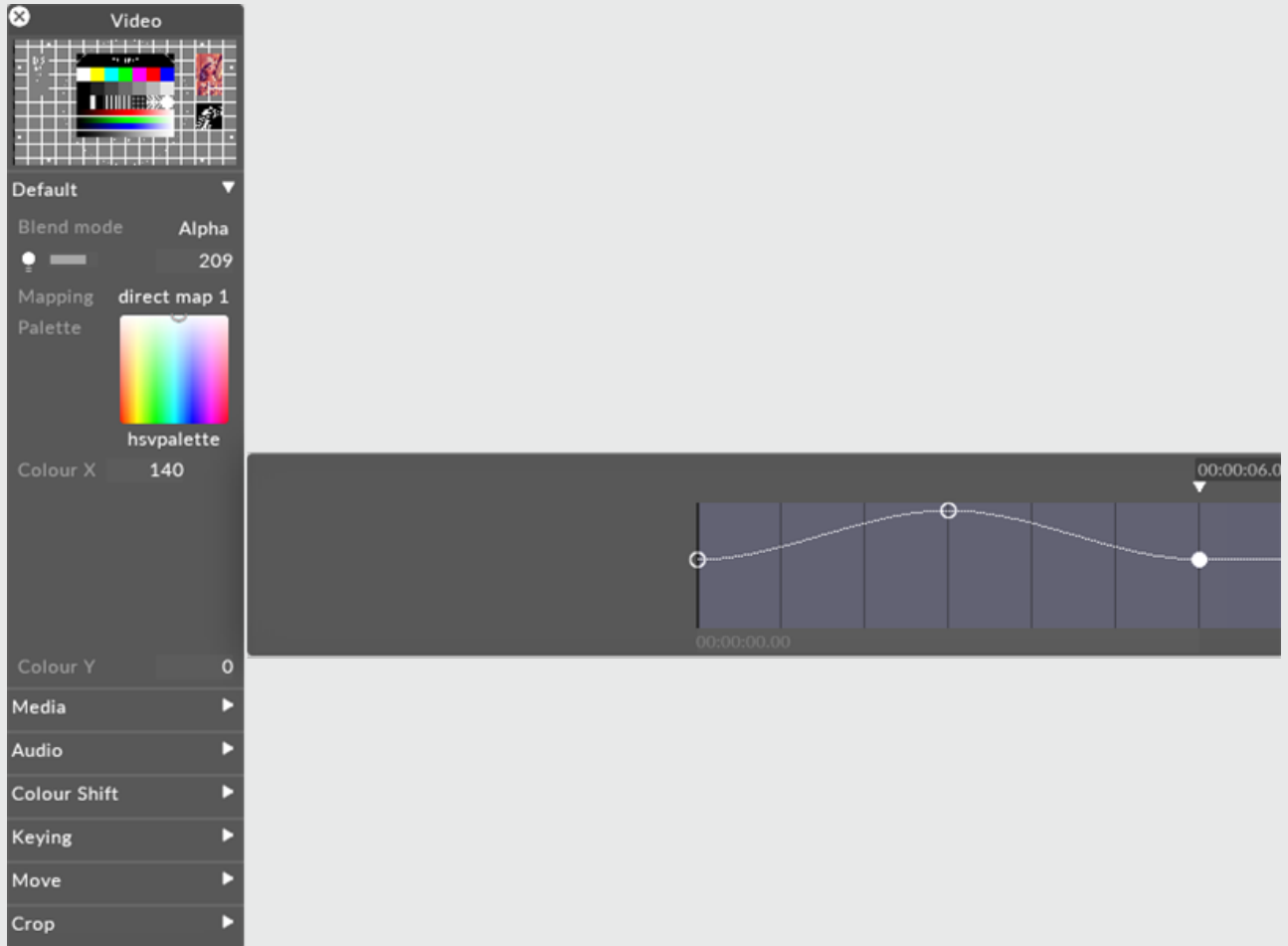

## Speed

This controls the horizontal scrolling speed, measured in pixels per beat. Positive numbers scroll the image to the left; negative numbers scroll it to the right.

## Border

The Scroll layer can generate a black border above and below the image, scaling the image down in the process. The **border** property controls the height of this border, in pixels.

# SpinBitmap

The SpinBitmap layer displays a moving, rotating bitmap. It is able to perform continuous rotation, and can tile its image. Since a bitmap contains an alpha channel, this layer can display up to three layers of images, one behind the other.

All Effect layers take their source from other layer types - either content or generative - by use of an arrow. Linking two layers with an arrow defines the arrowed from layer as the source, and the arrowed to layer as the destination. If you have an arrow between a content layer and effect layer, it is said that the content layer is being 'piped in' to the effect layer. For more information on arrows, see the [compositing layers](#) topic.

To draw an arrow between two layers, hold down **ALT** and left click & drag between the source and destination layer.



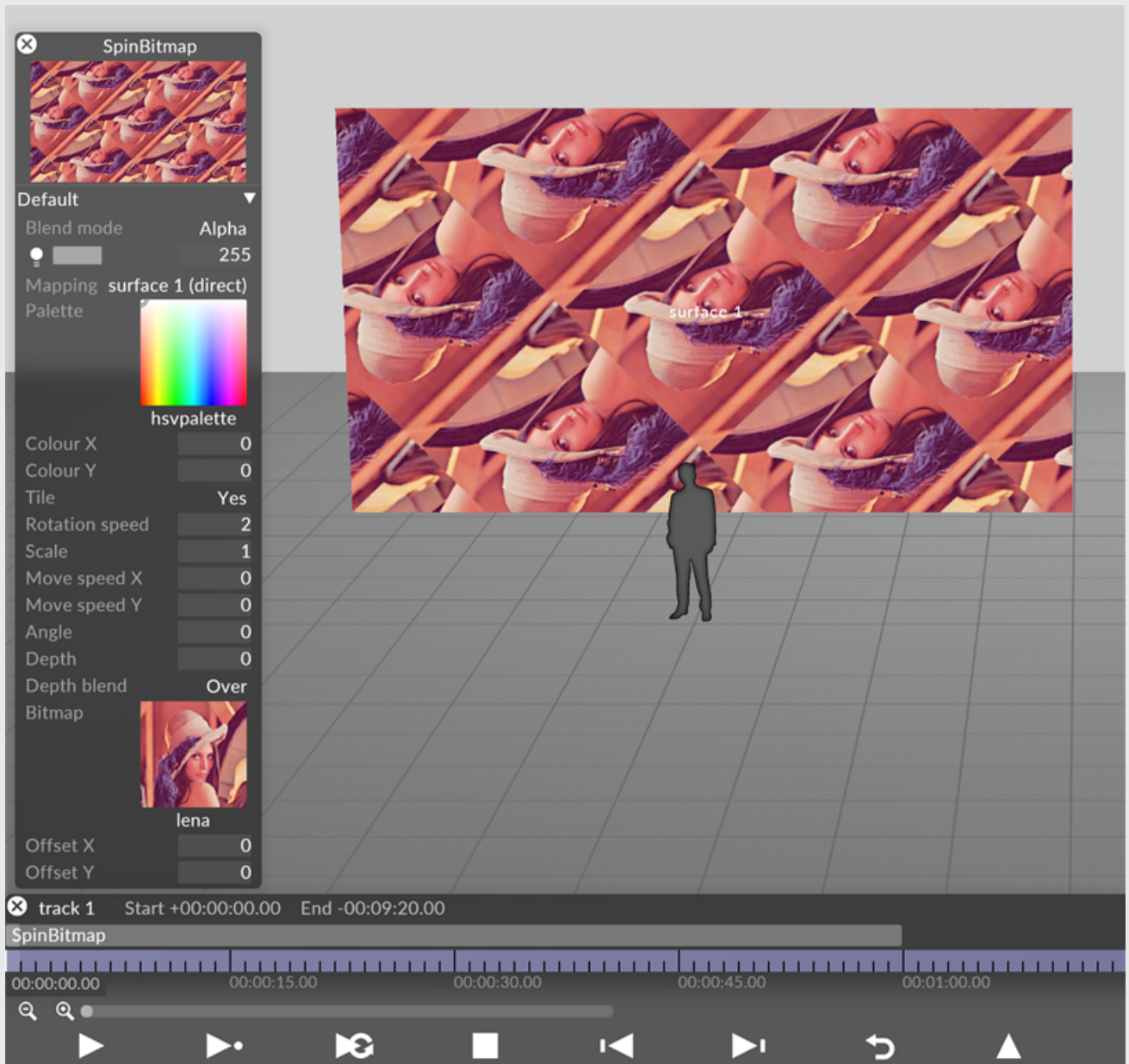

## Preview Thumbnail

This property is a small preview window at the top of the editor showing you what the layer output looks like.



## Blend Mode

BlendMode controls how the output of the layer is composited with the layers below. Layers are rendered in a bottom-up order: layers at the top can modify the output of the layers below.

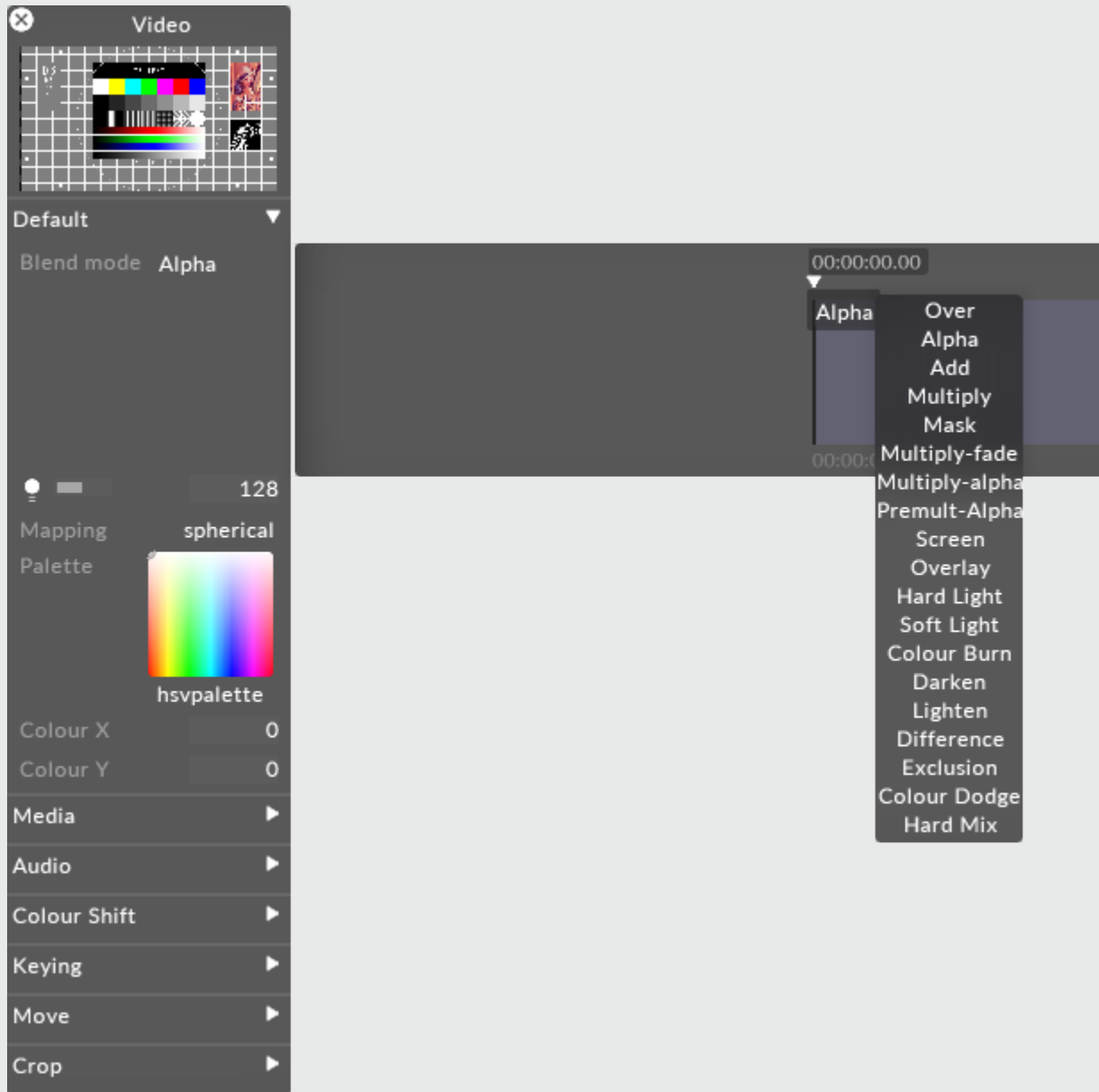

Changing brightness of a content layer in Disguise software is actually controlling the value of the alpha of the layer. Even when displaying a HAP video, the software will composite the layer with a controllable layer of alpha - one per layer.

There are two ways of expressing alpha in an image:

Straight alpha is an alpha channel which functions just like RGB. Alpha acts as a fourth channel of information per pixel which is as independent of the other three as R, G and B are of each other. For example, with straight alpha it is possible to have RGB = 255 (white) and alpha = 0 (fully transparent) on the same pixel. Internally generated content, such as gradient layer, are generated with straight alpha. This is the preferable style of alpha and considering the cleaner method of the two.

Premultiplied alpha takes the alpha and applies it to the values of the RGB channels per pixel. The more transparent something gets with premultiplied alpha, the closer it gets to black - as if the content is sitting on a black table. Premultiplied is the default output of Adobe Photoshop or AfterEffects. the result is our pixel at 255 RGB (full white) with 0 alpha would be calculated as a black pixel in the final image.

Here are explanations of what each individual blend mode will do.

## Over

Makes a layer fully opaque. Premultiplies all alpha onto the RGB value of each pixel. Alpha = black, so adjusting the brightness of a layer in Over blend mode makes it darker.

## Alpha

Default blend mode. It will apply alpha values as a transparency if the alpha is present. Brightness changes will make the layer more or less transparent.

## Add

Adds the value of each RGB pixel together. Always creates a brighter result. Values clamp at 255.

## Multiply

Reads the level of each subpixel as a level between 0.0 and 1.0, and multiplies source with blend. The result is always a darker image overall. For example: white x grey = 0.5. White turns transparent, black takes precedence. Alpha is applied in the same fashion as the Over Blend mode.

## Mask

Choose mask when you want to multiple out content upwards in the stack of layers, rather than downwards. In order to make this work you have to use the same mapping on the layer set to mask and the layer on top.

## Multiply-Fade

The same as Multiply, but will make use of the alpha channel to calculate transparency in the source and blend layers. Since maximum transparency is premultiplied, alpha results in black. This will ignore black created through premultiplying.

## Multiply-Alpha

Multiply with straight alpha. This mode assumes that the alpha has not been premultiplied onto the RGB values and will not apply a correction to the semi-transparent pixels.

## Premultiply Alpha

Like how Multiply-fade will ignore the darkening caused by premultiplying, this blend mode will do the same with Alpha.

## Colour Burn

Blend mode increases the contrast to darken the base colour while reflecting the blend colour. The darker the blend colour, the more intensely the colour will be applied in the base image. White as the blend colour produces no change. Using the colour burn blend mode can produce some harsh results at full opacity.

The colour burn blend mode can be used to make tonal and colour adjustments to a layer.

## Screen

This blend mode looks at each channels colour information and multiplies the inverse of the blend and base colour. The result is always a lighter colour. Screening with black leaves the colour unchanged. Screening with white produces white. The effect is similar to projecting multiple images on top of each other - where bright white is fully opaque, black is fully transparent and 50% grey is 50% transparent.

## Overlay

Multiplies or screens the colours, depending on the base colour. Patterns or colours overlay the existing pixels while preserving the highlights and shadows of the base colour. The base colour is not replaced, but mixed with the blend colour to reflect the lightness or darkness of the original colour.

## Hard Light

Multiplies or screens the colours, depending on the blend colour. The effect is similar to shining a harsh spotlight on the image. If the blend colour (light source/top layer) is lighter than 50% grey, the image is lightened as if it were screened. This is useful for adding highlights to an image. If the blend colour is darker than 50% grey, the image is darkened as if it were multiplied. This is useful for adding shadows to an image. Painting with pure black or white results in pure black or white.

## Soft Light

Darkens or lightens the colours, depending on the blend colour. The effect is similar to shining a diffused spotlight on the image. If the blend colour (light source/top layer) is lighter than 50% grey, the image is lightened as if it were dodged. If the blend colour is darker than 50% grey, the image is darkened as if it were burned in. Painting with pure black or white produces a distinctly darker or lighter area, but does not result in pure black or white.

## Darken

Looks at the colour information in each channel and selects the base or blend colour - whichever is darker - as the result colour. Pixels lighter than the blend colour are replaced and pixels darker than the blend colour do not change.

## Lighten

Looks at the colour information in each channel and selects the base or blend colour - whichever is lighter - as the result colour. Pixels darker than the blend colour are replaced and pixels lighter than the blend colour do not change.

## Difference

Looks at the colour information in each channel and subtracts either the blend colour from the base colour or the base colour from the blend colour depending on which has the greater brightness value.



Blending with white inverts the base colour values and blending with black produces no change.

## Exclusion

Creates an effects similar to but lower in contrast than the difference mode. Blending with white inverts the base colour values. Blending with black produces no change.

## Colour Dodge

Looks at the colour information in each channel and brightens the base colour to reflect the blend colour by decreasing contrast between the two. Blending with black produces no change.

## Hard Mix

Adds the RGB channels of the blend colour to the RGB values of the base colour. If the resulting sum for a channel is 255 or greater, it receives a value of 255; if it is less than 255 it receives a value of 0. Therefore all blended pixels have RGB channels of either 0 or 255. This changes all pixels to primary additive colours (RGB), white or black.

## Brightness

This property (which appears as a light bulb icon) controls the brightness of the layer output.

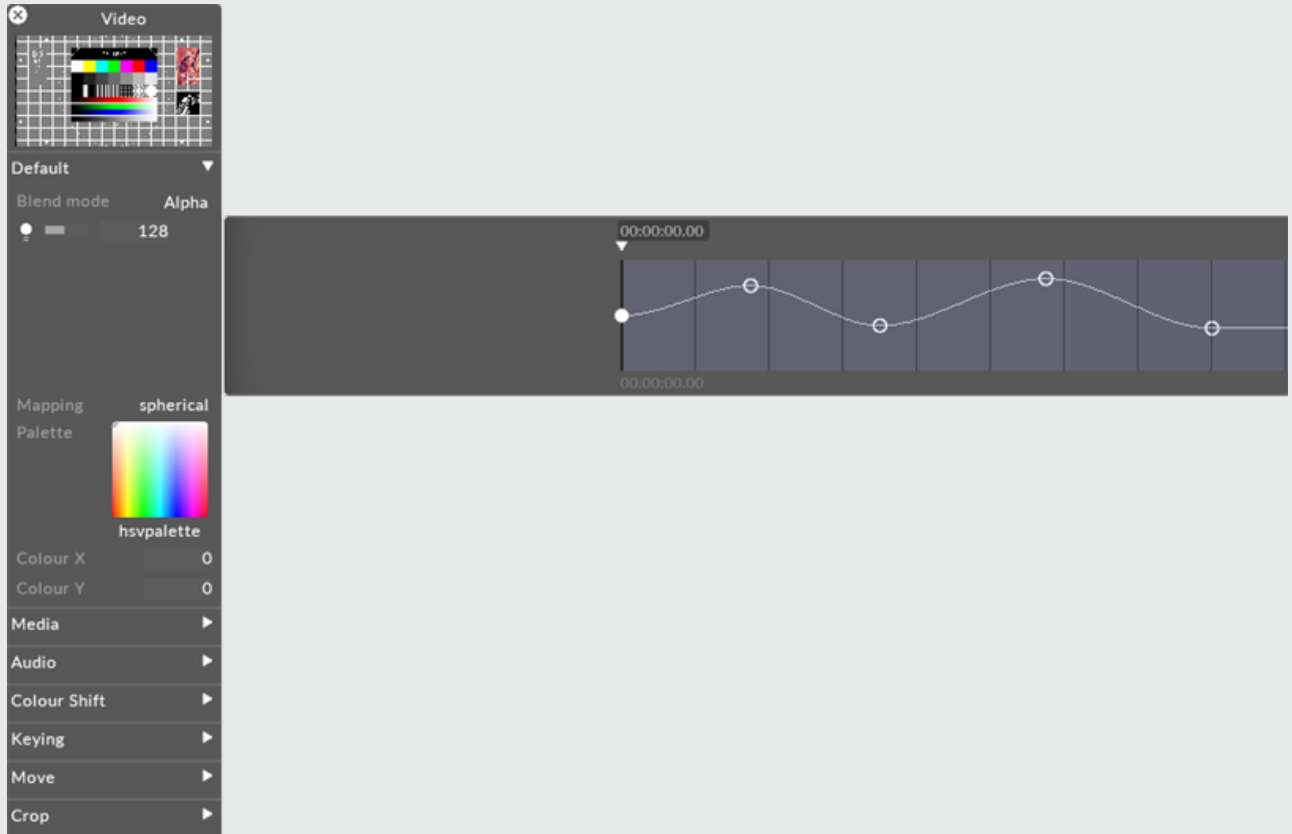

If the layers blend mode is set to Alpha, then reducing the brightness to 0 also reduces the opacity of the layer to 0. This can be useful when you want to dissolve from one layer to the next. In that case, you can place the new layer above the old layer and increase its brightness level.

## Mapping

The mapping property controls how the layer output is mapped onto the screen(s) in the Stage level.

**Video**

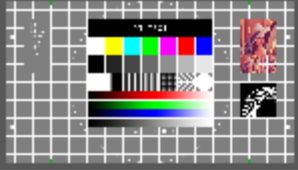

Default ▾

Blend mode Alpha

128

Mapping direct map 1

Palette



hsvpalette

Colour X 0

Colour Y 0

Media ▾

Video



d3\_test\_16-9.png

Speed 1

Mode Normal

At end point Loop

Transition time 0

Audio ▶

Colour Shift ▶

Keying ▶

Move ▶

Crop ▶

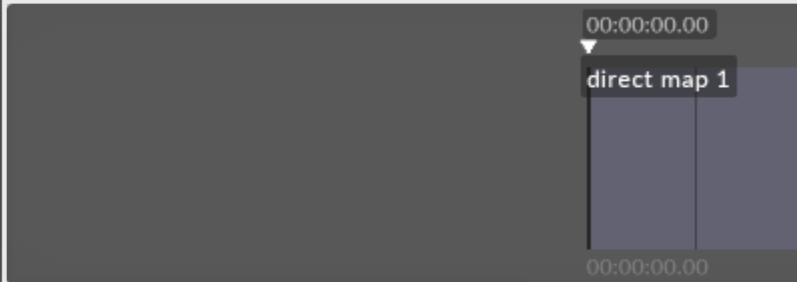

00:00:00.00

direct map 1

00:00:00.00

**mappings**

New mapping: OK Search:

all New Mappings

- direct map 1
- feed map 2
- feed mapping
- mapping 1
- mapping 2
- parallel
- spherical

For information on mapping, including how to use the different mapping types offered by Disguise software, please see the chapter [Content Mapping](#).

## Palette

This points to the still image file that defines the bitmap from which the tint colour is taken. The default palette ( HSVPAL ) consists of the complete range of hues and saturations. Selecting this property will open the Texture object library, which shows all of the still image files saved on your local hard-drive in the **DxTexture** folder.

To control the location within the current palette bitmap, and thus control the colour, you have to edit the **xCol** and **yCol** values (see the section for xCol, yCol).

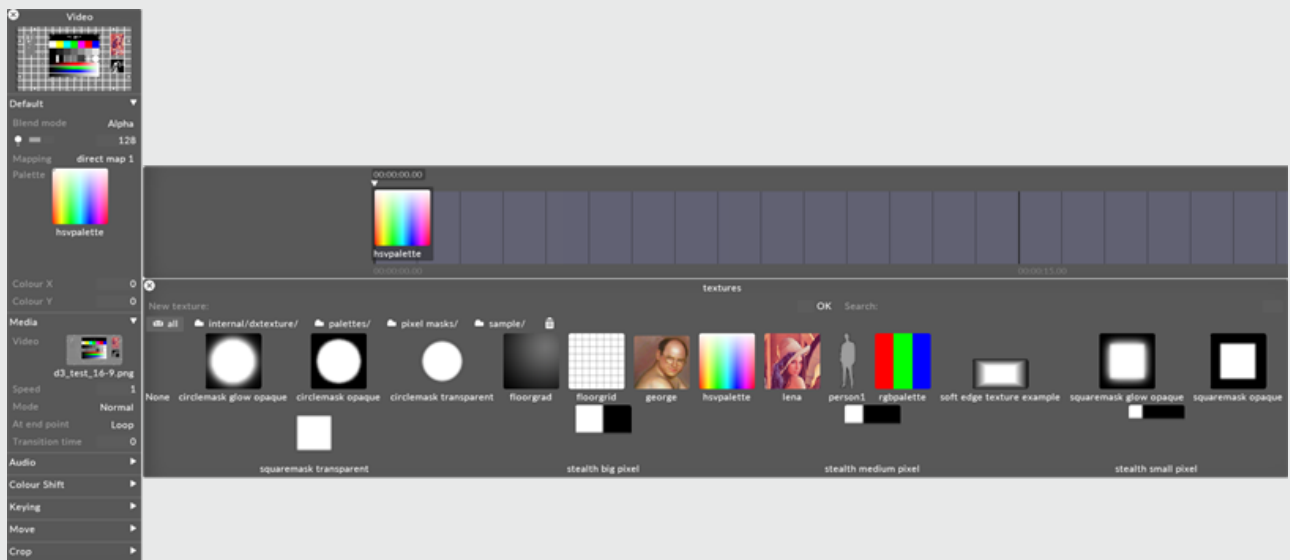

To change the current palette bitmap:

1. Left-click **palette** to open the Texture object library.
2. Left-click the still image file you want to use for the palette bitmap.

If you want to use a palette bitmap other than the standard still images provided in Disguise software, you will need to use a custom still image file.

See the [Placing media files for a project](#) sub-chapter to understand where to place a custom still image file and how to access it in Disguise software. Also save the file to a [supported file format](#).

## xCol yCol

These properties control the coordinates within the current palette bitmap where the output colour is sampled from. The default value is 0,0 which points at the color white (if you are using the HSVPAL palette). Multiplying white with the colors of the chosen content simply generates the original content colors. **Colour X** controls the horizontal position, where 0 is the leftmost edge and 255 is the rightmost edge. **Colour Y** controls the vertical position, where 0 is the top edge and 255 is the bottom edge.

For example, to saturate the video clip red, change the **Colour Y** value to 255 and use 0 for the **Colour X** value. These coordinates refer to the color red in the palette which is being multiplied with the colors of the existing content.

When you are using the default palette HSVPAL , **Colour Y** controls saturation, and **Colour X** controls hue.

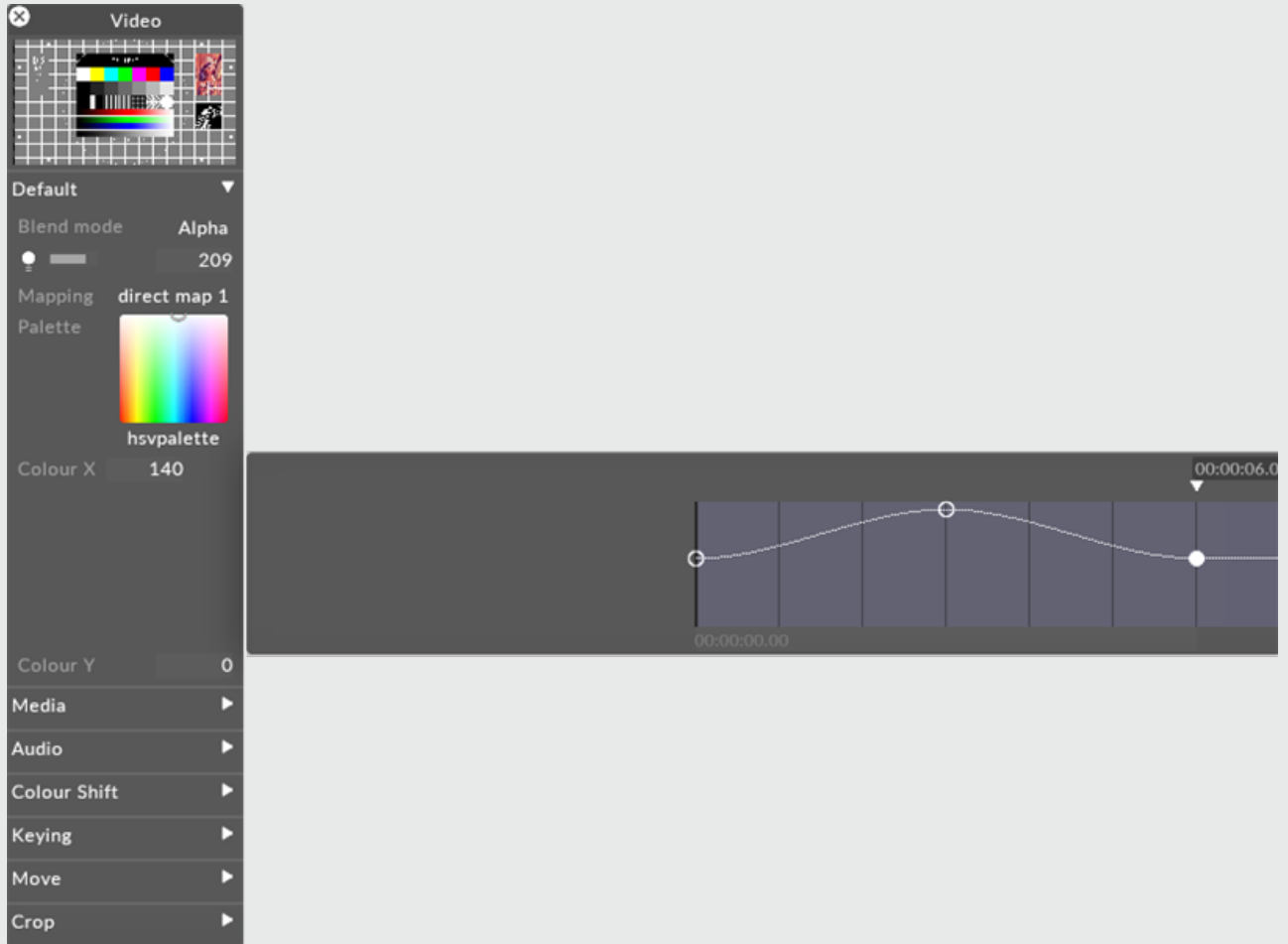

## Tile

If set to **off** , the central image is not tiled and the **move speed** property has no effect.

## Rotation speed

If this is set to 0, the rotation angle is controlled by the **angle** property. Otherwise, this property controls the rotation speed in degrees per beat.

## Scale

This controls the scaling of the bitmap. Somewhat counter-intuitively, increasing the number reduces the size of the bitmap and increases the number of tiled copies.

## Move speed

This controls the movement speed of the image, in each of the x and y axes, in pixels per beat.

## Angle

If **rotation speed** is set to 0, this property controls the **angle** . Otherwise, it has no effect.

## Depth

With values ranging from 0 to 2, **depth** controls the number of layers displayed. This only results in a visual effect if the bitmap is partially transparent, i.e. contains an alpha channel.

## Depth blend

This controls the blend mode applied between the multiple layers. The options to choose from, are **add** , **over** , **alpha** or **multiply** . For more information on blend modes please see the blendMode section in the [Common layer properties](#) topic.

# Offset

This shifts the entire field left or right, measured in pixels.



# Strobe

The Strobe layer creates a flashing strobe effect over multiple screens.



**Warning:** The Strobe layer only works using a Feed map. In order to turn each screen into "one flash", scale each feed rectangle to 1 pixel and place each screen's feed rectangles next to each other on the Mapping canvas.

Some Generative layers take their source from other layer types - either content or generative - by use of an arrow. Linking two layers with an arrow defines the arrowed from layer as the source, and the arrowed to layer as the destination. If you have an arrow between a content layer and effect layer, it is said that the content layer is being 'piped in' to the effect layer. For more information on arrows, see the [compositing layers topic](#).

To draw an arrow between two layers, hold down **ALT** and left click & drag between the source and destination layer.

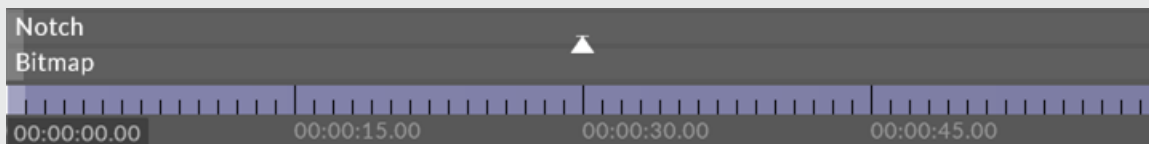

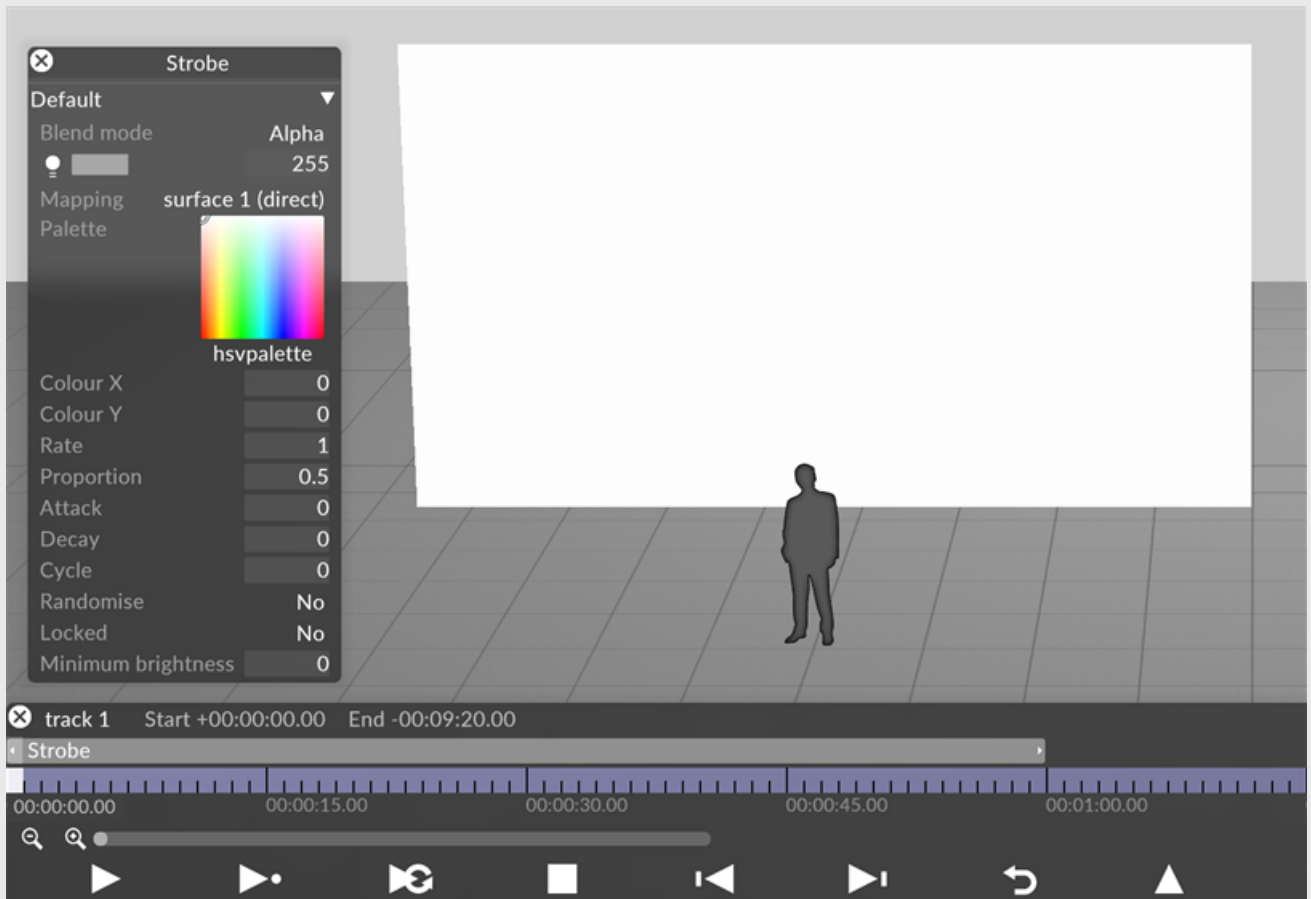

## Blend Mode

BlendMode controls how the output of the layer is composited with the layers below. Layers are rendered in a bottom-up order: layers at the top can modify the output of the layers below.

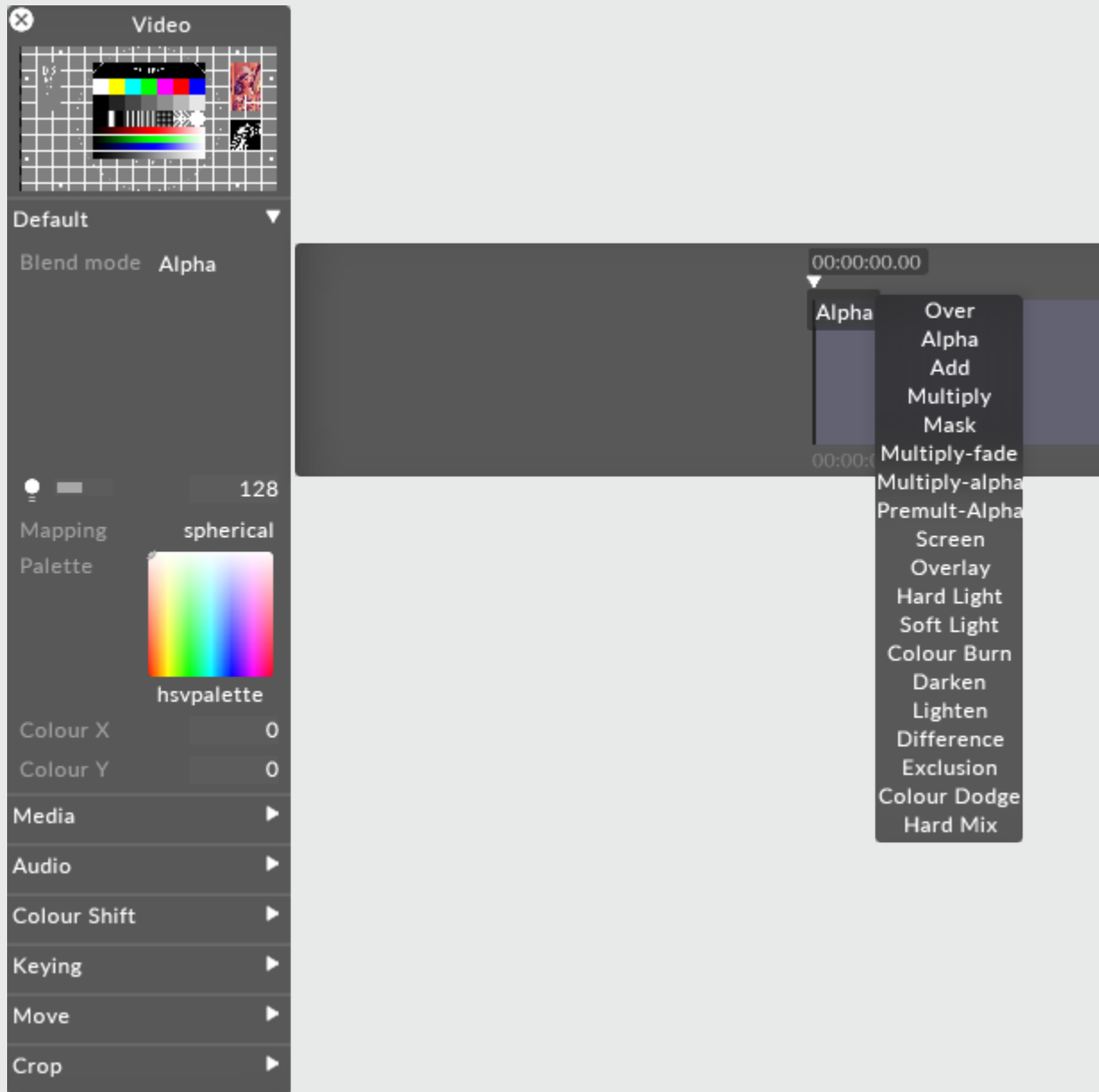

Changing brightness of a content layer in Disguise software is actually controlling the value of the alpha of the layer. Even when displaying a HAP video, the software will composite the layer with a controllable layer of alpha - one per layer.

There are two ways of expressing alpha in an image:

Straight alpha is an alpha channel which functions just like RGB. Alpha acts as a fourth channel of information per pixel which is as independent of the other three as R, G and B are of each other. For example, with straight alpha it is possible to have RGB = 255 (white) and alpha = 0 (fully transparent) on the same pixel. Internally generated content, such as gradient layer, are generated with straight alpha. This is the preferable style of alpha and considering the cleaner method of the two.

Premultiplied alpha takes the alpha and applies it to the values of the RGB channels per pixel. The more transparent something gets with premultiplied alpha, the closer it gets to black - as if the content is sitting on a black table. Premultiplied is the default output of Adobe Photoshop or AfterEffects. The result is our pixel at 255 RGB (full white) with 0 alpha would be calculated as a black pixel in the final image.

Here are explanations of what each individual blend mode will do.

## Over

Makes a layer fully opaque. Premultiplies all alpha onto the RGB value of each pixel. Alpha = black, so adjusting the brightness of a layer in Over blend mode makes it darker.

## Alpha

Default blend mode. It will apply alpha values as a transparency if the alpha is present. Brightness changes will make the layer more or less transparent.

## Add

Adds the value of each RGB pixel together. Always creates a brighter result. Values clamp at 255.

## Multiply

Reads the level of each subpixel as a level between 0.0 and 1.0, and multiplies source with blend. The result is always a darker image overall. For example: white x grey = 0.5. White turns transparent, black takes precedence. Alpha is applied in the same fashion as the Over Blend mode.

## Mask

Choose mask when you want to multiple out content upwards in the stack of layers, rather than downwards. In order to make this work you have to use the same mapping on the layer set to mask and the layer on top.

## Multiply-Fade

The same as Multiply, but will make use of the alpha channel to calculate transparency in the source and blend layers. Since maximum transparency is premultiplied, alpha results in black. This will ignore black created through premultiplying.

## Multiply-Alpha

Multiply with straight alpha. This mode assumes that the alpha has not been premultiplied onto the RGB values and will not apply a correction to the semi-transparent pixels.

## Premultiply Alpha

Like how Multiply-fade will ignore the darkening caused by premultiplying, this blend mode will do the same with Alpha.

## Colour Burn

Blend mode increases the contrast to darken the base colour while reflecting the blend colour. The darker the blend colour, the more intensely the colour will be applied in the base image. White as the blend colour produces no change. Using the colour burn blend mode can produce some harsh results at full opacity.

The colour burn blend mode can be used to make tonal and colour adjustments to a layer.

## Screen

This blend mode looks at each channels colour information and multiplies the inverse of the blend and base colour. The result is always a lighter colour. Screening with black leaves the colour unchanged. Screening with white produces white. The effect is similar to projecting multiple images on top of each other - where bright white is fully opaque, black is fully transparent and 50% grey is 50% transparent.

## Overlay

Multiplies or screens the colours, depending on the base colour. Patterns or colours overlay the existing pixels while preserving the highlights and shadows of the base colour. The base colour is not replaced, but mixed with the blend colour to reflect the lightness or darkness of the original colour.

## Hard Light

Multiplies or screens the colours, depending on the blend colour. The effect is similar to shining a harsh spotlight on the image. If the blend colour (light source/top layer) is lighter than 50% grey, the image is lightened as if it were screened. This is useful for adding highlights to an image. If the blend colour is darker than 50% grey, the image is darkened as if it were multiplied. This is useful for adding shadows to an image. Painting with pure black or white results in pure black or white.

## Soft Light

Darkens or lightens the colours, depending on the blend colour. The effect is similar to shining a diffused spotlight on the image. If the blend colour (light source/top layer) is lighter than 50% grey, the image is lightened as if it were dodged. If the blend colour is darker than 50% grey, the image is darkened as if it were burned in. Painting with pure black or white produces a distinctly darker or lighter area, but does not result in pure black or white.

## Darken

Looks at the colour information in each channel and selects the base or blend colour - whichever is darker - as the result colour. Pixels lighter than the blend colour are replaced and pixels darker than the blend colour do not change.

## Lighten

Looks at the colour information in each channel and selects the base or blend colour - whichever is lighter - as the result colour. Pixels darker than the blend colour are replaced and pixels lighter than the blend colour do not change.

## Difference

Looks at the colour information in each channel and subtracts either the blend colour from the base colour or the base colour from the blend colour depending on which has the greater brightness value.

Blending with white inverts the base colour values and blending with black produces no change.

## Exclusion

Creates an effects similar to but lower in contrast than the difference mode. Blending with white inverts the base colour values. Blending with black produces no change.

## Colour Dodge

Looks at the colour information in each channel and brightens the base colour to reflect the blend colour by decreasing contrast between the two. Blending with black produces no change.

## Hard Mix

Adds the RGB channels of the blend colour to the RGB values of the base colour. If the resulting sum for a channel is 255 or greater, it receives a value of 255; if it is less than 255 it receives a value of 0. Therefore all blended pixels have RGB channels of either 0 or 255. This changes all pixels to primary additive colours (RGB), white or black.

## Brightness

This property (which appears as a light bulb icon) controls the brightness of the layer output.

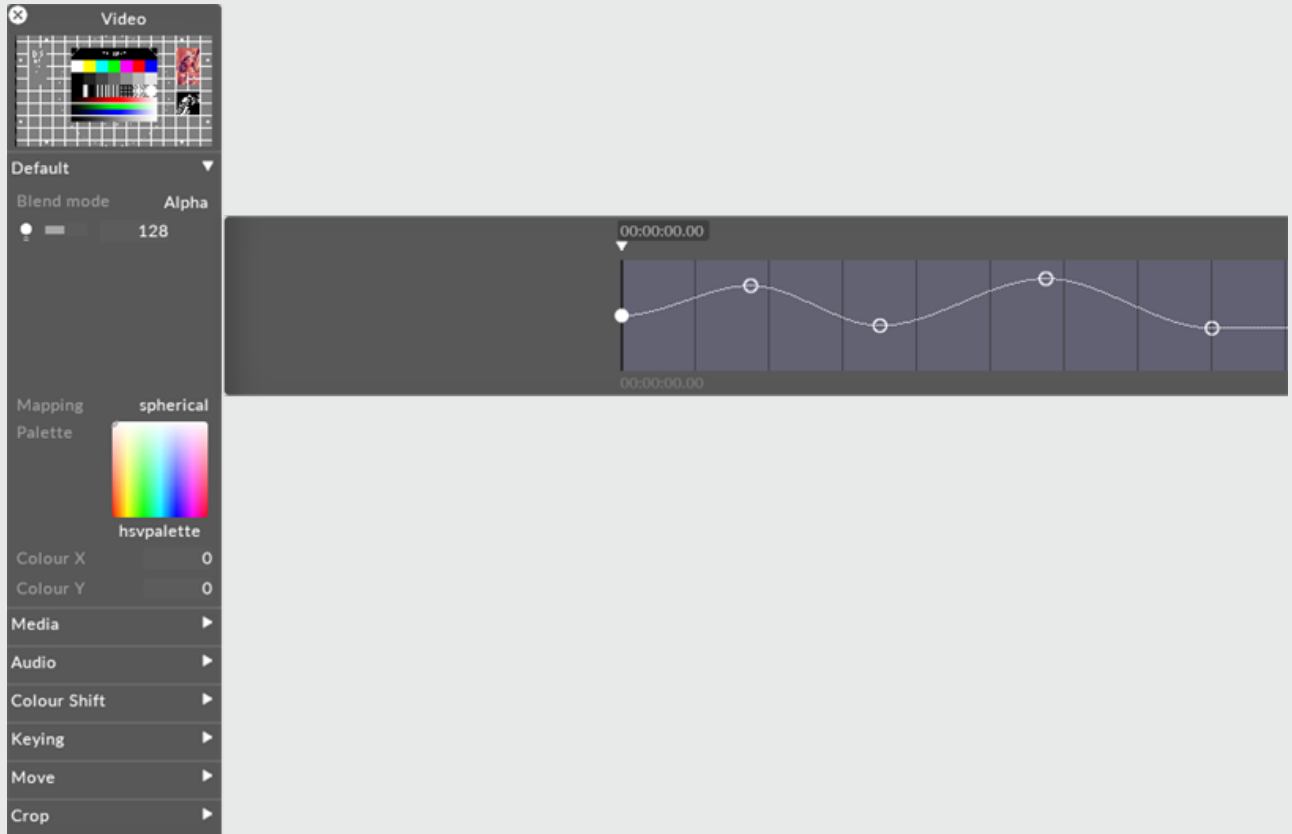

If the layers blend mode is set to Alpha, then reducing the brightness to 0 also reduces the opacity of the layer to 0. This can be useful when you want to dissolve from one layer to the next. In that case, you can place the new layer above the old layer and increase its brightness level.

## Mapping

The mapping property controls how the layer output is mapped onto the screen(s) in the Stage level.



**Video**

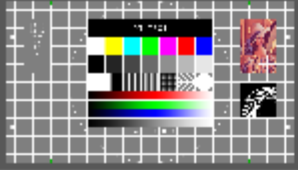

Default ▾

Blend mode Alpha

128

Mapping direct map 1

Palette



hsvpalette

Colour X 0

Colour Y 0

Media ▾

Video



d3\_test\_16-9.png

Speed 1

Mode Normal

At end point Loop

Transition time 0

Audio ▶

Colour Shift ▶

Keying ▶

Move ▶

Crop ▶

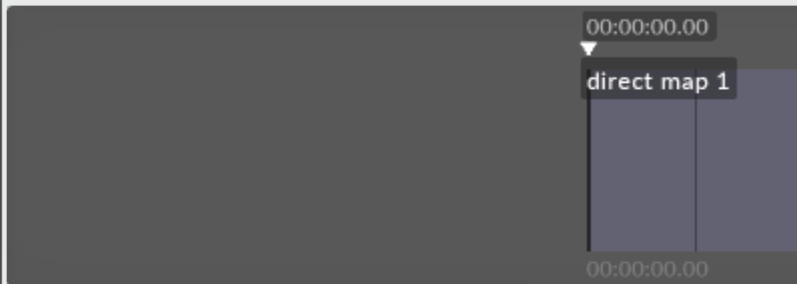

00:00:00.00

direct map 1

00:00:00.00

**mappings**

New mapping: OK Search:

all New Mappings

- direct map 1
- feed map 2
- feed mapping
- mapping 1
- mapping 2
- parallel
- spherical

For information on mapping, including how to use the different mapping types offered by Disguise software, please see the chapter [Content Mapping](#).

## Palette

This points to the still image file that defines the bitmap from which the tint colour is taken. The default palette ( HSVPAL ) consists of the complete range of hues and saturations. Selecting this property will open the Texture object library, which shows all of the still image files saved on your local hard-drive in the **DxTexture** folder.

To control the location within the current palette bitmap, and thus control the colour, you have to edit the **xCol** and **yCol** values (see the section for xCol, yCol).

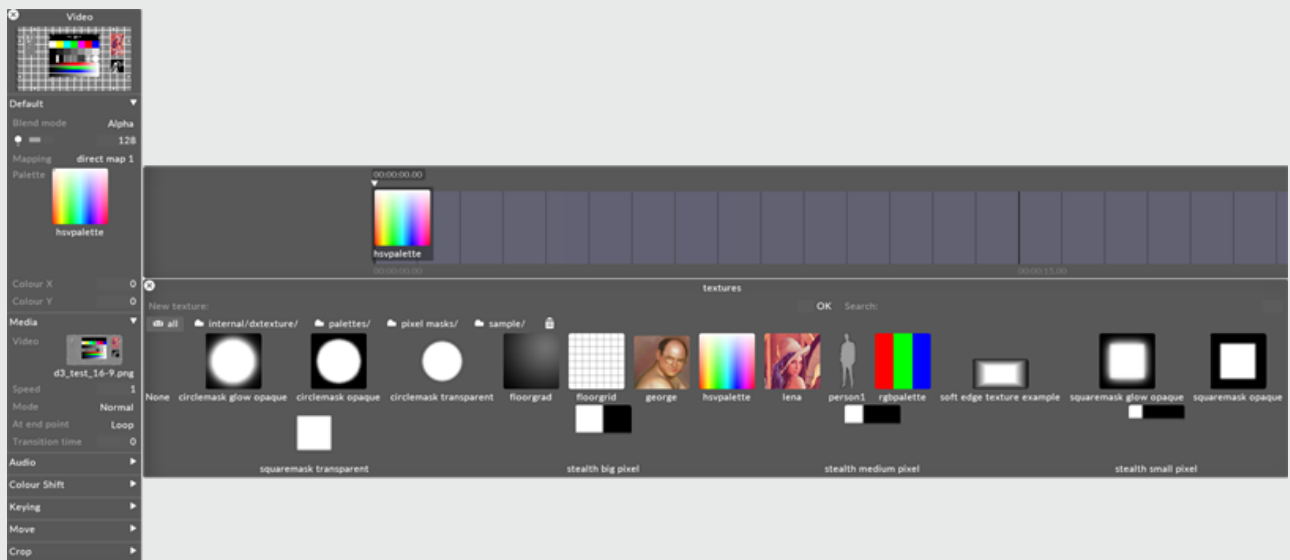

To change the current palette bitmap:

1. Left-click **palette** to open the Texture object library.
2. Left-click the still image file you want to use for the palette bitmap.

If you want to use a palette bitmap other than the standard still images provided in Disguise software, you will need to use a custom still image file.

See the [Placing media files for a project](#) sub-chapter to understand where to place a custom still image file and how to access it in Disguise software. Also save the file to a [supported file format](#).

## xCol yCol

These properties control the coordinates within the current palette bitmap where the output colour is sampled from. The default value is 0,0 which points at the color white (if you are using the HSVPAL palette). Multiplying white with the colors of the chosen content simply generates the original content colors. **Colour X** controls the horizontal position, where 0 is the leftmost edge and 255 is the rightmost edge. **Colour Y** controls the vertical position, where 0 is the top edge and 255 is the bottom edge.

For example, to saturate the video clip red, change the **Colour Y** value to 255 and use 0 for the **Colour X** value. These coordinates refer to the color red in the palette which is being multiplied with the colors of the existing content.

When you are using the default palette HSVPAL , **Colour Y** controls saturation, and **Colour X** controls hue.

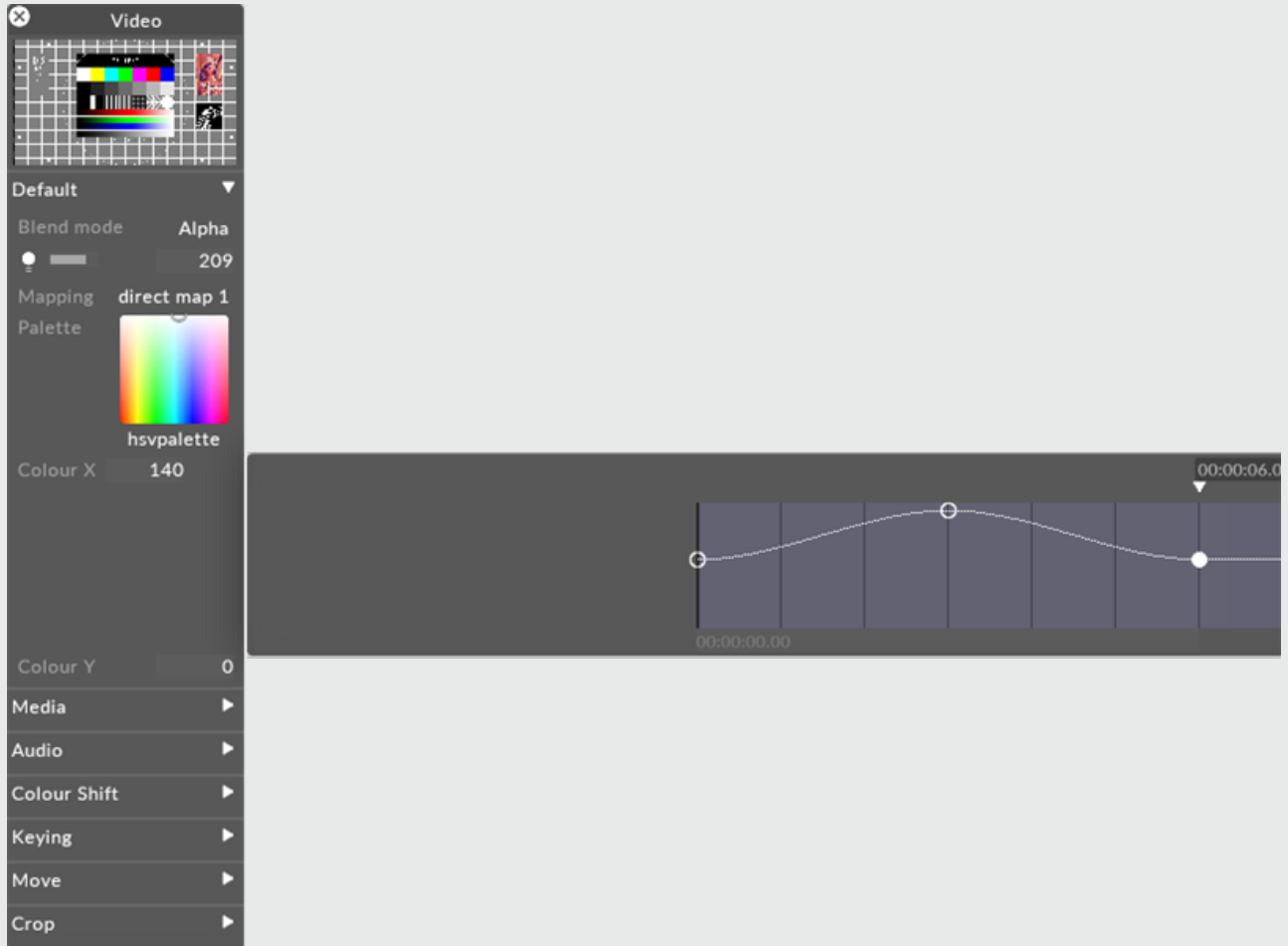

## Rate

Speed of strobing, in cycles per beat. 0 = stop flashing.

## Proportion

The amount of time within the cycle that the strobe is on. 0.5 = half the cycle time is white.

## Attack

Speed of attack (ramping from 0 to full brightness). 1 = instant, 0 = slowest.

## Decay

Speed of decay (ramping from full brightness down to 0). 1 = instant, 0 = slowest.

## Cycle

The cycle of the strobe. 0 = all screens flash together, 1 = screens flash in turn.

## Randomise

The randomness of the cycle order. Yes = order of the screens is randomised, No = order of the screens is not randomised.

## Min brightness

The minimum brightness outputted by the layer. 0 = 0%, 1 = 100%.

# Trigger

The Trigger layer allows you to trigger still image content at specific points of time on your screen(s).

All Effect layers take their source from other layer types - either content or generative - by use of an arrow. Linking two layers with an arrow defines the arrowed from layer as the source, and the arrowed to layer as the destination. If you have an arrow between a content layer and effect layer, it is said that the content layer is being 'piped in' to the effect layer. For more information on arrows, see the [compositing layers](#) topic.

To draw an arrow between two layers, hold down **ALT** and left click & drag between the source and destination layer.

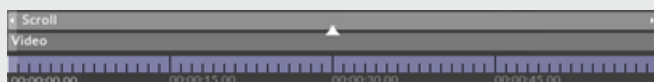

# Preview Thumbnail

This property is a small preview window at the top of the editor showing you what the layer output looks like.

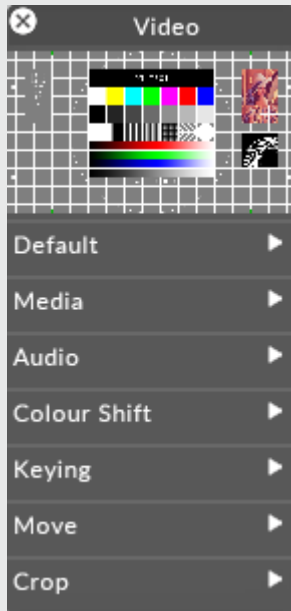

# Blend Mode

BlendMode controls how the output of the layer is composited with the layers below. Layers are rendered in a bottom-up order: layers at the top can modify the output of the layers below.

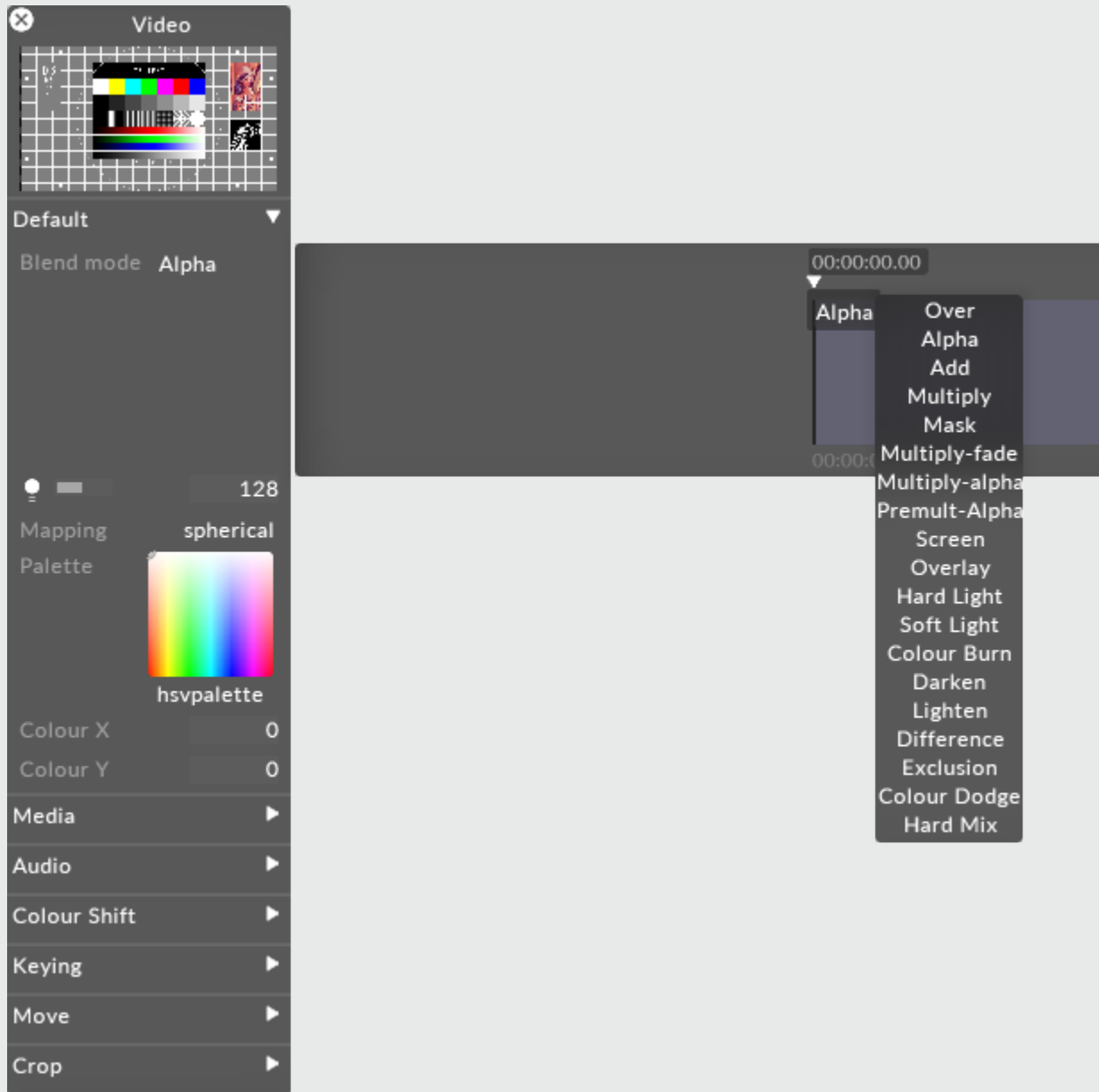

Changing brightness of a content layer in Disguise software is actually controlling the value of the alpha of the layer. Even when displaying a HAP video, the software will composite the layer with a controllable layer of alpha - one per layer.



There are two ways of expressing alpha in an image:

Straight alpha is an alpha channel which functions just like RGB. Alpha acts as a fourth channel of information per pixel which is as independent of the other three as R, G and B are of each other. For example, with straight alpha it is possible to have RGB = 255 (white) and alpha = 0 (fully transparent) on the same pixel. Internally generated content, such as gradient layer, are generated with straight alpha. This is the preferable style of alpha and considering the cleaner method of the two.

Premultiplied alpha takes the alpha and applies it to the values of the RGB channels per pixel. The more transparent something gets with premultiplied alpha, the closer it gets to black - as if the content is sitting on a black table. Premultiplied is the default output of Adobe Photoshop or AfterEffects. The result is our pixel at 255 RGB (full white) with 0 alpha would be calculated as a black pixel in the final image.

Here are explanations of what each individual blend mode will do.

## Over

Makes a layer fully opaque. Premultiplies all alpha onto the RGB value of each pixel. Alpha = black, so adjusting the brightness of a layer in Over blend mode makes it darker.

## Alpha

Default blend mode. It will apply alpha values as a transparency if the alpha is present. Brightness changes will make the layer more or less transparent.

## Add

Adds the value of each RGB pixel together. Always creates a brighter result. Values clamp at 255.

## Multiply

Reads the level of each subpixel as a level between 0.0 and 1.0, and multiplies source with blend. The result is always a darker image overall. For example: white x grey = 0.5. White turns transparent, black takes precedence. Alpha is applied in the same fashion as the Over Blend mode.

## Mask

Choose mask when you want to multiple out content upwards in the stack of layers, rather than downwards. In order to make this work you have to use the same mapping on the layer set to mask and the layer on top.

## Multiply-Fade

The same as Multiply, but will make use of the alpha channel to calculate transparency in the source and blend layers. Since maximum transparency is premultiplied, alpha results in black. This will ignore black created through premultiplying.

## Multiply-Alpha

Multiply with straight alpha. This mode assumes that the alpha has not been premultiplied onto the RGB values and will not apply a correction to the semi-transparent pixels.

## Premultiply Alpha

Like how Multiply-fade will ignore the darkening caused by premultiplying, this blend mode will do the same with Alpha.

## Colour Burn

Blend mode increases the contrast to darken the base colour while reflecting the blend colour. The darker the blend colour, the more intensely the colour will be applied in the base image. White as the blend colour produces no change. Using the colour burn blend mode can produce some harsh results at full opacity.

The colour burn blend mode can be used to make tonal and colour adjustments to a layer.

## Screen

This blend mode looks at each channels colour information and multiplies the inverse of the blend and base colour. The result is always a lighter colour. Screening with black leaves the colour unchanged. Screening with white produces white. The effect is similar to projecting multiple images on top of each other - where bright white is fully opaque, black is fully transparent and 50% grey is 50% transparent.

## Overlay

Multiplies or screens the colours, depending on the base colour. Patterns or colours overlay the existing pixels while preserving the highlights and shadows of the base colour. The base colour is not replaced, but mixed with the blend colour to reflect the lightness or darkness of the original colour.

## Hard Light

Multiplies or screens the colours, depending on the blend colour. The effect is similar to shining a harsh spotlight on the image. If the blend colour (light source/top layer) is lighter than 50% grey, the image is lightened as if it were screened. This is useful for adding highlights to an image. If the blend colour is darker than 50% grey, the image is darkened as if it were multiplied. This is useful for adding shadows to an image. Painting with pure black or white results in pure black or white.

## Soft Light

Darkens or lightens the colours, depending on the blend colour. The effect is similar to shining a diffused spotlight on the image. If the blend colour (light source/top layer) is lighter than 50% grey, the image is lightened as if it were dodged. If the blend colour is darker than 50% grey, the image is darkened as if it were burned in. Painting with pure black or white produces a distinctly darker or lighter area, but does not result in pure black or white.

## Darken

Looks at the colour information in each channel and selects the base or blend colour - whichever is darker - as the result colour. Pixels lighter than the blend colour are replaced and pixels darker than the blend colour do not change.

## Lighten

Looks at the colour information in each channel and selects the base or blend colour - whichever is lighter - as the result colour. Pixels darker than the blend colour are replaced and pixels lighter than the blend colour do not change.

## Difference

Looks at the colour information in each channel and subtracts either the blend colour from the base colour or the base colour from the blend colour depending on which has the greater brightness value.

Blending with white inverts the base colour values and blending with black produces no change.

## Exclusion

Creates an effects similar to but lower in contrast than the difference mode. Blending with white inverts the base colour values. Blending with black produces no change.

## Colour Dodge

Looks at the colour information in each channel and brightens the base colour to reflect the blend colour by decreasing contrast between the two. Blending with black produces no change.

## Hard Mix

Adds the RGB channels of the blend colour to the RGB values of the base colour. If the resulting sum for a channel is 255 or greater, it receives a value of 255; if it is less than 255 it receives a value of 0. Therefore all blended pixels have RGB channels of either 0 or 255. This changes all pixels to primary additive colours (RGB), white or black.

## Brightness

This property (which appears as a light bulb icon) controls the brightness of the layer output.

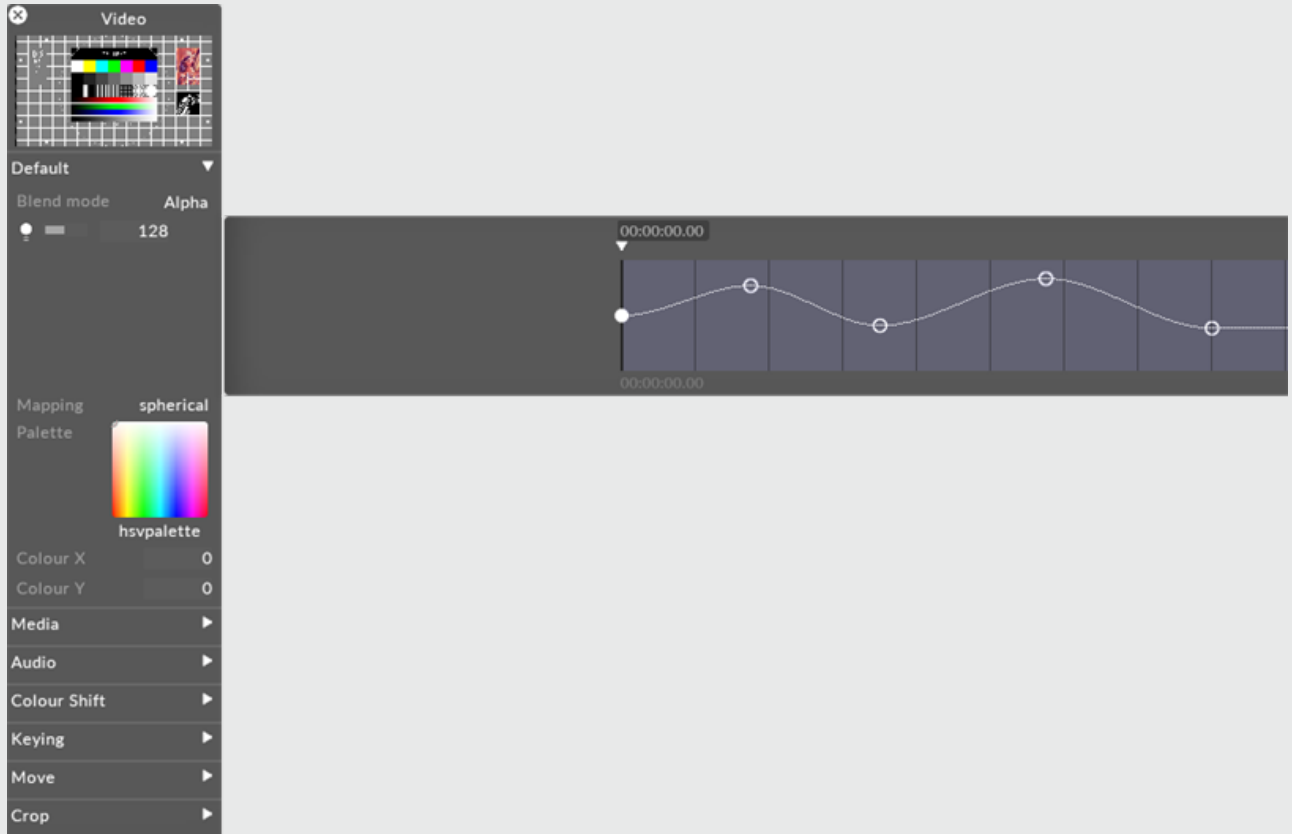

If the layers blend mode is set to Alpha, then reducing the brightness to 0 also reduces the opacity of the layer to 0. This can be useful when you want to dissolve from one layer to the next. In that case, you can place the new layer above the old layer and increase its brightness level.

## Mapping

The mapping property controls how the layer output is mapped onto the screen(s) in the Stage level.

**Video**

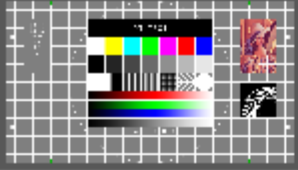

Default ▾

Blend mode Alpha

128

Mapping direct map 1

Palette



hsvpalette

Colour X 0

Colour Y 0

Media ▾

Video



d3\_test\_16-9.png

Speed 1

Mode Normal

At end point Loop

Transition time 0

Audio ▶

Colour Shift ▶

Keying ▶

Move ▶

Crop ▶

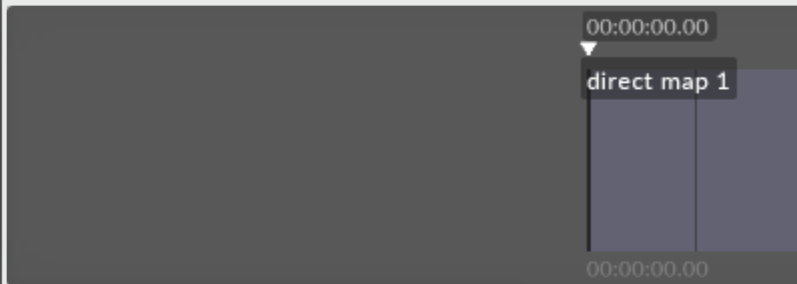

00:00:00.00

direct map 1

00:00:00.00

**mappings**

New mapping: OK Search:

all New Mappings

- direct map 1
- feed map 2
- feed mapping
- mapping 1
- mapping 2
- parallel
- spherical

For information on mapping, including how to use the different mapping types offered by Disguise software, please see the chapter [Content Mapping](#).

## Palette

This points to the still image file that defines the bitmap from which the tint colour is taken. The default palette ( HSVPAL ) consists of the complete range of hues and saturations. Selecting this property will open the Texture object library, which shows all of the still image files saved on your local hard-drive in the **DxTexture** folder.

To control the location within the current palette bitmap, and thus control the colour, you have to edit the **xCol** and **yCol** values (see the section for xCol, yCol).

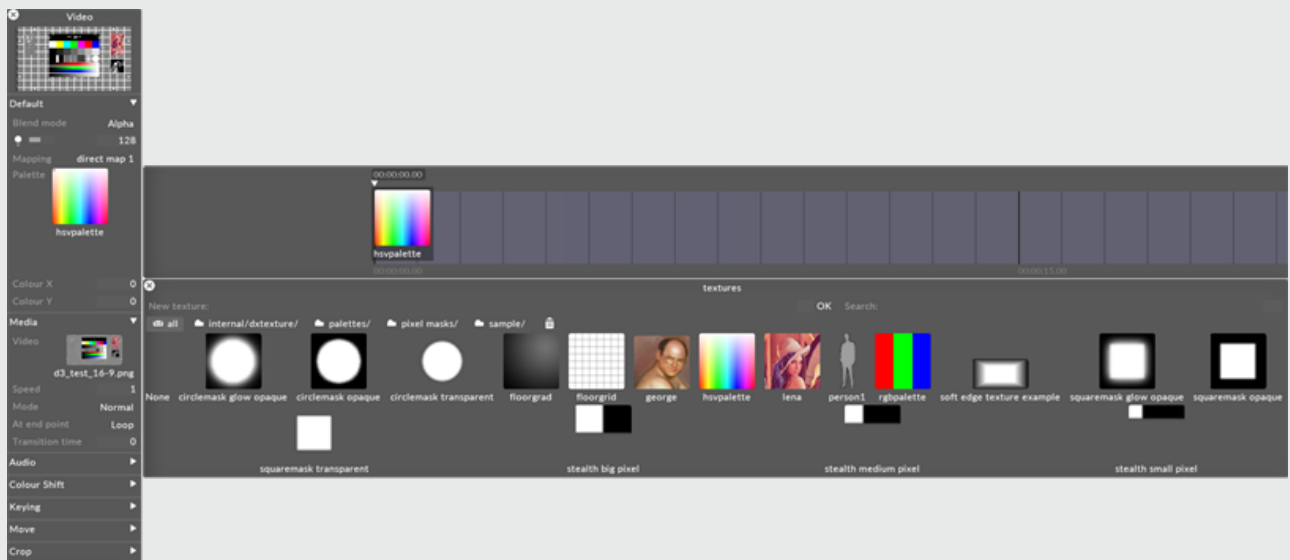

To change the current palette bitmap:

1. Left-click **palette** to open the Texture object library.
2. Left-click the still image file you want to use for the palette bitmap.

If you want to use a palette bitmap other than the standard still images provided in Disguise software, you will need to use a custom still image file.

See the [Placing media files for a project](#) sub-chapter to understand where to place a custom still image file and how to access it in Disguise software. Also save the file to a [supported file format](#).

## xCol yCol

These properties control the coordinates within the current palette bitmap where the output colour is sampled from. The default value is 0,0 which points at the color white (if you are using the HSVPAL palette). Multiplying white with the colors of the chosen content simply generates the original content colors. **Colour X** controls the horizontal position, where 0 is the leftmost edge and 255 is the rightmost edge. **Colour Y** controls the vertical position, where 0 is the top edge and 255 is the bottom edge.

For example, to saturate the video clip red, change the **Colour Y** value to 255 and use 0 for the **Colour X** value. These coordinates refer to the color red in the palette which is being multiplied with the colors of the existing content.

When you are using the default palette HSVPAL , **Colour Y** controls saturation, and **Colour X** controls hue.



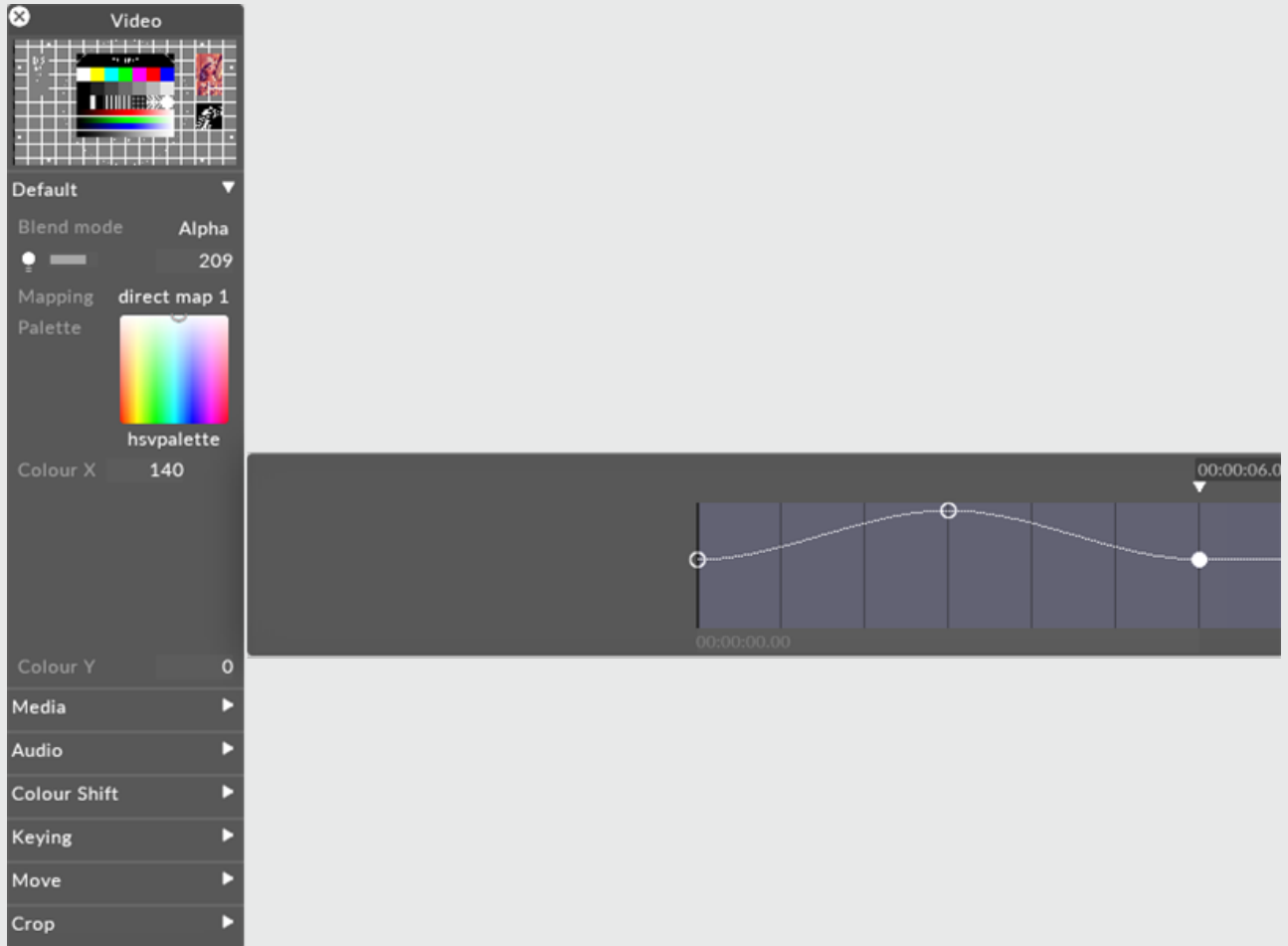

## Bitmap

Still image file to be placed in the key-frame editor.

## Speed

The transition speed of the triggered content. Positive = bottom to top, negative = top to bottom.

## Size x, y

The pixel size of the image.

## Trigger

Every trigger keyframe triggers the chosen image.

# UVLookup Layer

The UVLookup layer allows you to to change the UV mapping of a source texture applied to an object based on colour information contained in a lookup texture

## Overview

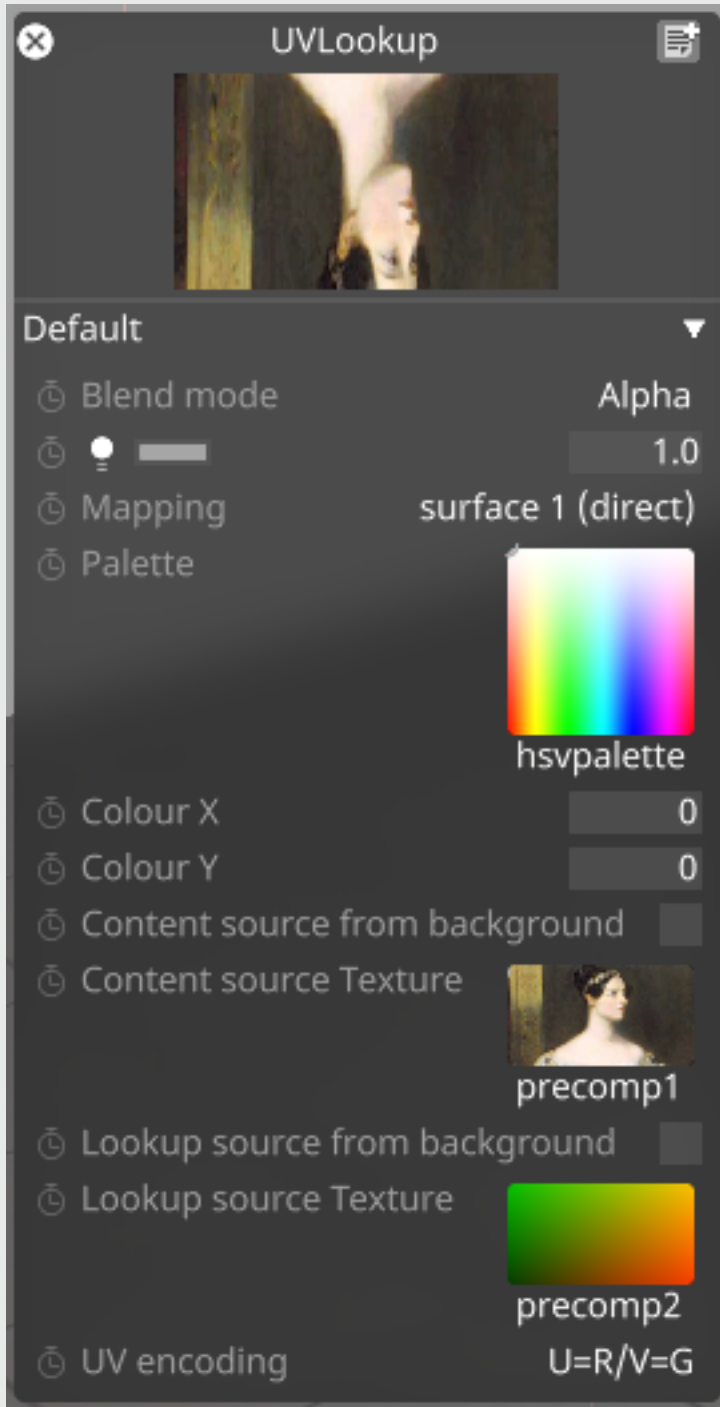

Similar in function to [Youveelizer](#), the plugin for After Effects that allows you to replace textures by using a UV map, the UVLookup layer is an effects layer available directly in Disguise software.

The UVLookup data is packed as two 12bit coordinates, U & V, into a 24-bit RGB video.

# Workflow

The UVLookup layer requires a Content source texture and a Lookup source texture. It is recommended to create PreComp textures and use these textures as the source textures within the UVLookup layer. For information on creating a PreComp visit [this link](#).

To configure the UVLookup layer, follow these steps:

1. Open a UVLookup layer
2. Create a new PreComp texture, "PreComp 1", and assign this as the Content source texture
3. Create a Video layer directly under the UVLookup layer, set the mapping of the layer to "PreComp 1", and select a piece of media for the Video layer.
4. Return to the UVLookup layer editor and create a second PreComp texture, "PreComp 2"
5. Add a second Video layer directly beneath the UVLookup layer, map it to "PreComp 2", and select a piece of media for the Video layer. Ideally this content will be a UV pass rendered specifically for this application
6. In the UVLookup layer editor, change the UV encoding setting to match the desired UV mapping coordinates; U=R/V=G is shown in the image shown below:

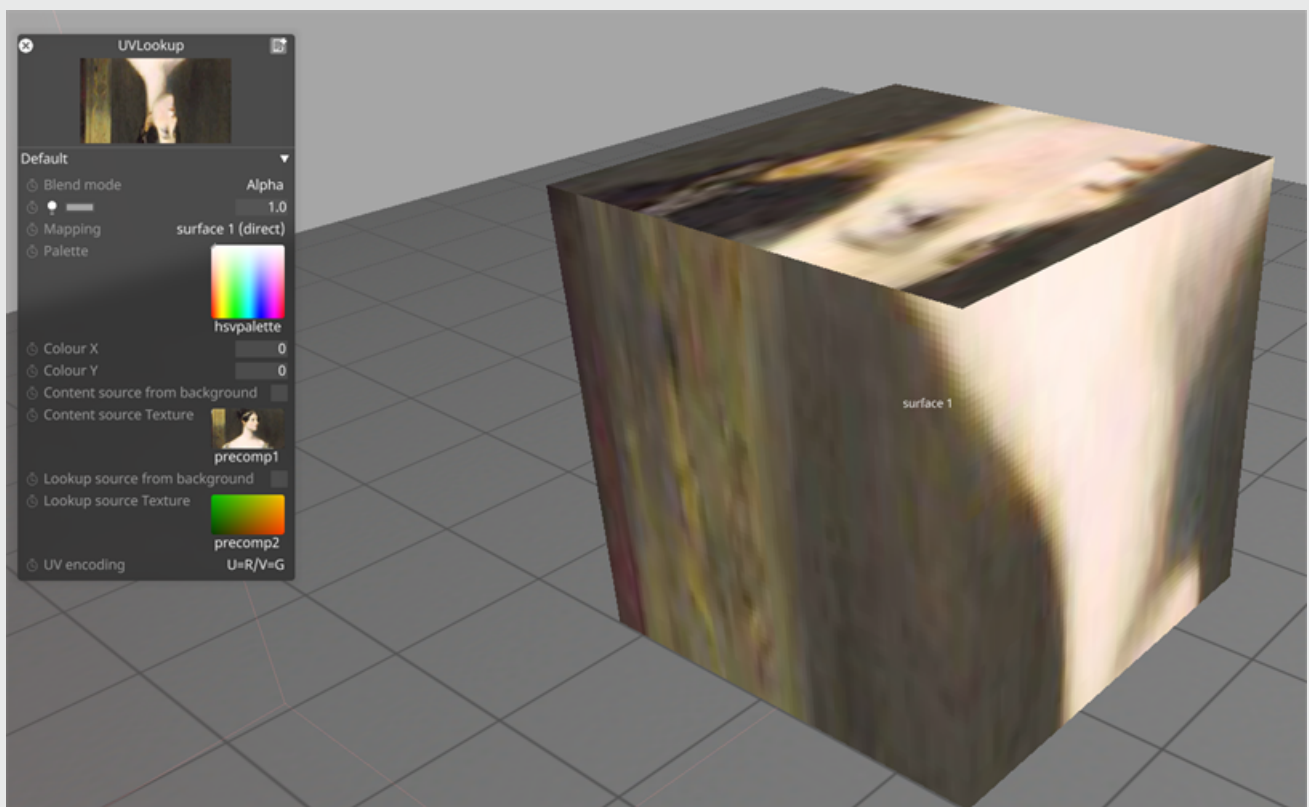

# Common layer properties

## Blend mode

BlendMode controls how the output of the layer is composited with the layers below. Layers are rendered in a bottom-up order: layers at the top can modify the output of the layers below.

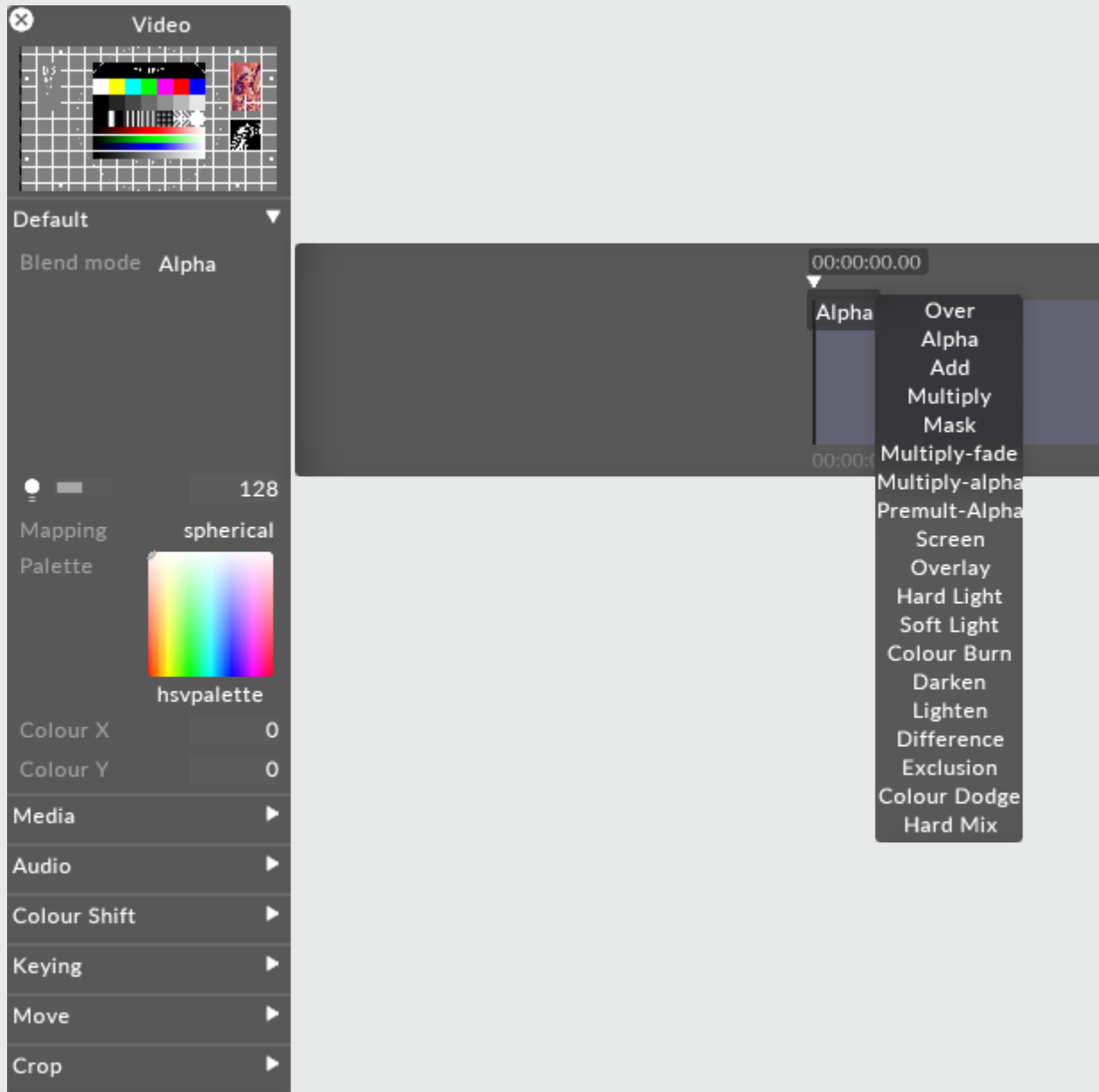

Changing brightness of a content layer in Disguise software is actually controlling the value of the alpha of the layer. Even when displaying a HAP video, the software will composite the layer with a controllable layer of alpha - one per layer.

There are two ways of expressing alpha in an image:

Straight alpha is an alpha channel which functions just like RGB. Alpha acts as a fourth channel of information per pixel which is as independent of the other three as R, G and B are of each other. For example, with straight alpha it is possible to have RGB = 255 (white) and alpha = 0 (fully transparent) on the same pixel. Internally generated content, such as gradient layer, are generated with straight alpha. This is the preferable style of alpha and considering the cleaner method of the two.

Premultiplied alpha takes the alpha and applies it to the values of the RGB channels per pixel. The more transparent something gets with premultiplied alpha, the closer it gets to black - as if the content is sitting on a black table. Premultiplied is the default output of Adobe Photoshop or AfterEffects. The result is our pixel at 255 RGB (full white) with 0 alpha would be calculated as a black pixel in the final image.

Here are explanations of what each individual blend mode will do.

## Over

Makes a layer fully opaque. Premultiplies all alpha onto the RGB value of each pixel. Alpha = black, so adjusting the brightness of a layer in Over blend mode makes it darker.

## Alpha

Default blend mode. It will apply alpha values as a transparency if the alpha is present. Brightness changes will make the layer more or less transparent.

## Add

Adds the value of each RGB pixel together. Always creates a brighter result. Values clamp at 255.

## Multiply

Reads the level of each subpixel as a level between 0.0 and 1.0, and multiplies source with blend. The result is always a darker image overall. For example: white x grey = 0.5. White turns transparent, black takes precedence. Alpha is applied in the same fashion as the Over Blend mode.



## Mask

Choose mask when you want to multiple out content upwards in the stack of layers, rather than downwards. In order to make this work you have to use the same mapping on the layer set to mask and the layer on top.

## Multiply-Fade

The same as Multiply, but will make use of the alpha channel to calculate transparency in the source and blend layers. Since maximum transparency is premultiplied, alpha results in black. This will ignore black created through premultiplying.

## Multiply-Alpha

Multiply with straight alpha. This mode assumes that the alpha has not been premultiplied onto the RGB values and will not apply a correction to the semi-transparent pixels.

## Premultiply Alpha

Like how Multiply-fade will ignore the darkening caused by premultiplying, this blend mode will do the same with Alpha.

## Colour Burn

Blend mode increases the contrast to darken the base colour while reflecting the blend colour. The darker the blend colour, the more intensely the colour will be applied in the base image. White as the blend colour produces no change. Using the colour burn blend mode can produce some harsh results at full opacity.

The colour burn blend mode can be used to make tonal and colour adjustments to a layer.

## Screen

This blend mode looks at each channels colour information and multiplies the inverse of the blend and base colour. The result is always a lighter colour. Screening with black leaves the colour unchanged. Screening with white produces white. The effect is similar to projecting multiple images on top of each other - where bright white is fully opaque, black is fully transparent and 50% grey is 50% transparent.

## Overlay

Multiplies or screens the colours, depending on the base colour. Patterns or colours overlay the existing pixels while preserving the highlights and shadows of the base colour. The base colour is not replaced, but mixed with the blend colour to reflect the lightness or darkness of the original colour.

## Hard Light

Multiplies or screens the colours, depending on the blend colour. The effect is similar to shining a harsh spotlight on the image. If the blend colour (light source/top layer) is lighter than 50% grey, the image is lightened as if it were screened. This is useful for adding highlights to an image. If the blend colour is darker than 50% grey, the image is darkened as if it were multiplied. This is useful for adding shadows to an image. Painting with pure black or white results in pure black or white.

## Soft Light

Darkens or lightens the colours, depending on the blend colour. The effect is similar to shining a diffused spotlight on the image. If the blend colour (light source/top layer) is lighter than 50% grey, the image is lightened as if it were dodged. If the blend colour is darker than 50% grey, the image is darkened as if it were burned in. Painting with pure black or white produces a distinctly darker or lighter area, but does not result in pure black or white.

## Darken

Looks at the colour information in each channel and selects the base or blend colour - whichever is darker - as the result colour. Pixels lighter than the blend colour are replaced and pixels darker than the blend colour do not change.

## Lighten

Looks at the colour information in each channel and selects the base or blend colour - whichever is lighter - as the result colour. Pixels darker than the blend colour are replaced and pixels lighter than the blend colour do not change.

## Difference

Looks at the colour information in each channel and subtracts either the blend colour from the base colour or the base colour from the blend colour depending on which has the greater brightness value.

Blending with white inverts the base colour values and blending with black produces no change.

## Exclusion

Creates an effects similar to but lower in contrast than the difference mode. Blending with white inverts the base colour values. Blending with black produces no change.

## Colour Dodge

Looks at the colour information in each channel and brightens the base colour to reflect the blend colour by decreasing contrast between the two. Blending with black produces no change.

## Hard Mix

Adds the RGB channels of the blend colour to the RGB values of the base colour. If the resulting sum for a channel is 255 or greater, it receives a value of 255; if it is less than 255 it receives a value of 0. Therefore all blended pixels have RGB channels of either 0 or 255. This changes all pixels to primary additive colours (RGB), white or black.

## Brightness

This property (which appears as a light bulb icon) controls the brightness of the layer output.

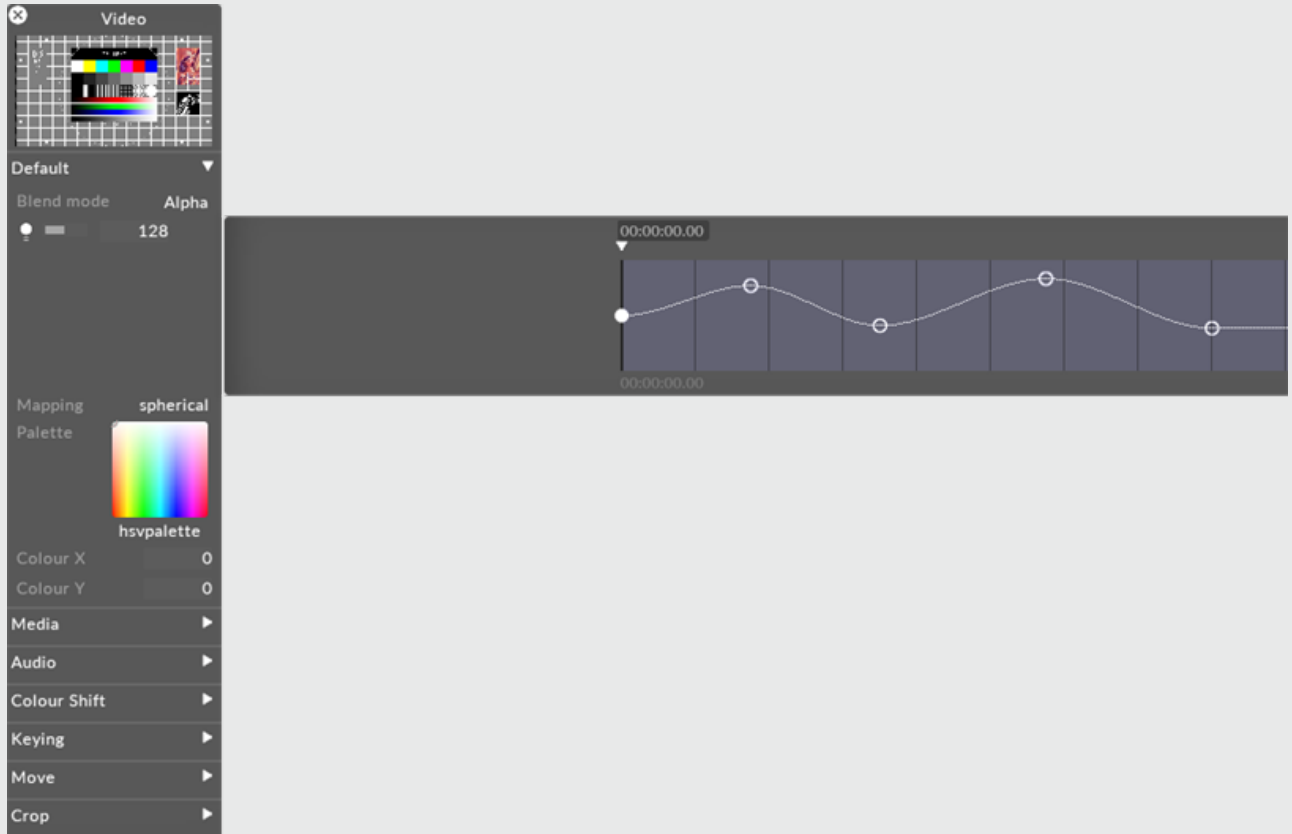

If the layers blend mode is set to Alpha, then reducing the brightness to 0 also reduces the opacity of the layer to 0. This can be useful when you want to dissolve from one layer to the next. In that case, you can place the new layer above the old layer and increase its brightness level.

## Mapping

The mapping property controls how the layer output is mapped onto the screen(s) in the Stage level.

**Video**

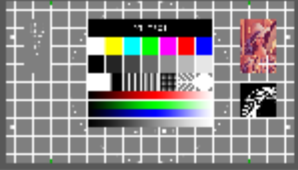

Default ▾

Blend mode Alpha

128

Mapping direct map 1

Palette



hsvpalette

Colour X 0

Colour Y 0

Media ▾

Video



d3\_test\_16-9.png

Speed 1

Mode Normal

At end point Loop

Transition time 0

Audio ▶

Colour Shift ▶

Keying ▶

Move ▶

Crop ▶

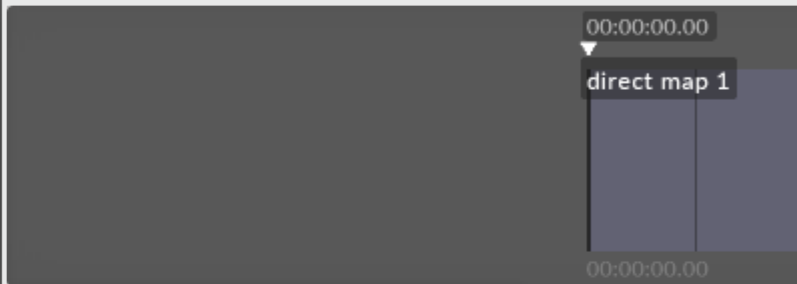

00:00:00.00

direct map 1

00:00:00.00

**mappings**

New mapping: OK Search:

all New Mappings

- direct map 1
- feed map 2
- feed mapping
- mapping 1
- mapping 2
- parallel
- spherical

For information on mapping, including how to use the different mapping types offered by Disguise software, please see the chapter [Content Mapping](#).

## UVLookup layer properties

### Content Source

The texture that is mapped to the object. There are two options:

**Content source from Background**- when enabled, the background is used as the source texture

**Content source Texture**-this can be a texture applied directly in this field or by using an arrow from another content source layer

### Lookup Source

The texture that is to be used as the UV map for the content source. There are two options:

**Lookup source from Background**- when enabled, the background is used as the source texture

**Lookup source Texture**-this can be a texture applied directly in this field or by using an arrow from another content source layer

### UV encoding

The UV mapping coordinates for the RGBA channels in the Lookup source texture.

There are 4 options:

U-R/V=G

U=R/V-B

UV=RGB (Packed)

$$U=RG/V=BA$$

# VideoTransition

The VideoTransition layer is used as a quick and easy way to perform graphical video transitions between two sets of content. For example the transition can be a left to right wipe, or a star wipe. This is very similar functionality to that found on vision mixers.

All Effect layers take their source from other layer types - either content or generative - by use of an arrow. Linking two layers with an arrow defines the arrowed from layer as the source, and the arrowed to layer as the destination. If you have an arrow between a content layer and effect layer, it is said that the content layer is being 'piped in' to the effect layer. For more information on arrows, see the [compositing layers](#) topic.

To draw an arrow between two layers, hold down **ALT** and left click & drag between the source and destination layer.



## VideoTransition File requirements

The transitions will need to be black and white, where video 1 will replace the white, and video 2 will replace the black. **These must be a movie** and **not a still image** like PNG or JPEG. See screenshots here of how an example Video Transition looks using George, Lena and a greyscale Star.



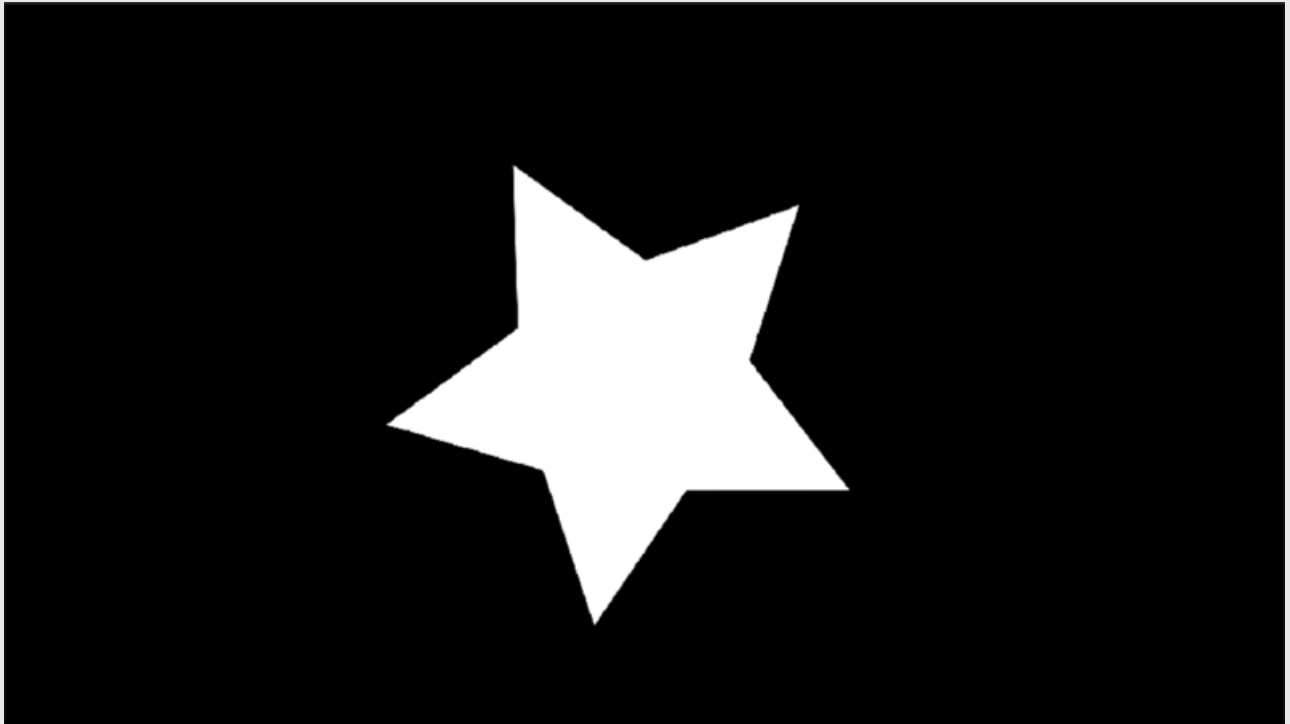

## End Result

After arrowing video layers into the Video Transition Layer, this is the effect produced.

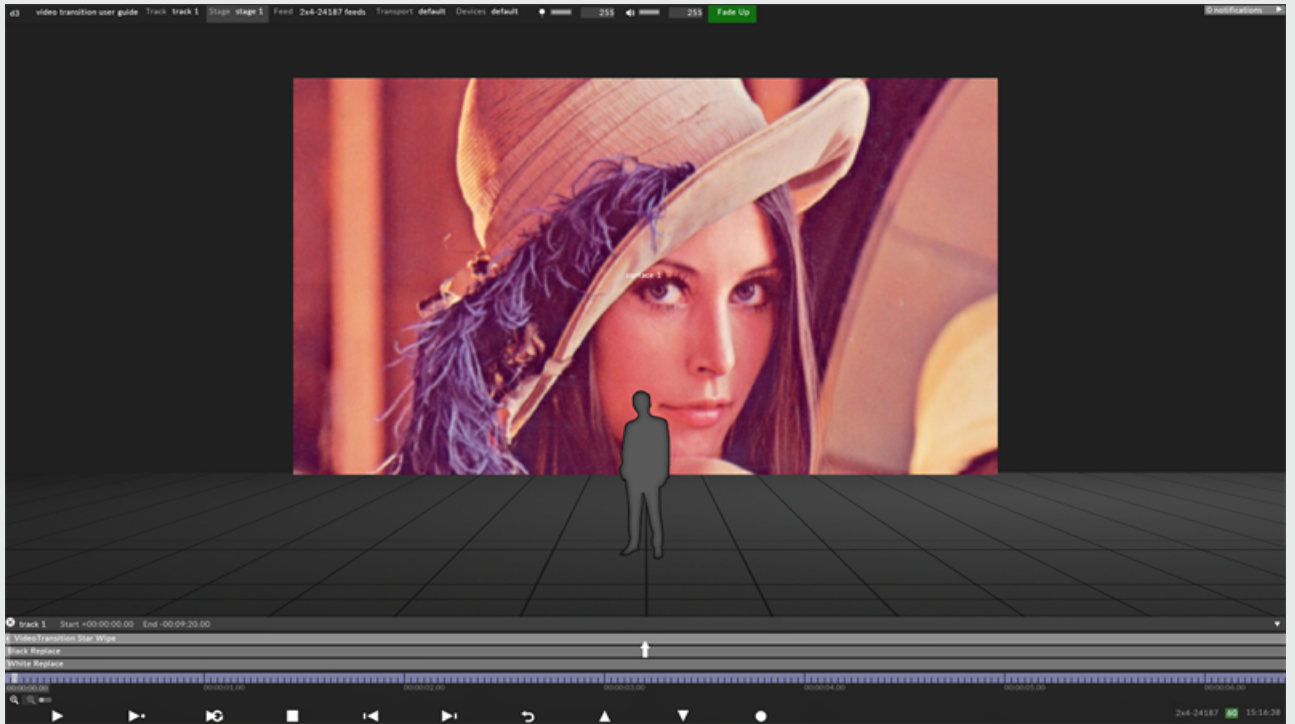

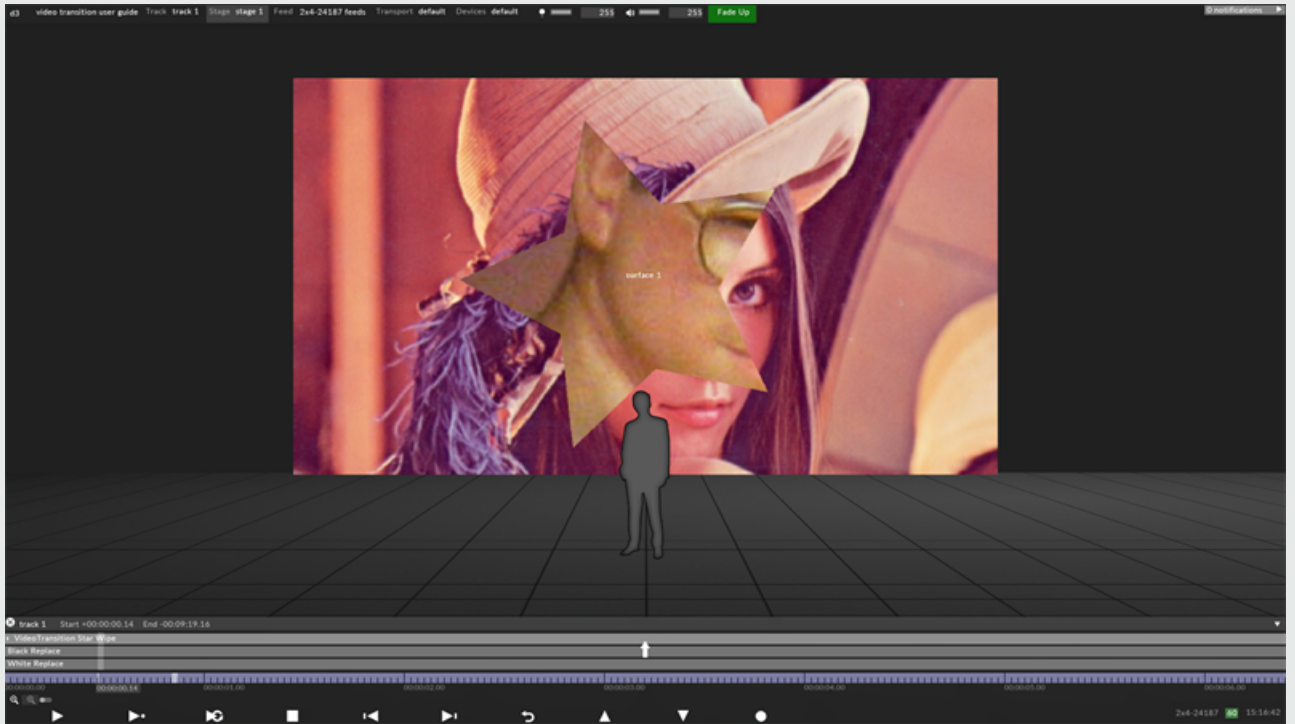



## Preview Thumbnail

This property is a small preview window at the top of the editor showing you what the layer output looks like.



## Blend Mode

BlendMode controls how the output of the layer is composited with the layers below. Layers are rendered in a bottom-up order: layers at the top can modify the output of the layers below.

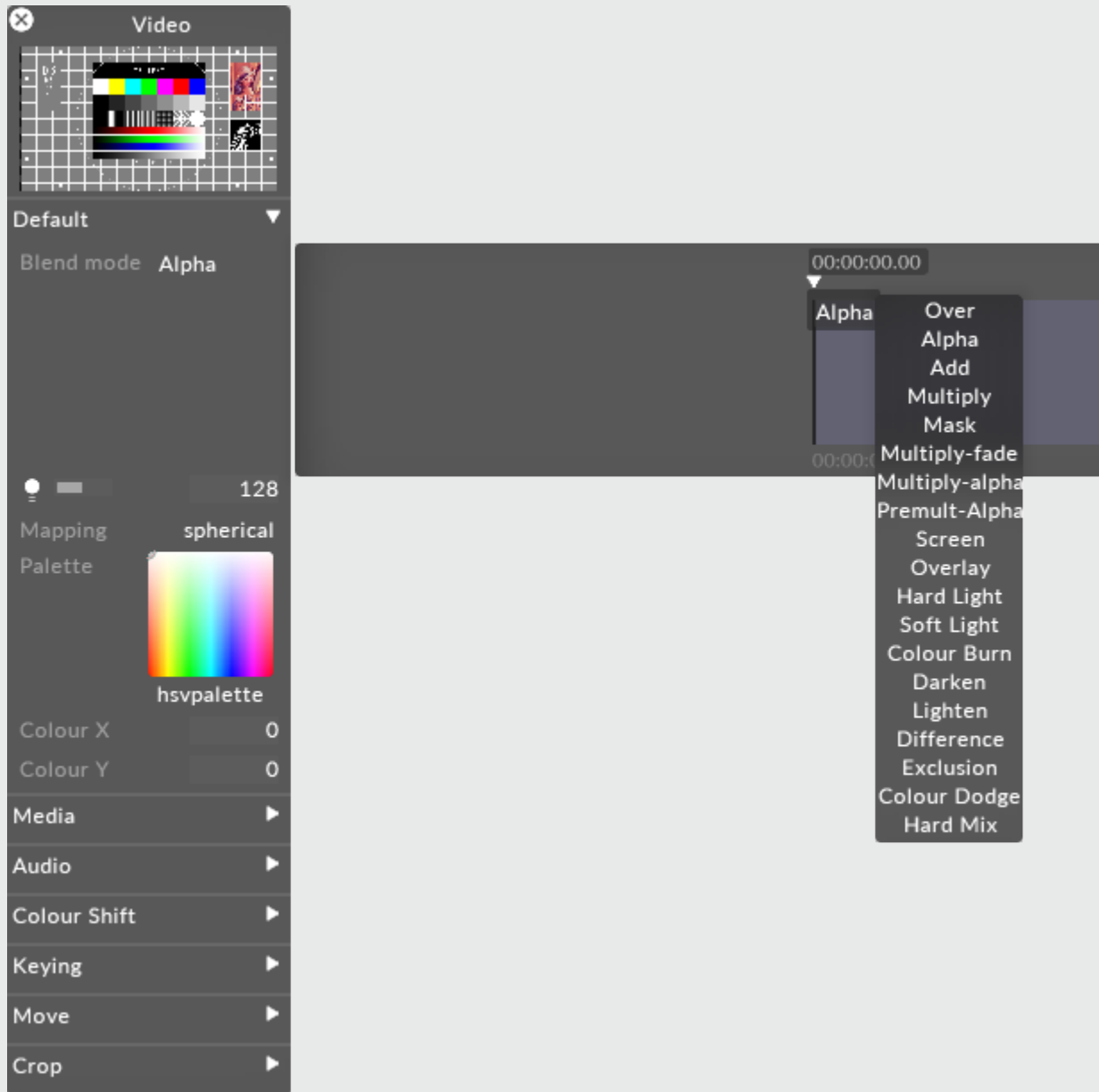

Changing brightness of a content layer in Disguise software is actually controlling the value of the alpha of the layer. Even when displaying a HAP video, the software will composite the layer with a controllable layer of alpha - one per layer.

There are two ways of expressing alpha in an image:

Straight alpha is an alpha channel which functions just like RGB. Alpha acts as a fourth channel of information per pixel which is as independent of the other three as R, G and B are of each other. For example, with straight alpha it is possible to have RGB = 255 (white) and alpha = 0 (fully transparent) on the same pixel. Internally generated content, such as gradient layer, are generated with straight alpha. This is the preferable style of alpha and considering the cleaner method of the two.

Premultiplied alpha takes the alpha and applies it to the values of the RGB channels per pixel. The more transparent something gets with premultiplied alpha, the closer it gets to black - as if the content is sitting on a black table. Premultiplied is the default output of Adobe Photoshop or AfterEffects. The result is our pixel at 255 RGB (full white) with 0 alpha would be calculated as a black pixel in the final image.

Here are explanations of what each individual blend mode will do.

## Over

Makes a layer fully opaque. Premultiplies all alpha onto the RGB value of each pixel. Alpha = black, so adjusting the brightness of a layer in Over blend mode makes it darker.

## Alpha

Default blend mode. It will apply alpha values as a transparency if the alpha is present. Brightness changes will make the layer more or less transparent.

## Add

Adds the value of each RGB pixel together. Always creates a brighter result. Values clamp at 255.

## Multiply

Reads the level of each subpixel as a level between 0.0 and 1.0, and multiplies source with blend. The result is always a darker image overall. For example: white x grey = 0.5. White turns transparent, black takes precedence. Alpha is applied in the same fashion as the Over Blend mode.

## Mask

Choose mask when you want to multiple out content upwards in the stack of layers, rather than downwards. In order to make this work you have to use the same mapping on the layer set to mask and the layer on top.

## Multiply-Fade

The same as Multiply, but will make use of the alpha channel to calculate transparency in the source and blend layers. Since maximum transparency is premultiplied, alpha results in black. This will ignore black created through premultiplying.

## Multiply-Alpha

Multiply with straight alpha. This mode assumes that the alpha has not been premultiplied onto the RGB values and will not apply a correction to the semi-transparent pixels.

## Premultiply Alpha

Like how Multiply-fade will ignore the darkening caused by premultiplying, this blend mode will do the same with Alpha.

## Colour Burn

Blend mode increases the contrast to darken the base colour while reflecting the blend colour. The darker the blend colour, the more intensely the colour will be applied in the base image. White as the blend colour produces no change. Using the colour burn blend mode can produce some harsh results at full opacity.

The colour burn blend mode can be used to make tonal and colour adjustments to a layer.

## Screen

This blend mode looks at each channels colour information and multiplies the inverse of the blend and base colour. The result is always a lighter colour. Screening with black leaves the colour unchanged. Screening with white produces white. The effect is similar to projecting multiple images on top of each other - where bright white is fully opaque, black is fully transparent and 50% grey is 50% transparent.



## Overlay

Multiplies or screens the colours, depending on the base colour. Patterns or colours overlay the existing pixels while preserving the highlights and shadows of the base colour. The base colour is not replaced, but mixed with the blend colour to reflect the lightness or darkness of the original colour.

## Hard Light

Multiplies or screens the colours, depending on the blend colour. The effect is similar to shining a harsh spotlight on the image. If the blend colour (light source/top layer) is lighter than 50% grey, the image is lightened as if it were screened. This is useful for adding highlights to an image. If the blend colour is darker than 50% grey, the image is darkened as if it were multiplied. This is useful for adding shadows to an image. Painting with pure black or white results in pure black or white.

## Soft Light

Darkens or lightens the colours, depending on the blend colour. The effect is similar to shining a diffused spotlight on the image. If the blend colour (light source/top layer) is lighter than 50% grey, the image is lightened as if it were dodged. If the blend colour is darker than 50% grey, the image is darkened as if it were burned in. Painting with pure black or white produces a distinctly darker or lighter area, but does not result in pure black or white.

## Darken

Looks at the colour information in each channel and selects the base or blend colour - whichever is darker - as the result colour. Pixels lighter than the blend colour are replaced and pixels darker than the blend colour do not change.

## Lighten

Looks at the colour information in each channel and selects the base or blend colour - whichever is lighter - as the result colour. Pixels darker than the blend colour are replaced and pixels lighter than the blend colour do not change.

## Difference

Looks at the colour information in each channel and subtracts either the blend colour from the base colour or the base colour from the blend colour depending on which has the greater brightness value.

Blending with white inverts the base colour values and blending with black produces no change.

## Exclusion

Creates an effects similar to but lower in contrast than the difference mode. Blending with white inverts the base colour values. Blending with black produces no change.

## Colour Dodge

Looks at the colour information in each channel and brightens the base colour to reflect the blend colour by decreasing contrast between the two. Blending with black produces no change.

## Hard Mix

Adds the RGB channels of the blend colour to the RGB values of the base colour. If the resulting sum for a channel is 255 or greater, it receives a value of 255; if it is less than 255 it receives a value of 0. Therefore all blended pixels have RGB channels of either 0 or 255. This changes all pixels to primary additive colours (RGB), white or black.

## Brightness

This property (which appears as a light bulb icon) controls the brightness of the layer output.

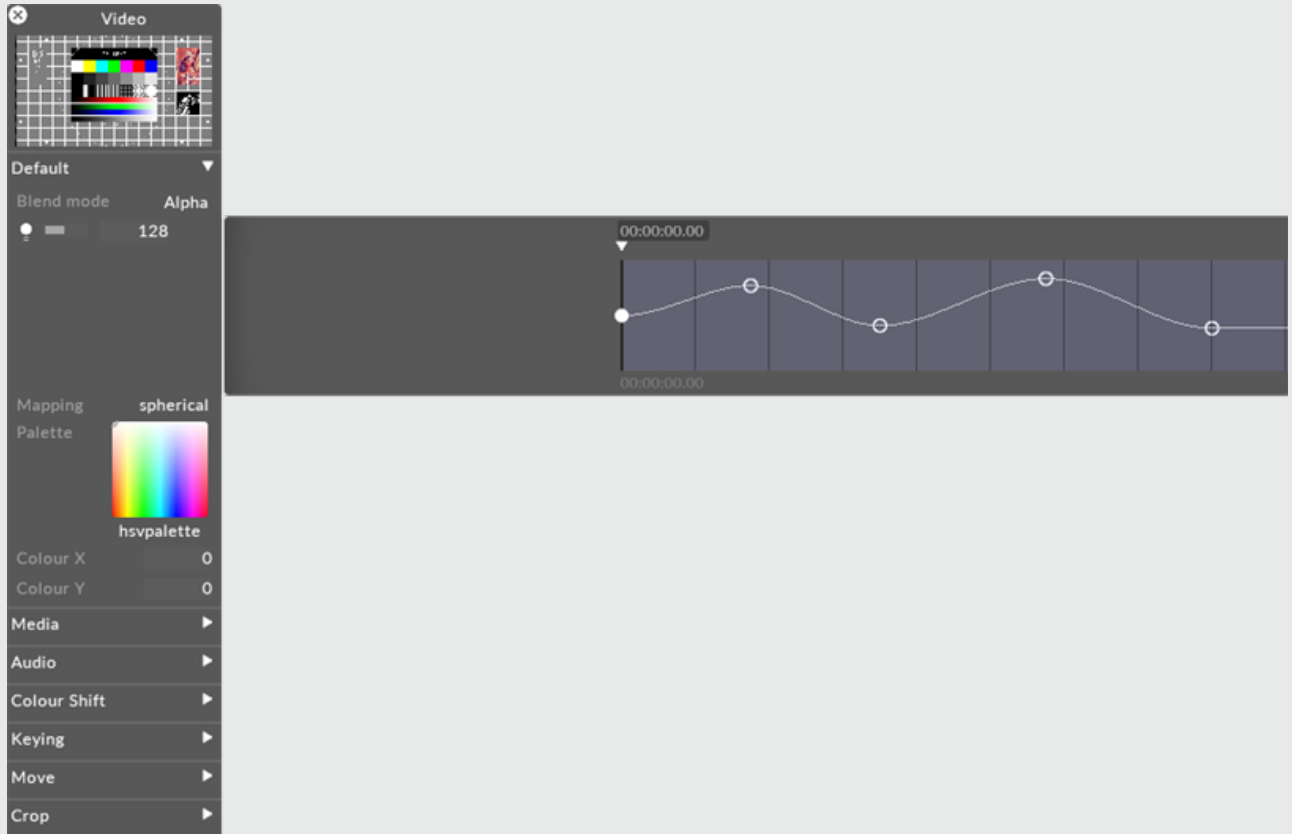

If the layers blend mode is set to Alpha, then reducing the brightness to 0 also reduces the opacity of the layer to 0. This can be useful when you want to dissolve from one layer to the next. In that case, you can place the new layer above the old layer and increase its brightness level.

## Mapping

The mapping property controls how the layer output is mapped onto the screen(s) in the Stage level.

**Video**

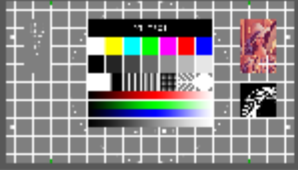

Default ▾

Blend mode Alpha

128

Mapping direct map 1

Palette



hsvpalette

Colour X 0

Colour Y 0

Media ▾

Video



d3\_test\_16-9.png

Speed 1

Mode Normal

At end point Loop

Transition time 0

Audio ▶

Colour Shift ▶

Keying ▶

Move ▶

Crop ▶

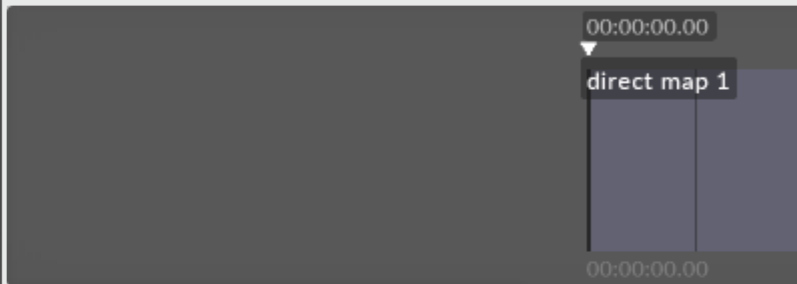

**mappings**

New mapping: OK Search:

all New Mappings

- direct map 1
- feed map 2
- feed mapping
- mapping 1
- mapping 2
- parallel
- spherical

For information on mapping, including how to use the different mapping types offered by Disguise software, please see the chapter [Content Mapping](#).

## Palette

This points to the still image file that defines the bitmap from which the tint colour is taken. The default palette ( HSVPAL ) consists of the complete range of hues and saturations. Selecting this property will open the Texture object library, which shows all of the still image files saved on your local hard-drive in the **DxTexture** folder.

To control the location within the current palette bitmap, and thus control the colour, you have to edit the **xCol** and **yCol** values (see the section for xCol, yCol).

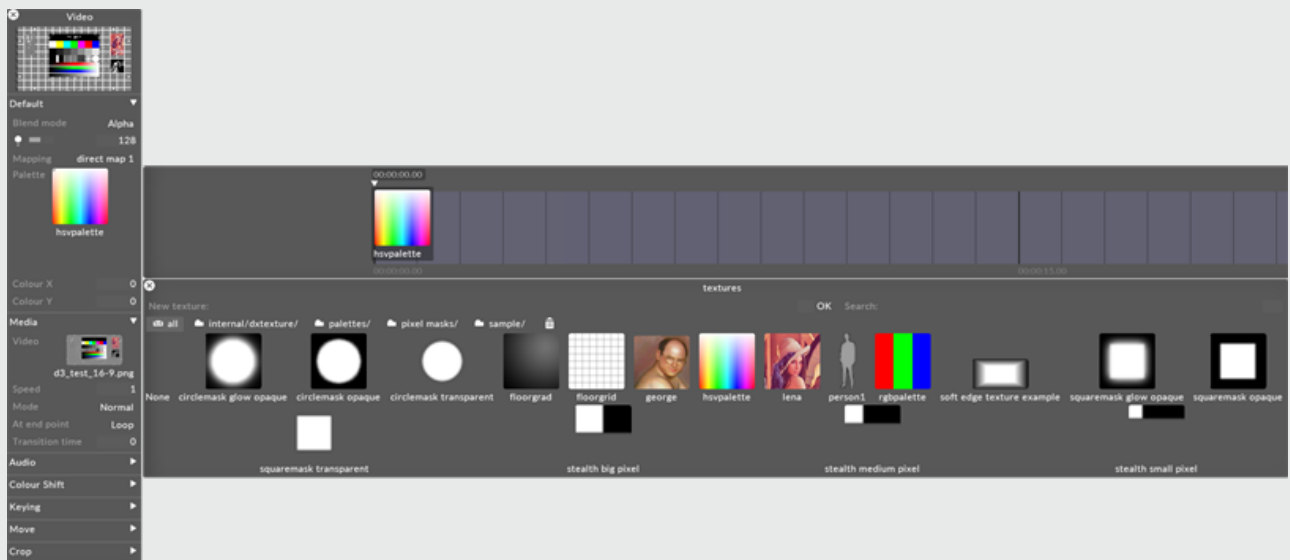

To change the current palette bitmap:

1. Left-click **palette** to open the Texture object library.
2. Left-click the still image file you want to use for the palette bitmap.

If you want to use a palette bitmap other than the standard still images provided in Disguise software, you will need to use a custom still image file.

See the [Placing media files for a project](#) sub-chapter to understand where to place a custom still image file and how to access it in Disguise software. Also save the file to a [supported file format](#).

## xCol, yCol

These properties control the coordinates within the current palette bitmap where the output colour is sampled from. The default value is 0,0 which points at the color white (if you are using the HSVPAL palette). Multiplying white with the colors of the chosen content simply generates the original content colors. **Colour X** controls the horizontal position, where 0 is the leftmost edge and 255 is the rightmost edge. **Colour Y** controls the vertical position, where 0 is the top edge and 255 is the bottom edge.

For example, to saturate the video clip red, change the **Colour Y** value to 255 and use 0 for the **Colour X** value. These coordinates refer to the color red in the palette which is being multiplied with the colors of the existing content.

When you are using the default palette HSVPAL , **Colour Y** controls saturation, and **Colour X** controls hue.

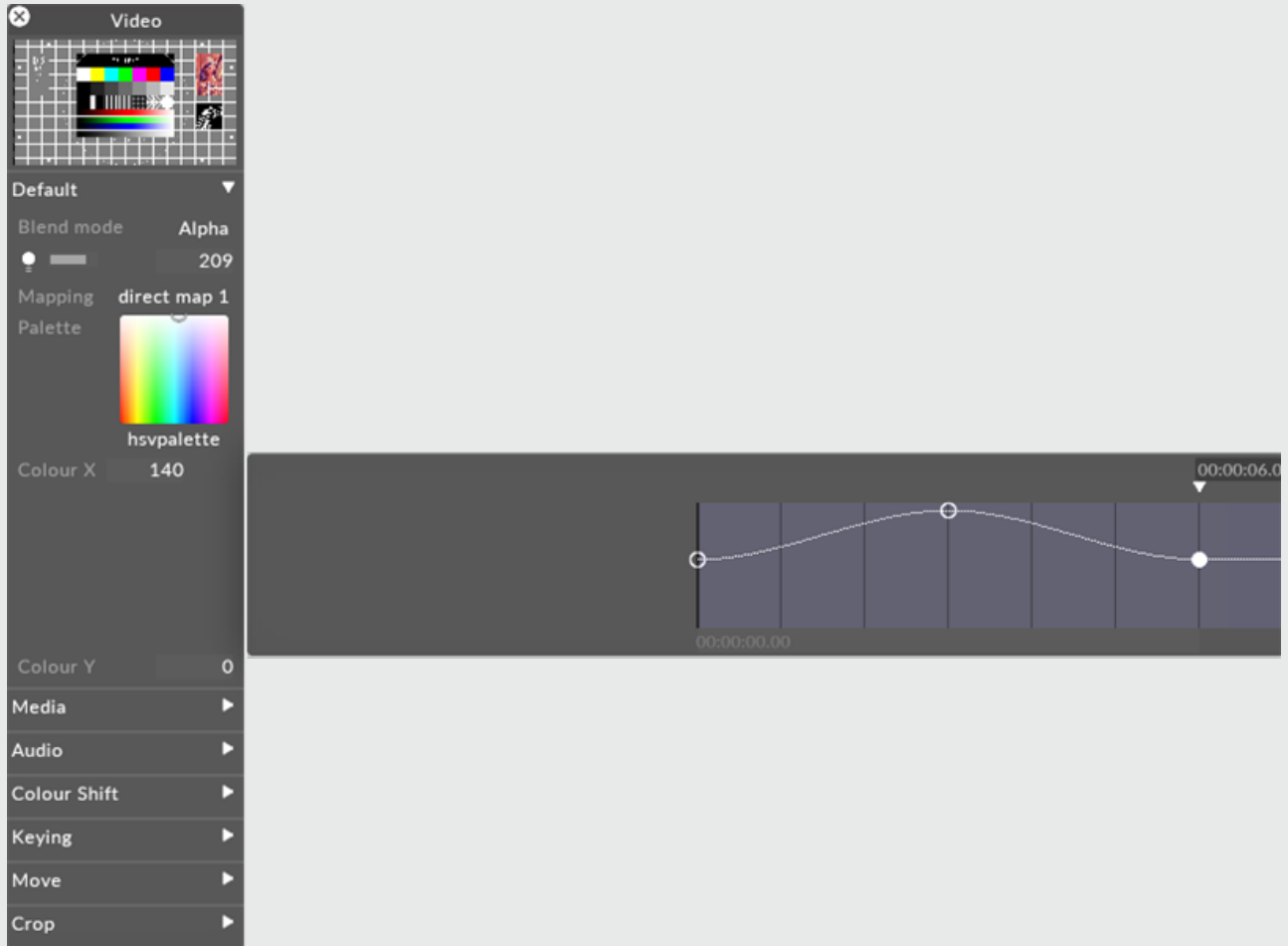

## Colour Shift

The colour shift property allows you to perform a number of colour-correction operations on the output of a layer.

Colour Shift objects can also be attached to individual video files within the Video layer.

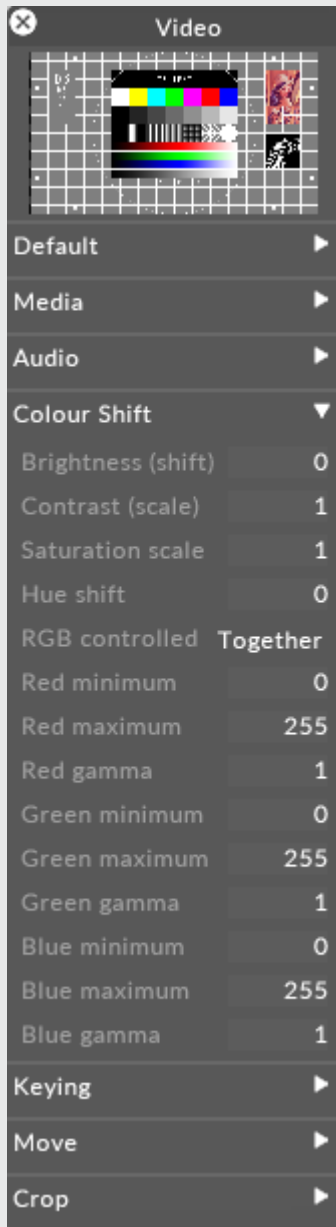

Colour Shift property performs colour-corrections on the output of a visual layer

Colour Shift properties are:



# Saturation scale

When set to 1, no change is applied to the image. When set to 0, the image is desaturated to black and white. When set higher than 1, the image is hypersaturated.

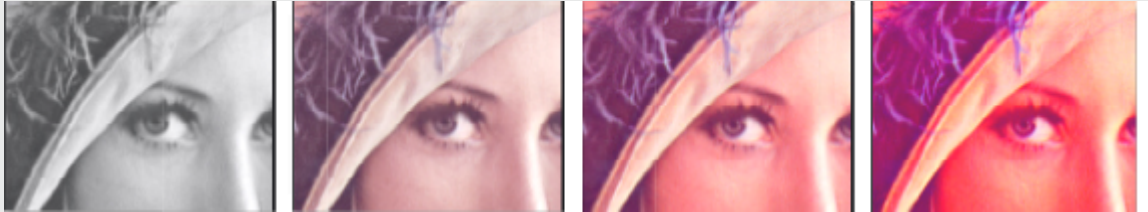

Saturation scale (from left to right):  $s=0$ ,  $s=0.5$ ,  $s=1$ ,  $s=2$

## Hue shift

### RGB controlled

This property controls how the min/max levels and gamma corrections are applied. If set to *together*, then the min, max and gamma values are the same for the red, green and blue channels. If set to *separate*, the min,max and gamma values can be controlled separately for red, green and blue. The latter setting allows you to apply fine colour balance controls to the image.

### Min

This sets the lowest brightness level found in the image. All pixels at this level are scaled down to zero brightness. Increasing this value enforces shadows and dark levels in the image and can be used to reduce low-level compression artifacts in an image or video frame.

Increasing *min* equally across red, green and blue enforces shadows, whereas increasing *min* on an individual channel has the effect of shifting the colour balance away from that colour. For example, increasing *red min* shifts the image towards cyan.

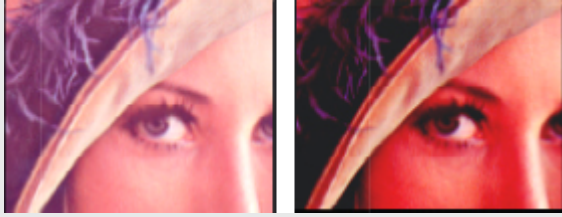

min = 00 (left), min = 96 (right)

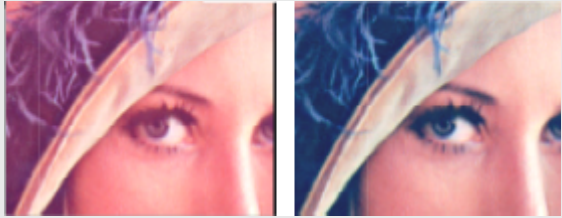

red.min = 0 (left), red.min = 96 (right)

## Max

This sets the highest brightness level found in the image. All pixels at this level are scaled up to the maximum level, i.e. 255. Decreasing this value brightens any highlights in the image. This is useful when the source image is too dark.

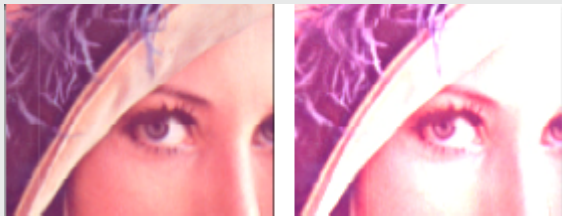

max = 255 (left), max = 260 (right)

If you set min to 255 and max to 0, the image (or single channel) will be inverted.

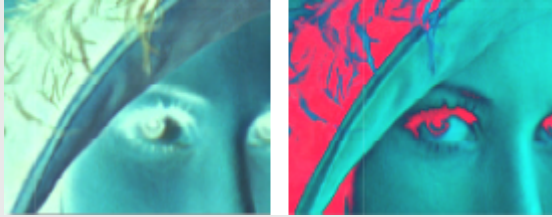

Invert all (left), invert red (right)

## Gamma

When *gamma* is set to 1, no change is made to the image. Reducing gamma brightens highlights while increasing gamma darkens lowlights. The maximum and minimum brightness levels remain the same.

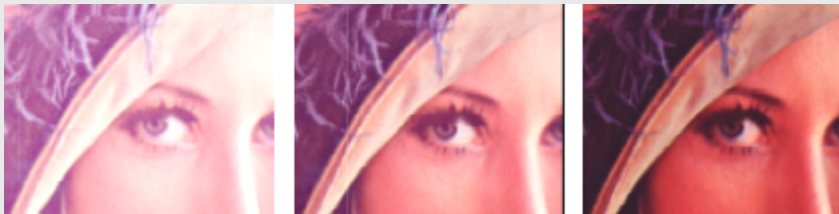

Gamma scale (from left to right):  $g=0.5$ ,  $g=1$ ,  $g=1.5$

## Example

1. Firstly create two video layers and populate them with content. This can be any valid video file including the Video Input.
2. Then add a **VideoTransition** layer above the two video modules. Next hold down the **Alt** key and click on what video is replacing the Black of the video Transition, and drag that arrow to the Video Transition layer. Likewise do the same for the video replacing the White part.
3. Next add your Video Transition Video into the Video Transition Layer.

4. If you hit play you will see your desired effect. Here is an image of the Layers used and how they are populated.

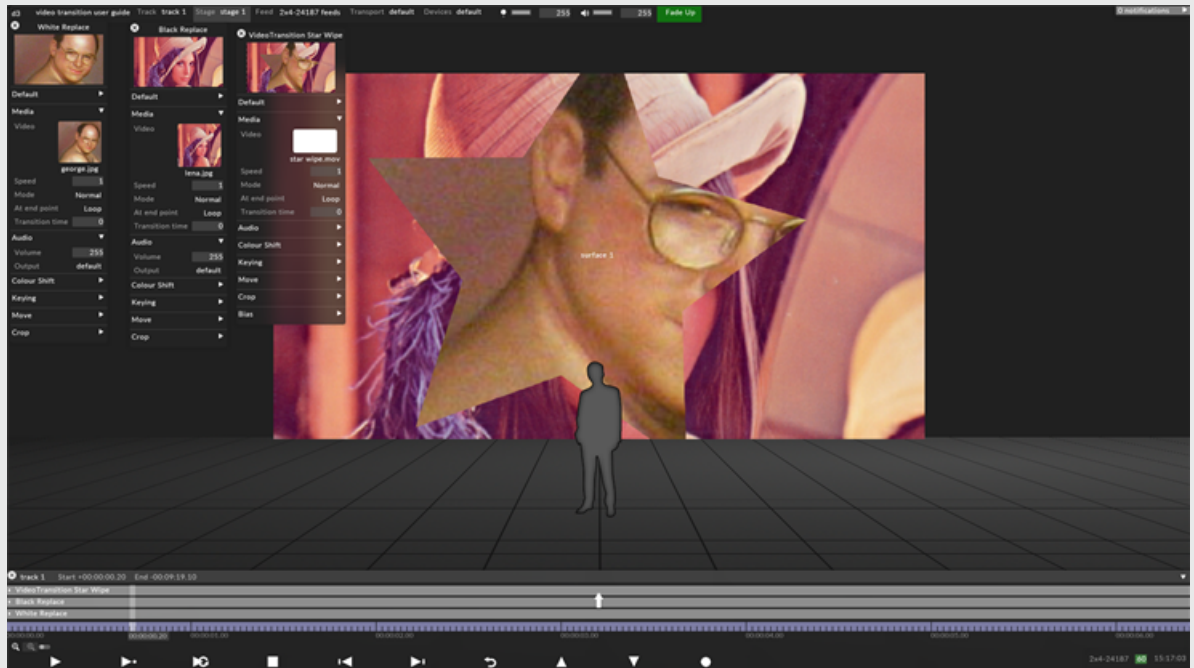

If you would like to reverse the Black and White of the Video Transition then simply go into the 'Colour Shift' drop down of the Layer and swap the RGB Maximum and Minimum values, so that the Minimum is now 255 and Maximum is 0.

# Generative Layers

Disguise software has several types of layers that can be used to generate content in real-time known as Generative layers.

## Types of Generative Layers

- [Bugs](#)
- [Chevron](#)
- [Colour](#)
- [Gradient](#)
- [Notch](#)
- [Radar](#)
- [RGBColour](#)
- [Readout](#)
- [Scan](#)
- [Strobe](#)
- [Tennis](#)
- [TestPattern](#)
- [Text](#)
- [TrackingMarker](#)

# Bugs

The Bugs layer is a simple generative layer that simulates a number of bugs.

A bug is a block of colour that moves across the canvas, leaving behind a fading trail of blocks. With each step, the bug may decide to change its direction or continue in the same direction.

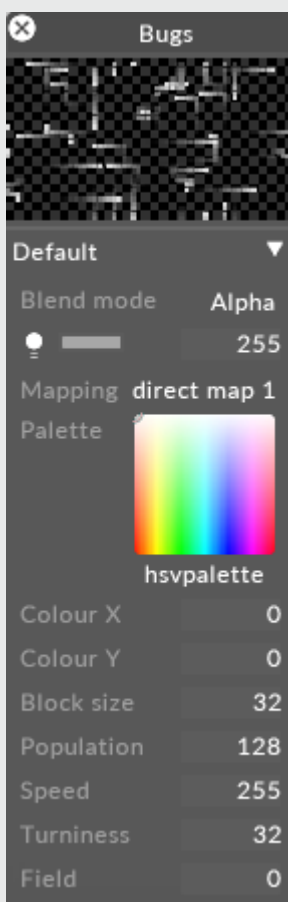

# Preview Thumbnail

This property is a small preview window at the top of the editor showing you what the layer output looks like.

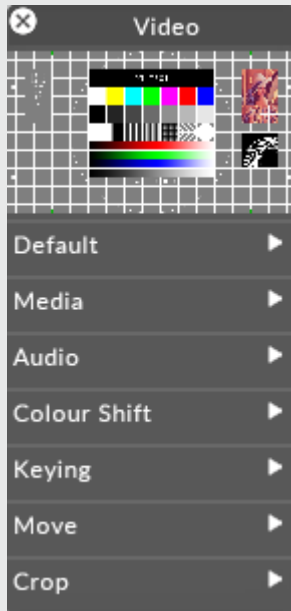

# Blend Mode

BlendMode controls how the output of the layer is composited with the layers below. Layers are rendered in a bottom-up order: layers at the top can modify the output of the layers below.

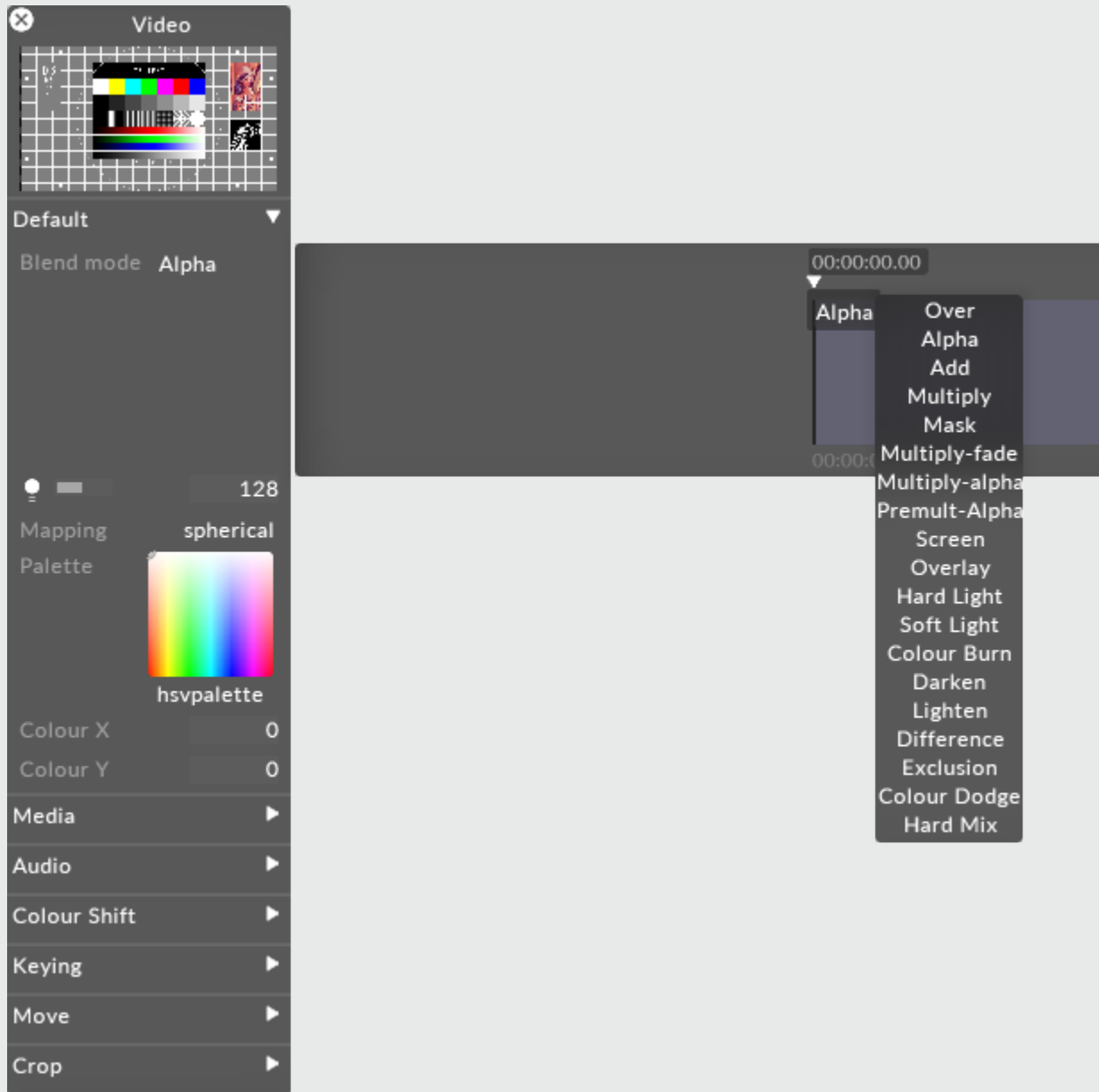

Changing brightness of a content layer in Disguise software is actually controlling the value of the alpha of the layer. Even when displaying a HAP video, the software will composite the layer with a controllable layer of alpha - one per layer.



There are two ways of expressing alpha in an image:

Straight alpha is an alpha channel which functions just like RGB. Alpha acts as a fourth channel of information per pixel which is as independent of the other three as R, G and B are of each other. For example, with straight alpha it is possible to have RGB = 255 (white) and alpha = 0 (fully transparent) on the same pixel. Internally generated content, such as gradient layer, are generated with straight alpha. This is the preferable style of alpha and considering the cleaner method of the two.

Premultiplied alpha takes the alpha and applies it to the values of the RGB channels per pixel. The more transparent something gets with premultiplied alpha, the closer it gets to black - as if the content is sitting on a black table. Premultiplied is the default output of Adobe Photoshop or AfterEffects. The result is our pixel at 255 RGB (full white) with 0 alpha would be calculated as a black pixel in the final image.

Here are explanations of what each individual blend mode will do.

## Over

Makes a layer fully opaque. Premultiplies all alpha onto the RGB value of each pixel. Alpha = black, so adjusting the brightness of a layer in Over blend mode makes it darker.

## Alpha

Default blend mode. It will apply alpha values as a transparency if the alpha is present. Brightness changes will make the layer more or less transparent.

## Add

Adds the value of each RGB pixel together. Always creates a brighter result. Values clamp at 255.

## Multiply

Reads the level of each subpixel as a level between 0.0 and 1.0, and multiplies source with blend. The result is always a darker image overall. For example: white x grey = 0.5. White turns transparent, black takes precedence. Alpha is applied in the same fashion as the Over Blend mode.

## Mask

Choose mask when you want to multiply out content upwards in the stack of layers, rather than downwards. In order to make this work you have to use the same mapping on the layer set to mask and the layer on top.

## Multiply-Fade

The same as Multiply, but will make use of the alpha channel to calculate transparency in the source and blend layers. Since maximum transparency is premultiplied, alpha results in black. This will ignore black created through premultiplying.

## Multiply-Alpha

Multiply with straight alpha. This mode assumes that the alpha has not been premultiplied onto the RGB values and will not apply a correction to the semi-transparent pixels.

## Premultiply Alpha

Like how Multiply-fade will ignore the darkening caused by premultiplying, this blend mode will do the same with Alpha.

## Colour Burn

Blend mode increases the contrast to darken the base colour while reflecting the blend colour. The darker the blend colour, the more intensely the colour will be applied in the base image. White as the blend colour produces no change. Using the colour burn blend mode can produce some harsh results at full opacity.

The colour burn blend mode can be used to make tonal and colour adjustments to a layer.

## Screen

This blend mode looks at each channels colour information and multiplies the inverse of the blend and base colour. The result is always a lighter colour. Screening with black leaves the colour unchanged. Screening with white produces white. The effect is similar to projecting multiple images on top of each other - where bright white is fully opaque, black is fully transparent and 50% grey is 50% transparent.

## Overlay

Multiplies or screens the colours, depending on the base colour. Patterns or colours overlay the existing pixels while preserving the highlights and shadows of the base colour. The base colour is not replaced, but mixed with the blend colour to reflect the lightness or darkness of the original colour.

## Hard Light

Multiplies or screens the colours, depending on the blend colour. The effect is similar to shining a harsh spotlight on the image. If the blend colour (light source/top layer) is lighter than 50% grey, the image is lightened as if it were screened. This is useful for adding highlights to an image. If the blend colour is darker than 50% grey, the image is darkened as if it were multiplied. This is useful for adding shadows to an image. Painting with pure black or white results in pure black or white.

## Soft Light

Darkens or lightens the colours, depending on the blend colour. The effect is similar to shining a diffused spotlight on the image. If the blend colour (light source/top layer) is lighter than 50% grey, the image is lightened as if it were dodged. If the blend colour is darker than 50% grey, the image is darkened as if it were burned in. Painting with pure black or white produces a distinctly darker or lighter area, but does not result in pure black or white.

## Darken

Looks at the colour information in each channel and selects the base or blend colour - whichever is darker - as the result colour. Pixels lighter than the blend colour are replaced and pixels darker than the blend colour do not change.

## Lighten

Looks at the colour information in each channel and selects the base or blend colour - whichever is lighter - as the result colour. Pixels darker than the blend colour are replaced and pixels lighter than the blend colour do not change.

## Difference

Looks at the colour information in each channel and subtracts either the blend colour from the base colour or the base colour from the blend colour depending on which has the greater brightness value.

Blending with white inverts the base colour values and blending with black produces no change.

## Exclusion

Creates an effects similar to but lower in contrast than the difference mode. Blending with white inverts the base colour values. Blending with black produces no change.

## Colour Dodge

Looks at the colour information in each channel and brightens the base colour to reflect the blend colour by decreasing contrast between the two. Blending with black produces no change.

## Hard Mix

Adds the RGB channels of the blend colour to the RGB values of the base colour. If the resulting sum for a channel is 255 or greater, it receives a value of 255; if it is less than 255 it receives a value of 0. Therefore all blended pixels have RGB channels of either 0 or 255. This changes all pixels to primary additive colours (RGB), white or black.

## Brightness

This property (which appears as a light bulb icon) controls the brightness of the layer output.

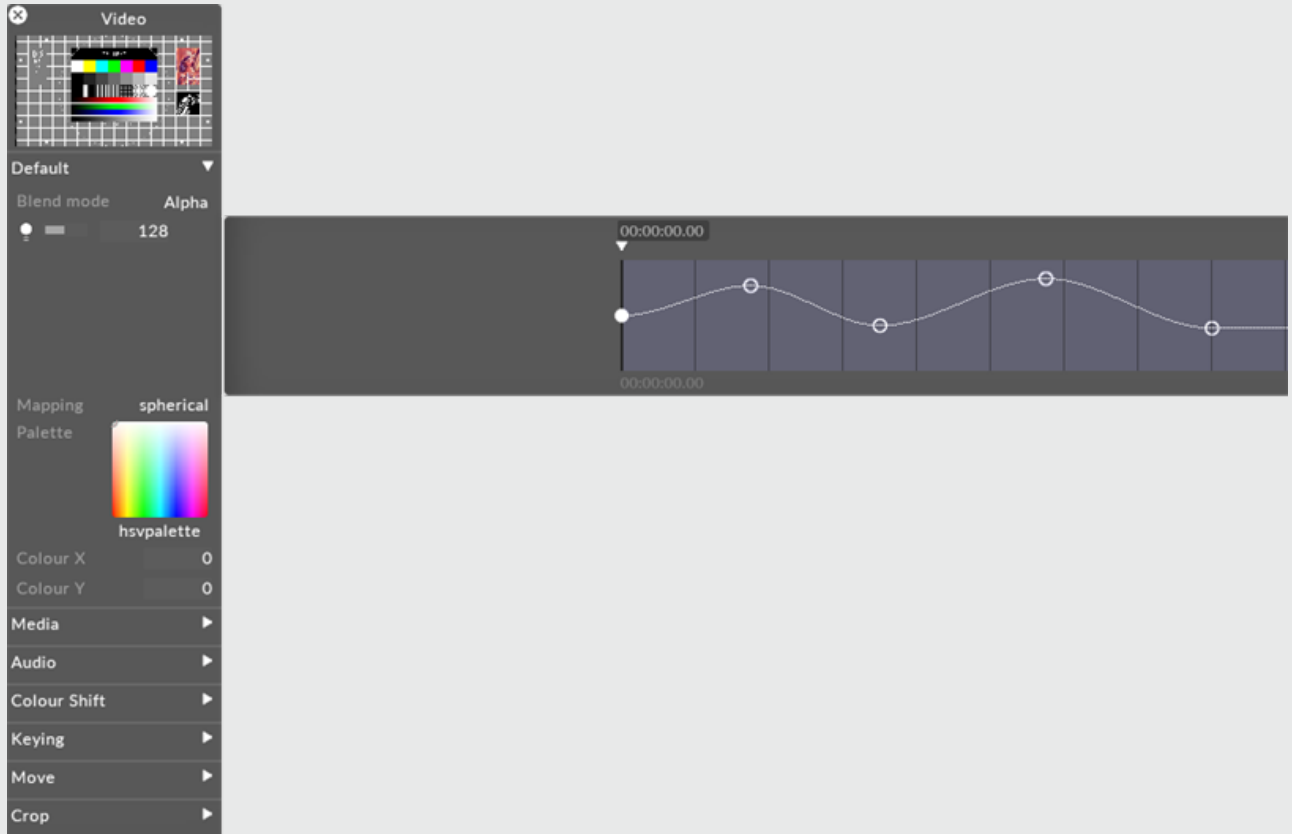

If the layers blend mode is set to Alpha, then reducing the brightness to 0 also reduces the opacity of the layer to 0. This can be useful when you want to dissolve from one layer to the next. In that case, you can place the new layer above the old layer and increase its brightness level.

## Mapping

The mapping property controls how the layer output is mapped onto the screen(s) in the Stage level.

**Video**

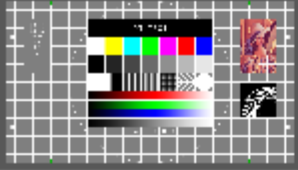

Default ▾

Blend mode Alpha

128

Mapping direct map 1

Palette



hsvpalette

Colour X 0

Colour Y 0

Media ▾

Video



d3\_test\_16-9.png

Speed 1

Mode Normal

At end point Loop

Transition time 0

Audio ▶

Colour Shift ▶

Keying ▶

Move ▶

Crop ▶



**mappings**

New mapping: OK Search:

all New Mappings

- direct map 1
- feed map 2
- feed mapping
- mapping 1
- mapping 2
- parallel
- spherical

For information on mapping, including how to use the different mapping types offered by Disguise software, please see the chapter [Content Mapping](#).

## Palette

This points to the still image file that defines the bitmap from which the tint colour is taken. The default palette ( HSVPAL ) consists of the complete range of hues and saturations. Selecting this property will open the Texture object library, which shows all of the still image files saved on your local hard-drive in the **DxTexture** folder.

To control the location within the current palette bitmap, and thus control the colour, you have to edit the **xCol** and **yCol** values (see the section for xCol, yCol).

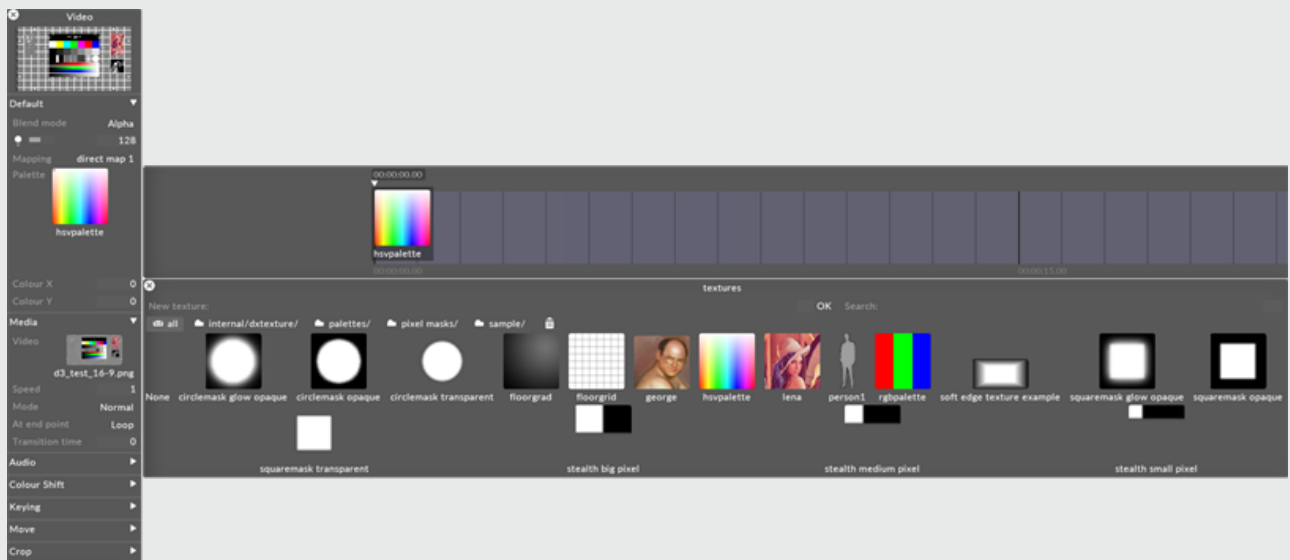

To change the current palette bitmap:

1. Left-click **palette** to open the Texture object library.
2. Left-click the still image file you want to use for the palette bitmap.

If you want to use a palette bitmap other than the standard still images provided in Disguise software, you will need to use a custom still image file.

See the [Placing media files for a project](#) sub-chapter to understand where to place a custom still image file and how to access it in Disguise software. Also save the file to a [supported file format](#).

## xCol y Col

These properties control the coordinates within the current palette bitmap where the output colour is sampled from. The default value is 0,0 which points at the color white (if you are using the HSVPAL palette). Multiplying white with the colors of the chosen content simply generates the original content colors. **Colour X** controls the horizontal position, where 0 is the leftmost edge and 255 is the rightmost edge. **Colour Y** controls the vertical position, where 0 is the top edge and 255 is the bottom edge.

For example, to saturate the video clip red, change the **Colour Y** value to 255 and use 0 for the **Colour X** value. These coordinates refer to the color red in the palette which is being multiplied with the colors of the existing content.

When you are using the default palette HSVPAL , **Colour Y** controls saturation, and **Colour X** controls hue.



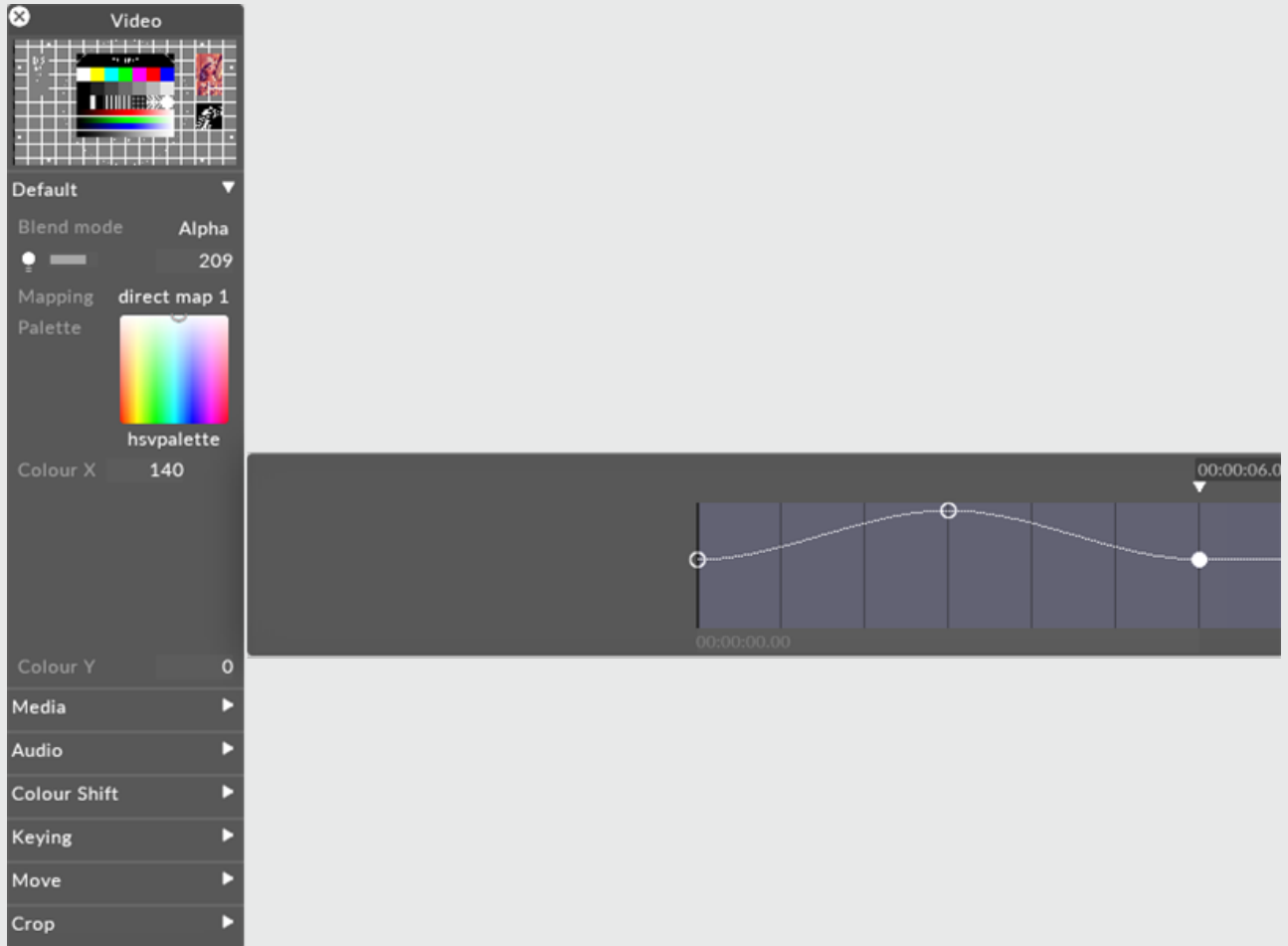

## Block size

This controls the size of each bug, in pixels. When the block size is higher than 1, a one pixel black border is drawn around each bugs square. The smaller the size, the finer the pattern generated.

## Population

This controls the number of bugs. When set to 255, the maximum number of bugs is drawn.

# Speed

This controls how many times per beat the bugs update their position.

# Turniness

This controls the ability of each bug to change direction at each step. When set to the minimum value 0, the bugs will move in straight lines and never change direction; when set to the maximum value 255, the bugs will turn at every opportunity.

# Field

This controls the number of directions the bugs can choose from. The min/ max Field values are 0 and 9. Different Field values control the directions the bugs move in in different ways.

The following Field values cause the bugs to move in the following directions:

**0** : horizontally right and left + vertically up and down

**1** : horizontally right and left

**2** : vertically up and down

**3** : diagonally up and down

**4** : diagonally down into horizontal right and left

**5** : vertically up

**6** : vertically down

**7** : horizontally right

**8-9** : horizontally left

# Chevron

Sooner or later, everybody needs chevrons. Recognising this fact of life, Disguise software includes a Chevron layer for all of your chevron needs.

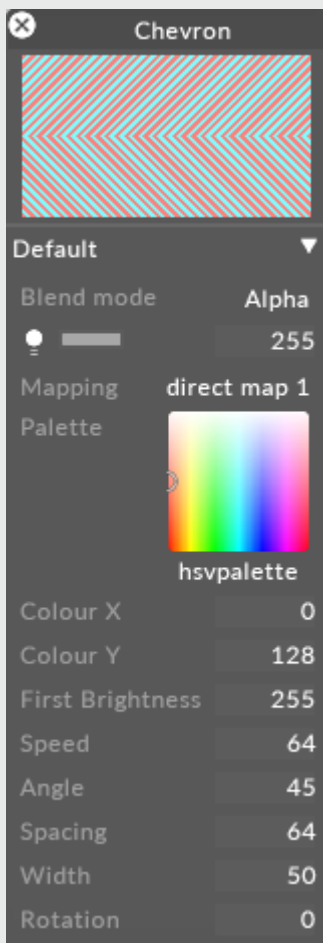

# Preview Thumbnail

This property is a small preview window at the top of the editor showing you what the layer output looks like.

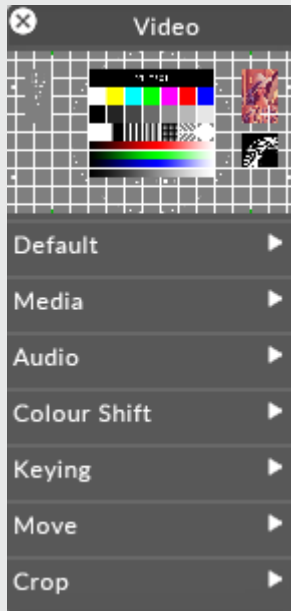

# Blend Mode

BlendMode controls how the output of the layer is composited with the layers below. Layers are rendered in a bottom-up order: layers at the top can modify the output of the layers below.

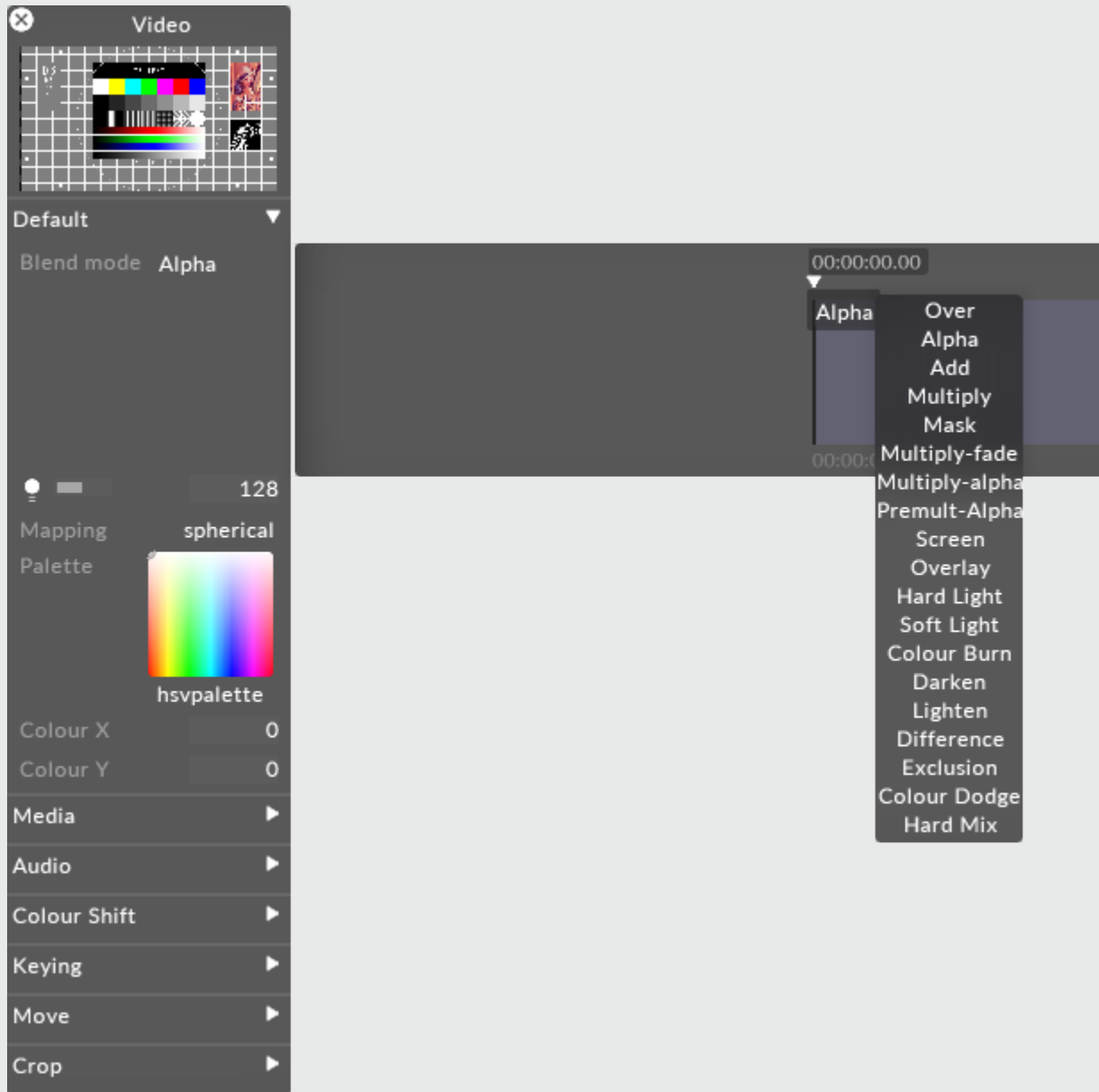

Changing brightness of a content layer in Disguise software is actually controlling the value of the alpha of the layer. Even when displaying a HAP video, the software will composite the layer with a controllable layer of alpha - one per layer.

There are two ways of expressing alpha in an image:

Straight alpha is an alpha channel which functions just like RGB. Alpha acts as a fourth channel of information per pixel which is as independent of the other three as R, G and B are of each other. For example, with straight alpha it is possible to have RGB = 255 (white) and alpha = 0 (fully transparent) on the same pixel. Internally generated content, such as gradient layer, are generated with straight alpha. This is the preferable style of alpha and considering the cleaner method of the two.

Premultiplied alpha takes the alpha and applies it to the values of the RGB channels per pixel. The more transparent something gets with premultiplied alpha, the closer it gets to black - as if the content is sitting on a black table. Premultiplied is the default output of Adobe Photoshop or AfterEffects. the result is our pixel at 255 RGB (full white) with 0 alpha would be calculated as a black pixel in the final image.

Here are explanations of what each individual blend mode will do.

## Over

Makes a layer fully opaque. Premultiplies all alpha onto the RGB value of each pixel. Alpha = black, so adjusting the brightness of a layer in Over blend mode makes it darker.

## Alpha

Default blend mode. It will apply alpha values as a transparency if the alpha is present. Brightness changes will make the layer more or less transparent.

## Add

Adds the value of each RGB pixel together. Always creates a brighter result. Values clamp at 255.

## Multiply

Reads the level of each subpixel as a level between 0.0 and 1.0, and multiplies source with blend. The result is always a darker image overall. For example: white x grey = 0.5. White turns transparent, black takes precedence. Alpha is applied in the same fashion as the Over Blend mode.

## Mask

Choose mask when you want to multiple out content upwards in the stack of layers, rather than downwards. In order to make this work you have to use the same mapping on the layer set to mask and the layer on top.

## Multiply-Fade

The same as Multiply, but will make use of the alpha channel to calculate transparency in the source and blend layers. Since maximum transparency is premultiplied, alpha results in black. This will ignore black created through premultiplying.

## Multiply-Alpha

Multiply with straight alpha. This mode assumes that the alpha has not been premultiplied onto the RGB values and will not apply a correction to the semi-transparent pixels.

## Premultiply Alpha

Like how Multiply-fade will ignore the darkening caused by premultiplying, this blend mode will do the same with Alpha.

## Colour Burn

Blend mode increases the contrast to darken the base colour while reflecting the blend colour. The darker the blend colour, the more intensely the colour will be applied in the base image. White as the blend colour produces no change. Using the colour burn blend mode can produce some harsh results at full opacity.

The colour burn blend mode can be used to make tonal and colour adjustments to a layer.

## Screen

This blend mode looks at each channels colour information and multiplies the inverse of the blend and base colour. The result is always a lighter colour. Screening with black leaves the colour unchanged. Screening with white produces white. The effect is similar to projecting multiple images on top of each other - where bright white is fully opaque, black is fully transparent and 50% grey is 50% transparent.

## Overlay

Multiplies or screens the colours, depending on the base colour. Patterns or colours overlay the existing pixels while preserving the highlights and shadows of the base colour. The base colour is not replaced, but mixed with the blend colour to reflect the lightness or darkness of the original colour.

## Hard Light

Multiplies or screens the colours, depending on the blend colour. The effect is similar to shining a harsh spotlight on the image. If the blend colour (light source/top layer) is lighter than 50% grey, the image is lightened as if it were screened. This is useful for adding highlights to an image. If the blend colour is darker than 50% grey, the image is darkened as if it were multiplied. This is useful for adding shadows to an image. Painting with pure black or white results in pure black or white.

## Soft Light

Darkens or lightens the colours, depending on the blend colour. The effect is similar to shining a diffused spotlight on the image. If the blend colour (light source/top layer) is lighter than 50% grey, the image is lightened as if it were dodged. If the blend colour is darker than 50% grey, the image is darkened as if it were burned in. Painting with pure black or white produces a distinctly darker or lighter area, but does not result in pure black or white.

## Darken

Looks at the colour information in each channel and selects the base or blend colour - whichever is darker - as the result colour. Pixels lighter than the blend colour are replaced and pixels darker than the blend colour do not change.

## Lighten

Looks at the colour information in each channel and selects the base or blend colour - whichever is lighter - as the result colour. Pixels darker than the blend colour are replaced and pixels lighter than the blend colour do not change.

## Difference

Looks at the colour information in each channel and subtracts either the blend colour from the base colour or the base colour from the blend colour depending on which has the greater brightness value.



Blending with white inverts the base colour values and blending with black produces no change.

## Exclusion

Creates an effects similar to but lower in contrast than the difference mode. Blending with white inverts the base colour values. Blending with black produces no change.

## Colour Dodge

Looks at the colour information in each channel and brightens the base colour to reflect the blend colour by decreasing contrast between the two. Blending with black produces no change.

## Hard Mix

Adds the RGB channels of the blend colour to the RGB values of the base colour. If the resulting sum for a channel is 255 or greater, it receives a value of 255; if it is less than 255 it receives a value of 0. Therefore all blended pixels have RGB channels of either 0 or 255. This changes all pixels to primary additive colours (RGB), white or black.

## Brightness

This property (which appears as a light bulb icon) controls the brightness of the layer output.

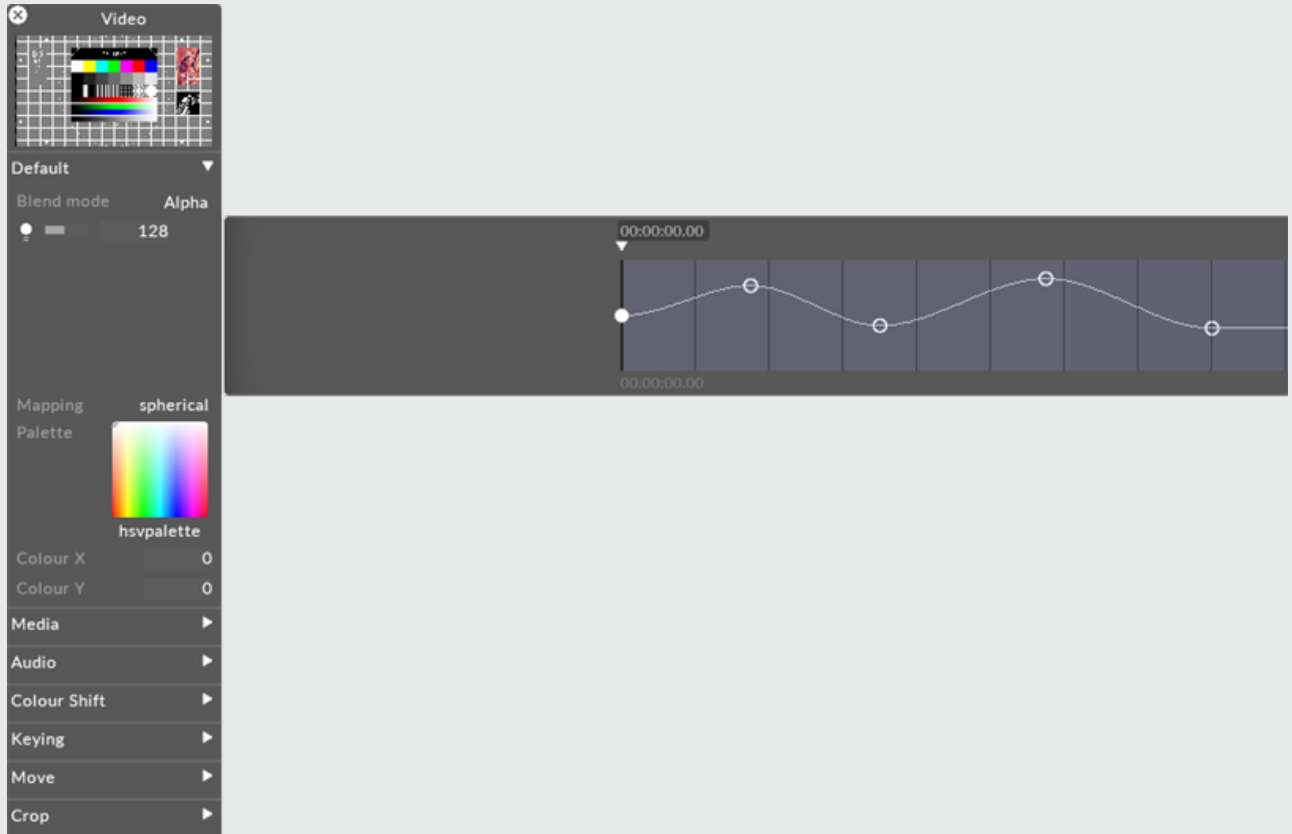

If the layers blend mode is set to Alpha, then reducing the brightness to 0 also reduces the opacity of the layer to 0. This can be useful when you want to dissolve from one layer to the next. In that case, you can place the new layer above the old layer and increase its brightness level.

## Mapping

The mapping property controls how the layer output is mapped onto the screen(s) in the Stage level.

**Video**

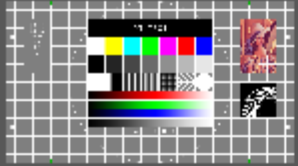

Default ▾

Blend mode Alpha

128

Mapping direct map 1

Palette



hsvpalette

Colour X 0

Colour Y 0

Media ▾

Video



d3\_test\_16-9.png

Speed 1

Mode Normal

At end point Loop

Transition time 0

Audio ▶

Colour Shift ▶

Keying ▶

Move ▶

Crop ▶

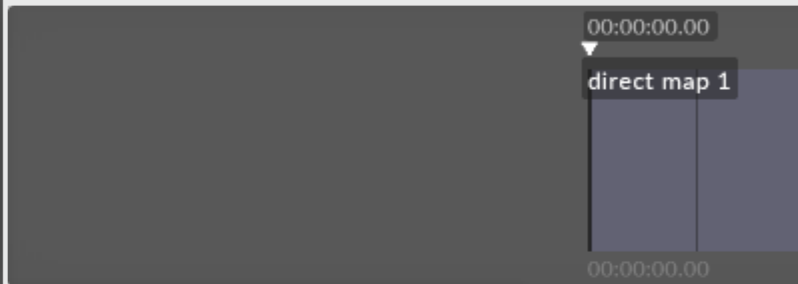

00:00:00.00

direct map 1

00:00:00.00

**mappings**

New mapping: OK Search:

all New Mappings

- direct map 1
- feed map 2
- feed mapping
- mapping 1
- mapping 2
- parallel
- spherical

For information on mapping, including how to use the different mapping types offered by Disguise software, please see the chapter [Content Mapping](#).

## Palette

This points to the still image file that defines the bitmap from which the tint colour is taken. The default palette ( HSVPAL ) consists of the complete range of hues and saturations. Selecting this property will open the Texture object library, which shows all of the still image files saved on your local hard-drive in the **DxTexture** folder.

To control the location within the current palette bitmap, and thus control the colour, you have to edit the **xCol** and **yCol** values (see the section for xCol, yCol).

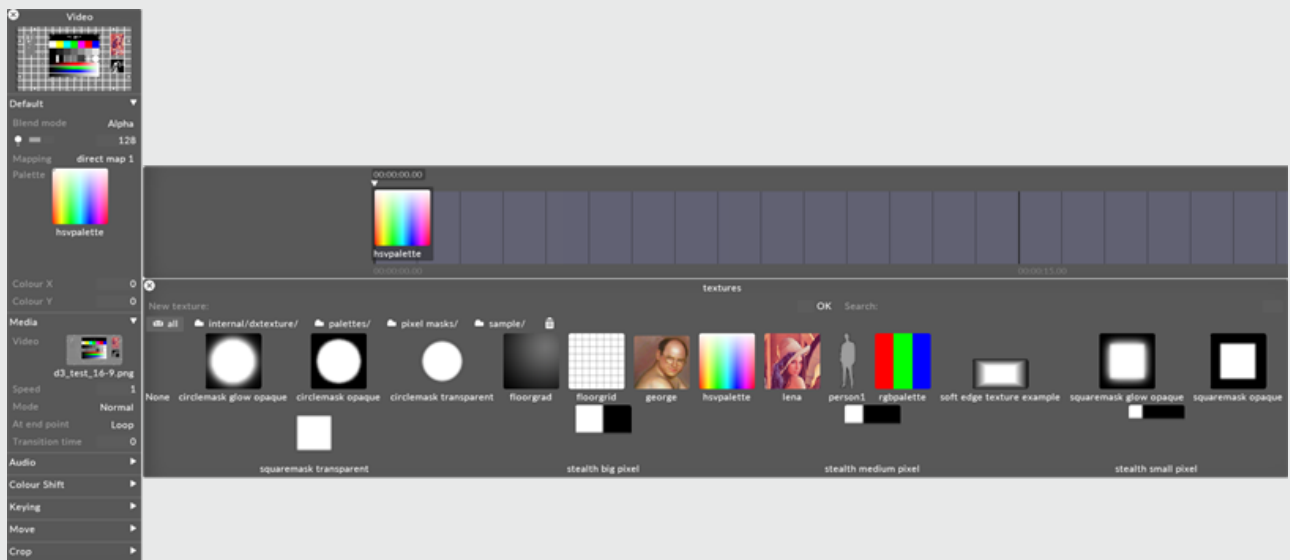

To change the current palette bitmap:

1. Left-click **palette** to open the Texture object library.
2. Left-click the still image file you want to use for the palette bitmap.

If you want to use a palette bitmap other than the standard still images provided in Disguise software, you will need to use a custom still image file.

See the [Placing media files for a project](#) sub-chapter to understand where to place a custom still image file and how to access it in Disguise software. Also save the file to a [supported file format](#).

## xCol y Col

These properties control the coordinates within the current palette bitmap where the output colour is sampled from. The default value is 0,0 which points at the color white (if you are using the HSVPAL palette). Multiplying white with the colors of the chosen content simply generates the original content colors. **Colour X** controls the horizontal position, where 0 is the leftmost edge and 255 is the rightmost edge. **Colour Y** controls the vertical position, where 0 is the top edge and 255 is the bottom edge.

For example, to saturate the video clip red, change the **Colour Y** value to 255 and use 0 for the **Colour X** value. These coordinates refer to the color red in the palette which is being multiplied with the colors of the existing content.

When you are using the default palette HSVPAL , **Colour Y** controls saturation, and **Colour X** controls hue.

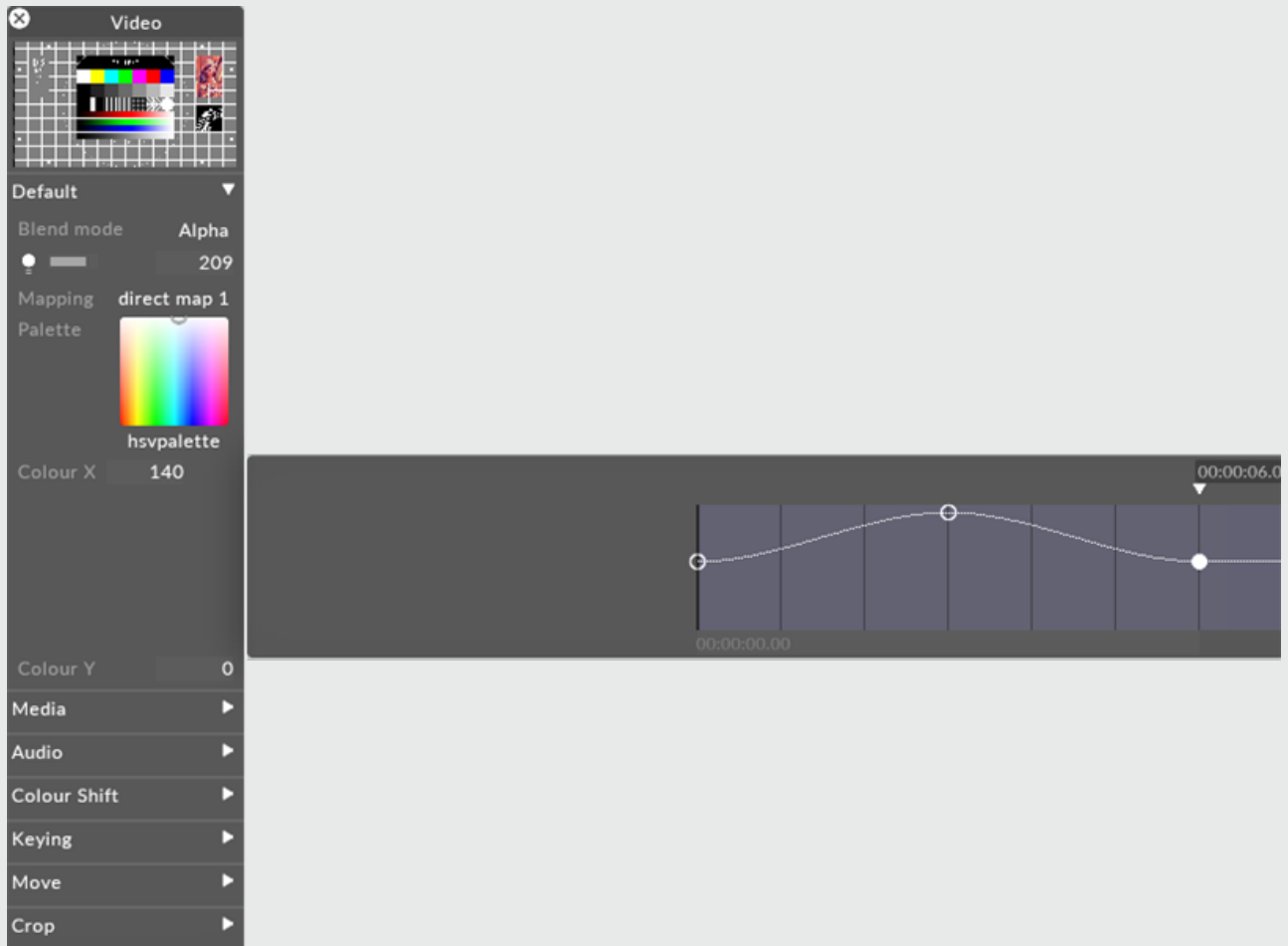

## Speed

This controls the speed of the chevrons, in pixels per beat. Positive numbers move the chevrons to the left; negative numbers move the chevrons to the right.

## Angle

This controls the angle of the chevron fins, in degrees. Smaller numbers move the angle closer to horizontal.

## Spacing

This controls the spacing between the chevrons, in pixels.

## Width

This controls the width, as a percentage of the spacing, of the first colour band.

# Colour

The Colour layer is a generative layer that is used to add a tint to the overall appearance of another layer.

## Overview

The Colour layer is the easiest layer type; it simply generates a flat colour.

The Colour layer can be used in combination with other layers such as the Video layer and the RenderStream layer, and is used to tint the image being output from that layer.

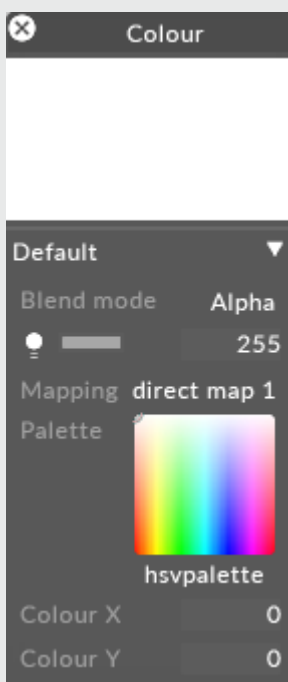

## Common Layer Properties



# Preview Thumbnail

This property is a small preview window at the top of the editor showing you what the layer output looks like.

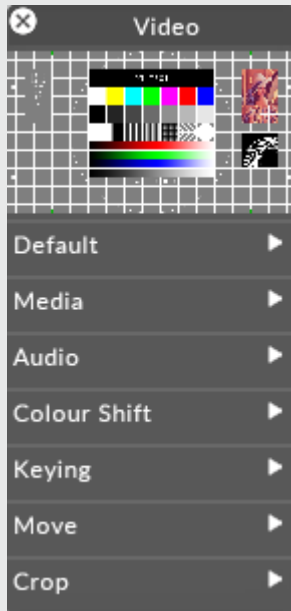

# Blend Mode

BlendMode controls how the output of the layer is composited with the layers below. Layers are rendered in a bottom-up order: layers at the top can modify the output of the layers below.

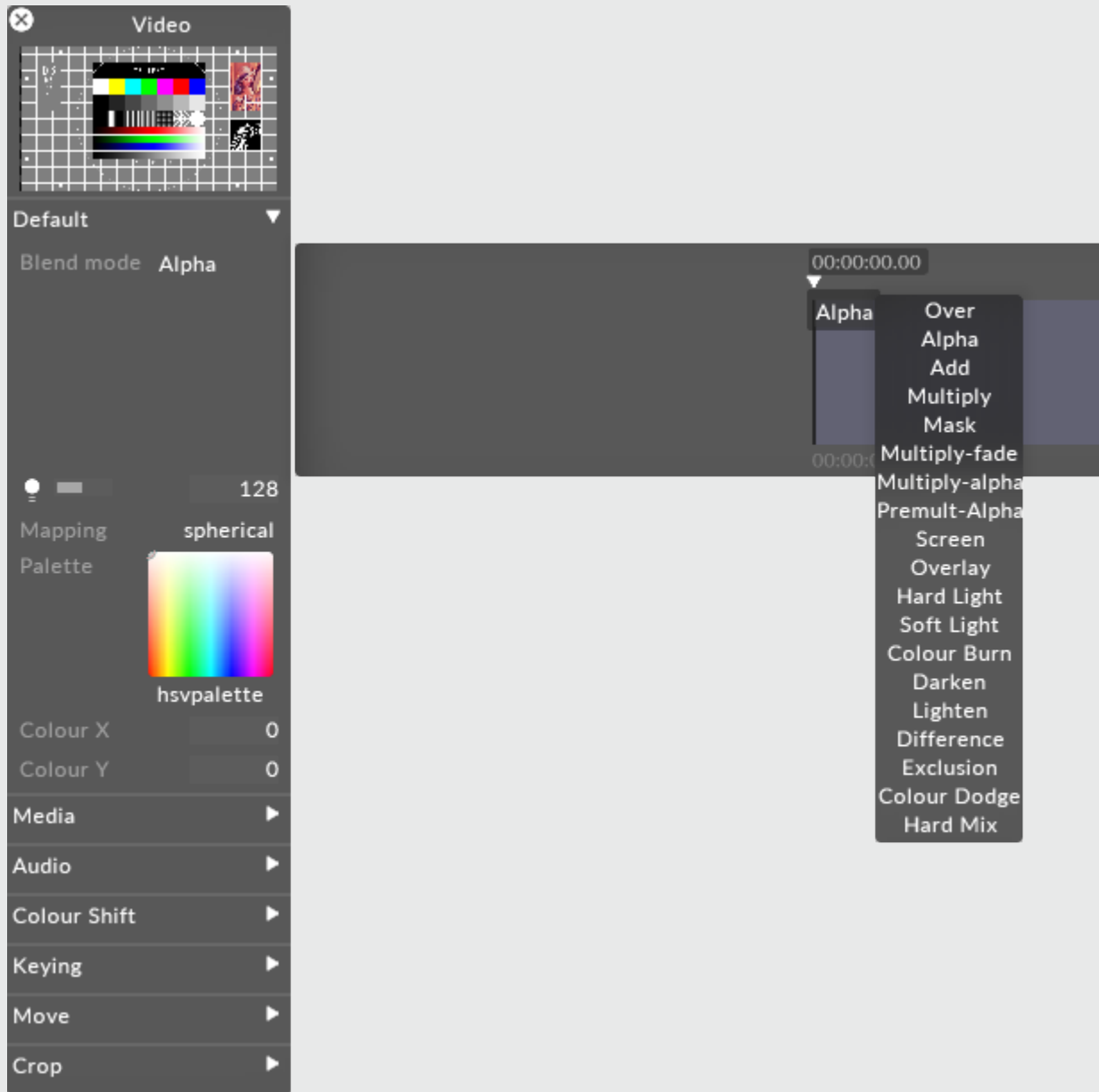

Changing brightness of a content layer in Disguise software is actually controlling the value of the alpha of the layer. Even when displaying a HAP video, the software will composite the layer with a controllable layer of alpha - one per layer.

There are two ways of expressing alpha in an image:

Straight alpha is an alpha channel which functions just like RGB. Alpha acts as a fourth channel of information per pixel which is as independent of the other three as R, G and B are of each other. For example, with straight alpha it is possible to have RGB = 255 (white) and alpha = 0 (fully transparent) on the same pixel. Internally generated content, such as gradient layer, are generated with straight alpha. This is the preferable style of alpha and considering the cleaner method of the two.

Premultiplied alpha takes the alpha and applies it to the values of the RGB channels per pixel. The more transparent something gets with premultiplied alpha, the closer it gets to black - as if the content is sitting on a black table. Premultiplied is the default output of Adobe Photoshop or AfterEffects. The result is our pixel at 255 RGB (full white) with 0 alpha would be calculated as a black pixel in the final image.

Here are explanations of what each individual blend mode will do.

## Over

Makes a layer fully opaque. Premultiplies all alpha onto the RGB value of each pixel. Alpha = black, so adjusting the brightness of a layer in Over blend mode makes it darker.

## Alpha

Default blend mode. It will apply alpha values as a transparency if the alpha is present. Brightness changes will make the layer more or less transparent.

## Add

Adds the value of each RGB pixel together. Always creates a brighter result. Values clamp at 255.

## Multiply

Reads the level of each subpixel as a level between 0.0 and 1.0, and multiplies source with blend. The result is always a darker image overall. For example: white x grey = 0.5. White turns transparent, black takes precedence. Alpha is applied in the same fashion as the Over Blend mode.

## Mask

Choose mask when you want to multiple out content upwards in the stack of layers, rather than downwards. In order to make this work you have to use the same mapping on the layer set to mask and the layer on top.

## Multiply-Fade

The same as Multiply, but will make use of the alpha channel to calculate transparency in the source and blend layers. Since maximum transparency is premultiplied, alpha results in black. This will ignore black created through premultiplying.

## Multiply-Alpha

Multiply with straight alpha. This mode assumes that the alpha has not been premultiplied onto the RGB values and will not apply a correction to the semi-transparent pixels.

## Premultiply Alpha

Like how Multiply-fade will ignore the darkening caused by premultiplying, this blend mode will do the same with Alpha.

## Colour Burn

Blend mode increases the contrast to darken the base colour while reflecting the blend colour. The darker the blend colour, the more intensely the colour will be applied in the base image. White as the blend colour produces no change. Using the colour burn blend mode can produce some harsh results at full opacity.

The colour burn blend mode can be used to make tonal and colour adjustments to a layer.

## Screen

This blend mode looks at each channels colour information and multiplies the inverse of the blend and base colour. The result is always a lighter colour. Screening with black leaves the colour unchanged. Screening with white produces white. The effect is similar to projecting multiple images on top of each other - where bright white is fully opaque, black is fully transparent and 50% grey is 50% transparent.

## Overlay

Multiplies or screens the colours, depending on the base colour. Patterns or colours overlay the existing pixels while preserving the highlights and shadows of the base colour. The base colour is not replaced, but mixed with the blend colour to reflect the lightness or darkness of the original colour.

## Hard Light

Multiplies or screens the colours, depending on the blend colour. The effect is similar to shining a harsh spotlight on the image. If the blend colour (light source/top layer) is lighter than 50% grey, the image is lightened as if it were screened. This is useful for adding highlights to an image. If the blend colour is darker than 50% grey, the image is darkened as if it were multiplied. This is useful for adding shadows to an image. Painting with pure black or white results in pure black or white.

## Soft Light

Darkens or lightens the colours, depending on the blend colour. The effect is similar to shining a diffused spotlight on the image. If the blend colour (light source/top layer) is lighter than 50% grey, the image is lightened as if it were dodged. If the blend colour is darker than 50% grey, the image is darkened as if it were burned in. Painting with pure black or white produces a distinctly darker or lighter area, but does not result in pure black or white.

## Darken

Looks at the colour information in each channel and selects the base or blend colour - whichever is darker - as the result colour. Pixels lighter than the blend colour are replaced and pixels darker than the blend colour do not change.

## Lighten

Looks at the colour information in each channel and selects the base or blend colour - whichever is lighter - as the result colour. Pixels darker than the blend colour are replaced and pixels lighter than the blend colour do not change.

## Difference

Looks at the colour information in each channel and subtracts either the blend colour from the base colour or the base colour from the blend colour depending on which has the greater brightness value.

Blending with white inverts the base colour values and blending with black produces no change.

## Exclusion

Creates an effects similar to but lower in contrast than the difference mode. Blending with white inverts the base colour values. Blending with black produces no change.

## Colour Dodge

Looks at the colour information in each channel and brightens the base colour to reflect the blend colour by decreasing contrast between the two. Blending with black produces no change.

## Hard Mix

Adds the RGB channels of the blend colour to the RGB values of the base colour. If the resulting sum for a channel is 255 or greater, it receives a value of 255; if it is less than 255 it receives a value of 0. Therefore all blended pixels have RGB channels of either 0 or 255. This changes all pixels to primary additive colours (RGB), white or black.

## Brightness

This property (which appears as a light bulb icon) controls the brightness of the layer output.

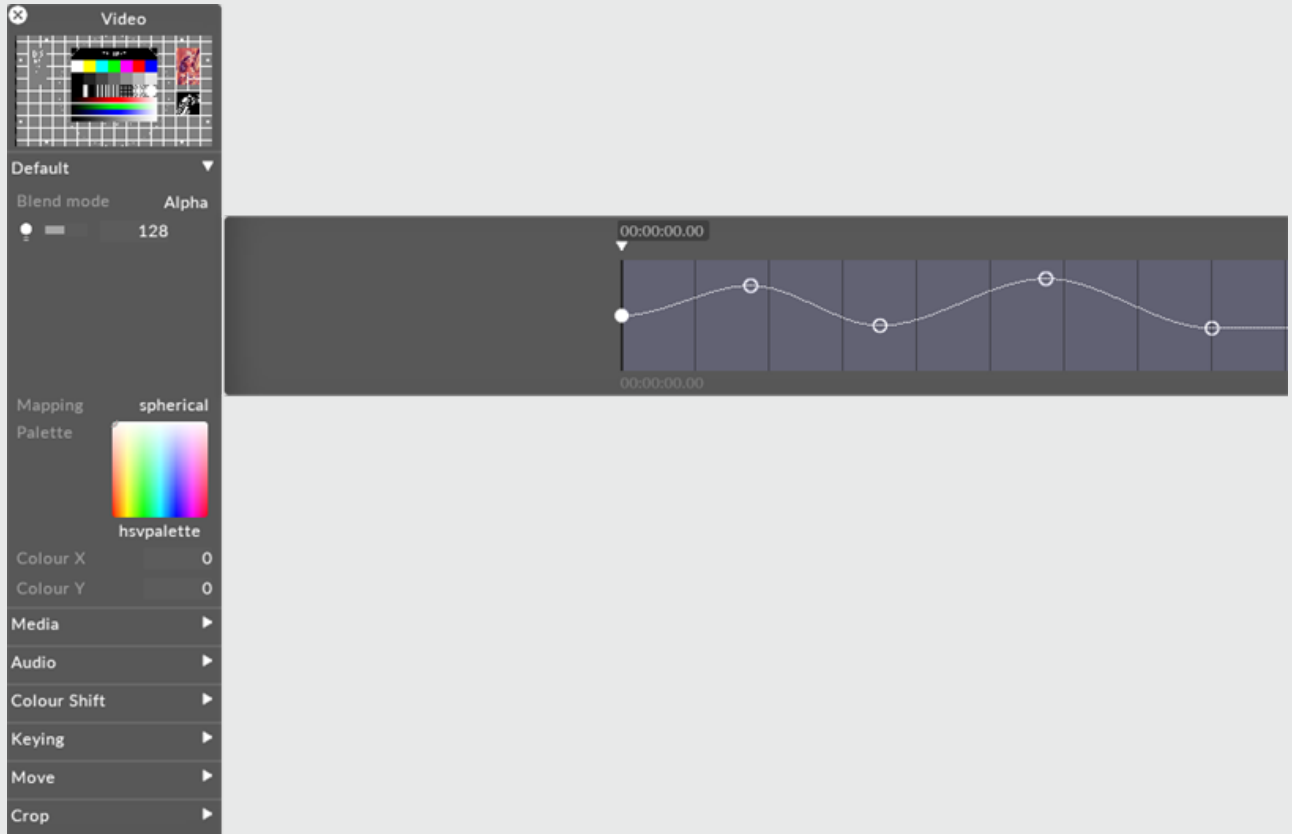

If the layers blend mode is set to Alpha, then reducing the brightness to 0 also reduces the opacity of the layer to 0. This can be useful when you want to dissolve from one layer to the next. In that case, you can place the new layer above the old layer and increase its brightness level.

## Mapping

The mapping property controls how the layer output is mapped onto the screen(s) in the Stage level.

**Video**

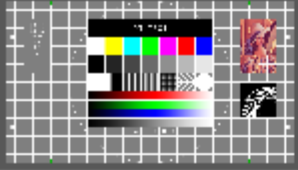

Default ▾

Blend mode Alpha

128

Mapping direct map 1

Palette



hsvpalette

Colour X 0

Colour Y 0

Media ▾

Video



d3\_test\_16-9.png

Speed 1

Mode Normal

At end point Loop

Transition time 0

Audio ▶

Colour Shift ▶

Keying ▶

Move ▶

Crop ▶

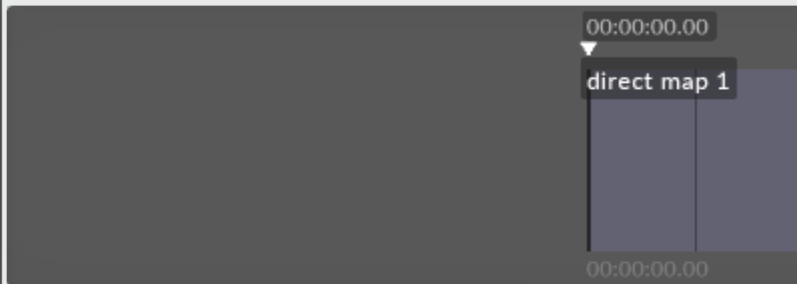

00:00:00.00

direct map 1

00:00:00.00

**mappings**

New mapping: OK Search:

all New Mappings

- direct map 1
- feed map 2
- feed mapping
- mapping 1
- mapping 2
- parallel
- spherical



For information on mapping, including how to use the different mapping types offered by Disguise software, please see the chapter [Content Mapping](#).

## Palette

This points to the still image file that defines the bitmap from which the tint colour is taken. The default palette ( HSVPAL ) consists of the complete range of hues and saturations. Selecting this property will open the Texture object library, which shows all of the still image files saved on your local hard-drive in the **DxTexture** folder.

To control the location within the current palette bitmap, and thus control the colour, you have to edit the **xCol** and **yCol** values (see the section for xCol, yCol).

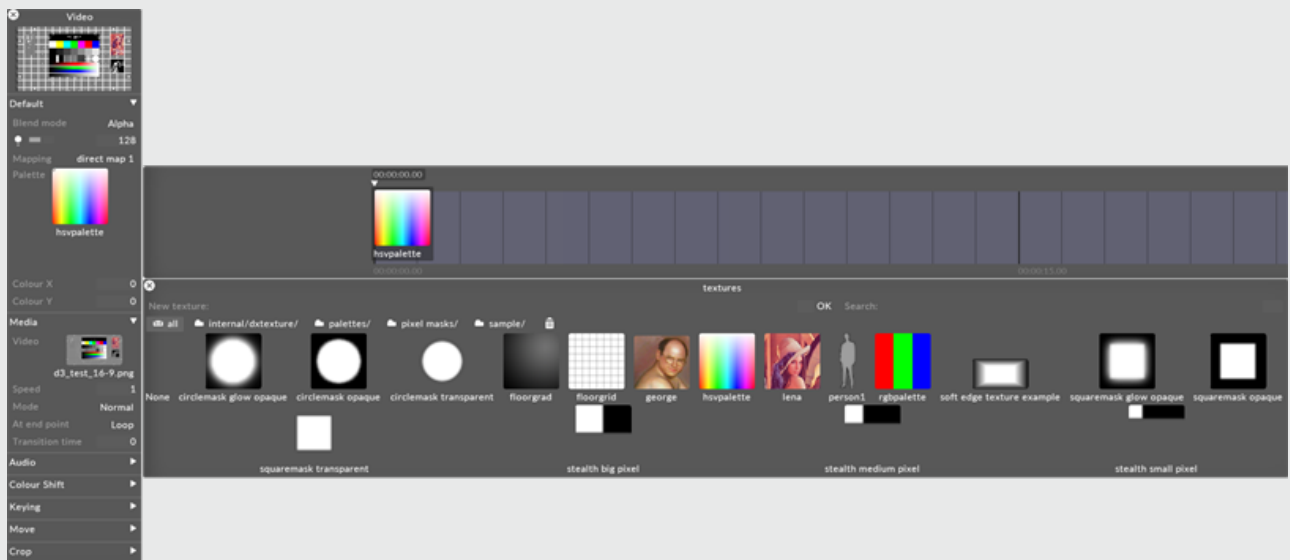

To change the current palette bitmap:

1. Left-click **palette** to open the Texture object library.
2. Left-click the still image file you want to use for the palette bitmap.

If you want to use a palette bitmap other than the standard still images provided in Disguise software, you will need to use a custom still image file.

See the [Placing media files for a project](#) sub-chapter to understand where to place a custom still image file and how to access it in Disguise software. Also save the file to a [supported file format](#).

## xCol y Col

These properties control the coordinates within the current palette bitmap where the output colour is sampled from. The default value is 0,0 which points at the color white (if you are using the HSVPAL palette). Multiplying white with the colors of the chosen content simply generates the original content colors. **Colour X** controls the horizontal position, where 0 is the leftmost edge and 255 is the rightmost edge. **Colour Y** controls the vertical position, where 0 is the top edge and 255 is the bottom edge.

For example, to saturate the video clip red, change the **Colour Y** value to 255 and use 0 for the **Colour X** value. These coordinates refer to the color red in the palette which is being multiplied with the colors of the existing content.

When you are using the default palette HSVPAL , **Colour Y** controls saturation, and **Colour X** controls hue.

Video



Default

Blend mode Alpha

209

Mapping direct map 1

Palette



hsvpalette

Colour X 140

Colour Y 0

Media ▶

Audio ▶

Colour Shift ▶

Keying ▶

Move ▶

Crop ▶

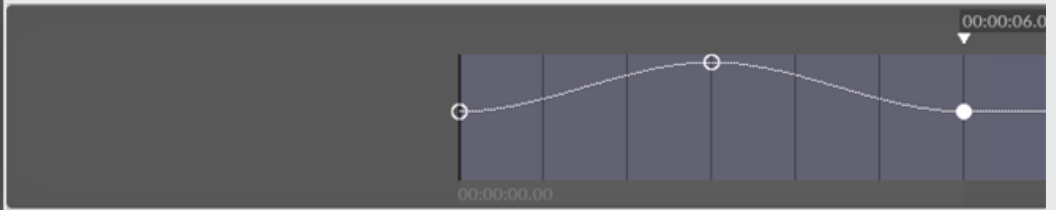

# Gradient

The Gradient layer draws real-time gradients composed of two colours.

## Overview

The Gradient layer draws real-time gradients composed of two colours. This means that the colours contained in the gradients can be keyframed and sequenced to change instead of being rendered into the content.

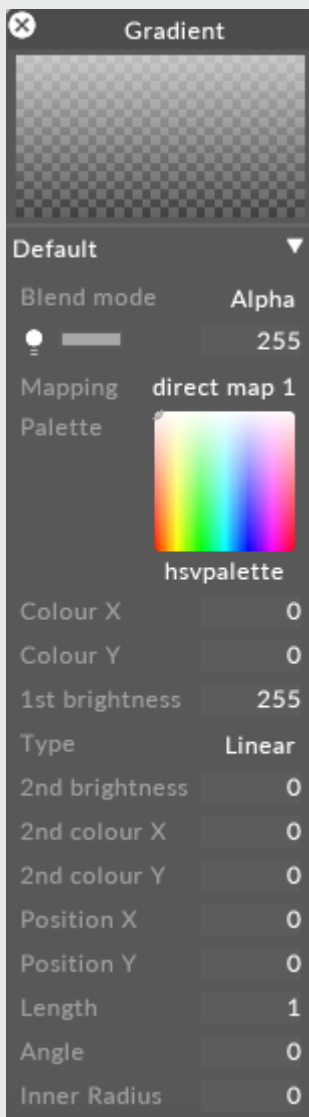

# Layer Properties

## Type

Either **linear** or **radial** .

## 2nd Brightness

This controls the brightness of the second colour in the gradient.

## 2nd xCol, 2nd yCol

This controls the second colour in the gradient (both colours must be taken from the same palette bitmap).

## Position x, y

This controls the position (ranging from -1 to +1 on both axes) of the the gradient. In case you are using the **linear** gradient, this is the midpoint of the line; If you are using the **radial** gradient, this is the center of the circle.

## Length

Length can have a value ranging from 0 to 1 (1= complete canvas width) and controls the width of either the linear gradient or the radius of the circle.

## Angle

This is only meaningful when using linear gradients. It controls the angle of the line, in degrees.

# Inner Radius

Radial offset before the gradient occurs. Only applies when the gradient **Type** is **Radial**.

# Common Layer properties

## Preview Thumbnail

This property is a small preview window at the top of the editor showing you what the layer output looks like.



## Blend Mode

BlendMode controls how the output of the layer is composited with the layers below. Layers are rendered in a bottom-up order: layers at the top can modify the output of the layers below.

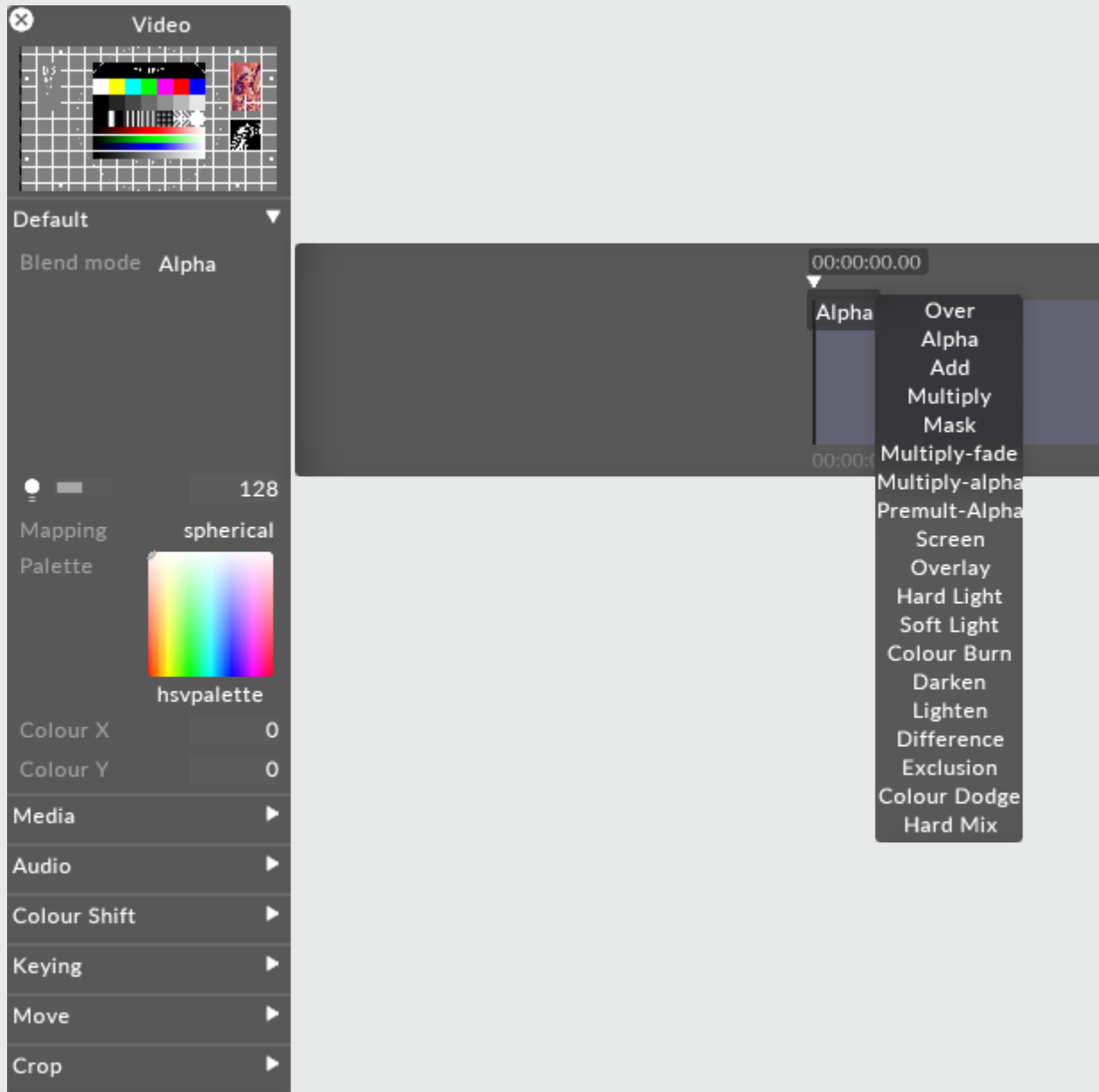

Changing brightness of a content layer in Disguise software is actually controlling the value of the alpha of the layer. Even when displaying a HAP video, the software will composite the layer with a controllable layer of alpha - one per layer.

There are two ways of expressing alpha in an image:

Straight alpha is an alpha channel which functions just like RGB. Alpha acts as a fourth channel of information per pixel which is as independent of the other three as R, G and B are of each other. For example, with straight alpha it is possible to have RGB = 255 (white) and alpha = 0 (fully transparent) on the same pixel. Internally generated content, such as gradient layer, are generated with straight alpha. This is the preferable style of alpha and considering the cleaner method of the two.

Premultiplied alpha takes the alpha and applies it to the values of the RGB channels per pixel. The more transparent something gets with premultiplied alpha, the closer it gets to black - as if the content is sitting on a black table. Premultiplied is the default output of Adobe Photoshop or AfterEffects. the result is our pixel at 255 RGB (full white) with 0 alpha would be calculated as a black pixel in the final image.

Here are explanations of what each individual blend mode will do.

## Over

Makes a layer fully opaque. Premultiplies all alpha onto the RGB value of each pixel. Alpha = black, so adjusting the brightness of a layer in Over blend mode makes it darker.

## Alpha

Default blend mode. It will apply alpha values as a transparency if the alpha is present. Brightness changes will make the layer more or less transparent.

## Add

Adds the value of each RGB pixel together. Always creates a brighter result. Values clamp at 255.

## Multiply

Reads the level of each subpixel as a level between 0.0 and 1.0, and multiplies source with blend. The result is always a darker image overall. For example: white x grey = 0.5. White turns transparent, black takes precedence. Alpha is applied in the same fashion as the Over Blend mode.



## Mask

Choose mask when you want to multiply out content upwards in the stack of layers, rather than downwards. In order to make this work you have to use the same mapping on the layer set to mask and the layer on top.

## Multiply-Fade

The same as Multiply, but will make use of the alpha channel to calculate transparency in the source and blend layers. Since maximum transparency is premultiplied, alpha results in black. This will ignore black created through premultiplying.

## Multiply-Alpha

Multiply with straight alpha. This mode assumes that the alpha has not been premultiplied onto the RGB values and will not apply a correction to the semi-transparent pixels.

## Premultiply Alpha

Like how Multiply-fade will ignore the darkening caused by premultiplying, this blend mode will do the same with Alpha.

## Colour Burn

Blend mode increases the contrast to darken the base colour while reflecting the blend colour. The darker the blend colour, the more intensely the colour will be applied in the base image. White as the blend colour produces no change. Using the colour burn blend mode can produce some harsh results at full opacity.

The colour burn blend mode can be used to make tonal and colour adjustments to a layer.

## Screen

This blend mode looks at each channels colour information and multiplies the inverse of the blend and base colour. The result is always a lighter colour. Screening with black leaves the colour unchanged. Screening with white produces white. The effect is similar to projecting multiple images on top of each other - where bright white is fully opaque, black is fully transparent and 50% grey is 50% transparent.

## Overlay

Multiplies or screens the colours, depending on the base colour. Patterns or colours overlay the existing pixels while preserving the highlights and shadows of the base colour. The base colour is not replaced, but mixed with the blend colour to reflect the lightness or darkness of the original colour.

## Hard Light

Multiplies or screens the colours, depending on the blend colour. The effect is similar to shining a harsh spotlight on the image. If the blend colour (light source/top layer) is lighter than 50% grey, the image is lightened as if it were screened. This is useful for adding highlights to an image. If the blend colour is darker than 50% grey, the image is darkened as if it were multiplied. This is useful for adding shadows to an image. Painting with pure black or white results in pure black or white.

## Soft Light

Darkens or lightens the colours, depending on the blend colour. The effect is similar to shining a diffused spotlight on the image. If the blend colour (light source/top layer) is lighter than 50% grey, the image is lightened as if it were dodged. If the blend colour is darker than 50% grey, the image is darkened as if it were burned in. Painting with pure black or white produces a distinctly darker or lighter area, but does not result in pure black or white.

## Darken

Looks at the colour information in each channel and selects the base or blend colour - whichever is darker - as the result colour. Pixels lighter than the blend colour are replaced and pixels darker than the blend colour do not change.

## Lighten

Looks at the colour information in each channel and selects the base or blend colour - whichever is lighter - as the result colour. Pixels darker than the blend colour are replaced and pixels lighter than the blend colour do not change.

## Difference

Looks at the colour information in each channel and subtracts either the blend colour from the base colour or the base colour from the blend colour depending on which has the greater brightness value.

Blending with white inverts the base colour values and blending with black produces no change.

## Exclusion

Creates an effects similar to but lower in contrast than the difference mode. Blending with white inverts the base colour values. Blending with black produces no change.

## Colour Dodge

Looks at the colour information in each channel and brightens the base colour to reflect the blend colour by decreasing contrast between the two. Blending with black produces no change.

## Hard Mix

Adds the RGB channels of the blend colour to the RGB values of the base colour. If the resulting sum for a channel is 255 or greater, it receives a value of 255; if it is less than 255 it receives a value of 0. Therefore all blended pixels have RGB channels of either 0 or 255. This changes all pixels to primary additive colours (RGB), white or black.

## Brightness

This property (which appears as a light bulb icon) controls the brightness of the layer output.

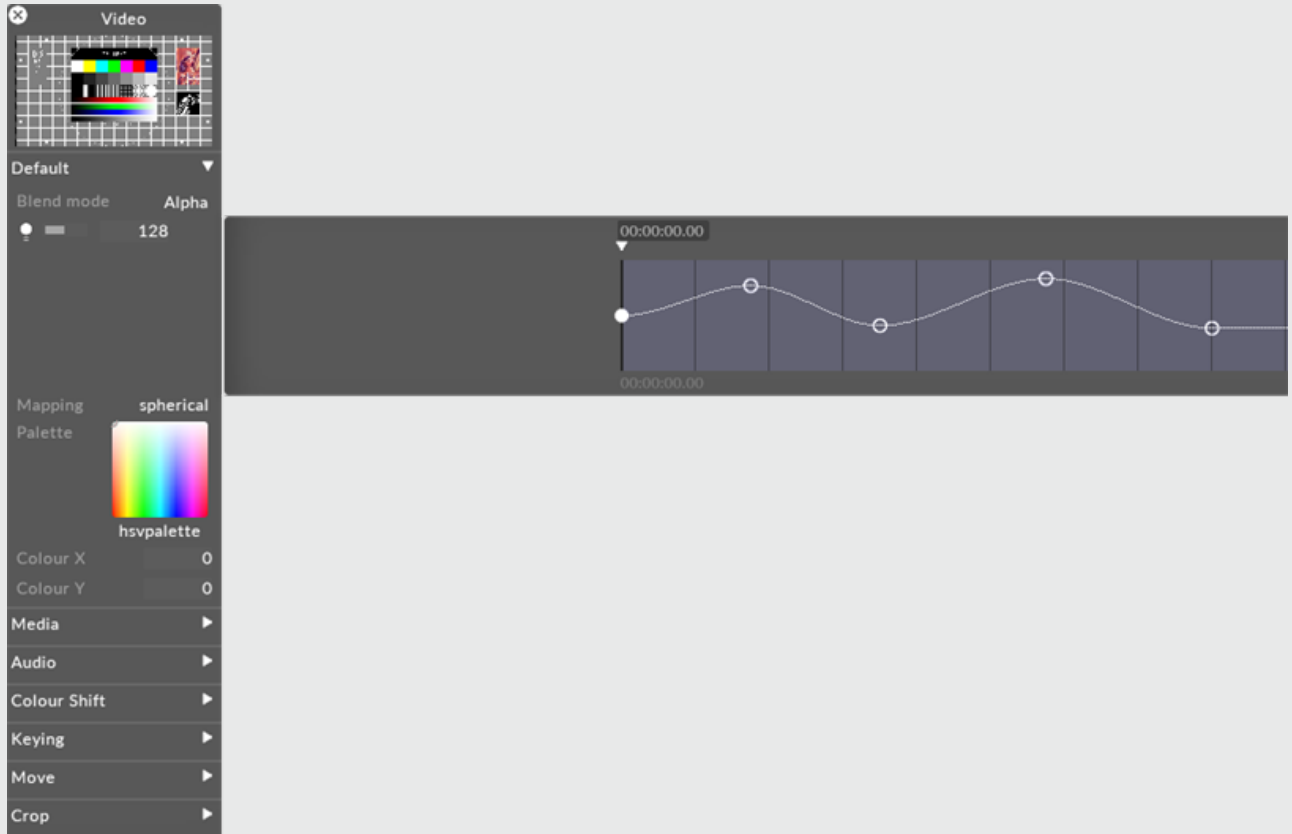

If the layers blend mode is set to Alpha, then reducing the brightness to 0 also reduces the opacity of the layer to 0. This can be useful when you want to dissolve from one layer to the next. In that case, you can place the new layer above the old layer and increase its brightness level.

## Mapping

The mapping property controls how the layer output is mapped onto the screen(s) in the Stage level.

**Video**

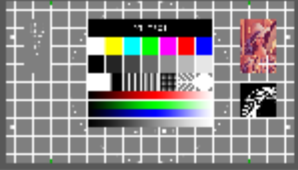

Default ▾

Blend mode Alpha

128

Mapping direct map 1

Palette



hsvpalette

Colour X 0

Colour Y 0

Media ▾

Video



d3\_test\_16-9.png

Speed 1

Mode Normal

At end point Loop

Transition time 0

Audio ▶

Colour Shift ▶

Keying ▶

Move ▶

Crop ▶

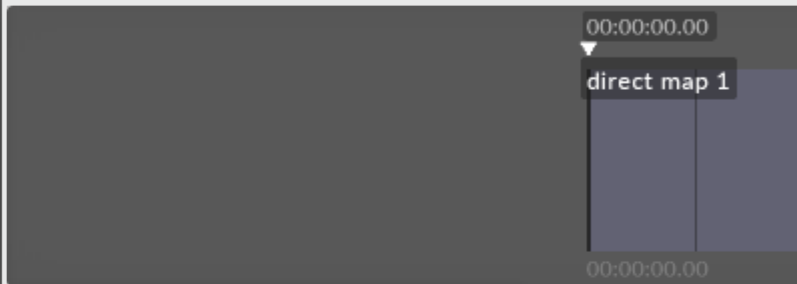

00:00:00.00

direct map 1

00:00:00.00

**mappings**

New mapping: OK Search:

all New Mappings

- direct map 1
- feed map 2
- feed mapping
- mapping 1
- mapping 2
- parallel
- spherical

For information on mapping, including how to use the different mapping types offered by Disguise software, please see the chapter [Content Mapping](#).

## Palette

This points to the still image file that defines the bitmap from which the tint colour is taken. The default palette ( HSVPAL ) consists of the complete range of hues and saturations. Selecting this property will open the Texture object library, which shows all of the still image files saved on your local hard-drive in the **DxTexture** folder.

To control the location within the current palette bitmap, and thus control the colour, you have to edit the **xCol** and **yCol** values (see the section for xCol, yCol).

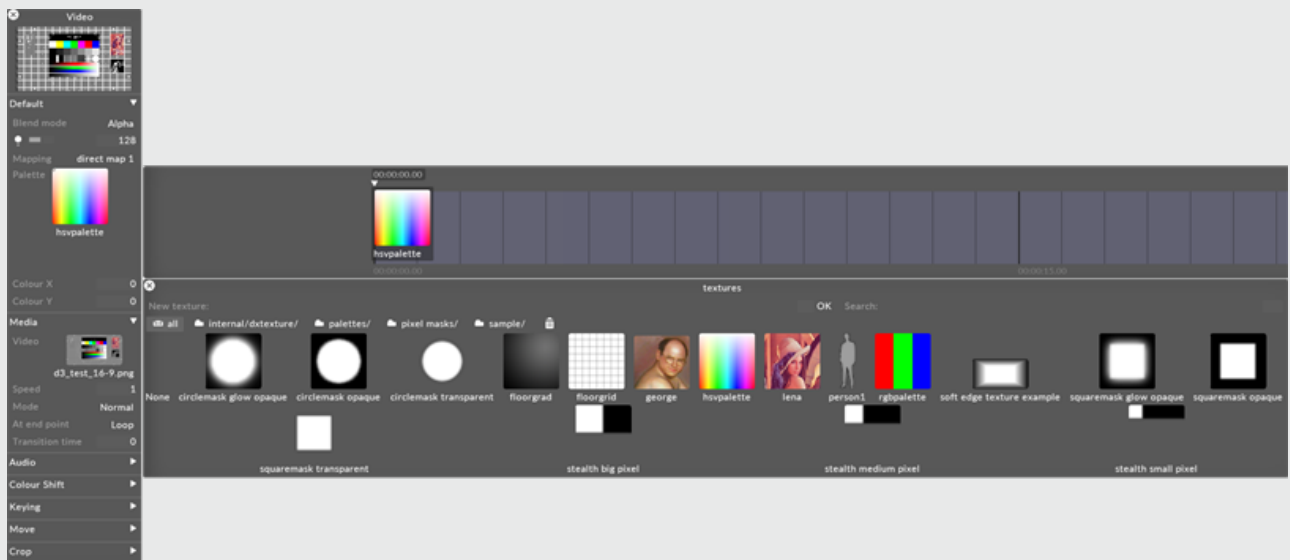

To change the current palette bitmap:

1. Left-click **palette** to open the Texture object library.
2. Left-click the still image file you want to use for the palette bitmap.

If you want to use a palette bitmap other than the standard still images provided in Disguise software, you will need to use a custom still image file.

See the [Placing media files for a project](#) sub-chapter to understand where to place a custom still image file and how to access it in Disguise software. Also save the file to a [supported file format](#).

## xCol y Col

These properties control the coordinates within the current palette bitmap where the output colour is sampled from. The default value is 0,0 which points at the color white (if you are using the HSVPAL palette). Multiplying white with the colors of the chosen content simply generates the original content colors. **Colour X** controls the horizontal position, where 0 is the leftmost edge and 255 is the rightmost edge. **Colour Y** controls the vertical position, where 0 is the top edge and 255 is the bottom edge.

For example, to saturate the video clip red, change the **Colour Y** value to 255 and use 0 for the **Colour X** value. These coordinates refer to the color red in the palette which is being multiplied with the colors of the existing content.

When you are using the default palette HSVPAL , **Colour Y** controls saturation, and **Colour X** controls hue.

Video



Default

Blend mode Alpha

209

Mapping direct map 1

Palette



hsvpalette

Colour X 140

Colour Y 0

Media ▶

Audio ▶

Colour Shift ▶

Keying ▶

Move ▶

Crop ▶

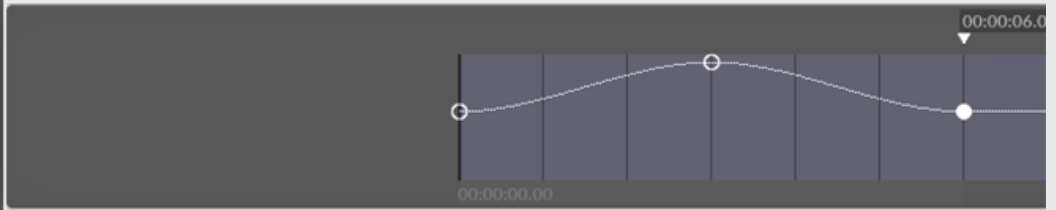



# Notch

Notch is a generative content creation platform that integrates with Disguise software.

## Overview

The Notch layer allows users to use [Notch Blocks](#) exported from [Notch Builder](#).

Notch content creation should be approached from a similar standpoint to that of rendered content, whereby the user specifies as much in advance as possible and test the content on a real world system before show time to reduce the likelihood of performance related issues.



**Warning:** Extremely demanding Notch blocks can cause an oversubscription of available memory resources - click [here](#) for full advisory.

Some Generative layers take their source from other layer types - either content or generative - by use of an arrow. Linking two layers with an arrow defines the arrowed from layer as the source, and the arrowed to layer as the destination. If you have an arrow between a content layer and effect layer, it is said that the content layer is being 'piped in' to the effect layer. For more information on arrows, see the [compositing layers topic](#).

To draw an arrow between two layers, hold down **ALT** and left click & drag between the source and destination layer.

On the Notch layer, you can specify which source the layer is using (either texture or an arrowed layer) by using the Video Loader parameter. The Video parameter of the layer will show a thumbnail of either the texture chosen, or the content coming from the arrowed layer (depending on the selection made)

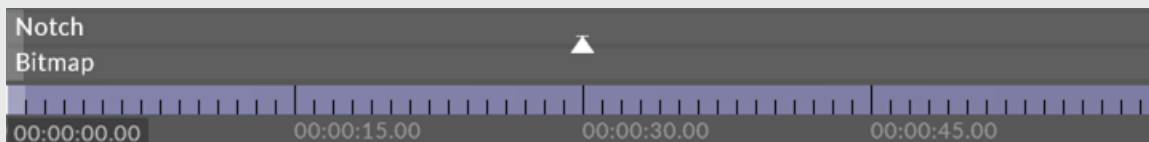

# Notch advice

**Please note:** It's always recommended to combine multiple Notch blocks into one block, as oppose to using lots of small blocks in your project. Notch has functionality to combine blocks in Notch builder.

- Notch renders to the size of the resolution of the mapping being used on the Notch layer within Disguise software.
- Rotation is displayed in degrees within Notch, but shown as radians once exposed within Disguise software.
- The Y and Z axes are different in Notch and Disguise software, and need to be flipped/converted manually using an expression.
- The general consensus is that one should NOT use Universal Crossfade alongside Notch. Using Universal Crossfade adds twice as much load, and depending on the effect used it is unlikely to generate the desired effect.
- Only ever have one dfx file connected to a Kinect.
- When using a Notch block with Kinect input, in order to see this input the machine will need the Kinect SDK installed. You will also need to enable Kinect input via Devices in Notch Builder.
- For audio reactive, its worthwhile to define the audio device being used on the server in you notch projects audio device (device->audio device).
- When using sockpuppet - please advise the Notch content creators to create unified naming conventions for all exposed parameters (ie: FX1, FX2, Speed1, Speed2, Color1, Color2, Color3, etc.) or the end management will be difficult to manage.
- Any block that stores frames (i.e. frame delay) needs to be managed extremely carefully or it may eat up all memory resources. If vram resources are being eaten up inexplicably, it's worth checking whether the Notch block is storing frames for use anywhere.

- Also, as Notch blocks are not user definable in terms of DMX assignment order, it is always best to pre-determine the number of attributes one wishes to have exposed in the Master block.

## Workflows

The Notch layer is specifically for playing back Notch blocks. Depending on your application and production needs, there are a number of workflows you can employ in order to integrate Notch effects into Disguise software. Below are a few recommended workflows for their respective applications. Bear in mind that these are stripped to the bare minimum elements for simplicity, and users are required to have a valid Notch Builder software with export capabilities in order to follow along.

For more information on Notch Builder, see [here](#).

## IMAG effects

These are probably the most straight-forward effects to implement on a show, as blocks are usually designed to be plug and play, with a video source and exposed parameters to control and interact with the effect. Below we denote the workflow.

### In Notch

- Create a Notch effect with a node that accepts a video (usually Video Source)
- Expose the Video Source property and compile the block

### In disguise

- Create a Notch layer, load the IMAG Notch block into it.
- Create a Video layer (or any layer you wish to output content from, i.e. generative layers).

- Set Video Source to **Layer**.
- Move the Notch layer above the other layer in the stack, then arrow the video layer to it.

You should now be able to see the IMAG effect applied to any content from the layer below. You can change the effects being applied under the parameter group's Notch Layer parameter, if the effect is set up to use layers as individual effects.

## Things to note

- The Disguise software does not yet support Video selection without layer arrowing. The Video parameter under Video Sources is mostly unused, though it can still be used for placeholder images. The images displayed there are taken from the DxTexture folder.
- If multiple Notch layers are used and you wish the arrowed video to be the same for all of them, you will need to set up the exposed parameter's Unique Identifier in Notch to be the same for all exposed video sources.
- If multiple layers are arrowed into an effect that accepts multiple sources, the source layer is chosen in order of selection (i.e. the first layer selected will be the first Video source, the second will be the second, etc) regardless of the order of the parameters themselves within the list.

## 3D virtual lighting simulations

These workflows often involve a 3D mapped object with projectors simulating light sources moving and affecting the object in real time. These effects rely on the virtual 3D space to match the real space and object, along with the coordinate systems of Disguise software and Notch.

### In Notch

- Add a 3D object node (or a Shape 3D node, etc) and add it to the scene.
- Add a light source.
- Create a UV camera node to output the lit textures onto the object's UVs.

- Expose the appropriate parameters (light positions, object positions, etc).
- Compile and export the block.

## In disguise

- Create a surface with the same object used in Notch.
- Calibrate the projectors to the surface with your preferred calibration method.
- Create a Notch layer.
- Apply the Notch layer via Direct mapping to the object.
- Move the lights around to see the object UVs being affected.

## Notes



**Warning:** While it's often advised to enable Deferred Rendering in Notch, it might negatively impact performance depending on the complexity of the scene. Use this functionality cautiously.

- In order for the Notch scene to match the scene within Disguise software, accurate measurements need to be taken on stage and an origin point reference needs to be determined from the start. Setting an origin point early in the process will make the line up process easier.
- Lights can be linked to MIDI, OSC or DMX controls like every parameter in Disguise software, or can be keyframed and sequenced on the timeline.
- The mapped object's movement can be linked to automation or tracking systems, and the positional data can then be used to drive the exposed position and rotation parameters.

- If multiple objects are in a scene, you will need to create a larger UV layout that accommodates each object in a separate UV area, and then match the overall lightmap resolution by setting the surface resolution within Disguise software. You can use the UV Output section of the 3D objects node in Notch to determine where in UV space a specific mesh will be output within the overall canvas.

## Particles systems and tracking regions

A very common application of Notch is to use it alongside tracking systems such as BlackTrax in order to generate particles from specific points in space, to be either projected on a surface or displayed on an LED screen. Below is a broad outline of the workflow using an LED screen, the BlackTrax system, and region camera to specify the tracking regions:

### In Notch

- Create a particle system (Minimum required: Particle Root, Emitter, Renderer).
- Create a Region Camera.
- Expose the position parameters of the Particle Emitter, as well as the Region Camera's Top Left X and Y, and Bottom Right X and Y.
- Compile the block and export to disguise.

### In disguise

- Create an LED screen. This can be placed anywhere in the virtual stage, though it is recommended to place the LED in the correct position to match the physical space.
- Ensure the BlackTrax system is connected and tracking data is being received from the beacons, then select a stringer to use as a tracked point for the Notch particles.
- Create a Notch layer and load the exported block into it.
- Set the Play Mode to Free-run, or press play on the timeline in order for the particles to begin spawning. They are a simulation, and only spawn over a span of time.

- Right-click on the BT point being tracked to open a widget that displays the point's current coordinates in 3D space.
- With the Notch layer open and the Particle Emitter position parameters visible, navigate to the tracked point's widget, hover over one of the position values, then Alt+left click and drag an arrow from there to the corresponding position parameter in the Notch block.
- You should now see the particle effect either disappearing off-screen (if the beacon is not in range of the LED screen), or moving towards it.
- If the world coordinates of Notch and disguise do not match, and the particle effect is limited to a particular screen or mapped area, a Region Camera can be used to mark the boundaries of the tracking region instead.
- To set the region camera, simply measure the XY position of the top-left corner of the LED screen, and do the same for the bottom-right, and enter these values in the exposed Region Camera parameters.

## Notes

- An often quicker method of finding out the region camera values is to place a tracked BT point on the top left of the screen, and then the bottom right, and manually enter the xyz coordinates displayed on the tracked point's widget, as they are sure to match precisely.
- A common mistake that leads to oddities with tracking regions is when the wrong axes are used. As a rule of thumb, for vertical surfaces you'll need to take the X and Y position of the top left and bottom right corners, whereas for horizontal surfaces (i.e. for effects built to be displayed on the ground) you will need X and Z. This is obviously also dependant on how the Notch block itself was built and the orientation chosen in the region camera node, so it's important to double-check these details beforehand.
- When using the region camera, particle size plays a fairly important role. It may be advisable to expose emitter size, particle size, and camera distance in order to achieve the desired result.
- If multiple machines are outputting the same set of particles but are seeing a different result, it is because both particle roots are running separate instances of the simulation on two machines.

You can fix that by setting the Particle Root node for that emitter to Deterministic by ticking the box in the node editor in Notch Builder.

## Notch layer properties

Notch layers are comprised of a set of default properties (detailed here) and additional properties that appear depending on what is actually in the Notch block. For explanation of properties beyond the default, please refer to your Notch content creator.

### Effect

The Effect parameter defines which Notch DFX File the layer is looking at.

### Blend Mode

Blend Mode controls how the output of the layer is composited with the layers below.

### Brightness

This property (which appears as a light bulb icon) controls the brightness of the layer output.

### Mapping

The mapping property controls how the layer output is mapped onto the screen(s) in the Stage level.



**Video**

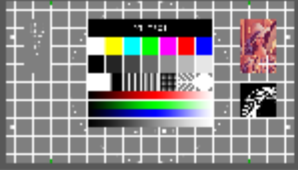

Default ▾

Blend mode Alpha

128

Mapping direct map 1

Palette



hsvpalette

Colour X 0

Colour Y 0

Media ▾

Video



d3\_test\_16-9.png

Speed 1

Mode Normal

At end point Loop

Transition time 0

Audio ▶

Colour Shift ▶

Keying ▶

Move ▶

Crop ▶

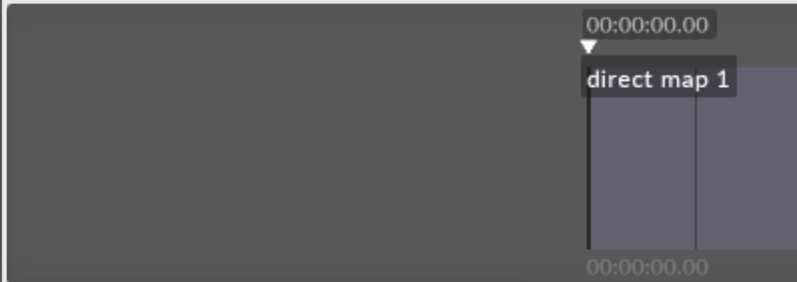

00:00:00.00

direct map 1

00:00:00.00

**mappings**

New mapping: OK Search:

all New Mappings

- direct map 1
- feed map 2
- feed mapping
- mapping 1
- mapping 2
- parallel
- spherical

For information on mapping, including how to use the different mapping types offered by Disguise software, please see the chapter [Content Mapping](#).

## Processing Size

The resolution at which the Notch effect is processed at.

There are two options:

**Output size** - The resolution of the screen the effect is mapped to (not the mapping itself)

**Input size** - The resolution of the effect as set in the Notch Builder.

## Dry-Wet Blend

Global Intensity level for the effect on a scale of 0-255.

## Mode

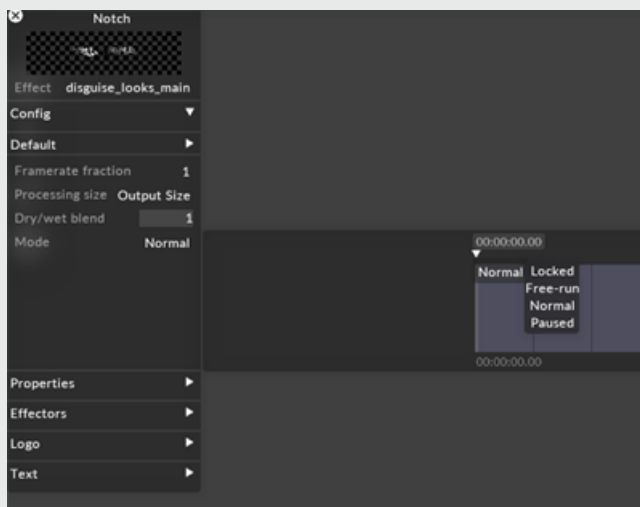

This specifies the playback mode.

There are three modes; each one has a specific behaviour that is useful for a different situation.

## — Locked

If the play cursor continues to play or stops at the end of a section, the video frame number locks to the timeline. When the play cursor holds at the end of a section, the video will play continuously.

## — FreeRun

If the play cursor continues to play or stops at the end of a section, the video will play continuously. Jumping around the timeline while the cursor is playing or has stopped does not affect which frame is being played.

## — Normal

When the play cursor stops, the video will also stop and the frame number will lock to the timeline position. When the cursor continues to play or holds at the end of a section, the video will play continuously. Jumping around the timeline while playing does not affect which frame is being played.

## — Paused

When playback reaches the end of the video clip, the clip will pause on the last frame.

# Radar

The Radar layer is one of the simplest generative layers. It generates a moving beam with a bright leading edge that fades to a black trailing edge.

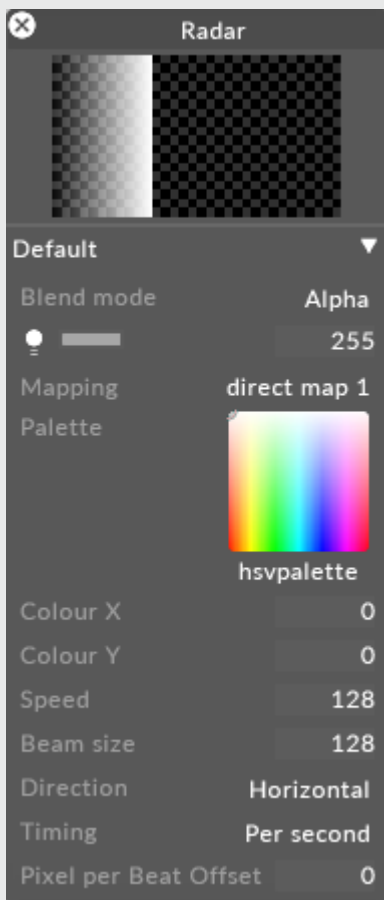

# Preview Thumbnail

This property is a small preview window at the top of the editor showing you what the layer output looks like.

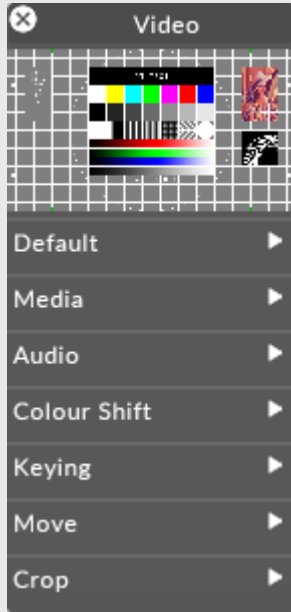

# Blend Mode

BlendMode controls how the output of the layer is composited with the layers below. Layers are rendered in a bottom-up order: layers at the top can modify the output of the layers below.

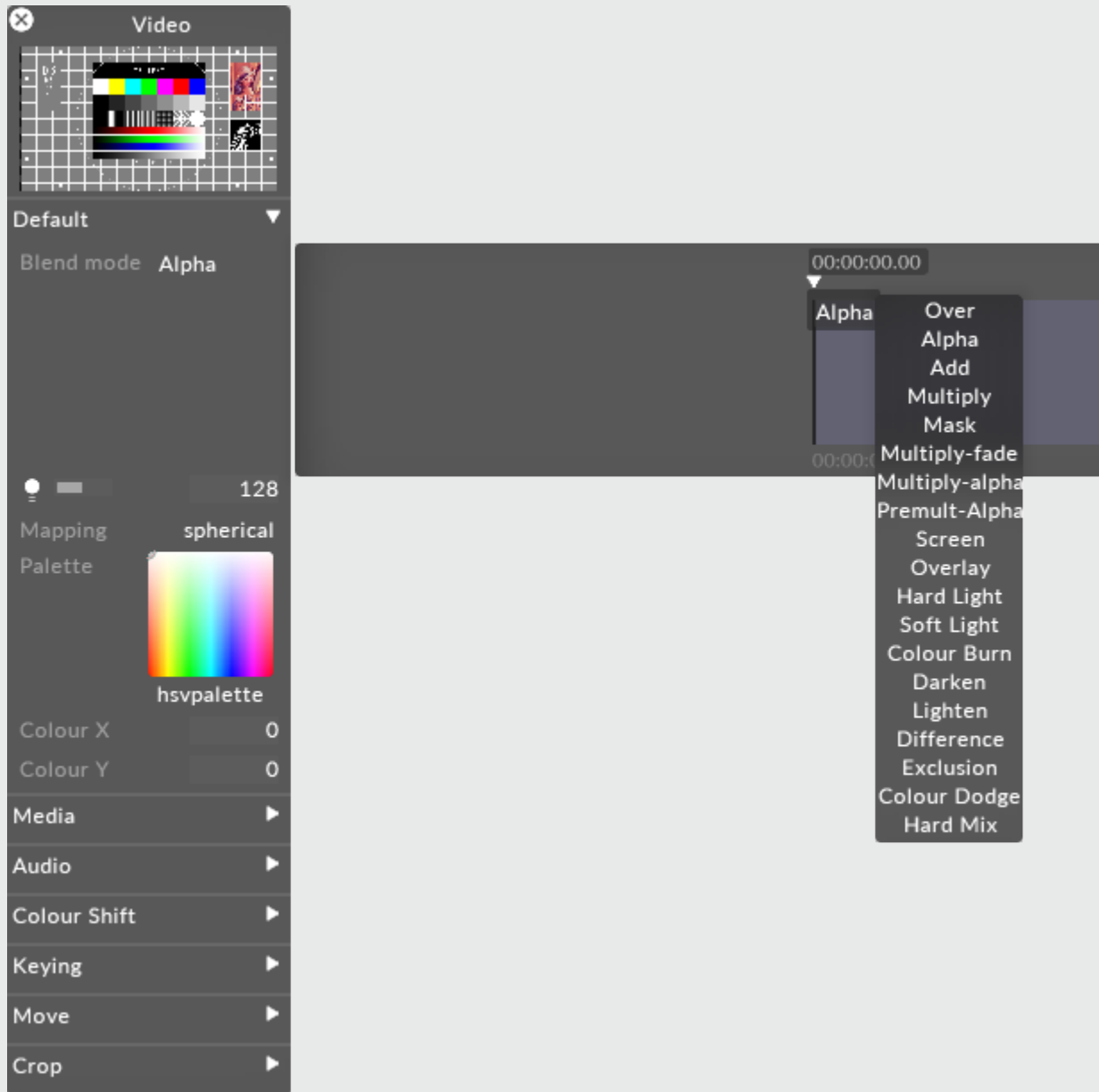

Changing brightness of a content layer in Disguise software is actually controlling the value of the alpha of the layer. Even when displaying a HAP video, the software will composite the layer with a controllable layer of alpha - one per layer.

There are two ways of expressing alpha in an image:

Straight alpha is an alpha channel which functions just like RGB. Alpha acts as a fourth channel of information per pixel which is as independent of the other three as R, G and B are of each other. For example, with straight alpha it is possible to have RGB = 255 (white) and alpha = 0 (fully transparent) on the same pixel. Internally generated content, such as gradient layer, are generated with straight alpha. This is the preferable style of alpha and considering the cleaner method of the two.

Premultiplied alpha takes the alpha and applies it to the values of the RGB channels per pixel. The more transparent something gets with premultiplied alpha, the closer it gets to black - as if the content is sitting on a black table. Premultiplied is the default output of Adobe Photoshop or AfterEffects. the result is our pixel at 255 RGB (full white) with 0 alpha would be calculated as a black pixel in the final image.

Here are explanations of what each individual blend mode will do.

## Over

Makes a layer fully opaque. Premultiplies all alpha onto the RGB value of each pixel. Alpha = black, so adjusting the brightness of a layer in Over blend mode makes it darker.

## Alpha

Default blend mode. It will apply alpha values as a transparency if the alpha is present. Brightness changes will make the layer more or less transparent.

## Add

Adds the value of each RGB pixel together. Always creates a brighter result. Values clamp at 255.

## Multiply

Reads the level of each subpixel as a level between 0.0 and 1.0, and multiplies source with blend. The result is always a darker image overall. For example: white x grey = 0.5. White turns transparent, black takes precedence. Alpha is applied in the same fashion as the Over Blend mode.

## Mask

Choose mask when you want to multiply out content upwards in the stack of layers, rather than downwards. In order to make this work you have to use the same mapping on the layer set to mask and the layer on top.

## Multiply-Fade

The same as Multiply, but will make use of the alpha channel to calculate transparency in the source and blend layers. Since maximum transparency is premultiplied, alpha results in black. This will ignore black created through premultiplying.

## Multiply-Alpha

Multiply with straight alpha. This mode assumes that the alpha has not been premultiplied onto the RGB values and will not apply a correction to the semi-transparent pixels.

## Premultiply Alpha

Like how Multiply-fade will ignore the darkening caused by premultiplying, this blend mode will do the same with Alpha.

## Colour Burn

Blend mode increases the contrast to darken the base colour while reflecting the blend colour. The darker the blend colour, the more intensely the colour will be applied in the base image. White as the blend colour produces no change. Using the colour burn blend mode can produce some harsh results at full opacity.

The colour burn blend mode can be used to make tonal and colour adjustments to a layer.

## Screen

This blend mode looks at each channels colour information and multiplies the inverse of the blend and base colour. The result is always a lighter colour. Screening with black leaves the colour unchanged. Screening with white produces white. The effect is similar to projecting multiple images on top of each other - where bright white is fully opaque, black is fully transparent and 50% grey is 50% transparent.



## Overlay

Multiplies or screens the colours, depending on the base colour. Patterns or colours overlay the existing pixels while preserving the highlights and shadows of the base colour. The base colour is not replaced, but mixed with the blend colour to reflect the lightness or darkness of the original colour.

## Hard Light

Multiplies or screens the colours, depending on the blend colour. The effect is similar to shining a harsh spotlight on the image. If the blend colour (light source/top layer) is lighter than 50% grey, the image is lightened as if it were screened. This is useful for adding highlights to an image. If the blend colour is darker than 50% grey, the image is darkened as if it were multiplied. This is useful for adding shadows to an image. Painting with pure black or white results in pure black or white.

## Soft Light

Darkens or lightens the colours, depending on the blend colour. The effect is similar to shining a diffused spotlight on the image. If the blend colour (light source/top layer) is lighter than 50% grey, the image is lightened as if it were dodged. If the blend colour is darker than 50% grey, the image is darkened as if it were burned in. Painting with pure black or white produces a distinctly darker or lighter area, but does not result in pure black or white.

## Darken

Looks at the colour information in each channel and selects the base or blend colour - whichever is darker - as the result colour. Pixels lighter than the blend colour are replaced and pixels darker than the blend colour do not change.

## Lighten

Looks at the colour information in each channel and selects the base or blend colour - whichever is lighter - as the result colour. Pixels darker than the blend colour are replaced and pixels lighter than the blend colour do not change.

## Difference

Looks at the colour information in each channel and subtracts either the blend colour from the base colour or the base colour from the blend colour depending on which has the greater brightness value.

Blending with white inverts the base colour values and blending with black produces no change.

## Exclusion

Creates an effects similar to but lower in contrast than the difference mode. Blending with white inverts the base colour values. Blending with black produces no change.

## Colour Dodge

Looks at the colour information in each channel and brightens the base colour to reflect the blend colour by decreasing contrast between the two. Blending with black produces no change.

## Hard Mix

Adds the RGB channels of the blend colour to the RGB values of the base colour. If the resulting sum for a channel is 255 or greater, it receives a value of 255; if it is less than 255 it receives a value of 0. Therefore all blended pixels have RGB channels of either 0 or 255. This changes all pixels to primary additive colours (RGB), white or black.

## Brightness

This property (which appears as a light bulb icon) controls the brightness of the layer output.

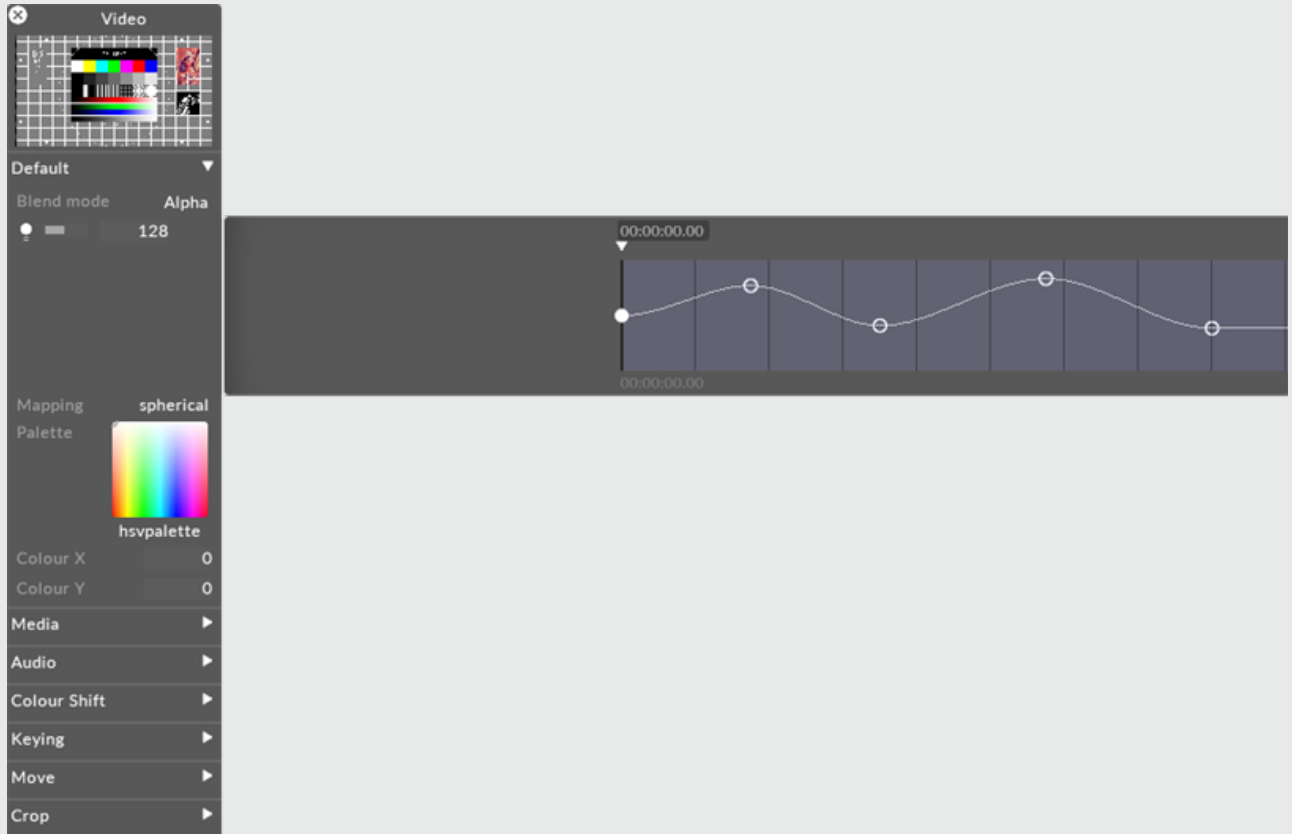

If the layers blend mode is set to Alpha, then reducing the brightness to 0 also reduces the opacity of the layer to 0. This can be useful when you want to dissolve from one layer to the next. In that case, you can place the new layer above the old layer and increase its brightness level.

## Mapping

The mapping property controls how the layer output is mapped onto the screen(s) in the Stage level.

**Video**

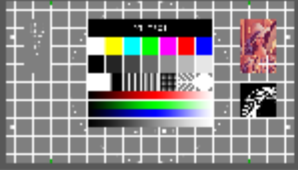

Default ▾

Blend mode Alpha

128

Mapping direct map 1

Palette



hsvpalette

Colour X 0

Colour Y 0

Media ▾

Video



d3\_test\_16-9.png

Speed 1

Mode Normal

At end point Loop

Transition time 0

Audio ▶

Colour Shift ▶

Keying ▶

Move ▶

Crop ▶

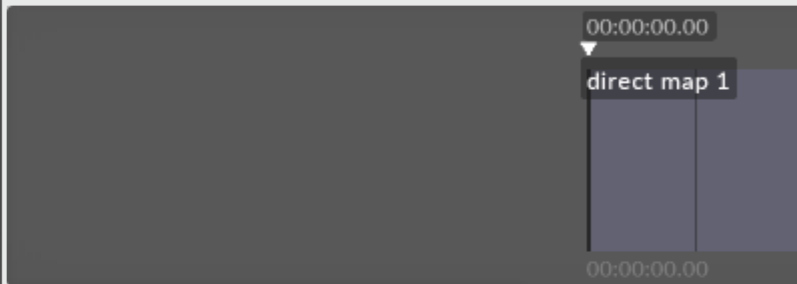

00:00:00.00

direct map 1

00:00:00.00

**mappings**

New mapping: OK Search:

all New Mappings

- direct map 1
- feed map 2
- feed mapping
- mapping 1
- mapping 2
- parallel
- spherical

For information on mapping, including how to use the different mapping types offered by Disguise software, please see the chapter [Content Mapping](#).

## Palette

This points to the still image file that defines the bitmap from which the tint colour is taken. The default palette ( HSVPAL ) consists of the complete range of hues and saturations. Selecting this property will open the Texture object library, which shows all of the still image files saved on your local hard-drive in the **DxTexture** folder.

To control the location within the current palette bitmap, and thus control the colour, you have to edit the **xCol** and **yCol** values (see the section for xCol, yCol).

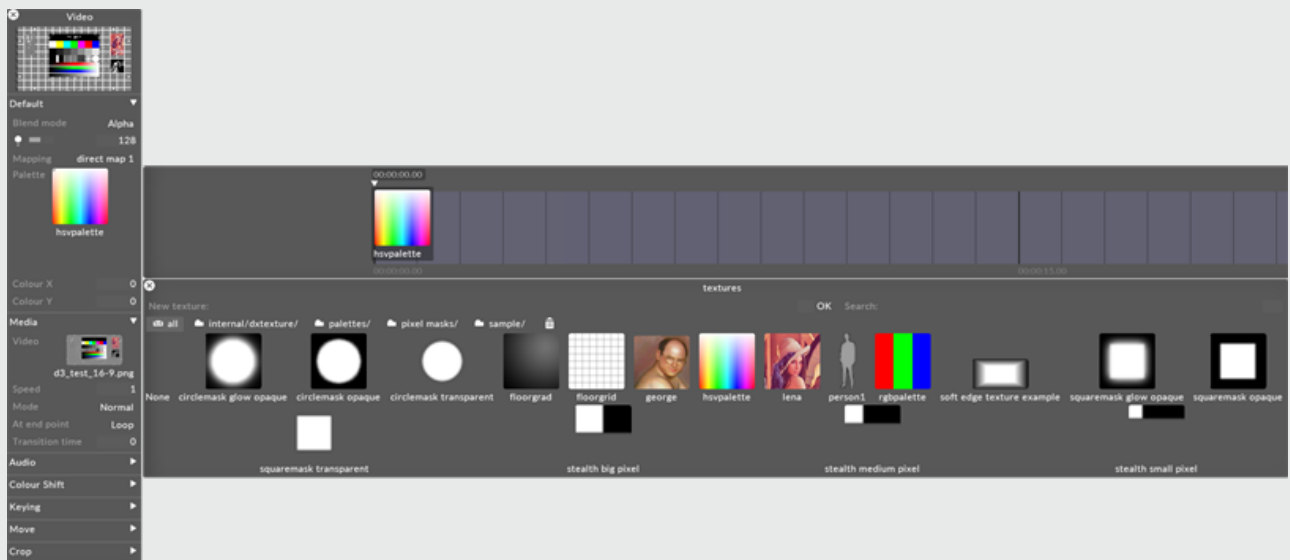

To change the current palette bitmap:

1. Left-click **palette** to open the Texture object library.
2. Left-click the still image file you want to use for the palette bitmap.

If you want to use a palette bitmap other than the standard still images provided in Disguise software, you will need to use a custom still image file.

See the [Placing media files for a project](#) sub-chapter to understand where to place a custom still image file and how to access it in Disguise software. Also save the file to a [supported file format](#).

## xCol y Col

These properties control the coordinates within the current palette bitmap where the output colour is sampled from. The default value is 0,0 which points at the color white (if you are using the HSVPAL palette). Multiplying white with the colors of the chosen content simply generates the original content colors. **Colour X** controls the horizontal position, where 0 is the leftmost edge and 255 is the rightmost edge. **Colour Y** controls the vertical position, where 0 is the top edge and 255 is the bottom edge.

For example, to saturate the video clip red, change the **Colour Y** value to 255 and use 0 for the **Colour X** value. These coordinates refer to the color red in the palette which is being multiplied with the colors of the existing content.

When you are using the default palette HSVPAL , **Colour Y** controls saturation, and **Colour X** controls hue.

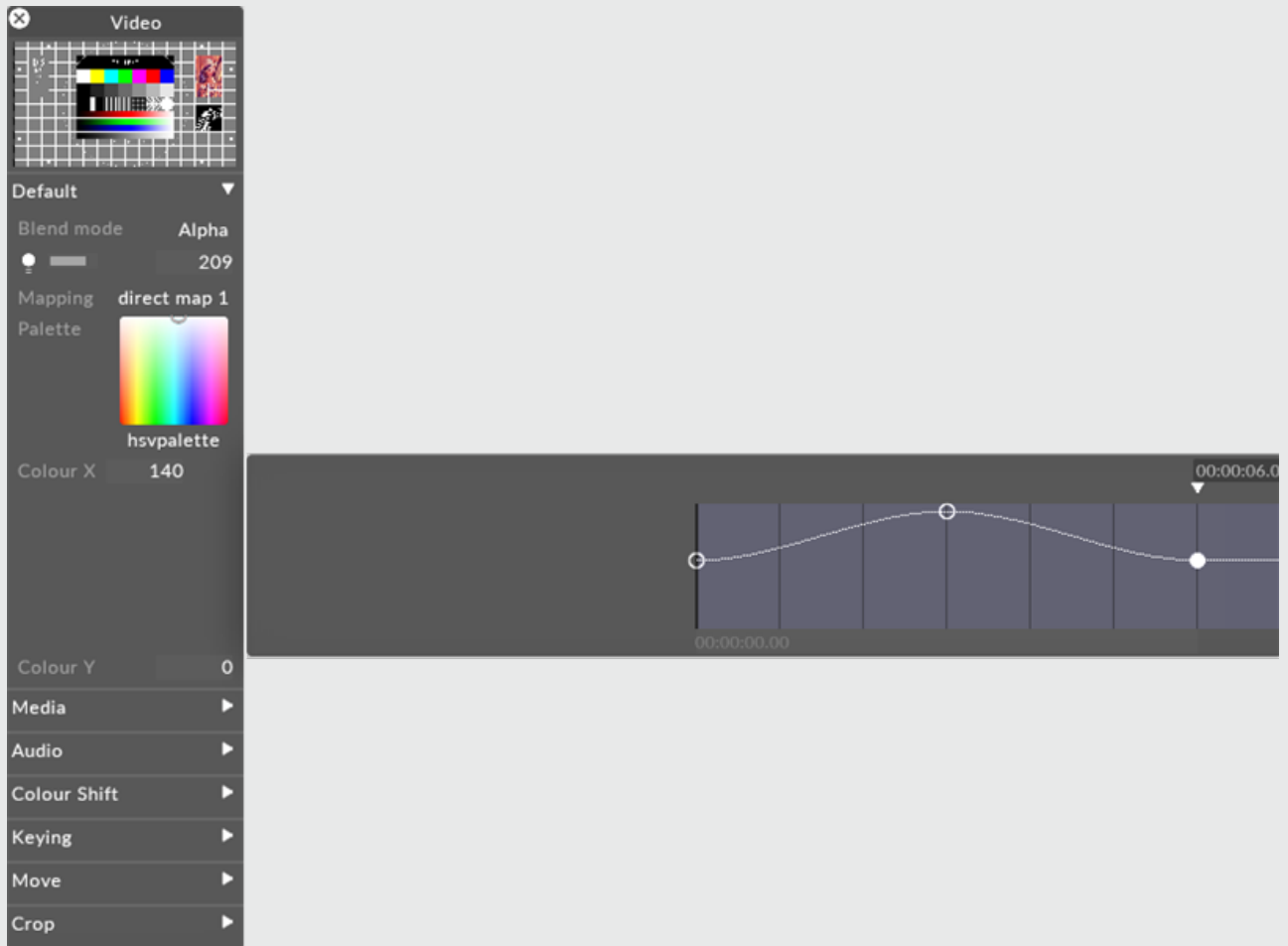

## Speed

This controls the speed of the beam movement. Positive numbers go rightwards/downwards; negative numbers go leftwards/upwards.

## Beam Size

This controls the size of the beam. When set to 255, the width of the beam is the same as the width of the canvas.

## Direction

This is an option property; the two options are **horizontal** and **vertical**.

## Timing

This controls how the **speed** property is interpreted. The options are:

**Per sec** : the radar beam moves at x pixels per second, regardless of how the play cursor moves. This means that the radar beam position is not predictable anywhere on the timeline.

**Per beat** : the radar beam moves at a speed related to the current bpm, so that it moves an integer number of complete sweeps per beat. Furthermore, the position of the beam depends on the timeline position, so the beam is guaranteed to be at the same position at the start of every beat.

**Per frame** : the radar beam moves x pixels every frame.



# Readout

This layer allows you to assign the incoming timecode, remaining section time, or system time to a screen via a mapping to show on the output as well as in the stage.

## Display property

The Display property allows you to switch between readouts for the incoming timecode, MTC layer, Timeline, Section, Video timecode, Time and Output Debuggers, and System time readouts.

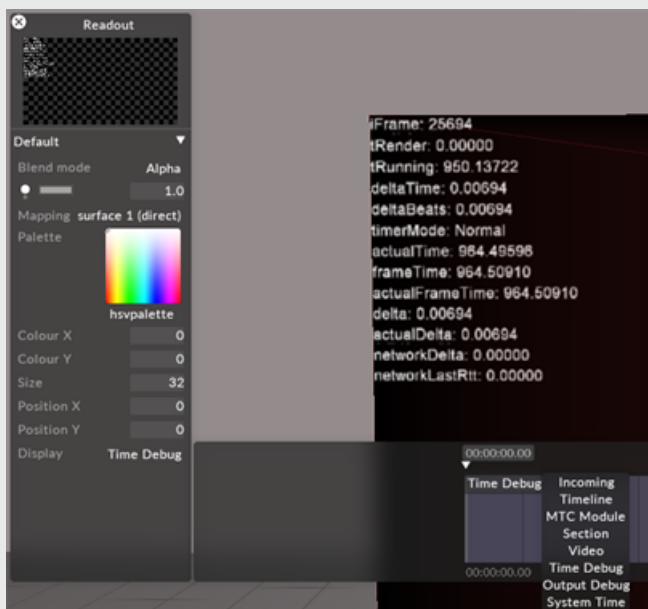

## Common layer properties

For information on the common layer properties "Mapping:", "Palette", "Colour x/y", "Size", and "Position x/y", please visit [this link](#)

# RGBColour

The RGBColour layer is one of the most basic layers. It behaves in a very similar way to the Colour layer. Quite simply, it allows you to manually set RGBColour values to display a solid colour.

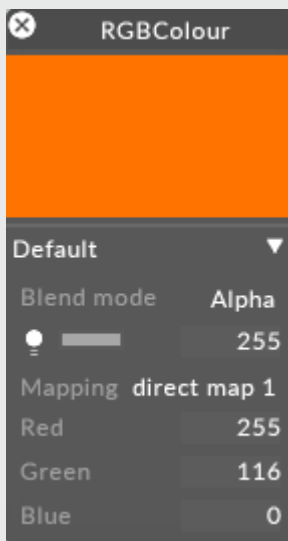

## Preview Thumbnail

This property is a small preview window at the top of the editor showing you what the layer output looks like.



## Blend Mode

BlendMode controls how the output of the layer is composited with the layers below. Layers are rendered in a bottom-up order: layers at the top can modify the output of the layers below.

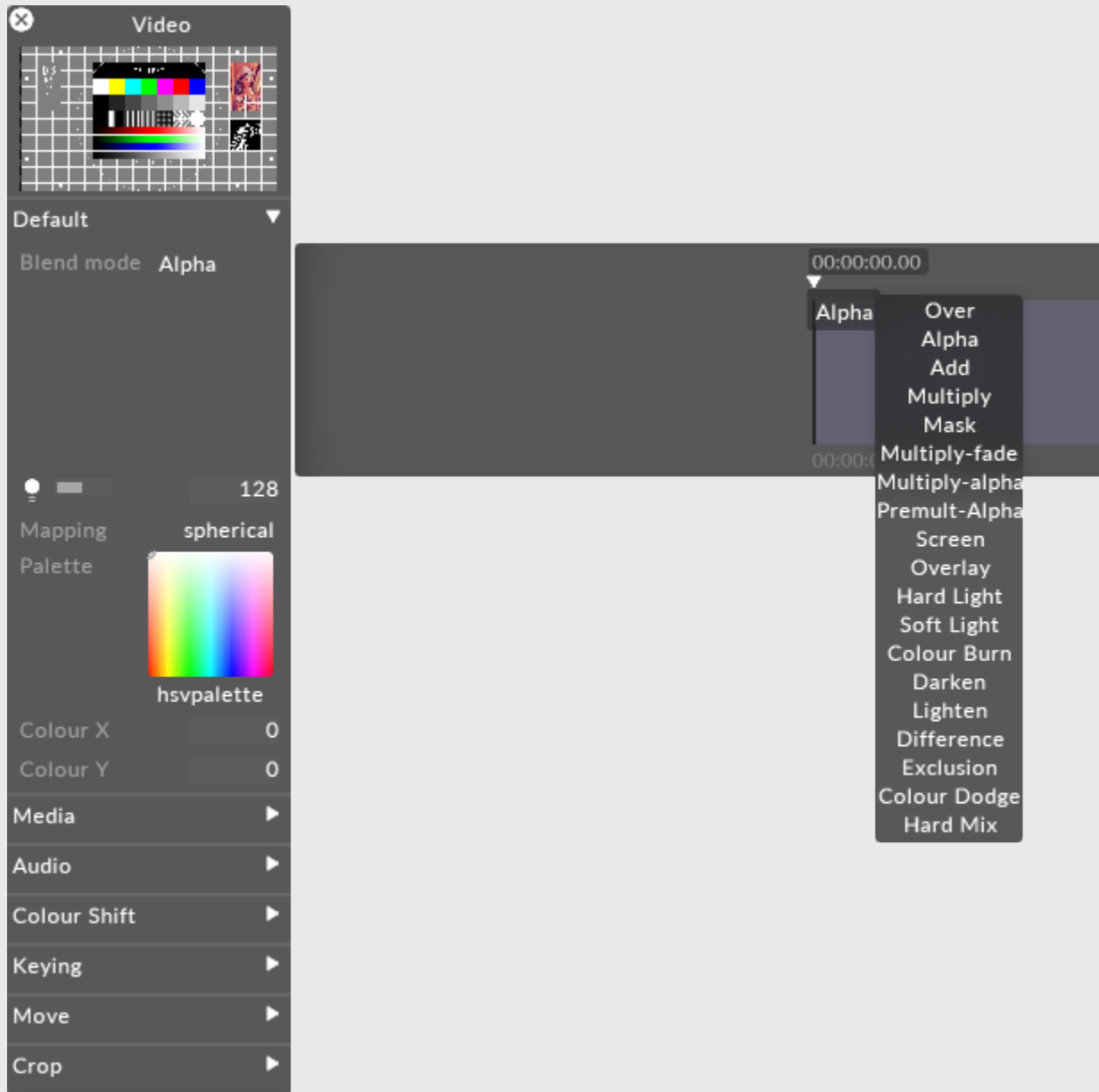

Changing brightness of a content layer in Disguise software is actually controlling the value of the alpha of the layer. Even when displaying a HAP video, the software will composite the layer with a controllable layer of alpha - one per layer.

There are two ways of expressing alpha in an image:

Straight alpha is an alpha channel which functions just like RGB. Alpha acts as a fourth channel of information per pixel which is as independent of the other three as R, G and B are of each other. For example, with straight alpha it is possible to have RGB = 255 (white) and alpha = 0 (fully transparent) on the same pixel. Internally generated content, such as gradient layer, are generated with straight alpha. This is the preferable style of alpha and considering the cleaner method of the two.

Premultiplied alpha takes the alpha and applies it to the values of the RGB channels per pixel. The more transparent something gets with premultiplied alpha, the closer it gets to black - as if the content is sitting on a black table. Premultiplied is the default output of Adobe Photoshop or AfterEffects. the result is our pixel at 255 RGB (full white) with 0 alpha would be calculated as a black pixel in the final image.

Here are explanations of what each individual blend mode will do.

## Over

Makes a layer fully opaque. Premultiplies all alpha onto the RGB value of each pixel. Alpha = black, so adjusting the brightness of a layer in Over blend mode makes it darker.

## Alpha

Default blend mode. It will apply alpha values as a transparency if the alpha is present. Brightness changes will make the layer more or less transparent.

## Add

Adds the value of each RGB pixel together. Always creates a brighter result. Values clamp at 255.

## Multiply

Reads the level of each subpixel as a level between 0.0 and 1.0, and multiplies source with blend. The result is always a darker image overall. For example: white x grey = 0.5. White turns transparent, black takes precedence. Alpha is applied in the same fashion as the Over Blend mode.

## Mask

Choose mask when you want to multiple out content upwards in the stack of layers, rather than downwards. In order to make this work you have to use the same mapping on the layer set to mask and the layer on top.

## Multiply-Fade

The same as Multiply, but will make use of the alpha channel to calculate transparency in the source and blend layers. Since maximum transparency is premultiplied, alpha results in black. This will ignore black created through premultiplying.

## Multiply-Alpha

Multiply with straight alpha. This mode assumes that the alpha has not been premultiplied onto the RGB values and will not apply a correction to the semi-transparent pixels.

## Premultiply Alpha

Like how Multiply-fade will ignore the darkening caused by premultiplying, this blend mode will do the same with Alpha.

## Colour Burn

Blend mode increases the contrast to darken the base colour while reflecting the blend colour. The darker the blend colour, the more intensely the colour will be applied in the base image. White as the blend colour produces no change. Using the colour burn blend mode can produce some harsh results at full opacity.

The colour burn blend mode can be used to make tonal and colour adjustments to a layer.

## Screen

This blend mode looks at each channels colour information and multiplies the inverse of the blend and base colour. The result is always a lighter colour. Screening with black leaves the colour unchanged. Screening with white produces white. The effect is similar to projecting multiple images on top of each other - where bright white is fully opaque, black is fully transparent and 50% grey is 50% transparent.

## Overlay

Multiplies or screens the colours, depending on the base colour. Patterns or colours overlay the existing pixels while preserving the highlights and shadows of the base colour. The base colour is not replaced, but mixed with the blend colour to reflect the lightness or darkness of the original colour.

## Hard Light

Multiplies or screens the colours, depending on the blend colour. The effect is similar to shining a harsh spotlight on the image. If the blend colour (light source/top layer) is lighter than 50% grey, the image is lightened as if it were screened. This is useful for adding highlights to an image. If the blend colour is darker than 50% grey, the image is darkened as if it were multiplied. This is useful for adding shadows to an image. Painting with pure black or white results in pure black or white.

## Soft Light

Darkens or lightens the colours, depending on the blend colour. The effect is similar to shining a diffused spotlight on the image. If the blend colour (light source/top layer) is lighter than 50% grey, the image is lightened as if it were dodged. If the blend colour is darker than 50% grey, the image is darkened as if it were burned in. Painting with pure black or white produces a distinctly darker or lighter area, but does not result in pure black or white.

## Darken

Looks at the colour information in each channel and selects the base or blend colour - whichever is darker - as the result colour. Pixels lighter than the blend colour are replaced and pixels darker than the blend colour do not change.

## Lighten

Looks at the colour information in each channel and selects the base or blend colour - whichever is lighter - as the result colour. Pixels darker than the blend colour are replaced and pixels lighter than the blend colour do not change.

## Difference

Looks at the colour information in each channel and subtracts either the blend colour from the base colour or the base colour from the blend colour depending on which has the greater brightness value.

Blending with white inverts the base colour values and blending with black produces no change.

## Exclusion

Creates an effects similar to but lower in contrast than the difference mode. Blending with white inverts the base colour values. Blending with black produces no change.

## Colour Dodge

Looks at the colour information in each channel and brightens the base colour to reflect the blend colour by decreasing contrast between the two. Blending with black produces no change.

## Hard Mix

Adds the RGB channels of the blend colour to the RGB values of the base colour. If the resulting sum for a channel is 255 or greater, it receives a value of 255; if it is less than 255 it receives a value of 0. Therefore all blended pixels have RGB channels of either 0 or 255. This changes all pixels to primary additive colours (RGB), white or black.

## Brightness

This property (which appears as a light bulb icon) controls the brightness of the layer output.



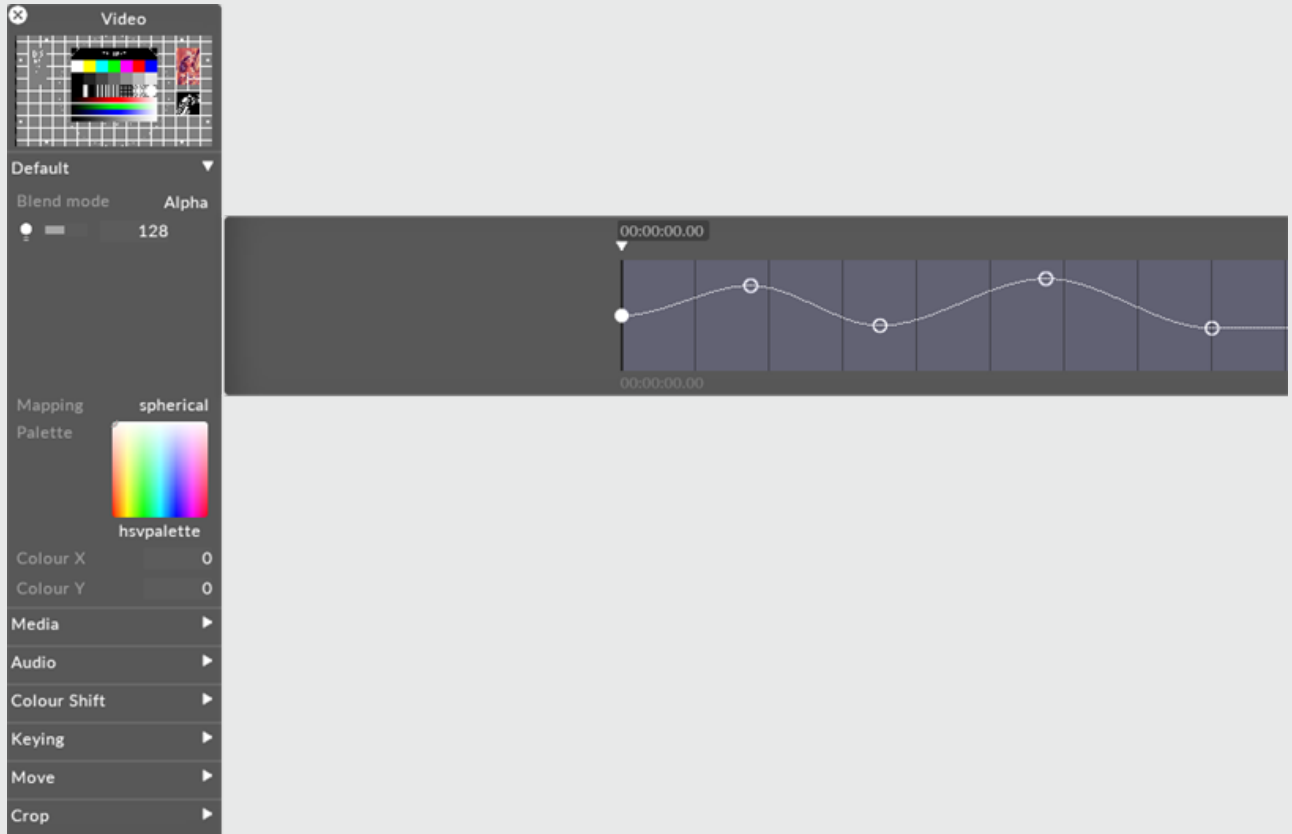

If the layers blend mode is set to Alpha, then reducing the brightness to 0 also reduces the opacity of the layer to 0. This can be useful when you want to dissolve from one layer to the next. In that case, you can place the new layer above the old layer and increase its brightness level.

## Mapping

The mapping property controls how the layer output is mapped onto the screen(s) in the Stage level.

**Video**

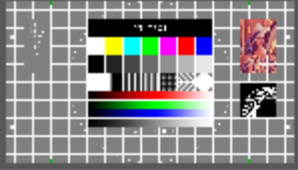

Default ▾

Blend mode Alpha

128

Mapping direct map 1

Palette



hsvpalette

Colour X 0

Colour Y 0

Media ▾

Video



d3\_test\_16-9.png

Speed 1

Mode Normal

At end point Loop

Transition time 0

Audio ▶

Colour Shift ▶

Keying ▶

Move ▶

Crop ▶

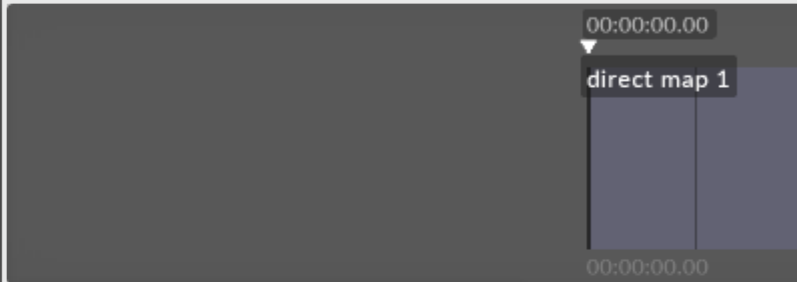

00:00:00.00

direct map 1

00:00:00.00

**mappings**

New mapping: OK Search:

all New Mappings

- direct map 1
- feed map 2
- feed mapping
- mapping 1
- mapping 2
- parallel
- spherical

For information on mapping, including how to use the different mapping types offered by Disguise software, please see the chapter [Content Mapping](#).

## Red

Controls the Red additive colour mix.

## Green

Controls the Green additive colour mix.

## Blue

Controls the Blue additive colour mix.

# Scan

The Scan layer is a simple test pattern generator that is useful for checking output signal timings. It generates a single-pixel wide horizontal red line and a single-pixel wide vertical blue line. Each line moves forward by a single pixel per frame.

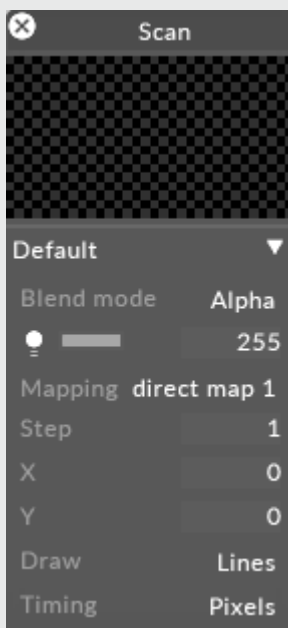

It sometimes happens that downstream DVI processing devices such as switchers, scalers or LED processors skew the timing of the DVI signal, causing the appearance of jerky playback. At such times it is useful to be able to generate a visual signal that is visibly smooth on the computer, but clearly shows signal skews on the output devices.

The Scan layer is also useful for checking if the 3D screen models have been correctly imported into Disguise software. If the model has incorrect texture coordinates, you will see a single row or column either disappearing or spanning two separate sub-objects.

# Preview Thumbnail

This property is a small preview window at the top of the editor showing you what the layer output looks like.

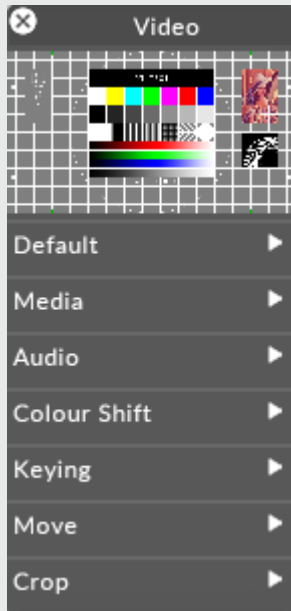

# Blend Mode

BlendMode controls how the output of the layer is composited with the layers below. Layers are rendered in a bottom-up order: layers at the top can modify the output of the layers below.

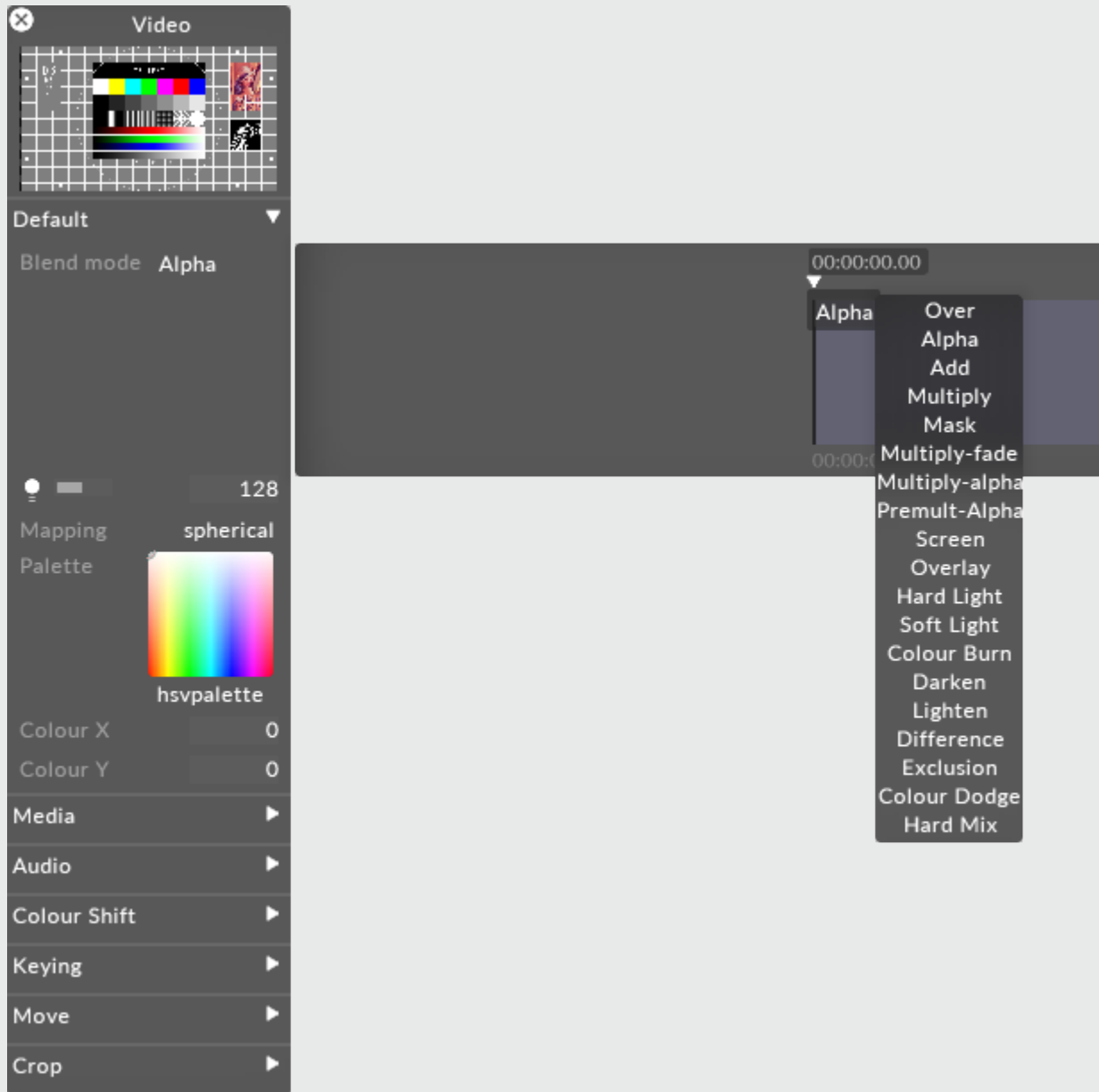

Changing brightness of a content layer in Disguise software is actually controlling the value of the alpha of the layer. Even when displaying a HAP video, the software will composite the layer with a controllable layer of alpha - one per layer.

There are two ways of expressing alpha in an image:

Straight alpha is an alpha channel which functions just like RGB. Alpha acts as a fourth channel of information per pixel which is as independent of the other three as R, G and B are of each other. For example, with straight alpha it is possible to have RGB = 255 (white) and alpha = 0 (fully transparent) on the same pixel. Internally generated content, such as gradient layer, are generated with straight alpha. This is the preferable style of alpha and considering the cleaner method of the two.

Premultiplied alpha takes the alpha and applies it to the values of the RGB channels per pixel. The more transparent something gets with premultiplied alpha, the closer it gets to black - as if the content is sitting on a black table. Premultiplied is the default output of Adobe Photoshop or AfterEffects. the result is our pixel at 255 RGB (full white) with 0 alpha would be calculated as a black pixel in the final image.

Here are explanations of what each individual blend mode will do.

## Over

Makes a layer fully opaque. Premultiplies all alpha onto the RGB value of each pixel. Alpha = black, so adjusting the brightness of a layer in Over blend mode makes it darker.

## Alpha

Default blend mode. It will apply alpha values as a transparency if the alpha is present. Brightness changes will make the layer more or less transparent.

## Add

Adds the value of each RGB pixel together. Always creates a brighter result. Values clamp at 255.

## Multiply

Reads the level of each subpixel as a level between 0.0 and 1.0, and multiplies source with blend. The result is always a darker image overall. For example: white x grey = 0.5. White turns transparent, black takes precedence. Alpha is applied in the same fashion as the Over Blend mode.

## Mask

Choose mask when you want to multiple out content upwards in the stack of layers, rather than downwards. In order to make this work you have to use the same mapping on the layer set to mask and the layer on top.

## Multiply-Fade

The same as Multiply, but will make use of the alpha channel to calculate transparency in the source and blend layers. Since maximum transparency is premultiplied, alpha results in black. This will ignore black created through premultiplying.

## Multiply-Alpha

Multiply with straight alpha. This mode assumes that the alpha has not been premultiplied onto the RGB values and will not apply a correction to the semi-transparent pixels.

## Premultiply Alpha

Like how Multiply-fade will ignore the darkening caused by premultiplying, this blend mode will do the same with Alpha.

## Colour Burn

Blend mode increases the contrast to darken the base colour while reflecting the blend colour. The darker the blend colour, the more intensely the colour will be applied in the base image. White as the blend colour produces no change. Using the colour burn blend mode can produce some harsh results at full opacity.

The colour burn blend mode can be used to make tonal and colour adjustments to a layer.

## Screen

This blend mode looks at each channels colour information and multiplies the inverse of the blend and base colour. The result is always a lighter colour. Screening with black leaves the colour unchanged. Screening with white produces white. The effect is similar to projecting multiple images on top of each other - where bright white is fully opaque, black is fully transparent and 50% grey is 50% transparent.



## Overlay

Multiplies or screens the colours, depending on the base colour. Patterns or colours overlay the existing pixels while preserving the highlights and shadows of the base colour. The base colour is not replaced, but mixed with the blend colour to reflect the lightness or darkness of the original colour.

## Hard Light

Multiplies or screens the colours, depending on the blend colour. The effect is similar to shining a harsh spotlight on the image. If the blend colour (light source/top layer) is lighter than 50% grey, the image is lightened as if it were screened. This is useful for adding highlights to an image. If the blend colour is darker than 50% grey, the image is darkened as if it were multiplied. This is useful for adding shadows to an image. Painting with pure black or white results in pure black or white.

## Soft Light

Darkens or lightens the colours, depending on the blend colour. The effect is similar to shining a diffused spotlight on the image. If the blend colour (light source/top layer) is lighter than 50% grey, the image is lightened as if it were dodged. If the blend colour is darker than 50% grey, the image is darkened as if it were burned in. Painting with pure black or white produces a distinctly darker or lighter area, but does not result in pure black or white.

## Darken

Looks at the colour information in each channel and selects the base or blend colour - whichever is darker - as the result colour. Pixels lighter than the blend colour are replaced and pixels darker than the blend colour do not change.

## Lighten

Looks at the colour information in each channel and selects the base or blend colour - whichever is lighter - as the result colour. Pixels darker than the blend colour are replaced and pixels lighter than the blend colour do not change.

## Difference

Looks at the colour information in each channel and subtracts either the blend colour from the base colour or the base colour from the blend colour depending on which has the greater brightness value.

Blending with white inverts the base colour values and blending with black produces no change.

## Exclusion

Creates an effects similar to but lower in contrast than the difference mode. Blending with white inverts the base colour values. Blending with black produces no change.

## Colour Dodge

Looks at the colour information in each channel and brightens the base colour to reflect the blend colour by decreasing contrast between the two. Blending with black produces no change.

## Hard Mix

Adds the RGB channels of the blend colour to the RGB values of the base colour. If the resulting sum for a channel is 255 or greater, it receives a value of 255; if it is less than 255 it receives a value of 0. Therefore all blended pixels have RGB channels of either 0 or 255. This changes all pixels to primary additive colours (RGB), white or black.

## Brightness

This property (which appears as a light bulb icon) controls the brightness of the layer output.

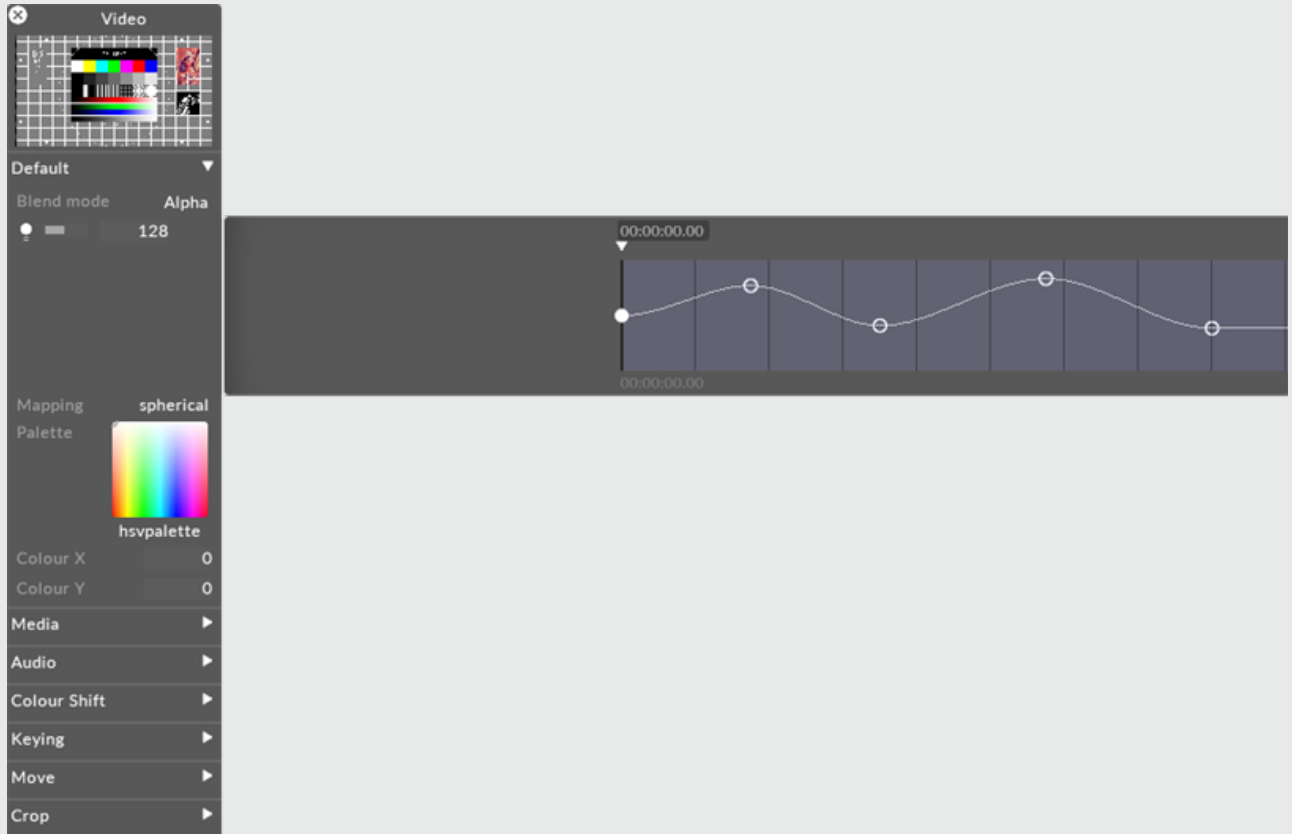

If the layers blend mode is set to Alpha, then reducing the brightness to 0 also reduces the opacity of the layer to 0. This can be useful when you want to dissolve from one layer to the next. In that case, you can place the new layer above the old layer and increase its brightness level.

## Mapping

The mapping property controls how the layer output is mapped onto the screen(s) in the Stage level.

**Video**

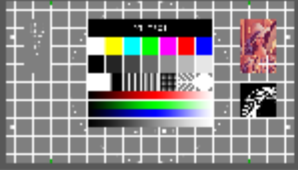

Default ▾

Blend mode Alpha

128

Mapping direct map 1

Palette



hsvpalette

Colour X 0

Colour Y 0

Media ▾

Video



d3\_test\_16-9.png

Speed 1

Mode Normal

At end point Loop

Transition time 0

Audio ▶

Colour Shift ▶

Keying ▶

Move ▶

Crop ▶

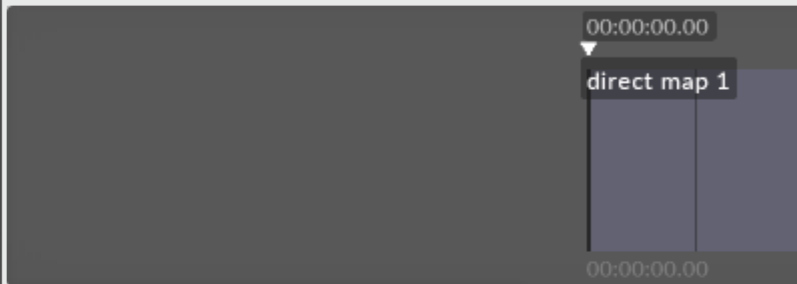

00:00:00.00

direct map 1

00:00:00.00

**mappings**

New mapping: OK Search:

all New Mappings

- direct map 1
- feed map 2
- feed mapping
- mapping 1
- mapping 2
- parallel
- spherical

For information on mapping, including how to use the different mapping types offered by Disguise software, please see the chapter [Content Mapping](#).

## Step

This controls the movement speed of the lines. The number you fill is is the number of frames the lines moves forward per pixel. Increasing this number slows the line down. Setting **step** to 0 allows you to control the position of the lines manually using the **x** and **y** properties.

## X, y

When **step** is set to 0, you can directly control the position of the lines by adjusting **x** and **y**. The position of the vertical blue line is controlled by **x**, while the position of the horizontal red line is controlled by **y**. Both are measured in pixels.

## Draw

There are two options:

**Lines** : this shows red and blue lines which intersect to form a crosshair (useful for LED screens).

**Dot** : this shows a single white dot at position x, y. This option is more useful when calibrating singlepixel strings (useful for linear fixtures).

## Timing

There are two options:

**Pixels** : if set to this, the crosshair moves one pixel every (step) frames.

**Time** : if set to this, the crosshair moves at (1/step) pixels per second.

# Strobe

The Strobe layer creates a flashing strobe effect over multiple screens.



**Warning:** The Strobe layer only works using a Feed map. In order to turn each screen into "one flash", scale each feed rectangle to 1 pixel and place each screen's feed rectangles next to each other on the Mapping canvas.

Some Generative layers take their source from other layer types - either content or generative - by use of an arrow. Linking two layers with an arrow defines the arrowed from layer as the source, and the arrowed to layer as the destination. If you have an arrow between a content layer and effect layer, it is said that the content layer is being 'piped in' to the effect layer. For more information on arrows, see the [compositing layers topic](#).

To draw an arrow between two layers, hold down **ALT** and left click & drag between the source and destination layer.

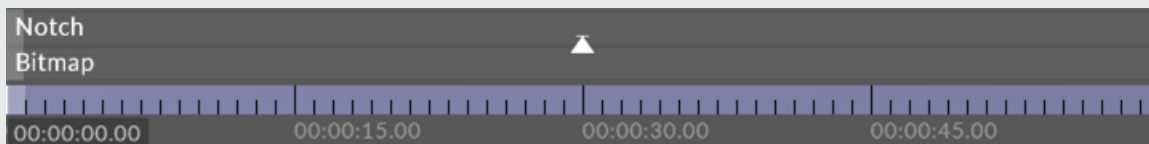

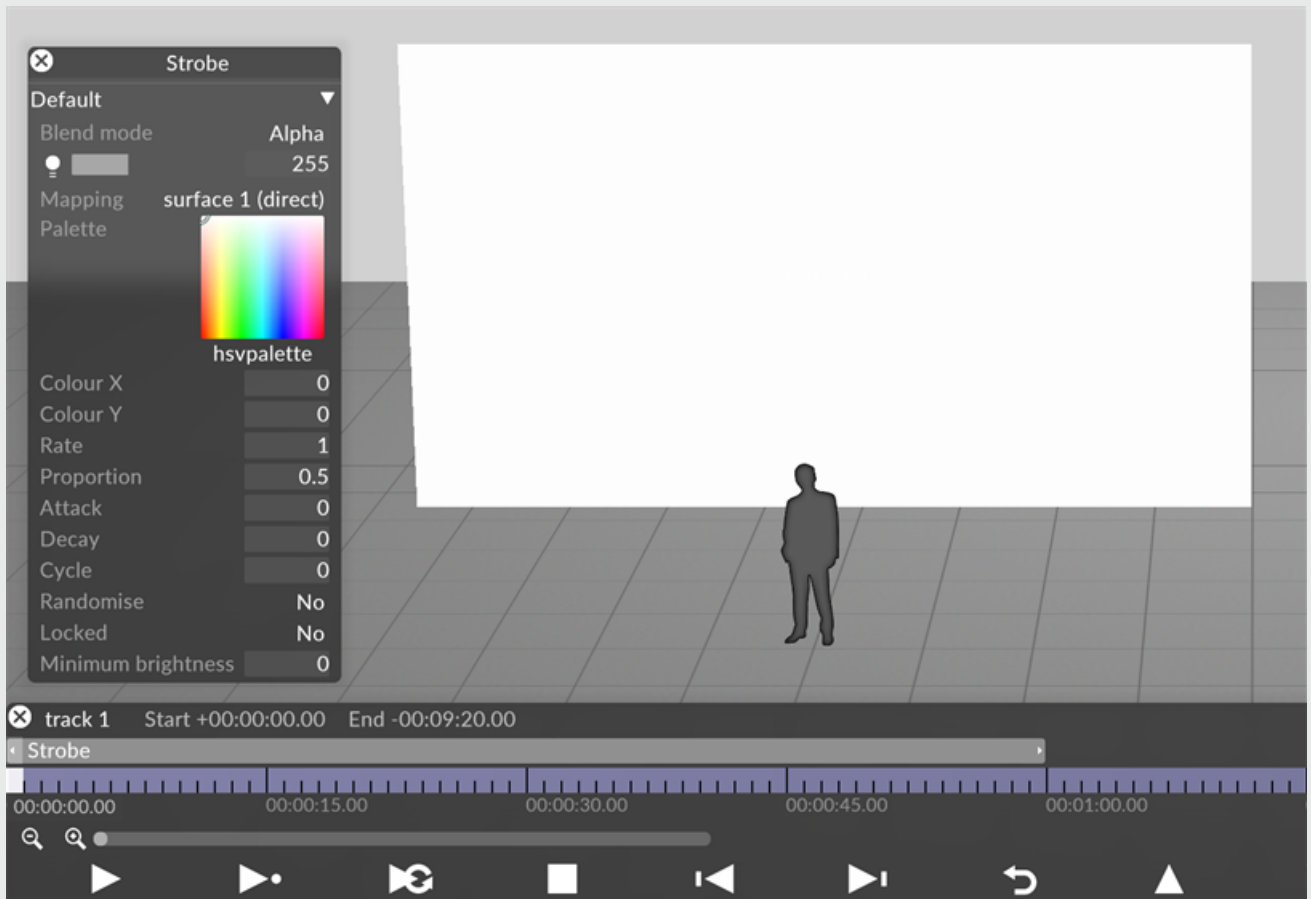

## Blend Mode

BlendMode controls how the output of the layer is composited with the layers below. Layers are rendered in a bottom-up order: layers at the top can modify the output of the layers below.

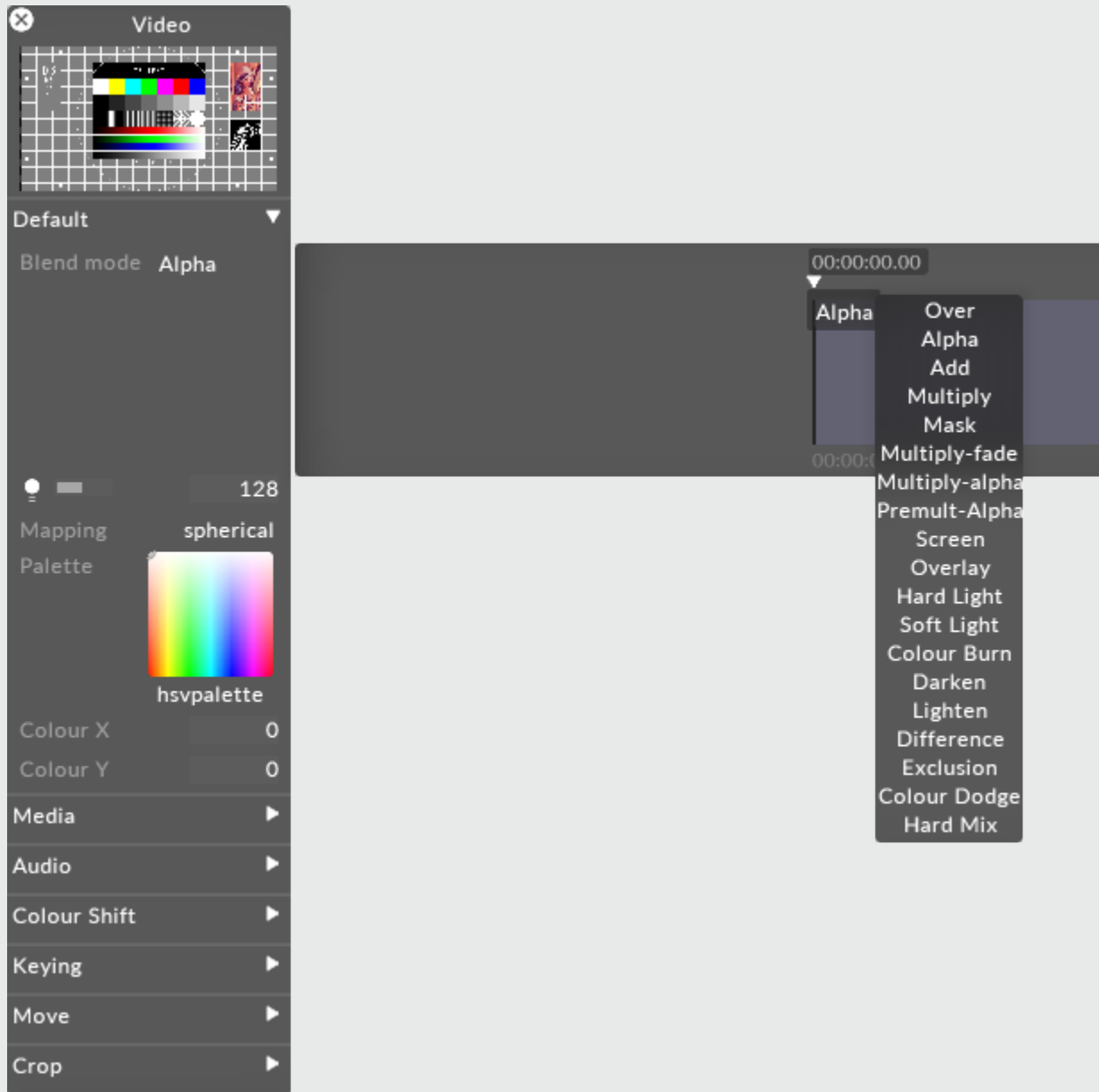

Changing brightness of a content layer in Disguise software is actually controlling the value of the alpha of the layer. Even when displaying a HAP video, the software will composite the layer with a controllable layer of alpha - one per layer.



There are two ways of expressing alpha in an image:

Straight alpha is an alpha channel which functions just like RGB. Alpha acts as a fourth channel of information per pixel which is as independent of the other three as R, G and B are of each other. For example, with straight alpha it is possible to have RGB = 255 (white) and alpha = 0 (fully transparent) on the same pixel. Internally generated content, such as gradient layer, are generated with straight alpha. This is the preferable style of alpha and considering the cleaner method of the two.

Premultiplied alpha takes the alpha and applies it to the values of the RGB channels per pixel. The more transparent something gets with premultiplied alpha, the closer it gets to black - as if the content is sitting on a black table. Premultiplied is the default output of Adobe Photoshop or AfterEffects. the result is our pixel at 255 RGB (full white) with 0 alpha would be calculated as a black pixel in the final image.

Here are explanations of what each individual blend mode will do.

## Over

Makes a layer fully opaque. Premultiplies all alpha onto the RGB value of each pixel. Alpha = black, so adjusting the brightness of a layer in Over blend mode makes it darker.

## Alpha

Default blend mode. It will apply alpha values as a transparency if the alpha is present. Brightness changes will make the layer more or less transparent.

## Add

Adds the value of each RGB pixel together. Always creates a brighter result. Values clamp at 255.

## Multiply

Reads the level of each subpixel as a level between 0.0 and 1.0, and multiplies source with blend. The result is always a darker image overall. For example: white x grey = 0.5. White turns transparent, black takes precedence. Alpha is applied in the same fashion as the Over Blend mode.

## Mask

Choose mask when you want to multiple out content upwards in the stack of layers, rather than downwards. In order to make this work you have to use the same mapping on the layer set to mask and the layer on top.

## Multiply-Fade

The same as Multiply, but will make use of the alpha channel to calculate transparency in the source and blend layers. Since maximum transparency is premultiplied, alpha results in black. This will ignore black created through premultiplying.

## Multiply-Alpha

Multiply with straight alpha. This mode assumes that the alpha has not been premultiplied onto the RGB values and will not apply a correction to the semi-transparent pixels.

## Premultiply Alpha

Like how Multiply-fade will ignore the darkening caused by premultiplying, this blend mode will do the same with Alpha.

## Colour Burn

Blend mode increases the contrast to darken the base colour while reflecting the blend colour. The darker the blend colour, the more intensely the colour will be applied in the base image. White as the blend colour produces no change. Using the colour burn blend mode can produce some harsh results at full opacity.

The colour burn blend mode can be used to make tonal and colour adjustments to a layer.

## Screen

This blend mode looks at each channels colour information and multiplies the inverse of the blend and base colour. The result is always a lighter colour. Screening with black leaves the colour unchanged. Screening with white produces white. The effect is similar to projecting multiple images on top of each other - where bright white is fully opaque, black is fully transparent and 50% grey is 50% transparent.

## Overlay

Multiplies or screens the colours, depending on the base colour. Patterns or colours overlay the existing pixels while preserving the highlights and shadows of the base colour. The base colour is not replaced, but mixed with the blend colour to reflect the lightness or darkness of the original colour.

## Hard Light

Multiplies or screens the colours, depending on the blend colour. The effect is similar to shining a harsh spotlight on the image. If the blend colour (light source/top layer) is lighter than 50% grey, the image is lightened as if it were screened. This is useful for adding highlights to an image. If the blend colour is darker than 50% grey, the image is darkened as if it were multiplied. This is useful for adding shadows to an image. Painting with pure black or white results in pure black or white.

## Soft Light

Darkens or lightens the colours, depending on the blend colour. The effect is similar to shining a diffused spotlight on the image. If the blend colour (light source/top layer) is lighter than 50% grey, the image is lightened as if it were dodged. If the blend colour is darker than 50% grey, the image is darkened as if it were burned in. Painting with pure black or white produces a distinctly darker or lighter area, but does not result in pure black or white.

## Darken

Looks at the colour information in each channel and selects the base or blend colour - whichever is darker - as the result colour. Pixels lighter than the blend colour are replaced and pixels darker than the blend colour do not change.

## Lighten

Looks at the colour information in each channel and selects the base or blend colour - whichever is lighter - as the result colour. Pixels darker than the blend colour are replaced and pixels lighter than the blend colour do not change.

## Difference

Looks at the colour information in each channel and subtracts either the blend colour from the base colour or the base colour from the blend colour depending on which has the greater brightness value.

Blending with white inverts the base colour values and blending with black produces no change.

## Exclusion

Creates an effects similar to but lower in contrast than the difference mode. Blending with white inverts the base colour values. Blending with black produces no change.

## Colour Dodge

Looks at the colour information in each channel and brightens the base colour to reflect the blend colour by decreasing contrast between the two. Blending with black produces no change.

## Hard Mix

Adds the RGB channels of the blend colour to the RGB values of the base colour. If the resulting sum for a channel is 255 or greater, it receives a value of 255; if it is less than 255 it receives a value of 0. Therefore all blended pixels have RGB channels of either 0 or 255. This changes all pixels to primary additive colours (RGB), white or black.

## Brightness

This property (which appears as a light bulb icon) controls the brightness of the layer output.

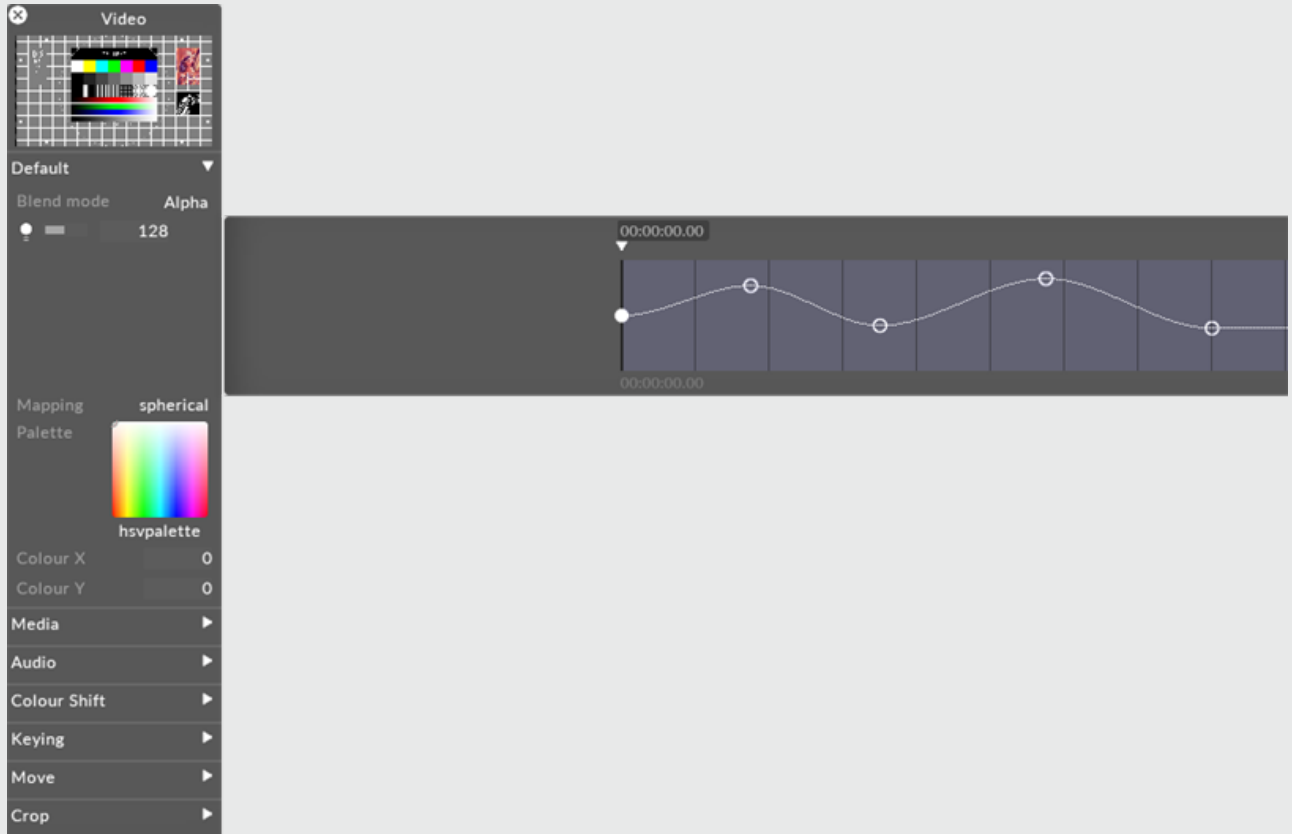

If the layers blend mode is set to Alpha, then reducing the brightness to 0 also reduces the opacity of the layer to 0. This can be useful when you want to dissolve from one layer to the next. In that case, you can place the new layer above the old layer and increase its brightness level.

## Mapping

The mapping property controls how the layer output is mapped onto the screen(s) in the Stage level.

**Video**

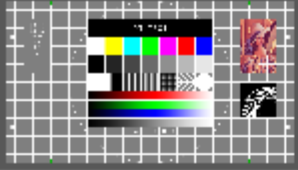

Default ▾

Blend mode Alpha

128

Mapping direct map 1

Palette



hsvpalette

Colour X 0

Colour Y 0

Media ▾

Video



d3\_test\_16-9.png

Speed 1

Mode Normal

At end point Loop

Transition time 0

Audio ▶

Colour Shift ▶

Keying ▶

Move ▶

Crop ▶



**mappings**

New mapping: OK Search:

all New Mappings

- direct map 1
- feed map 2
- feed mapping
- mapping 1
- mapping 2
- parallel
- spherical

For information on mapping, including how to use the different mapping types offered by Disguise software, please see the chapter [Content Mapping](#).

## Palette

This points to the still image file that defines the bitmap from which the tint colour is taken. The default palette ( HSVPAL ) consists of the complete range of hues and saturations. Selecting this property will open the Texture object library, which shows all of the still image files saved on your local hard-drive in the **DxTexture** folder.

To control the location within the current palette bitmap, and thus control the colour, you have to edit the **xCol** and **yCol** values (see the section for xCol, yCol).

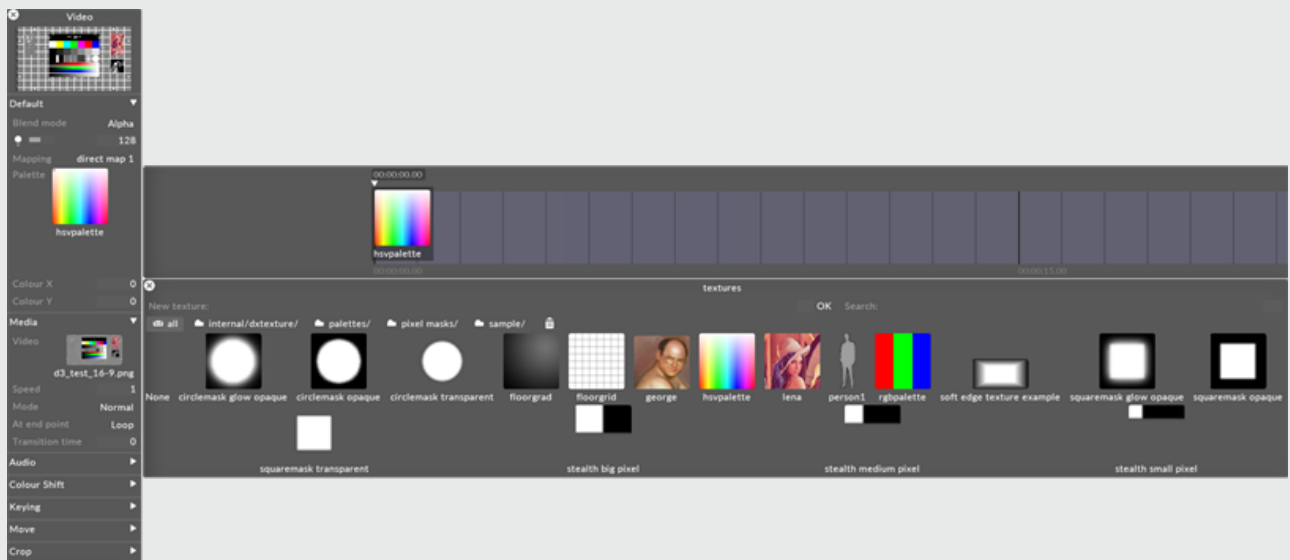

To change the current palette bitmap:

1. Left-click **palette** to open the Texture object library.
2. Left-click the still image file you want to use for the palette bitmap.

If you want to use a palette bitmap other than the standard still images provided in Disguise software, you will need to use a custom still image file.

See the [Placing media files for a project](#) sub-chapter to understand where to place a custom still image file and how to access it in Disguise software. Also save the file to a [supported file format](#).

## xCol yCol

These properties control the coordinates within the current palette bitmap where the output colour is sampled from. The default value is 0,0 which points at the color white (if you are using the HSVPAL palette). Multiplying white with the colors of the chosen content simply generates the original content colors. **Colour X** controls the horizontal position, where 0 is the leftmost edge and 255 is the rightmost edge. **Colour Y** controls the vertical position, where 0 is the top edge and 255 is the bottom edge.

For example, to saturate the video clip red, change the **Colour Y** value to 255 and use 0 for the **Colour X** value. These coordinates refer to the color red in the palette which is being multiplied with the colors of the existing content.

When you are using the default palette HSVPAL , **Colour Y** controls saturation, and **Colour X** controls hue.



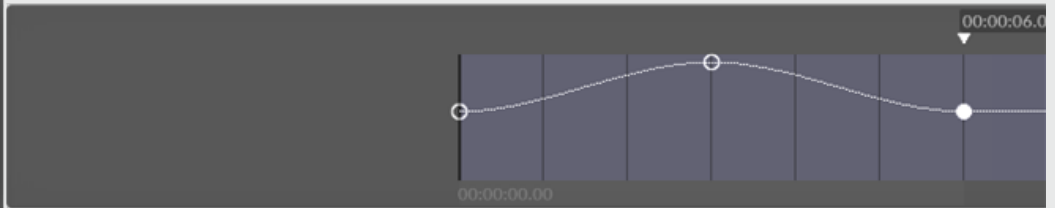
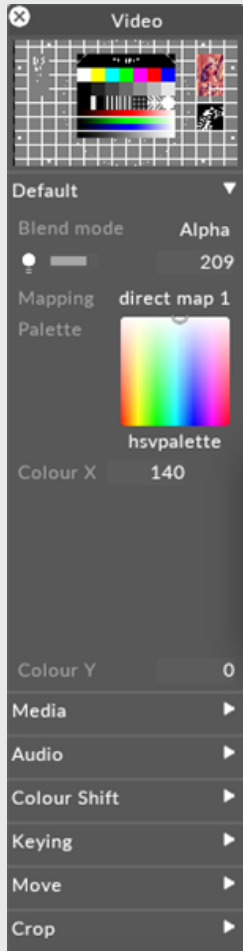

## Rate

Speed of strobing, in cycles per beat. 0 = stop flashing.

## Proportion

The amount of time within the cycle that the strobe is on. 0.5 = half the cycle time is white.

## Attack

Speed of attack (ramping from 0 to full brightness). 1 = instant, 0 = slowest.

## Decay

Speed of decay (ramping from full brightness down to 0). 1 = instant, 0 = slowest.

## Cycle

The cycle of the strobe. 0 = all screens flash together, 1 = screens flash in turn.

## Randomise

The randomness of the cycle order. Yes = order of the screens is randomised, No = order of the screens is not randomised.

## Min brightness

The minimum brightness outputted by the layer. 0 = 0%, 1 = 100%.

# Tennis

Tennis has been a staple of the Disguise software since the early days, hidden until r17 and previously called Pong but renamed due to legal reasons. Best played using a midi controller.

## Preview Thumbnail

This property is a small preview window at the top of the editor showing you what the layer output looks like.

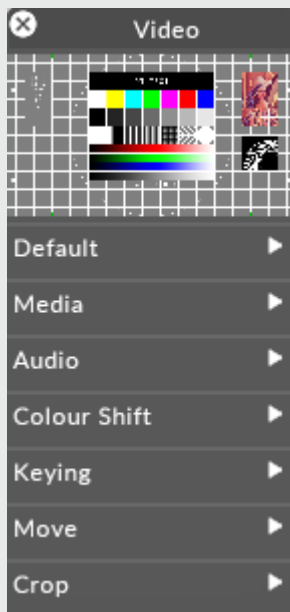

# Blend Mode

BlendMode controls how the output of the layer is composited with the layers below. Layers are rendered in a bottom-up order: layers at the top can modify the output of the layers below.

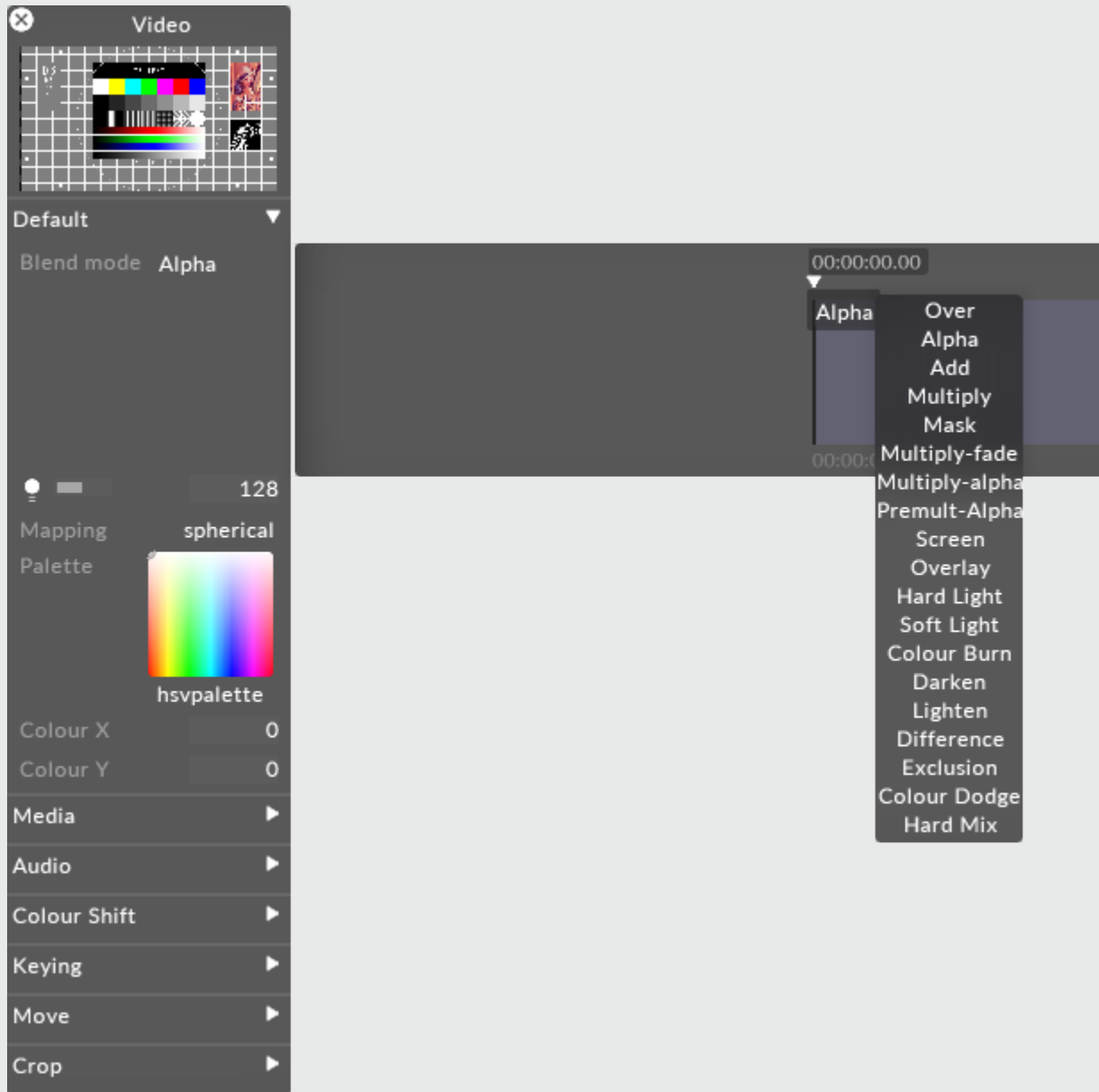

Changing brightness of a content layer in Disguise software is actually controlling the value of the alpha of the layer. Even when displaying a HAP video, the software will composite the layer with a controllable layer of alpha - one per layer.

There are two ways of expressing alpha in an image:

Straight alpha is an alpha channel which functions just like RGB. Alpha acts as a fourth channel of information per pixel which is as independent of the other three as R, G and B are of each other. For example, with straight alpha it is possible to have RGB = 255 (white) and alpha = 0 (fully transparent) on the same pixel. Internally generated content, such as gradient layer, are generated with straight alpha. This is the preferable style of alpha and considering the cleaner method of the two.

Premultiplied alpha takes the alpha and applies it to the values of the RGB channels per pixel. The more transparent something gets with premultiplied alpha, the closer it gets to black - as if the content is sitting on a black table. Premultiplied is the default output of Adobe Photoshop or AfterEffects. the result is our pixel at 255 RGB (full white) with 0 alpha would be calculated as a black pixel in the final image.

Here are explanations of what each individual blend mode will do.

## Over

Makes a layer fully opaque. Premultiplies all alpha onto the RGB value of each pixel. Alpha = black, so adjusting the brightness of a layer in Over blend mode makes it darker.

## Alpha

Default blend mode. It will apply alpha values as a transparency if the alpha is present. Brightness changes will make the layer more or less transparent.

## Add

Adds the value of each RGB pixel together. Always creates a brighter result. Values clamp at 255.

## Multiply

Reads the level of each subpixel as a level between 0.0 and 1.0, and multiplies source with blend. The result is always a darker image overall. For example: white x grey = 0.5. White turns transparent, black takes precedence. Alpha is applied in the same fashion as the Over Blend mode.

## Mask

Choose mask when you want to multiple out content upwards in the stack of layers, rather than downwards. In order to make this work you have to use the same mapping on the layer set to mask and the layer on top.

## Multiply-Fade

The same as Multiply, but will make use of the alpha channel to calculate transparency in the source and blend layers. Since maximum transparency is premultiplied, alpha results in black. This will ignore black created through premultiplying.

## Multiply-Alpha

Multiply with straight alpha. This mode assumes that the alpha has not been premultiplied onto the RGB values and will not apply a correction to the semi-transparent pixels.

## Premultiply Alpha

Like how Multiply-fade will ignore the darkening caused by premultiplying, this blend mode will do the same with Alpha.

## Colour Burn

Blend mode increases the contrast to darken the base colour while reflecting the blend colour. The darker the blend colour, the more intensely the colour will be applied in the base image. White as the blend colour produces no change. Using the colour burn blend mode can produce some harsh results at full opacity.

The colour burn blend mode can be used to make tonal and colour adjustments to a layer.

## Screen

This blend mode looks at each channels colour information and multiplies the inverse of the blend and base colour. The result is always a lighter colour. Screening with black leaves the colour unchanged. Screening with white produces white. The effect is similar to projecting multiple images on top of each other - where bright white is fully opaque, black is fully transparent and 50% grey is 50% transparent.

## Overlay

Multiplies or screens the colours, depending on the base colour. Patterns or colours overlay the existing pixels while preserving the highlights and shadows of the base colour. The base colour is not replaced, but mixed with the blend colour to reflect the lightness or darkness of the original colour.

## Hard Light

Multiplies or screens the colours, depending on the blend colour. The effect is similar to shining a harsh spotlight on the image. If the blend colour (light source/top layer) is lighter than 50% grey, the image is lightened as if it were screened. This is useful for adding highlights to an image. If the blend colour is darker than 50% grey, the image is darkened as if it were multiplied. This is useful for adding shadows to an image. Painting with pure black or white results in pure black or white.

## Soft Light

Darkens or lightens the colours, depending on the blend colour. The effect is similar to shining a diffused spotlight on the image. If the blend colour (light source/top layer) is lighter than 50% grey, the image is lightened as if it were dodged. If the blend colour is darker than 50% grey, the image is darkened as if it were burned in. Painting with pure black or white produces a distinctly darker or lighter area, but does not result in pure black or white.

## Darken

Looks at the colour information in each channel and selects the base or blend colour - whichever is darker - as the result colour. Pixels lighter than the blend colour are replaced and pixels darker than the blend colour do not change.

## Lighten

Looks at the colour information in each channel and selects the base or blend colour - whichever is lighter - as the result colour. Pixels darker than the blend colour are replaced and pixels lighter than the blend colour do not change.

## Difference

Looks at the colour information in each channel and subtracts either the blend colour from the base colour or the base colour from the blend colour depending on which has the greater brightness value.



Blending with white inverts the base colour values and blending with black produces no change.

## Exclusion

Creates an effects similar to but lower in contrast than the difference mode. Blending with white inverts the base colour values. Blending with black produces no change.

## Colour Dodge

Looks at the colour information in each channel and brightens the base colour to reflect the blend colour by decreasing contrast between the two. Blending with black produces no change.

## Hard Mix

Adds the RGB channels of the blend colour to the RGB values of the base colour. If the resulting sum for a channel is 255 or greater, it receives a value of 255; if it is less than 255 it receives a value of 0. Therefore all blended pixels have RGB channels of either 0 or 255. This changes all pixels to primary additive colours (RGB), white or black.

## Brightness

This property (which appears as a light bulb icon) controls the brightness of the layer output.

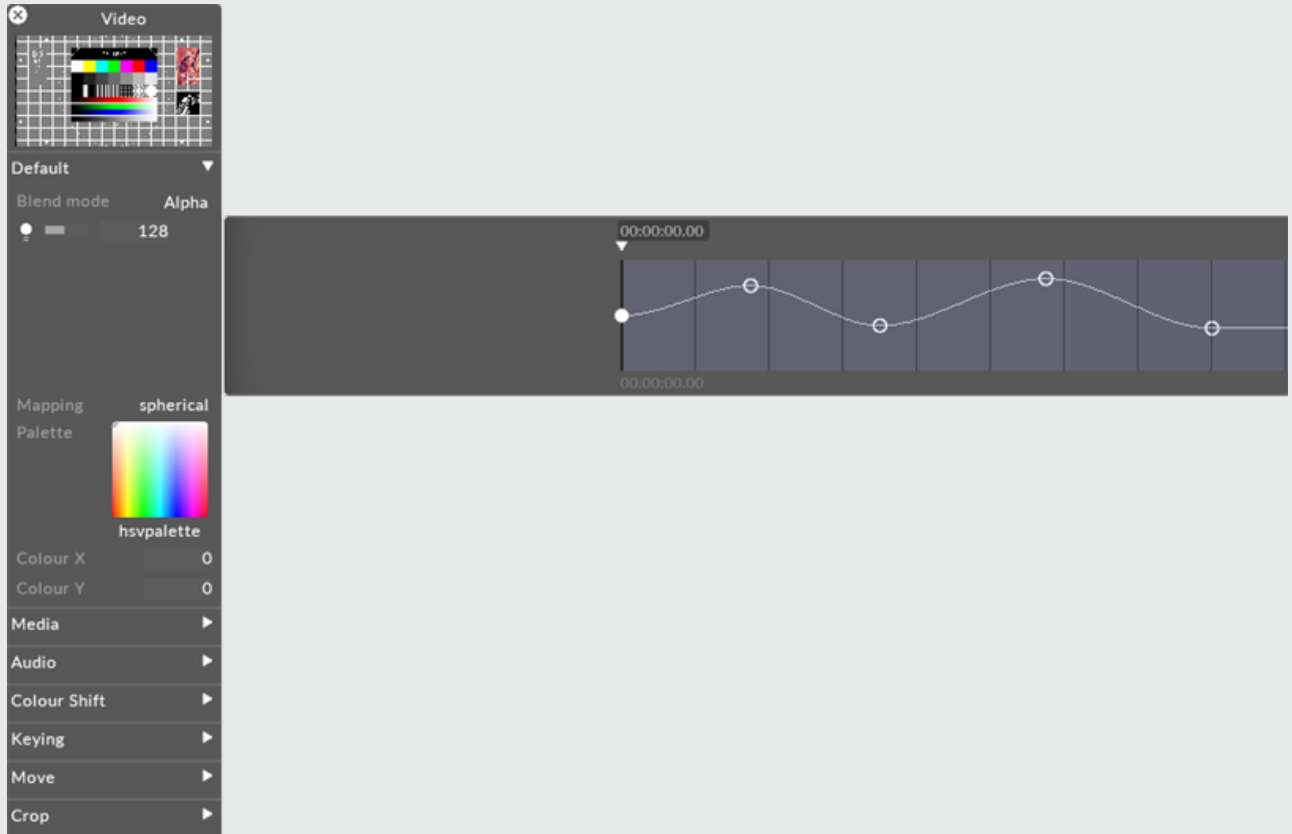

If the layers blend mode is set to Alpha, then reducing the brightness to 0 also reduces the opacity of the layer to 0. This can be useful when you want to dissolve from one layer to the next. In that case, you can place the new layer above the old layer and increase its brightness level.

## Mapping

The mapping property controls how the layer output is mapped onto the screen(s) in the Stage level.

**Video**

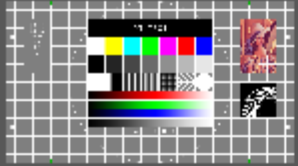

Default ▾

Blend mode Alpha

128

Mapping direct map 1

Palette



hsvpalette

Colour X 0

Colour Y 0

Media ▾

Video



d3\_test\_16-9.png

Speed 1

Mode Normal

At end point Loop

Transition time 0

Audio ▶

Colour Shift ▶

Keying ▶

Move ▶

Crop ▶



**mappings**

New mapping: OK Search:

all New Mappings

- direct map 1
- feed map 2
- feed mapping
- mapping 1
- mapping 2
- parallel
- spherical

For information on mapping, including how to use the different mapping types offered by Disguise software, please see the chapter [Content Mapping](#).

## Palette

This points to the still image file that defines the bitmap from which the tint colour is taken. The default palette ( HSVPAL ) consists of the complete range of hues and saturations. Selecting this property will open the Texture object library, which shows all of the still image files saved on your local hard-drive in the **DxTexture** folder.

To control the location within the current palette bitmap, and thus control the colour, you have to edit the **xCol** and **yCol** values (see the section for xCol, yCol).

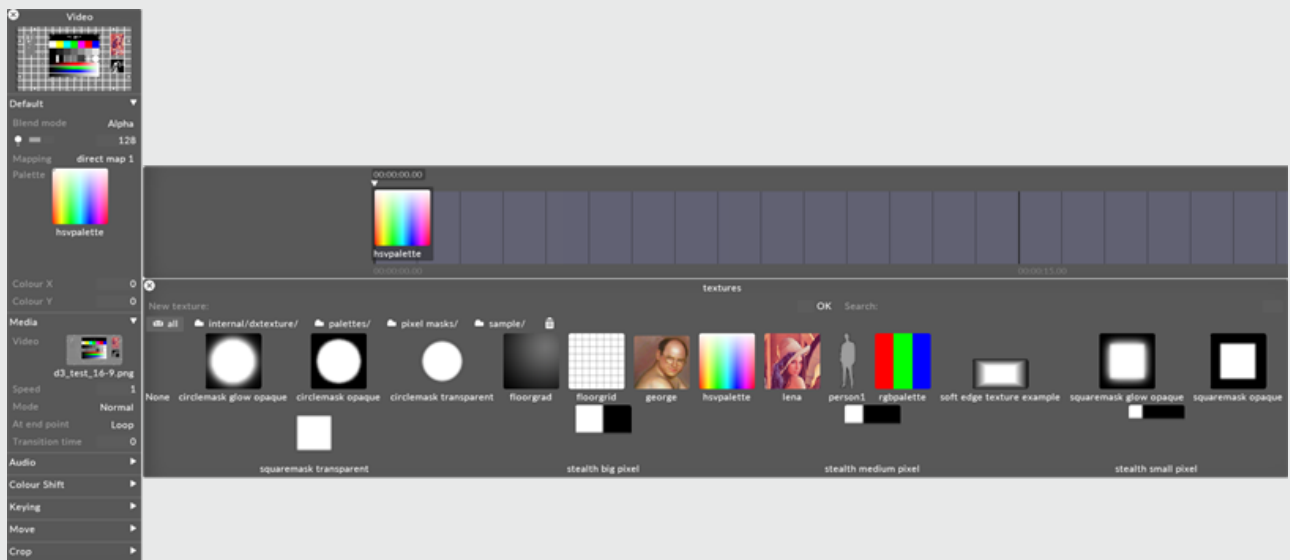

To change the current palette bitmap:

1. Left-click **palette** to open the Texture object library.
2. Left-click the still image file you want to use for the palette bitmap.

If you want to use a palette bitmap other than the standard still images provided in Disguise software, you will need to use a custom still image file.

See the [Placing media files for a project](#) sub-chapter to understand where to place a custom still image file and how to access it in Disguise software. Also save the file to a [supported file format](#).

## xCol y Col

These properties control the coordinates within the current palette bitmap where the output colour is sampled from. The default value is 0,0 which points at the color white (if you are using the HSVPAL palette). Multiplying white with the colors of the chosen content simply generates the original content colors. **Colour X** controls the horizontal position, where 0 is the leftmost edge and 255 is the rightmost edge. **Colour Y** controls the vertical position, where 0 is the top edge and 255 is the bottom edge.

For example, to saturate the video clip red, change the **Colour Y** value to 255 and use 0 for the **Colour X** value. These coordinates refer to the color red in the palette which is being multiplied with the colors of the existing content.

When you are using the default palette HSVPAL , **Colour Y** controls saturation, and **Colour X** controls hue.

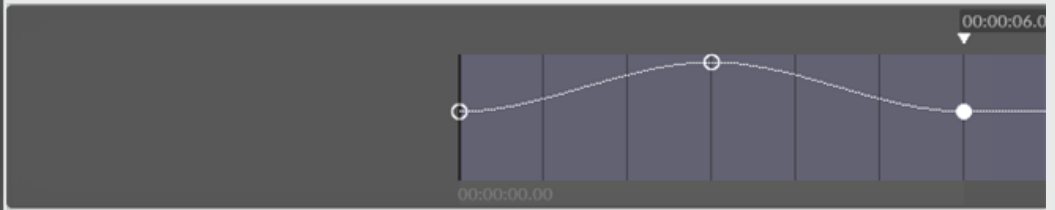
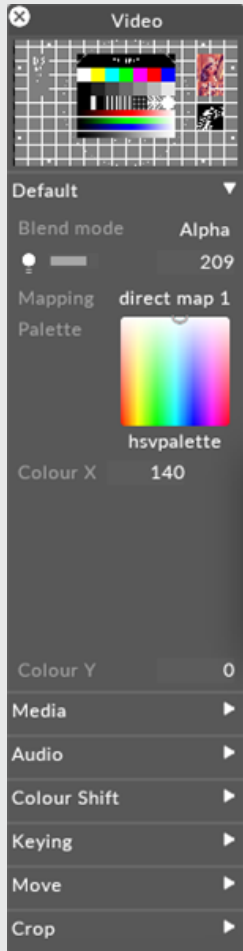

## Options

### Ball speed

This controls the speed of the generated ball, in pixels per beat.

## Bat size

This controls the size of each bat.

## Bat padding

This controls padding on each bat.

## Control

**Please note:** We recommend using an external controller (such as a midi device with faders) to control the bats.

## Left bat position

This controls the vertical location of the left bat.

## Right bat position

This controls the vertical location of the right bat.

# Text

The Text module allows you to enter and display text on a surface or screen.

## Overview

The Text module is used to generate and map text to a surface or screen.



# Text Layer Properties

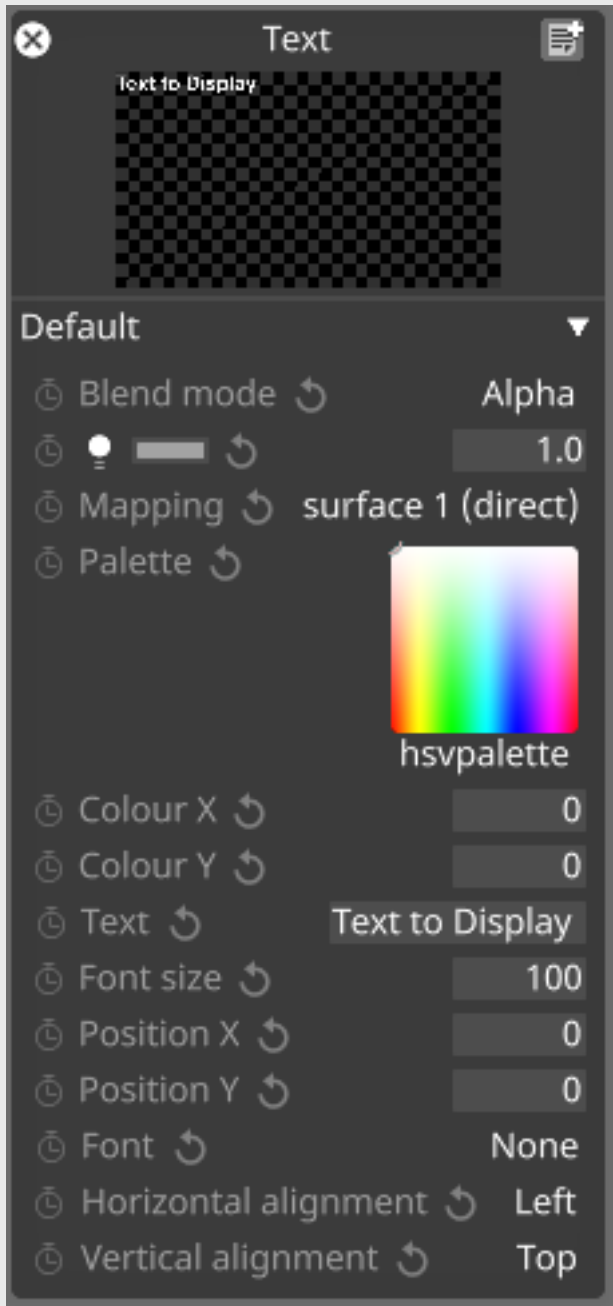

# Text

The text that will be displayed on the surface.

# Font Size

The size of text.

# Font

The type of font to be displayed. TTF fonts can be added to the project by being added to the objects/textfont folder within the project.

# Horizontal alignment

Horizontal location of text on the surface. Options are Left, Center, and Right.

# Vertical alignment

Vertical location of text on the surface. Options are Top, Center, and Bottom.

# Common Layer Properties

For information on common layer properties, [visit this link](#).

# Readout

This layer allows you to assign the incoming timecode, remaining section time, or system time to a screen via a mapping to show on the output as well as in the stage.

## Display property

The Display property allows you to switch between readouts for the incoming timecode, MTC layer, Timeline, Section, Video timecode, Time and Output Debuggers, and System time readouts.

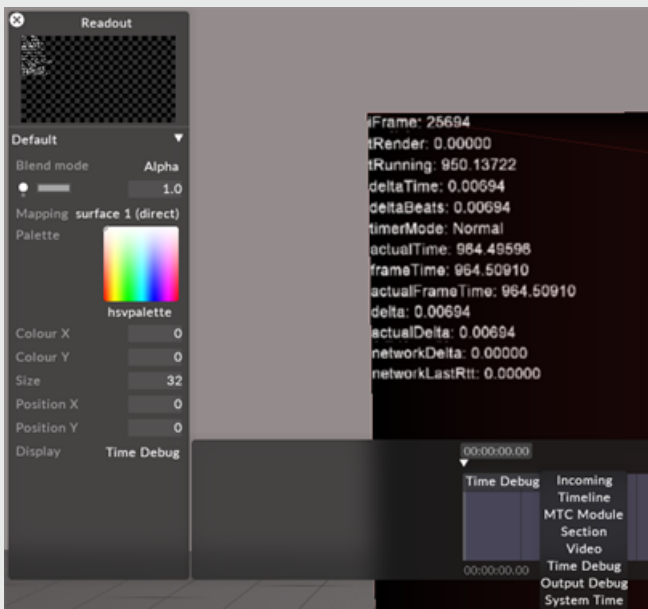

## Common layer properties

For information on the common layer properties "Mapping:", "Palette", "Colour x/y", "Size", and "Position x/y", please visit [this link](#)

# TrackingMarker Module

The TrackingMarker module is useful for virtual production workflows where some scenes require a green screen, either just within the camera frustum or on the whole of the LED screen.

## Overview

The tracking marker module generates a repeating pattern of markers on a coloured or transparent background. It is useful for virtual production workflows where some scenes require a green screen, either just within the camera frustum or on the whole of the LED screen. It can be used for both 2D and 3D mappings, and the markers will appear fixed to the screens in both cases.

## See How It Works

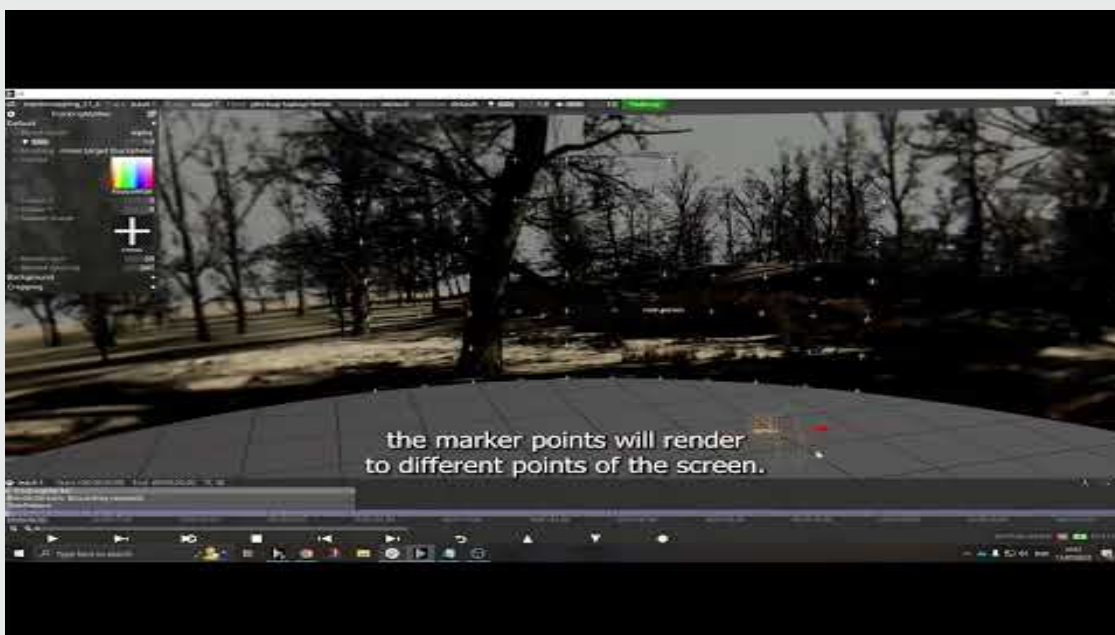

# Layer Properties

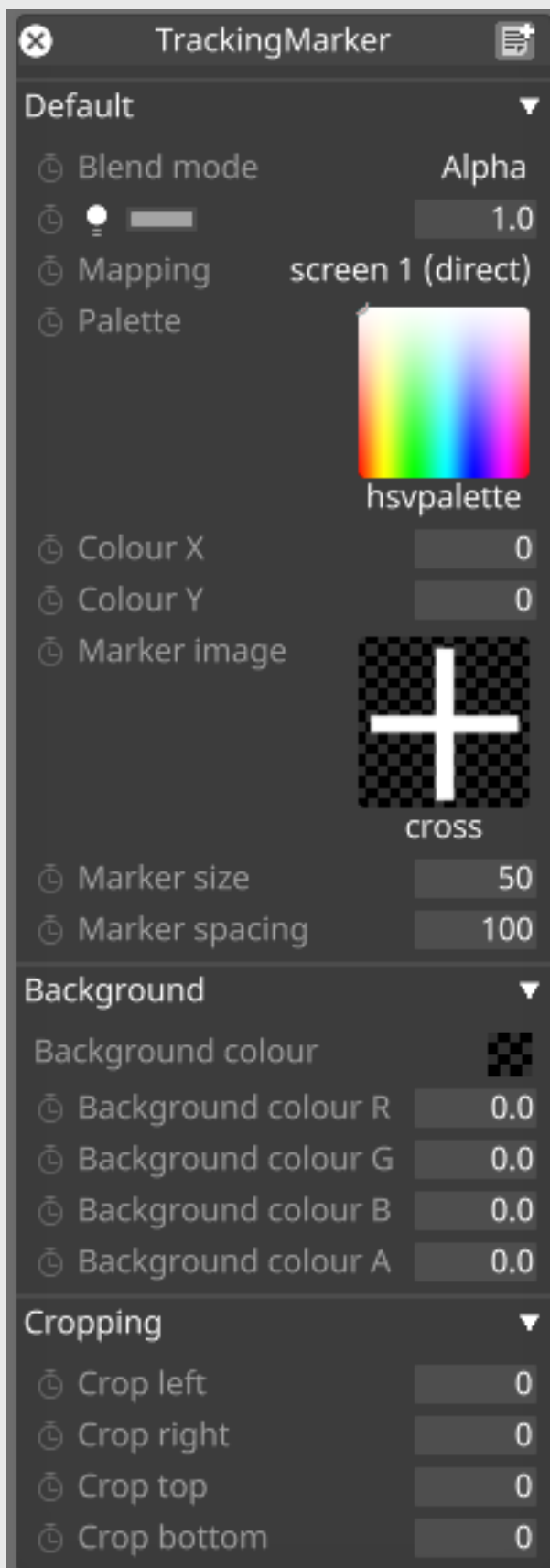

## Marker Image

The image used for the onscreen marker.

## Marker Size

The size of the onscreen marker.

## Marker Spacing

The spacing between each onscreen marker image.

## Background Colour

Colour Controls for the background colour when Alpha is enabled

## Cropping

Crops left, right, top and bottom of the marker overlay.

## Common Layer Properties

For information on common layer properties, [visit this link](#).

# Previsualisation Layers Overview

Previsualisation Layers allow virtual objects within the Stage view to be animated via keyframes.

## Types of Previsualisation layers

There are several types of Previsualisation layers available within Disguise software:

[AnimateCameraPreset](#)

[AnimateCameraControl](#)

[AnimateObjectPreset](#)

[TargetControl](#)

[TargetObject](#)

[TargetPreset](#)

# AnimateCameraControl

This layer allows you to script a fly-through of the stage so that you can create presentation videos, with or without audio.

Please note: while the Timeline play cursor is under the layers extent, the AnimateCameraControl layer overrides normal Stage navigation. To regain control of the normal Stage navigation, move the play cursor away from under the layer (or move the layer).

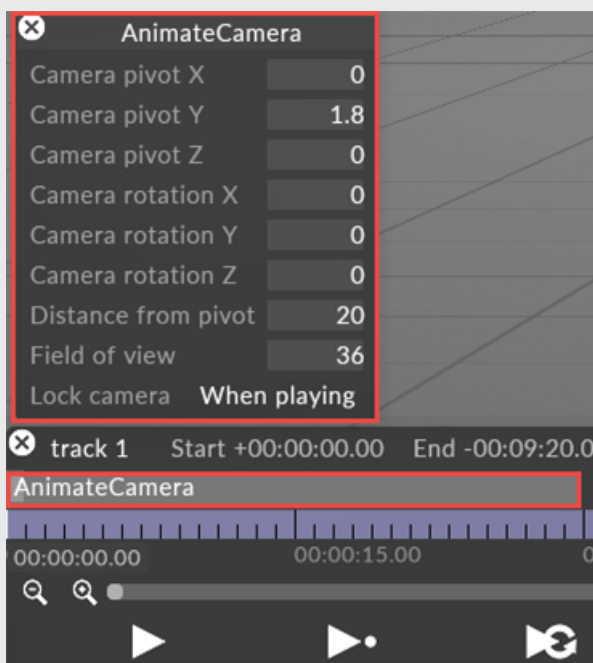

**Please note:** AnimateCameraControl layer gives you full control of keyframes but is also more complex and harder to operate than the [AnimateCameraPreset layer](#), which is based on animating between a number of pre-made configurations.



## Camera pivot

This controls the position of the **pivot** the point where the camera is looking at. This is a 3 dimensional position, i.e. it has x, y and z components. These are all stage space coordinates, expressed in meters.

**Please note:** in most cases the best approach is to have a static pivot point throughout the camera fly-through animation. Set the pivot point to the point of rotation, then animate the other properties. If not, you may get a sliding effect of the camera.

## Camera rotation

This controls the rotation of the camera around the pivot point, in degrees around each of the x, y and z axes. Rotation around the x axis is equivalent to elevation, around the y axis is equivalent to heading, and the z axis rotates the camera around its viewing axis.

## Distance from pivot

This controls the distance (in meters) from the camera to its pivot point. Increasing this number takes the camera away from the pivot point; decreasing it moves the camera closer to the pivot point.

## View angle

A higher view angle will show more of the stage from a given point of view. View angle is measured in degrees.

## Camera locked

This manipulates how the layer controls the camera.

- Left-click **camera locked** to open the **camera locked** keyframe editor.
- Left-click **always** to open the option properties.
- Left-click **when playing** to set the layer so that it only controls the camera when the keyframe editor is playing, allowing you to move freely when the keyframe editor stops.
- Left-click **always** to set the layer so that it always control the camera.

# AnimateCameraPreset

The AnimateCameraPreset layer lets you create a camera fly through using a number of configurations which can be dropped onto the timeline. The Disguise software will then animate the camera between the configurations.

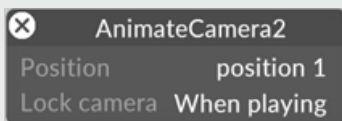

## Creating a camera position animation

1. Left-click **position**. This will open the **position** keyframe editor and a window where you can create a new camera position.
2. Left-click **new cameraposition** to highlight the text field.
3. Type in the name of your new camera, for example **east**.
4. Hit **Enter**. This will create the new camera position, add it to the **position** key-frame editor at the position of the currently selected Track bar, and open the Camera Position editor. The camera position key-frames can also be click-dragged from the Camerapositions manager to a specified point on the Position key-frame editor.



Process used to create a camera position, in this example position 1, and place it on the Position key-frame editor

5. Edit the values within the Camera Position editor (properties explained below).
6. Repeat the steps listed above to create as many new camera positions as required.
7. Hit **Shift** and **<** to jump to the first second of the track.
8. Hit **Enter** to trigger normal play mode and watch the camera animation.

## Position

This property lets you create a new configuration of cameras you want to animate. Please see the section below **Creating a camera position animation** for step-by-step instructions on how to do this.

## Camera locked

This manipulates how the layer controls the camera.

- Left-click **camera locked** to open the **camera locked** keyframe editor.
- Left-click **always** to open the option properties.
- Left-click **when playing** to set the layer so that it only controls the camera when the keyframe editor is playing, allowing you to move freely when the keyframe editor stops.
- Left-click **always** to set the layer so that it always control the camera.

As demonstrated above, you need to use the Camera Position editor as part of the process to animate a camera position.

To open the Camera Position editor:

- Right-click a camera position in the Camerapositions manager

position 1			
Pivot	0,	2,	0
Elevation			-11
Heading			0
Roll			0
Distance to pivot			53
Field of view			36

Copy values from visualiser

## Pivot

This controls the position of the pivot the point where the camera is looking at. This is a 3 dimensional position, i.e. it has components x, y and z; all are stage space coordinates, expressed in meters.

**Please note:** in most cases the best approach is to have a static pivot point throughout the camera fly-through animation. Set the pivot point to the point of rotation, then animate the other properties. If not, you may get a sliding effect of the camera.

## Elevation

This rotates the camera up and down and is expressed in degrees. Note that the Elevation value is based around the cameras pivot point.

## Heading

This rotates the camera left and right, in degrees. Note that the Heading value is based around the cameras pivot point.

## Roll

This rotates the camera around its own z-axis, in degrees.

## Distance to pivot

This moves the camera closer to or further away from its pivot point, in meters.

## View angle

A higher view angle will show more of the stage from a given point of view. View angle is measured in degrees.

# AnimateObjectPreset Layer

The AnimateObjectPreset layer allows you to simulate moving objects such as screens within the Stage Visualiser by placing key-frames onto the key-frame editor. The Disguise software will then animate the object(s) between the configuration key-frame positions.

Please note: Disguise does not output control instructions to automation systems. The AnimateObjectPreset layer is for pre-visualisation purposes only.

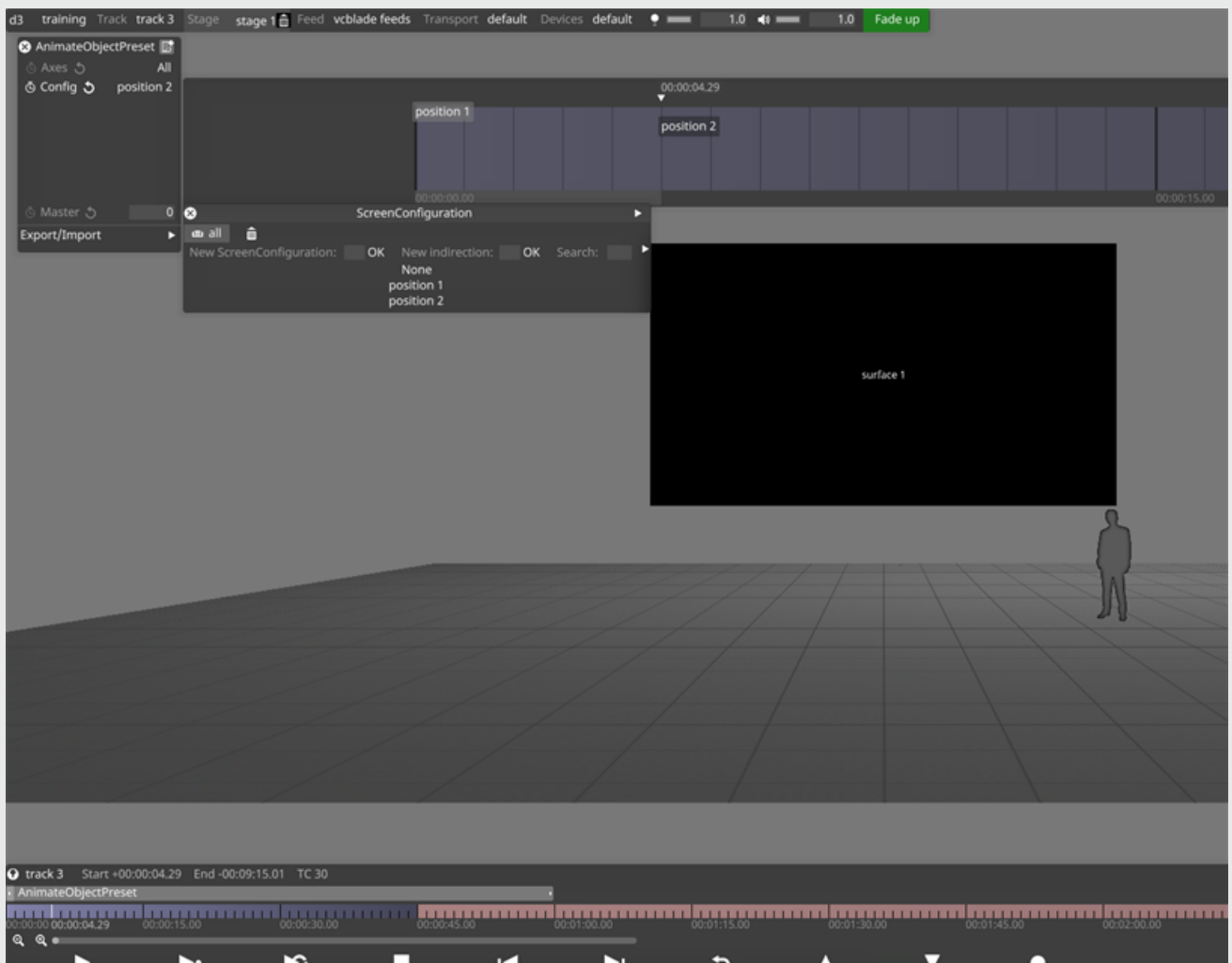

## Workflow

1. Create an AnimateObjectPreset layer
2. Create Position configurations
3. Add screens or objects to the configurations
4. Configure the properties of the configurations
5. Playback the configuration keyframes on the keyframe editor timeline to animate objects around the stage.

## Creating a AnimateObjectPreset animation

1. Create an AnimateObjectPreset layer and assign a mapping type that contains all of the screen or objects that you want to control. For information on mapping types please see the chapter [Content Mapping](#).
2. Open the Config key-frame editor by left-clicking the keyframe editor icon next to **Config**, then create and place a Configuration keyframe. The process used to create/sequence Configuration keyframes is the same as any other layer type that uses keyframe editors, for example the [AnimateCameraPreset](#) .
3. Use the Configuration editor to edit the position of the screen or object.
4. Create as many Configuration key-frames as required and place these on the Config keyframe editor. Once all keyframes have been placed on the keyframe timeline, press the Play button and Disguise software will animate the screen or objects between the Configuration keyframe positions.



# Axes

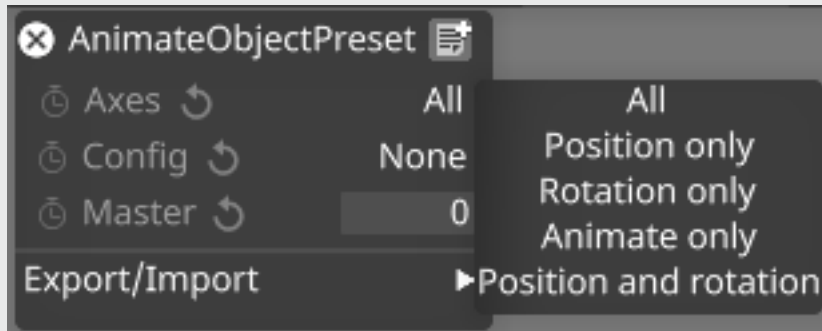

There are five options to choose from:

**All:** this affects the properties **position**, **rotation** and **animate**.

**Position only:** this affects only the **position** property.

**Rotation only:** this affects only the **rotation** property.

**Animate only:** this affects only the **animation** property of the screen type **Moving mesh** which is currently not in an official Disguise release.

**Position and rotation:** this affects only the **position** and **rotation** properties.

# Config

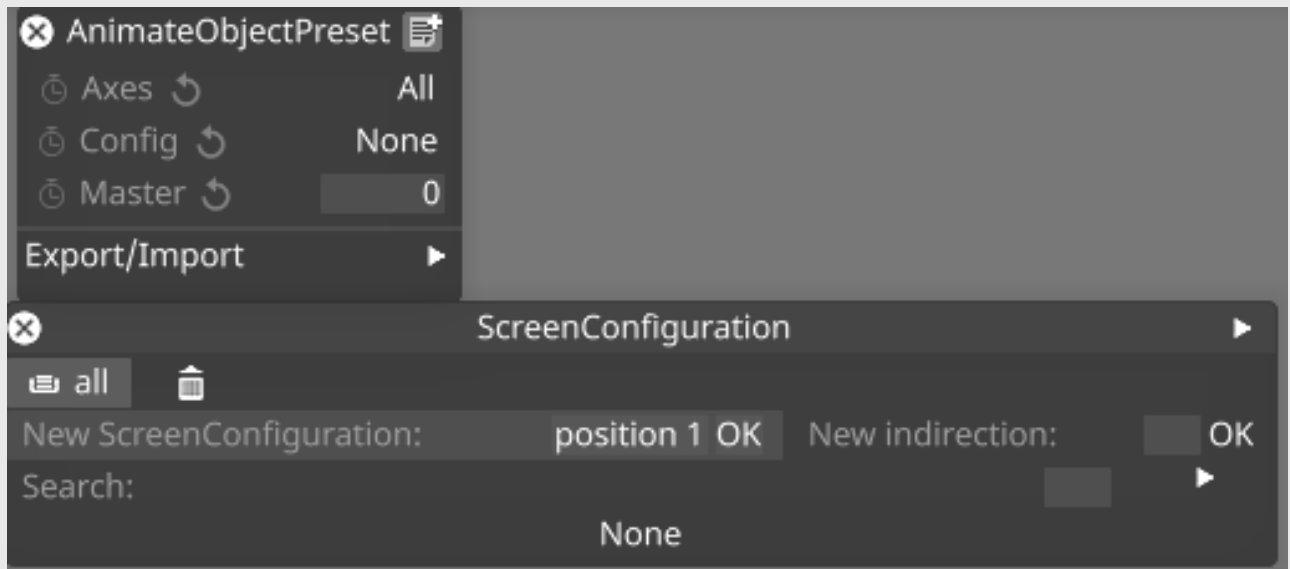

This property lets you create a new configuration of screens or objects that you want to animate.

# Master

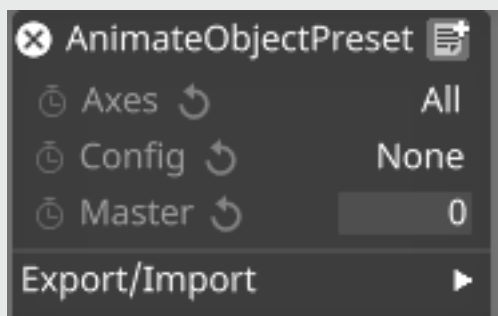

The **Master** property allows you to exert fine control of the movement speed between configuration positions. By default, Disguise software generates a linear animation between configuration points. However, if there are any keyframes on the master timeline between the configuration endpoints, Disguise software will use the master curve to animate between the endpoints.

# Export/ Import

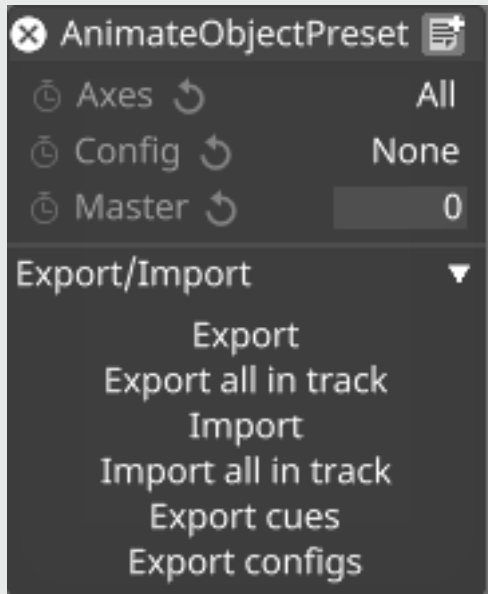

There are six options to choose from:

**Export:** makes a list of time based positions of screens when they change. This list is saved as a **.txt** file called **screenpos\_yourlayername**.

**Export all in track:** Export all points from the track.

**Import:** Imports all previously exported points.

**Import all in track:** Imports all points for a specific track.

**Export cues:** makes a time list of when specific configuration names are key-framed. This list is saved as a **.txt** file called **screeencues\_yourlayername**.

**Export configs:** makes a list of configurations. This list is saved as a **.txt** file called **screenconfigs\_yourlayername**.

The **.txt** files are saved in a new folder called **table** inside the specific Project folder. For more information on where the specific Project folder is located please see the sub-chapter [Projects location](#). You can open the **.txt** file with Microsoft Excel or Office.

**Please note:** when using the AnimateObjectPreset layer import properties make sure your layer names and object names have no spaces or characters such as dashes or slashes etc otherwise the layers and screens will not import.

You need to use the Configuration editor as part of the process to animate a screen or object.

## To open the Configuration editor:

- Right-click a configuration from the Configurations manager

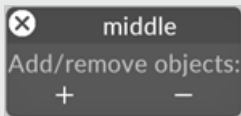

## Add / Remove Screens or objects

1. To add a screen to the Configuration editor left-click the + button. This will open the Objects list manager.

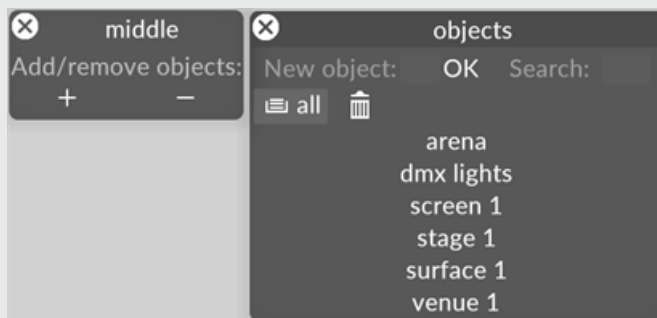

2. Left-click the object you want to add, in this example Surface 1. This will add Surface 1 to the Configuration editor.

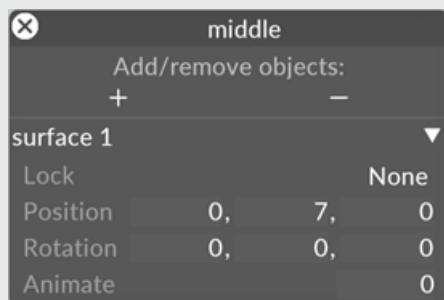

3. Edit the Configuration editors **position** or **rotation** properties.
4. To remove a screen from the Configuration editor left-click the button and select the corresponding screen from the Objects manager.

## Position

This controls the object's **position** in the 3D space. There are three numbers laid out horizontally: respectively the x (left/right), y (up/down) and z (into/out of the screen) coordinates.

## Rotation

This controls the **rotation** of the object, in degrees. The x component controls the rotation around the x axis; the y component around the y axis; and the z component around the z axis.

## Animate

This property is used to control the animation of a 3D object such as an [Alembic File](#).

# AnimateObjectPreset Layer

The AnimateObjectPreset layer allows you to simulate moving objects such as screens within the Stage Visualiser by placing key-frames onto the key-frame editor. The Disguise software will then animate the object(s) between the configuration key-frame positions.

Please note: Disguise does not output control instructions to automation systems. The AnimateObjectPreset layer is for pre-visualisation purposes only.

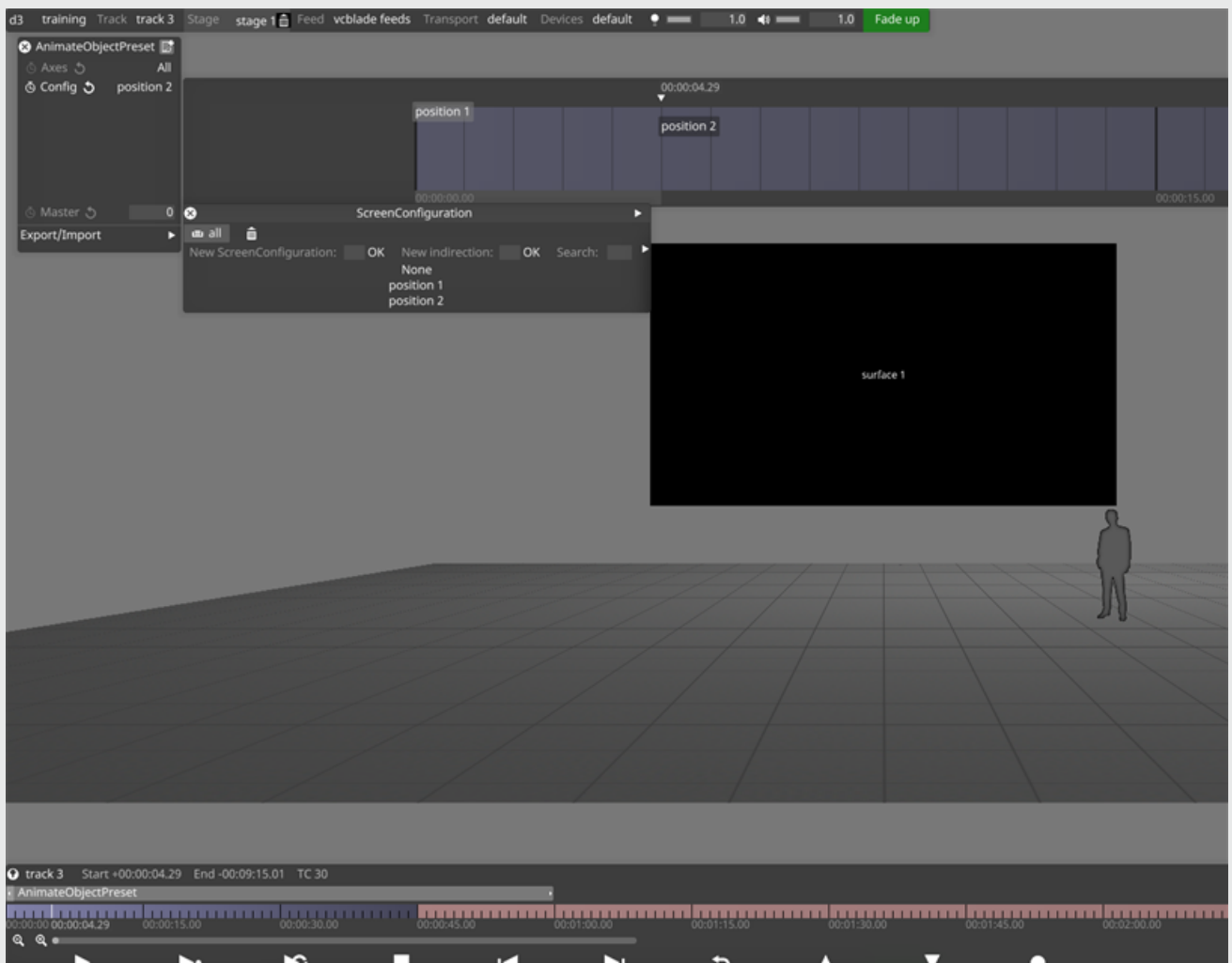

## Workflow

1. Create an AnimateObjectPreset layer
2. Create Position configurations
3. Add screens or objects to the configurations
4. Configure the properties of the configurations
5. Playback the configuration keyframes on the keyframe editor timeline to animate objects around the stage.

## Creating a AnimateObjectPreset animation

1. Create an AnimateObjectPreset layer and assign a mapping type that contains all of the screen or objects that you want to control. For information on mapping types please see the chapter [Content Mapping](#).
2. Open the Config key-frame editor by left-clicking the keyframe editor icon next to **Config**, then create and place a Configuration keyframe. The process used to create/sequence Configuration keyframes is the same as any other layer type that uses keyframe editors, for example the [AnimateCameraPreset](#) .
3. Use the Configuration editor to edit the position of the screen or object.
4. Create as many Configuration key-frames as required and place these on the Config keyframe editor. Once all keyframes have been placed on the keyframe timeline, press the Play button and Disguise software will animate the screen or objects between the Configuration keyframe positions.

# Axes

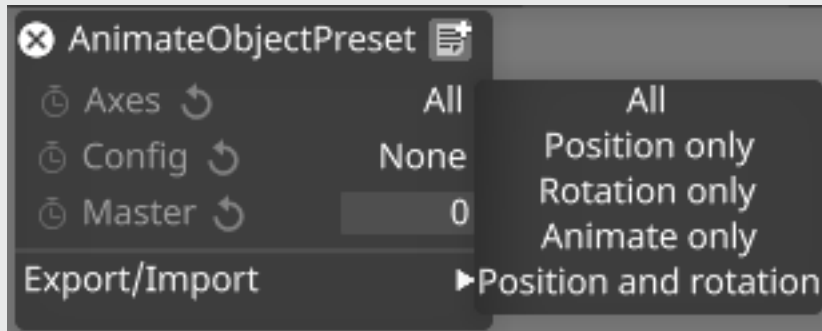

There are five options to choose from:

**All:** this affects the properties **position**, **rotation** and **animate**.

**Position only:** this affects only the **position** property.

**Rotation only:** this affects only the **rotation** property.

**Animate only:** this affects only the **animation** property of the screen type **Moving mesh** which is currently not in an official Disguise release.

**Position and rotation:** this affects only the **position** and **rotation** properties.



# Config

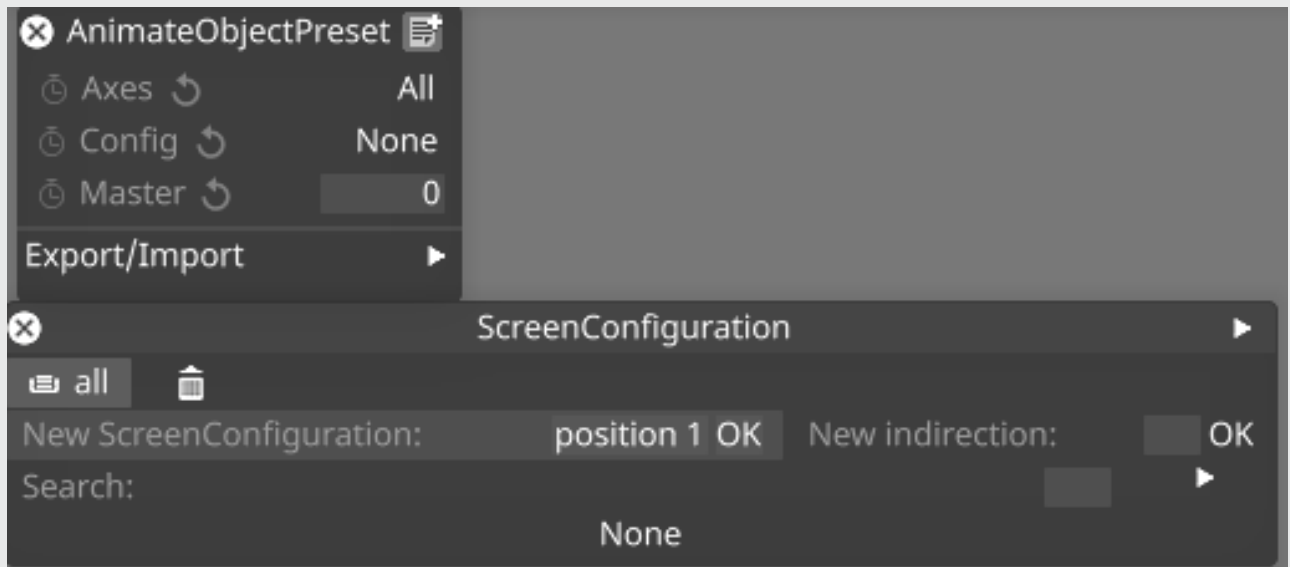

This property lets you create a new configuration of screens or objects that you want to animate.

# Master

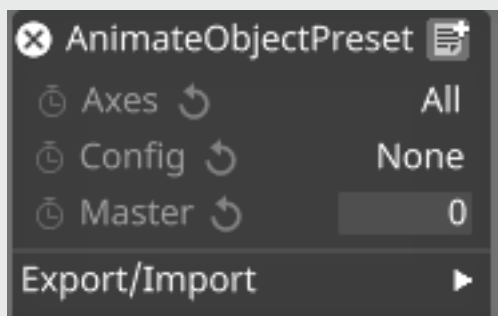

The **Master** property allows you to exert fine control of the movement speed between configuration positions. By default, Disguise software generates a linear animation between configuration points. However, if there are any keyframes on the master timeline between the configuration endpoints, Disguise software will use the master curve to animate between the endpoints.

# Export/ Import

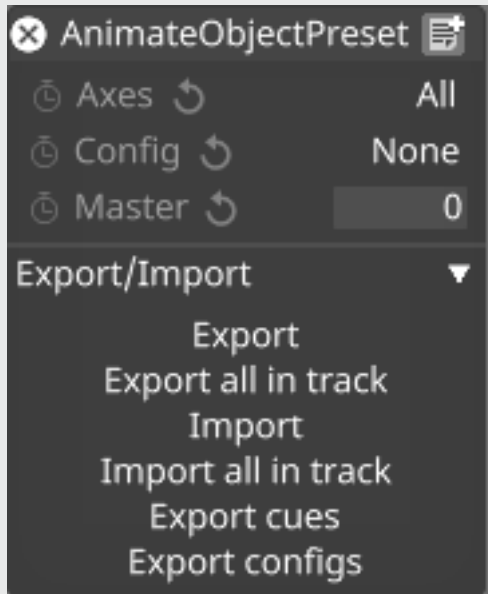

There are six options to choose from:

**Export:** makes a list of time based positions of screens when they change. This list is saved as a **.txt** file called **screenpos\_yourlayername**.

**Export all in track:** Export all points from the track.

**Import:** Imports all previously exported points.

**Import all in track:** Imports all points for a specific track.

**Export cues:** makes a time list of when specific configuration names are key-framed. This list is saved as a **.txt** file called **screeencues\_yourlayername**.

**Export configs:** makes a list of configurations. This list is saved as a **.txt** file called **screenconfigs\_yourlayername**.

The **.txt** files are saved in a new folder called **table** inside the specific Project folder. For more information on where the specific Project folder is located please see the sub-chapter [Projects location](#). You can open the **.txt** file with Microsoft Excel or Office.

**Please note:** when using the AnimateObjectPreset layer import properties make sure your layer names and object names have no spaces or characters such as dashes or slashes etc otherwise the layers and screens will not import.

You need to use the Configuration editor as part of the process to animate a screen or object.

## To open the Configuration editor:

- Right-click a configuration from the Configurations manager

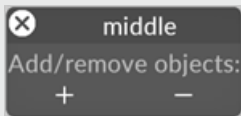

## Add / Remove Screens or objects

1. To add a screen to the Configuration editor left-click the + button. This will open the Objects list manager.

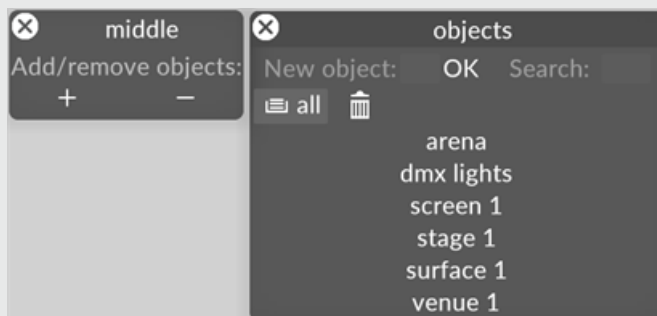

2. Left-click the object you want to add, in this example Surface 1. This will add Surface 1 to the Configuration editor.

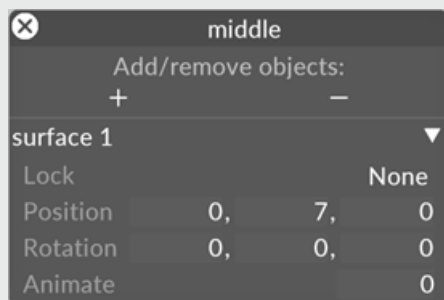

3. Edit the Configuration editors **position** or **rotation** properties.
4. To remove a screen from the Configuration editor left-click the button and select the corresponding screen from the Objects manager.

## Position

This controls the object's **position** in the 3D space. There are three numbers laid out horizontally: respectively the x (left/right), y (up/down) and z (into/out of the screen) coordinates.

## Rotation

This controls the **rotation** of the object, in degrees. The x component controls the rotation around the x axis; the y component around the y axis; and the z component around the z axis.

## Animate

This property is used to control the animation of a 3D object such as an [Alembic File](#).

# TargetControl

The TargetControl layer is similar to the [TargetPreset](#) in that it allows to control the movement of moving head lights. Each light in the target screen (which must be of the screen type DmxLights) has its own target point.



**Warning: the fixture defined in the DMXLight needs to set to aimable. If not, the TargetControl layer will have no effect.**

The TargetControl layer allows you to control how these target points are generated from the lights base positions. The main difference is that while the TargetPreset layer is based on setting a number of configurations of the target offset, scale and rotation and then interpolate the movements between the configurations, the TargetControl layer allows to keyframe every frame of the offset, scale and rotation values. This gives the user more precise control of the movements but may be more difficult to use for an inexperienced user. Notice that the fixture defined in the DMXLight needs to set to **aimable**. If not, the TargetControl layer will have no effect.

Please read the sub-chapter [DmxLights](#) for information on how to create a DmxLights screen. Afterwards please read the sub-chapter [Creating a fixture](#) for information on how to add a fixture to a DmxLights screen.

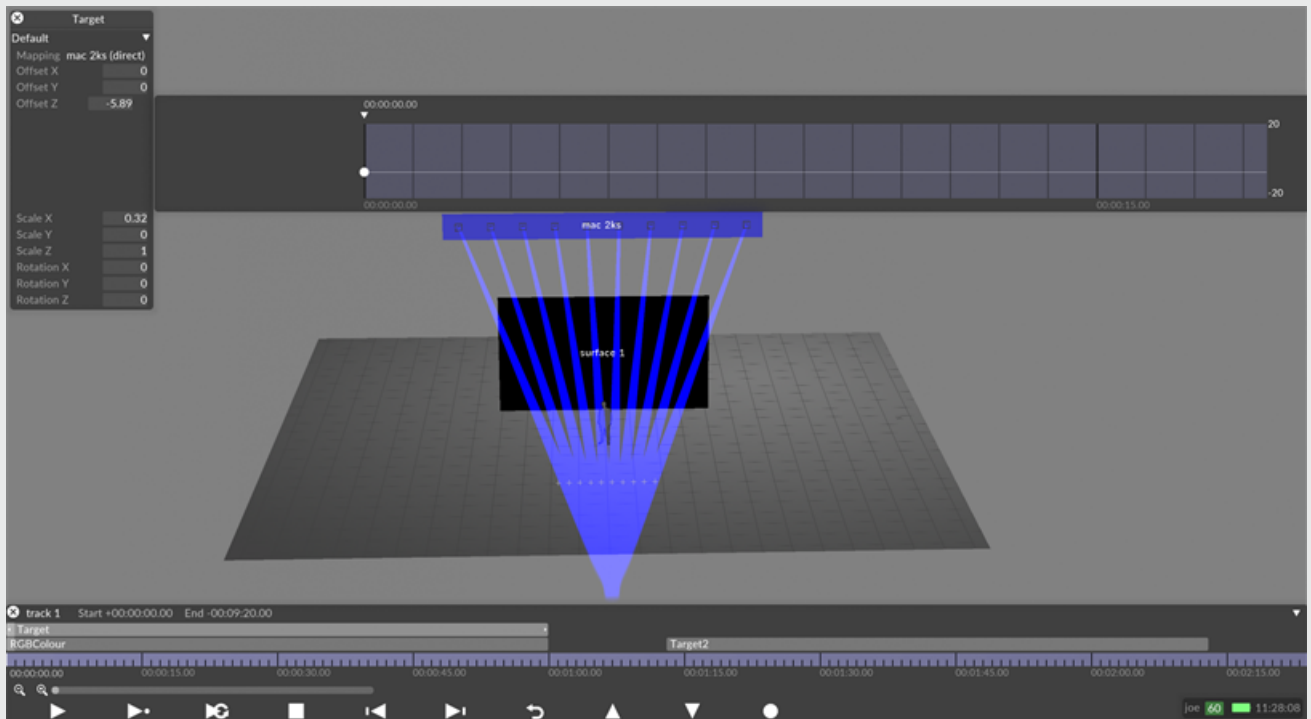

## Offset

This value is added to the (x, y, z) stage position of each fixture. To move the fixture targets left and right, change the x property, to move them up and down, change the y property and to move them in and out, use the z property.

## Scale

This scales the target points in each of the three axes x, y and z. Values higher than 1 increase the size of the target grid, causing the beams to splay outwards; values lower than 1 reduce the size of the target grid and setting the scale to 0 causes all beams to converge.

## Rotation

This rotates the target grid around each of the x, y and z axes (angles specified in degrees).

For step-by-step instructions on how to control moving head lights using the Target layer please see the sub-chapter [Targeting fixtures](#).

# TargetObject

The TargetObject layer is similar to the [TargetControl](#) in that it allows to control the movement of moving head lights. The only difference being that instead of using virtual target points the TargetObject allows you to use an object as the target.



**Warning: the fixture defined in the DMXLight needs to set to aimable. If not, the TargetObject layer will have no effect.**

Please read the sub-chapter [DmxLights](#) for information on how to create a DmxLights screen. Afterwards please read the sub-chapter [Creating a fixture](#) for information on how to add a fixture to a DmxLights screen.

For step-by-step instructions on how to control moving head lights using the Target layer please see the sub-chapter [Targeting fixtures](#).

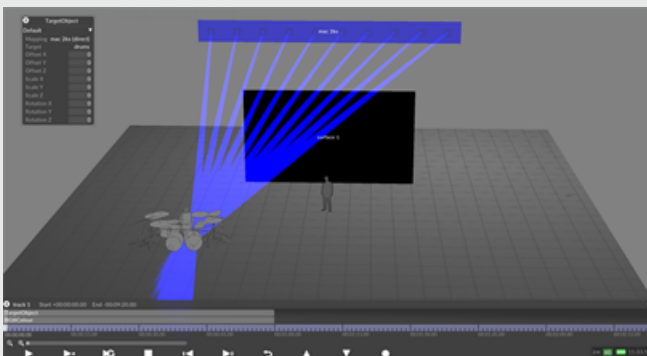

## Mapping



Determines what mapping of DMXLight screens to use. Notice that any mapping type can be created using DMXLight screens.

## Target

This property allows you to select the object that you want to use as the target.

## Offset

This value is added to the (x, y, z) stage position of each fixture. To move the fixture targets left and right, change the x property, to move them up and down, change the y property and to move them in and out, use the z property.

## Scale

This scales the target points in each of the three axes x, y and z. Values higher than 1 increase the size of the target grid, causing the beams to splay outwards; values lower than 1 reduce the size of the target grid and setting the scale to 0 causes all beams to converge.

## Rotation

This rotates the target grid around each of the x, y and z axes (angles specified in degrees).

# TargetPreset

The TargetPreset layer is similar to the [TargetControl](#) in that it allows to control the movement of moving head lights. Each light in the target screen (which must be of the screen type DmxLights) has its own target point.



**Warning: the fixture defined in the DMXLight needs to set to aimable. If not, the TargetPreset layer will have no effect.**

The TargetPreset (and TargetControl) layer allows you to control how these target points are generated from the lights base positions. The main difference is that while the TargetControl layer allows to keyframe every frame of the offset, scale and rotation values, the TargetPreset layer is based on setting a number of configurations of the target offset, scale and rotation and then interpolate the movements between the configurations. Notice that the fixture defined in the DMXLight needs to set to **aimable**. If not, the Target layer will have no effect.

Please read the sub-chapter [DmxLights](#) for information on how to create a DmxLights screen. Afterwards please read the sub-chapter [Creating a fixture](#) for information on how to add a fixture to a DmxLights screen.

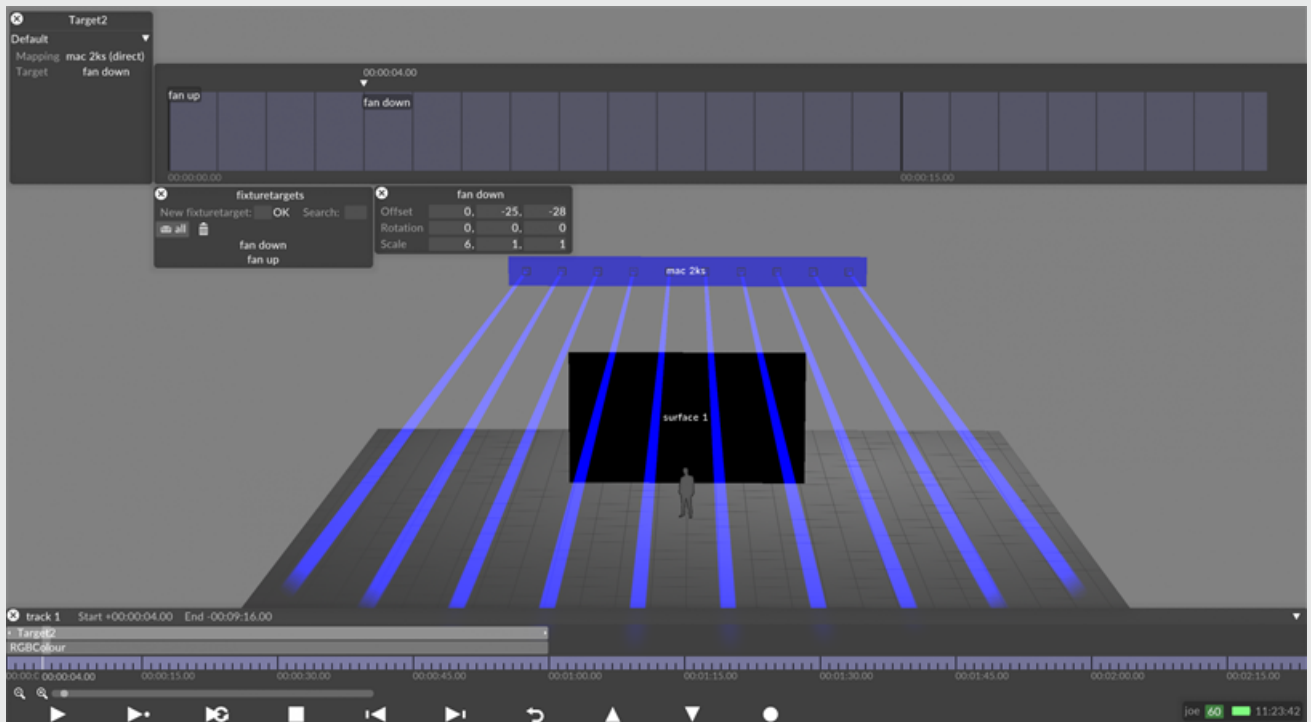

## Targeting/animating fixtures

1. Create a TargetPreset layer.
2. Target the fixtures by assigning a mapping type with the DMXLights you want to control. Make sure to set the fixture defined in the DMXLight to **aimable**.
3. Open the TargetPreset keyframe editor by left-clicking **target** and create and drag/drop a Target keyframe (configuration). The process used to create and sequence Target keyframes is the same as any other layer type that uses key-frame editors, for example the AnimateCameraPreset layer.
4. Right-click the the Target keyframe to edit the position of the fixture targets see below for more info.
5. Create as many Target keyframes as required and place these on the keyframe editor.

6. Press the Play button. The Disguise software will now animate the light's movements between the Target positions.

## Mapping

Determines what mapping of DMXLight screens to use. Notice that any mapping type can be created using DMXLight screens.

## Target

This property lets you create a new configuration of fixture targets, each specifying a target position (offset, rotation, scale) set which can be animated. Please see the section below for step-by-step instructions on how to do this.

You need to use the Target editor as part of the process to animate movinghead fixtures.

## Opening the Fixture Targets editor

- Right-click a target in the Targets manager.

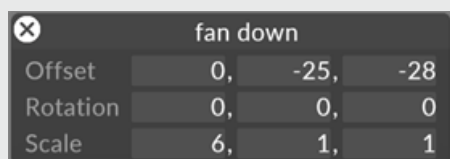

The screenshot shows a dark-themed window titled 'fan down' with a close button (X) in the top-left corner. It contains a table with three rows and four columns. The first column lists the properties: Offset, Rotation, and Scale. The subsequent three columns contain numerical values for each property, separated by commas.

fan down			
Offset	0,	-25,	-28
Rotation	0,	0,	0
Scale	6,	1,	1

## Offset

This controls the **offset** of the fixture target, in meters, from the base light position.

## Rotation

This controls the **rotation** of the fixture target, in degrees. The x component controls the rotation around the x axis; the y component around the y axis; and the z component around the z axis.

## Scale

This controls the **scale** of the fixture target. 1 = no change, >1 = scale up. If all are set to 0, the lights will focus on a point; if two are set to zero, the lights will focus on a line.

# Keyframing overview

Keyframing is used to animate a layer's property over time.

## What is the Keyframe editor?

Keyframing enables you to animate a layers property over time. A layer's property can be accessed from its layer editor. If a layers property cannot be animated, you may be able to use the [Open layer](#).

Before reading this sub-chapter it is recommended that you read the sub-chapter [Editing layers](#) which explains the Layer editor.

## Opening a Keyframe editor

To open a Keyframe editor:

- Left-click a Layer property to open the Keyframe editor. Opening a Keyframe editor will close any other open Keyframe editors.

## Keyframe toggles

- Beginning with r20, Keyframe toggles have been added, allowing you to reset all keyframes for an attribute within a layer. Enable and disable keyframes easily by clicking on the keyframe toggle icon. For more information on [Keyframe Toggles](#), please visit this [link](#).

# Opening multiple Keyframe editors

- Hold **Ctrl** whilst left-clicking the properties of a layer editor to open multiple Keyframe editors.

## Keyframe editor types

There are three different types of Keyframe editors. Examples of these three types are described below using the example of a Bitmap layer and its editor, and in the three following sub-chapters. Please read the [Editing objects](#) sub-chapter for more information on object property types.



## Numeric

A numeric Keyframe editor allows you to animate a numeric value when editing a numeric property, in this example **brightness**.

## Option

An option Keyframe editor gives you a fixed option list to choose from when animating an option property, in this example *blendMode*.

## Object

An object Keyframe editor refers to another object when animating an object property.

## Navigating Keyframe editors

1. Left-click a Track bar in the Timeline to play forwards or backwards in the currently selected Track. Notice that as you navigate the Timeline the currently open Keyframe editor will adjust accordingly. The Keyframe editor shows a bar of time just before the current Timeline position and a certain number of bars after it. The number of bars depends on the screen width and the current zoom factor.
2. Left-click the Keyframe editor and hold **Alt** whilst moving the mouse scroll wheel to zoom in or out. The mouse must remain focused on the Keyframe editor to successfully zoom.

## Common Keyframe properties

All three Keyframe editor types have the following things in common:



- They consist of a sequence of **Keyframe** or **key values** , which can be either **option** choices, **numeric** values or **objects** . In the case of numeric properties, the value between the Keyframe is generated according to a line or curve that passes through the Keyframe.
- A beat of time appears as a single vertical line. Each group of four lines represents a single Track bar and is marked with a bar number just below it. The background colour of the Keyframe editor matches the colour of the corresponding Track bar in the Timeline.
- Just above the Keyframe editor is a small triangle with a timecode just above it. This is the 'Now' pointer; it indicates the Timeline position that is currently being rendered to the stage. Editing a Keyframe moves the now pointer to the time of that Keyframe, thus allowing you to instantly see the effect of changing the value.

## Keyframe Options

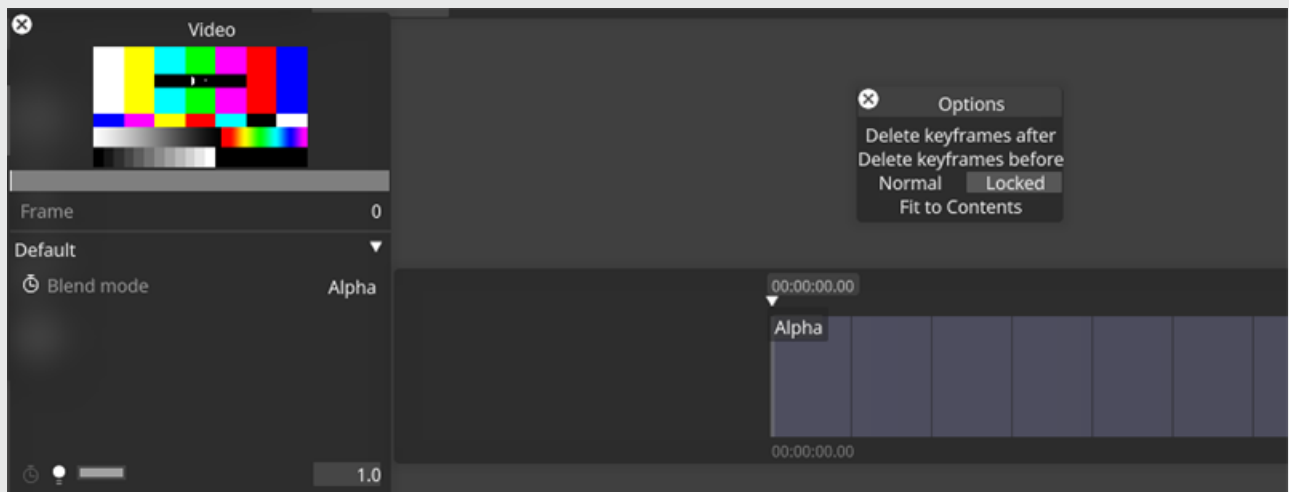

Right click on the border of a keyframe timeline and the Options window will appear with the following options:

- **Delete keyframes after**
- **Delete keyframes before**

- **Normal:** When there are looping keyframes after a section break and the playhead hits that section break, it will play the keyframes after the section break anyway.
- **Locked:** When there are keyframes after a section break and the playhead hits that section break, it respects the section break and will not play the keyframes.
- **Fit to Contents:** Shortens the layer length to the same length of time as the last keyframe of that layer

# Keyframe Toggle

Keyframes can easily be stripped from a keyframe editor with the click of a button

## Keyframe Toggle

With the new Keyframe toggle available for every keyframable attribute on a layer, you can quickly clean up your sequencing on the timeline by simply toggling timeline keyframes off.

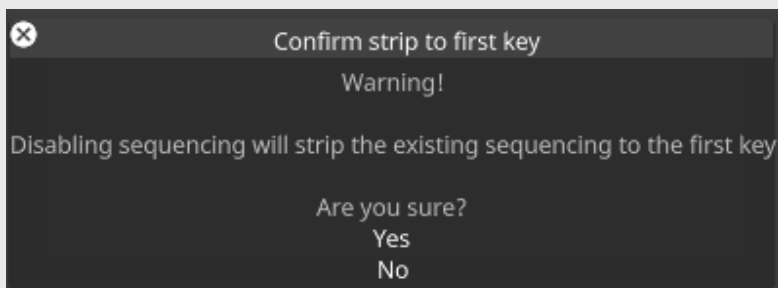
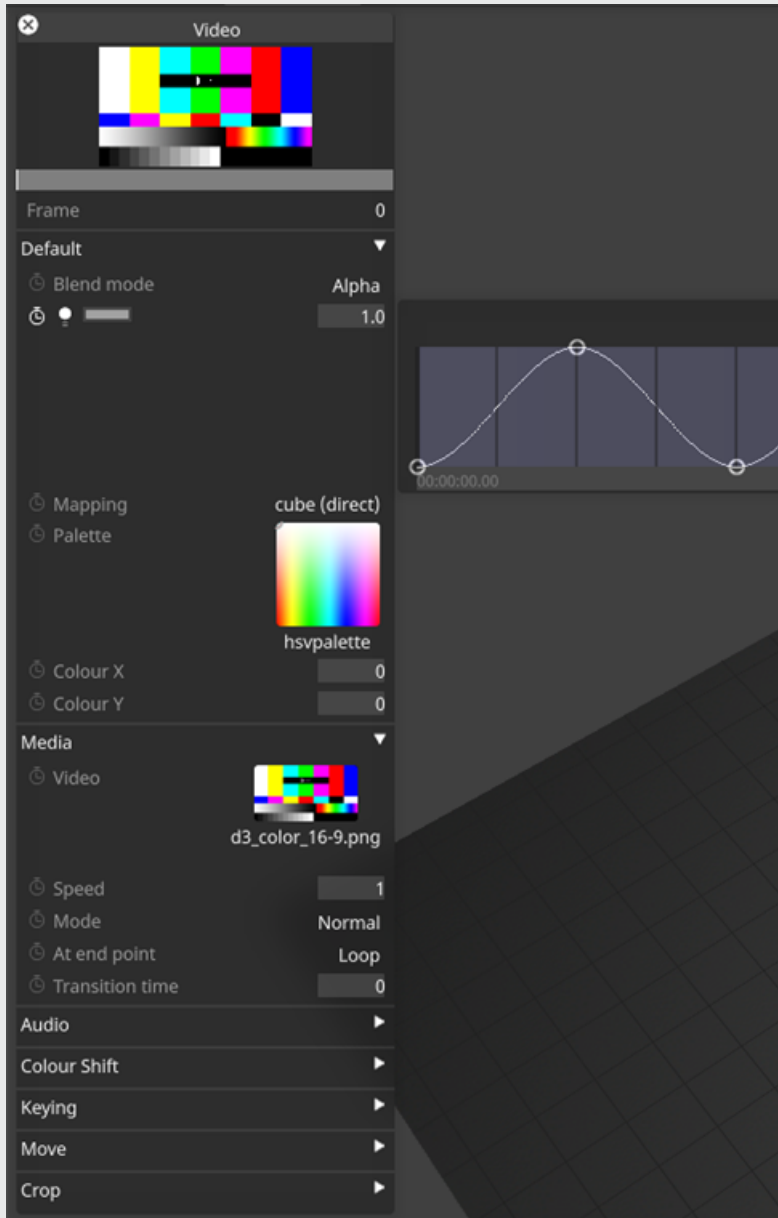

# Multiple keyframes

Editing actions apply to all three types of keyframe editors mentioned above and can be applied to a single keyframe editor or multiple keyframe editors of multiple layers.

## Selecting a range of keyframes

1. Hold down the left **Shift** key and drag a rectangle around the keyframes you want to select inside the keyframe editor. Keyframes that fall under the selection rectangle are displayed as solid white dots.

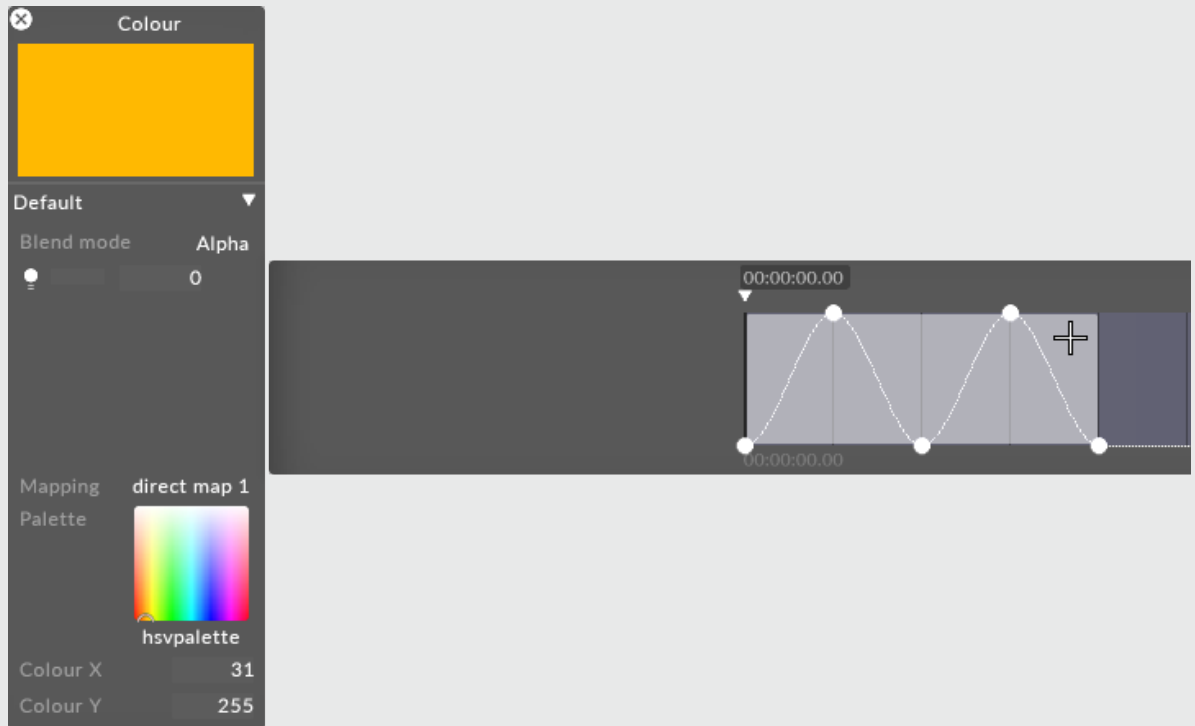

2. To open more than one keyframe editor, hold down the **Ctrl** key when selecting the properties.

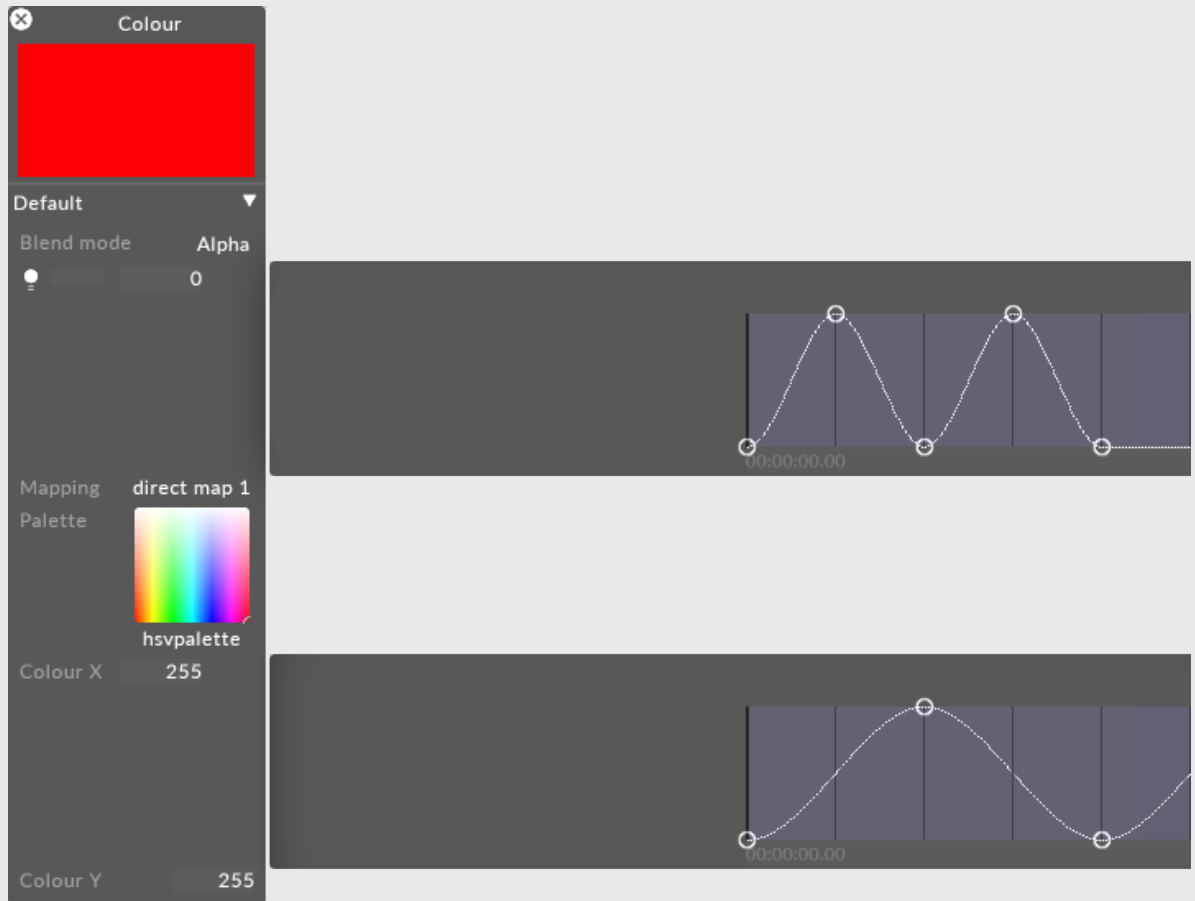

3. With multiple keyframe editors open, you can now select and edit keyframes from more than one keyframe editor simultaneously.

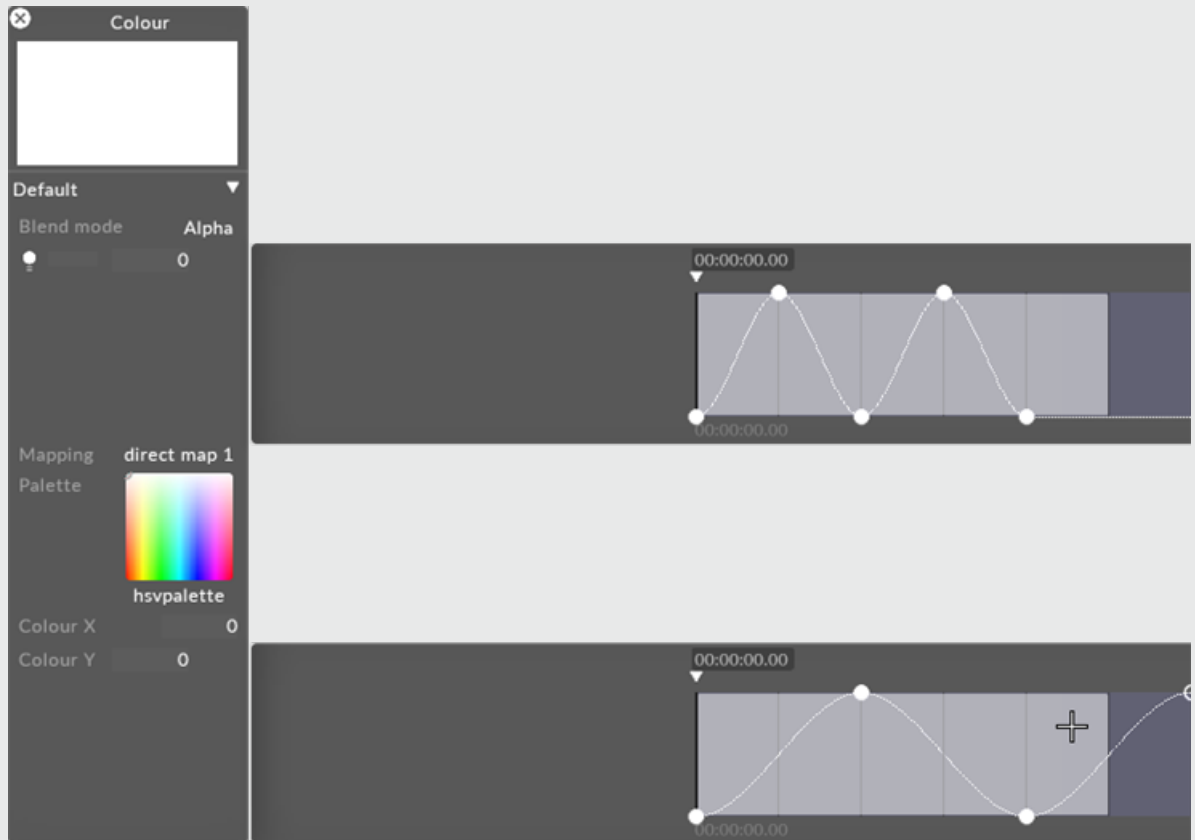

## Editing a range of keyframes

- Rightclicking inside the keyframe editor with a selected range of keyframes allows you to change the interpolation type between only the selected keyframes. The popup menu gives you a list of options to choose from.



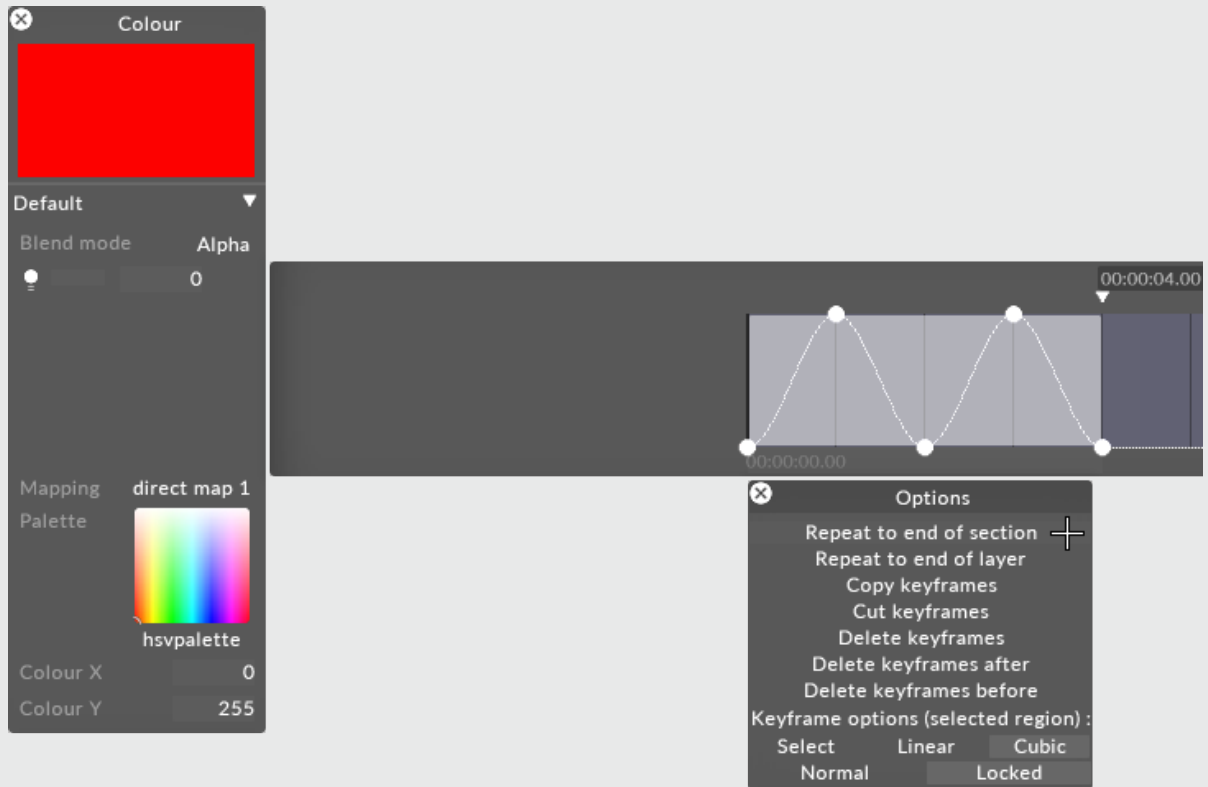

## Repeat a range of keyframes

1. Hold down the left **Shift** key to select a whole number of bars.
2. Rightclick the keyframe editor.
3. Select either **repeat to end of layer** or **repeat to end of section** .

## Cut / copy / paste

1. Hold down the left **Shift** key to select a range of keyframes.
2. Rightclick the keyframe editor and select **cut keyframes** or **copy keyframes** .

3. Move to a different section of the timeline, rightclick the ribbon and select **paste keyframes** .

## Clear a range of keyframes

1. Hold down the left **Shift** key to select a range of keyframes.
2. Rightclick the keyframe editor and select **delete keyframes** .

# Numeric keyframes

Numeric keyframes are used for properties that use a numeric range such as 0-255 or 0-1.

## Create a numeric keyframe

- Left-click the keyframe editor of a layer at the point where you want to create a new keyframe. This will create a keyframe with the same value as the previous keyframe in the timeline.

## Move a numeric keyframe

1. To move a keyframe, click it and drag it upwards, downwards, left or right. You can also adjust the keyframe using the mouse scroll wheel.
2. You can add a keyframe and position it in a single action; just click in the timeline and drag the new keyframe without releasing the mouse button.

## Remove numeric keyframes

- To remove one keyframe, rightclick it.
- To remove multiple selected keyframes, hold down **Shift** and drag-select the keyframes. Hit the **Delete** button on the keyboard.

# Editing min/max values

As with standard numeric properties, you can set min/max constraints to limit the positions of your Keyframes to a certain range.

1. Right-click a numeric property from the Layer editor to open the Numeric property editor.

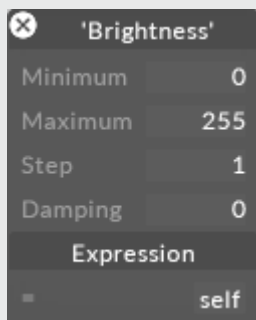

2. Type the min/max values you want to set in the **min** / **max** text fields.
3. Edit the value in the numeric property's text field in the Layer editor. If you input a value beyond the range specified in the min/max text fields, the value will automatically default to the min/max value (whichever is nearer) when you click anywhere on the screen. However, you can override this by manually moving the Keyframes on the Keyframe editor.

For more information on **step** , **damping** and editing numeric properties in general please read the 'Editing numerical properties section in the [Editing objects](#) sub-chapter.

Rightclick the keyframe editor to set the curve for all keyframes, or select a subset by holding shift and dragging a selection box over them. This will open an option menu that allows you to change the interpolation type (i.e. the shape of the curve that goes through the key values). There are three options:

# Select

The output value remains static until the next keyframe.

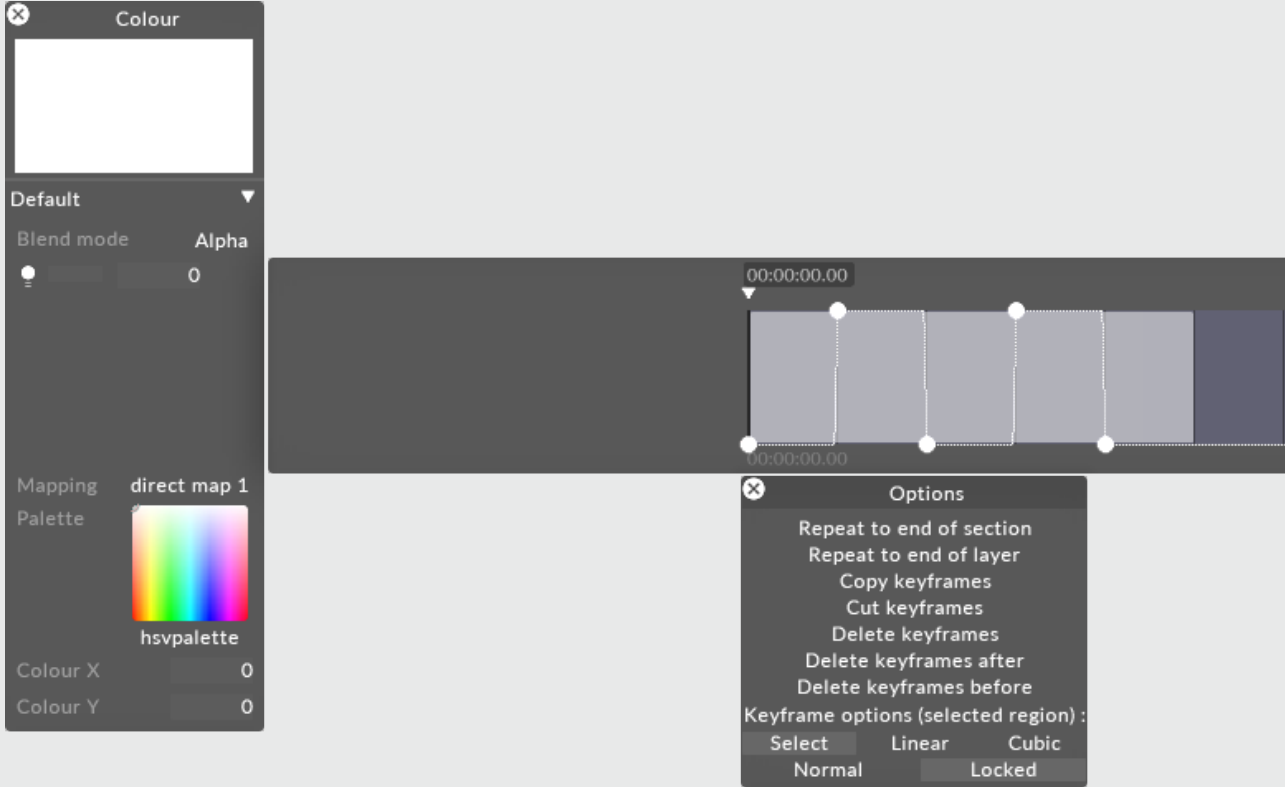

# Linear

The output follows a straight line between adjacent keyframes.

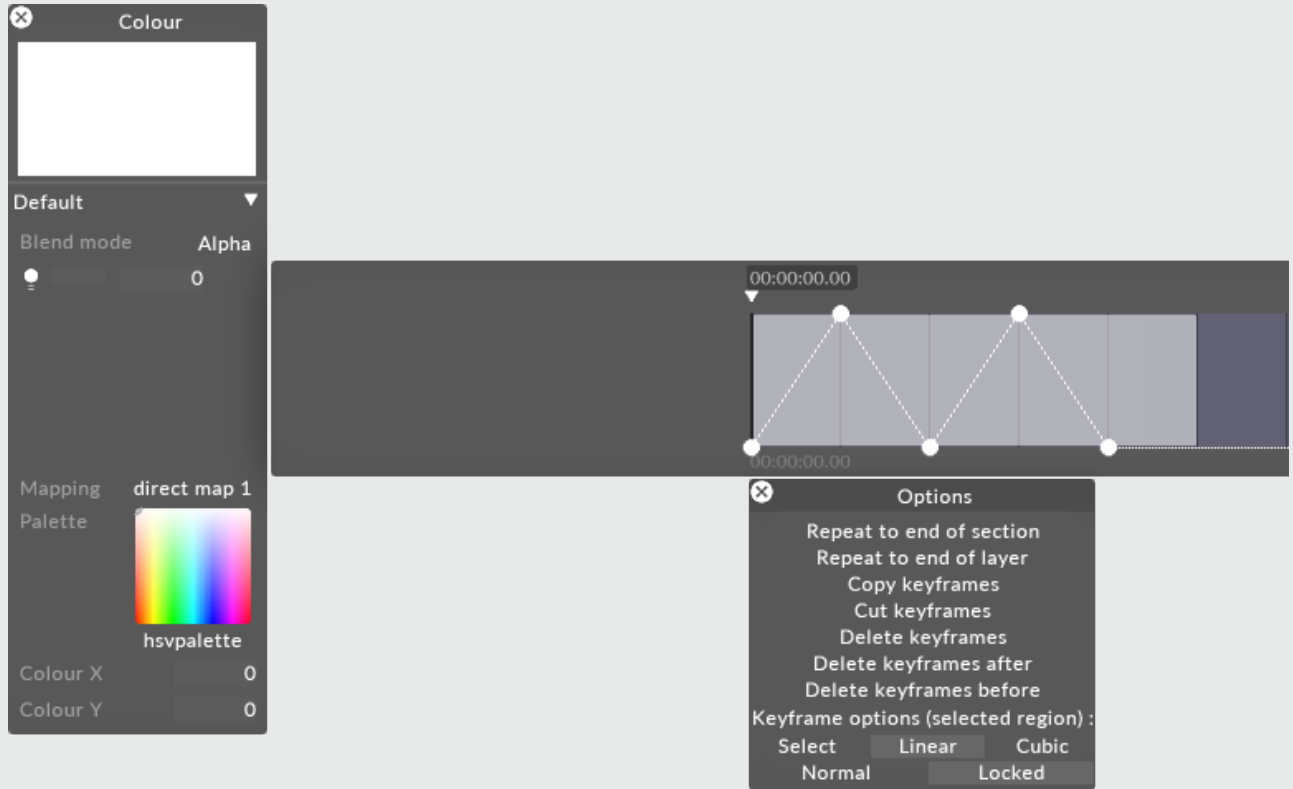

# Cubic

The output value follows a cubic curve with zero in and out speed.

Colour



Default

Blend mode Alpha

0

Mapping direct map 1

Palette



hsvpalette

Colour X 0

Colour Y 0

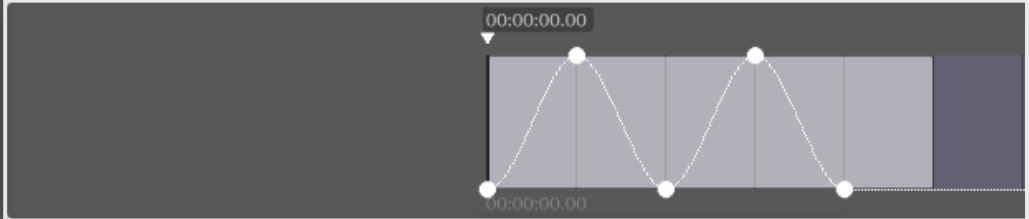

Options

- Repeat to end of section
- Repeat to end of layer
- Copy keyframes
- Cut keyframes
- Delete keyframes
- Delete keyframes after
- Delete keyframes before

Keyframe options (selected region) :

Select Linear Cubic

Normal Locked

# Object keyframes

The object keyframe editor consists of keyframes appearing as object thumbnails. The object library for that type opens up just below the keyframe editor, allowing you to drag thumbnails onto it.



## Creating an object keyframe

- Either drag a thumbnail from the object library onto the keyframe editor or left-click a thumbnail in the library to create a new keyframe at that current position.

## Moving an object keyframe

- Left-click the thumbnail in the keyframe editor and drag it left or right.



# Removing object keyframes

- Rightclick the object thumbnail in the keyframe editor.

# Option keyframes

Option property keyframe editors also consist of a series of keyframes, but each keyframe has an option choice. Option property keyframe editors behave similarly to numeric keyframe editors.

## Creating an option keyframe

- Left-click the keyframe editor at the point where you want to create a new keyframe. This will create the keyframe and open an options menu for editing the keyframe.

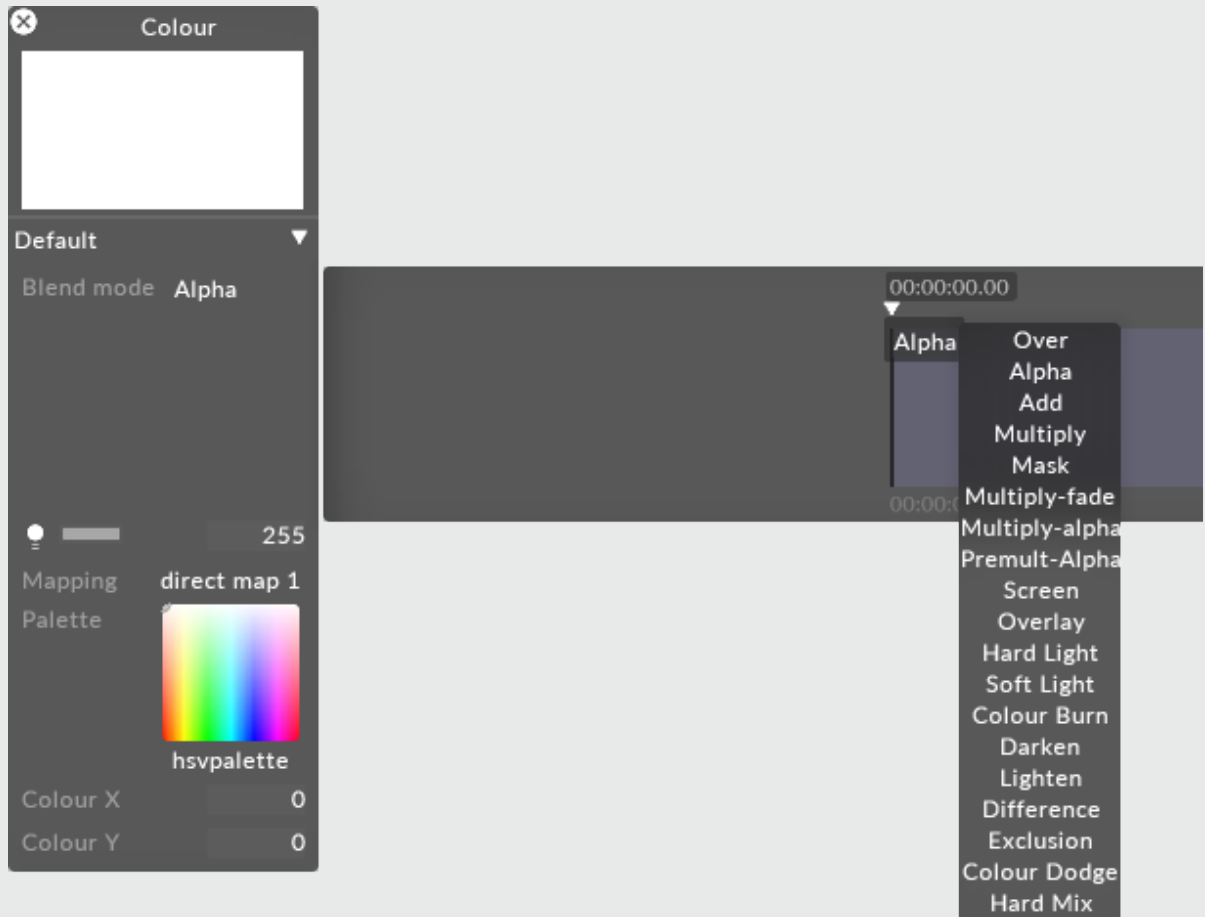

## Modifying an option keyframe

1. Left-click the keyframe and drag it left or right to change its time.
2. To select a different option, left-click the keyframe and release the mouse button immediately to open up the option list so you can choose a different value.

## Removing an option keyframe

- Rightclick the keyframe to remove it.

# Compositing layers

Arrows provide a way of compositing multiple layers together. For instance, you could take the output of a Video layer and pipe it into a Scroll layer, to scroll the video from side to side.

Multiple layers can be chained together, so for example, you could take the output of the Scroll layer and pipe it into a SpinBitmap layer.

1. To create an arrow between two layers, make sure the source layer is below the destination layer in the layer stack (because layers are rendered from the bottom up).
2. Position the cursor over the source layer, hold down the **Alt** key, press the mouse button and drag away from the source layer. You will see an arrow appear that is following the cursor.
3. Now move the mouse cursor to the destination layer and release the mouse button. This will create a new arrow between the source and destination layers.

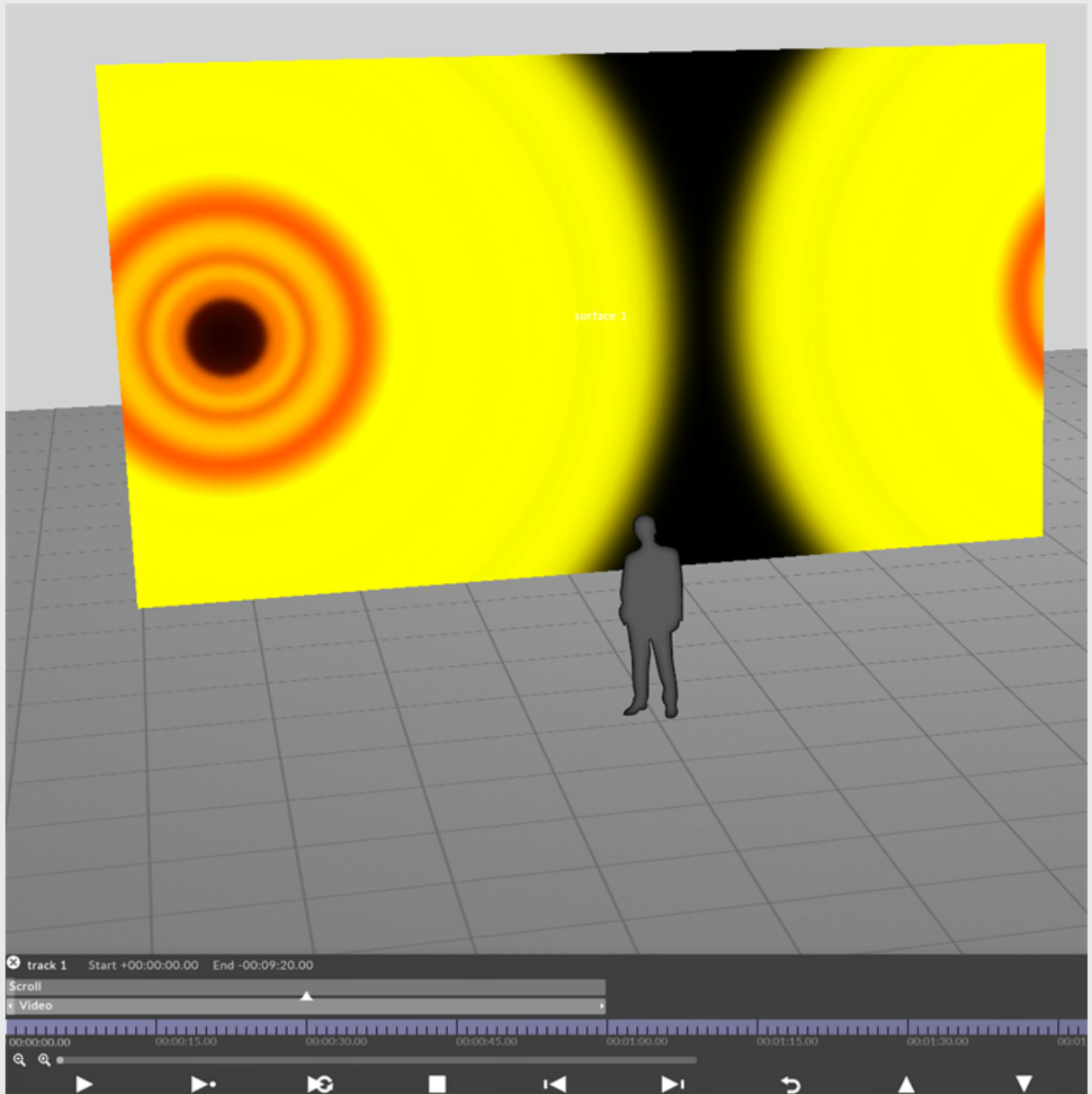

Scrolling video content created by using an Arrow to pipe a Video layer into a Scroll layer

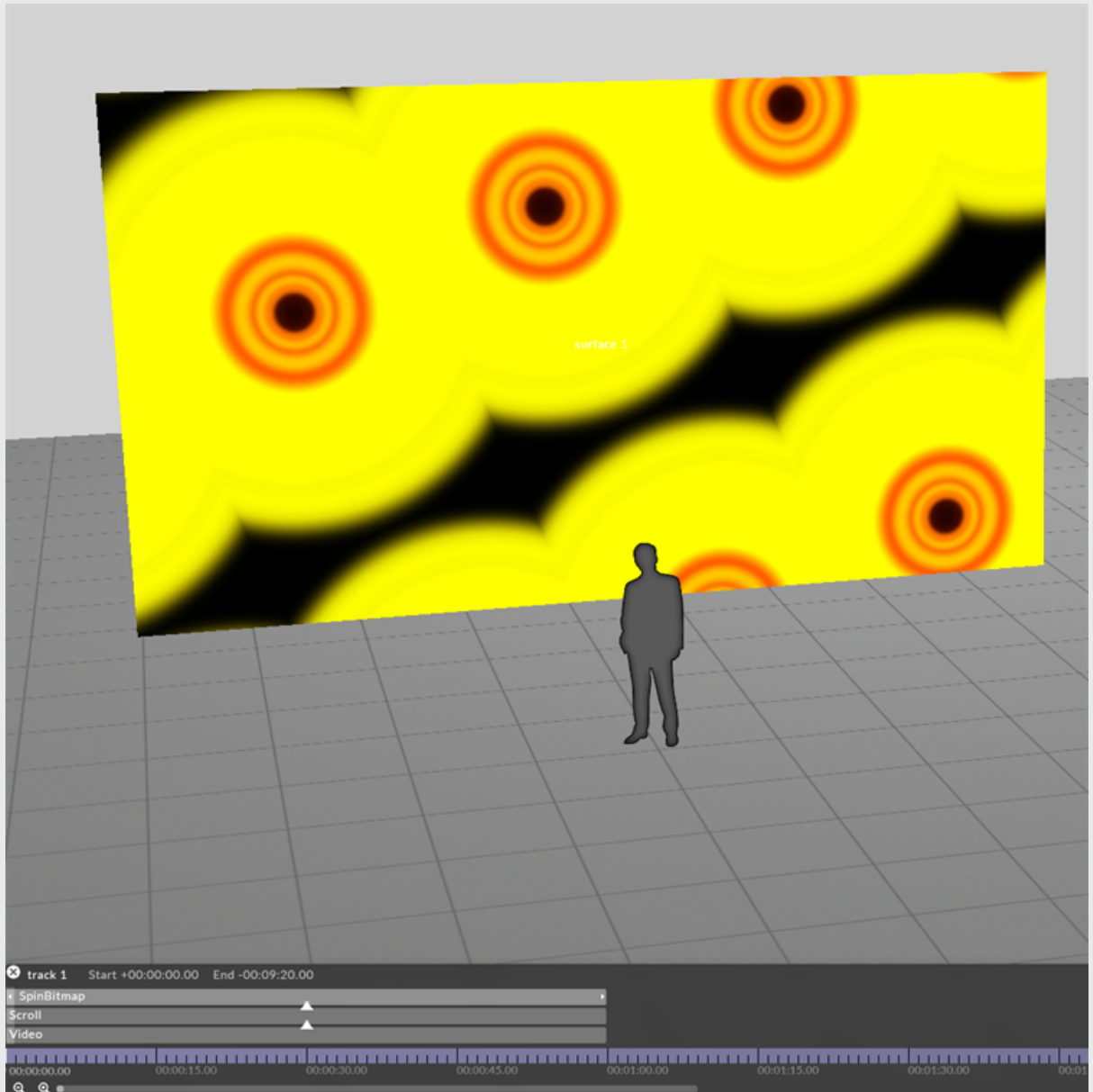

4. To remove an arrow, hold down the **Alt** key and right click the root of the arrow.

## Arrow-supported layers

All content layers can be used for piping in content into another layer. However, not all layers support being piped into.

Currently, only the Bitmap and Effect Layers can be piped into.

# Copying and pasting layers

A layer can be copied and pasted in the current track or even copied and pasted onto another.

## Copying a layer

1. Right-click the layer to open the Layer menu.
2. Left-click **copy**.

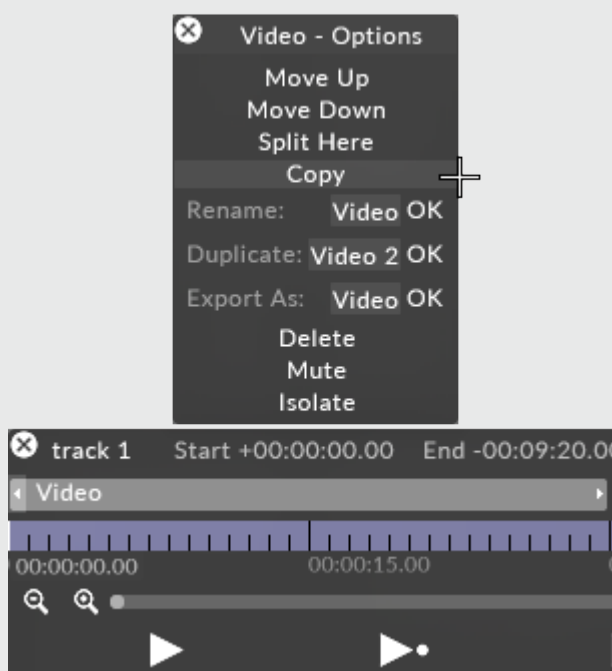

Copying a layer will copy all of the layers keyframe events. It is recommended that you rename the layer to avoid future confusion. However you cannot copy and paste groups of layers. To do this, you can export and import layers. Please read the section [Exporting / importing layers](#) for more information on this feature.

## Pasting a layer

1. Right-click the Track bar where you want to insert the layer on the Timeline. This will open the Track bars menu.
2. Left-click **paste layer 'LayerName'** to insert the layer copy at the currently selected point on the Timeline.

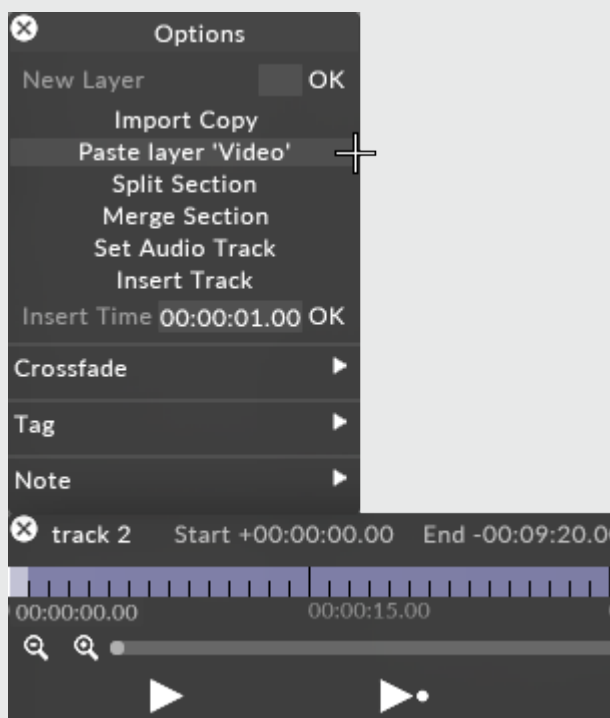



# Deleting multiple layers

1. Hold down the left **Shift** key and left-click and drag a selection rectangle in the Content Layer section over the layers you want to select.
2. Right-click the selection rectangle to open the Multiple Layer menu.
3. Left-click **delete**. The selected layers will be immediately deleted from the Content Layer section.

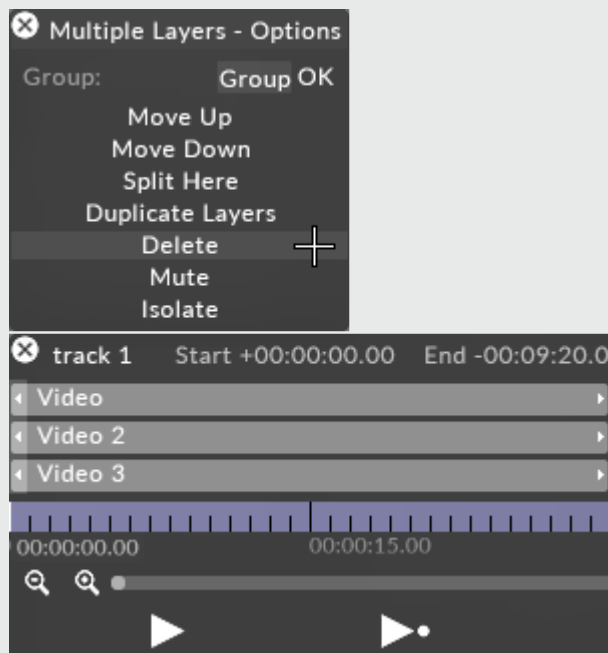

# Deleting layers

## Deleting a layer

1. Right-click the layer to open the Layer menu.
2. Left-click **delete**. The layer will be immediately deleted from the Content Layer section.

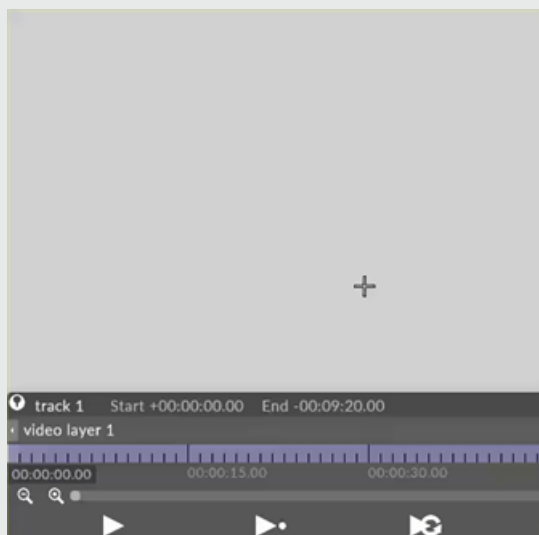

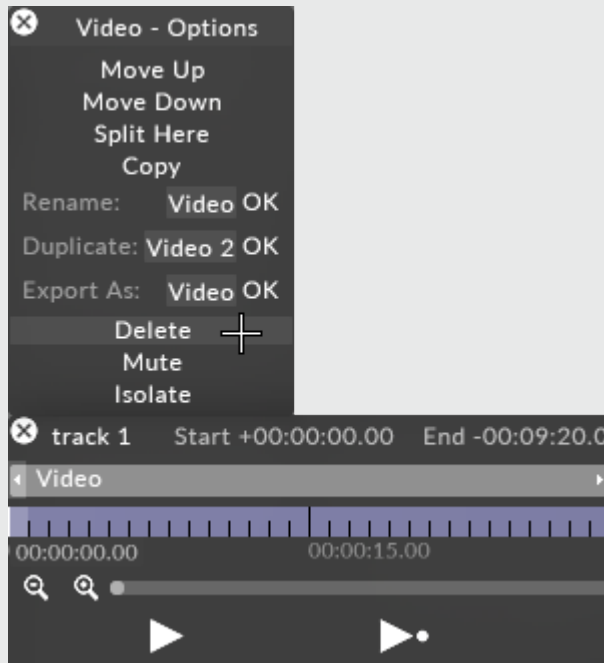

# Duplicating layers

## Duplicating a layer

1. Right-click the layer to open the Layer menu.
2. Type the new layer name in the **duplicate** text field (if different from the default layer name) and hit **Enter**. The default layer name in the text field will be the name of the layer you are duplicating with a number added to the end.

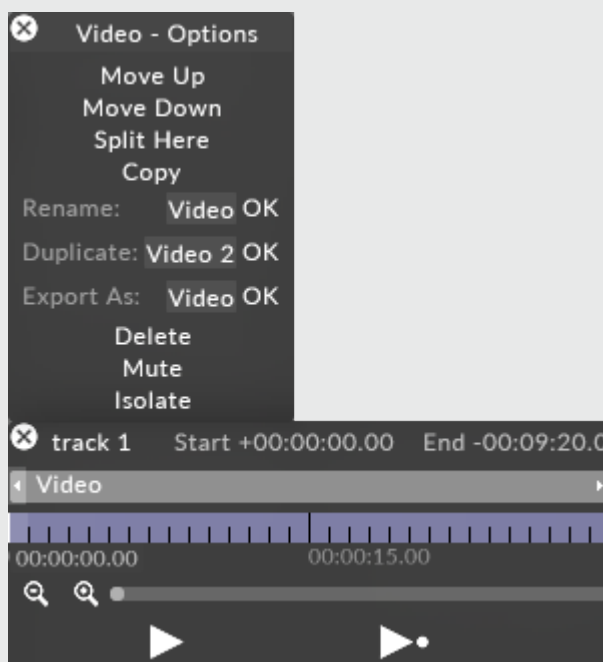

# Extending layers

You may want to extend a layer so that it renders content for a longer section of the Timeline.

## Extending a layer

1. Left-click the layer to open two small tabs at the layers edges.
2. Hover your mouse cursor over the layers edges. You will notice the cursor change from a cross hair to a double ended arrow.
3. Left-click and drag the layers extender tabs to the left or right to extend the layer.

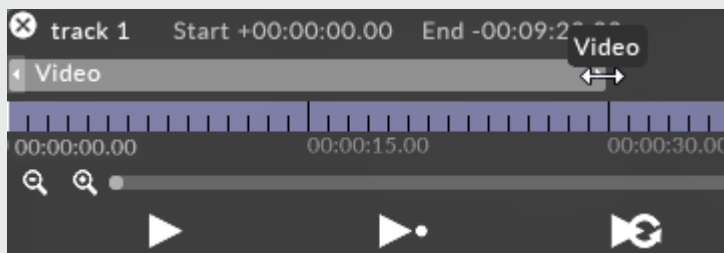

Extending a layer does not modify its keyframe events, they remain in the same position. If you reduce the extent of a layer, any key-frame events outside the layers extent remain there; if and when you extend the layer again, those key-frame events become accessible again.

# Grouping layers

When working with large numbers of layers, it is convenient to group related layers together. This reduces the vertical height of the Timeline and makes it easier to move large numbers of layers.

**Please note:** that to arrow a layer in to an existing group, the layer needs to be on top of the group in the compositing order before arrowing. Arrowing a layer from elsewhere on the timeline will not work.

You can also import and export a group of layers to the current track, or even onto another track in the Timeline. Please read the 'Importing and exporting layers' section above for more information on this very useful feature.

## Grouping layers

1. Hold down the left **Shift** key and left-click and drag a selection rectangle in the Content Layer section over the layers you want to group.
2. Right-click the highlighted layers to open the Layer menu.
3. Type the name of your group into the **group** text field and hit **Enter**. The grouped layers will turn orange.

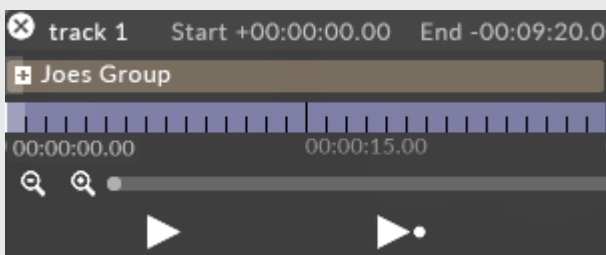
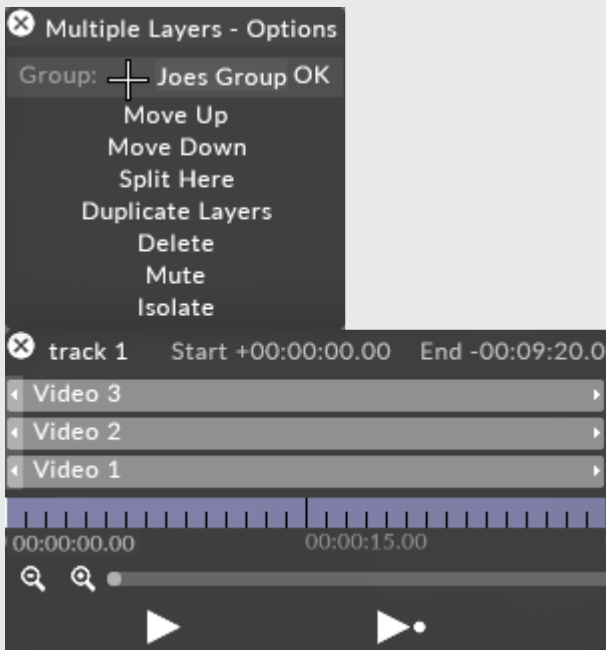
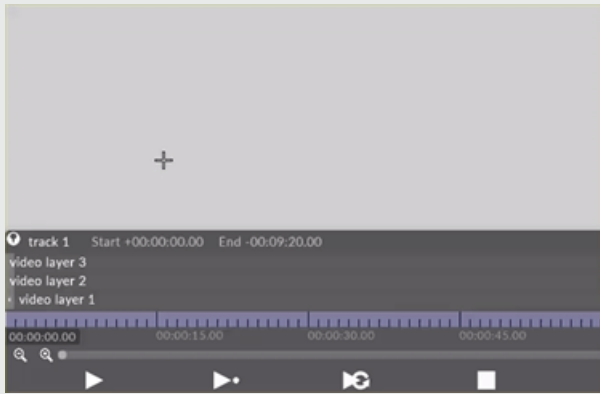

## Editing grouped layers

Left-click the **+** to expand the group layer.

The layers are revealed below the group layer and can be edited in the normal way.

## Collapsing a group of layers

Click the **-** button on the Group layer.

## Ungroup a grouped layer

1. Right-click the Group layer to open the Layer menu.
2. Left-click **ungroup**.

## Removing a layer from the group

1. Make sure the group is expanded
2. Right-click on the layer you wish to remove from the group
3. Left-click on **Extract**

## Adding a layer to a group

Hold down the **Alt** key and left-click drag an arrow from the layer to be group, to the group layer.

The layer will be added to the group layer.



# Save as and importing layers

Layers can be saved to the layers library, from where they can be imported back onto the Timeline in another location.

**Please note:** importing a layer makes a copy of the saved layer; changing the layer that you saved to the layer library does not change the copies.

This allows you to transfer layers or groups of layers in the current track, or even from one track into another track. This is extremely useful when sequencing, as you can store these saved layers in the Layers Library as templates to avoid having to repeat actions when creating layers.

**Please note:** This functionality used to be called Import & Export in previous releases.

## Saving a layer

1. Right-click the layer to open the Layer menu.
2. Type the name of your exported layer (if different from the default layer name) in the **Save as** text field and hit **OK**. This will save the layer in the Layers Library.

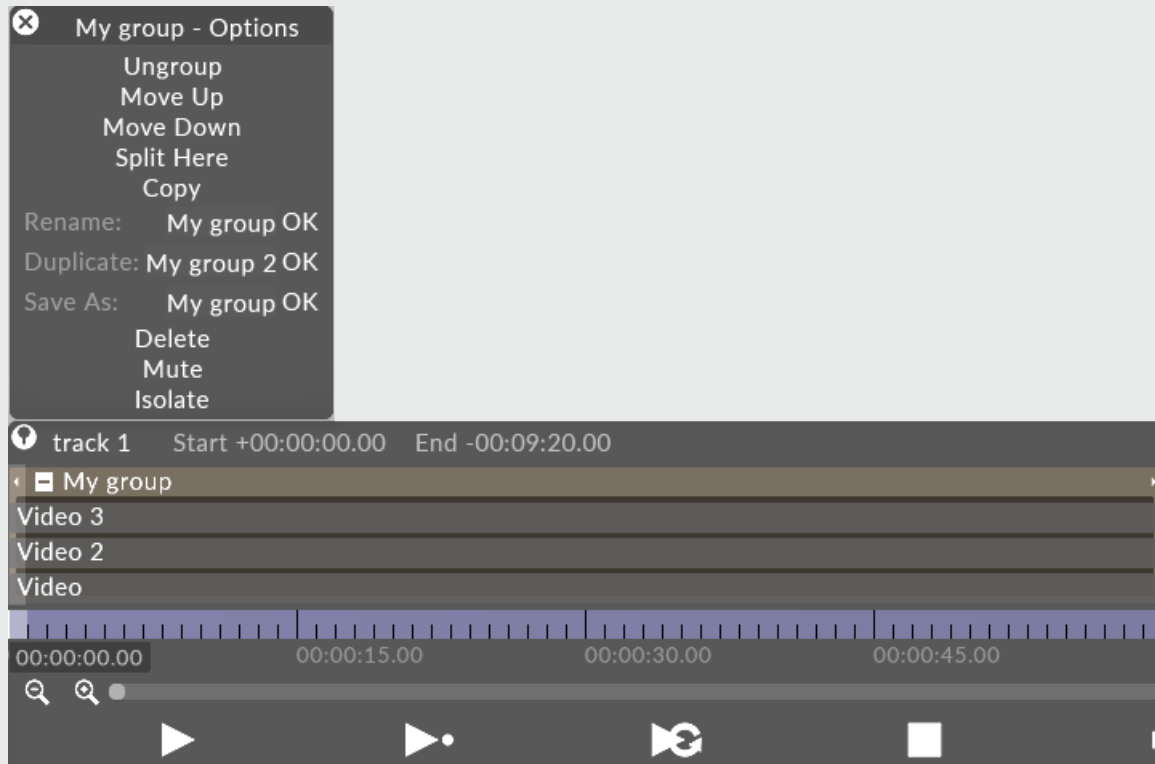

Saving a layer will copy all of the layers keyframe events.

## Importing a layer

1. Right-click the Track bar at the point where you want to import the layer on the Timeline. This will open the Track bars menu.
2. Left-click **import layer**. This will open the Layers Library.

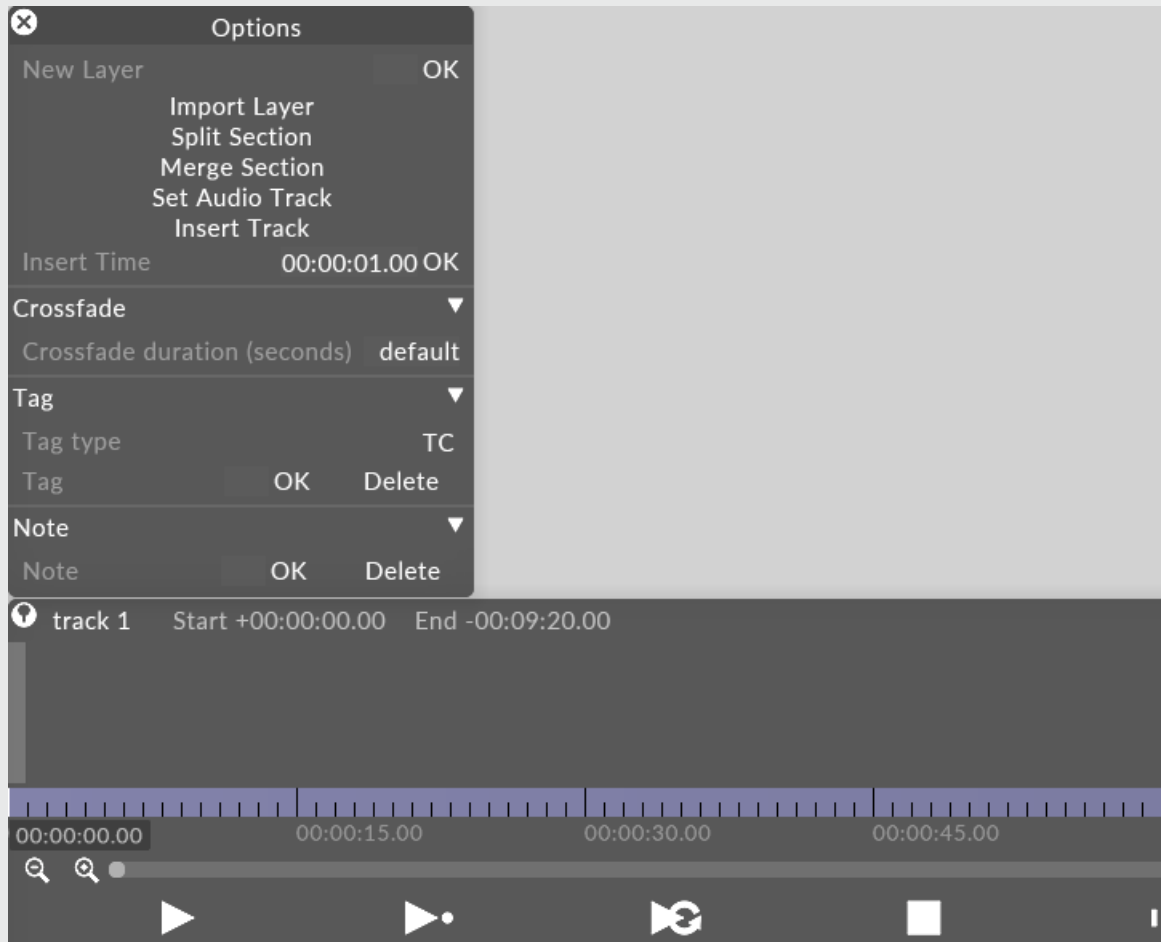

3. Left-click the saved layer from the Layers Library.

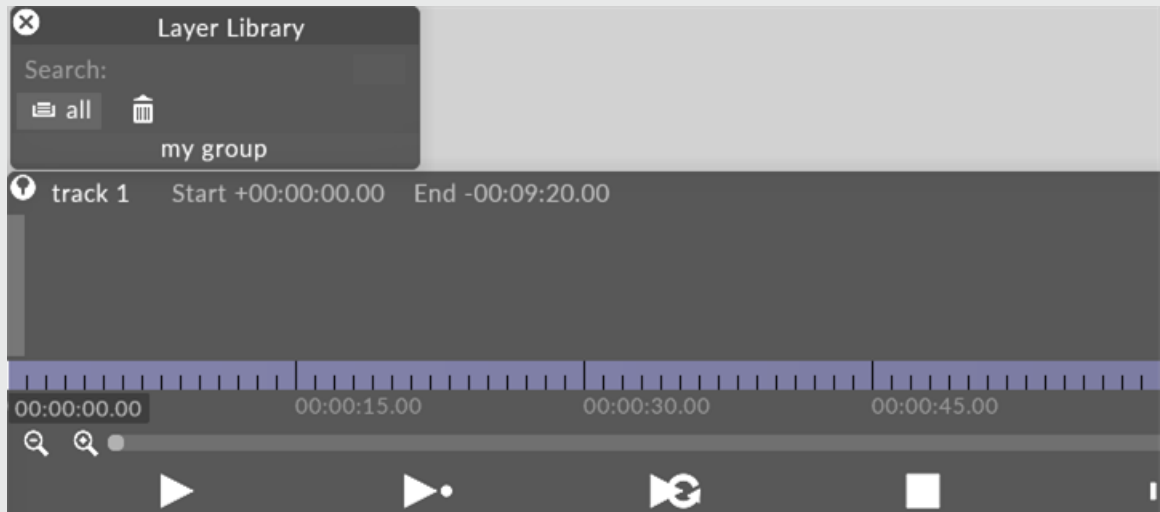

The layer will be added to the track at the currently selected point on the Timeline.

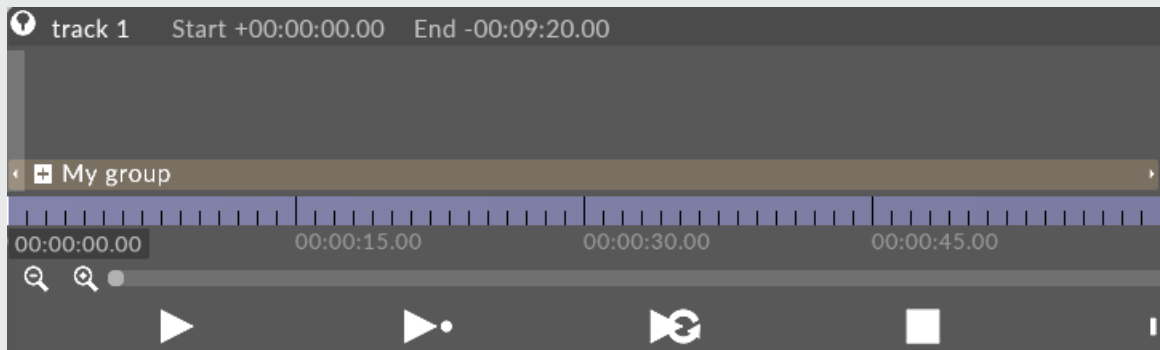

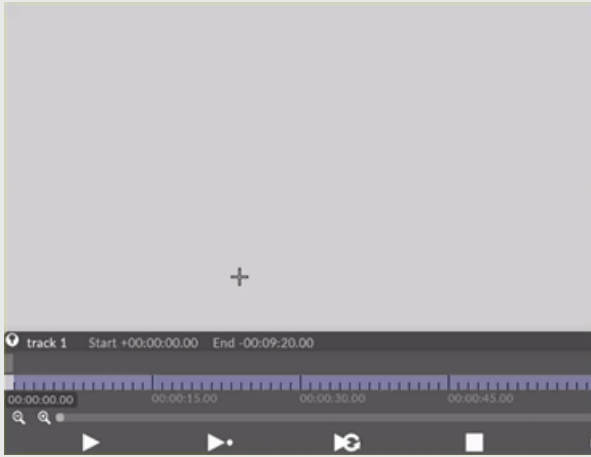

# Isolating layers

Sometimes it is useful to only see the output of a single layer when you have a stack of layers.

To see the output of a single layer:

1. Hold down the **I** key and left-click the layer. The other layers turn grey to indicate that the selected layer has been isolated.
2. Left-click anywhere in the Content Layer section to return the screen to the normal view.

Or alternatively

- Right click on the layer and select the Isolate option.

# Locking layers

## To lock a layer:

1. Right-click the layer to open the Layer menu.
2. Left-click **Lock**. This will lock the layer from edits and disallow the user from deleting, moving or changing layer values until it is unlocked.

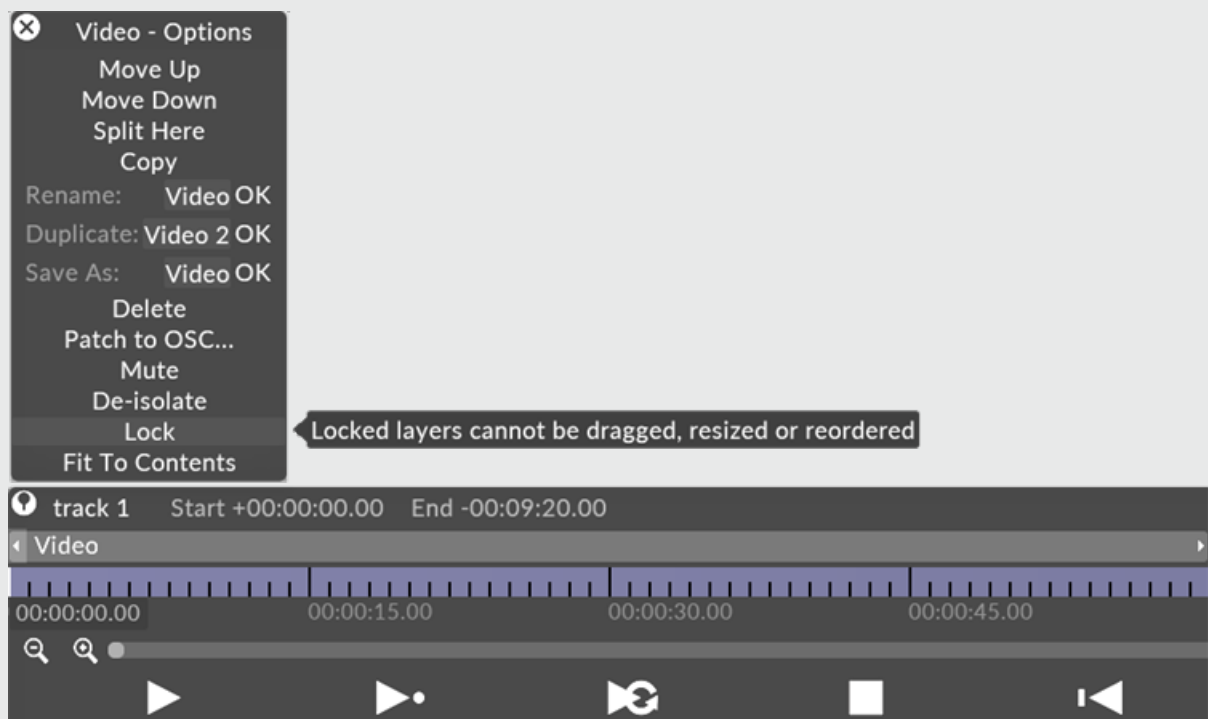

## To unlock a layer:

1. Right-click the layer to open the Layer menu.
2. Left-click **Unlock**. This will unlock the layer and allow the user to edit it again.

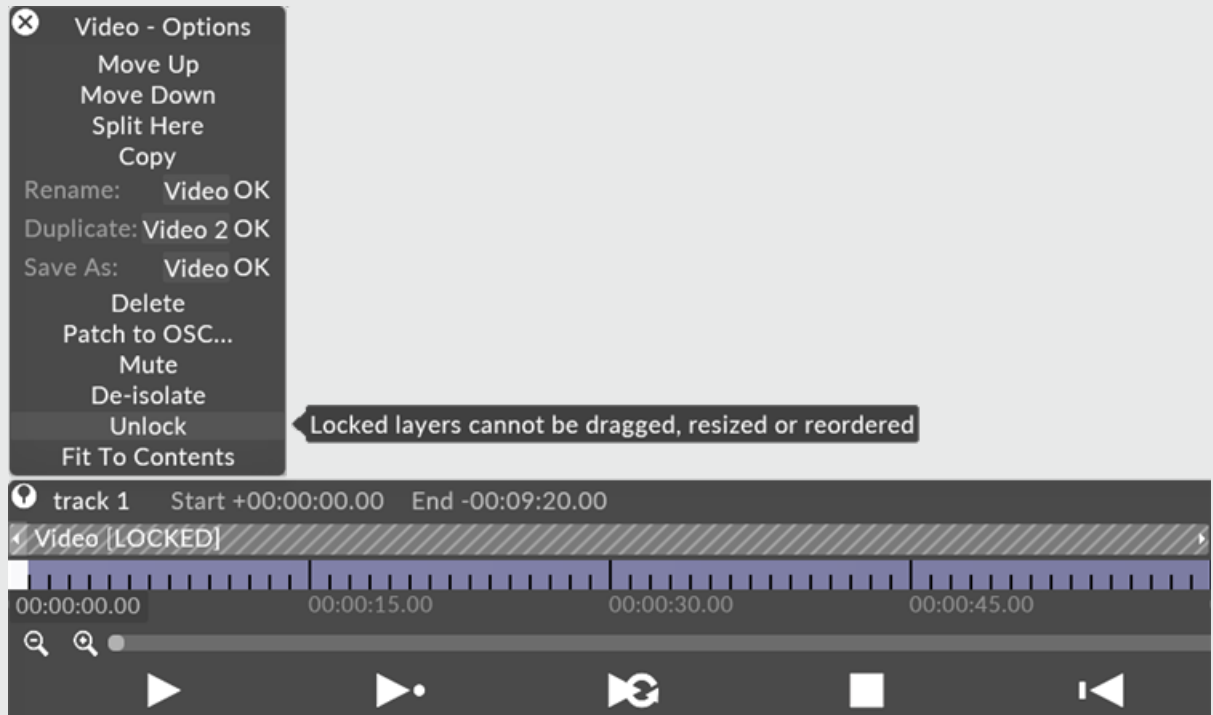

**Please note:** Locking a layer does not modify its keyframe events.



# Moving layers

Moving and re-ordering layers is particularly useful when you have a stack of layers.

Layers arranged in a stack are rendered in bottom up order: layers at the top are composited over layers at the bottom.

Moving/re-ordering a layer can be done in three ways.

## Option 1

- Left-click and drag the layer left or right. You cannot drag the layer up or down. This method can be used to move multiple layers when you have a selection rectangle. Please read the [Selecting multiple layers](#) section below for more information on selection rectangles.

## Option 2

1. Right-click the layer to open the Layer menu.
2. Left-click **move up** or **move down**.

## Option 3

- Left-click the layer and hold **Ctrl+ Alt** whilst using the keyboard arrow keys to move the layer up, down, left or right. Moving a layer moves all keyframe events.

# Muting layers

It is possible to mute a layer to temporarily disable it, allowing you to see layers behind it in a stack of layers.

## Muting a single layer:

1. Hold down the **M** key and left-click the layer.  
Or alternatively
2. Right click on the layer and left click the Mute option.

The layer will turn dark grey to indicate that the selected layer has been muted.

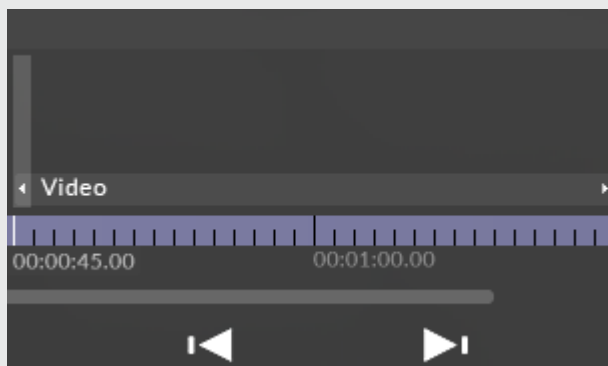

## Unmuting a single layer:

1. Hold down the **M** key and left-click the layer again.  
Or alternatively
2. Right click on the layer and left click the unmute option.

The layer will return to its original colour.

# Renaming layers

To rename a layer:

1. Right-click the layer to open the Layer menu.
2. Type the new layer name in the **rename layer** text field and hit **Enter**. The layers name will update instantly. A good layer naming format is Layer-type + description.

# Selecting multiple layers

To select multiple layers:

- Hold down the left **Shift** key and left-click and drag a selection rectangle in the Content Layer section over the layers you want to select. This allows you to select a range of layers.

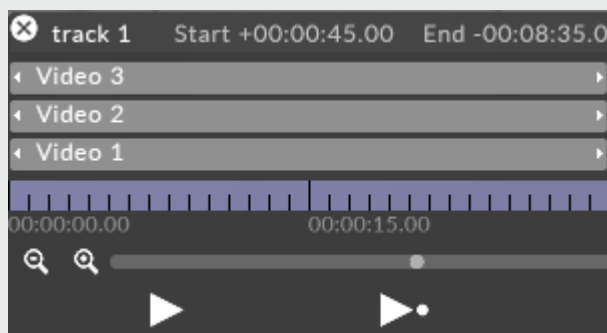

Selecting multiple layers will copy the selected layers keyframe events.

- Left-click anywhere in the Content Layer section to clear the selection rectangle.

# Splitting layers

## To split a layer:

1. Left-click a Track bar at the point on the Timeline where you want to split the layer.
2. Right-click the layer to open the Layer menu.
3. Left-click **split**. This will split the layer at the currently selected Timeline position into two shorter layers.

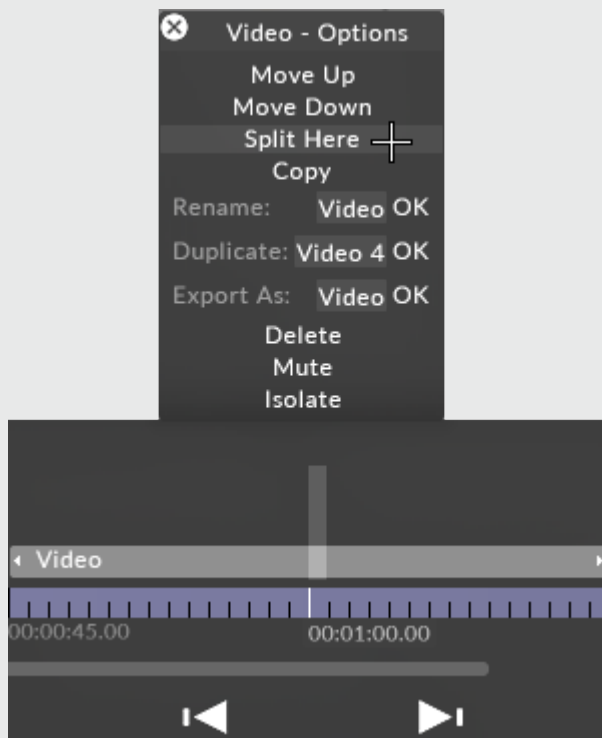

Splitting a layer does not modify its keyframe events, they remain in the same position. If you split the layer, any key-frame events outside the layers extent remain there; if and when you extend the layer again, those key-frame events become accessible again.

# Sockpuppet overview

## What is Sockpuppet

Sockpuppet fully implements DMX & OSC controls into Disguise software. This feature enables the user to fully control all layers and their parameters from a lighting desk or OSC application. As a result, the operator is no longer restricted to timeline based sequencing, but can now program their project using the lighting desk's cue stack, or a combination of both; by having certain layers controlled from the lighting desk and others controlled from the Timeline. In short, Sockpuppet works by treating all of the layer types as fixture personalities.

## Compatibility

Sockpuppet is fully compatible with any lighting desk capable of outputting Art-Net or sACN, as well as any OSC platform capable of sending OSC control strings.

Additionally, for added usability XML personalities can be exported from Disguise software and imported into any XML compatible console.

### **Known Limitations**

Frame accurate sync across multiple machines cannot be guaranteed. This is because sockpuppet playback responds locally to control packets received on each machine, rather than the director receiving the control data and distributing it synchronously across the machines in the session. This is to guarantee as low latency response as possible.

In setups where a single screen is stitched from outputs across multiple servers, sockpuppet cannot guarantee synchronous playback across the whole surface.

## Network setup - console

First ensure the lighting desk and server are networked together and able to **ping** each other. You will need to assign the IP address and Subnet mask on both the lighting desk's Art-Net port and the server's Art-Net port. These will normally be addressed as shown below:

- server - DMX port - 2.0.0.x - 255.0.0.0
- lighting desk - Art-Net port - 2.0.0.x - 255.0.0.0

**Please note:** Each device needs a unique IP address within the same IP range and subnet

## Network setup - OSC

First ensure the OSC app and server are networked together and able to **ping** each other. You will need to assign the IP address and Subnet mask (ensuring they are both set to the same IP and Subnet range) on the system hosting the OSC application and the server's network port that is receiving the OSC data.

- Set OSC application send IP
- Set OSC application receive IP
- Set the OSC application outgoing port
- Set the OSC application incoming port
- Set Disguise software OSC device send IP
- Set Disguise software OSC device receive IP



- Set the OSC Disguise software outgoing port
- Set the OSC Disguise software incoming port

## Confirm the connection

To check the two devices can communicate with each other, a command line called **ping** should be used.

**Please note:** If using sockpuppet on a Director/Actor system, you will need to give each machine its own Art-Net or OSC connection as each machine needs to receive the data from the control source.

## Setup

Once network connectivity has been confirmed between the server and the lighting desk, the next step is to create a DMX or OSC device in Disguise software.

Read more about DMX setup [here](#).

Read more about OSC devices [here](#).

# Sockpuppet overview

## What is Sockpuppet

Sockpuppet fully implements DMX & OSC controls into Disguise software. This feature enables the user to fully control all layers and their parameters from a lighting desk or OSC application. As a result, the operator is no longer restricted to timeline based sequencing, but can now program their project using the lighting desk's cue stack, or a combination of both; by having certain layers controlled from the lighting desk and others controlled from the Timeline. In short, Sockpuppet works by treating all of the layer types as fixture personalities.

## Compatibility

Sockpuppet is fully compatible with any lighting desk capable of outputting Art-Net or sACN, as well as any OSC platform capable of sending OSC control strings.

Additionally, for added usability XML personalities can be exported from Disguise software and imported into any XML compatible console.

### **Known Limitations**

Frame accurate sync across multiple machines cannot be guaranteed. This is because sockpuppet playback responds locally to control packets received on each machine, rather than the director receiving the control data and distributing it synchronously across the machines in the session. This is to guarantee as low latency response as possible.

In setups where a single screen is stitched from outputs across multiple servers, sockpuppet cannot guarantee synchronous playback across the whole surface.

## Network setup - console

First ensure the lighting desk and server are networked together and able to **ping** each other. You will need to assign the IP address and Subnet mask on both the lighting desk's Art-Net port and the server's Art-Net port. These will normally be addressed as shown below:

- server - DMX port - 2.0.0.x - 255.0.0.0
- lighting desk - Art-Net port - 2.0.0.x - 255.0.0.0

**Please note:** Each device needs a unique IP address within the same IP range and subnet

## Network setup - OSC

First ensure the OSC app and server are networked together and able to **ping** each other. You will need to assign the IP address and Subnet mask (ensuring they are both set to the same IP and Subnet range) on the system hosting the OSC application and the server's network port that is receiving the OSC data.

- Set OSC application send IP
- Set OSC application receive IP
- Set the OSC application outgoing port
- Set the OSC application incoming port
- Set Disguise software OSC device send IP
- Set Disguise software OSC device receive IP

- Set the OSC Disguise software outgoing port
- Set the OSC Disguise software incoming port

## Confirm the connection

To check the two devices can communicate with each other, a command line called **ping** should be used.

**Please note:** If using sockpuppet on a Director/Actor system, you will need to give each machine its own Art-Net or OSC connection as each machine needs to receive the data from the control source.

## Setup

Once network connectivity has been confirmed between the server and the lighting desk, the next step is to create a DMX or OSC device in Disguise software.

Read more about DMX setup [here](#).

Read more about OSC devices [here](#).

# Bank Editor

Please note: it is important to note for best results have the console set up to work in decimal rather than percent.

## What is the bank editor?

The bank editor enables us to assign DMX values to the various resources needed within a layer, examples of such resource parameters include, video or bitmap files, mapping types or HTML bookmarks. This process is managed on a bank and slot basis.

## Banks & slots

Within the layer personality, sockpuppet will assign two channels to each resource parameter, the first of these channels will be for the resource bank, and the second will be for the resource slot. For example within the video layer personality, channel 8 is for the video bank & channel 9 is for the video slot.

Example: If we had a video asset assigned to video slot 5 in video bank 3, we would need to output the following from the lighting console to recall it.

**channel 8 @3, channel 9 @5.**

This means that we can have a maximum of 255 video banks and within each of those we can have 255 video slots, giving us a total of 65025 assignable video slots (255\*255) for each resource type.

# Main Interface elements

To open the Bank editor right click on the state menu (top left) and underneath the sockpuppet tab left click "bank".

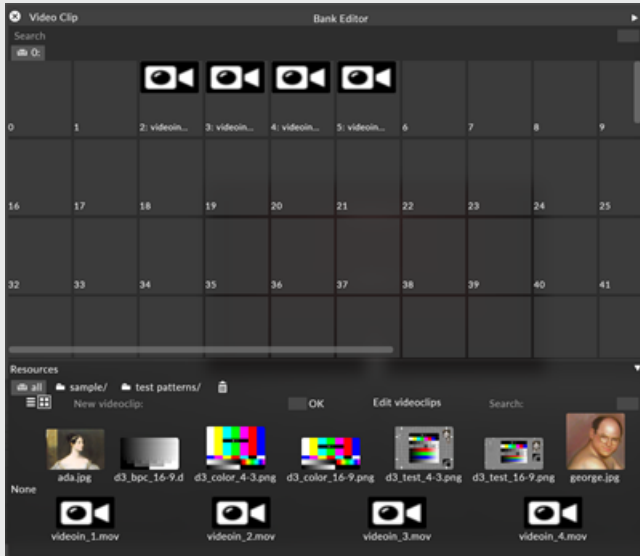

At the top of the window we have the currently selected resource type, in this case, video clip. Left click Video Clip to open a menu for other resource types. You can populate the resource bank with resources by dragging them from the resources view in the bottom of the window, to empty bank slots.



## Preferences

The bank editor preferences can be opened by left clicking the small white triangle in the top right corner of the window.

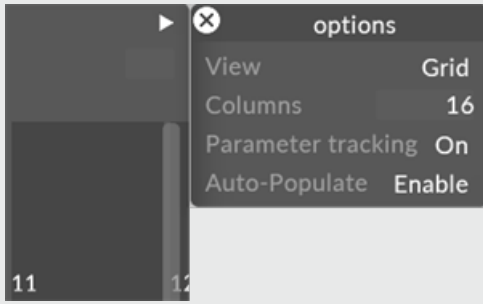

## View type

Here we can select the way in which we want to view the bank editor. Grid will display the slot window in a grid format and List will display the slot window as a list.

## Columns

Specifies the number of columns displayed by default.

## Parameter tracking

By left clicking on this field and setting it to "on" we will have a visual representation of which slot we currently have selected; so as the console programmer scrolls through the slots and banks on the encoders, a red square will be drawn over the slot we currently have selected.

## Auto-populate

When disabled, it stops assets being added automatically based on their file name.

## Search function

This enables you to search through the assets already assigned to a slot, and will highlight them with a light blue square if they match the search criteria.

## Working with banks

The banks are all configured and managed in the tabs bar above the slot layout. By default we will have bank 0 already created. In order to open the bank options window right click on an existing bank or on bank 0.

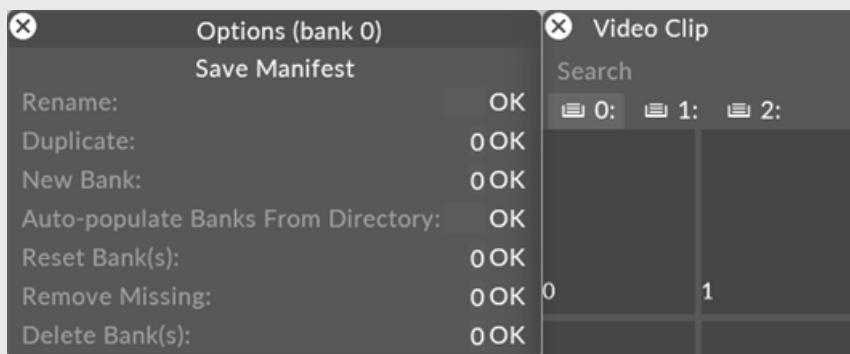

## Rename

Here we can specify a custom name for our bank, type it into the field and click **ok** or press the return key.

## Duplicate

Here we can copy the contents of our selected bank into another, specify the destination bank number in the field and click **ok** or press the return key.



## New bank

Here we can create a new bank. to do this enter the number for your new bank and click **ok** or press the return key.

## Auto-populate banks from directory

Please see below, "under adding assets to slots"

## Reset bank

This will return the bank to its default state, and empty any populated slots.

## Remove missing

Allows you to remove missing media from a selected bank.

## Delete bank

By left clicking here, we will completely delete the bank from our bank editor.

## Adding assets to slots

### Manually add assets to slots

To manually add an asset to a slot, simply select the resource type you wish to assign, such as textures, left click on the thumbnail in the library and drag and drop it over the slot you wish to assign it to. repeat this process for all of your content. If you have your content organised into files and boxes ([click here to read about organising your content](#)) then you can quickly populate your slots with whole

boxes at a time. To do this simply hold down **Alt** on the keyboard and left click over the box you wish to use, this will turn our cursor into a white arrow which we can drag from our box to the first slot we wish to use, release and it will populate the slots with the contents of that box.

## Using auto-populate to add assets to slots

Another widely used method of assigning DMX values to assets, is adding numerical values to folders and files within your assets library. The Disguise software also supports this workflow and is managed via the auto-populate field in the bank options (see above for how to access).

### Auto-populate file structure:

Each of the content folders located within the objects/videofile folder needs to be labelled numerically, for example: **001\_Foldername**

Files within this folder should follow this same numeric labelling scheme: **001\_filename**

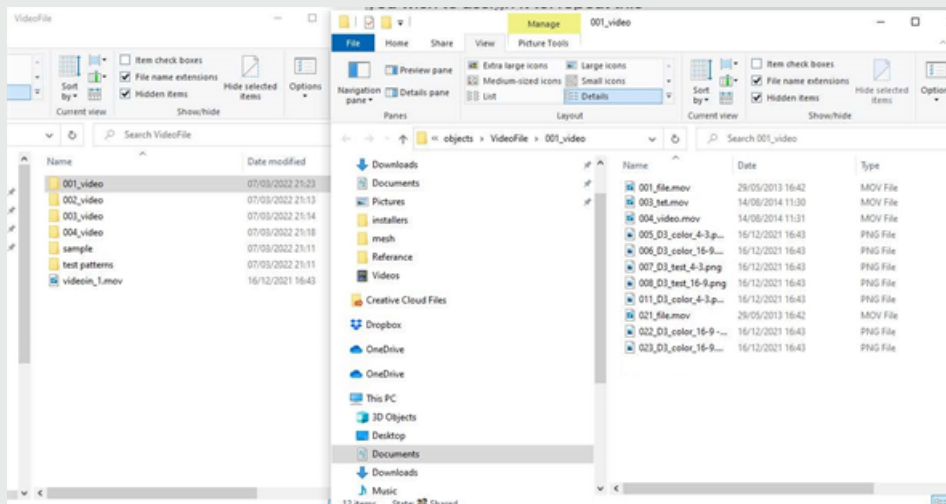

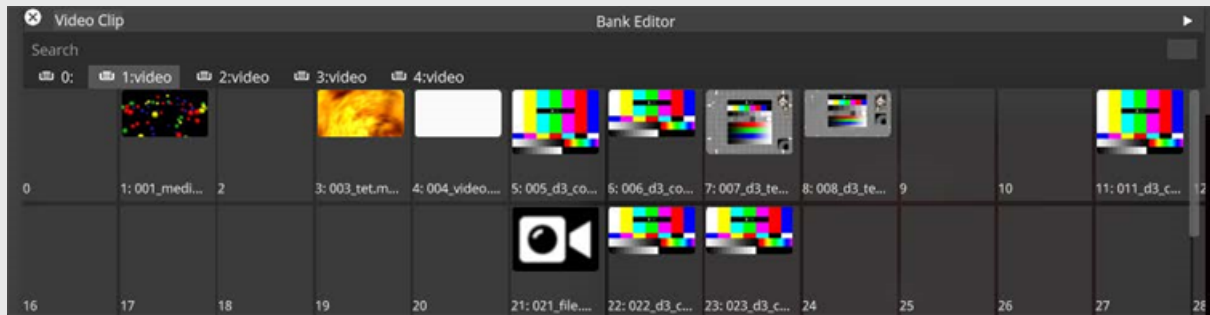

Auto-populated results within the Bank Editor

## Creating a directory

When using this method to populate your banks and slots, you will need to start by numbering your folders and files within the project directory in Windows.

Navigate to the resource folder you wish to use (we will be using DxTexture as an example) and number your folders within the DxTexture folder, these will become your bank numbers. Within each of these folders you will need to number your asset files, these will become your slot numbers.

## Clearing assets from slots

In order to clear a slot we will need to overwrite it with the "none" thumbnail from our resource library. To do this simply left click on the none thumbnail and drag it over a populated slot. We could also use the reset bank option to clear out the whole bank.

## Banks with OSC

As of r17.3, banks can also be used with OSC sockpuppet.

- The path is always the same: /d3/layer/Typeoflayer/Nameoflayer - Example:  
/d3/layer/Video/video
- It's always one message (One address/path + one or two integers)

- Option one: One path and one integer with bank and slot encoded into one number (e.g, bank 1 slot 1 is  $256+1=257$ ).
- The formula for a single int is  $\text{bank} * 255 + \text{slot}$  (eg. bank 0 slot 1 is  $0 * 255 + 1$ )
- Option two: One path and two integers with bank in the first integer and slot in the second integer.

# Patch assignments

Sockpuppet treats all of Disguise's layer types as fixture personalities. The Patch Assignments window is where we patch or assign our layers on our Timeline to incoming DMX values or channels. For OSC the process is slightly different.

## DMX

### Patching a layer to DMX control

1. Access the patch assignments window by right-click on the d3 icon in the top left corner of the interface.
2. Navigate down to the Sockpuppet tab.
3. Beneath this you will find two fields, the first will be **Patch assignments** and the second **Bank assignments**.
4. Left-click Patch Assignments to open the patch assignments window.

Patch Assignments															
Editor tracking															On
View type															Patch Grid
Viewing universe															1
1	2	3	4	5	6	7	8	9	10	11	12	13	14	15	16
17	18	19	20	21	22	23	24	25	26	27	28	29	30	31	32
33	34	35	36	37	38	39	40	41	42	43	44	45	46	47	48
49	50	51	52	53	54	55	56	57	58	59	60	61	62	63	64
65	66	67	68	69	70	71	72	73	74	75	76	77	78	79	80
81	82	83	84	85	86	87	88	89	90	91	92	93	94	95	96
97	98	99	100	101	102	103	104	105	106	107	108	109	110	111	112
113	114	115	116	117	118	119	120	121	122	123	124	125	126	127	128
129	130	131	132	133	134	135	136	137	138	139	140	141	142	143	144
145	146	147	148	149	150	151	152	153	154	155	156	157	158	159	160
161	162	163	164	165	166	167	168	169	170	171	172	173	174	175	176
177	178	179	180	181	182	183	184	185	186	187	188	189	190	191	192
193	194	195	196	197	198	199	200	201	202	203	204	205	206	207	208
209	210	211	212	213	214	215	216	217	218	219	220	221	222	223	224
225	226	227	228	229	230	231	232	233	234	235	236	237	238	239	240
241	242	243	244	245	246	247	248	249	250	251	252	253	254	255	256
257	258	259	260	261	262	263	264	265	266	267	268	269	270	271	272
273	274	275	276	277	278	279	280	281	282	283	284	285	286	287	288
289	290	291	292	293	294	295	296	297	298	299	300	301	302	303	304
305	306	307	308	309	310	311	312	313	314	315	316	317	318	319	320
321	322	323	324	325	326	327	328	329	330	331	332	333	334	335	336
337	338	339	340	341	342	343	344	345	346	347	348	349	350	351	352
353	354	355	356	357	358	359	360	361	362	363	364	365	366	367	368
369	370	371	372	373	374	375	376	377	378	379	380	381	382	383	384
385	386	387	388	389	390	391	392	393	394	395	396	397	398	399	400
401	402	403	404	405	406	407	408	409	410	411	412	413	414	415	416

# View Types

Left click on the view type field to open the list of available view options.

## Patch grid

Displays all 512 channels in a grid format. You are able to patch to any free channels here or view which channels you have already populated with a patch. Left-click on Patch Grid to view different options to change the layout of the patch window.

Please note: this is the view type you will need to be in to patch your layers.

## Patch list

This shows us a list of all of the current layers patched and their start channels within any selected universe (selectable from the Viewing Universe field).

## Global patch list

This follows the same format as the Patch List, however this will show us a full list of all layers patched regardless of which universe they start on.

## Universe occupancy

This will show us in grid format which of our universes we currently have layers patched to (a blue square over any universe indicates we have layers patched).

# Patching layers

To patch layers within Disguise software ensure:

- The Patch Assignments window is open & in the patch grid view type.
- The layer you want to patch is added to the Timeline. Click [here](#) for more information on working with layers.
- Hover the cursor over the DMX channel you want to patch to in the Patch Assignments window.
- Select the DMX channel while holding down **ALT** to generate a white arrow, which should be dragged down to the layer on the Timeline that you want to patch to.



**Patch Assignments**

Editor tracking On

View type Patch Grid

Viewing universe 1

1	2	3	4	5	6	7	8	9	10	11	12	13	14	15	16
17	18	19	20	21	22	23	24	25	26	27	28	29	30	31	32
33	34	35	36	37	38	39	40	41	42	43	44	45	46	47	48
49	50	51	52	53	54	55	56	57	58	59	60	61	62	63	64
65	66	67	68	69	70	71	72	73	74	75	76	77	78	79	80
81	82	83	84	85	86	87	88	89	90	91	92	93	94	95	96
97	98	99	100	101	102	103	104	105	106	107	108	109	110	111	112
113	114	115	116	117	118	119	120	121	122	123	124	125	126	127	128
129	130	131	132	133	134	135	136	137	138	139	140	141	142	143	144
145	146	147	148	149	150	151	152	153	154	155	156	157	158	159	160
161	162	163	164	165	166	167	168	169	170	171	172	173	174	175	176
177	178	179	180	181	182	183	184	185	186	187	188	189	190	191	192
193	194	195	196	197	198	199	200	201	202	203	204	205	206	207	208
209	210	211	212	213	214	215	216	217	218	219	220	221	222	223	224
225	226	227	228	229	230	231	232	233	234	235	236	237	238	239	240
241	242	243	244	245	246	247	248	249	250	251	252	253	254	255	256
257	258	259	260	261	262	263	264	265	266	267	268	269	270	271	272
273	274	275	276	277	278	279	280	281	282	283	284	285	286	287	288
289	290	291	292	293	294	295	296	297	298	299	300	301	302	303	304
305	306	307	308	309	310	311	312	313	314	315	316	317	318	319	320
321	322	323	324	325	326	327	328	329	330	331	332	333	334	335	336
337	338	339	340	341	342	343	344	345	346	347	348	349	350	351	352
353	354	355	356	357	358	359	360	361	362	363	364	365	366	367	368
369	370	371	372	373	374	375	376	377	378	379	380	381	382	383	384
385	386	387	388	389	390	391	392	393	394	395	396	397	398	399	400
401	402	403	404	405	406	407	408	409	410	411	412	413	414	415	416

track 1 Start +00:00:00.00 End -00:09:20.00

Video

00:00:00.00 00:00:15.00 00:00:30.00 00:00:45.00

⏪ ⏩ ⏮ ⏭ ⏸ ⏪

This will create a green block over the channels in our patch grid that the layer will take up, and also turn the layer on the timeline green to signify the layer is patched and only controllable through Sockpuppet DMX.

We will also be presented with some key information regarding our patch. This will include the start address, a user specified name (this will be "untitled" by default) the layer type, and the personality version.

✕
Patch Assignments

Editor tracking
On

View type
Patch Grid

Viewing universe
1

1:1 Video (VideoModule v16)

82 83 84 85 86 87 88 89 90 91 92 93 94 95 96

97 98 99 100 101 102 103 104 105 106 107 108 109 110 111 112

113 114 115 116 117 118 119 120 121 122 123 124 125 126 127 128

129 130 131 132 133 134 135 136 137 138 139 140 141 142 143 144

145 146 147 148 149 150 151 152 153 154 155 156 157 158 159 160

161 162 163 164 165 166 167 168 169 170 171 172 173 174 175 176

177 178 179 180 181 182 183 184 185 186 187 188 189 190 191 192

193 194 195 196 197 198 199 200 201 202 203 204 205 206 207 208

209 210 211 212 213 214 215 216 217 218 219 220 221 222 223 224

225 226 227 228 229 230 231 232 233 234 235 236 237 238 239 240

241 242 243 244 245 246 247 248 249 250 251 252 253 254 255 256

257 258 259 260 261 262 263 264 265 266 267 268 269 270 271 272

273 274 275 276 277 278 279 280 281 282 283 284 285 286 287 288

289 290 291 292 293 294 295 296 297 298 299 300 301 302 303 304

305 306 307 308 309 310 311 312 313 314 315 316 317 318 319 320

321 322 323 324 325 326 327 328 329 330 331 332 333 334 335 336

337 338 339 340 341 342 343 344 345 346 347 348 349 350 351 352

353 354 355 356 357 358 359 360 361 362 363 364 365 366 367 368

369 370 371 372 373 374 375 376 377 378 379 380 381 382 383 384

385 386 387 388 389 390 391 392 393 394 395 396 397 398 399 400

401 402 403 404 405 406 407 408 409 410 411 412 413 414 415 416

✕ track 1
Start +00:00:00.00
End -00:09:20.00

Video

00:00:00.00      00:00:15.00      00:00:30.00      00:00:45.00

🔍 🔍
▶
▶
↺
■
◀

**Please note:** Any previous keyframing / sequencing done on the layer will be overwritten and deleted by the default values sent from the desk once the layer is patched.

## Patch settings

To access this patch settings menu, right click on the green patch block, this will open the patch settings.

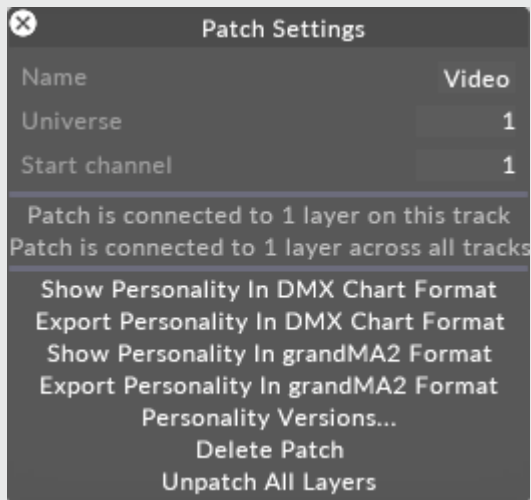

### Name

Here we can give the layer a user friendly name, this might be particularly useful if we have a high number of video layers patched for example, and want to easily distinguish which ones are which.

### Universe

Here we can specify the universe we want to patch our layer to.

## Start channel

Here we can specify the start channel we want to patch our layer to.

## Patch info

Here we are presented with some basic information as to where and how many layers our patch assignment is connected to.

## Show Personality

By left clicking this, we are presented with a window displaying the layers personality. This is a table highlighting which incoming DMX channel is assigned to what function or parameter within the layer, in addition to this we are shown the default values of channels, their ranges, and the title displaying the layer type and its total footprint size.

## Show Personality XML

Left clicking Show personality XML will do two things. The first will present the user with a window showing the video layer personality in XML form. The second action performed will be to create a new folder in the d3 projects folder, this will be named "output". (see the below file directory)

**Computer > Media (E:) > d3 Projects > Project Name > output**

This folder will be populated with an XML file containing the Personality data for the selected layer. This can then be transferred via USB stick onto your XML compatible lighting console.

**Please note:** You will need to follow this process for each layer type patched. A new XML document will be created within this output folder, for each new layer type that the user opens the show personality XML function on.

# Personality Versions

Here we will find an archive of the previous personality versions used in our project. A personality profile may be updated / changed with a new release of Disguise software, this function will allow you to roll back to the personality version that you originally programmed your show with, meaning you will not have to update any of the programming on your console.

## Delete Patch

By left clicking on delete patch we will remove the selected layer from our patch assignment. This will return it to its standard operating mode (controlled through the timeline & keyframable)

## OSC

### Patching a layer to OSC control

1. Right click a layer on the timeline
2. Left click **Patch to OSC**

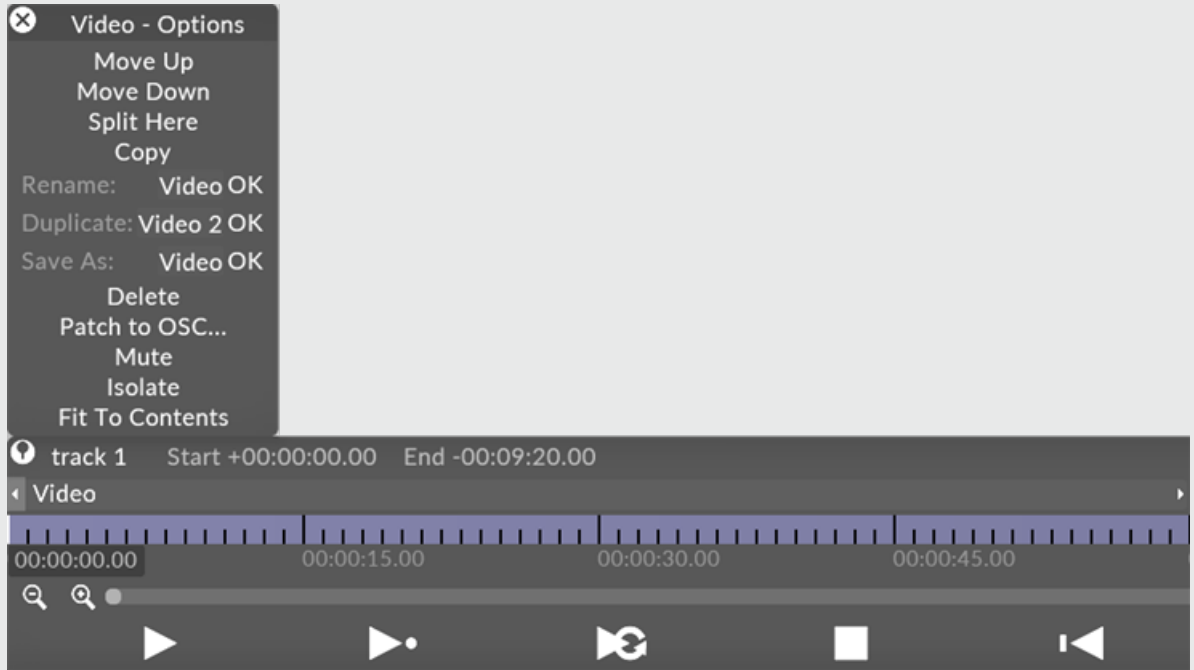

3. Choose OSC device

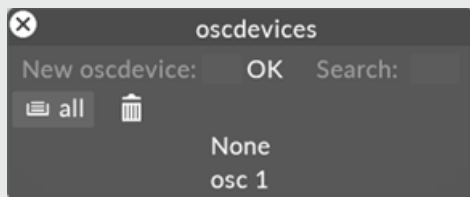

The layer will now turn green, indicating that it is controlled by an external sockpuppet system.

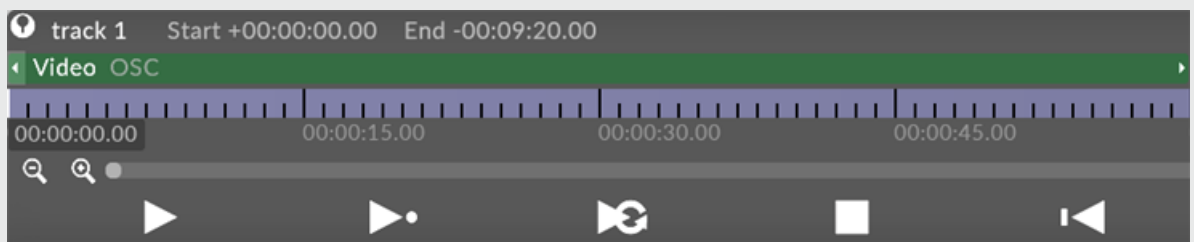

# View the personality

1. To view the personality of the layer for OSC, right click the layer and choose **Edit OSC patch**.

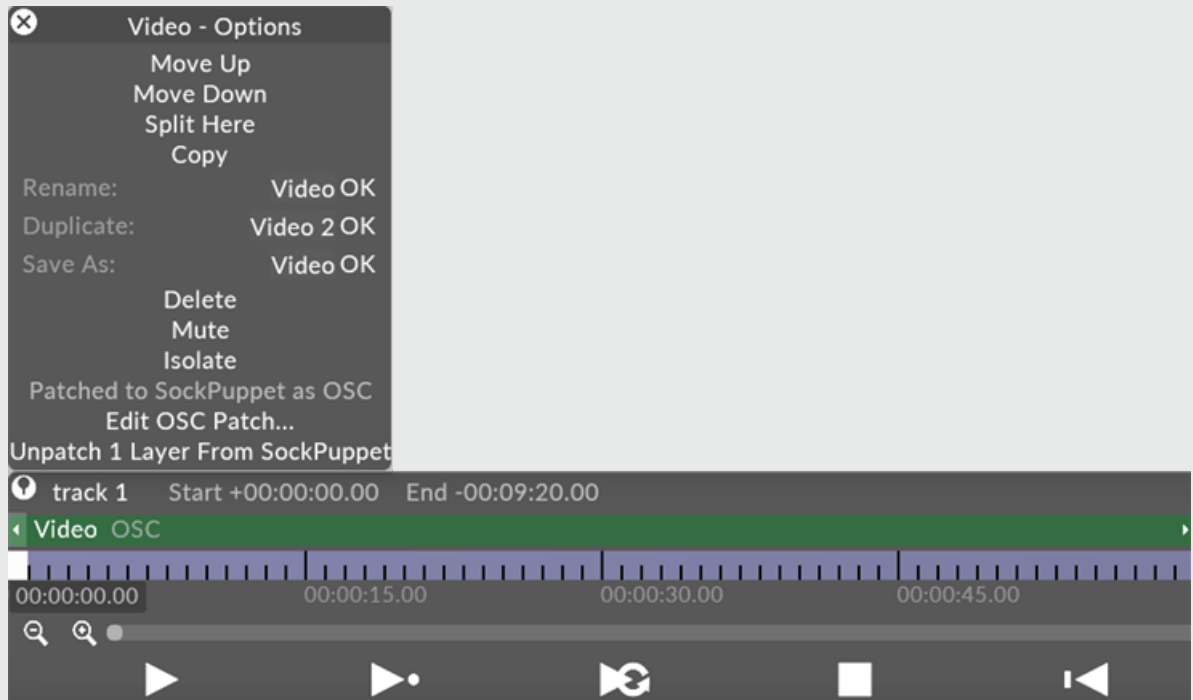

2. Left click **View personality**

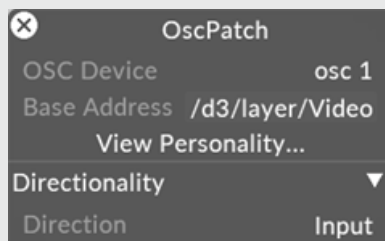

The default OSC personality opens.





## Export the personality

1. Repeat the previous steps to view the OSC patch.
2. Once the patch is open, left click the Export button at the bottom of the window.

# Sockpuppet personality editor

The **Sockpuppet** personality editor is a feature of Disguise software that allows users to edit the default personality of a patched layer.

It's important to note that currently, the functionality is limited to patched layers and you cannot store a custom personality for use with other layers of the same type.

The functionality is useful for setting 16-bit control of some control channels, as well as removing parameters from the personality.

## Accessing & using the personality editor

1. Patch a layer as specified in the [patch assignments topic](#).
2. Right click the patched layer in the patch assignments widget.

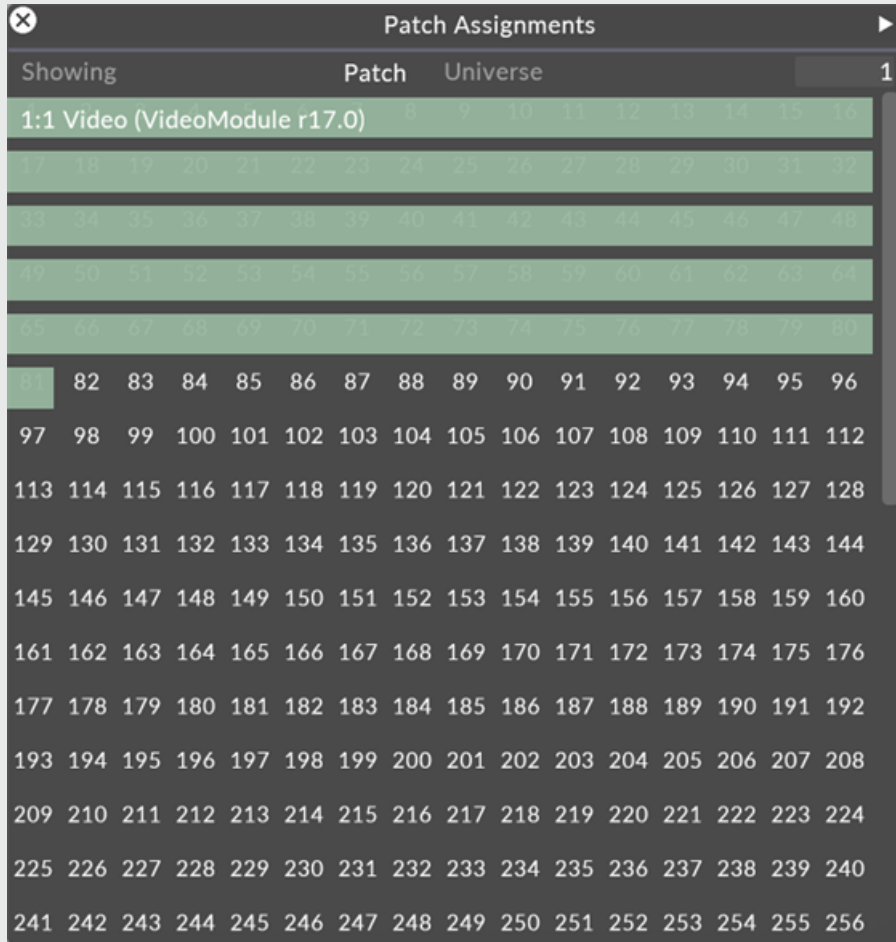

- In the DMX Patch Settings widget, right click the **DmxPersonality** object.

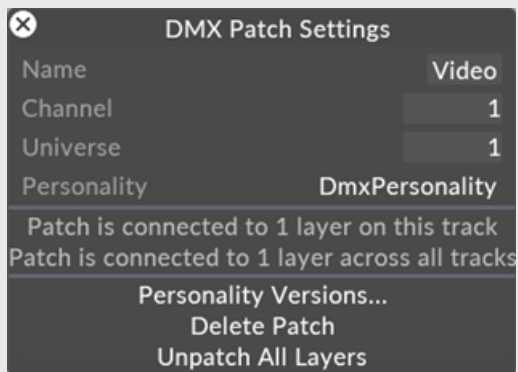

The personality editor will open. You can now edit values in the editor which will be stored to the personality in use for that layer.

**DmxPersonality**

Variant name: r17.0  
Channels: 81

Channel Offset	Type	Field	Display Name	Group Name	Minimum	Maximum	Default Value
0	options	blendMode	blendMode	Default	0	18	1
1	8-bit	brightness	brightness	Default	0	1	1
2	bank/slot	mapping	mapping	Default	0	255	0
4	RGB-colour	RGB colour	RGB colour	Default	0	1	255
7	bank/slot	video	video	Media	0	255	0
9	16-bit	speed	speed	Media	-4	4	1
11	options	mode	mode	Media	0	9	1
12	options	at end point	at end point	Media	0	2	0
13	16-bit	loop inFrame	loop inFrame	Media	0	65535	0
15	16-bit	transition time	transition time	Media	0	10	0
17	8-bit	volume	volume	Audio	0	1	1
18	bank/slot	Output	Output	Audio	0	255	0
20	16-bit	brightness (shift)	brightness (shift)	ColourShift	-1	1	0
22	16-bit	contrast (scale)	contrast (scale)	ColourShift	0	2	1
24	16-bit	saturation scale	saturation scale	ColourShift	0	4	1
26	16-bit	hue shift	hue shift	ColourShift	-360	360	0
28	options	RGB controlled	RGB controlled	ColourShift	0	1	1
29	8-bit	red min	red min	ColourShift	0	1	0
30	8-bit	red max	red max	ColourShift	0	1	1
31	16-bit	red gamma	red gamma	ColourShift	0.1	4	1
33	8-bit	green min	green min	ColourShift	0	1	0
34	8-bit	green max	green max	ColourShift	0	1	1
35	16-bit	green gamma	green gamma	ColourShift	0.1	4	1
37	8-bit	blue min	blue min	ColourShift	0	1	0
38	8-bit	blue max	blue max	ColourShift	0	1	1
39	16-bit	blue gamma	blue gamma	ColourShift	0.1	4	1
41	8-bit	key colour.r	key colour.r	ColourShift	0	1	0
42	8-bit	key colour.g	key colour.g	ColourShift	0	1	0
43	8-bit	key colour.b	key colour.b	ColourShift	0	1	0
44	options	clip_type	clip_type	Move	0	4	4
45	16-bit	size	size	Move	0	4	1
47	16-bit	scale.x	scale.x	Move	0	4	1
49	16-bit	scale.y	scale.y	Move	0	4	1
51	16-bit	pos.x	pos.x	Move	-1	1	0
53	16-bit	pos.y	pos.y	Move	-1	1	0
55	16-bit	rotation	rotation	Move	-180	180	0
57	16-bit	left	left	Crop	0	1	0
59	16-bit	right	right	Crop	0	1	0
61	16-bit	top	top	Crop	0	1	0
63	16-bit	bottom	bottom	Crop	0	1	0
65	options	on clock lost	on clock lost	Timecode	0	2	0
66	8-bit	hours	hours	Timecode	0	255	0
67	8-bit	minutes	minutes	Timecode	0	255	0
68	8-bit	seconds	seconds	Timecode	0	255	0
69	8-bit	frames	frames	Timecode	0	255	0
70	8-bit	threshold	threshold	ColourShift	0	1	0
71	16-bit	hardness	hardness	ColourShift	0	1	1
73	16-bit	cropSoftness	cropSoftness	Crop	0	1	0
75	16-bit	frame index	frame index	Media	0	65535	0
77	16-bit	trim frames	trim frames	Media	0	65535	0
79	16-bit	loop outFrame	loop outFrame	Media	0	65535	0

**Actions**

- Show Personality In DMX Chart Format
- Export Personality In DMX Chart Format
- Show Personality In grandMA2 Format
- Export Personality In grandMA2 Format

Use the actions tab to show or export the personality in either text or grandMA2 format.

4. Editing and creating a custom DMX personality:

#### **Removing channels**

Channels can be removed from a personality as well to create a custom DMX profile. Right-click on the empty space between a column in the DMXPersonality editor and select Remove Properties.

**DmxPersonality**

Variant name: r17.4.12

Channels: 81

Settings

Channel Offset	Type	Field	Display Name	Group Name	Minimum	Maximum	Default Value
18	bank/slot	Output	Output	Audio	0	255	0
20	16-bit	brightness (shift)	brightness (shift)	ColourShift	-1	1	0
22	16-bit	contrast (scale)	contrast (scale)	ColourShift	0	2	1
24	16-bit	saturation scale	saturation scale	ColourShift	0	4	1
26	16-bit	hue shift	hue shift	ColourShift	-360	360	0
28	options	RGB controlled	RGB controlled	ColourShift	0	1	1
29	8-bit	red min	red min	ColourShift	0	1	0
30	8-bit	red max	red max	ColourShift	0	1	1
31	16-bit	red gamma	red gamma	ColourShift	0.1	4	1
33	8-bit	green min	green min	ColourShift	0	1	0
34	8-bit	green max	green max	ColourShift	0	1	1
35	16-bit	green gamma	green gamma	ColourShift	0.1	4	1
37	8-bit	blue min	blue min	ColourShift	0	1	0
38	8-bit	blue max	blue max	ColourShift	0	1	1
39	16-bit	blue gamma	blue gamma	ColourShift	0.1	4	1
41	8-bit	key colour.r	key colour.r	ColourShift	0	1	0
42	8-bit	key colour.g	key colour.g	ColourShift	0	1	0
43	8-bit	key colour.b	key colour.b	ColourShift	0	1	0
44	options	clip_type	clip_type	Move	0	4	4
45	16-bit	size	size	Move	0	4	1
47	16-bit	scale.x	scale.x	Move	0	4	1
49	16-bit	scale.y	scale.y	Move	0	4	1
51	16-bit	pos.x	pos.x	Move	-1	1	0
53	16-bit	pos.y	pos.y	Move	-1	1	0
55	16-bit	rotation	rotation	Move	-180	180	0
57	16-bit	left	left	Crop	0	1	0
59	16-bit	right	right	Crop	0	1	0
61	16-bit	top	top	Crop	0	1	0
63	16-bit	bottom	bottom	Crop	0	1	0
65	options	on clock lost	on clock lost	Timecode	0	2	0
66	8-bit	hours	hours	Timecode	0	255	0
67	8-bit	minutes	minutes	Timecode	0	255	0
68	8-bit	seconds	seconds	Timecode	0	255	0
69	8-bit	frames	frames	Timecode	0	255	0
70	8-bit	threshold	threshold	ColourShift	0	1	0
71	16-bit	hardness	hardness	ColourShift	0	1	1
73	16-bit	cropSoftness	cropSoftness	Crop	0	1	0
75	16-bit	frame index	frame index	Media	0	65535	0
77	16-bit	trim frames	trim frames	Media	0	65535	0
79	16-bit	loop outFrame	loop outFrame	Media	0	65535	0

Options For loop outFrame

- Remove Properties
- Show Personality In DMX Chart Format
- Export Personality In DMX Chart Format
- Show Personality In grandMA2 Format
- Export Personality In grandMA2 Format

### **Creating a custom DMX personality**

The Channel Offset, Display Name, Group Name, and Min/Max/Default Values can also be customized in this editor and exported.



# Sequencing with Sockpuppet

There are a number of changes to the way in which layers are programmed or sequenced when running in sockpuppet mode. The following section will outline these differences.

## Dormant layers

### Overview

Dormant layers is a feature to enable the stacking of large numbers of layers on the timeline. The issue with this previously was that each layer on the timeline required a certain amount of system resources in order to run, which would quickly add up when working with large numbers and result in a significant drop in performance. Now when a layer is set to be dormant it will not require any system resources, and therefore mean we can have large stacks of layers on our timeline and not have to worry about performance issues.

### Setting a layer to be dormant

To make a layer dormant simply set the brightness to 0. This will change the colour of the layer to a dark grey to signify the layer is now dormant. Raise the value above zero to make the layer active.

### RGB colour overview

When running in sockpuppet mode the colour palette system with its X and Y values are ignored and instead replaced by a RGB colour system. This is to reflect the typical way of working with colour on a lighting console.

**Please note:** there is a know issue whereby the RGB colour control system will not be reflected in the layer editor within Disguise software, this will be fixed in a later release.

### Video playback modes overview

When running a layer in sockpuppet mode there are a number of behaviour changes and additions to the video play modes. The functions are listed below:

## Normal

Play forward

## Locked

Play forward: no difference from Normal

## Reset

Reset to the first frame in the clip and hold

## Pause

Pause at the current frame

## Inframe

Go to a specific frame

## Outframe

Set a specific outframe

## Reverse

Play clip backwards

## Timecode

Playback will chase timecode

## LoopInFrame

Set a specific inframe for a video clip loop

## LoopOutFrame

Set a specific outframe for a video clip loop

## Toggle Sockpuppet

The toggle sockpuppet feature allows us to remove the sockpuppet functionality on any parameter within a patched layer.

If for example, we have a Bitmap layer patched and we want to have DMX control over everything apart from the brightness parameter, which we want to keyframe. We can now right click on the parameter we want to toggle, and click "toggle sockpuppet" this will now take my parameter out of the sockpuppet mode.

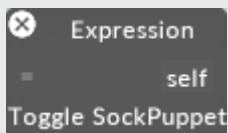

# Indirections

Indirections are keyframes that can be replaced remotely when the user sends a specified command to the system.

## Overview

Indirections are primarily used for switching out pre-programmed content on the fly. They can be used for situations where the user may wish to change objects under certain scenarios such as triggering of an external system or changing playback to match different talent performing on stage.

Indirections are controlled by an Indirection controller, of which there are five types:

## Manual

Holds a single resource that the Indirection uses. They can be manually controlled via the UI or via the new Indirections API.

## List

The list controller type holds a list of objects and has an index for which object they refer to. The list can be controlled manually via the UI or via the Indirections API.

## SequencedIndirectionController

The indirection control module allows indirections to be sequenced on the timeline. Users can sequence indirection changes on the timeline. One Indirection control module controls one indirection. This is controlled by keyframes in an IndirectionControl layer.

## OSC

The OSC controller holds an address, for example - **“/d3/indirection/ name”** and an OSC device. It's controlled by sending a string to Disguise software via OSC in the following format:

**Address:** /d3/indirection/nameOfIndirectionToControl

**Message:** sample/george.jpg

## DMX

The DMX controller holds a channel and a universe. It's controlled by sending a value on that channel/universe that corresponds to a DMX bank & slot.



**Warning:** OSC and DMX indirection controllers can be set to any object that you've specified or put in a bank/slot which means you must take care to select the correct type of object. If you set a keyframe indirection to an object that does not match the keysequence it is sequenced in (i.e. you set your Indirection to reference a mapping when it expects a videoClip) the indirection will instead switch to holding None.

## UDP

The UDP controller holds a string-keyed list of objects. It's controlled by sending a raw UDP message with the specified string to select the associated object.

Indirections can also be accessed via a dedicated API, documentation for which can be found at <http://localhost/docs/v1/index.html> whilst you have Disguise software running.



**Warning:** UDP sockets can only be bound to one port, this means that a UDP ports can only be used by one indirection controller at a time.



**Warning:** OSC, DMX and UDP Indirection controllers do not hold their values through restarts of Disguise software.

## Workflow

- An Indirection acts somewhat like a "dynamic" keyframe
- The dynamic keyframe has a controller attached to it
- The controller gets values sent to it
- Based on those values the resulting output can be changed temporarily

# Examples

## Manual

Manual indirections are extremely useful if you want to make a quick change to a defined resource via the Disguise software user interface. For example, swap out a logo during a corporate event

1. Open a content layer, such as Video
2. Open the keyframe editor for the resource you wish to change, i.e. videoClip
3. Create a new Indirection

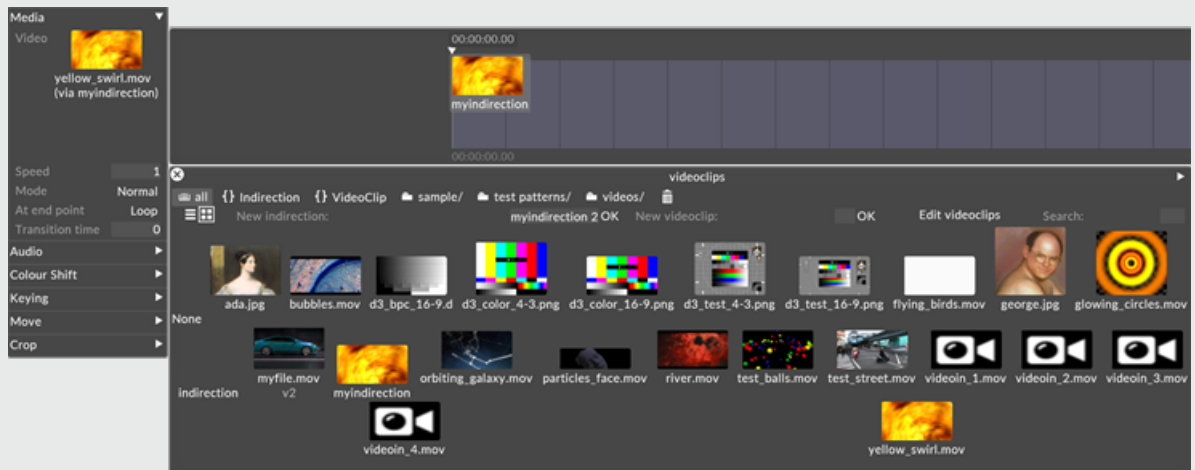

4. Give the Indirection a unique name
5. In the Indirection create a controller
6. Choose the manual controller type

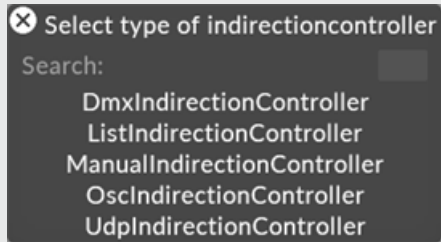

7. In the manual controller, choose a resource to assign to the controller
8. Once this is done, the resource can be changed and the layer is updated.

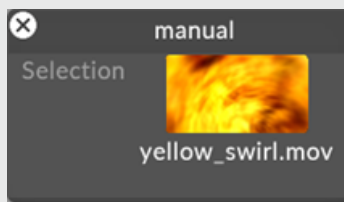

## List

List is a useful controller for when you have a small selection of resources you wish to change out or swap between. For example toggling between two pieces of media for when a different performer is covering for someone during a show.

1. Open a content layer, such as Video
2. Open the keyframe editor for the resource you wish to change, i.e. videoClip
3. Create a new Indirection

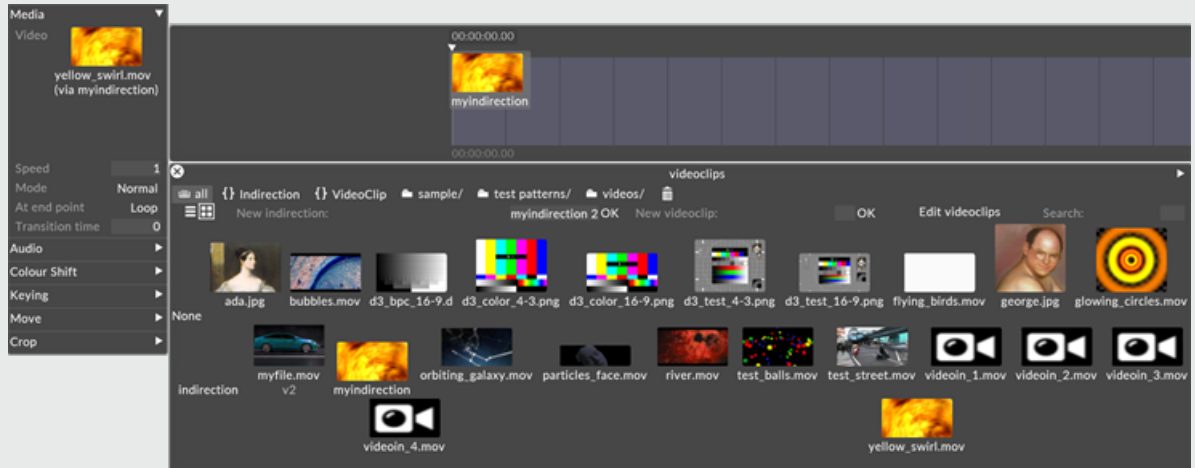

4. Give the Indirection a unique name
5. In the Indirection create a controller
6. Choose the list controller type

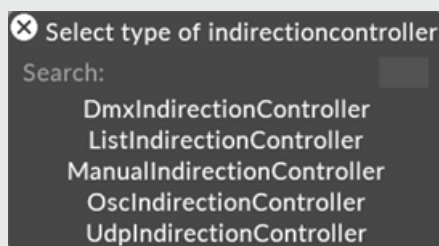

7. In the list controller, choose resources to assign to the controller
  - a. Resources can be re-ordered like other lists in Disguise software. Drag the items up and down to re-order.
  - b. The index value cycles through resources, so the ordering of the list is important.



- c. The Index value can have an expression which can be linked to an external device, for example a midi controller.
8. Once this is done, the resource can be changed and the layer is updated.

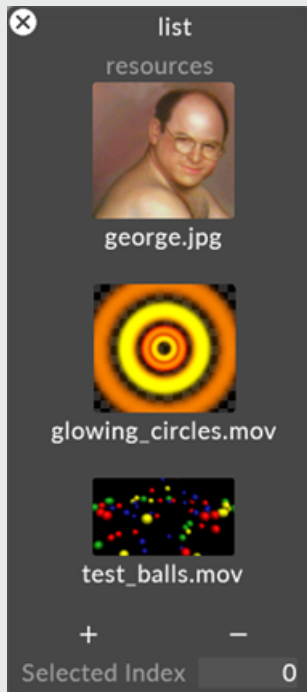

## OSC

The OSC indirection is useful if you want to create a more complex front end interface on a device such as an iPad, or apply logic to your Indirections.

1. Open a content layer, such as Video
2. Open the keyframe editor for the resource you wish to change, i.e. videoClip
3. Create a new Indirection

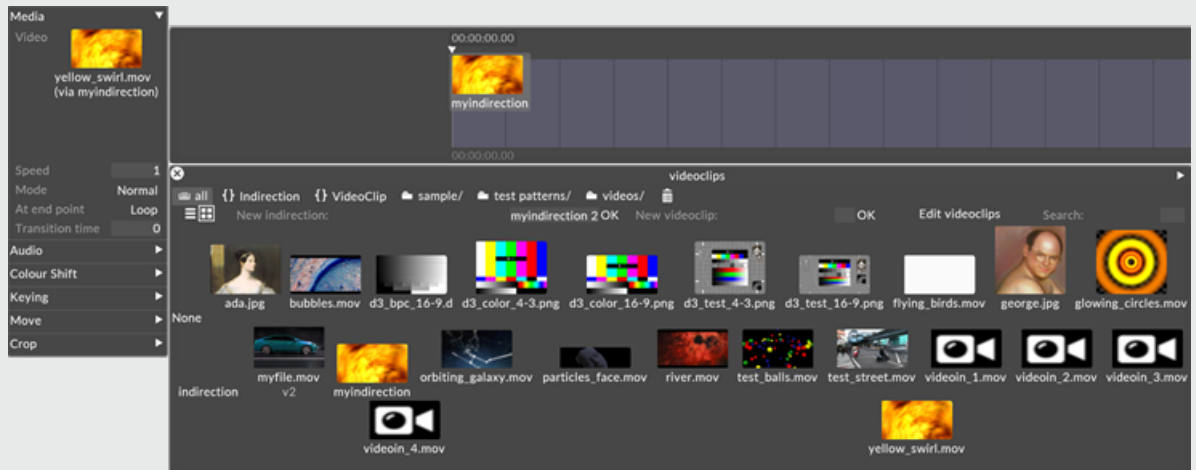

4. Give the Indirection a unique name
5. In the Indirection create a controller
6. Choose the OSC controller type

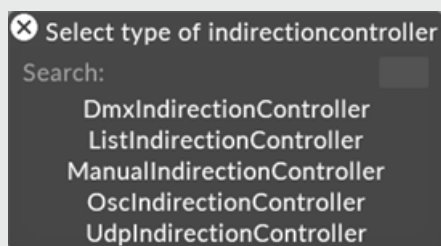

7. In the OSC controller, choose values to assign to the controller
  - a. Set the OSC device that the controller is receiving data from.
  - b. Set the OSC address that the controller is listening to.
8. Once this is done, the resource can be changed and the layer is updated.

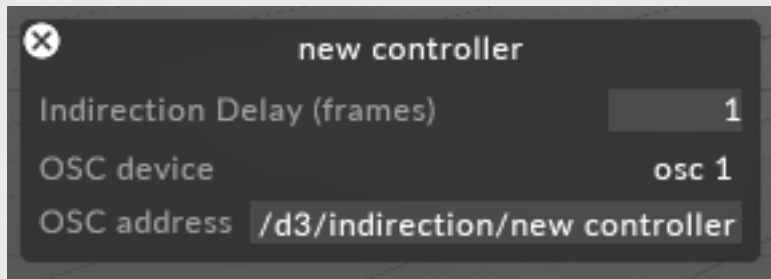

## DMX

DMX is useful for being able to change Indirections via a lighting desk, much in the same way sockpuppet works, but without needing to set up a full sockpuppet programming workflow.

1. Open a content layer, such as Video
2. Open the keyframe editor for the resource you wish to change, i.e. videoClip
3. Create a new Indirection

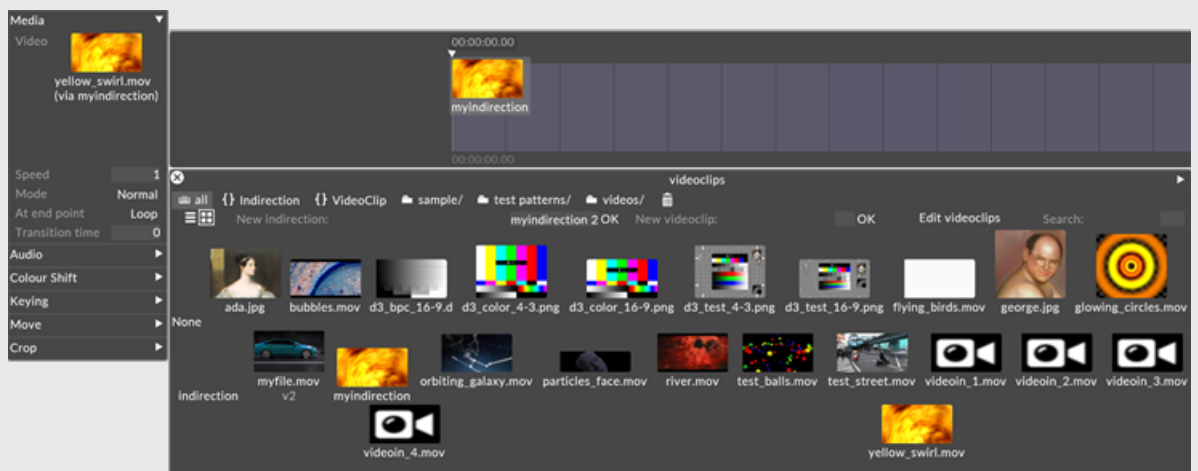

4. Give the Indirection a unique name
5. In the Indirection create a controller

6. Choose the DMX controller type

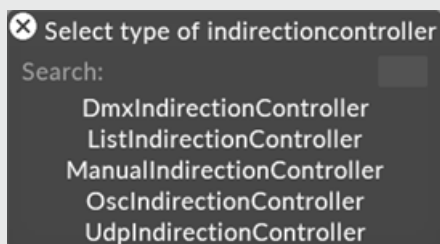

7. In the DMX controller, choose values to assign to the controller
  - a. Set the universe & address
  - b. Ensure the resources you wish to control are exposed in the bank assignments, much like sockpuppet.
8. Once this is done, the resource can be changed and the layer is updated.



## UDP

The UDP Indirection is useful for more complex use cases where an external system is running logic to decide which Indirections are being used.

1. Open a content layer, such as Video
2. Open the keyframe editor for the resource you wish to change, i.e. videoClip
3. Create a new Indirection

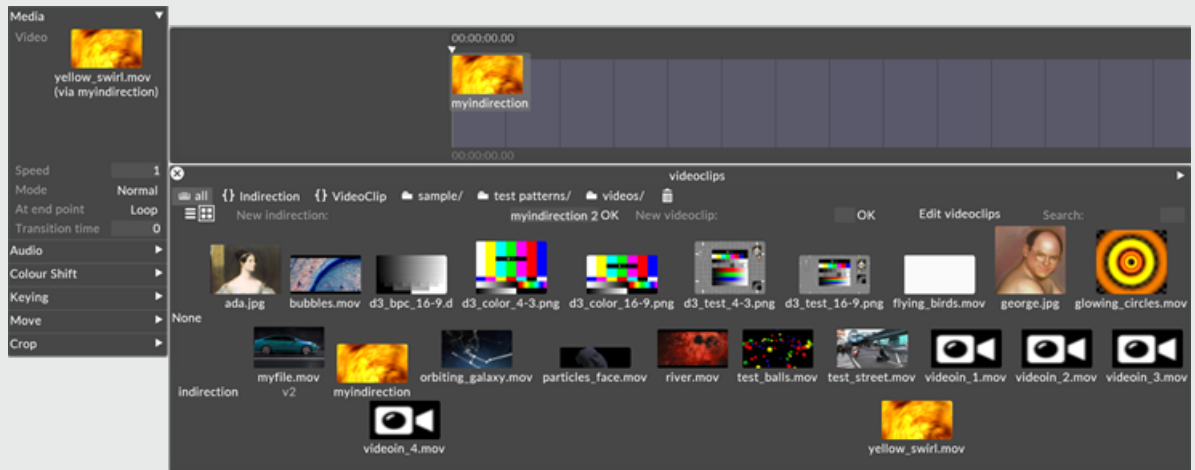

4. Give the Indirection a unique name
5. In the Indirection create a controller
6. Choose the UDP controller type

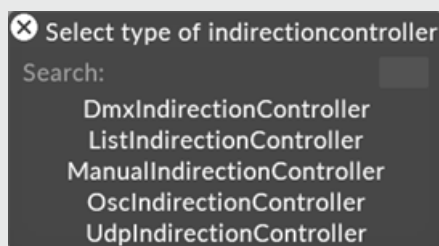

7. In the UDP controller, choose resources to assign to the controller
  - a. Set the key(s) for your resource(s)
8. Once this is done, the resource can be changed and the layer is updated.

ⓧ udp

resources

key	VI1	resource	 videoin_1.mov
key	VI2	resource	 videoin_2.mov
key	VI3	resource	 videoin_3.mov
key	VI4	resource	 videoin_4.mov

+                  -

Verbose

Filter IP

Receive port

# Universal crossfade overview

## What is Universal crossfade?

Universal crossfade allows you to smoothly dissolve / fade between any two points in a show.

Up to r11.3, the only way to transition from one point in a track to another, or to another track, was a hard cut. In r12 onwards, you can jump from any point in a track to any other point, or to another track, with a smooth dissolve.

## Crossfade duration

Controlling the duration of the dissolve can be done in three ways:

- Globally across the entire project: open the state manager by right clicking the d3 icon on the top left of the gui, navigate to **Project Settings** and see option **Global Crossfade Duration**.
- Per-track: right-click on the track title bar, select **Special settings**, switch **Default Crossfade** to **Fade** or **TrackSection**, and select the transition time you want to use.
- Per section: right-click on the first bar of the section, under the Crossfade tab, select either Fade or TrackSection and configure the parameters accordingly.

## Fade transitions

Fade transitions is the mode universal crossfade has always used.

These can be set at either a global level, track level or section level. Each overriding the last in order of precedence.

To access the fade settings:

1. Right click a section

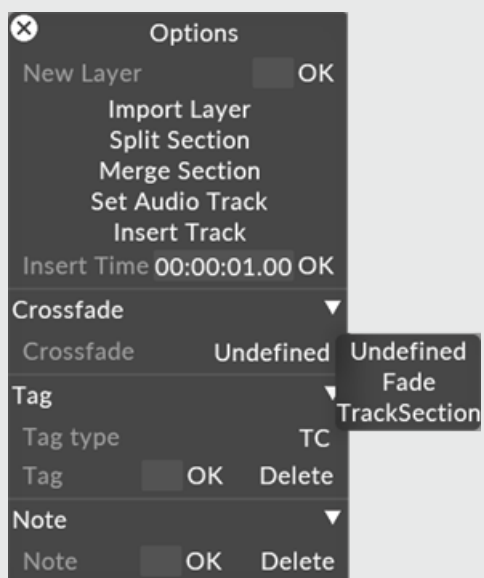

2. Set the crossfade from Undefined to **Fade**.
3. Set the duration to be whatever time you wish the fade to occur over.



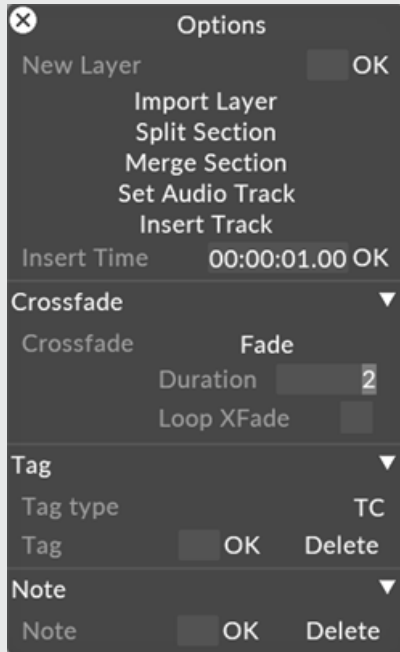

4. The first second of each section shows a triangular indentation to indicate that jumping into the section will initiate a dissolve of that duration. The duration is always controlled by the destination section.

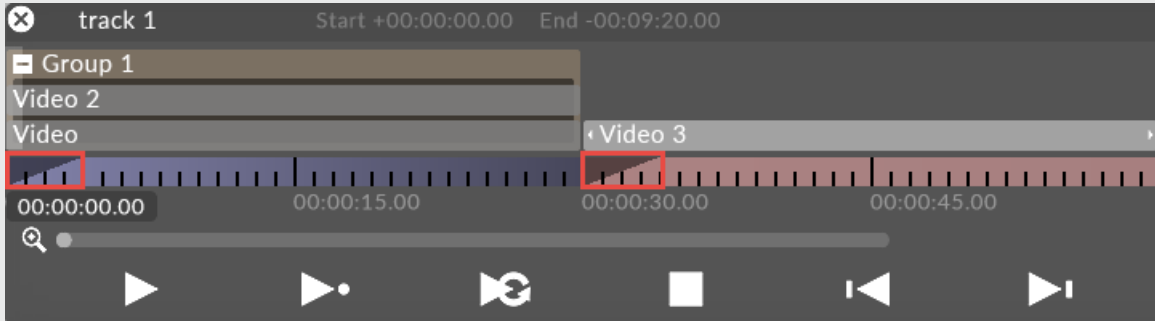

The fade is started under two circumstances :

- Jumping to another point on the timeline
- Holding at the end of a section and going forward into the next section

**Please note:** that playing across a section boundary will **not** start the dissolve. Only an action that **forces** the playhead to another location on the timeline will trigger the crossfade.

## Crossfade loop

When in loop section playmode, the playhead can crossfade to the beginning of the current section  $x$  seconds before the end of the section. Where  $x$  is the duration of the fade or the length of the specified track section used to render the transition. This helps create a more seamless fade back to the start of a section rather than a hard cut.

1. Right click on a section and set the transition to fade.
2. Check Loop XFade box.
3. The section will now fade back to the beginning using the duration set.

## Sequenced transitions

As of r17.1, you can sequence a transition instead of using universal crossfade which only allows a straight dissolve. Note that sequenced transitions can only be used at the section level currently.

- Individual RGBA components are actually transitioned independently.
- During a transition, all layer types are expected to work except those which deal with transport commands or status. Examples include:
  - » `TransportVolumeLocal`
  - » `TransportBrightnessLocal`
  - » `TransportControl`

» TrackJump

» Readout

- Audio is played back during transitions. This is to allow an audio component to the transition.
- Prefetch is not performed - any 'heavy' video files will likely fail on the first frame. A workaround would be to offset the transition video forward by a frame or two.

## Setting up a sequenced transition

1. Create a track called “transitions”.
2. Create sections within the track that define your transition lengths.
3. Within your section, sequence a video file or texture starting black, and ending white. Playmode should be set to “pause at end”.
4. Give the section a name by using a note.
5. On your main show track, right click a section to define a section based crossfade. This can also be set via Telnet when using the Multi-transport API.
6. Choose “Track Section” in place of the crossfade override.
7. Choose the transition section to use.



# Universal crossfade overview

## What is Universal crossfade?

Universal crossfade allows you to smoothly dissolve / fade between any two points in a show.

Up to r11.3, the only way to transition from one point in a track to another, or to another track, was a hard cut. In r12 onwards, you can jump from any point in a track to any other point, or to another track, with a smooth dissolve.

## Crossfade duration

Controlling the duration of the dissolve can be done in three ways:

- Globally across the entire project: open the state manager by right clicking the d3 icon on the top left of the gui, navigate to **Project Settings** and see option **Global Crossfade Duration**.
- Per-track: right-click on the track title bar, select **Special settings**, switch **Default Crossfade** to **Fade** or **TrackSection**, and select the transition time you want to use.
- Per section: right-click on the first bar of the section, under the Crossfade tab, select either **Fade** or **TrackSection** and configure the parameters accordingly.

## Fade transitions

Fade transitions is the mode universal crossfade has always used.

These can be set at either a global level, track level or section level. Each overriding the last in order of precedence.

To access the fade settings:

1. Right click a section

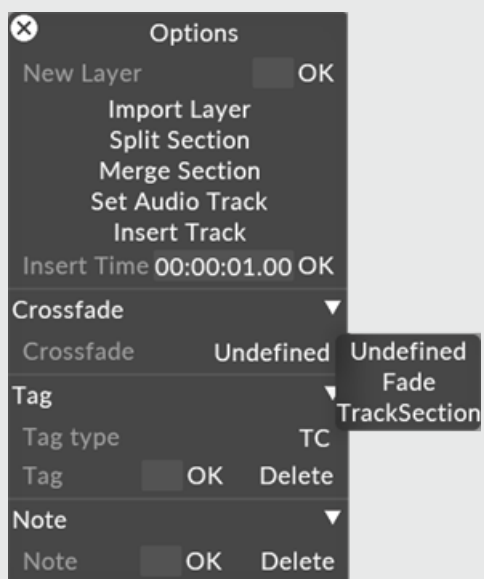

2. Set the crossfade from Undefined to **Fade**.
3. Set the duration to be whatever time you wish the fade to occur over.

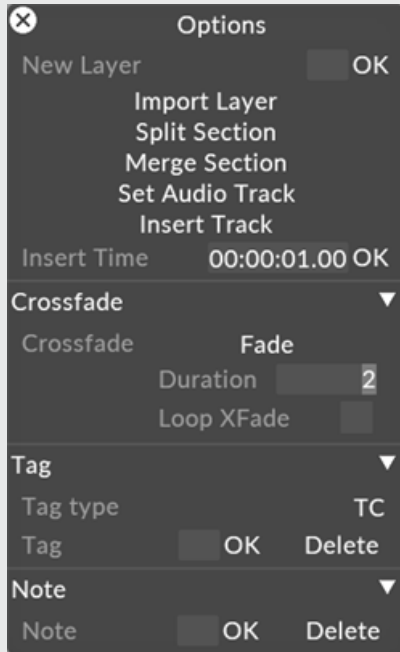

4. The first second of each section shows a triangular indentation to indicate that jumping into the section will initiate a dissolve of that duration. The duration is always controlled by the destination section.

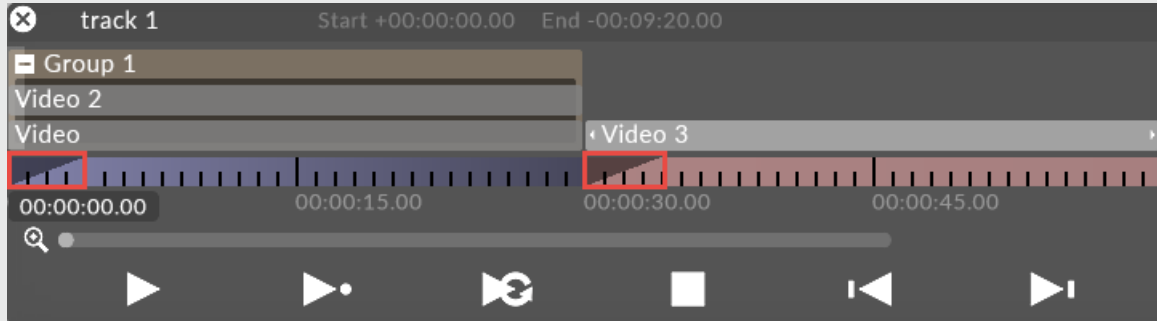

The fade is started under two circumstances :

- Jumping to another point on the timeline
- Holding at the end of a section and going forward into the next section

**Please note:** that playing across a section boundary will **not** start the dissolve. Only an action that **forces** the playhead to another location on the timeline will trigger the crossfade.

## Crossfade loop

When in loop section playmode, the playhead can crossfade to the beginning of the current section  $x$  seconds before the end of the section. Where  $x$  is the duration of the fade or the length of the specified track section used to render the transition. This helps create a more seamless fade back to the start of a section rather than a hard cut.

1. Right click on a section and set the transition to fade.
2. Check Loop XFade box.
3. The section will now fade back to the beginning using the duration set.

## Sequenced transitions

As of r17.1, you can sequence a transition instead of using universal crossfade which only allows a straight dissolve. Note that sequenced transitions can only be used at the section level currently.

- Individual RGBA components are actually transitioned independently.
- During a transition, all layer types are expected to work except those which deal with transport commands or status. Examples include:
  - » `TransportVolumeLocal`
  - » `TransportBrightnessLocal`
  - » `TransportControl`

» TrackJump

» Readout

- Audio is played back during transitions. This is to allow an audio component to the transition.
- Prefetch is not performed - any 'heavy' video files will likely fail on the first frame. A workaround would be to offset the transition video forward by a frame or two.

## Setting up a sequenced transition

1. Create a track called “transitions”.
2. Create sections within the track that define your transition lengths.
3. Within your section, sequence a video file or texture starting black, and ending white. Playmode should be set to “pause at end”.
4. Give the section a name by using a note.
5. On your main show track, right click a section to define a section based crossfade. This can also be set via Telnet when using the Multi-transport API.
6. Choose “Track Section” in place of the crossfade override.
7. Choose the transition section to use.





# Generating textures

## Texture types

### Composite Texture

Combines multiple textures into one. To blend the textures together, you can select different blend modes.

### Gradient Texture

Gradient texture allows for generative gamma and gradient length options.

### Soft Edge texture

Create as many points as you want and configure what gamma level and level of gradient you need to achieve the perfect blend between your projector outputs.

### Solid texture

Texture that only allows one solid color.

### Lookup texture

This texture allows you to edit the brightness curve of a softedge texture.

### PreComp Texture

This texture acts as a virtual screen that content can be written to. See the [PreComp](#) topic for more information.

# Creating textures

To create a texture:

1. Open a Bitmap layer, a Spinbitmap layer or any other texture based layer.
2. Left-click **palette** from the layer editor.
3. Left-click **new texture** to highlight the text field.
4. Type in the name of your texture, for example **theatre surface** .
5. Hit **Enter**. This will open a menu of five different types of textures.

# Exporting textures

To Export a texture:

1. Open your texture from the **DxTexture** editor by right clicking on it.
2. Left-click the **Actions** tab at the bottom of the editor.
3. Alter the name if needed, and then hit **Enter** or left click OK. The texture will be written to the output folder of the Project folder.

# Configuring Overview

This topic explains how to configure all the different devices that send data to Disguise or receive data from Disguise.

# Configuring Overview

This topic explains how to configure all the different devices that send data to Disguise or receive data from Disguise.

# API

r21 introduced the ability to perform a number of controls from an application programming interface, otherwise known as the API

## Overview

This topic introduces the concepts of APIs and UIDs within Disguise software.

## What is an API?

An API is defined as an application programming interface. Within Disguise software, it is accessible via d3Manager and allows direct access to specific software functionality within the software.

Designer's API documentation can be found by opening SwaggerDocs directly from d3Manager. This can be launched on the localhost of a local machine, or via a remote machine.

The APIs shown in [SwaggerDocs](#) are expressions of call commands that can be made from an external, virtual or actual physical interface to d3 projects to trigger a change or event. To make the call command, users need to provide references to specific existing d3 projects, and to items within those. This is done by referencing UIDs.

## Opening API Documentation

Disguise software uses an OpenAPI format for d3 API.

**d3 API** <sup>1.5.0</sup>  
 [ Base URL: /api/v1 ]  
 d3api.swagger.json

**CameraCalibration** ∨

- POST** /cameracalibration/addobservation Add Observation
- POST** /cameracalibration/enableobservation Enable Observation
- GET** /cameracalibration/mrsets List MR sets
- GET** /cameracalibration/mrsets/{mrsetuid} Get single MR set
- GET** /cameracalibration/observationprogress Get Observation progress state
- POST** /cameracalibration/resetallobservations Reset Observations

**Indirections** ∨

- GET** /indirections List all indirections
- PUT** /indirections Update one or more indirections
- POST** /indirections/set Update one or more indirections
- GET** /indirections/{uid} Get single indirection

To access the API, open d3Manager, and from the Help menu, select Open API Documentation.

## What is a UID?

A unique identifier (UID) is a numeric or alphanumeric string that is associated with a single entity within a given system. Every item in Disguise software has a numeric UID assigned to it.

**Please note:** For additional information on APIs, please visit <https://developer.disguise.one>

# API

r21 introduced the ability to perform a number of controls from an application programming interface, otherwise known as the API

## Overview

This topic introduces the concepts of APIs and UIs within Disguise software.

## What is an API?

An API is defined as an application programming interface. Within Disguise software, it is accessible via d3Manager and allows direct access to specific software functionality within the software.

Designer's API documentation can be found by opening SwaggerDocs directly from d3Manager. This can be launched on the localhost of a local machine, or via a remote machine.

The APIs shown in SwaggerDocs are expressions of call commands that can be made from an external, virtual or actual physical interface to d3 projects to trigger a change or event. To make the call command, users need to provide references to specific existing d3 projects, and to items within those. This is done by referencing UIs.

## Opening API Documentation

Disguise software uses an OpenAPI format for d3 API.

**d3 API** <sup>1.5.0</sup>  
 [ Base URL: /api/v1 ]  
 d3api.swagger.json

### CameraCalibration

- POST** /cameracalibration/addobservation Add Observation
- POST** /cameracalibration/enableobservation Enable Observation
- GET** /cameracalibration/mrsets List MR sets
- GET** /cameracalibration/mrsets/{mrsetuid} Get single MR set
- GET** /cameracalibration/observationprogress Get Observation progress state
- POST** /cameracalibration/resetallobservations Reset Observations

### Indirections

- GET** /indirections List all indirections
- PUT** /indirections Update one or more indirections
- POST** /indirections/set Update one or more indirections
- GET** /indirections/{uid} Get single indirection

To access the API, open d3Manager, and from the Help menu, select Open API Documentation.

## What is a UID?

A unique identifier (UID) is a numeric or alphanumeric string that is associated with a single entity within a given system. Every item in Disguise software has a numeric UID assigned to it.

**Please note:** For additional information on APIs, please visit <https://developer.disguise.one>



# Audio overview

Disguise works with audio in two distinct ways: audio can be inserted directly onto the Track or added to a layer on the timeline.

To achieve PA audio quality (including per machine patching) it is recommended to embed uncompressed audio within a video file or to use the [Audio Layer](#)

Track audio (.mp3, .wav, or .aiff) can be [quantised](#) and used as a guide audio track, allowing a show to be sequenced to the beat.

For file format information, see [supported file formats](#).

## Quantising a track and sequencing to the beat

An audio file can be attached directly to the Track. It is then possible to **quantise** the audio track. Quantising involves editing a beatgrid to snap Track events to the beat, enabling content to be sequenced to the beat.

For step-by-step instructions on how to quantise an audio track please see the below sub-chapter [Quantising an audio track](#).

**Please note:** at present only music with a 4/4 time signature is supported. These deficiencies will be addressed to in a future release.

## Outputting high quality audio

The 4U, Pro Range and Gx Range hardware can output balanced stereo from its professional RME audio card.

For more information please see the sub-chapter [Outputting audio](#).

## AudioAnalyser

The **AudioAnalyser** displays the audio waveform. For more information on using the AudioAnalyser, visit [this page](#).

# Quantising audio

Please note: Before proceeding with the steps listed below for quantising audio, please see the sub-chapter [Setup Quantising](#)

Please note: a handy tip when you are quantising an audio track is to use the keyboard shortcuts [ and ] to navigate the quantiser window left and right. To learn more useful shortcuts please see the sub-chapter [Keyboard Shortcuts](#).

## Quantising an audio track

Quantising means dragging beatmarkers over the audio track to tell Disguise software where the beats are. To quantise an audio track you need to open the quantiser window.

To open the quantiser window for the current audio track:

1. Hit **Alt-Q**. Hitting **Alt-Q** again closes the quantiser window once it is open.

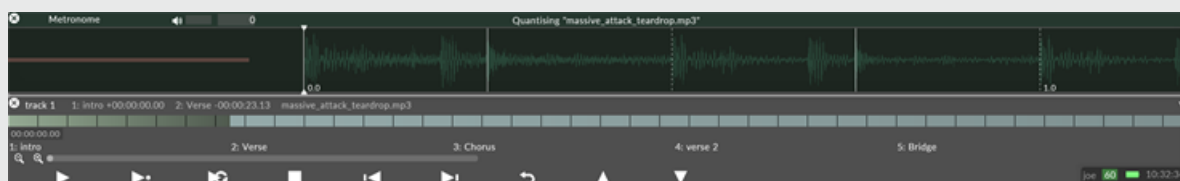

2. Play the track until you find the first beat and drag the closest marker to it.

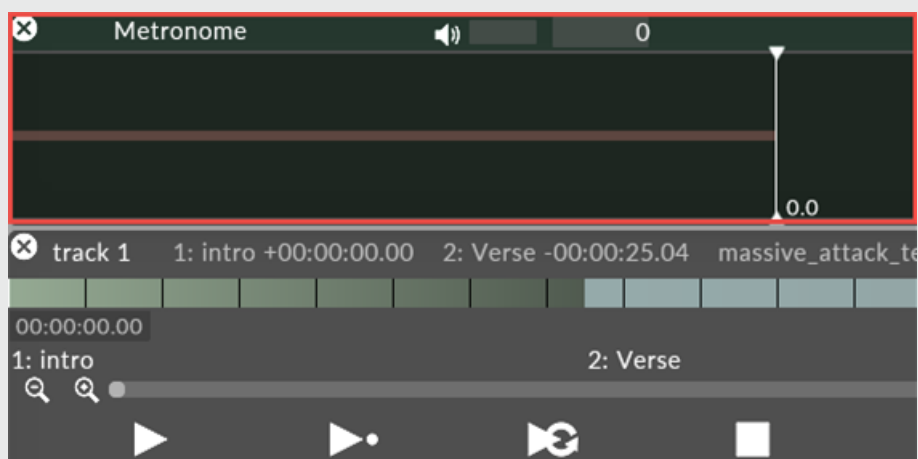

3. Then drag the next marker to the following beat.

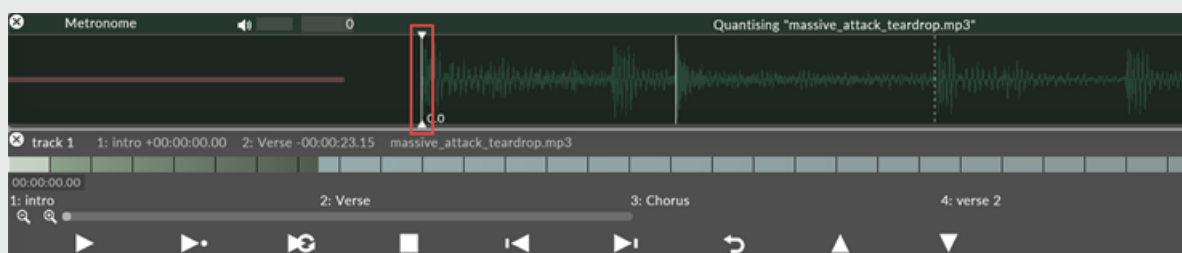

4. Now play forward; you will see a series of dotted markers that gradually drift offtime. The dotted markers are autogenerated by Disguise software.
5. At any point, you can grab a dotted marker and drag it to bring it in line with the nearest beat. At this point it becomes a solid line. Dotted markers between your manually positioned markers move to space themselves equally.
6. At any time, you can zoom in or out using the mouse scroll wheel. This allows you to see more detail and thus position the markers more accurately.

- The **metronome** button plays each marker as an audible beat to check how well the beatgrid lines up. The Metronome button has a Volume control next to it. Left-click the white volume bar or text field to modify the Metronome volume. You can fill in any number between 0 (mute) and 255 (full) in the text field. These are the minimum and maximum values.

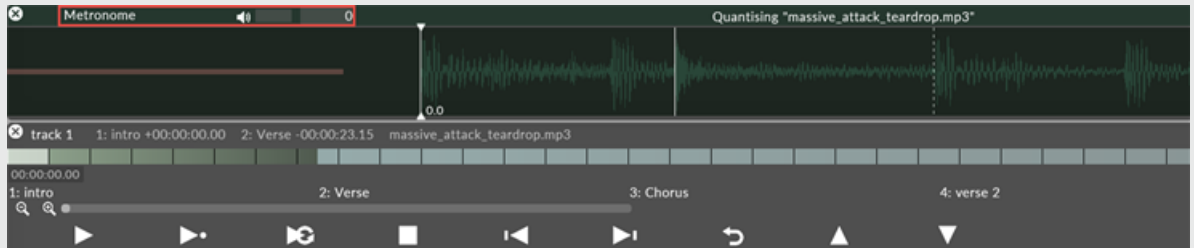

- Hit **Alt Q** to close the quantiser when you have finished quantising your track.

**Please note:** that the metronome will only output on the Director machine in a Director/ Actor/ Understudy environment due to the quantiser only being drawn on the Director.

## Quantiser properties

The quantiser contains further editing options.

To open the Quantiser menu:

1. Right-click the quantiser windows title bar.

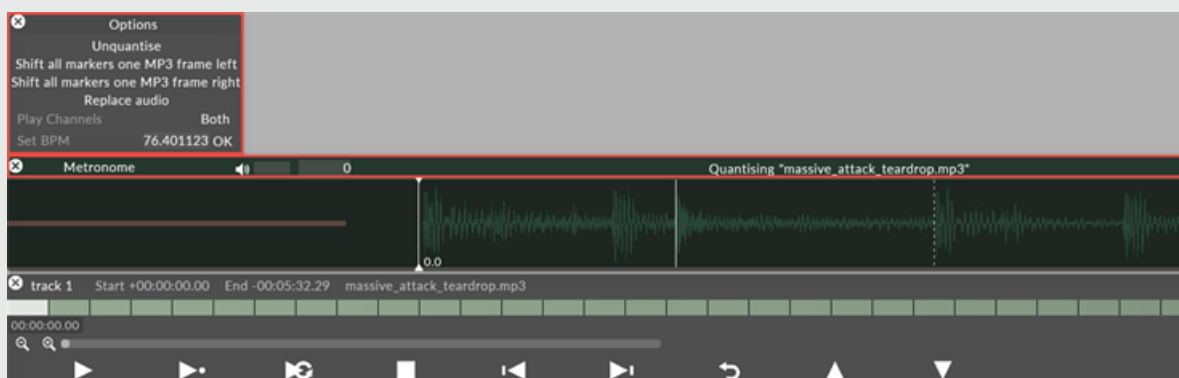

The editing options are:

**Unquantise** : This option will delete any markers previously positioned over the track and close the quantiser window.

**Shift all markers one frame left** : This option will take all of your positioned markers and move them one frame to the left. This is useful if your markers are positioned too late in relation to the beats in the track but you want to move all of the markers uniformly.

**Shift all markers one frame right** : This option will take all of your positioned markers and move them one frame to the right. This is useful if your markers are positioned too early in relation to the beats in the track but you want to move all of the markers uniformly.

**Replace audio** : This option will replace the current audio file in the track with another audio file. This is useful if, for example, you are rehearsing a music show and the rehearsal crew want to test different versions of the same song.

## To replace audio:

1. Left-click **replace audio** from the Quantiser editor. This will open the AudioFiles manager which displays a list of all of the audio files saved on your local hard-drive in the **AudioFile** folder.

See the [Placing media files for a project](#) sub-chapter to understand where to copy an audio file. Also save the file to a [supported file format](#).

2. Left-click the audio file you want to replace the current audio file. The name of the audio track will be updated on the Track Player and quantiser windows title bars.

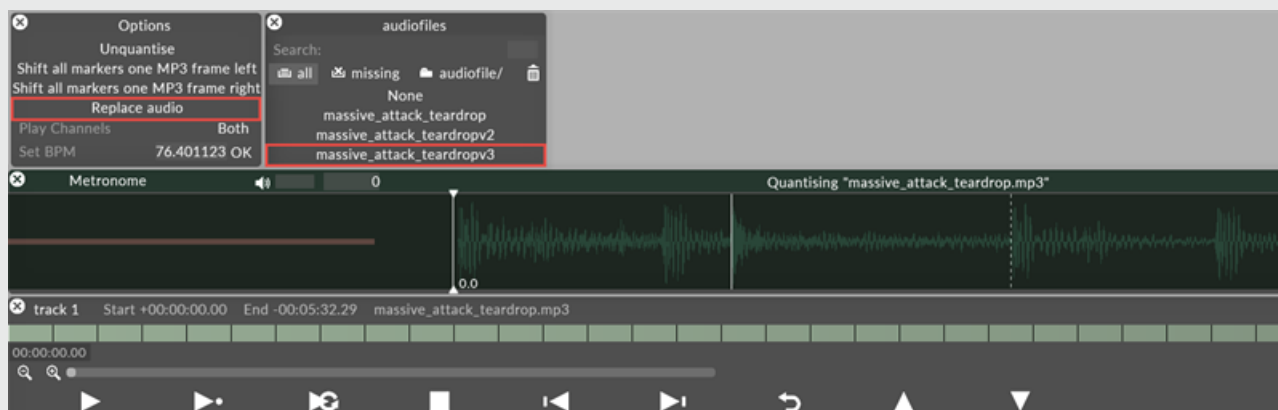

**Set bpm:** This option will reset the current tracks beats per minute to whatever value the user sets.

# Setup quantising

## Copying an audio file to the correct folder

To set up for quantising your audio, the audio files need to be copied into the **AudioFile** folder in the specific Project folder. See the [Placing media files for a project](#) sub-chapter to understand where to copy an audio file. Also save the file to a [supported file format](#).

## Adding an audio file to a track

A track containing non audio regions will display its bars in red and/or blue.

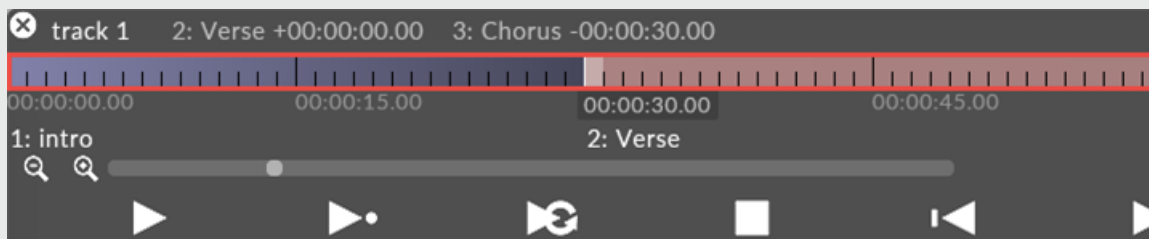

Non-audio regions for a track are displayed in red and/or blue

To add an audio file to the track:

1. Rightclick the first bar of the track and select **set audio track** from the popup menu. You will then get an AudioTracks manager.

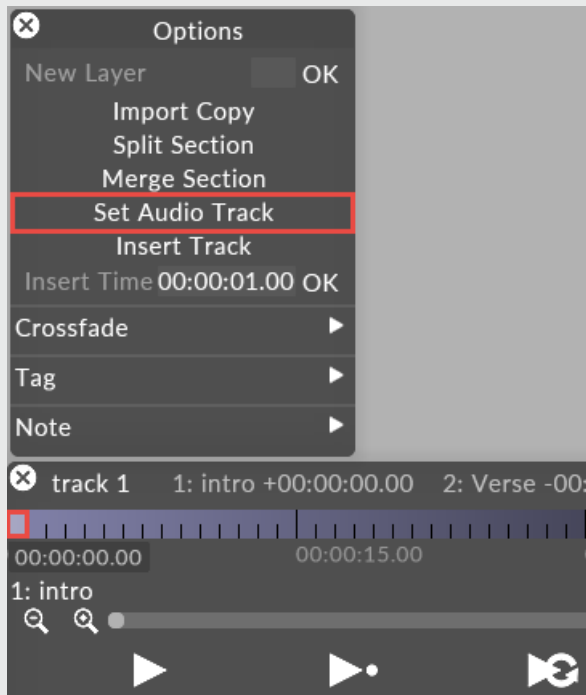

2. Left-click the audio file you want and the display will change: the audio file becomes the guide audio for the track. To indicate this, the bars will colour green and the name of the audio track will be displayed on the title bar :

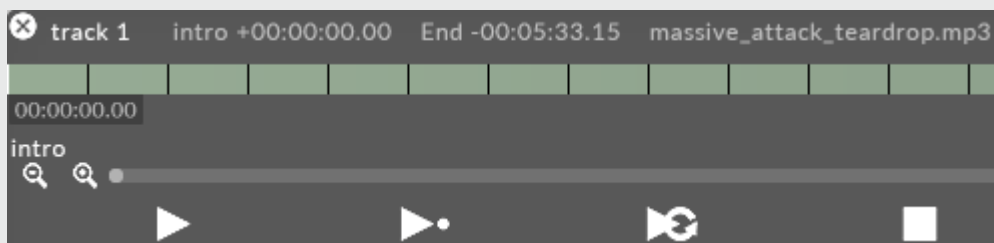
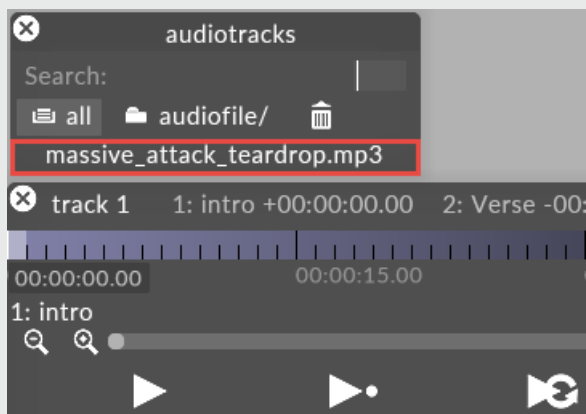



# Advanced quantiser settings

## Inserting bars of silence

At any point, you can insert extra bars into your Track (for example if the audio file changes, but you don't have access to a new version).

To insert bars of silence:

1. Right-click the bar at the point where you want to insert time. This will open the Track bars menu.
2. Type the number of bars you want to add in the **Insert Bars** text field and hit **Enter**Disguise will insert the appropriate number of silent bars for you. In this example we have inserted five bars of silence.

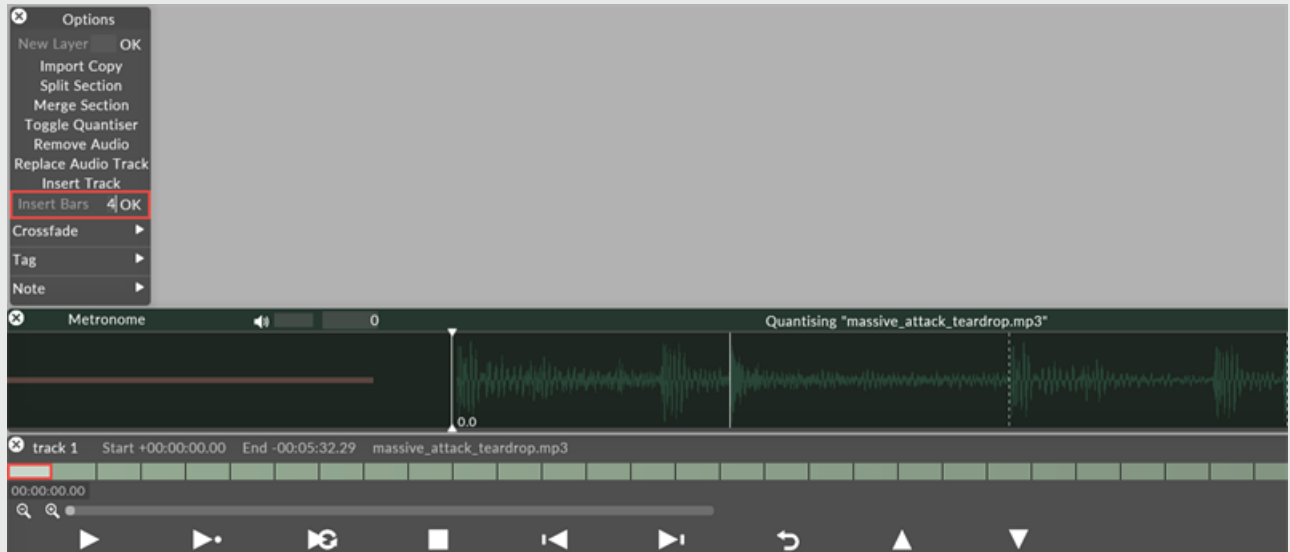

*Insert Bars option from the Track bar menu (left), used to insert silent bars (right), opened by right-clicking a Track bar*

## Adding more than one audio file to a track

For some applications (for example rock shows), it makes sense to have one audio file per track. For other shows (such as theatre) it makes more sense to have multiple audio files on the same track, separated by silences. This allows smooth transitions from one musical section to another.

To add an audio track:

1. Extend the length of the track. For information on how to extend the length of the track, see the [Editing tracks](#) sub-chapter.
2. Right-click an audio free section (shown as red or blue bars) to open the Track bars menu.
3. Left-click **Insert Audio Track**. This will open the Audio Tracks Manager.
4. Left-click the Audio Tracks Manager to add the audio file to the point of the currently selected Track bar.

5. Move the cursor in that region and hit **ALT Q** to open the quantiser window.

**Please note:** It is recommended that you quantise the audio file before you start animating content layers in the region. The software will re-time content events, but may not do so perfectly accurately.

## Duplicating Track bars

You can also select any number of bars and duplicate them:

1. Select a Timeline region by holding down the **left Shift key** and then dragging the cursor across the bars at the bottom of the window.
2. Right-click the grey region and select **Duplicate Bars**:

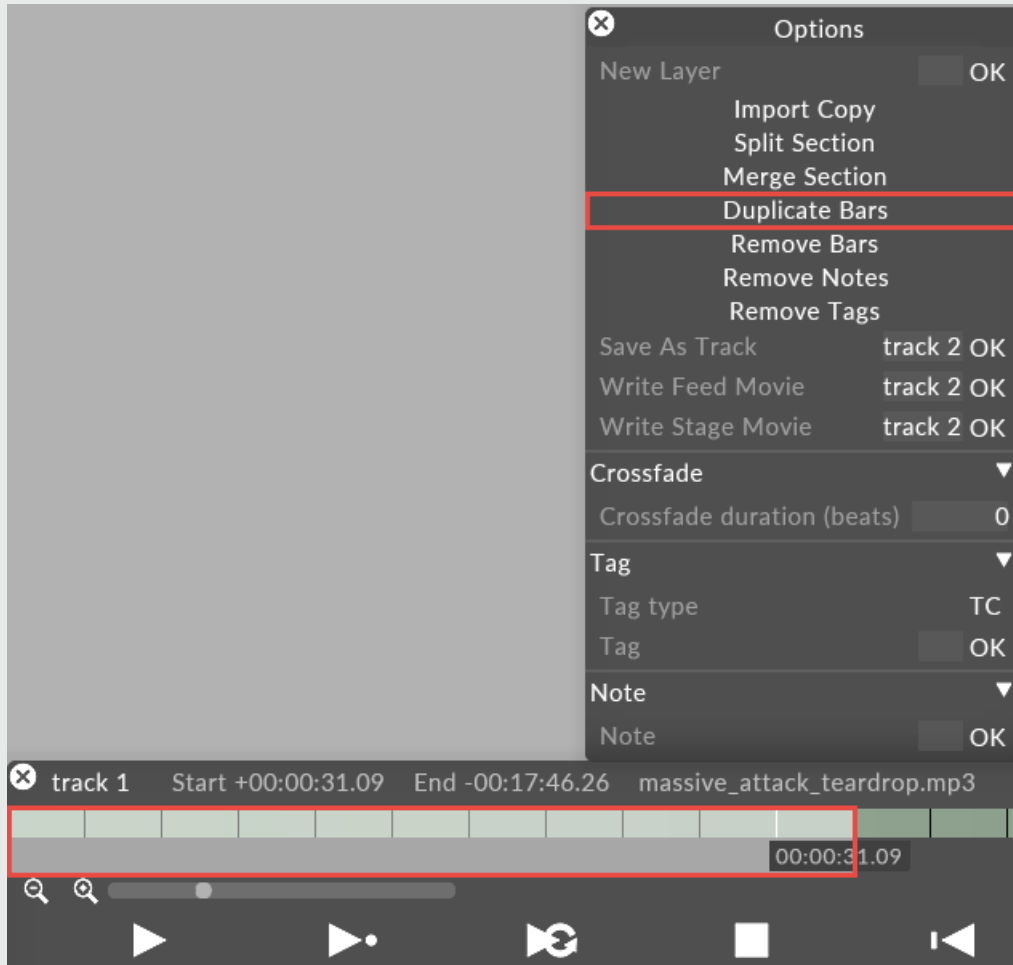

## Removing bars

- Select a timeline region by holding down the **left Shift key** and dragging the cursor across the bars you want to remove, as illustrated in the previous section. Then rightclick the grey region and select **Remove Bars**.

**Please note:** removing bars will remove all content layers and events within the removed region. The undo function, **CTRL-Z**, is your friend.

# Setup audio output

## Output devices

Disguise offers the ability to patch timeline audio to various devices with flexibility.

- Patching can be done per machine on a d3Net setup.
- Particular patches can be monitored on local headphones/speakers.
- External sound cards are auto-detected and made available to the patch.

**Please note:** At this stage audio input, LTC and quantised audio tracks cannot be patched.

## Concepts

Audio output is managed by the **Audio Output Patch Manager**, accessible via the **Devices menu** item.

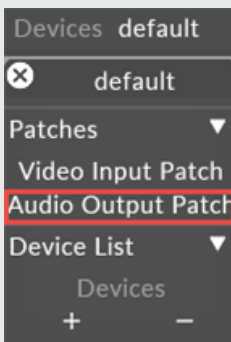

**Audio Patches** are essentially 'virtual slots' from which you can patch to physical audio for each machine in your Disguise setup. You can have as many **Audio Patches** as you wish. Each **Audio Patch** is two channels; a stereo pair.

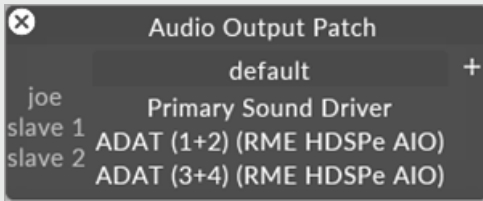

Each **Audio Patch** (columns) can be configured per machine (rows) in the d3Net Manager set up.

Clicking a cell in the table, presents you with the physical stereo pairs available on the machine. Audio output devices listed are auto-detected over d3Net, including external audio devices. If the remote machine is not currently connected, the list is derived from the **Machine Type** selected in **d3Net Manager** and will present the outputs of the internal sound device.

If the local machine is not part of a d3Net network, a single row for the local machine will be presented.

## Configuration - Step by step

To configure an **Audio Patch** follow these steps:

1. Ensure your audio output device source is connected correctly. (XLR connection etc.)
2. Right-click **devices** in the State editor.
3. Left-click **Audio Output Patch**.
4. Create an **Audio Patch** by pressing the **+** icon.
5. Enter a name for the patch and click **OK**.

A new column will have been created in the **Audio Patch Manager**.

6. In the cells under the column, use the drop down to select the audio output on the physical audio device you wish to map the audio to.
7. You can now pipe Video Content Layer audio on the timeline into the **Audio Patch** which will accordingly output it to the physical audio device output from the mapping.

**Please note:** You can monitor **Audio Output Patches** using the **Monitor Audio** menu item in the **State** menu. This will pipe the selected patch to the local machines Primary Audio Device (as set by Windows).

## Working with audio on the timeline

Audio can either be embedded in videos or added in an audio layer to be played back.

If embedded in a Video, then in the **Video Layer** under **Audio**, the **Output** field allows you to select the Audio Patch you wish to output the audio to.

## Sample rates

All audio outputs' sample rates should be set to match that of the content (and conversely, when the output sample rate is fixed the content should be rendered to match).

The currently configured sample rate for the patched audio output is displayed in the Audio Output Patch for each machine.

Below are details of how to change the sample rate on the RME audio interfaces in servers and generic instructions for devices that use the Windows audio settings (which applies for most consumer audio devices). For other professional audio devices, please consult the manufacturer's documentation.

## Changing the sample rate

As of r15.2, changing the sample rate must be done outside of Disguise software in the RME audio device settings. Pre r15.2, the sample rate is set in Disguise software audio patch editor.



**Warning:** It is important to set the sample rate to be the same across all machines.

1. Right click on the "Hammerfall DSP" icon in the System Tray and select Settings.

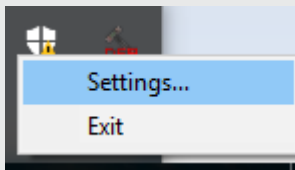

2. Select the desired sample rate from the drop down menu.

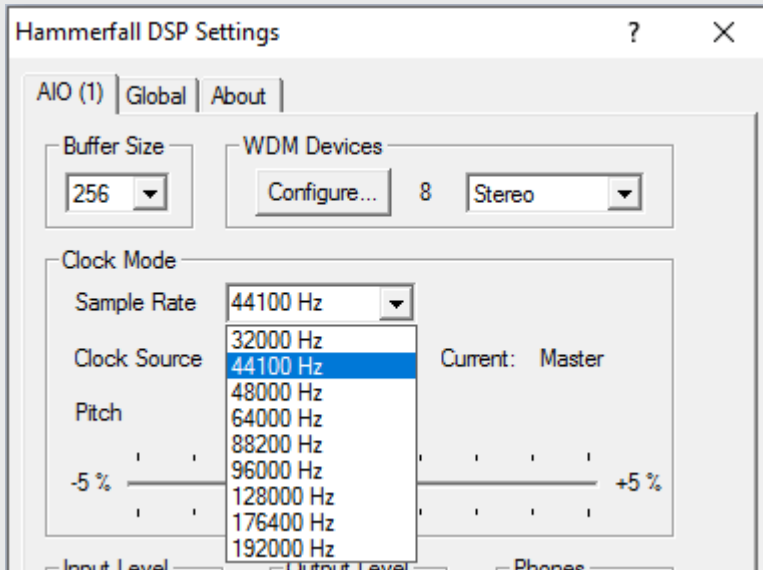

3. Right click on the audio icon in the System Tray and select **Playback devices**.

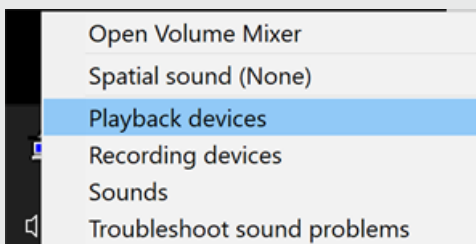

4. Double click on the relevant audio device



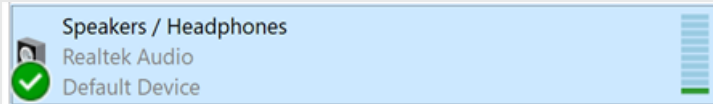

5. On the **Advanced** tab, select the desired sample rate from the drop-down list.

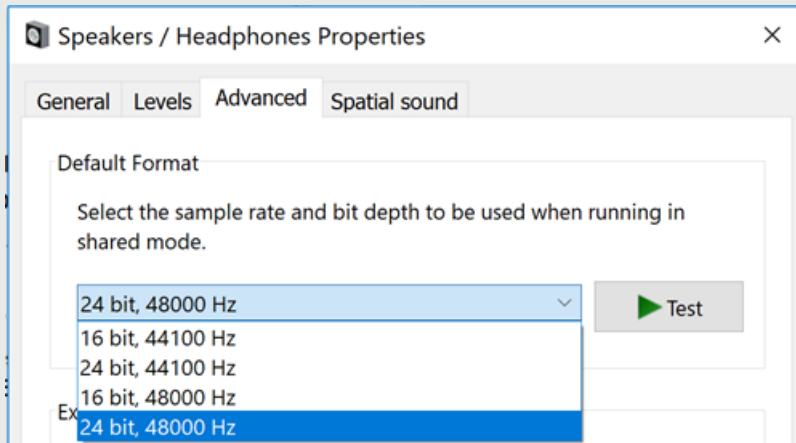

# Setup audio output

## Output devices

Disguise offers the ability to patch timeline audio to various devices with flexibility.

- Patching can be done per machine on a d3Net setup.
- Particular patches can be monitored on local headphones/speakers.
- External sound cards are auto-detected and made available to the patch.

**Please note:** At this stage audio input, LTC and quantised audio tracks cannot be patched.

## Concepts

Audio output is managed by the **Audio Output Patch Manager**, accessible via the **Devices menu** item.

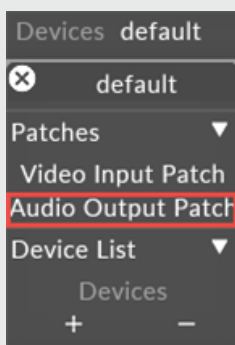

**Audio Patches** are essentially 'virtual slots' from which you can patch to physical audio for each machine in your Disguise setup. You can have as many **Audio Patches** as you wish. Each **Audio Patch** is two channels; a stereo pair.

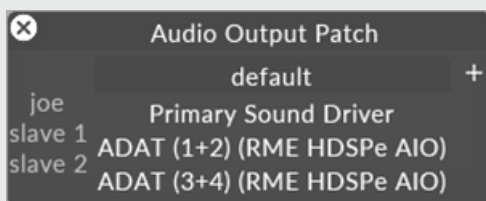

Each **Audio Patch** (columns) can be configured per machine (rows) in the d3Net Manager set up.

Clicking a cell in the table, presents you with the physical stereo pairs available on the machine. Audio output devices listed are auto-detected over d3Net, including external audio devices. If the remote machine is not currently connected, the list is derived from the **Machine Type** selected in **d3Net Manager** and will present the outputs of the internal sound device.

If the local machine is not part of a d3Net network, a single row for the local machine will be presented.

## Configuration - Step by step

To configure an **Audio Patch** follow these steps:

1. Ensure your audio output device source is connected correctly. (XLR connection etc.)
2. Right-click **devices** in the State editor.
3. Left-click **Audio Output Patch**.
4. Create an **Audio Patch** by pressing the **+** icon.
5. Enter a name for the patch and click **OK**.

A new column will have been created in the **Audio Patch Manager**.

6. In the cells under the column, use the drop down to select the audio output on the physical audio device you wish to map the audio to.
7. You can now pipe Video Content Layer audio on the timeline into the **Audio Patch** which will accordingly output it to the physical audio device output from the mapping.

**Please note:** You can monitor **Audio Output Patches** using the **Monitor Audio** menu item in the **State** menu. This will pipe the selected patch to the local machines Primary Audio Device (as set by Windows).

## Working with audio on the timeline

Audio can either be embedded in videos or added in an audio layer to be played back.

If embedded in a Video, then in the **Video Layer** under **Audio**, the **Output** field allows you to select the Audio Patch you wish to output the audio to.

## Sample rates

All audio outputs' sample rates should be set to match that of the content (and conversely, when the output sample rate is fixed the content should be rendered to match).

The currently configured sample rate for the patched audio output is displayed in the Audio Output Patch for each machine.

Below are details of how to change the sample rate on the RME audio interfaces in servers and generic instructions for devices that use the Windows audio settings (which applies for most consumer audio devices). For other professional audio devices, please consult the manufacturer's documentation.

## Changing the sample rate

As of r15.2, changing the sample rate must be done outside of Disguise software in the RME audio device settings. Pre r15.2, the sample rate is set in Disguise software audio patch editor.



**Warning:** It is important to set the sample rate to be the same across all machines.

1. Right click on the "Hammerfall DSP" icon in the System Tray and select Settings.

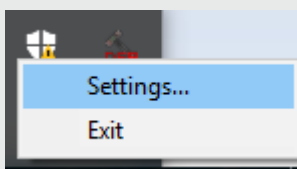

2. Select the desired sample rate from the drop down menu.

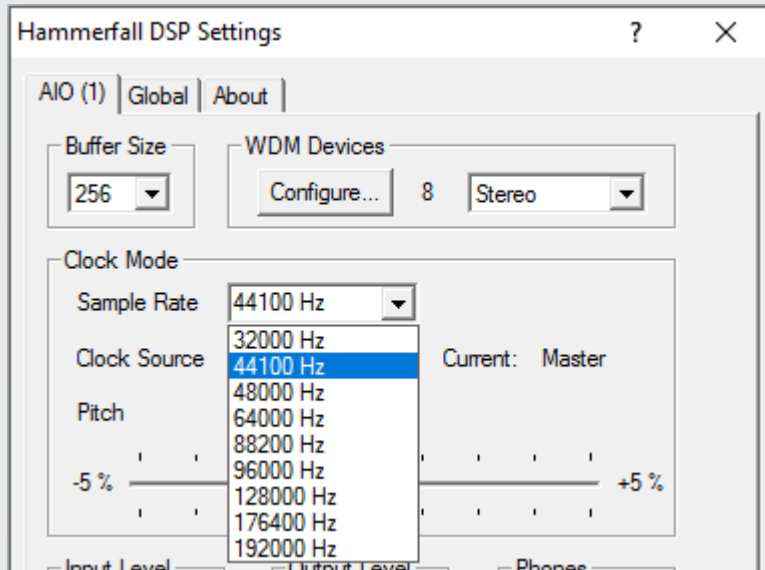

3. Right click on the audio icon in the System Tray and select **Playback devices**.

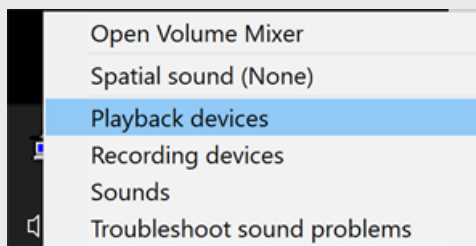

4. Double click on the relevant audio device

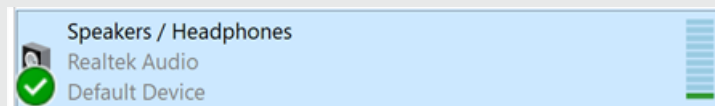

5. On the **Advanced** tab, select the desired sample rate from the drop-down list.

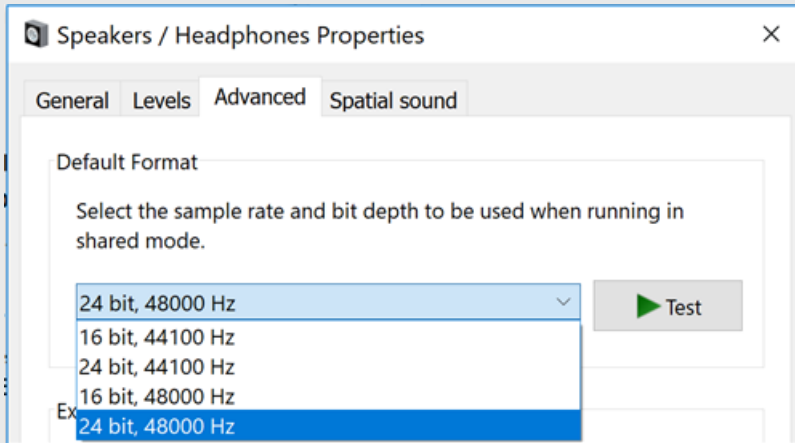

# Output professional audio

The Disguise software **can** play back a quantised audio file attached to the Track. However, to achieve PA audio quality, it is recommended to embed uncompressed audio within a video file and play that audio back as a Video layer. The audio can be either embedded in the same video file as the video content, or as a separate 16x16px DXV video file.

## Audio format restrictions when embedding audio into a video file (pre r15.2)

- 44.1kHz, 16bit samples, stereo, uncompressed **.wav** embedded into a 16x16 pixel Quicktime **.mov** (DXV preferably)

## Playing back audio in a separate video file

The advantage of rendering the audio into a separate low-res video file, as opposed to embedding it in the same video file as the video content, is that if the audio or video is updated the embedded video file does not have to be re-rendered.

To play back audio in a separate video file:

1. Render the audio into a 16x16px black DXV video using for example Adobe After Effects. Make sure to have the DXV codec installed.
2. Copy the video file with the embedded audio to the **VideoFile** folder in the specific Project folder. See the [Placing media files for a project](#) topic to understand where to copy a video file.
3. Create a [Video layer](#).
4. Select the video file containing the audio and drop it onto the Video key-frame editor.
5. Create a new screen of the type Screen and rename it to **Audio dummy screen**.
6. Set the resolution of the screen to 16x16px and set the offset values so it's positioned far away from the other video screens in the Stage. This screen will only be used for audio output and has therefore no visual function.
7. Select the mapping type used for the **Audio dummy screen** for the Video layer. This will direct the Video layers output to the **Audio dummy screen** screen.

8. In the Output Feed level, add a Feed rectangle to the **Audio dummy screen screen**. This will copy the **Audio dummy screen** screens content from the Stage level to a Feed scene in the Feed level. Hit **Enter** or select the Play button to output the audio to a PA.

To play the audio in sync with video content, create a second Video layer, position the video file at the same position on the Video key-frame editor as the video file containing audio, and map the second Video layer to a separate screen.



# Output multi-channel audio

The RME audio card in the pro range, gx range (not gx1), plus range (optional) and classic range machines supports up to eight channels of audio via ADAT over an optical TOSLink cable.

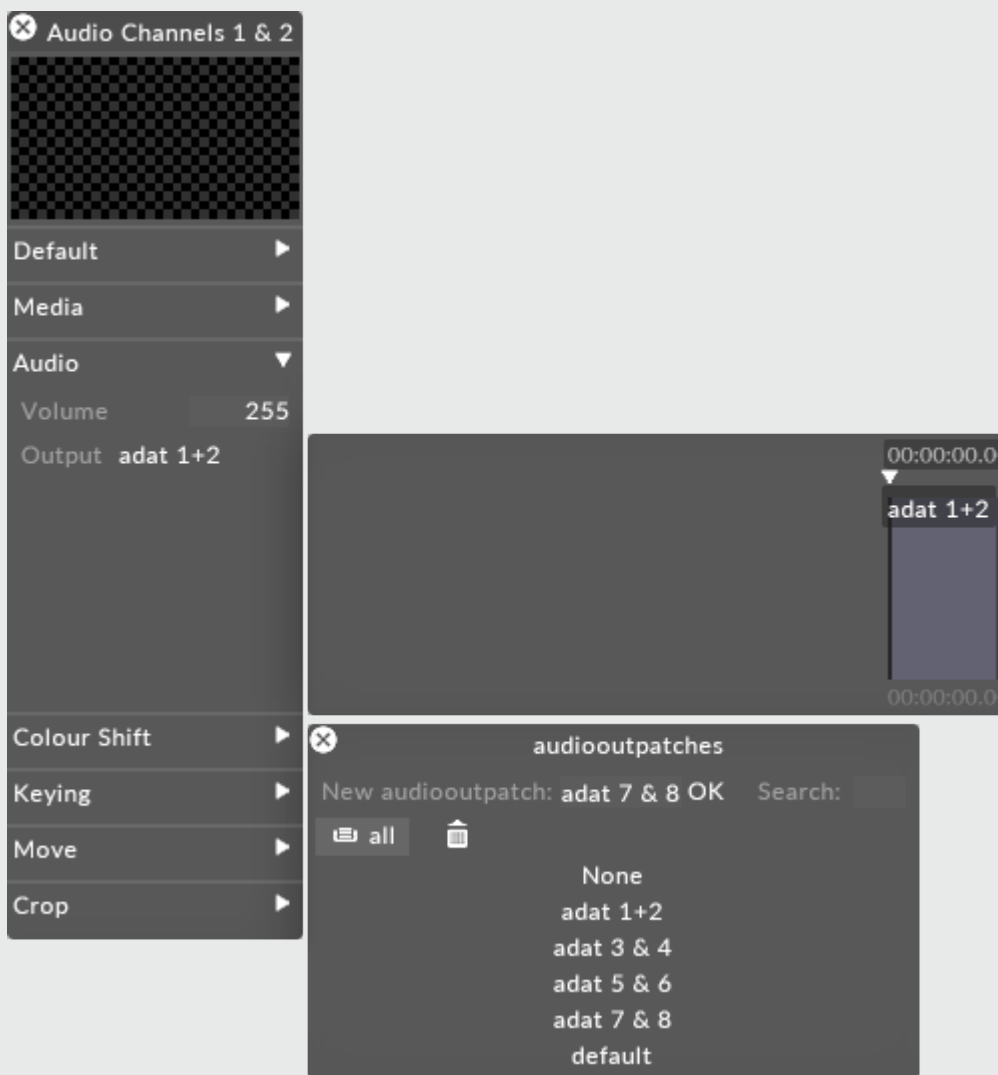

The ADAT outputs present themselves in stereo pairs. For example **ADAT (1+2) (RME HDSP 9632)**.

The process explained in the previous sub-chapter, Outputting audio can be used to output multi-channel audio. However, each Video layer can only output two channels. Therefore, four Video layers will need to be created to output the eight audio channels.

## Known limitations

- Audio files do not currently support versioning.
- Audio embedded in video files does not support more than two channels.
- We cannot re-mix the channels inside Disguise software.
- To output true multi-channel audio you need to set the RME interface into multi-channel mode. This is done externally to Disguise software.

## Outputting multi-channel audio with the Video layer

1. Separate the audio track into 4 different video files, one for each stereo pair.
2. Map each channel depending on which ADAT channel the audio is to be assigned.
3. Render out a video for each stereo pair. The video file format is outlined in the previous sub-chapter Outputting audio.
4. Follow the steps explained in the previous sub-chapter Outputting audio for each of the four video files.

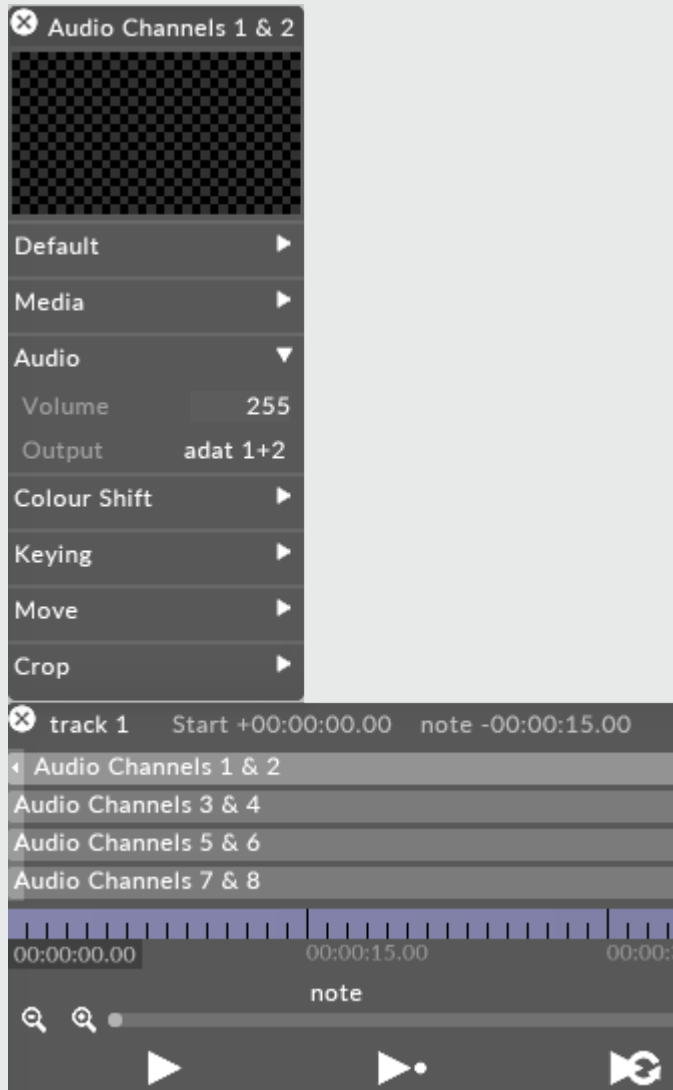

One Video layer can output two channels of audio, therefore four Video layers are required to output eight channels of audio.

# Outputting multi-channel audio with the Audio layer

1. Change the ADAT mode in the audio card software to multi-channel.

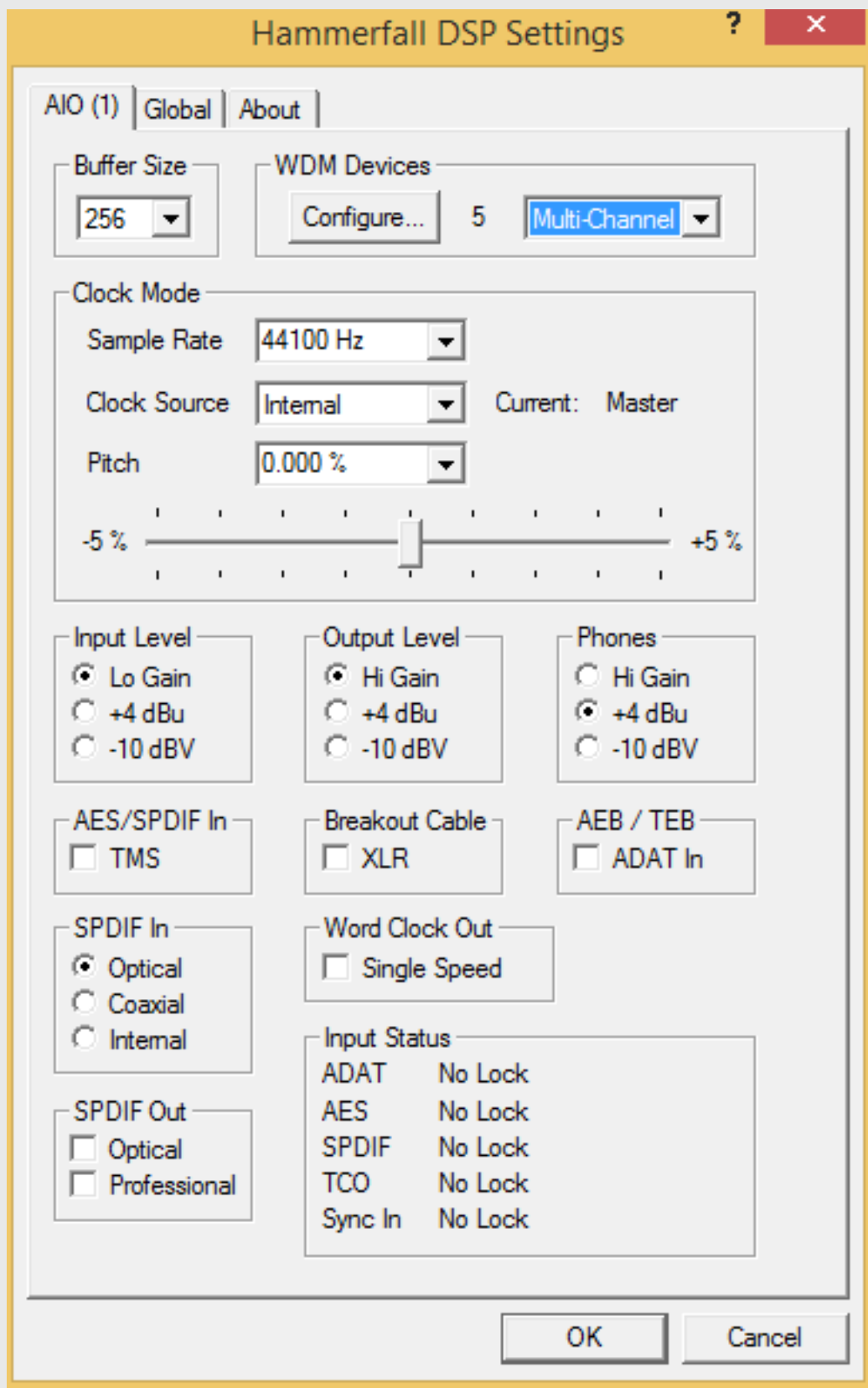

2. Select the now visible, multi-channel ADAT device from the audio output patch.

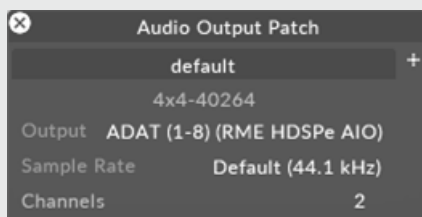

3. Add an Audio layer and define your multi-channel audio file.

## ASIO multi-channel audio with the Audio layer



**Warning:** Only one program can access ASIO at a time. Therefore using a program such as Notch at the same time as Disguise software is not supported for this workflow.

1. Select the ASIO audio device in the audio output patch editor.  
For 5.1 audio use Adat 1 => Adat 6  
For 7.1 audio use Adat 1 => Adat 8
2. Select output channels.

## WASAPI multi-channel audio with the Audio layer

1. Select the WASAPI audio device in the audio output patch editor, it will have the name **ADAT 1-8**.
2. Select output channels.

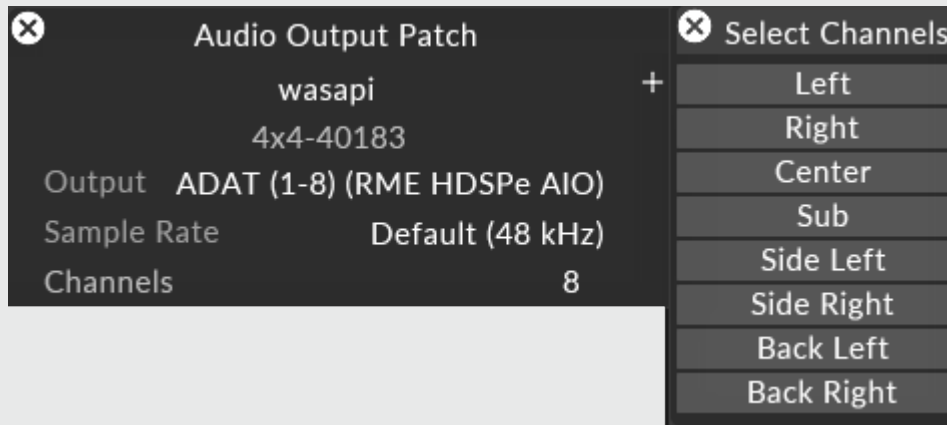

Audio output patch editor with WASAPI outputs selected.

## WASAPI channel numbering

- LEFT - ADAT 1
- RIGHT - ADAT 2
- CENTER - ADAT 3
- SUB - ADAT 4
- SIDE LEFT - ADAT 7
- SIDE RIGHT - ADAT 8
- BACK LEFT - ADAT 5
- BACK RIGHT - ADAT 6



# Output audio to DA converters

## Single system

If you are working with one machine it is relatively straight forward to setup audio output

1. Run a optical cable from the sound card on the Disguise system into your DA convertor
2. Set up the DA to receive sync clock from external device

You should now have 1-8 channels of analogue audio coming out of your DA converter

## Multiple systems

If you are having a backup (understudy) there are 2 ways to do:

- Do as described above utilizing a dedicated DA for the master and a dedicated DA for the understudy.
- Synchronise multiple machines to one DA or a Mixing Desk.

**Please note:** This presumes your DA has 2 ADAT convertors (RME ADI-8 QS, RME ADI-8 DS, MOTU 2408mk3) i.e. the ability to output 16 channels of analogue audio.

In the scenario of multiple machines and one DA, the audio sample clocks of the master and understudy both needs to be synchronised with the DA convertor.

## This is how to do it:

1. Your external DA is going to be the audio sync clock **master** so make sure the clock source is internal You will probably also have to set your correct sample rate and bit depth.

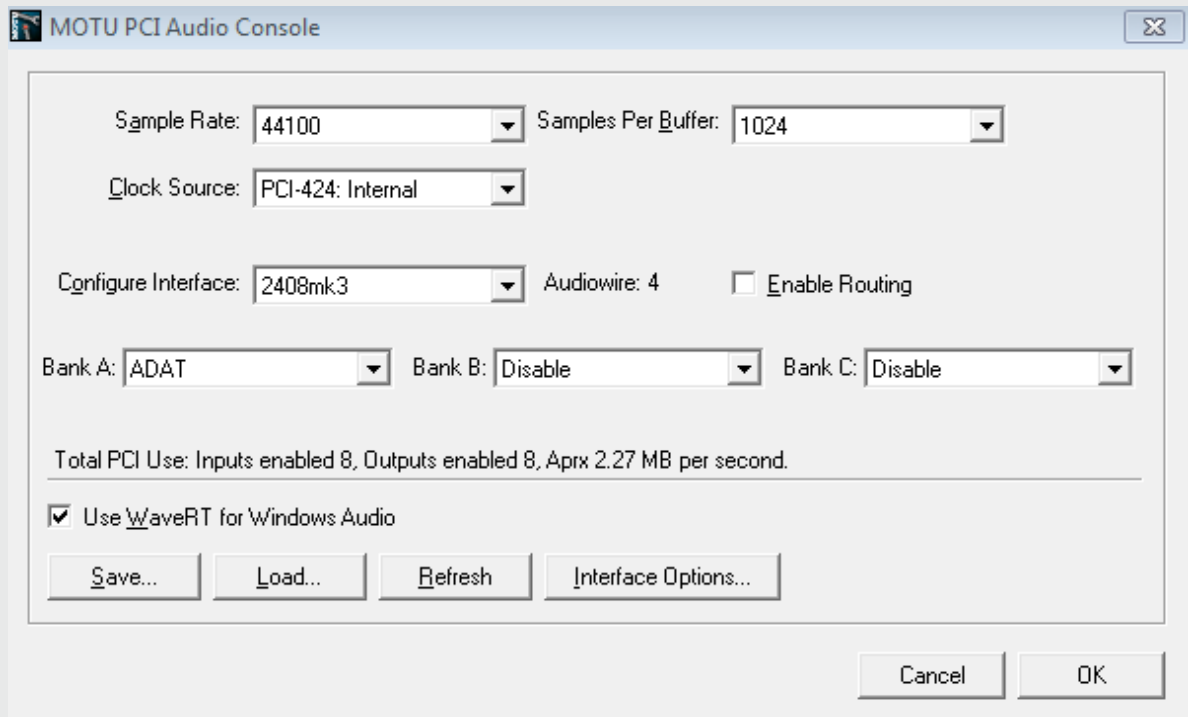

2. Your RME settings in your machine should be set to Clock source: **ADAT IN**, however it should auto detect if not otherwise is specified.

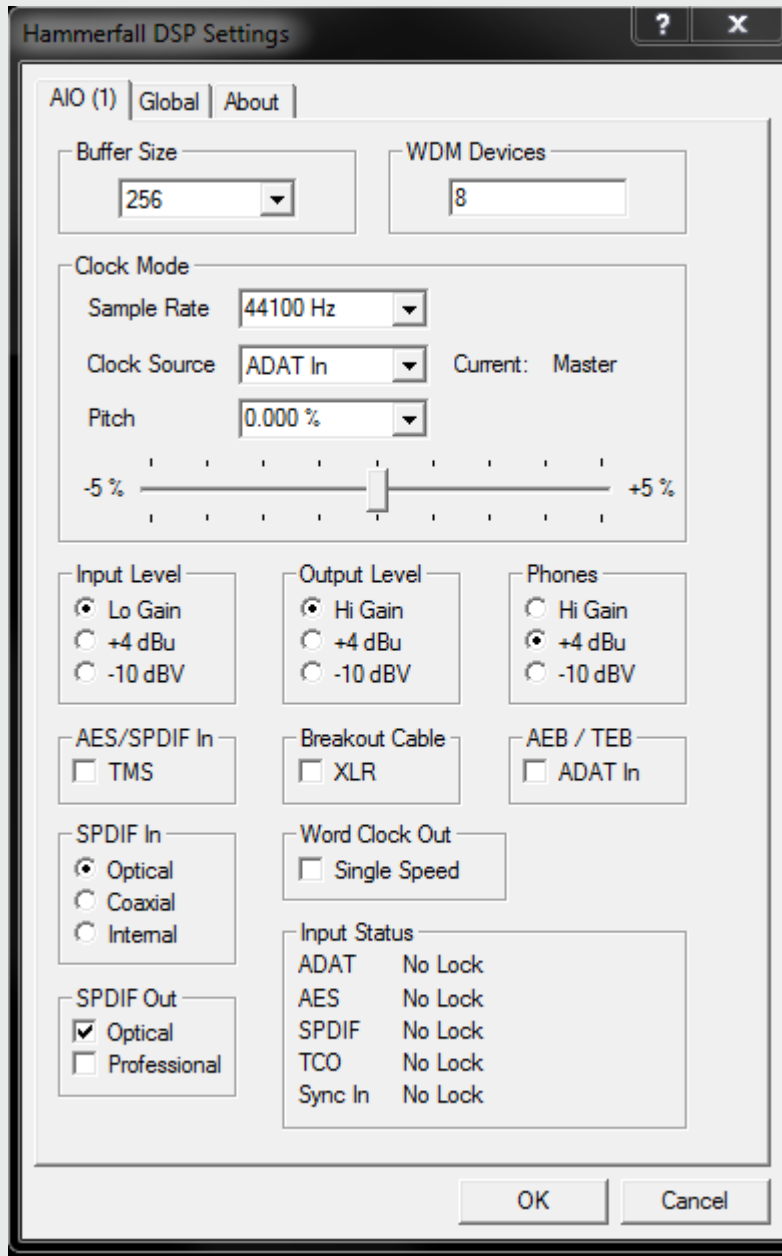

- Both of the optical cables needs to be connected; one is for signal and one is for sync

4. The bottom outlet (grey) is the signal output from the Disguise system and goes into input on the DA converter.
5. The output on the DA converter (sync) is going into the top input on the Disguise system (Black)
6. You should see in the RME settings menu on the Disguise system that it is receiving sync signal over the optical cable
7. Repeat this step for the understudy as well and you should be good to go

## Troubleshooting

Audio playing in Disguise software/ windows but no audio is converted in the DA converter or very small sporadic instances of audio is coming out of the DA

- Check the sample rate and bit depth of the entire signal path and make sure they are all set the same parameters (44.1/48 16 bit)

Clicks and pops are heard in the audio from either of the machines

- The audio sampling is not synced correctly, please check the entire signal path for synchronization e.g. ADAT clock internal on, clock receive ADAT in.

# Audio Waveform View

The audio waveform allows users to visualise the audio output of a single layer, a collection of layers or the quantized audio track while working in the keyframe editor. This permits them to add keyframes while taking audio output as a consideration at a glance.

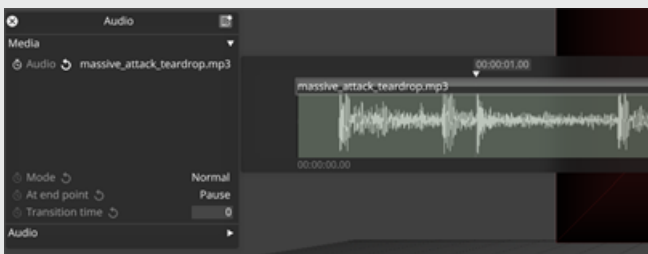

To visualize the audio waveform of one or more layers:

1. Create one or more audio layers.
2. Set the audio track of the layer(s).  
This example uses *massive\_attack\_teardrop.mp3*.
3. Open a keyframe editor.
4. Right-click in the keyframe editor area to access keyframe **Options**.

The available options are:

- Delete keyframes after
- Delete keyframes before
- None
- Layer

— Combined

— Quantised

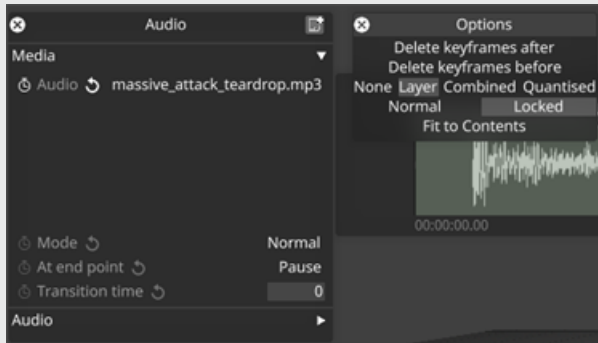

*Key widget waveform modes*

5. Select one of the following options:

a. **Layer**

to visualize the waveform of the currently opened layer

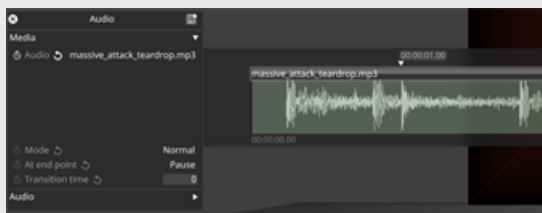

*Single layer waveform*

b. **Combined**

to visualize the collective waveform of multiple layers

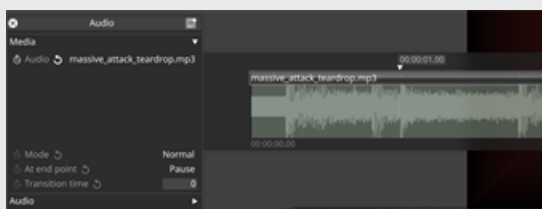

*Combined layers audio waveforms*

To visualize the audio waveform of the quantized audio

1. Add an audio track to the track.
2. Open a keyframe editor.
3. Right-click in the keyframe editor area to access the options
4. Select **Show quantised audio waveform** to visualize the waveform of the timeline audiotrack.

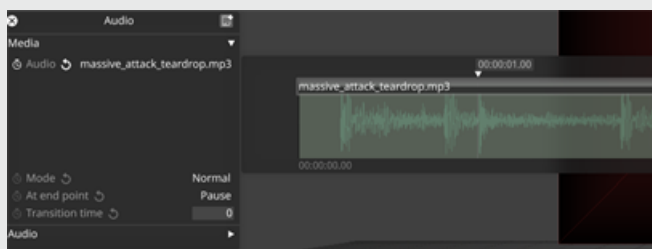

*Quantised audio waveforms*

Examples of audio waveforms

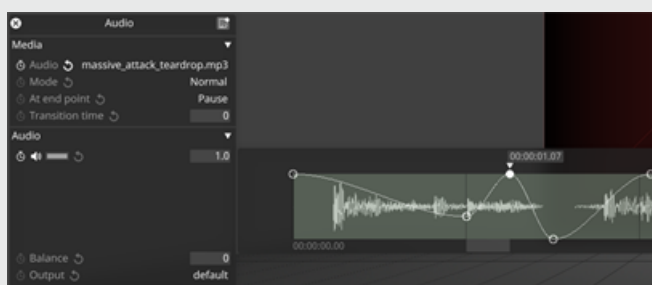

*Audio waveform with volume keyframes*



*Audio waveform in layer mode with quantised track*

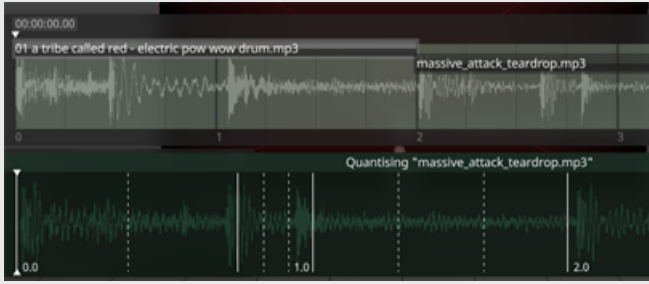

*Audio waveform in quantised mode with quantised track*



# d3Net overview

Director/Actor operation allows you to sequence shows whose output requirements are greater than a single machine's maximum.

The goal of Director/Actor operation is to allow you to sequence the entire show on a single machine (possibly a laptop) and then run the show on a network of machines. This network is called **d3 Net**.

There are 4 types of machine roles within a d3Net setup:

- Director Machine
- Actor (output machines)
- Understudy (backup machines)
- Editors - which can be any PC/Laptop running Designer.

Only one Director is allowed on a network. Multiple Actors, Understudies and Editors are permitted.

Every Director & Actor is configured to output video to its assigned Feed scene. Please see the chapter [Output Feeds](#) for more information on Feed scenes. For example:

- The Director machine is outputting to 1 GUI monitor and 3 projectors.
- Actor 1 outputs to projectors 4,5,6,7, no GUI. Actor 2 outputs to projectors 8, 9.
- The understudy machine should not have any specific Feed scene assigned to it as it should be able to take over from any other machine.

# The Director machine

A Director machine can either be Dedicated or Non-Dedicated. If a Director is not outputting to any screens other than the GUI, it should be set to Dedicated.

If a machine is Non-Dedicated, that means the machine controls all other Actors in the network but also outputs video through its remaining outputs. Dedicated means that the machine controls Actors, but does not output video to the stage; it is used only for visualisation and show sequencing.

The distinction is important because a Director that is Non-Dedicated will only play content destined for its output feed, the so called Feed Scene, for efficiency purposes. If you need to see all content in the visualiser, set the Director to Dedicated, or else ensure that all content in the project appears in the feed assigned to the Director.

# Actor machines

Actor machines automatically follow the Director machine's timeline, regardless of what the Director is doing. Therefore, there is no need to input any MIDI timecode (or any other external trigger signal) to the Actors; the Director is responsible for passing these on.

If an Actor relies on external automation signals or audio inputs, you will need to ensure that these signals are also sent to the machines; at present the Director will not distribute these signals automatically. The same is true for live video signals.

# Understudy machines

Designating a machine as an Understudy allows it to take over from any machine in the network if that machine fails, including the Director machine. The Understudy can be set to do this automatically or manually. It can also send a matrix present command to a matrix as it replaces the other machine. This can be useful for shows that need to run unattended but cope with potential machine failure.

# Editors

MultiEdit allows multiple people to edit a project simultaneously, without manually merging projects. Edits from each Editor are propagated to all other machines via the Director in real time. Each editor machine can work on a different track, or on different regions of the same track, at the same time; Editors can also take control of the Director timeline position and control the stage.

## Distributing signals

- The Understudy machine should also receive MIDI timecode or any other external trigger signal that the Director receives, in case it is needed to replace the Director machine.
- If controlling the Timeline with Art-Net there is also no need to split the Art-Net signal to any other machine other than the understudy.
- If inputting SDI, split and distribute the SDI signal to all servers in the network.
- If inputting MIDI from a control surface such as the BCF2000, split the signal into all servers.

# Setup d3Net

## The d3Net manager

The d3Net manager is used to set up a Director/Actor network.

To open the d3Net manager:

1. Open the Program Settings menu by right-clicking **d3** from the d3 State editor (bar at the top of the screen).
2. Left-click **d3Net manager** in the d3Net tab.

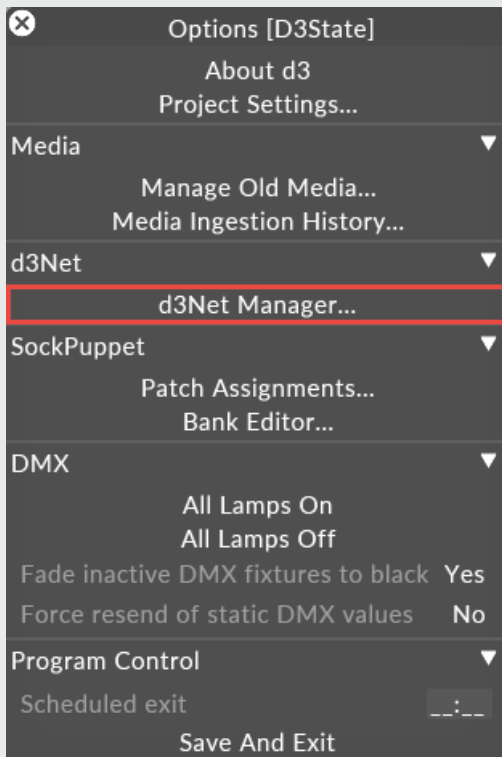

## d3Net manager properties

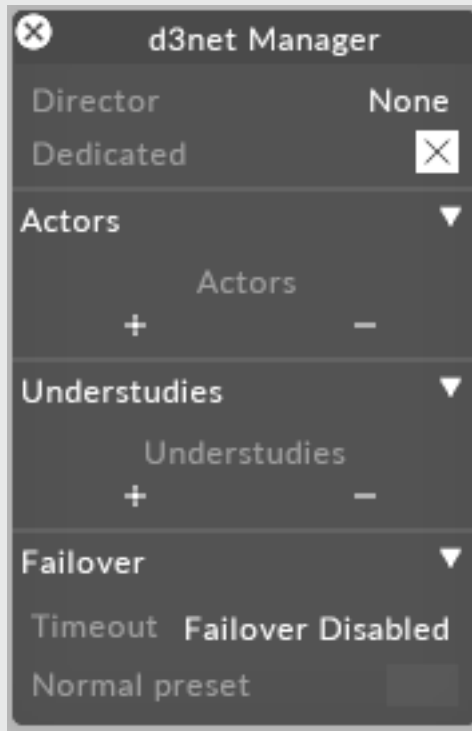

The d3Net manager can be configured to contain all of the Disguise machines in the Director/ Actor network. These machines are represented by virtual machine objects.

The **Actors**, **Understudies** and main sections of the d3Net Manager (described in greater detail below) are used to create an Actor, Understudy or Director machine.

To create a Disguise machine:

1. Open the Machines manager by either left-clicking **Director**, or left-clicking the **+** button under the **Actors** or **Understudies** section. The Machines manager displays a list of all of the machines you have created.

2. Type the machine name into the **New Machine** text field, for example **Director**, and hit **Enter**. The machine name should describe the **role** of the machine in the network (such as "Actor1"), rather than the name of the physical machine ("d3r0082"). The machine name will be displayed at the bottom right corner of each machine's GUI.

This will open the Machine Editor. Add the new machine to the Machines manager and assign it to a role within the d3Net manager. The Actors and Understudies can be removed from the d3Net Manager by click-dragging them to the - button. This will remove the machine from the d3Net network but not delete it; it will still be in the Machines manager.

## Director

Specifies which machine is used as the Director machine controlling the Actors and the Understudy (or multiple Understudies).

## Director type

Controls how the Director machine outputs content. Set to **Dedicated** for the Director to control the Actors and not output any content; When the Director is set to **Non-Dedicated**, it can output content via its own outputs as well.

**Please note:** if the Director Type property is set to Non-Dedicated, the Director will only show content on screens included in its assigned Feed scene. This is an optimization feature enabling the machine only to process content assigned to its Feed scene. Set the Director machine type to Dedicated to view content on all screens in the Director machine's visualiser.

## Actors

Specifies which machines are to be used as Actors. Each Actor will output according to its assigned Feed scene. The first output on the Actor machine, which is usually used for a GUI monitor on

the Director machine, can also be used as a display output.

## Understudies

Designating a machine as an Understudy allows it to take over from any machine in the network in case the machine fails, including the Director machine. The machines the Understudy should take over can be chosen from the **Understudy targets** section of the machine editor. For more information please scroll down to the section **Understudy targets** below.

## Timeout

The amount of time in seconds until the Understudy automatically takes over from the failed machine. Note that the value 0 disables this function.

## Normal preset

The default matrix preset when all machines are functional and outputting their assigned Feed scenes. Read more about matrix presets in the [Matrix & Switchers](#) sub-chapter.

## Machine editor

- To open the Machine editor, right-click the machine from the Machines manager or the d3Net manager.

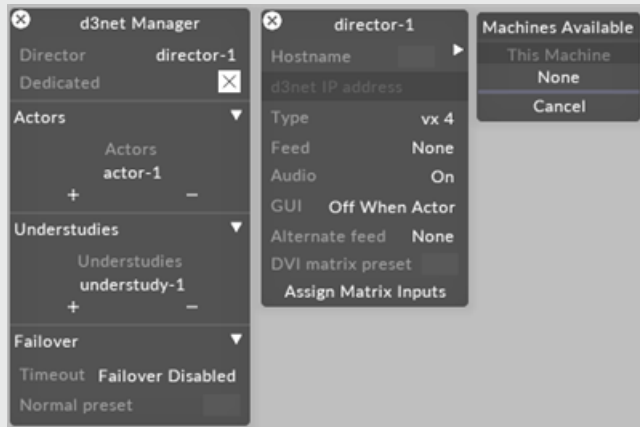

## Host Name

The Hostname of the machine. This can be selected from a list of discovered machines in the d3Net network, opened by left-clicking the arrow.

**Please note:** the Actor and Understudy machines must be running the d3Net launcher in order to appear in the list

Network manager monitors the health of the Actors using their frame rates

The **failover** section of the Network manager monitors the health of the Director and all of its Actors using frames-per-second readouts. For more information on frame-rate readouts please scroll down to the section 'Monitoring Actors' below.

## Type

Each machine can be set as a certain type. Changing this value sets the capabilities of the machine for Video Input Patch and Audio Output. The value is auto-detected, when the Disguise machines are connected. When machines are disconnected (for example when building your project in Disguise Designer) you can specify the type manually.



## Feed

Assigns a specific Feed scene to the machine. The Feed scene contains specific outputs and can be created directly from the d3Net manager. Alternatively, Feed scenes can be created and configured before assigning them to a machine using the Output Feeds level. Please see [Switching Feed scenes](#) for more information.

## Audio

Controls how audio is outputted from the machine.

**off** disables all audio from the machine,

**timeline only** plays audio from the Timeline,

**video files only** plays audio from video clips only,

**on** enables all audio.

Typically this property is used to allow audio from video clips to play through a PA whilst suppressing the Timeline audio, which is used for reference purposes on the Director only.

**Please note:** in order to output audio in a Director-Actor network the video file containing the audio needs to be mapped to a screen. The screen then needs to be assigned to a Feed scene, which in turn needs to be assigned to the machine which will output the audio. If using a separate low-res DXV videofile (16x16 pixels) which only contains audio and no video, create a low-res 'dummy screen and assign it to the Feed scene. Read more about outputting audio in the [Outputting audio](#) sub-chapter.

## GUI

Controls whether to start up with the GUI; options are **off when Actor**, **always on** and **always off**.

## Matrix Control

This is a preset number to be automatically sent to the [Matrix](#) by the Understudy when one of the machines fails. A preset number should **only** be set in the Director and Actor machines. In case of a machine failure, that machine's preset number will be sent to the matrix by the Understudy.

You can also enter the information for which input on the matrix each head on the machine is connected to for Direct Matrix routing. For more information please see the [Direct Matrix routing](#) sub-chapter.

If there are multiple matrix devices Disguise software will send the same preset to all matrix devices in the Devices manager list. For step-by-step instructions on how to create a device please see the [Creating devices](#) sub-chapter.



**Warning:** automatic preset switching is currently only available when using one understudy. If using multiple understudies, the matrix needs to be switched manually.

## Alternate feed

Specifies the alternative Feed scene the Understudy should switch to if one of the machines fail. If set to **None**, the Understudy will switch itself to the standard Feed scene specified in the previous property. This is mainly used if the Understudy's Feed scene has different output head size settings than the machine it is replacing. Please see the explanation of the **Feed** property above for information on how to create Feed scenes using the Output Feeds level.

## Understudy targets

The machines the Understudy should take over can be chosen from the **Understudy targets** section of the Machine editor. However, in order to see this section:

1. Create an Understudy Machine. When creating an Understudy, leave the **Feed** property (described below) blank. This is because it should be able to use any other Feed scene assigned to the failed machine.
2. Close and reopen the Machine editor. A new section called **Understudy targets** will now exist at the bottom of the editor.

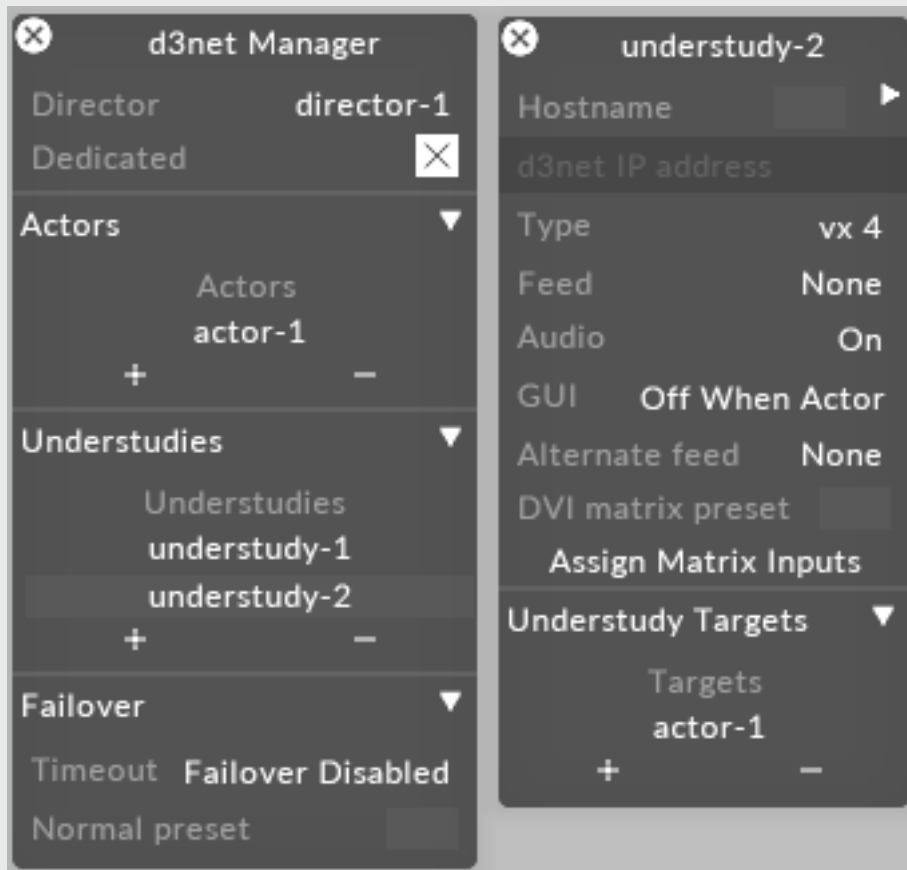

Understudy targets section of the Machine editor is used to add machines the Understudy should take over

If no machines are added to this list, then the Understudy will take over from any machine on the network.

If a Matrix device has been added to the system, the Understudy can be configured to send a preset command to the connected matrix device.

## File distribution in a Director-Actor network

Once the d3Net manager has been set up correctly, copy the specific Project folder to all of the Actor and Understudy machines in the network. The video files must be distributed in such a way that every machine has all of the content files it will need to play during the show. For information on where the specific Project folder is located please see the sub-chapter [Projects location](#).

## Remote control service

The Disguise machines are installed with a Windows services, named **d3Service**. When starting Disguise software on the Director, the Director automatically sends out a start Disguise network command, which attempts to start the Actor(s) with the specific project. When the Actor machine starts, it looks at the d3Net manager, identifies itself in the list and switches automatically to its assigned role and Feed scene.

**Please note:** d3Service installs as part of the installer and no activation is required.

## Monitoring Actors

The Director machine can monitor the health of all of its Actors. By default, the bottom right corner of the Disguise screen contains a frame-rate readout showing the number of frames Disguise software is outputting per second (fps).

60 fps is the optimum frame rate and indicates a healthy machine by showing in **green**;

<60 fps is unhealthy and shows in **red**.

If you select a 50Hz output mode, a smooth 50 fps shows as **green**).

Number of frames Disguise software is outputting per second, in this example a healthy 60 fps

In Director mode, the frame readout will be accompanied by a readout for each Actor. If the Actor is not running for any reason, the readout will be in red with a - instead of a number.

In Director mode the Director machines readout will be accompanied by a readout for each Actor.

# Setup Editors

MultiEdit allows multiple people to edit a project simultaneously, without manually merging projects.

Edits from each machine are propagated to all other machines in real time. Each editor machine can work on a different track, or on different regions of the same track, at the same time; editors can also take control of the Director timeline position and control the stage.

There are a few ground rules for MultiEdit that must be observed:

## The Director must be running

The Director machine is authority for show state; therefore, Disguise software must be running on the Director for a multiedit session to work. If you shut down Disguise software on the Director, all connected editors will be kicked out of the session. If you're uncertain how to set up a Director/Actor read the [setup d3net](#) page.

## The Director is the authority over show state

When an editor joins a session, it copies the project file over to the local machine. Any edits made on the local machine while it was offline will be overwritten. Therefore, if an editor makes edits to the project while disconnected, the only way to get the edits into the main project is to run a standard project merge.

## Edits are first-come, first-serve

When an editor attempts to make a change to any object, it locks that object for a short time (a tenth of a second). During this time, if another editor tries to change that object, the change will be locked out. Locking is 'fine-grained' - it is, for example, possible for two people to edit different properties of the same layer at the same time; but edits to the same property will be first-come-first-served.

## Director session control

The Director is the final authority on show state, and is responsible for show safety. Since unsupervised connection of editors at showtime introduces a risk, the Director has the ability to disallow any editors from connecting. It also has the ability to prevent editors from taking control of transport (the position of the cursor on the timeline). This is done using the network status widget on the Director.

## Send Transport Commands

This means that Actors are following the Director's timeline position. Clicking on this button changes the setting to disabled; show state will be propagated to Actors, but they will not follow if the Director jumps to a different part of a track, or jumps to a different track. This allows you to 'park' your Actors at a static position while editing continues on the Director.

## Editors are allowed

Means that editors are allowed to join the session. Clicking on this button changes the state to **editors blocked**; existing editors will be kicked off the session, and new editors will be disallowed.

## Synchronising the project

To join a session, the editor machine needs to first copy the entire project folder from the Director machine (including all media assets). Once this is done, the .d3 project file will be synchronised automatically; however any new media files must currently be synchronised manually using a third-party synchronisation utility.

## Joining a session

To join a session, open the [d3Manager](#) and find the project session in the project list. If the session is running, you'll see the session icon next to the project name.

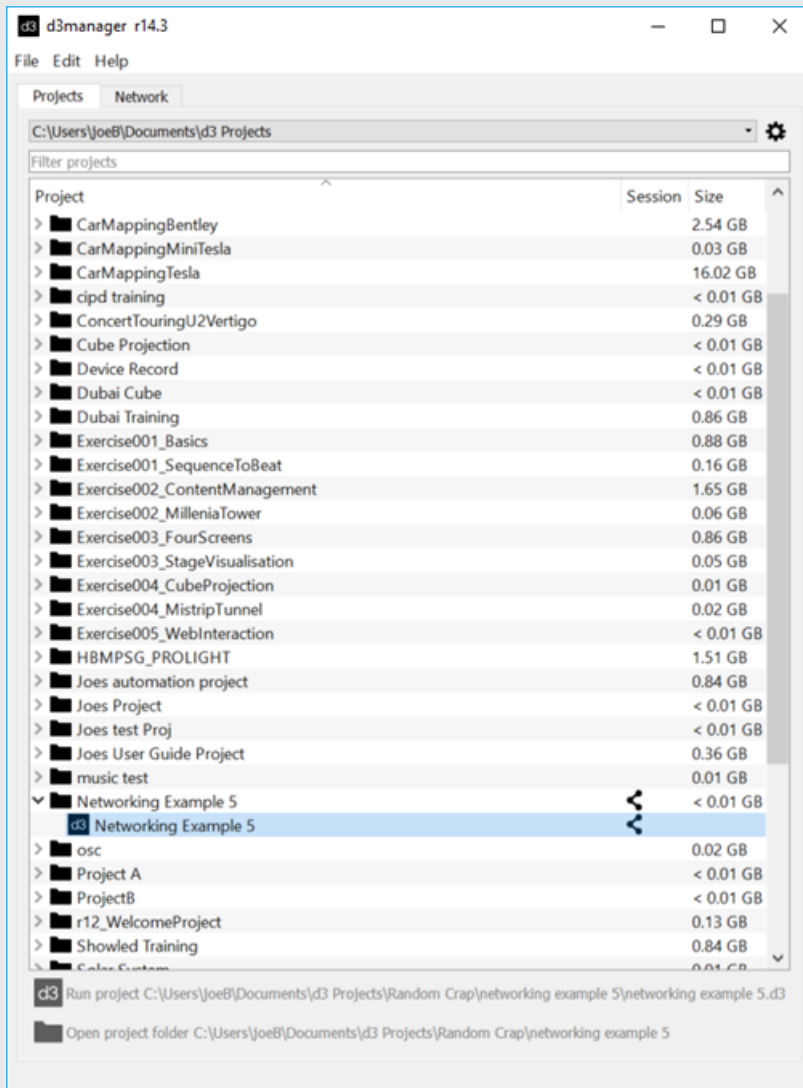

- Double click the project to launch, and when prompted, choose **Join Session**.  
Or alternatively;
- Right-click on the project name, and select **Join Session**. This will pop up a dialog box warning you that any local edits will be overwritten (they will be copied into the history folder, so they're safe); clicking **OK** will start Disguise software in editor mode and synchronise the project file; you'll see **synchronising project file** in the startup sequence.

For more options how to join a session see the [d3Manager](#) page.

Once you're running, you'll know you're an editor if you see the **independent** button at the bottom right of the Disguise GUI.



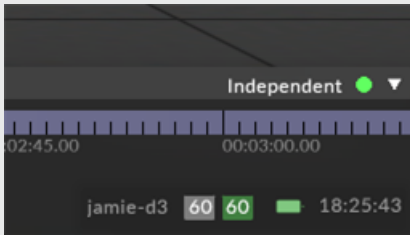

## Editing objects

Once you're in the session, you'll find editing is pretty much the same as when you're running as a Director or solo machine, with a couple of exceptions:

- you can't edit the Director/Actor configuration itself.
- you can't control any of the Director properties in the (dashboard).

## Timeline control

By default, the editor machine maintains its own transport position (position on timeline, and which track is selected). This means that you can freely jump from one track to another, making edits, without affecting the Director or the Actors. Sometimes, however, you'll want to take control of the transport from the editor.

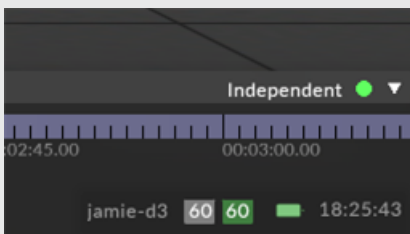

To do this, press the **independent** button on the timeline title bar. If the Director has allowed editors to take transport control (see **Director session control** above), the button will show **locked to Director** and flash green.

Clicking on a different bar of the track, pressing play/stop or next/prev section, or switching to another track, will be reflected on the Director and the Actors. Conversely, any transport control movements (including those generated by other editors, or external transport devices such as lighting desks or OSC) will be followed by the local editor machine, on a first-come, first-served basis.

# Network Adapter

It may be necessary to manually assign a network adapter to Disguise software in complex network scenarios, or with machines that have multiple network connections.

This can be done in d3Manager before starting a project. Selecting a network adapter will then ensure Disguise net always uses that connector.

To select the adapter, choose it from the dropdown list and then click the **Set Network Adapter** button. Once you have selected a network adapter, Disguise will prompt you to restart your machine.

Any [Current selection] ▾  
Any [Current selection]  
WiFi

Set Network Adapter

			Status
Joe	r14.3 37860	Designer	Normal

# Windows network settings

## General preparation

1. Download and install the latest Disguise release version onto all machines in the network.
2. Run the **same** Disguise installer on all machines.
3. Do not run a checkpointed version of the Disguise project when you are working in a Director/ Actor configuration. For information on checkpoints, including how to disable a checkpoint, please see the [Running a project from a checkpoint](#) sub-chapter.
4. Ensure that the Disguise machines have no third-party programs installed which may cause a reduction in performance or other unwanted actions.
5. Disable all popup windows and auto-update functions.

## Set up IP addresses

To use Disguise software in a Director/ Actor configuration, every Disguise machine needs to be set to a static IP address within the same network. When providing [DMX input/output](#) the DMX LAN port also needs to be set to a static IP address. To do this:

1. Open the Windows Network and Sharing Center (Start menu > **Control Panel** > **Network and Sharing Center** ). This window can also be opened by selecting the network icon in the task-bar (bottom right-hand corner of the screen) and selecting **Open Network and Sharing Center**

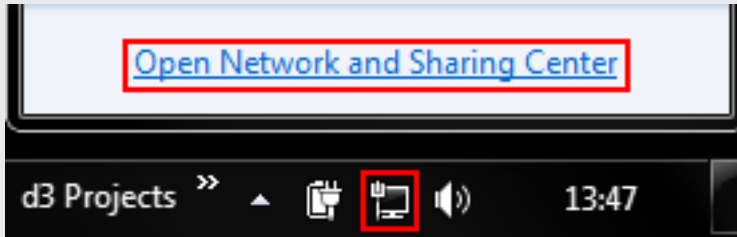

2. Select **Change Adapter Settings** in the left hand pane.

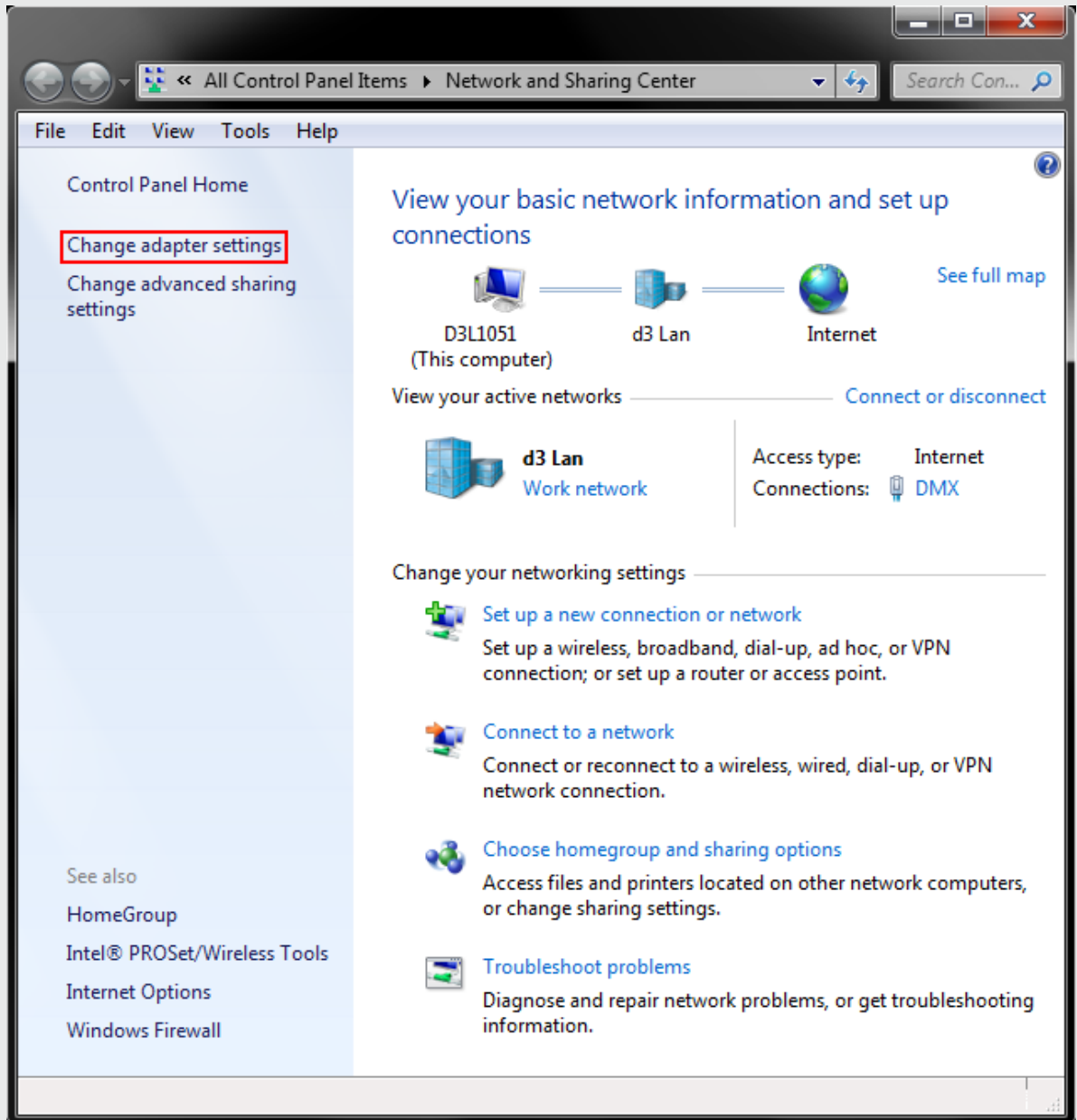

3. Right-click the **Data** port and select properties.

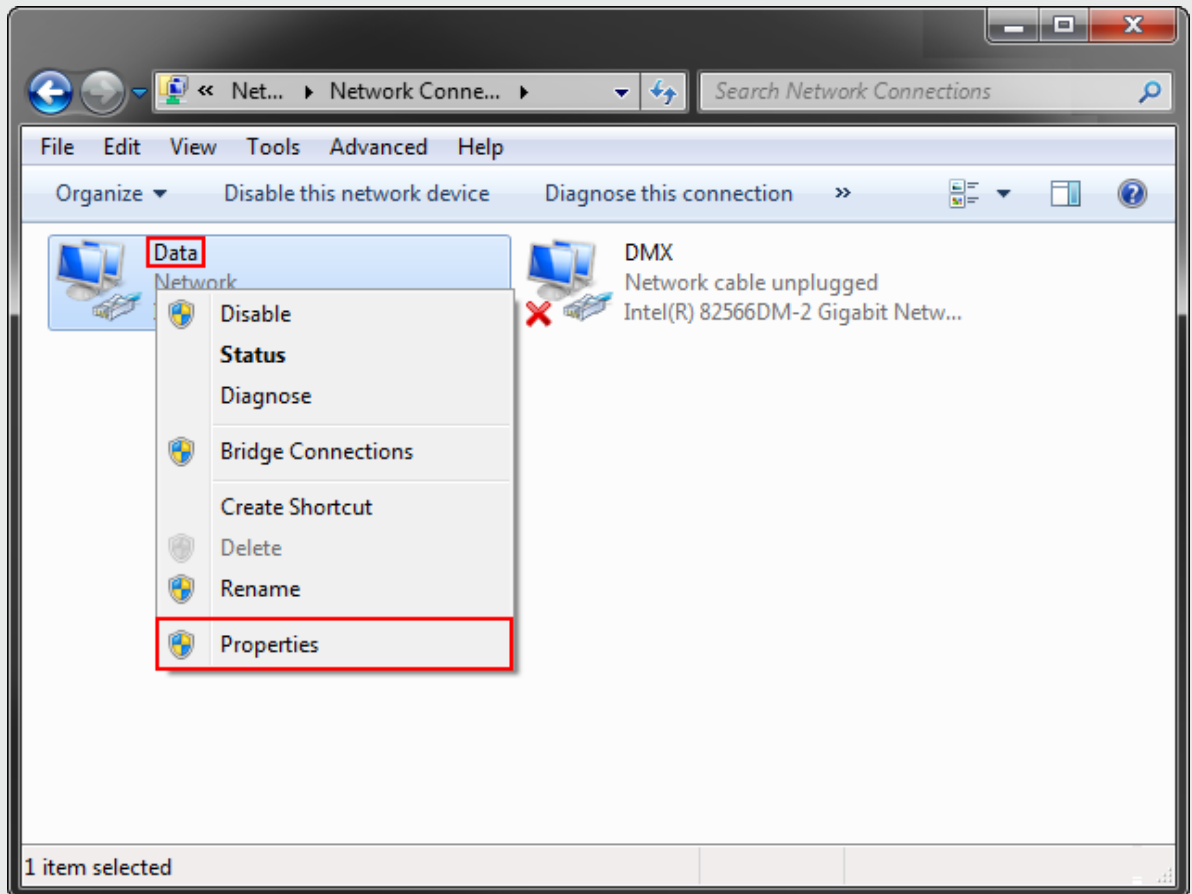

4. Untick the TCP/IPv6. This disables IPv6.
5. Select **Internet Protocol Version 4 (TCP/IPv4)** and select **Properties**.

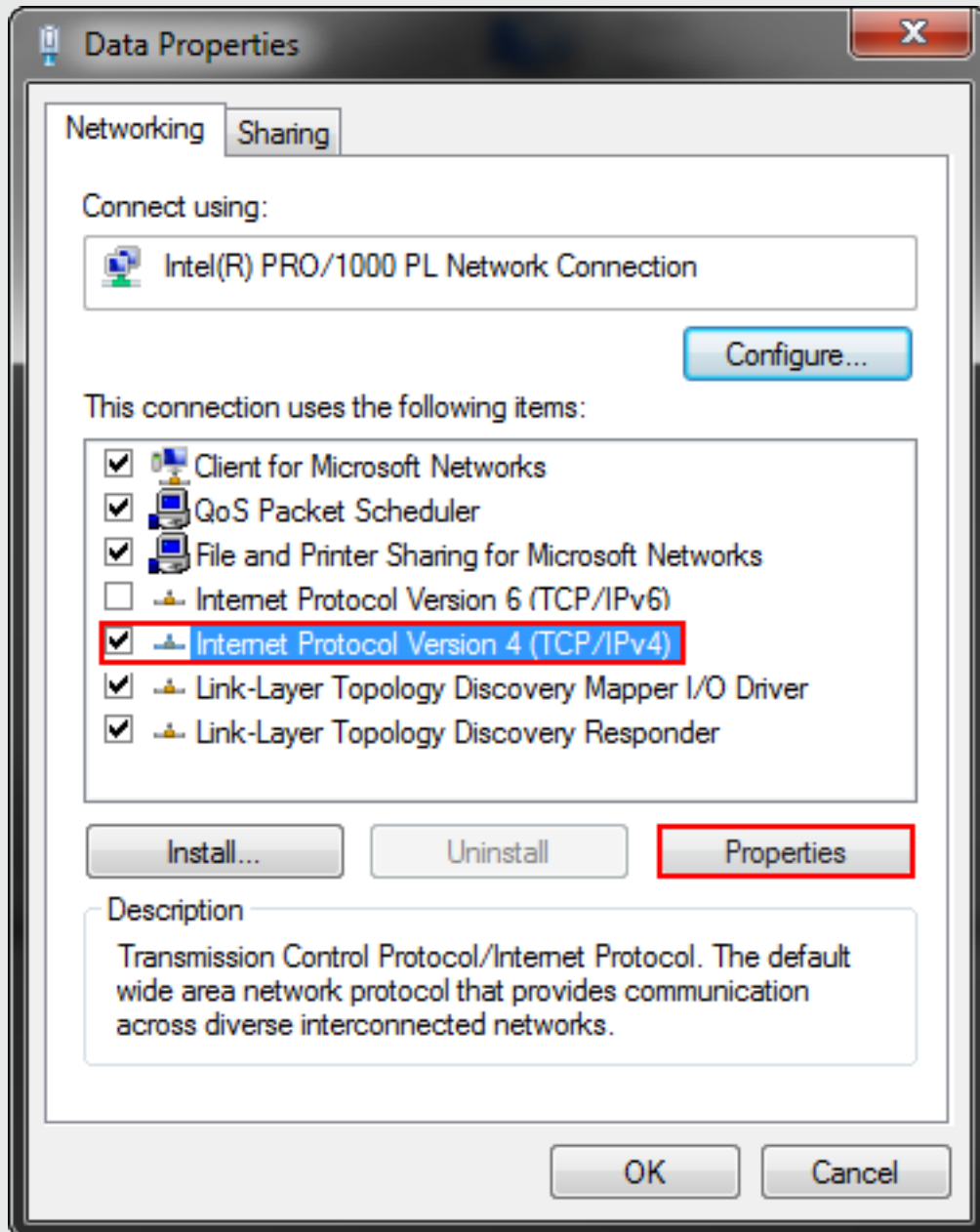

6. Select **Use the following IP Address** and use something appropriate, like 10.0.0.1 or 192.168.0.1, and set the **Subnet Mask** to 255.255.255.0.



7. Make sure to keep all Disguise machines on the same range, for example 10.0.0.xxx or 192.168.0.xxx, where xxx is any number from 1-254.
8. Leave the DNS server fields blank.

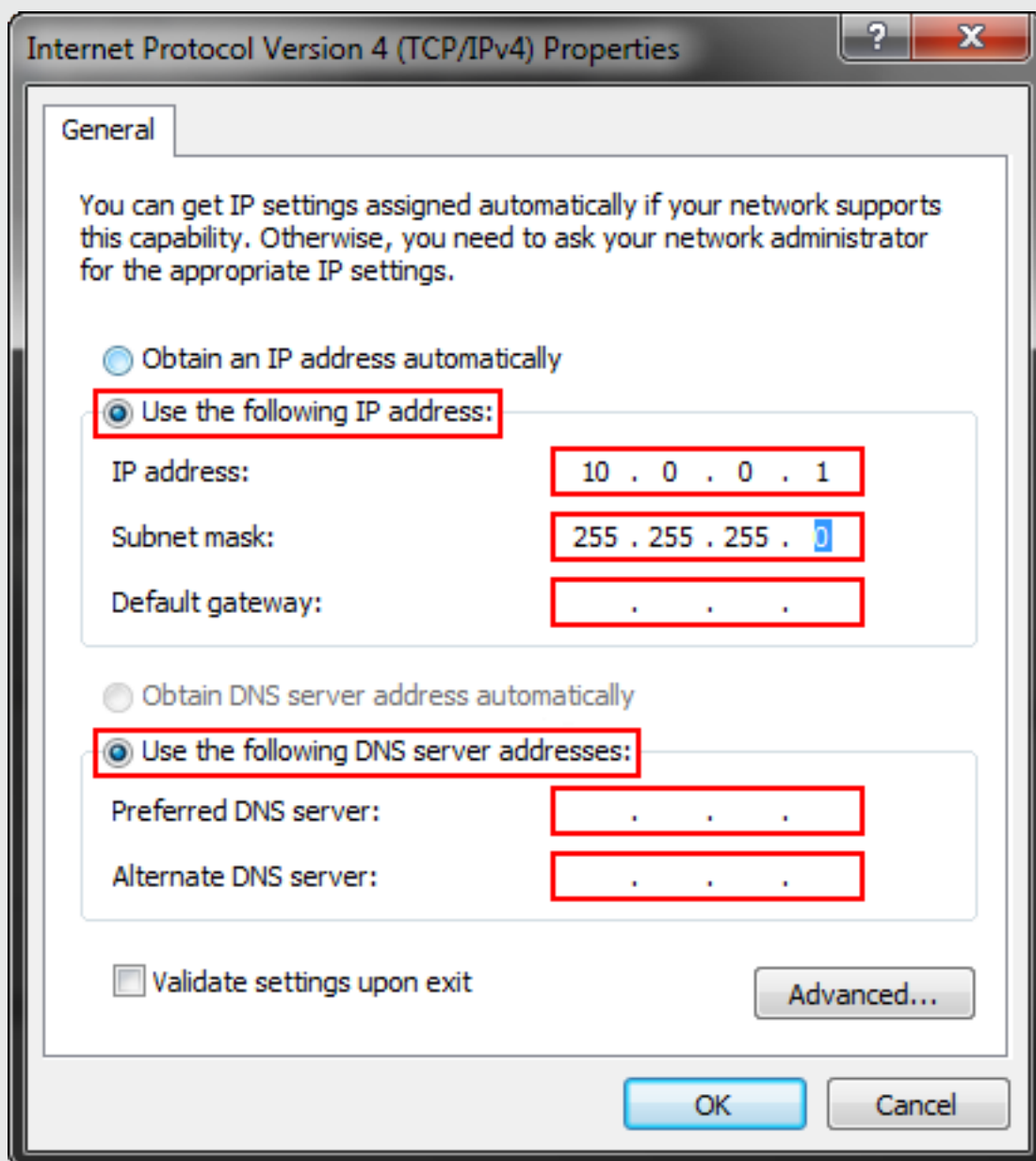

# Set up sharing

Set the same time, date and timezone to all machines in the network. To do this:

1. Open the Date and Time window (Start menu > **Control Panel** > **Date and Time** ).
2. Select **Change date and time** to open the Date and Time Settings window, adjust the date and time accordingly and select **OK** .

It may be useful to rename all computer names to what they represent in the Director/Actor network. For example, Actor 1 may be outputting to projectors 1 to 4 and should have a computer name **Actor 1** . In addition, all computers should be set to the same Workgroup.

3. To change a computer's name and workgroup open the System Properties window (Start menu

> **Control Panel** > **System** > **Change settings** )

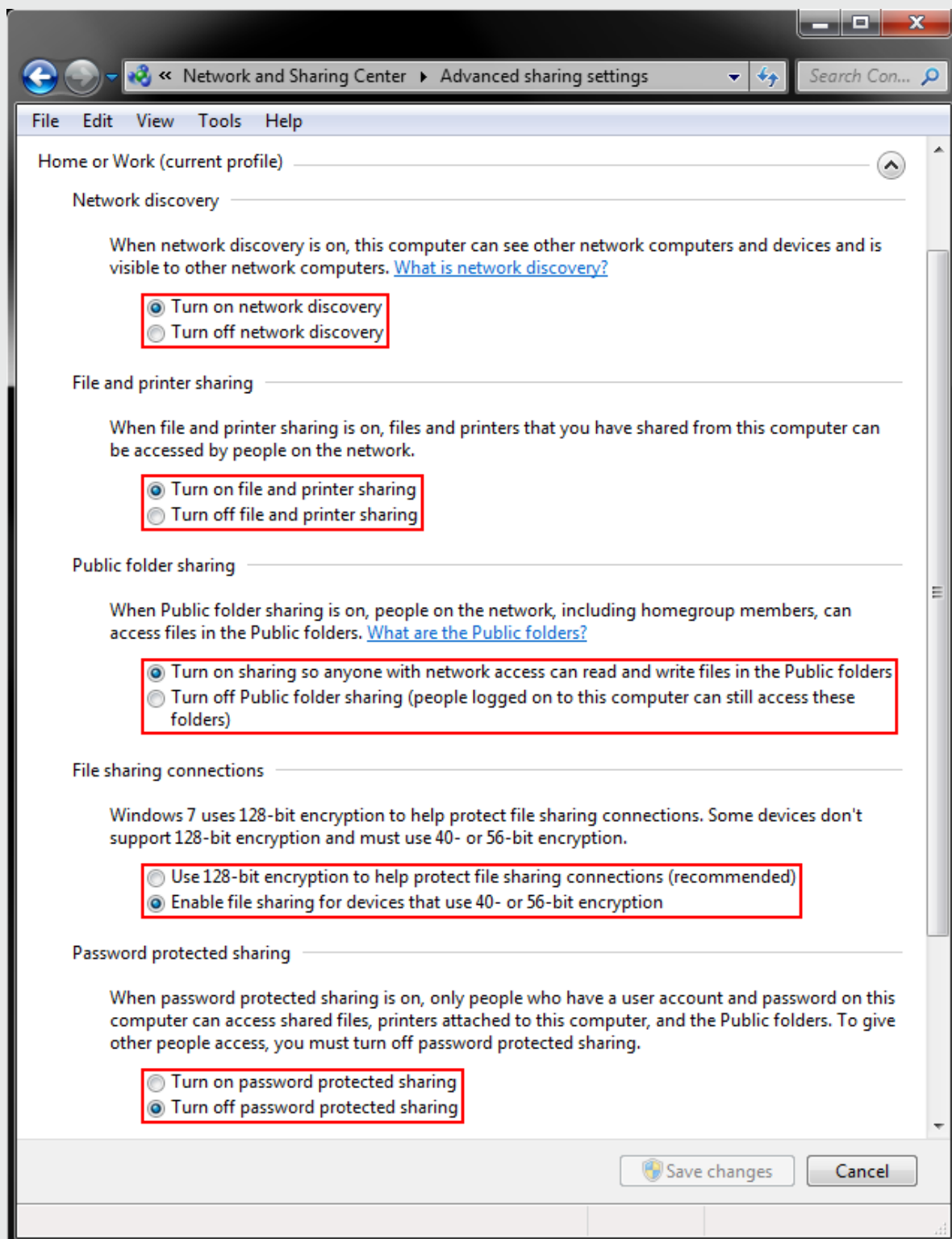

System Properties window is used to change the computers name and workgroup

In addition, the computer's sharing settings should be configured. To do this:

1. Open the Network and Sharing center (**Start menu > Control Panel > Network and Sharing Center** ).
2. Select **Change Advanced Sharing Settings** .
3. Change the settings to those shown below and select **Save changes** .

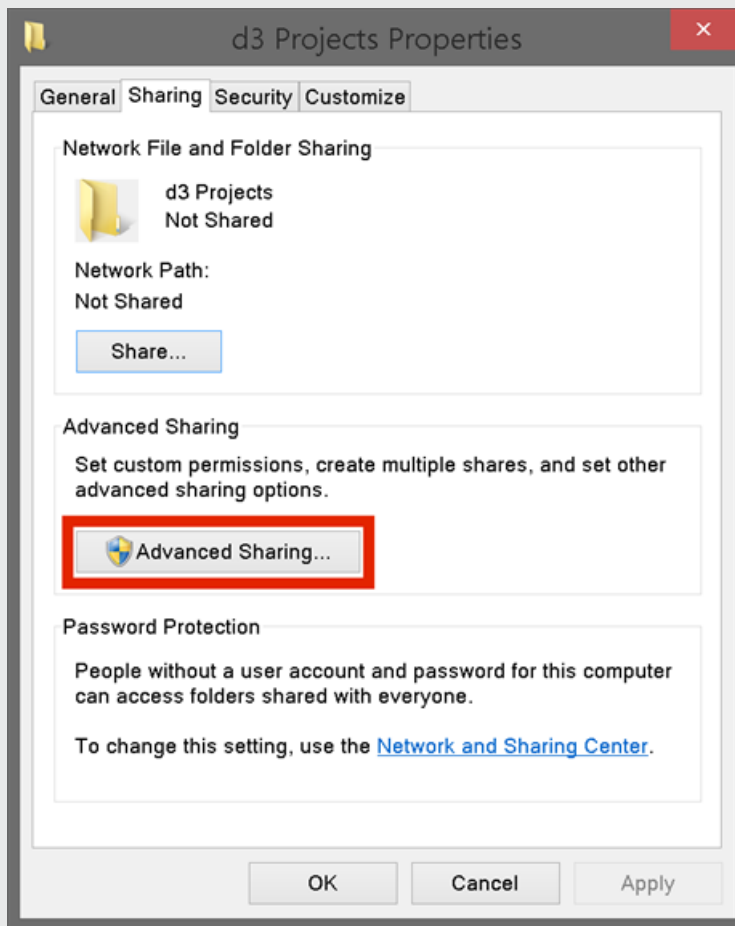

## Share folders

It is very important that the specific Disguise Project folder is shared with the other computers on the network. To do this:

1. Open the File Sharing window by right-clicking the specific Project folder and selecting **Properties > Sharing > Advanced Sharing**. For information on where the specific Project folder is located please see the sub-chapter [Projects location](#).
2. Set the Permission Level of the users **d3** , **Everyone** and **Guest** to **Read/Write** .
3. Right-click the d3 Projects folder and select properties from the context menu.

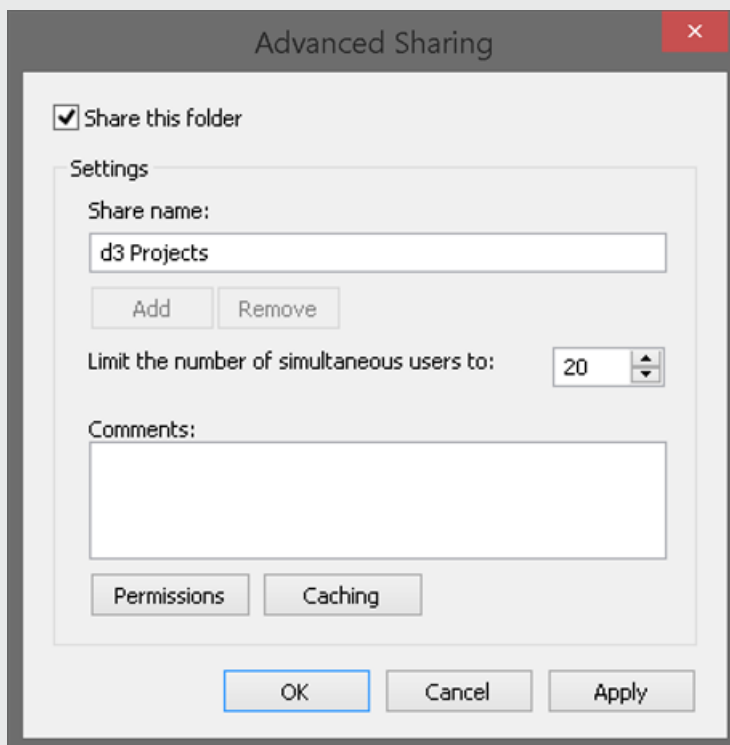

4. Click the Advanced Sharing... under the sharing tab.

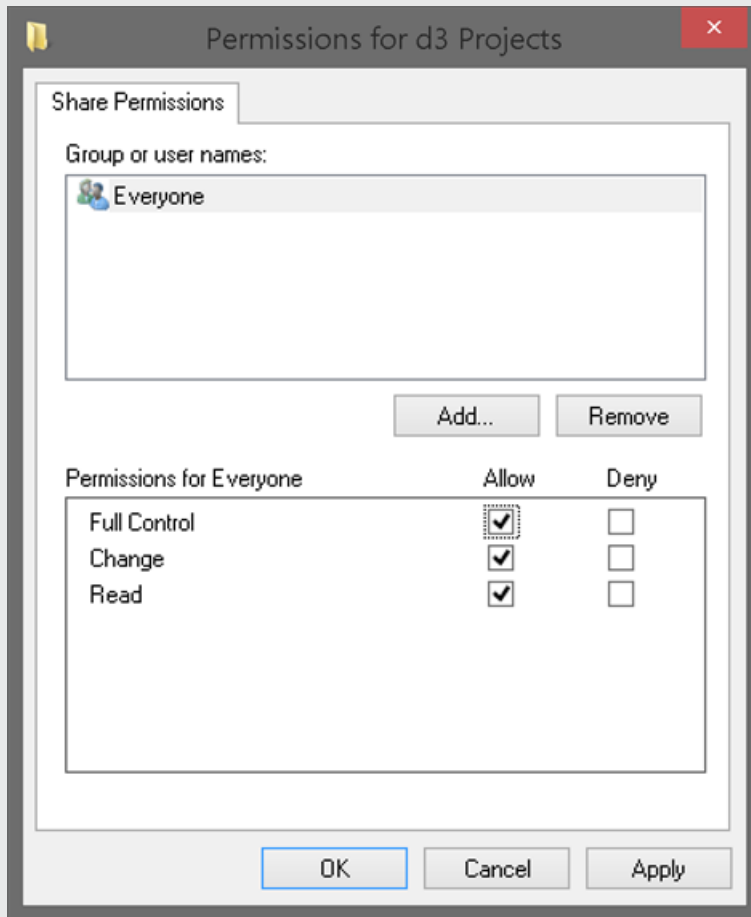

5. Tick the **Share this folder** box and set an appropriate share name.
6. Ensure sharing permissions are set to Read/Write for the users which have access. Please add a dedicated user if you want more granular control.

## Network settings

Please ensure that the HomeGroup of the computers is set to the same network. This will make it easier when using a Director/Actor configuration, as it will enable files to be shared between the computers on the network.

To change the HomeGroup:

1. Open the Network and Sharing center (Start menu > **Control Panel** > **Network and Sharing Center** ).
2. Select **HomeGroup** (bottom left corner of screen) > **What is a network location?** > **Work network**.

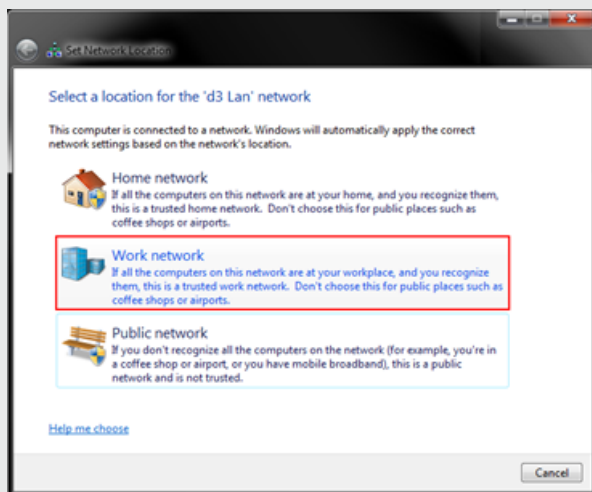

3. Ensure that the computers are set to the same network

## Verify connections

The Windows Command Prompt can be used to check the connections of the machines. To check the connections:

1. Open the Windows Command Prompt by selecting the Start menu (bottom left corner of screen), typing **cmd** into the text field, and selecting **cmd.exe** .
2. Use one of the Disguise machines, preferably the Director machine, to verify that all of the machines are responding by typing in a prompt according to the format:

```
ping [space] IPAddress
```

for example



```
ping 10.0.0.65
```

3. Hit Enter .
4. If the machines are responding correctly, the line **Reply from 'IP address: bytes=32** etc will appear. If there is an error, it will prompt **Request timed out** .

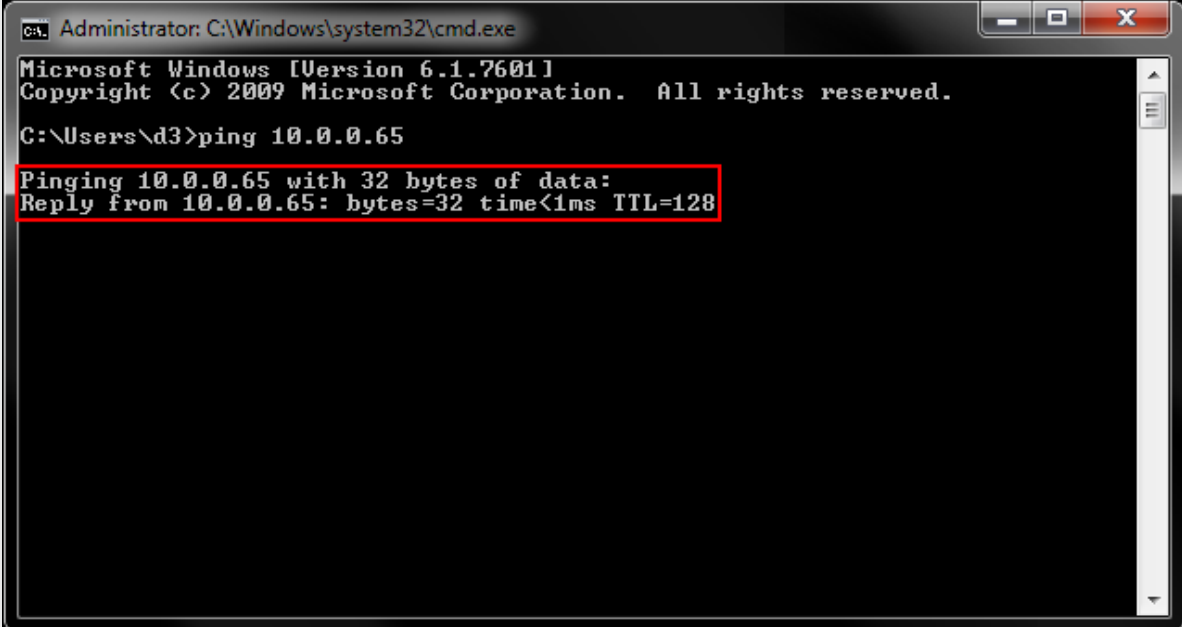
A screenshot of a Windows command prompt window titled "Administrator: C:\Windows\system32\cmd.exe". The window shows the following text: "Microsoft Windows [Version 6.1.7601] Copyright (c) 2009 Microsoft Corporation. All rights reserved. C:\Users\d3>ping 10.0.0.65". The output of the command is highlighted with a red box: "Pinging 10.0.0.65 with 32 bytes of data: Reply from 10.0.0.65: bytes=32 time<1ms TTL=128".

```
Administrator: C:\Windows\system32\cmd.exe
Microsoft Windows [Version 6.1.7601]
Copyright (c) 2009 Microsoft Corporation. All rights reserved.
C:\Users\d3>ping 10.0.0.65
Pinging 10.0.0.65 with 32 bytes of data:
Reply from 10.0.0.65: bytes=32 time<1ms TTL=128
```

5. On the Director machine type Ping followed by its IP address and hit Enter, if the machines are responding the reply line as shown in this example will appear
6. To check the current machines IP address type `ipconfig/all` and hit Enter.

**Please note:** If using a Mac/OS X, you may access the shared folders on another machine by using the hotkey combination CMD+K and then typing in the connection server address using this syntax:

```
smb://Guest:@<d3_server_name>/d3 Projects
```

# Create shortcuts

1. Use the Director machine to access the specific Project folder for all of the Actor and understudy machines. For information on where the specific Project folder is located please see the sub-chapter [Projects location](#).
2. Create a shortcut of the specific Project folder onto the Director machines desktop, clearly labelled with the project name and machine function. An example of a short-cut name would be **MyProject on Actor 11** and **MyProject on Understudy**.
3. Repeat the process for all of the Actor machines in the network, i.e. create a shortcut to the Director machines specific Project folder onto the desktop of every Actor machine. A quick way to access the machines in the local network is by selecting the Windows Start menu and typing in the machines IP address into the text field and hitting **Enter** .
4. On the machines desktop, remove all of the icons that are not needed. Ideally, the only icons showing will be the machine name at the top left and the Windows bin (which cannot be removed). You may also want to create a custom background to the Directors desktop to highlight all of the shortcut folders.
5. Set the desktop background of all of the Actor to black, showing no Disguise logo at least during show-time.

# Educational license

Disguise can work with educational establishments to provide an educational license.

This works by placing the license on a networked host which then validates a defined number of seats, thus removing the need for supplying, overseeing and managing a number of physical dongles for the student population

For further information please [contact sales](#).



**Warning:** Launching Disguise software without this initial networking setup will report a lack of license on the client machines and not run. Once successfully setup as above, Disguise software will launch correctly on the machines permitted in the procedure outlined here.

## Setting up the educational license

The following assumes:

- a connected network with machines connected and able to ping each other
- Designer installed on each machine. The latest version can be downloaded [here](#)

The educational license is supplied on a [Designer dongle](#).

Once inserted into the host machine -

1. On the host, access the WebAdmin control panel from the CmContainer in the System Tray

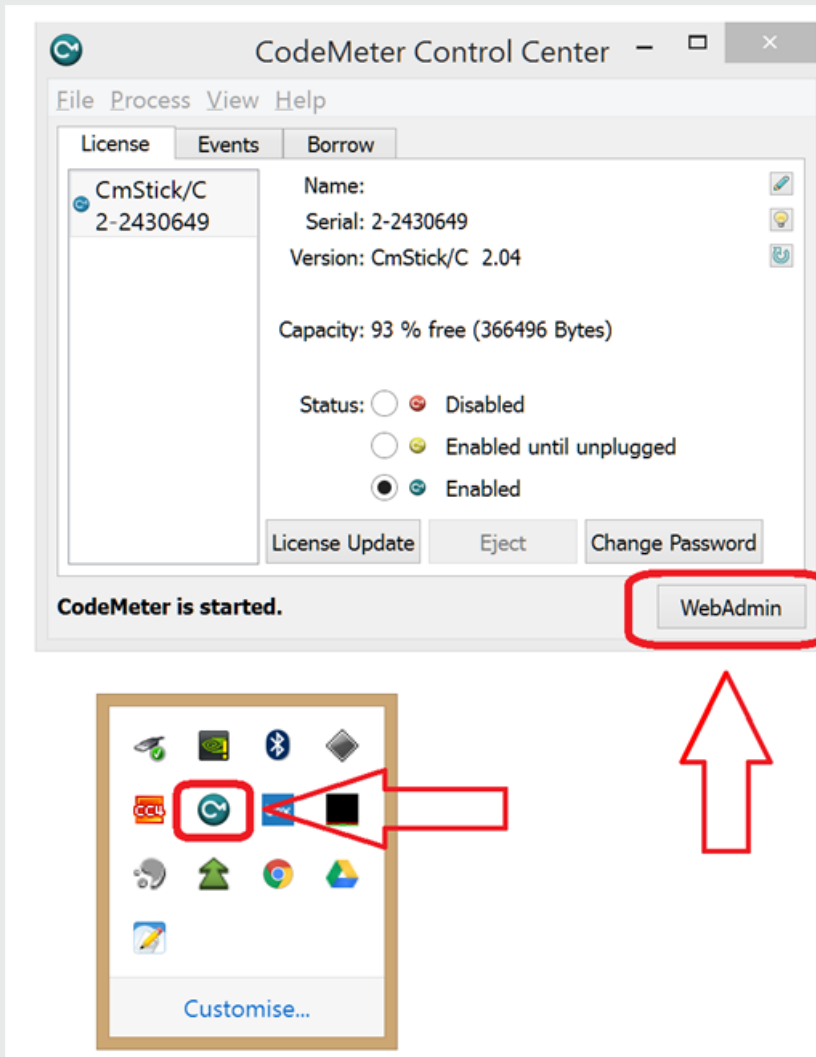

This WebAdmin panel can also be accessed by selecting localhost:22350 in your browser

2. Make the license available through Configuration> Server >ServerAccess, select the check boxes and Apply

The screenshot shows the CodeMeter WebAdmin interface. At the top, there is a navigation bar with tabs for Home, Content, Server, Configuration, Diagnosis, Info, and Help. Below this is a sub-menu for the Server section, including Network, Server, Proxy, Access Control, Certified Time, WebAdmin, Backup, and Borrowing. The main content area is titled "Server" and contains the following configuration options:

- Bind Address: All (Default)
- Run Network Server:
- Network Port \*: 22350
- Run CmWAN Server:
- CmWAN Port \*: 22351

At the bottom of the configuration area, there are two buttons: "Apply" and "Default". Below the buttons, a note states: "(\*) Changes only take effect after restarting CodeMeter".

3. Client side settings

All clients on the local network should find the server automatically. Should this not work (for example your server is in a different subnet, or you are connecting remotely through the Internet) then you may need to specify the server's hostname or IP address on the client:

- a. open WebAdmin
- b. Configuration > Basic > Server Search List
- c. add the host server to the Server Search List

This field may have multiple entries and the client searches for available licenses in the presented order. It only searches for the specified server if the list is populated.

## Access Control

With the default settings all computers on the same local network (same subnet) may use a license from the server. Should you wish to restrict access:

1. Open WebAdmin
2. Navigate to License Monitoring > Sessions
3. Select the CmContainer with the Education license
4. View Borrowed Licenses



The screenshot displays the CodeMeter WebAdmin interface. At the top, the title "CodeMeter WebAdmin" is shown next to the CodeMeter logo. Below the title is a navigation menu with tabs for Home, Content, Server, Configuration, Diagnosis, Info, and Help. Under the Configuration tab, there is a sub-menu with links for Network, Server, Proxy, Access Control, Certified Time, WebAdmin, Backup, and Borrowing. The main content area shows the "Access Control Mode" section, where "Basic" is selected with a radio button. Below this, it states "CodeMeter Server is running in **Basic** Access Mode." A "Clients" list is shown in a dropdown menu, containing "localhost" and "NW\_Mac\_Win81". Below the list are "add" and "remove" buttons. The "Access FSB" section has a checked checkbox labeled "enabled". At the bottom of the section are "Apply", "Undo changes", and "Default" buttons. A note at the very bottom states "Changes only take effect after restarting CodeMeter."

Where the Clients' list is empty, anyone on the local network can use a license.

Where at least one entry is specified, only the specified entry(s) will be granted a license.

**Please note:** If the server is public or you wish to restrict access then ensure that this list is populated correctly to avoid unwanted license usage.

## Usage monitoring

To see who is using a license:

1. open WebAdmin on the host server
2. navigate to Server> User tab  
which will enumerate the current client usage.

## Confirming the network license has been applied

To see whether your networked license has been applied correctly you can check:

- on the Host's WebAdmin control panel> Server> Cluster> Details will itemise those machines connected
- on the client machine's WebAdmin control panel> Content> Licenses will report the license correctly. (If not applied, it will simply state that no CmContainer is found.)

# Devices Index

Devices in Disguise software represent external devices that connect to the software, either for signal input or output.

The list of devices that can be created within Disguise software are:





— [Agile Camera](#)

— [Analog Way OPS300](#)

— [Audio Analyser](#)

- [Barco Encore](#)
- [Barco Matrix Pro](#)
- [BlackMagic VideoHub Matrix](#)
- [CITP Device](#)
- [DMX Device](#)
- [DMX Machine Control](#)
- [DMX Projector Control Device](#)
- Folsom Matrix Pro 16x16
- GVG Matrix
- Gefen Matrix
- [JSON Machine Control Device](#)
- [Lightware Matrix](#)
- Lightware Matrix LW3
- [MediorNet Matrix](#)
- [MIDI Device](#)
- [OSC Device](#)
- [OSC Machine Control](#)
- [OSC Tester](#)
- [Position Receiver](#)
- Projector Calibrator Device
- [PureLink Matrix](#)
- Serial Device
- [Shot Recorder](#)
- [String Projector Control Device](#)

- Telnet Device
- Telnet Matrix
- UDP Device
- Visca Camera

# Devices Index

Devices in Disguise software represent external devices that connect to the software, either for signal input or output.

The list of devices that can be created within Disguise software are:



— [Agile Camera](#)

— [Analog Way OPS300](#)

— [Audio Analyser](#)

- [Barco Encore](#)
- [Barco Matrix Pro](#)
- [BlackMagic VideoHub Matrix](#)
- [CITP Device](#)
- [DMX Device](#)
- [DMX Machine Control](#)
- [DMX Projector Control Device](#)
- Folsom Matrix Pro 16x16
- GVG Matrix
- Gefen Matrix
- [JSON Machine Control Device](#)
- [Lightware Matrix](#)
- Lightware Matrix LW3
- [MediorNet Matrix](#)
- [MIDI Device](#)
- [OSC Device](#)
- [OSC Machine Control](#)
- [OSC Tester](#)
- [Position Receiver](#)
- Projector Calibrator Device
- [PureLink Matrix](#)
- Serial Device
- [Shot Recorder](#)
- [String Projector Control Device](#)

- Telnet Device
- Telnet Matrix
- UDP Device
- Visca Camera

# Creating devices

## Creating a new device

1. Right-click **devices** from the dashboard. This will open the Device Manager, which contains a list of active devices.
2. Select **+** to open the Device library. This lists which internal or external devices are available.
3. Type in the name of the new device into the **new device** text field.
4. Hit **Enter**. This will open a list of device types available in Disguise software.
5. Select the appropriate device type.

The new device will be added to the Device Manager's active device list, and to the Device library. The device's editor will also open.





**Please note:** Always right-click on the **default** device object to add devices to it. If left-clicking you will be prompted to create a whole new device manager which is rarely required.

# Motion control systems

## Overview

Disguise has the ability to receive positional data from various motion control systems using the PositionReceiver Device. This data can be used to animate screens or props within the Stage level. This device will be the main interface between Disguise and the various motion control systems that are currently supported. It is possible to have multiple PositionReceiver Device devices. Depending on the system used objects in a stage can be moved and rotated in all three axes, matching the real world positions of the actual objects. This provides an accurate toolkit for previsualising a project.

## Components of a motion control system

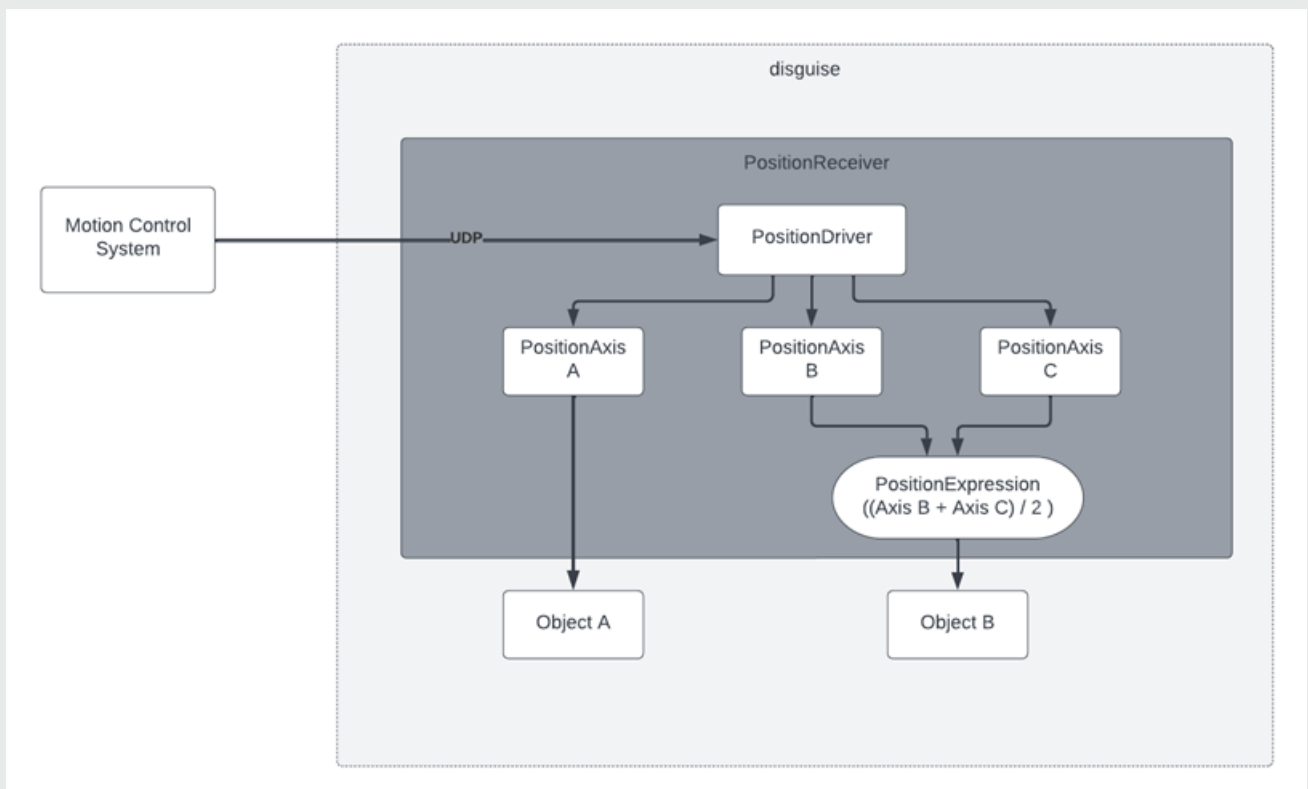

Diagram illustrating the flow of data from a motion control system to objects in Disguise

*Diagram illustrating the flow of data from a motion control system to screens/props in Disguise*

The motion control system sends data over the network (via UDP).

1. The system receives the data and passes it to the PositionReceiver Device and onto the PositionDriver.
2. The PositionDriver decodes the data and passes it onto the PositionAxis objects.
3. The PositionAxis , named 'A', sends the position straight to the defined parameter of Screen / Prop A .
4. The PositionExpression takes the values from both axes, 'B' and 'C', and evaluates it using the expression  $((\text{Axis B} + \text{Axis C}) / 2)$  and sends the result to the defined parameter of Screen / Prop B .

# Axes

The Axes section of the PositionReceiver Device editor is used to create PositionAxis objects which control the movement of individual screens or props along each axis.

Axes are discrete objects themselves, but can be automatically created by reading the axis data the automation system is sending to Disguise software.

## Example

### Creating PositionAxis objects

To create a PositionAxis object:

- Select the **+** button within the **Axes** section of the PositionReceiver Device editor, type the name of the new object into the text field and hit **Enter**.

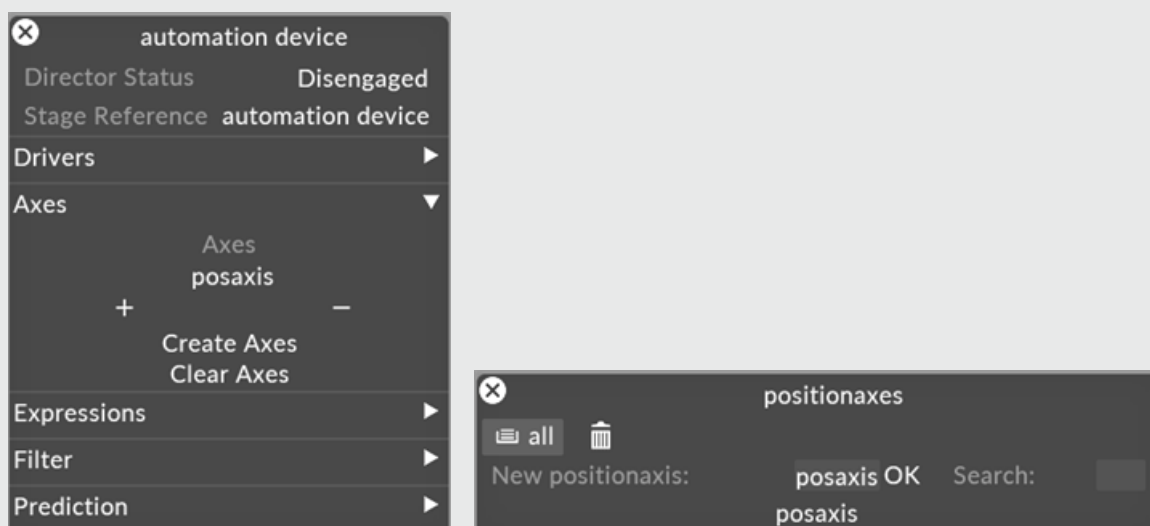

Or alternatively;

- Click the **Create Axes** button to automatically read the incoming axes from the Automation driver.

## PositionAxis properties

# Configuration

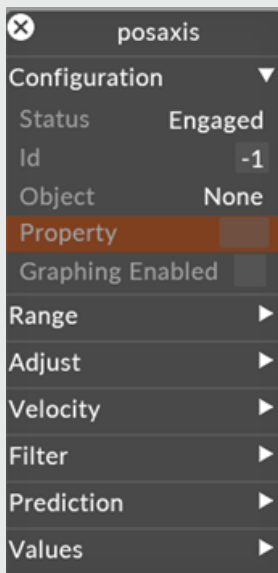

## Status

Axis 'Engage' and 'Disengage' options. Allows the user to allow/disallow stage objects being updated in the visualiser. Can also be used during calibration to prevent automation data passing through to the stage objects.

# ID

The unique identifier for the axis normally being sent by the automation system. In r14.2 onwards you shouldn't have to edit this field.

# Object

The Screen that the automation is affecting, ie Surface 1.

# Property

Which property of the stage object will be automated. E.g. **offset.x**, **offset.y**, **offset.z**, **rotation.x**, **rotation.y**, **rotation.z**.

# Graphing Enabled

Allows the user to switch on/ off the graphing/ monitoring of incoming packet data (position/ velocity) and filtered position data.

# Range

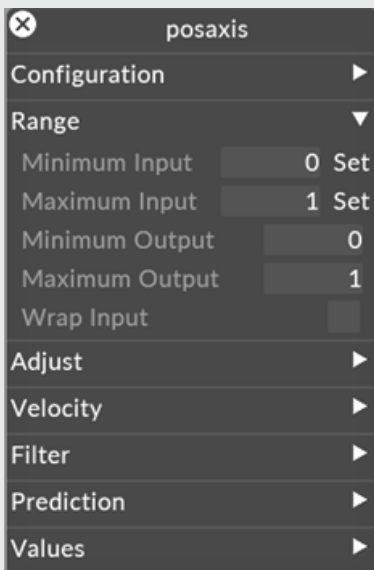

# Minimum/Maximum Input

Maximum/ Minimum Input: Set the Min and Max Input in Disguise software to the real world values coming into the software from the automation system. The set button for Maximum and Minimum Input fields can be used to mark the in and out positions (range) of the automated object. This will reference the current Input Value and therefore when pressed it will paste the current input value into the field. Therefore, making it easier to set these values. Disguise software works in metres and degrees so the user should set appropriate scaling if the received values are not in metres.

# Minimum/Maximum Output

The Minimum and Maximum Output fields allow the user to scale the input range to a local range in the visualiser.

# Wrap Input

Wrap input allows the user to specify that the automated object has rotary motion and the data will wrap. For example, a revolve going from 0-359 and wrapping back to 0.

# Filter

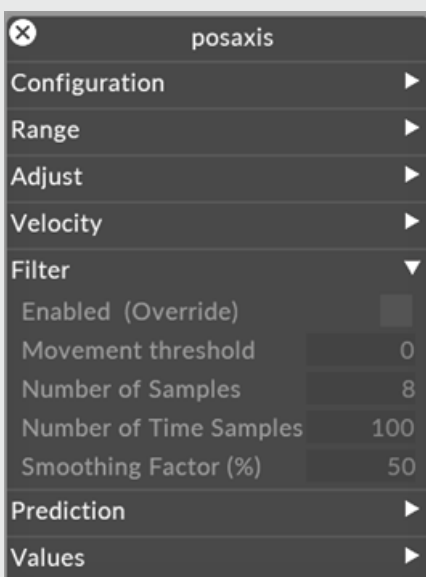

## Enabled (override)

Default - Off

When switched on, filter parameters override the parent devices parameters.

## Movement threshold

Minimum change needed before updating output value. This helps when data has unwanted movement when intended to be static. 0 means no threshold (disabled).

## Number of samples

Number of samples to filter. Use 0 to disable. More samples will introduce higher latency with more smoothing effect. Fewer samples will introduce less latency with less smoothing effect.

## Number of time samples

Number of time samples to filter. Use 0 to disable. More samples will introduce higher latency with more smoothing effect. Fewer samples will introduce less latency with less smoothing effect.

## Smoothing factor

Smoothing factor %. Higher values will smooth the data more but will increase latency and therefore the need for prediction

## Velocity



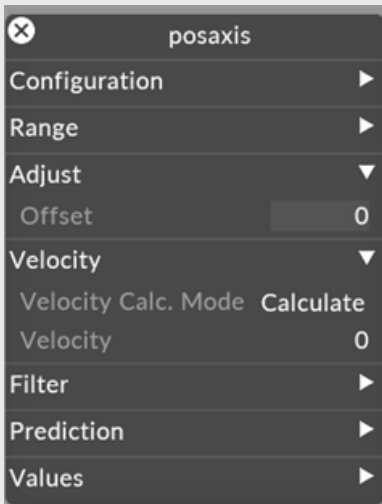

## Velocity Calc Mode

This is for prediction and determines the method for calculating the speed between samples within Disguise software in order to predict the position ahead of time. When in Calculate mode, Disguise will calculate the speed between the latest and previous packet. When From Packet is selected, the speed information should be received within the packet itself.

**Please note:** Note that the velocity units will be calculated/ received in the units in which the source is sending position and/ or velocity. E.g. If the source is sending position/ velocity in mm/s<sup>2</sup> then the velocity is calculated in mm/s<sup>2</sup> or when From Packet is selected, the velocity received would be in mm/s<sup>2</sup>. Therefore, any scaling (min/ max values for input/ output) is applied after the velocity prediction step. The scaling is used in order to scale input values into metres which is what Disguise uses. Disabled sets velocity to 0 and consequently turns prediction off.

## Velocity

Updates only when in Calculated or From Packet modes and displays the velocity that is being calculated/ received from the automation system for the axis.

# Prediction

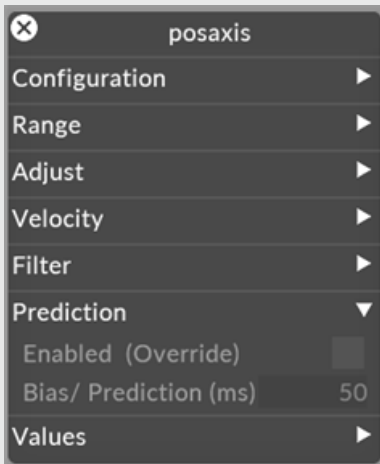

## Enabled (override)

When switched on, prediction uses the **bias** property to predict tracked positions at a future time.

## Bias/ Prediction (ms)

Compensate for time latency between received data and projector output. Use 0 to disable.

# Adjust

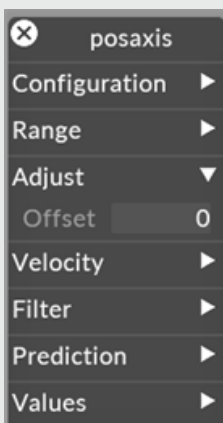

# Offset

Allows the user to offset the position of the object relative to the incoming position data.

# Values

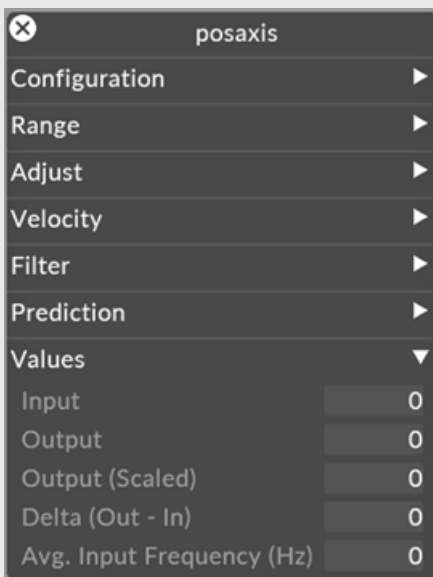

posaxis	
Configuration	▶
Range	▶
Adjust	▶
Velocity	▶
Filter	▶
Prediction	▶
Values	▼
Input	0
Output	0
Output (Scaled)	0
Delta (Out - In)	0
Avg. Input Frequency (Hz)	0

# Input

The values of the incoming data, from here one can determine the Min and Max Input of data.

# Output

The output including any prediction.

## Output Scaled

Scaled output velocity comparing the Input and Output levels.

## Delta (in - Out)

The difference between the incoming position data and output position data. For good output should be twitching between -0 and 0 value.

## Avg Input Frequency (hz)

The field displays the average frequency that automation data is being received for the axis. It's important to monitor this field and ensure that the rate is at least 30 Hz or higher and consistently at the rate specified by the automation system. I.e. avoid large swings/ fluctuations in the input frequency.

# Creating Driver Axes

Create Driver Axes is a function that allows an automation device to automatically detect what axes the connected device is sending data for and thus save the user from manually creating all of the axes for the automation system.

1. Once you successfully add & configure an automation device with its associated driver, clicking the Create Driver Axes button will show all the axes that automation driver is sending into Disguise software.

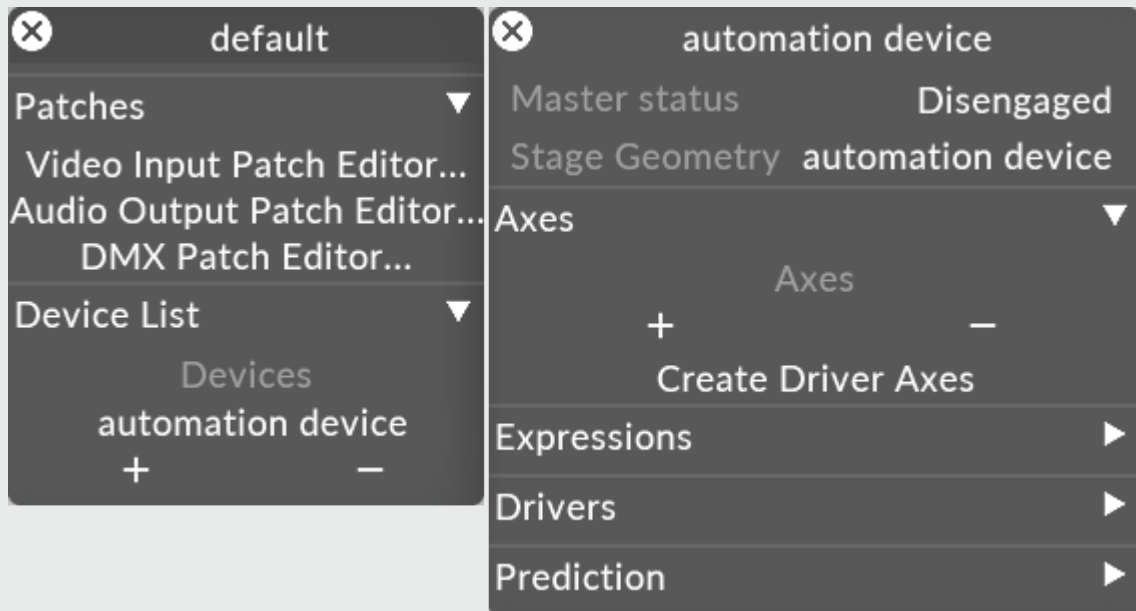

2. Right clicking an Axis allows you to link that Axis to an object, for example Surface 1 and then to assign it a property, for example 'Offset.x' so that surface 1 is linked to the x offset of that axis.

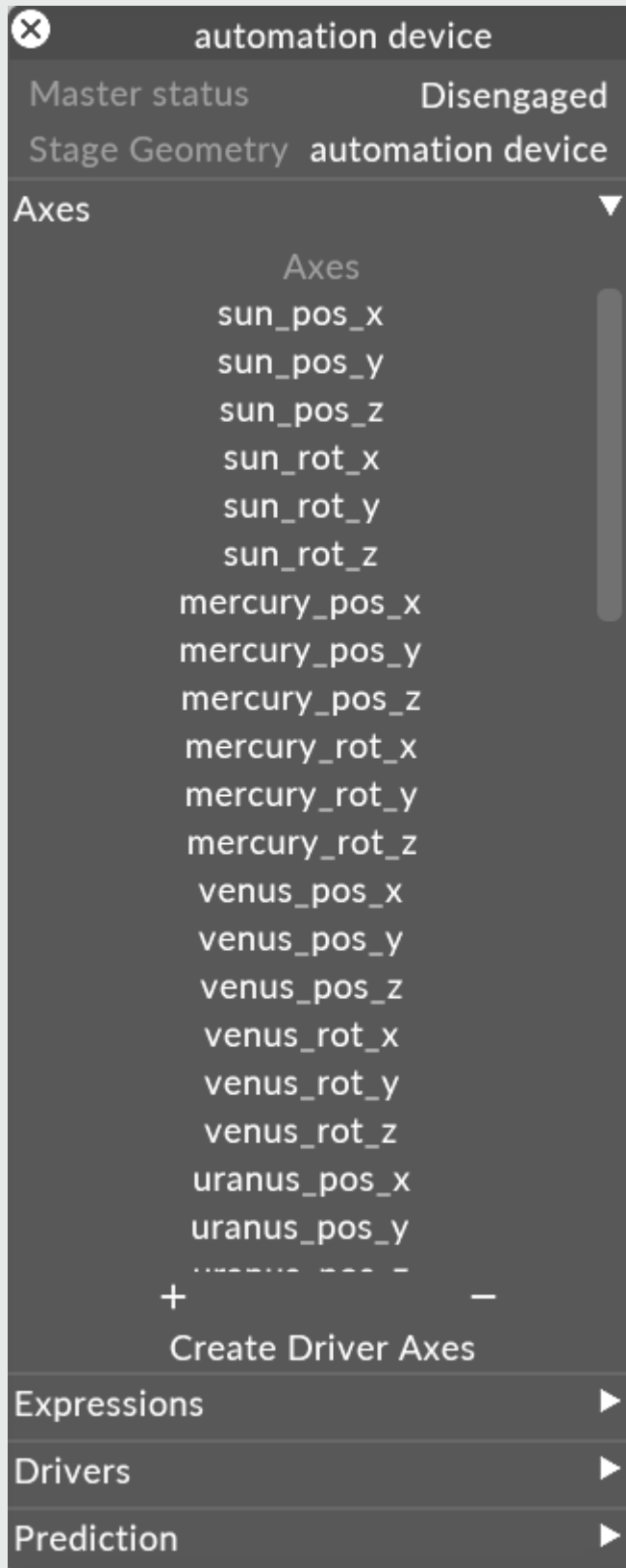

- Another piece of useful functionality, is the ability to set minimum & maximum inputs. For example, set the Automation system to the minimum point of reference, press **Set**, Disguise will

read that value and input it for you, and repeat for the maximum.

**Please note:** Note that when an axis is controlled by a PositionReceiver Device that the PositionReceiver Device always defines the position, even when overridden.

# Screen Axis Expressions

Screen Axis Expressions can be used to perform arithmetic on values outputted from ScreenPositionAxis objects and sent to a property of a defined screen.

## Creating expressions

To create an expression:

- Select the **+** button within the **Expressions** section of the PositionReceiver editor, type the name of the new object into the text field, and hit **Enter**.

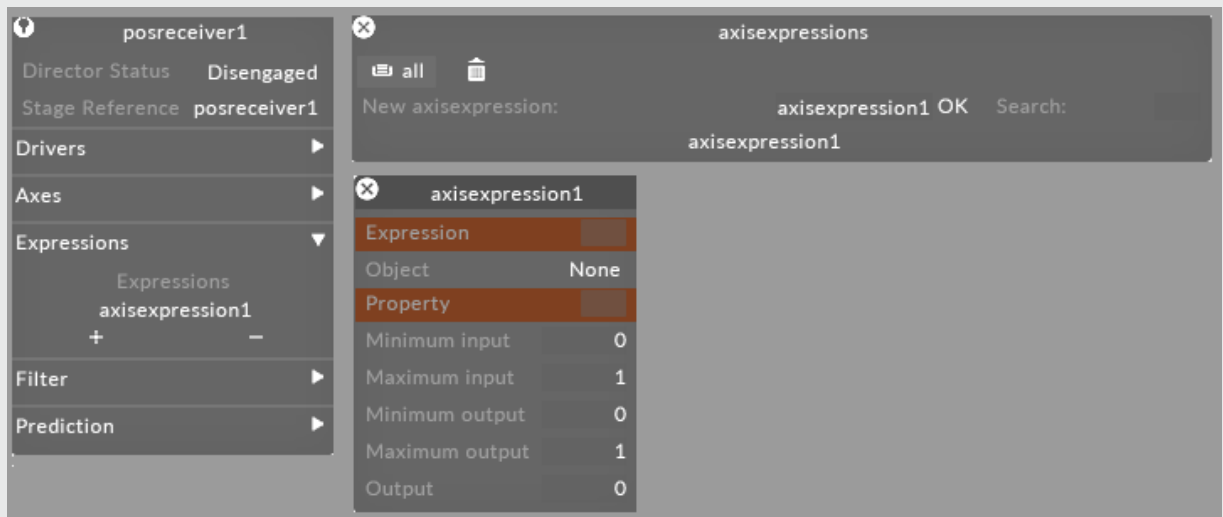

This will open the Expressions editor.



## Expressions properties

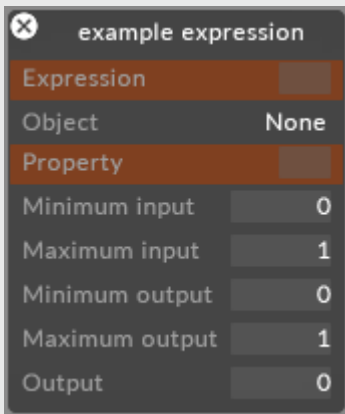

Expression editor is used to perform arithmetic on values outputted from `ScreenPositionAxis` objects to a property of a defined screen

## Expression

These are the arithmetic expressions performed on the defined axes. The `ScreenPositionAxis` objects are defined by their name. For example,

```
(ledscreenx*ledscreeny)/2
```

Where **ledscreenx** and **ledscreeny** are `ScreenPositionAxis` objects.

## Screen

The screen you want to move and rotate. You should leave the property field of the object blank if you want to use the output of the expression rather than the axis.

## Min input

The minimum input value that will be received from the `ScreenPositionAxis` objects.

## Max input

The maximum input value that will be received from the `ScreenPositionAxis` objects.

## Min output

The minimum output value of the defined property.

## Max output

The maximum output value of the defined property.

## Output

The current output value.

# CPS Driver

It is recommended that you use driver default settings, unless the system is configured differently.

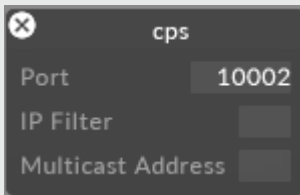

## Port

The port number the automation data is coming in on.

## IP Filter

The remote IP that the data is coming in on (optional).

## Multicast Address

The multicast address the data is coming from (optional).

# D3SSI Driver

It is recommended that you use driver default settings, unless the system is configured differently.

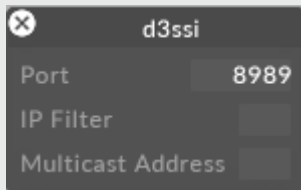

## Port

The port number the automation data is coming in on.

## IP Filter

The remote IP that the data is coming in on (optional).

## Multicast Address

The multicast address the data is coming from (optional).

# DMX Screen Position Driver

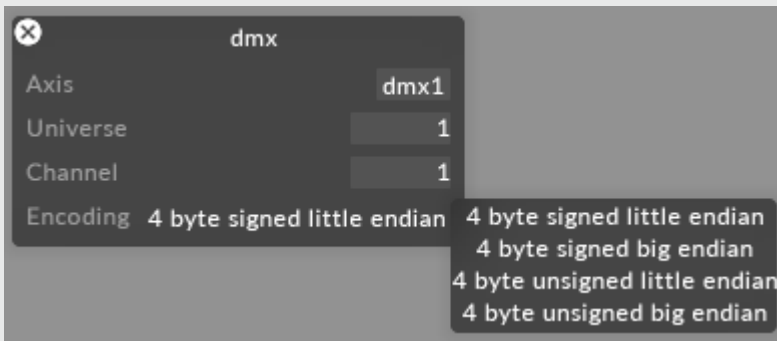

## Axis

User defined axis name.

## Universe

The universe address of the automation system.

## Channel

The channel address of the automation system.

## Encoding

4 byte signed little endian - signed int little endian (bytes read from right to left)

range = -2, 147, 483, 648 to 2, 147, 483, 647

4 byte signed big endian - signed int little endian (bytes read from left to right)

range = -2, 147, 483, 648 to 2, 147, 483, 647

4 byte unsigned little endian - unsigned little endian (bytes read from right to left)

range = 0 to 4, 294, 967, 295

4 byte signed big endian - unsigned big endian (bytes read from left to right)

range = 0 to 4, 294, 967, 295

# HMC Driver

It is recommended that you use driver default settings, unless the system is configured differently.

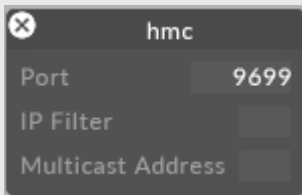

## Port

The port number the automation data is coming in on.

## IP Filter

The remote IP that the data is coming in on (optional).

## Multicast Address

The multicast address the data is coming from (optional).

# IPCUSB Driver

It is recommended that you use driver default settings, unless the system is configured differently.

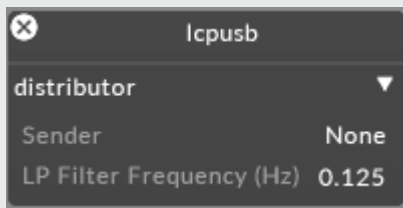

## Port

The port number the automation data is coming in on.

## IP Filter

The remote IP that the data is coming in on (optional).

## Multicast Address

The multicast address the data is coming from (optional).

# Kinesys Driver

Kinesys is a motion control system that provides six axes of freedom (x,y,z movement and x,y,z rotation). It sends data over the network to d3 via the UDP protocol.

Disguise software supports both Vector & K2 products.

Please note: make sure you are connected to the Kinesys system by network switch or direct. You are likely to experience problems if behind a router or firewall.

## Kinesys driver properties

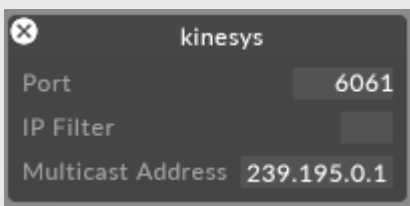

### Port

This is the UDP port used, normally 6061.

### IP Filter

This is the IP address the data is coming from. (Optional)

### Multicast address

This is the engine multicast address from the K2 software. (Optional)

Outside of d3, use the Kinesys K2 software to find the engine multicast address and parameter address . If you are familiar with the K2 software, please navigate to the following windows, or contact your Kinesys representative or operator.

The engine multicast address is the address that the K2 software will broadcast the positional data to and can be found in the red box shown below.

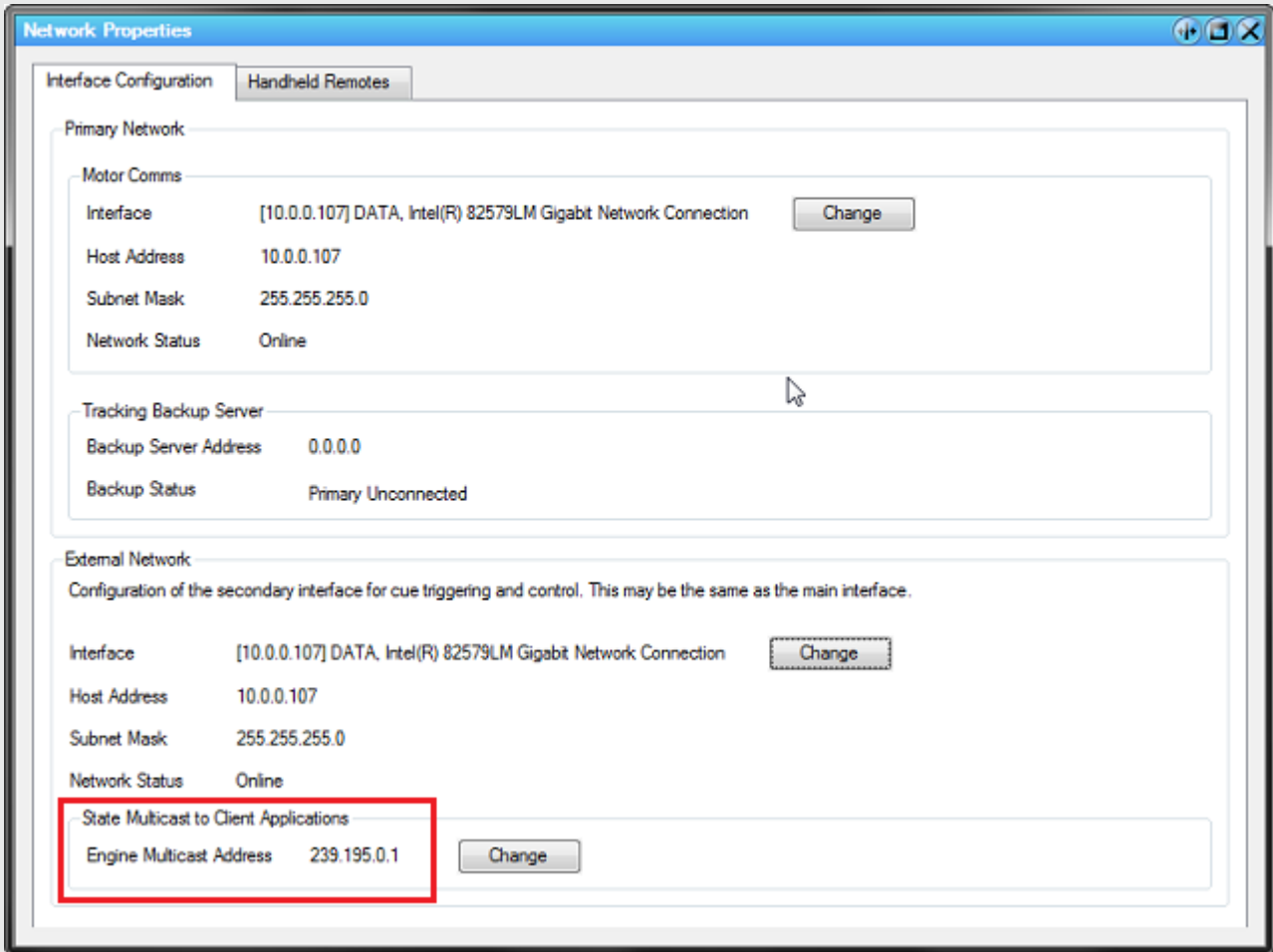

*Engine Multicast Address is situated in the red rectangle*

The parameter address for each construct parameter is the id tag for each set of data and can be found in the red box shown here.



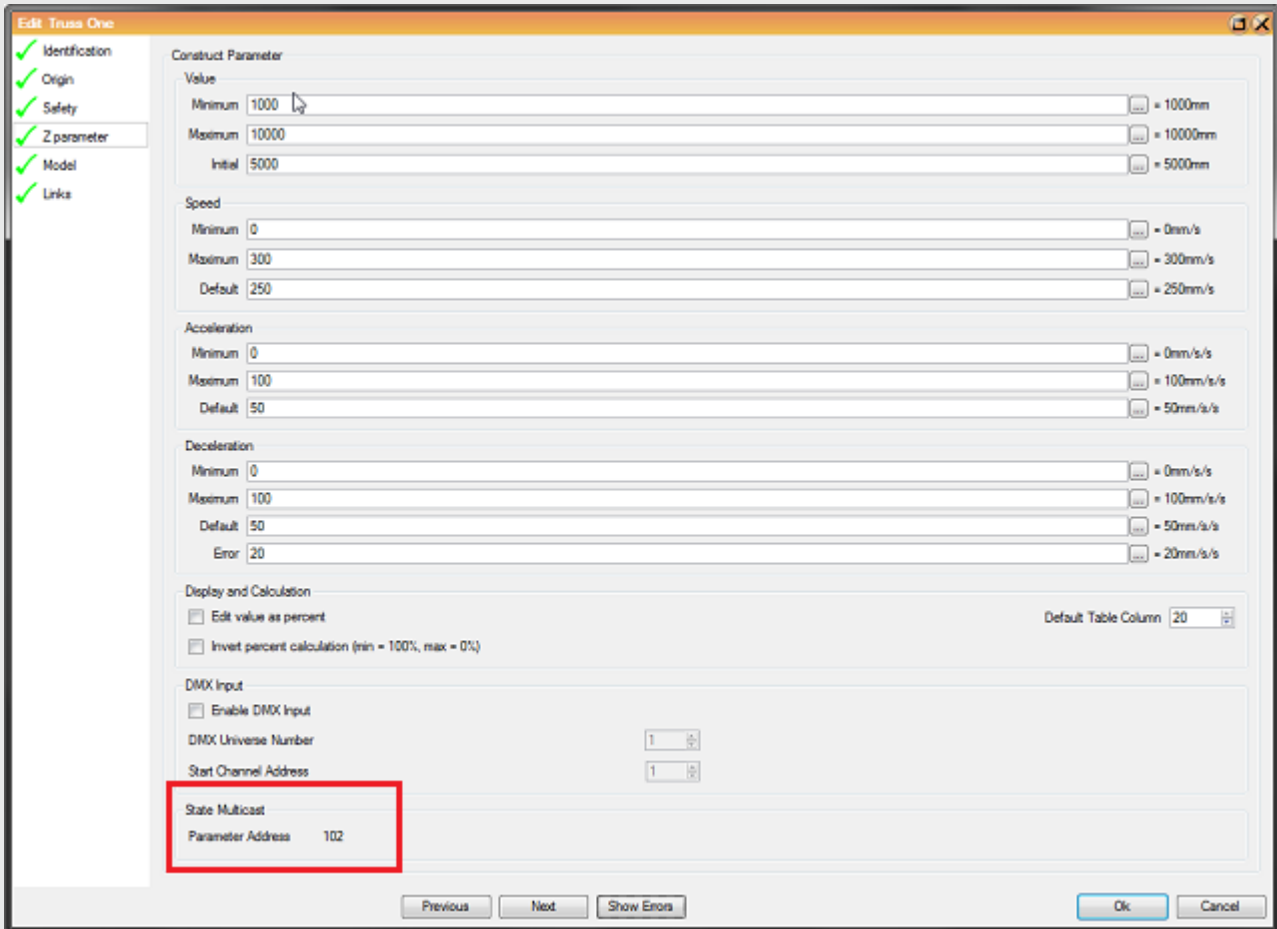

Parameter Address is situated in the red rectangle

- Type the correct engine multicast address value into the Multicast address text field of the Kinesys driver editor.
- Create a ScreenPositionAxis object for each axis of movement using the steps explained earlier in the Axes page. Insert the K2 parameter address into the ScreenPositionAxis id property text field.

# MoSys F4 Driver

It is recommended that you use driver default settings, unless the system is configured differently.

## Port

The port number the automation data is coming in on.

## IP Filter

The remote IP that the data is coming in on (optional).

## Multicast Address

The multicast address the data is coming from (optional).

# Movecat Driver

It is recommended that you use driver default settings, unless the system is configured differently.

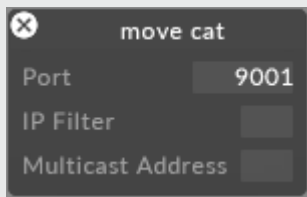

## Port

The port number the automation data is coming in on.

## IP Filter

The remote IP that the data is coming in on (optional).

## Multicast Address

The multicast address the data is coming from (optional).

# Navigator Driver

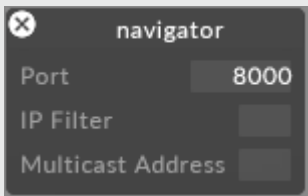

## Port

The port number the automation data is coming in on.

## IP Filter

The remote IP that the data is coming in on (optional).

## Multicast Address

The multicast address the data is coming from (optional).

## FTSI Navigator UDP Packet Format

D3 requires the Navigator system to send data in a specific format. Each axis should send data in the following format.

```
ID: POS, VELOCITY;
```

**ID** = Axis ID

**POS** = Axis position as a floating point number

**VELOCITY** = Axis velocity as a floating point number

## Example:

```
1:-24.034,1.323;
```

Multiple axes can be combined in the same message,

```
ID: POS, VELOCITY; ID: POS, VELOCITY; ID: POS, VELOCITY; . . . . .
```

```
1:-24.034,1.323;2:5.346,12.098;3:9.064,2.511;
```



**Warning:** a common error is to omit the last semi-colon in the sequence. This will cause the last quantity not to be received.

# NG360 Driver

It is recommended that you use driver default settings, unless the system is configured differently.

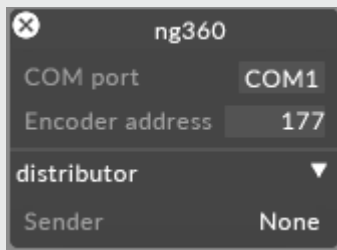

## Port

The port number the automation data is coming in on.

## IP Filter

The remote IP that the data is coming in on (optional).

## Multicast Address

The multicast address the data is coming from (optional).

# OSC Driver

It is recommended that you use driver default settings, unless the system is configured differently.

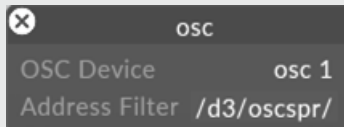

## OSC device

The OSC device that is sending the data.

## Address Filter

Enter the OSC address string (excluding the axis name), for which OSC messages will be received.

Leave this blank to receive all OSC data.

# Posi Stage Net Driver

It is recommended that you use driver default settings, unless the system is configured differently.

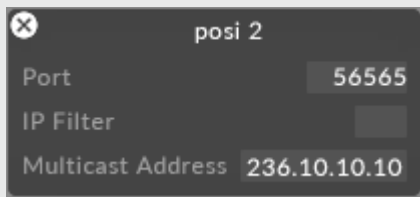

## Port

The port number the automation data is coming in on.

## IP Filter

The remote IP that the data is coming in on (optional).

## Multicast Address

The multicast address the data is coming from (optional).



# PRG Stage Command Driver

It is recommended that you use driver default settings, unless the system is configured differently.

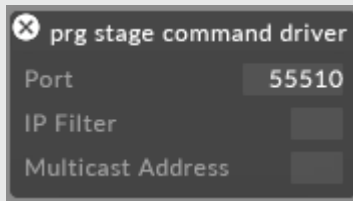

## Port

The port number the automation data is coming in on.

## IP Filter

The remote IP that the data is coming in on (optional).

## Multicast Address

The multicast address the data is coming from (optional).

# PRG Driver

It is recommended that you use driver default settings, unless the system is configured differently.

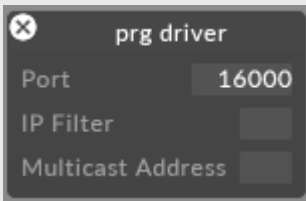

## Port

The port number the automation data is coming in on.

## IP Filter

The remote IP that the data is coming in on (optional).

## Multicast Address

The multicast address the data is coming from (optional).

# Simotion Driver

It is recommended that you use driver default settings, unless the system is configured differently.

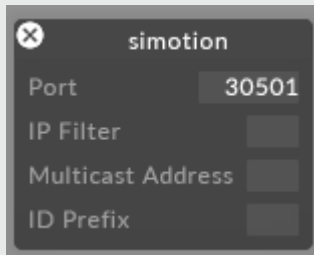

## Port

The port number the automation data is coming in on.

## IP Filter

The remote IP that the data is coming in on (optional).

## Multicast Address

The multicast address the data is coming from (optional).

# Stage Kinetics MoveCat driver

It is recommended that you use driver default settings, unless the system is configured differently.

## Port

The port number the automation data is coming in on.

## IP Filter

The remote IP that the data is coming in on (optional).

## Multicast Address

The multicast address the data is coming from (optional).

## Protocol version

The protocol version that the driver is using. Default is V2.

# STS Driver

It is recommended that you use driver default settings, unless the system is configured differently.

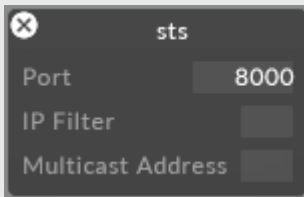

## Port

The port number the automation data is coming in on.

## IP Filter

The remote IP that the data is coming in on (optional).

## Multicast Address

The multicast address the data is coming from (optional).

# Stype Driver

It is recommended that you use driver default settings, unless the system is configured differently.

## Port

The port number the automation data is coming in on.

## IP Filter

The remote IP that the data is coming in on (optional).

## Multicast Address

The multicast address the data is coming from (optional).

# Unican Open Cue Driver

It is recommended that you use driver default settings, unless the system is configured differently.

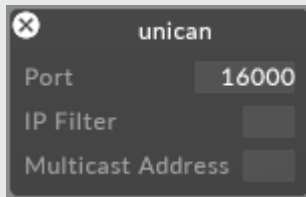

## Port

The port number the automation data is coming in on.

## IP Filter

The remote IP that the data is coming in on (optional).

## Multicast Address

The multicast address the data is coming from (optional).

# Visual Act Driver

It is recommended that you use driver default settings, unless the system is configured differently.

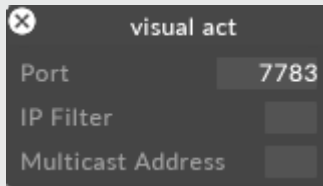

## Port

The port number the automation data is coming in on.

## IP Filter

The remote IP that the data is coming in on (optional).

## Multicast Address

The multicast address the data is coming from (optional).



# Audio analyser

The AudioAnalyser device enables the properties of an audio source to be controlled.

Before starting Disguise software ensure an audio source is connected to the line inputs on the RME breakout. Please see the Hardware sub-chapter [Audio breakout](#) for more information. Make sure that there is a good signal level.

## Setting up an audio device

1. Create an AudioAnalyser device. An AudioAnalyser device is created in the same way as any other device type. Please see the earlier sub-chapter [Creating devices](#) for step-by-step instructions on how to create a device, and select **AudioAnalyser** from the menu of different device types. This will open the AudioAnalyser devices menu which contains two audio lines. Alternatively, by default Disguise contains an AudioAnalyser device called **audio analyser**, which can be selected from the Devices manager.

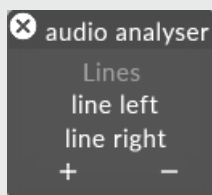

AudioAnalyser menu contains two audio lines

2. Right-click on an audio line, in this example **line left**, to open the audio line editor. The audio line editor is used to specify how the audio is to be inputted.
3. Open the audio device selection list by left-clicking the **line** property.

Audio device selection list is used to specify how the audio is to be inputted

4. Select an appropriate audio device from the audio device selection list. An audio spectrum should now be displayed.

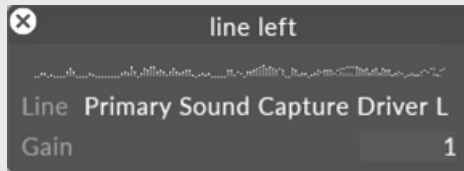

Audio spectrum should now be displayed for the audio device selected

5. To achieve an appropriate level it may be necessary to adjust the gain level. To adjust the gain level type a value into the **gain** text field.
6. To check the gain level left-click the audio spectrum; this will switch the display to an audio waveform. If the audio waveform has red in it the audio level is too high and is 'peaking'.
7. Adjust the gain level until the audio waveform has no red in it.
8. Once the level is clean, left-click the audio waveform and the display will return to an audio spectrum.

## Controlling layer properties

This section explains how to use expressions to control layer properties using the AudioAnalyser device. In this example the AudioAnalyser device will be used to affect the **brightness** property of a Colour layer.

To control layer properties using the AudioAnalyser device:

1. Open the layers editor. Please see the chapter [Working with Layers](#) for information on creating and editing layers.

2. Right-click the layer property you want to control using the AudioAnalyser device, in this example the Colour layers **Brightness** property. This will open a small editor.
3. Type the expression into the **untitled Expression** text field according to the format:

LayerPropertyValue\*Device:AudioLine.c[FrequencyRange]

## For example

255\*AudioLine:line\_left.c[0..10]

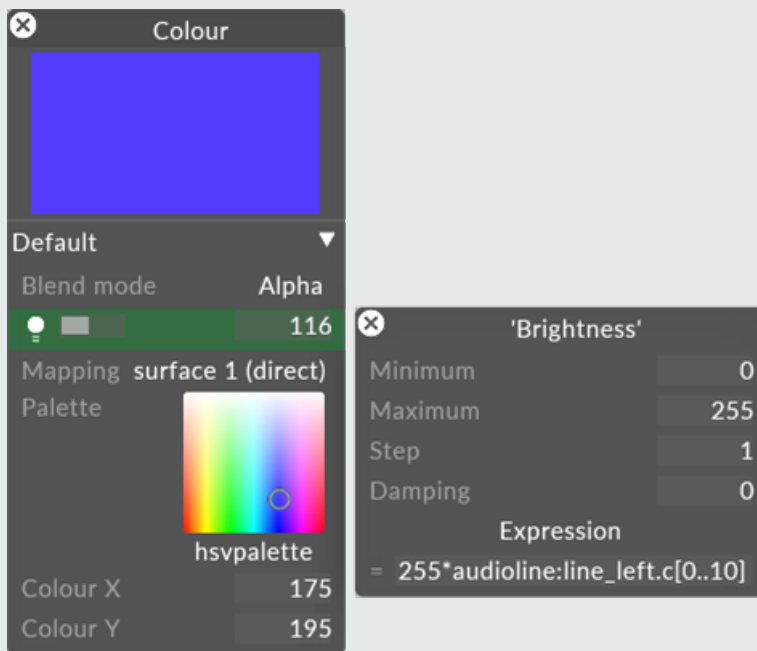

Expression being used to make a layer property, in this example Brightness, controllable using an AudioAnalyser device

When the expression has been accepted the layer property will turn green.

## What does the expression mean?

The diagram below is broken up into sections with a letter underneath. A description of each section is located below the diagram.

**255**\***AudioLine:****line\_left.c****[0..10]**

A B C D

**A:** 255 = Brightness value of the layer

**B:** AudioLine = which device to use

**C:** lineleft = which audio line to use

**D:** [0..10]= what frequency range to analyse

## How do I choose which frequencies to analyse?

The audio spectrum has 127 steps across the frequency range.

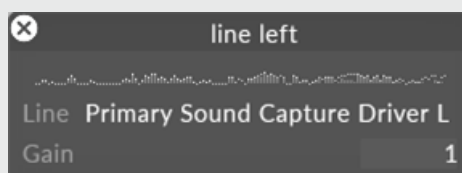

Audio spectrum has 127 steps across the frequency range

Any frequency from 0 to 127 or a range of frequencies can be analysed using part D of the expression described above. For example,

- To analyse just the bass frequencies select a range similar to [0..10] .
- To analyse just the high frequencies select a range similar to [100..127] .

# DMX

This topic explains how to configure Disguise to prove DMX input and output, using an Art-Net device as an example.



**Warning: it is possible to map a DmxDevice to conflicting address ranges. This will result in unpredictable behaviour.**

The Disguise software also uses a number of other converter device types: sACN, Enttec, Soundlight, Exdmx, Kinet v1 and Kinet v2.

To setup the Art-Net connection you first need to create a DmxDevice. A DmxDevice represents a physical output device that connects to the computer (via USB or ethernet) and outputs and/or receives DMX to/from physical devices. d3 supports a number of such DMX converters and protocols. You will need to create a separate DmxDevice for each physical converter device.

## Create a DmxDevice

A DmxDevice is created in the same way as any other device type. Please see the sub-chapter [Creating devices](#) for step-by-step instructions on how to create a device, and select **DmxDevice** from the menu of different device types.

# Edit the DmxDevice

1. Right-click the new DmxDevice, in this case Art-Net, to open the DmxDevice editor.

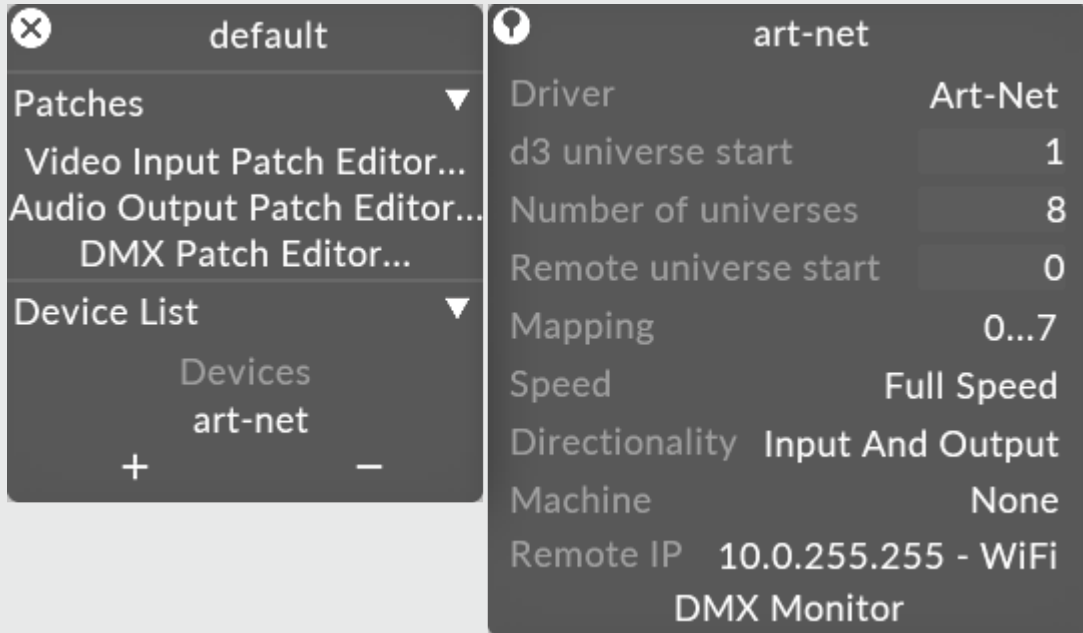

2. Left-click **driver**. This is an option switch that selects the converter device type.

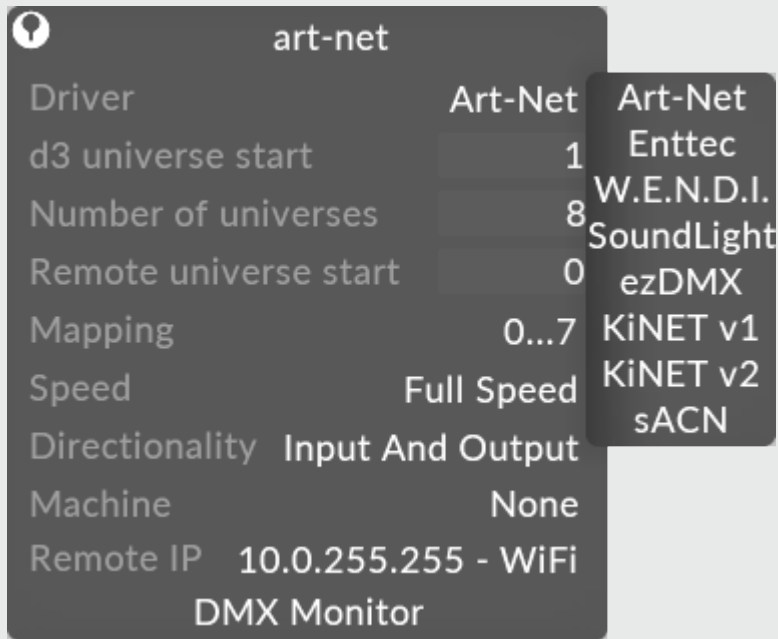

Driver property points to different options of converter device types

## Protocols Supported

The following options are supported:

### — Art-Net

This is the most commonly used DMX-over-ethernet protocol. Art-Net can transmit up to 32,768 Universes of data via a single ethernet cable.

### Art-Net broadcast

To do Art-Net Broadcast, set the remote IP of the device to be the broadcast address of the network. **Example** - if the node's IP is 2.0.0.1 and the net mask is 255.0.0.0 then the broadcast IP will be 2.255.255.255.

## Art-Net IP Address Filtering

We've modified the way we manage Art-Net/sACN connections to allow for more precise layering of DMX data. This means that Disguise is now more strict regarding which IP address it will receive data from, as opposed to the previous behaviour in which it would listen to the entire subnet. In light of this change, users will now need to be more specific when entering remote IP addresses, ensuring that either the correct unicast address or the subnet's broadcast address is used.

### sACN

Streaming-ACN, also known as ANSI E.131-2016, is an alternate DMX-over-Ethernet protocol that is supported by Disguise. Unlike Art-Net, which is a broadcast (or unicast) protocol, sACN is a multicast protocol and can transmit up to 63,999 Universes of control data via an ethernet network.

When selecting an adapter for multicast traffic in Disguise software, it loads the list of the adapters present on the local machine. Note that the name of the adapter that is being used to transmit the sACN signal must be labeled the same way on each of the servers in the network in order to connect properly.

Incorrect example:

Server A (Director) NIC B labeled "B - sACN 1Gbit"

Server B (Actor) NIC B labeled "B - Artnet 1Gbit" (NIC B will not receive DMX)

Correct example:

Server A (Director) NIC B labeled "B - sACN 1Gbit"

Server B (Actor) NIC B labeled "B - sACN 1Gbit"



## — Enttec

This is the protocol supported by the popular Enttec Datagate conversion devices.

## — Soundlight

This is a USB based protocol communicating with DMX devices made by Soundlight Inc.

## — EZDMX

This is a USB based protocol communicating with Avolites EZDMX devices.

## — Kinet V1 and V2

This is a lighting control protocol supported by Color Kinetics devices.

For this example:

- Select **Artnet** from the list of driver converter types.
- Left-click **IP-address** to open the IP address editor. Ethernetbased protocols (Artnet, Enttec, Wendi) identify each physical device with a different IP address. This property has no function for USBbased protocols (Soundlight, Ezdmx).
- Left-click **Manual address** to open the **Select Remote Node** window and type in the IP address of the device. In this example the IP address for a GrandMA lighting desk is being typed in.
- Left-click **OK** when you have finished typing in the IP address.
- Type in the **start universe** value; universe numbers always start from 1. The **start universe** property specifies the first universe number of the device. Disguise software makes an arbitrary number of DMX universes available to you and maps ranges of universes to individual DMX converter devices. This number specifies the universe number of the first universe mapped to this device.

- Type in the **universes** value. This specifies the number of universes to be mapped to the DMX device. In the example above, universes 1 through 8 are mapped to the Art-Net device located at 10.0.0.83.

## Prove DMX input/output

1. Open the DMX monitor by left-clicking **DMX monitor** in the Device editor. The DMX monitor is used to prove DMX input and output, in this example for an Artnet device.

The screenshot shows the DMX Monitor interface with the following configuration:

- Driver: Art-Net
- Start universe: 1
- Number of universes: 8
- Speed: Full Speed
- IP address: 2.0.0.1 - <manual>

The DMX Monitor table displays data for 16 universes (1-16) across 16 channels (1-16). The 'Monitor' column is currently set to 'Output'.

Universe	1	2	3	4	5	6	7	8	9	10	11	12	13	14	15	16	Output
1	0	0	0	0	0	0	0	0	0	0	0	0	0	0	0	0	1
17	0	0	0	0	0	0	0	0	0	0	0	0	0	0	0	0	0
33	0	0	0	0	0	0	0	0	0	0	0	0	0	0	0	0	0
49	0	0	0	0	0	0	0	0	0	0	0	0	0	0	0	0	0
65	0	0	0	0	0	0	0	0	0	0	0	0	0	0	0	0	0
81	0	0	0	0	0	0	0	0	0	0	0	0	0	0	0	0	0
97	0	0	0	0	0	0	0	0	0	0	0	0	0	0	0	0	0
113	0	0	0	0	0	0	0	0	0	0	0	0	0	0	0	0	0
129	0	0	0	0	0	0	0	0	0	0	0	0	0	0	0	0	0
145	0	0	0	0	0	0	0	0	0	0	0	0	0	0	0	0	0
161	0	0	0	0	0	0	0	0	0	0	0	0	0	0	0	0	0
177	0	0	0	0	0	0	0	0	0	0	0	0	0	0	0	0	0
193	0	0	0	0	0	0	0	0	0	0	0	0	0	0	0	0	0
209	0	0	0	0	0	0	0	0	0	0	0	0	0	0	0	0	0
225	0	0	0	0	0	0	0	0	0	0	0	0	0	0	0	0	0
241	0	0	0	0	0	0	0	0	0	0	0	0	0	0	0	0	0
257	0	0	0	0	0	0	0	0	0	0	0	0	0	0	0	0	0
273	0	0	0	0	0	0	0	0	0	0	0	0	0	0	0	0	0
289	0	0	0	0	0	0	0	0	0	0	0	0	0	0	0	0	0
305	0	0	0	0	0	0	0	0	0	0	0	0	0	0	0	0	0
321	0	0	0	0	0	0	0	0	0	0	0	0	0	0	0	0	0
337	0	0	0	0	0	0	0	0	0	0	0	0	0	0	0	0	0
353	0	0	0	0	0	0	0	0	0	0	0	0	0	0	0	0	0
369	0	0	0	0	0	0	0	0	0	0	0	0	0	0	0	0	0
385	0	0	0	0	0	0	0	0	0	0	0	0	0	0	0	0	0
401	0	0	0	0	0	0	0	0	0	0	0	0	0	0	0	0	0
417	0	0	0	0	0	0	0	0	0	0	0	0	0	0	0	0	0
433	0	0	0	0	0	0	0	0	0	0	0	0	0	0	0	0	0
449	0	0	0	0	0	0	0	0	0	0	0	0	0	0	0	0	0
465	0	0	0	0	0	0	0	0	0	0	0	0	0	0	0	0	0
481	0	0	0	0	0	0	0	0	0	0	0	0	0	0	0	0	0
497	0	0	0	0	0	0	0	0	0	0	0	0	0	0	0	0	0

DMX monitor is used to prove DMX input and output, opened by left-clicking DMX Monitor from the DmxDevice editor

2. Type in the **universe** value to prove DMX input on that specific universe.
3. Left click on **Monitor** to change the value from **Output** to **Input**.

4. Check if the values are coming into Disguise software.

# DMXMachineControl Device

The DMXMachineControl Device allows restart and shutdown commands to be sent to Disguise software from an external DMX device such as a lighting console.

## Overview

The DMXMachineControl Device is used for remote shutdown and restart of Disguise machines using DMX commands.

## Workflow

1. Create a DMX device from the Device manager as detailed [here](#).
2. Create a DMXMachineControl Device .
  - Set the Universe & Address values.
  - Configure the command & personality ranges to suit personal preference, or use the default settings.
3. Export the personality to the lighting console in either .txt or MA2 XML format from the Export tab of the device.
  - The exports will be written to the output folder of the [project folder](#).
4. Send values from the lighting console to remotely trigger a machine restart or shutdown.

## DMXMachineControl Device properties

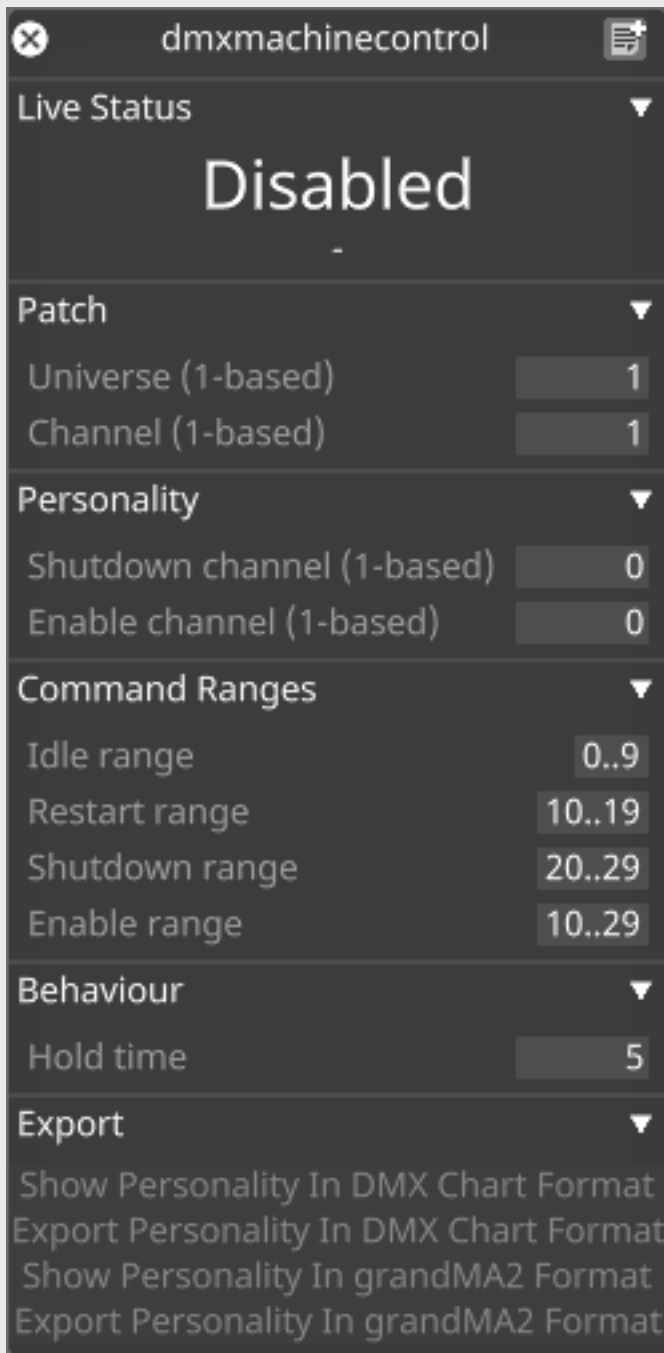

### Live Status

Monitors the status of DMX commands being received

## Patch

### — Universe

The Universe property defines the Universe number that the commands will come from.

### — Channel

The Channel property defines the Channel number that the commands will come from.

## Personality

### — Shutdown Channel

The Shutdown channel defines which DMX channel will send the shutdown command to the Disguise machine.

### — Enable channel

The Enable channel defines which DMX channel will send the Enable command to the Disguise machine, this will allow the command to be triggered.

## Command Ranges

### — Idle range

The Idle range defines the range where no commands are sent to the device.

### — Restart range

The Restart range defines the range where a machine Restart command will be sent to the device.

### — Shutdown range

The Shutdown range defines the range where a machine Shutdown command will be sent to the device.

### — Enable range

The Enable range defines the range where the Enable command will be sent to the device.

## Behavior

### — Hold time

The Hold time, specified in seconds, defines how long Disguise software will wait before acting on a Restart or Shutdown command.

## Export

### — Show Personality in DMX Chart format

Clicking this button will show the DMX personality for the device inside Disguise software in plain text format.

### — Export Personality in DMX Chart format

Clicking this button will Export the DMX personality for the device, from Disguise software in plain text format, to the Output folder of the project folder.

### — Show Personality in grandMA2 format

Clicking this button will show the DMX personality for the device, from Disguise software in XML format to be used with the grandMA2 lighting console.

### — Export Personality in DMX Chart format

Clicking this button will Export the DMX personality for the device, from Disguise software in XML format, to the Output folder of the project folder, to be used with the grandMA2 lighting console.

# JSONMachineControl

JSONMachineControl Device allows for the querying of machine list and machine status via JSON.

## Telnet setup

A JSONMachineControl Device requires the use of Telnet. Follow these steps to properly configure the Disguise server for Telnet communication:

1. Enable Telnet by navigating to **Control Panel > Programs > Turn on Windows Features > Telnet Client**
2. Click on the link **telnet://127.0.0.1:9864**
3. To get the name of the machine, enter: **{"query":{"q":"machineList"}}**
4. To get the framerate, enter **{"query":{"q":"machineStatus hostName"}}**



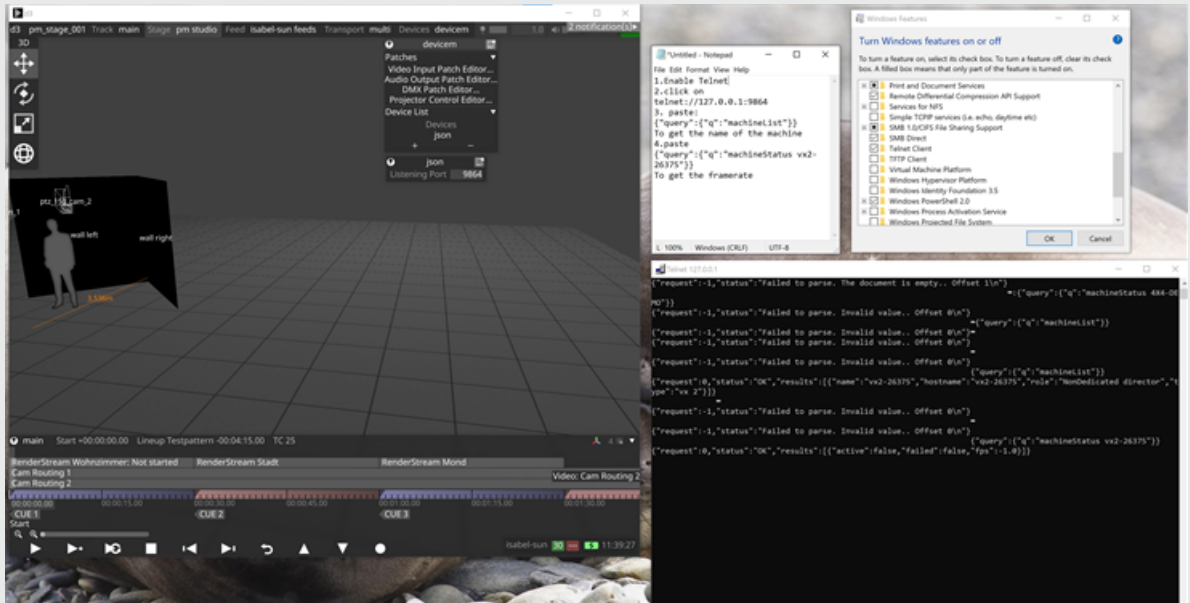

Using Live framerate is recommended. This python code method may be used to get Live framerate:

### live framerate

```

1 import json
2 from telnetlib import Telnet
3 from socket import gethostbyaddr
4 hostIP = "127.0.0.1" # stick the server IP here
5 port = 9864
6 host_name = gethostbyaddr(hostIP)
7 print(f'd3 name is: {host_name[0]}')
8 q = '{"query":{"q":"machineStatus ' + host_name[0] + '"}}'
9 print(f'sending - {q.encode('ASCII').decode('ASCII')} - to {host_name[0]}')
10 def readFPS():
11     with Telnet(hostIP, port) as tn:
12         tn.write(q.encode('ASCII') + b'\r\n')
13         buf_as_dict = json.loads(tn.read_until(b'}}'))
14         return buf_as_dict['results'][0]['fps']
15 if __name__ == '__main__':
16     while True:
17         fps = readFPS()
18         print(fps)

```

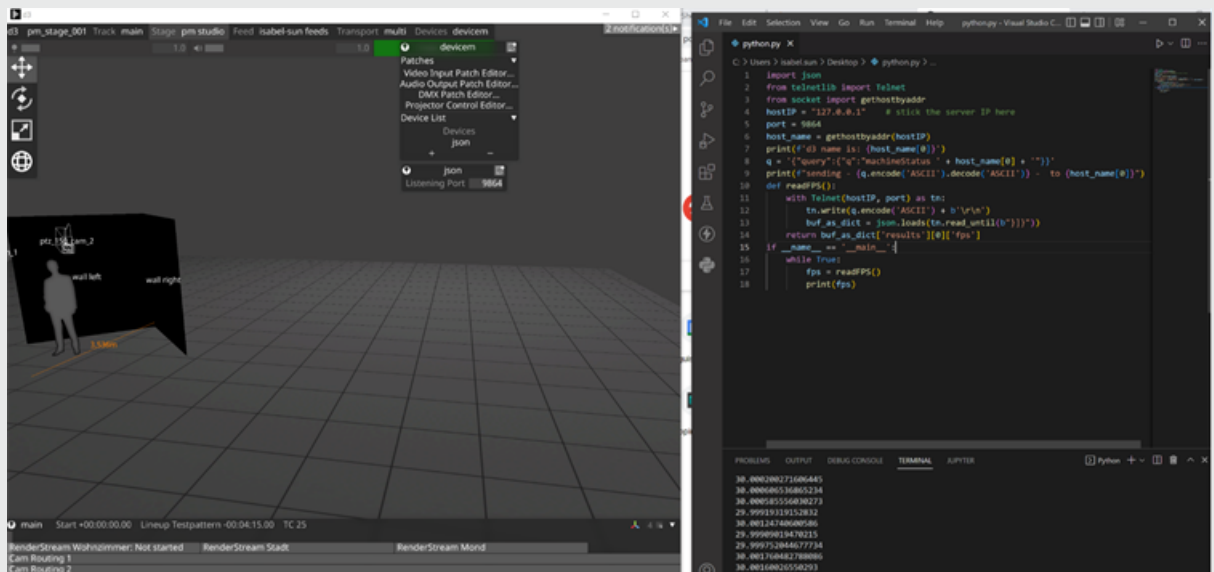

## Creating a JSONMachineControl Device

A **JSONMachineControl** device is created in the same way as any other device type. Please see the sub-chapter [Creating devices](#) for step-by-step instructions on how to create a device, and select **JSONMachineControl** from the menu of different device types. This will open the device editor (explained below).

## JSONMachineControl Device properties

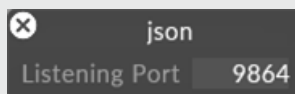

## Listening Port

The listening port the device is set to.

## JSONMachineControl queries

**Machine list:** {"query":{"q":"machineList"}}

Returns a list of dictionaries containing information about the machine: d3 name, hostname role and machine type.

**Example return:** {"request":0,"status":"OK","results":

```
[{"machine":"4x4-DEMO","hostname":"4X4-DEMO","role":"Dedicated director","type":"4x4pro"}]}
```

**Machine status:** {"query":{"q":"machineStatus 4X4-DEMO"}}

Returns extra information about a machine: session status, failover status and current FPS.

**Example return:** {"request":0,"status":"OK","results":

```
[{"active":true,"Failed":false,"fps":32.345558166503909}]}
```

# MIDI controllers

## Setting up a MIDI device

Disguise software includes the following pre-built midi control surfaces: [Behringer BCF 2000](#), [M-Audio Oxygen 8](#), [M-Audio UC-33](#). If you wish to use a midi control surface other than the midi control surfaces provided by default in the software, you can use the MidiDevice device type to create a virtual replica of the real world midi control surface. This control surface can then be used to send midi to/from Disguise software.

1. Create a **MidiDevice**. A MidiDevice is created in the same way as any other device type. Please see the earlier sub-chapter [Creating devices](#) for step-by-step instructions on how to create a device, and select **MidiDevice** from the menu of different device types. The MidiDevice is initially just a title bar displaying its name as the device currently has no features or properties.

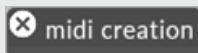

New MidiDevice, in this example Midi\_creation; currently the device has no properties

2. To open the MidiDevice editor right-click on the title bar and select **edit**. The MidiDevice editor is used to create the midis control surface.

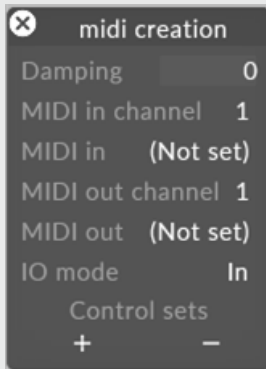

3. Set the **midi in/midi out** properties to the appropriate midi port. HDSP9632 are the midi ports on the RME breakout cable or AOI Midi on newer systems.
4. Under **control sets** select the **+** button to open the MidiControlSets manager. The MidiControlSets manager contains a list of all of the control sets. Notice Disguise software comes with a series of control sets by default.
5. To create a new control set type the control set name into the **newmidicontrolset** text field, in this example **sliders**, and hit **Enter**.

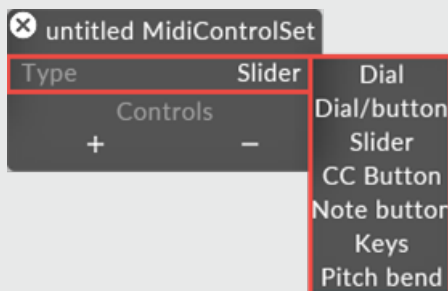

The new control set will be added to the list of control sets in the MidiDevice editor and MidiControlSets manager, and the Control Sets editor will open.

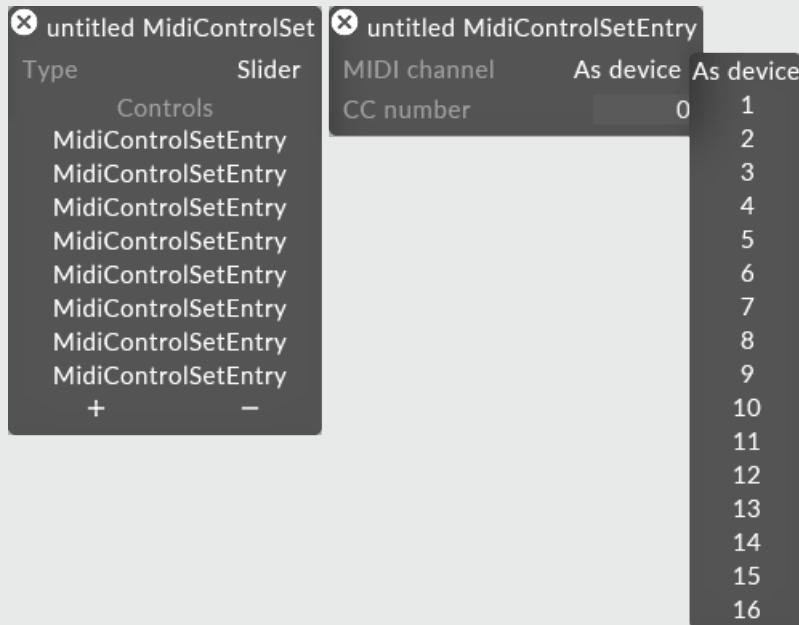

6. To specify the type of control set right-click **type** and select a control set type from the menu. Options are **dial**, **slider**, **button**, **keys** and **dial/button**. This example uses the **slider** control set type.
7. Select the **+** button to add the desired number of control objects. In this example ten sliders have been created.
8. Set the **mode** property to **in**, **out** or **bidirectional** depending on how the midi data should be sent; **bidirectional** will set the midi data to be sent to Disguise aswell as from Disguise software.
9. Repeat the above steps to create the required number of dials/sliders/buttons/ keys.
10. Once all of the required controls have been created close and reopen the MidiDevice by right-clicking the device from the Devices menu. Notice that the MidiDevice is not just a title bar anymore but is a virtual replica of a midi control surface.

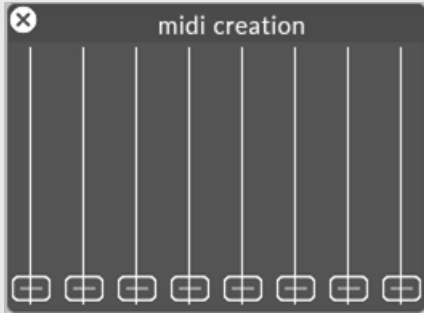

The next task is to assign the controls to a control surface.

1. To link a control to a control surface, right-click on the specific control, for example, **slider 1**.

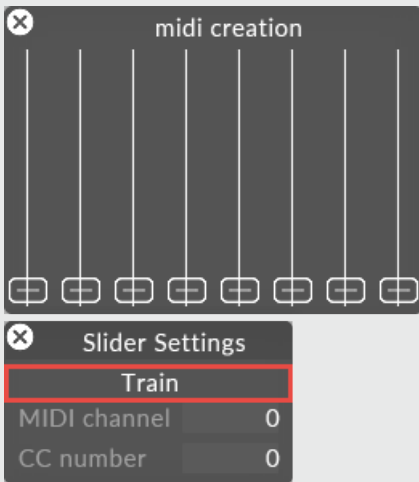

Dial Settings being used to link a control to a control surface, opened by right-clicking on the specific control

2. Move/change the encoder value on the control surface. Disguise will learn the encoder and store it. Repeat this step for the encoders that are to be used.

# Assign a midi control to a layer property

1. Hold **Alt** and left-click drag from the encoder to a layer property to apply midi control to that property. This will draw a white arrow. For more information on Arrows please see the sub-chapter [Composing layers using Arrows](#).

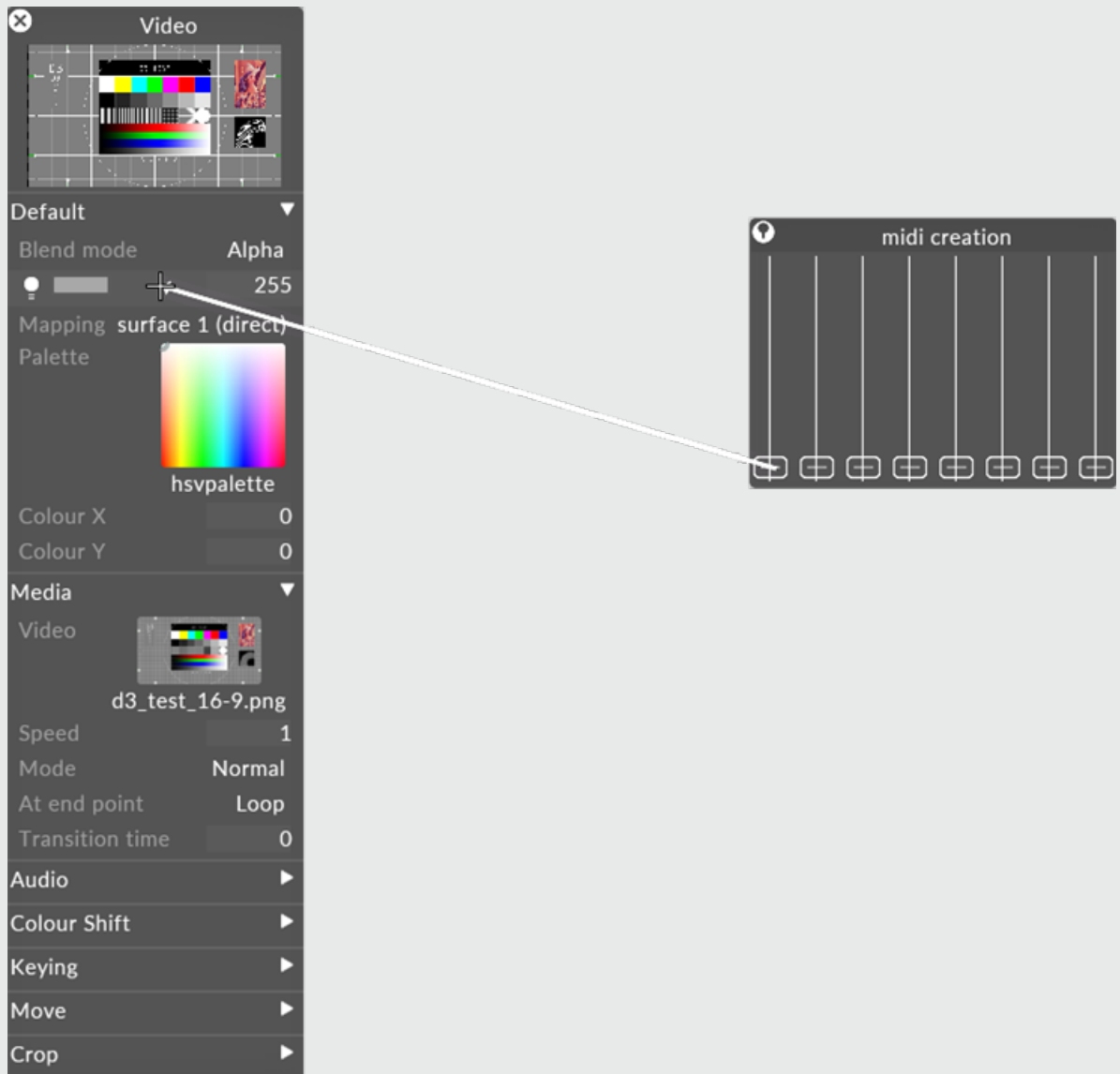



Arrows being used to assign a midi control to a layer property

2. Release the mouse button to assign the encoder to the specific layer property. The layer property will turn green once the link has been successfully created.

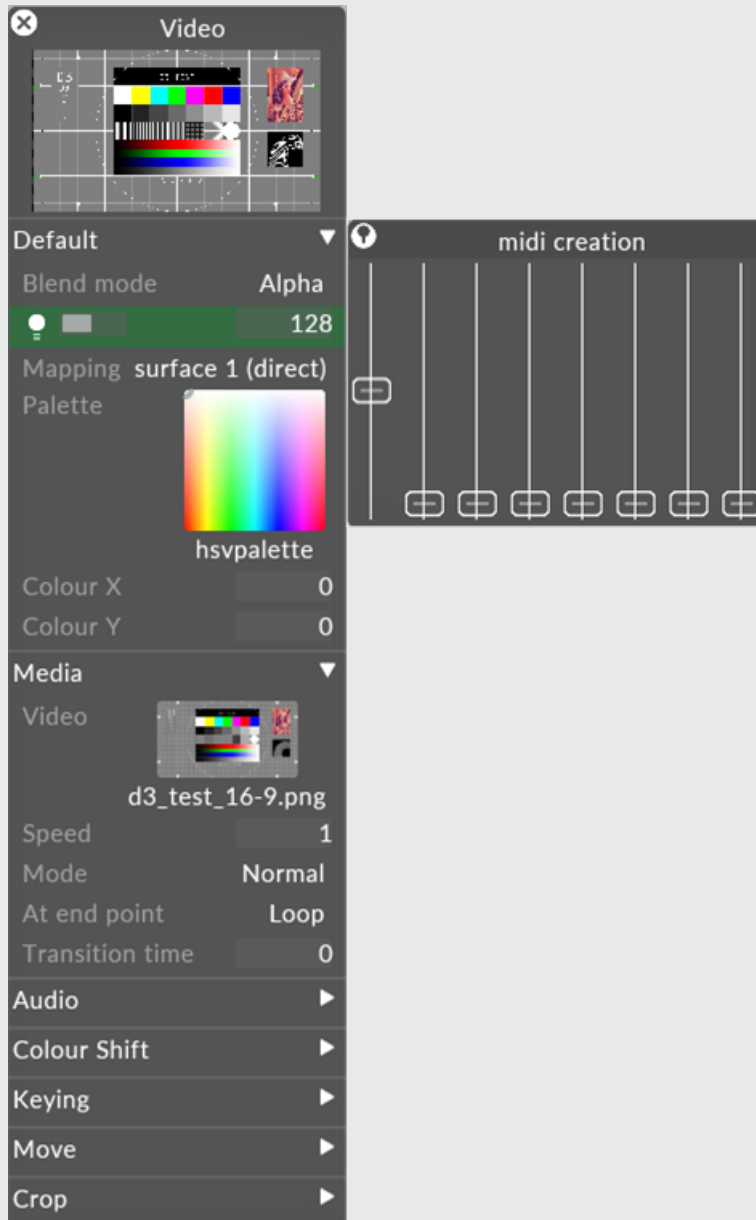

The Brightness property of the Colour layer has turned green indicating that this property has successfully been assigned to a midi control

3. To check the expression that is being used by a layer property right-click on the specific property. This will open a small editor containing the expression.

For more information on expressions please see the sub-chapter [Expressions](#).

# OSC

## OSC applications

There are several applications available for iOS that are capable of sending OSC commands. Two applications that we recommend are [Liine](#) by Lemur and [TouchOSC](#) by hexler.net.

To download examples of TouchOSC and Lemur layouts please go to the [OSC Downloads](#) page.

**Please note:** the sliders within TouchOSC application are set as float values between 0 to 1.

## Creating OSC Devices

An OSC Device is created in the same way as any other device type. Please see the earlier sub-chapter [Creating devices](#) for step-by-step instructions on how to create a device, and select **OSC Device** from the menu of different device types. Alternatively, by default Disguise contains an Osc Device called **osc 1**, which can be selected from the Devices manager.

## OSCDevice properties

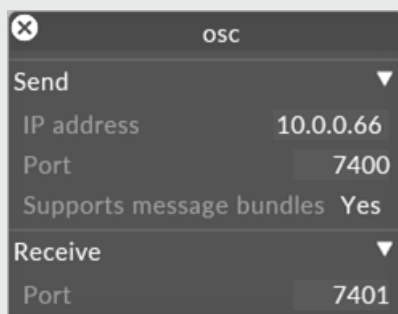

## sendIPAddress

This property specifies the IP value of the machine/device for out going commands to be sent to.

## sendPort

This property specifies the port number of the machine/device for out going commands to be sent to.

## receivePort

This property specifies the port number for incoming commands.

For more information on setting the IP address please see the sub-chapter [Windows Settings](#).

## OSC Transport Control

For information how to use OSC expressions on the timeline please see the [OSC Transport Control](#) page.

## Controlling layer properties with OSC

For information how to use OSC expressions to control layer properties please see the [Controlling layer properties with OSC](#) page.

## Example Workflow

### Setting up a device to control disguise through OSC

This is an example workflow using the iPhone application Lemur and an iPhone device.

1. Download the example Lemur layout from the disguise [Resources](#) page.
2. Download the Lemur application to the iPhone device that will be sending commands to Disguise software.
3. Import the Lemur layout to your iPhone. If you are using a Mac computer you can Airdrop the layout to the iPhone and it will automatically import to Lemur. Otherwise, you can do it manually from the Lemur app settings.

4. If you are using a disguise server, configure your network settings to assign the IP of the server the OSC device will send commands to. If you are using a designer machine, you can have it connected to a WiFi connection.
5. Run your disguise project.
6. Right click on the Devices editor.
7. Press the + icon to create a new device, or to add the default loaded osc 1 device.
8. Right click on the device name to open its network configuration settings.
9. Under the Send tab's IP Address field, assign the IP address that disguise should send commands to. In the Lemur application, this IP can be accessed through the apps settings as the "Lemur IP"
10. In the Lemur settings, set the OSC host as the IP address of your machine. This will be reflected under the Adapter tab in the OSC device window.
11. Under the Receive tab's Port field, assign the port number the OSC device will send commands to. This is the number reflected in the Lemur OSC settings.
12. Toggle an OSC command from the Lemur profile to see if the OSC device indicator turns green. That will verify the connection has been made.
13. You can also create an OSC tester device [[link to OSC tester device page](#)] linked to your OSC device to verify the connection has been made.

# OSCMachineControl setup

The OSCMachineControl device allows restart and shutdown commands to be sent to Disguise software from an external OSC device.

## Overview

This topic outlines the setup steps in order to setup the OSCMachineControl device in Disguise software which is used for remote failover and restore of Disguise machines using OSC commands.

## Workflow

1. Create a OSC device from device manager as detailed [here](#).
2. Create a OSCMachineControl device from device manager.
  - Set the OSC device to an existing OSC device (or create a new one)
  - Configure the input & output message strings to your preferences, or use the default strings.
  - The exports will be written to the output folder of the [project folder](#).
3. Send values from the OSC device to remotely trigger a machine restart or shutdown.

## OSCMachineControl properties

### OSC Device

#### OSC device

The OSC device defines the OSC device in Disguise software that the commands will be sent to and from.

### Input Addresses

#### Failover address

The failover address causes a machine failover. It accepts a string parameter which is the machine host name that should be failed over.

#### Restore address

The restore address restores a machine from failover. It accepts a string parameter which is the machine host name that should be restored.

#### Display query address

The string used to query display resolutions using the machine name.

## Output Addresses

### Machine resolution address

The string used to define the response to the Display query with 2 integer data with x & y resolution. For example: **/d3/showcontrol/display/resolution/myMachine/0/0 1920 1080**



# OSC tester

OSC tester is a device that allows users to test incoming and outgoing OSC messages from Disguise software. It exists as a standard device.

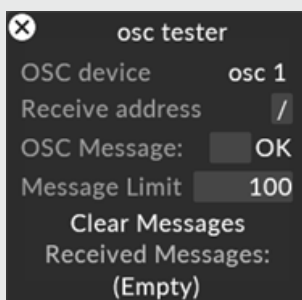

## Creating a new device

1. Right-click **devices** from the dashboard. This will open the Device Manager, which contains a list of active devices.
2. Select **+** to open the Device library. This lists which internal or external devices are available.
3. Type in the name of the new device into the **new device** text field.
4. Hit **Enter**. This will open a list of device types available in Disguise software.
5. Select the appropriate device type.

The new device will be added to the Device Manager's active device list, and to the Device library. The device's editor will also open.



**Please note:** Always right-click on the **default** device object to add devices to it. If left-clicking you will be prompted to create a whole new device manager which is rarely required.

## Testing incoming messages

1. Set the OSC device to be the OSC device you are expecting to received messages from.
2. Set the Receive address filter, if you wish to filter only specific OSC messages.
3. Send the values from the OSC device.
4. Values received should be shown in the Received Messages area at the bottom of the widget.

# Testing sending messages

1. Set the OSC device to be the OSC device you are expecting to send messages to.
2. Set the message limit, or use the default setting.
3. Define the OSC string by typing it into the **OSC Message** field.
4. Send the values to the OSC device by clicking **OK**.

# StringProjectorControl Device

The StringProjectorControl Device is intended for controlling external devices while optionally simulating their behaviour inside the visualiser.

## Overview

Projector control can be simulated as well as output to real projectors. The intention is to be able to recall presets for the projectors that contain pan/tilt, zoom, focus, lens shift, intensity and projector configuration objects (for recalling different calibration states).

## Setup

# Configure the StringProjectorControl Device

## Device setup

1. Create a StringProjectorControl Device
2. Associate the device with a projector.
3. Create a control device if using the string control version.
4. Assign the simulation configuration to the selected projector config.
5. Create presets either via the ProjectorControl Editor or the ProjectorControl layer preset editor. The former is the preferred workflow, as it allows for multi-edit.

## Timeline keyframing

1. Create a projector control layer.
2. Create a mapping (group of projectors to control).
3. Create presets for the projectors to recall as the timeline plays.

## Configure the device

1. Define which projector is controlled by the device.
2. Choose whether simulation configuration is enabled or disabled. This controls whether the projector will move in the stage or not.
  - In the case of the StringProjectorControl device, define a control device and create a corresponding serial, telnet or UDP device to send the data out of Disguise software.
3. Configure any Default, Startup and Shutdown commands, as appropriate.

## Configure presets

ProjectorControlPresets can be created either through the ProjectorControl layer or through the StringProjectorControl Device Editor. Performing this functionality through the editor is a better choice as this editor fully supports multi-edit functionality, as well as converting hard values to presets for more time saving functionality.

1. Open the StringProjectorControl Device Editor from the Device manager.
2. Select each projector and apply the desired values. Either individually or by using the multi-edit functionality.

3. Select multiple rows and use the **Convert Selected Rows to Preset** function, to store the contents of the selected rows into a preset that can be recalled later. For example - Home position, Position 1, Position 2 and so on.

Projector Control Device																
Device Status	Name	Select All						Select None								
		Projector	Pan/Tilt	Focus	Zoom	Lens Shift (V/H)	Intensity	Simulation configuration	Home rotation		Rotation speed (deg/s)		Recall			
Active	projector device 1	projector 1	5,	0	1	0	0,	0	0	None	0,	0,	0	1,	1	default
Active	projector device 2	projector 2	8,	0	1	0	0,	0	0	None	0,	0,	0	1,	1	default
Active	projector device 3	projector 3	12,	0	1	0	0,	0	0	None	0,	0,	0	1,	1	default

## Control the projector

See [ProjectorControl layer](#) for more information.

## Properties

### Projector

- The virtual projector object in the visualiser

### Values

- Pan/Tilt, Focus, Zoom, Lens Shift (V/H), Intensity: the current values being sent to the external device. Modifying these values will cause the device to send out commands to the external device.

### Simulation

- **Simulation configuration** - the projector configuration that the device modifies to simulate the behaviour of the external device. Always use a dedicated projector configuration for this as its settings will be overwritten by the simulation
- **Home rotation**- the starting rotation when the device's pan/tilt are at zero
- **Rotation speed** - the animation speed of rotation between different pan/tilt values
- **Pan axis** the axis controlled by the pan value
- **Tilt axis** the axis controlled by the tilt value

## Default recall

- **Recall** -the default order of the commands sent to the device. This allows delays between starting the pan/tilt, focus, zoom and other actions.

For example, you may want to delay intensity moves for a set period of time to allow zoom, focus and position to be set before the projector is visible. The delay value is expressed in seconds.

The editor is capable of multi-edit functionality, so does not behave in the same way as a normal editor. See [multi-edit](#) for more information.

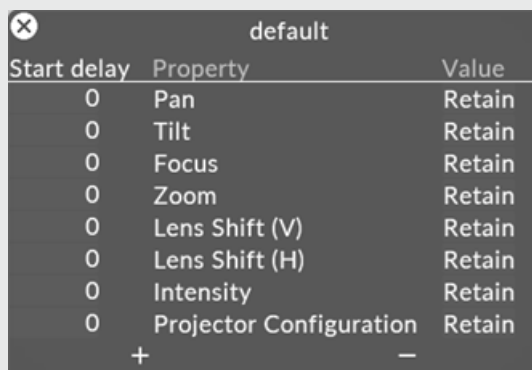

Start delay	Property	Value
0	Pan	Retain
0	Tilt	Retain
0	Focus	Retain
0	Zoom	Retain
0	Lens Shift (V)	Retain
0	Lens Shift (H)	Retain
0	Intensity	Retain
0	Projector Configuration	Retain

## Device

- **Control device** the network device (Serial, Telnet, UDP) that commands are sent over

## Commands

- **Default commands** - String commands sent to the network device before any specific actions' DMX commands
- **Startup commands** - String commands sent to the network device when the projector control device is started or added from the device manager
- **Shutdown commands** -String commands sent to the network device when the projector control device is stopped or removed from the device manager

## Common properties

Control strings for each of these projector control actions can be created. The range will be used to scale the current value before exposing it as a binary (%) or decimal (\$) number

**Zoom**

**Focus**

**Lens Shift**

**Intensity**



# Telnet

**TelnetDevice** can be used to send commands via an available serial port to 3rd party products. For more information on how rs232 works please see this [page](#).

**TelnetDevices** are used by the Control Layer and the [DVIMatrixControl layer](#).

## Creating a TelnetDevice

A **TelnetDevice** is created in the same way as any other device type. Please see the earlier sub-chapter [Creating devices](#) for step-by-step instructions on how to create a device. This will open the **TelnetDevice** editor (explained below).

## TelnetDevice properties

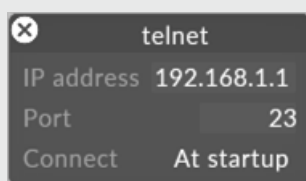

### IP Address

The IP address of the destination 3rd party hardware. You must ensure that your network topology is configured to allow communications between the two machines.

### Port

The network port of the destination 3rd party hardware. Telnet is traditionally port 23.

## Connect

The telnet port can be opened once **at startup** of d3 and held open or can be opened for **every send** of a command.

# UDP

**UDPDevices** can be used to send commands over a network via UDP to 3rd party products.

**UDPDevices** are used by the Control Layer and the [DVIMatrixControl layer](#).

## Creating a UDPDevice

A **UDPDevice** is created in the same way as any other device type. Please see the earlier sub-chapter [Creating devices](#) for step-by-step instructions on how to create a device, and select **UDPDevice** from the menu of different device types. This will open the **UDPDevice** editor (explained below).

## UDPDevice properties

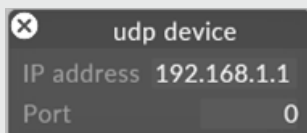

### IP Address

The IP address of the destination 3rd party hardware. You must ensure that your network topology is configured to allow communications between the two machines.

### Port

The network port of the destination 3rd party hardware. The 3rd party vendor will need to specify this value.

# Agile camera setup

## Overview

This topic outlines the setup steps in order to control the Agile ARC 360 camera using a Disguise mediaserver.

## Requirements

- Agile Camera that supports IP connectivity and SDI output.
- Optional Agile HW Controller.
- PoE switch (for supplying power to the camera).
- Optional Disguise machine with a capture card (only if you want to use the camera as a live video input).



**Warning:** Currently the Agile Camera doesn't support absolute PTZ (Pan, Tilt and Zoom) commands. Therefore, in order to send the camera absolute PTZ values, it's necessary to create presets.

## Workflow

1. Create a UDP device from device manager.
  - Set the IP Address
  - Set the Port on the UDP device
2. Create an Agile Camera device from device manager.

- Set the Address.
  - Set the Control Device to the UDP device.
  - Set the Camera Model.
3. Create a CameraControl layer on the timeline.
- Set the Camera field to the camera that was created earlier.
  - Click the Command field to open up the keyframe editor.
  - Create and keyframe your desired commands for the camera.

## Creating a UDP device

1. Right-click **devices** from the dashboard. This will open the Device Manager, which contains a list of active devices.
2. Select **+** to open the Device library. This lists which internal or external devices are available.
3. Type in the name of the new device into the **new device** text field.
4. Hit **Enter**. This will open a list of device types available in Disguise software.
5. Select the appropriate device type. In the case of Agile camera, a UDP device is needed.



The new device will be added to the Device Manager's active device list, and to the Device library. The device's editor will also open.

**Please note:** Always right-click on the **default** device object to add devices to it. If left-clicking you will be prompted to create a whole new device manager which is rarely required.

## Create an Agile camera device

1. Right-click **devices** from the dashboard. This will open the Device Manager, which contains a list of active devices.
2. Select **+** to open the Device library. This lists which internal or external devices are available.
3. Type in the name of the new device into the **new device** text field.
4. Hit **Enter**. This will open a list of device types available in Disguise software.

5. Select the **AgileCamera** device type.



## Controlling the camera

1. Create a [CameraControl](#) layer and add it to the timeline. For more information see [Creating layers](#).
2. Create CameraControl presets & keyframe accordingly. For more information, see [CameraControl](#).

## Mapping the camera to a video input

To display the camera on a screen in Disguise software and subsequently output it to a real screen, complete the following steps.

1. Create a [Video layer](#)
2. Open the media property of the layer and choose the video input that the camera is being input. For more information see, [video input](#).

## AgileCamera properties

### Address

The address property defines the address of the camera you are communicating with.

### Control Device

The control device property defines which device in the devices manager, is communicating with the physical camera.

### Camera Model

The camera model currently, can only be defined as ARC360.

### New Address

The new address field lets the user change the camera address.

1. Enter a new value in the new address field
2. Left click **Set**



## Preset #

The preset number field allows you to specify which preset is saved or recalled. There are 256 preset slots, 0-255.

Left click **Recall** to manually recall the selected preset number.

The presets are saved within the camera device, and only support Pan, Tilt and Zoom.

Presets can also be triggered from the CameraControl layer, using the CameraRecallPreset command.

## Pan Tilt Jog

Left click and drag in the jog control to manually position the camera.

## Zoom Jog

Left click and drag in the jog control to manually change the zoom of the camera.

## Supported commands

The following commands are supported for use with the CameraControl layer

- CameraAutoFocus

When on, you cannot change the focus of the camera.

When off, you can change the focus of the camera.

- CameraBlack

- CameraBlueGain

- CameraExposureMode

When on, you cannot change black, blue, red, camera gain and white balance.

When off, you can change black, blue, red, camera gain and white balance.

- CameraFocus
- CameraGain
- CameraGammaMode
- CameraGoToPreset
- CameraImageMirrorMode
- CameraIris
- CameraNightMode
- CameraOnOff
- CameraRedGain
- CameraShutter
- CameraVideoOutputMode
- CameraWhiteBalanceMode

# Visca camera setup

## Overview

This topic outlines the setup steps in order to control the Visca camera using a Disguise mediaserver.

## Requirements

- Visca Camera that supports IP connectivity.
- Optional Disguise machine with a relevant capture card (only if you want to use the camera as a live video input).

## Workflow

1. Create a UDP device from device manager.
  - Set the IP Address
  - Set the Port on the UDP device
2. Create a Visca Camera device from device manager.
  - Set the Address.
  - Set the Control Device to the UDP device.
  - Set the Camera Model.
3. Create a CameraControl layer on the timeline.
  - Set the Camera field to the camera that was created earlier.
  - Click the Command field to open up the keyframe editor.
  - Create and keyframe your desired commands for the camera.

# Creating a UDP device

1. Right-click **devices** from the dashboard. This will open the Device Manager, which contains a list of active devices.
2. Select **+** to open the Device library. This lists which internal or external devices are available.
3. Type in the name of the new device into the **new device** text field.
4. Hit **Enter**. This will open a list of device types available in Disguise software.
5. Select the appropriate device type. In the case of Visca camera, a UDP device is needed.



The new device will be added to the Device Manager's active device list, and to the Device library. The device's editor will also open.

**Please note:** Always right-click on the **default** device object to add devices to it. If left-clicking you will be prompted to create a whole new device manager which is rarely required.

## Create a Visca camera device

1. Right-click **devices** from the dashboard. This will open the Device Manager, which contains a list of active devices.
2. Select **+** to open the Device library. This lists which internal or external devices are available.
3. Type in the name of the new device into the **new device** text field.
4. Hit **Enter**. This will open a list of device types available in Disguise software.
5. Select the **ViscaCamera** device type.



# Controlling the camera

1. Create a [CameraControl](#) layer and add it to the timeline. For more information see [Creating layers](#).
2. Create CameraControl presets & keyframe accordingly. For more information, see [CameraControl](#).

# Mapping the camera to a video input

To display the camera on a screen in Disguise software and subsequently output it to a real screen, complete the following steps.

1. Create a [Video layer](#)
2. Open the media property of the layer and choose the video input that the camera is being input. For more information see, [video input](#).

## ViscaCamera properties

### Address

The address property defines the address of the camera you are communicating with.

### Control Device

The control device property defines which device in the devices manager, is communicating with the physical camera.

# Camera Model

The camera model currently you are using.

# Matrix switches overview

The Disguise software can switch presets of various matrices and switchers. Presets can be animated using the [MatrixControl](#) layer but in a Director/Actor environment the presets can be changed through an automated process using the [d3Net manager](#).

## Which matrix switches are supported?

The Disguise software has built-in drivers for the following matrices and switchers:

- [Lightware](#)
- [Barco MatrixPro](#)
- Barco Encore. See external link [here](#).
- [Analog Way OPS300](#)
- Folsom MatrixPro 16x16.
- Gefen Matrix. See external link [here](#)
- [Blackmagic Smart Video Hub](#)

## Other devices to be controlled

For devices that currently do not have built-in drivers Disguise can also send serial commands using the [Control layer](#) assuming you first set up the Serial Device.

The [TelnetDVIMatrix](#) device also allows most matrices to be controlled from Disguise.



# Direct Matrix Routing

## What is Direct Matrix Routing?

The Disguise software supports direct matrix routing, which sends individual routing instructions (“map input X to output Y”) to the matrix. Disguise software allows multiple matrix devices to be controlled, and allows fanout (a single feed output can be mapped to more than one physical output, for backup).

When a feed is assigned to a machine, Disguise generates an appropriate set of routing instructions and sends this to all connected matrix devices.

## Using Direct Matrix Routing

To set it up, you need to tell Disguise software two things:

- For each machine, which matrix input each physical head connects to
- For each feed, which matrix output(s) drive each feed head

When a feed is assigned to a machine, Disguise generates an appropriate set of routing instructions and sends this to all connected matrix devices.

## Setting up Direct Matrix Routing

1. Add one or more matrix devices to your Devices list and set them up appropriately. Note that the order these devices are in the **Device Manager** is what defines them as Matrix 1, Matrix 2 etc. You can drag matrices up & down in the Device Manager to re-order them.
2. Access your feed scene by left clicking **Feeds** from the dashboard.
3. Right click the coloured border of a feed output.

4. For the Matrix input & Matrix output parameter, write in a comma-separated list of (matrix number, input number), eg. "1.1, 1.2" means "outputs 1 and 2 of matrix 1".



**Warning:** There should be no spaces between matrix routing strings. Any spaces in the input field will cause the routing to fail.

For more information on supported DVI matrices, see the [Matrix switches overview](#) sub-chapter

## Basic routing example

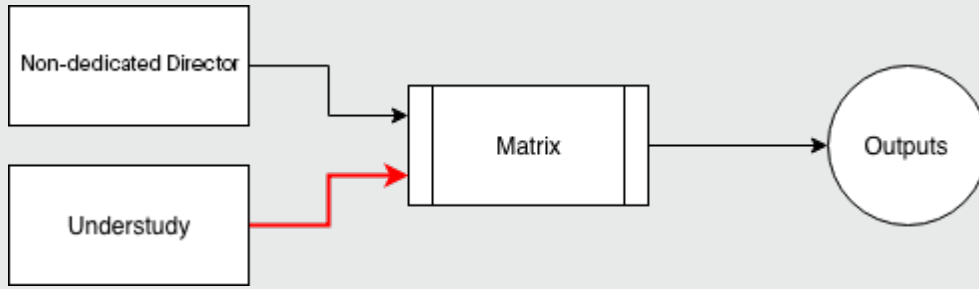

Director In	1	2	3	4
Director Out	1	2	3	4
Understudy In	5	6	7	8

This is the easiest configuration to work with. In its most basic form, matrix routing will use a single matrix to swap the inputs on failover. This notation is as simple as typing each input and output number into the feed properties of each machine. This matrix is using a 1-to-1 routing, and on failover inputs 5-8 are used to receive from the Understudy.

## Matrix DA routing example

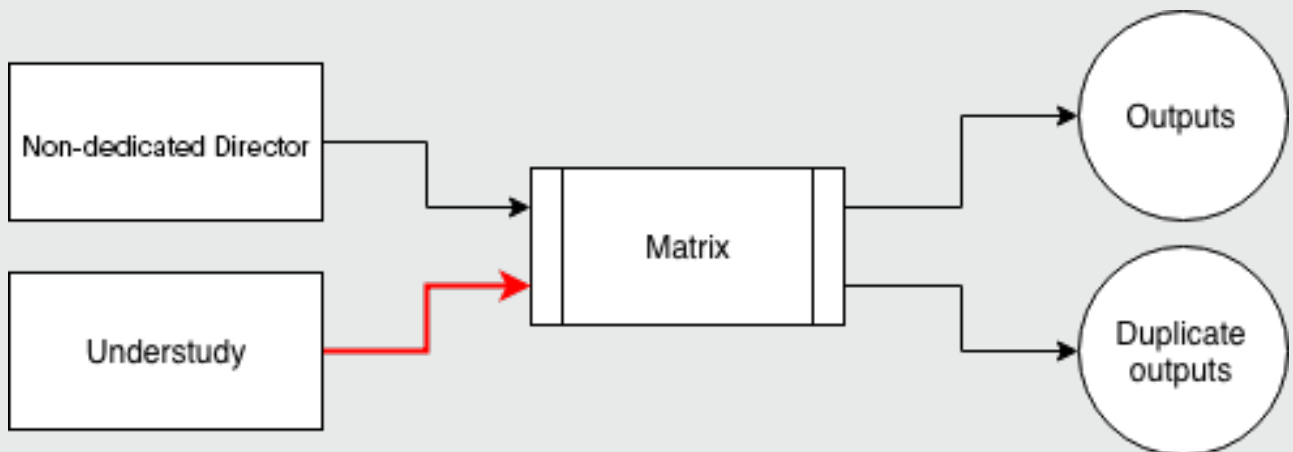

Director In	1	2	3	4
Director Out	1,5	2,6	3,7	4,8
Understudy In	5	6	7	8

In this example, each matrix output is doubled up and sending a duplicate output. In Disguise software the notation for this is to comma separate the output numbers. This example shows input 1 being sent to outputs 1 and 5, 2 to 2 and 6, and so on. On failover, 5 is routed to 1 and 5, etc. The comma only works in the output field of each routing.

## Multiple matrices routing example

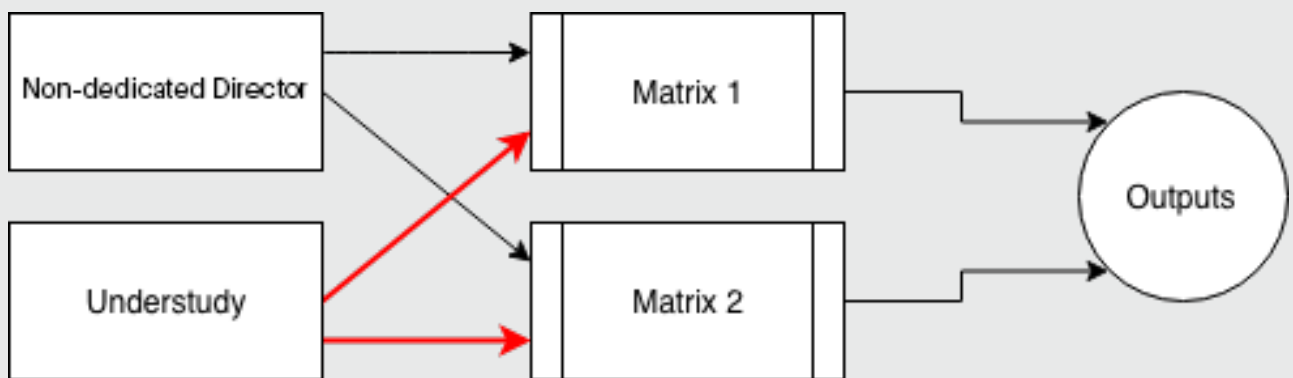

Director In	1.1	1.2	1.3	1.4	2.1	2.3	2.4	
Director Out	1.1	1.2	1.3	1.4	2.1	2.2	2.3	2.4
Understudy In	1.5	1.6	1.7	1.8	2.5	2.6	2.7	2.8

This is the same 1-to-1 routing as the first example, except doubled-up. The Director and Understudy each have 8 outputs, sending 4 of each to the 2 matrices. In order to delineate between the 2 matrices, which are separate devices in the **Device Manager**, the above **Dot** notation is used. The number before the dot is the matrix's ID, and the number after is the input or output routing number on that specific matrix. The ID number is determined by the order of the matrix-type devices in the device list, starting from the top.

# Cascading matrices routing example

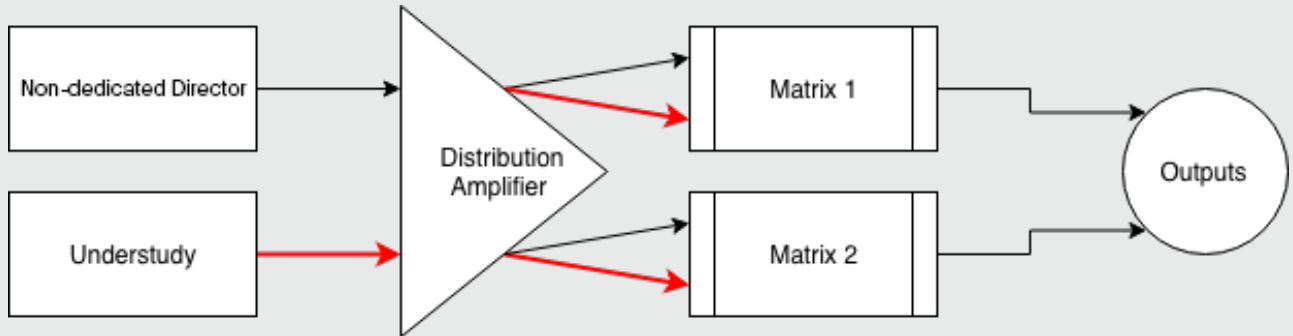

Director In	1.1   2.1	1.2   2.2	1.3   2.3	1.4   2.4
Director Out	1.1   2.1	1.2   2.2	1.3   2.3	1.4   2.4
Understudy In	1.5   2.5	1.6   2.6	1.7   2.7	1.8   2.8

This more complex notation is able to send two or more commands for each input or output routing. In this example, a distribution amp or similar is doubling every signal before it reaches the matrices, so each output from Disguise software reaches more than one matrix at once.

The **Pipe** notation is able to send multiple whole commands per feed output. The order the routing is written in is important: one routing is before the pipe, the other is after. On failover, the understudy would route 1.5 to 1.1 and 2.5 to 2.1 at the same time, and so on.

This needn't stop at two routings per output; a second pipe can be used if a third matrix needed to be controlled (**1.1 | 2.1 | 3.1**). The dot notation is also in use because more than one matrix is being controlled. All three - comma, dot and pipe - can be mixed and matched to suit the exact configuration of matrices in use.

# Setup Analog Way OPS300

## Setting up an Analog Way OPS300

1. Navigate to the **Network Settings** page of the Analog Way OPS300 interface. Note down the **Remote Address** and **Remote Port** numbers used or set your own. Please see your devices manual for more instructions.

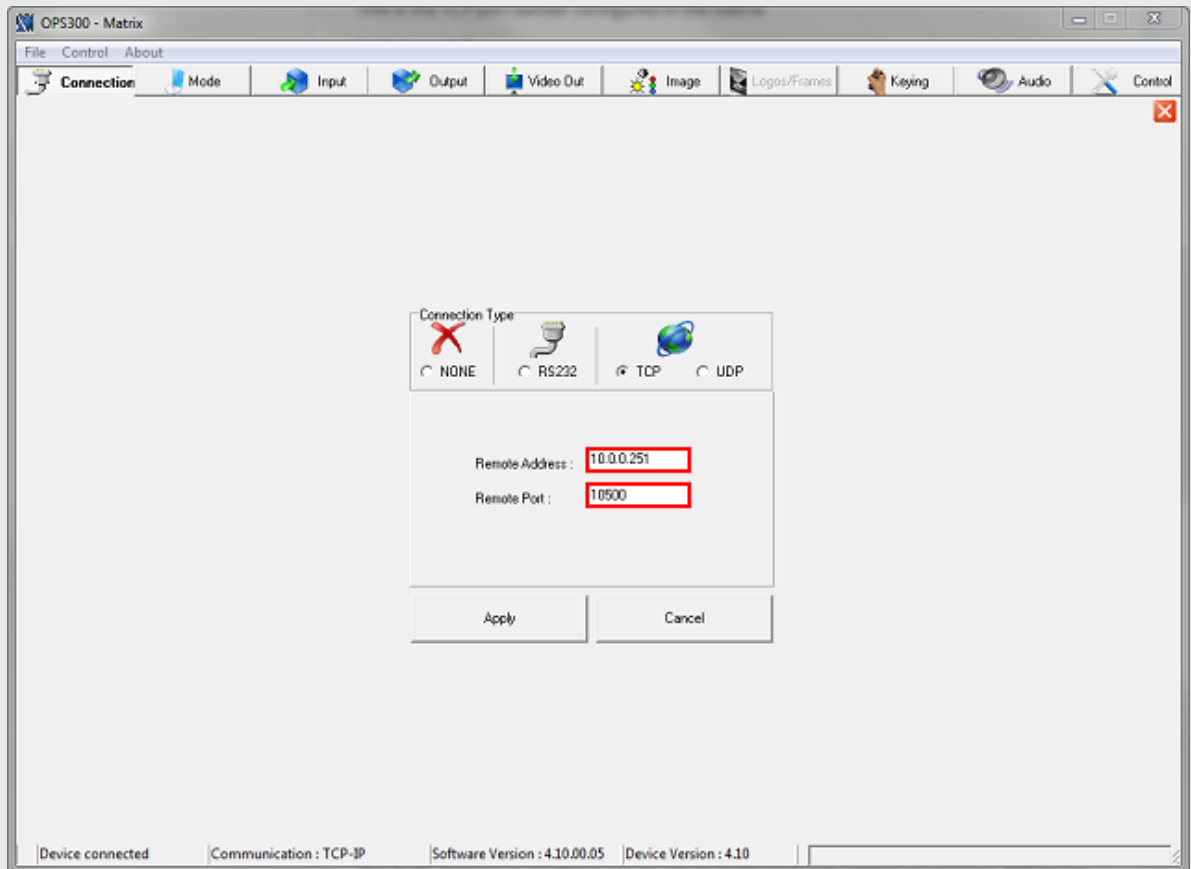

Note down the Remote Address and Remote Port numbers used or set your own from the Analog Way OPS300 Network Settings page

2. Set the matrix to be in the same IP range as the Disguise system.
3. In Disguise software, create an **AnalogWayOPS300** device. An AnalogWayOPS300 device is created in the same way as any other device type. Please see the previous sub-chapter [Creating devices](#) for step-by-step instructions on how to create a device, and select **AnalogWayOPS300** from the menu of different device types. This will open the AnalogWayOPS300 device editor.

4. Configure the device using the properties contained in the AnalogWayOPS300 device editor (explained below).

## AnalogWayOPS300 device properties

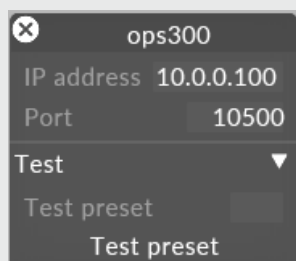

### AnalogWayOPS300 device editor

#### IP address

The IP address of the matrix.

#### Port

The TCP port number configured in the matrix.

#### Test preset

The test preset number

#### Test

This button will set the matrix to the preset set in the **test preset #** property.



# Setup Barco MatrixPro

The Barco MatrixPro can either be controlled via Serial or TCP-IP. If creating a Serial device it will take priority over the IP configuration.

## Setting up a Barco MatrixPro

- In Disguise, create a **BarcoMatrixPro** device. A BarcoMatrixPro device is created in the same way as any other device type. Please see the earlier sub-chapter [Creating devices](#) for step-by-step instructions on how to create a device, and select **BarcoMatrixPro** from the menu of different device types. This will open the BarcoMatrixPro device editor.

## Serial control

- In the **Port** property create a new SerialDevice. Use the same process as that for creating the BarcoMatrixPro device, but select **SerialDevice** from the menu of different device types. If creating a SerialDevice it will take priority over the IP configuration.

## TCP-IP control

1. Configure the Barco MatrixPro to the same IP network as the [Director/Actor network](#).
2. Configure the device using the properties contained in the BarcoMatrixPro device editor (explained below).

# BarcoMatrixPro device properties

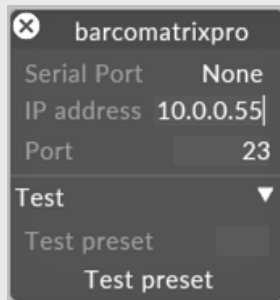

## BarcoMatrixPro device editor

### Port

The UDP port to send commands on.

### IP address

The IP address of the matrix.

### Test preset

The test preset number.

### Test

This will set the matrix to the preset set in the **test preset** property.

# Setup Pure Link Matrix

## Setting up a Pure Linkmatrix

1. Configure the Pure Link matrix to the same IP network as the [Director/Actor network](#).
2. Choose port 23 in the matrix configuration.
3. In Disguise, create a **PureLinkMatrix** device. A PureLinkMatrix device is created in the same way as any other device type. Please see the previous sub-chapter [Creating devices](#) for step-by-step instructions on how to create a device, and select **PureLinkMatrix** from the menu of different device types. This will open the PureLinkMatrix device editor.
4. Configure the device using the properties contained in the device editor (explained below).

## PureLinkMatrix device properties

### IP address

The IP address of the matrix.

### Port

The TCP port number configured in the matrix. Set it to 23.

### Router ID

The ID number set on the matrix.

### Test Input

This input allows you to specify a test input.

## Test Output

This input allows you to specify a test output.

## Test route

Once you have selected a test input & output, click the **Test route** button to confirm whether the routing works.

# Setup Riedel MediorNet

You can control Riedel MediorNet devices from Disguise software.

This topic assumes you have already configured the matrix via the Riedel web interface. It is important to enable the Ember+ 3rd Party interface and assign ID's to the inputs & outputs, as these will be the indices use in Disguise software. Remember to do both **Directions, In** and **Out**. For more information, refer to the Riedel Matrix documentation.

There is a known limitation of only being able to modify video channel connections.

## Setting up a Riedel MediorNet device

- In Disguise software, create a **MediorNet matrix** device. A MediorNet device is created in the same way as any other device type. Please see the earlier sub-chapter [Creating devices](#) for step-by-step instructions on how to create a device, and select **MediorNet Matrix** from the menu of different device types. This will open the MediorNet Matrix device editor.

## TCP-IP control

1. Configure the MediorNet Matrix to the same IP range as the [Director/ Actor network](#).
2. Configure the device using the properties contained in the MediorNet Matrix device editor.

# MediorNet Matrix device properties

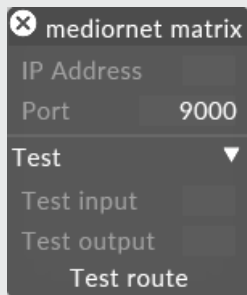

## MediorNet Matrix device editor

### IP address

The IP address of the matrix.

### Port

The UDP port to send commands on.

### Test input

The test input number.

### Test output

The test output number.

# Setup Blackmagic Smart Video Hub

The Blackmagic Smart Video Hub is a suitable Matrix for use with Disguise software.

## Example

1. Create a telnet device with the appropriate IP address and port (default 9990).
2. Create a TelnetDVIMatrix device, assign it the Telnet device you just created.
3. In the "route" field of the TelnetDVIMatrix device, type the following string:  
VIDEO OUTPUT ROUTING:\n\$2 \$1\n\n  
This is the telnet command used to issue a remote routing change to the Videohub, with "\$2" and "\$1" as placeholders for output and input respectively.

## Using a Blackmagic Smart Video Hub for failover in a Director and Understudy setup

1. Add a BlackmagicVideoHubMatrix.
2. Add the IP address and port number.
3. Test the routing working by entering an input/output routing.

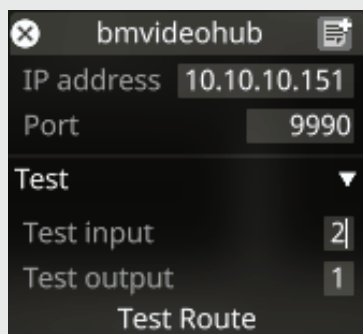

4. In d3Net Manager, assign the director and understudy.
5. Then assign the patch accordingly in the "matrix inputs."

6. On Failover, this will switch the device routing as specified.

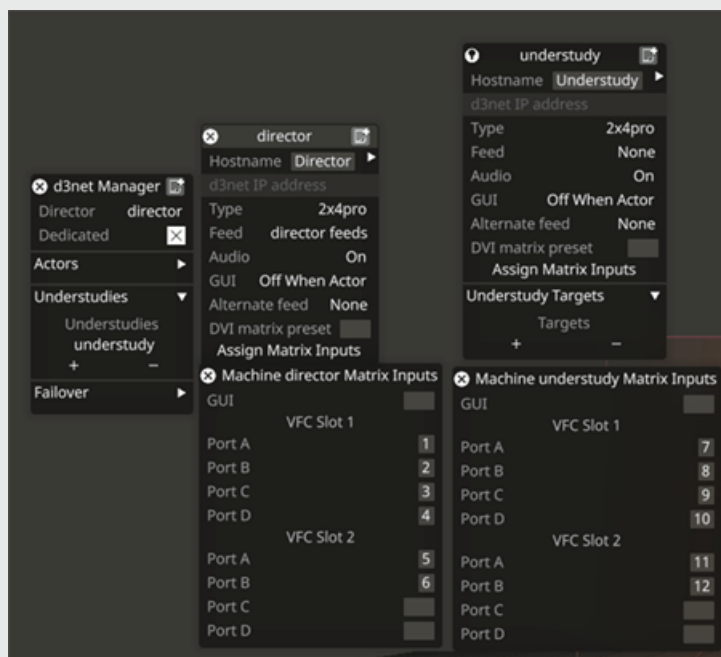



# Setup Lightware Matrix

## Setting up a Lightware matrix

1. Configure the Lightware matrix to the same IP network as the Director/Actor network.
2. Choose port 10001 in the matrix configuration.
3. In Disguise, create a **LightwareMatrix** device. A LightwareMatrix device is created in the same way as any other device type. Please see the previous sub-chapter Creating devices for step-by-step instructions on how to create a device, and select **LightwareMatrix** from the menu of different device types. This will open the LightwareMatrix device editor.
4. Configure the device using the properties contained in the LightwareMatrix device editor (explained below).

**Please note:** Currently only the LW2 protocol can be used to configure the Lightware matrix and the disguise software. Newly released devices from Lightware use LW3 protocol; therefore LW2 must be enabled in the Lightware Device software in order to be used with disguise.

# LightwareMatrix device properties

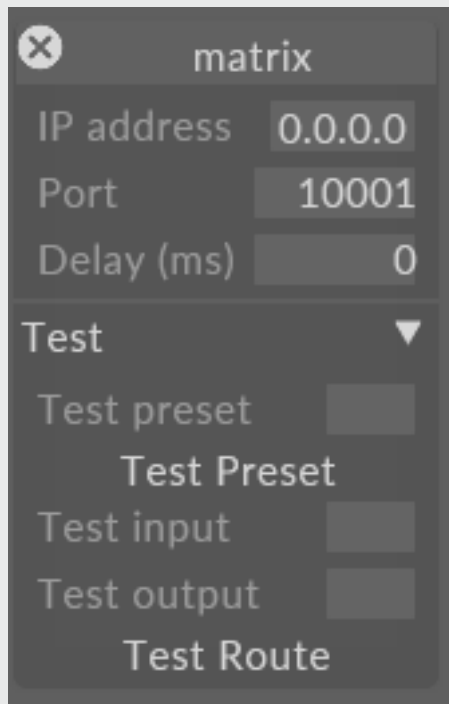

## IP address

The IP address of the matrix.

## Port

The TCP port number configured in the matrix. Set it to 10001.

## Test preset

The test preset number.

## Test

This button will set the matrix to the preset set in the **test preset** property.

# Setup Telnet Matrix

The TelnetMatrix device can control any matrices that support telnet.

## Setting up a TelnetMatrix

- In Disguise, create a **TelnetMatrix** device. A TelnetMatrix device is created in the same way as any other device type. Please see the earlier sub-chapter [Creating devices](#) for step-by-step instructions on how to create a device, and select **TelnetMatrix** from the menu of different device types. This will open the TelnetMatrix device editor.

## TelnetMatrix device properties

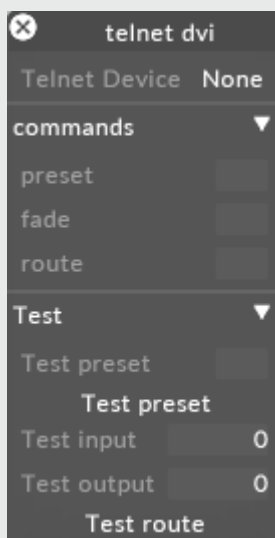

# TelnetMatrix device editor

## Telnet Device

Defines the Telnet device to send commands to.

## Commands

**Preset** defines the preset number to trigger.

**Fade** defines the fade time.

**Route** defines the routing information.

## Test

**Test preset** - enter the preset to test and click the **Test Preset** button to trigger the test.

**Test input** - enter the direct matrix input

**Test output** - enter the direct matrix output

**Test Route** - once the input and output is defined, click the **Test Route** - button to test the matrix routing.

The TelnetMatrix uses the same syntax for the preset, route and fade commands as the control layer except for the following:

- **Preset** : \$1 = preset as ASCII, %1 = preset as binary
- **Route** : \$1 = input as ASCII, %1 = input as binary, \$2 = output as ASCII, %2 = output as binary
- **Fade** : \$1 = transition time as ASCII, %1 = transition time as binary

## Common strings for TelnetMatrix device

**Kramer DVI Matrix** - #35PRST-RCL \$1\n

**Extron DMS 3600 Matrix** - \$1.

**Gefen 8x8 DVIKVM DL** - #callpreset \$1\n would send #callpreset 6\n if you recalled preset 6.

#doroute \$1\$2\n would send #doroute 3 5\n" if you switched input 3 to output 5.

**Extron Matrix Switcher** - \27R\$1PRST\13\10

**Barco Encore2 (E2)** - PRESET -a \$1\r\n

ROUTE \$1\$2

Where 1 is input, 2 is output.

**Barco MatrixPro** - RPRST \$1\r

**IDK Matrix** - Preset - @RPM,\$1\r\n

Route - @IOS,\$1,\$2\r\n

**Please note:** It is typically required to use `\13\10` or `\r\n` (Carriage Return) at the end of a command string. More examples of ascii and hex command strings can be found [here](#)

# Setup video input

This topic covers how to set up video inputs in Disguise software, including SDI and NDI sources.

## Sources

Disguise offers the ability to capture video from a number of sources.

- 3G/HD/SD-SDI capture sources on Disguise hardware. See hardware manual for capabilities.
- DirectShow devices (intended for testing only, limited support, not for use on shows)
- NDI sources, when an NDI source is present on the network.

**Please note:** As of r17, NDI input is fully supported and does not require an option switch. Should an NDI input fail, Disguise software will periodically attempt to restart the stream. The NDI version that Disguise software supports can be downloaded from our [Resources](#) page

## Concepts

Video capture is managed by the Video Input Patch manager, accessible via the Devices menu item.

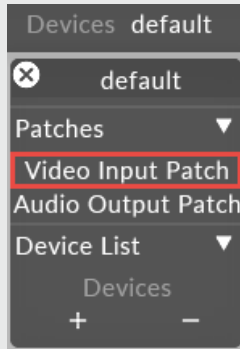

Video Input Clips are essentially 'virtual slots' into which you can patch physical capture inputs for each machine in your d3 setup. You can have as many Video Input Clips as you wish, they are labelled `videoin_1.mov` and upwards by default.

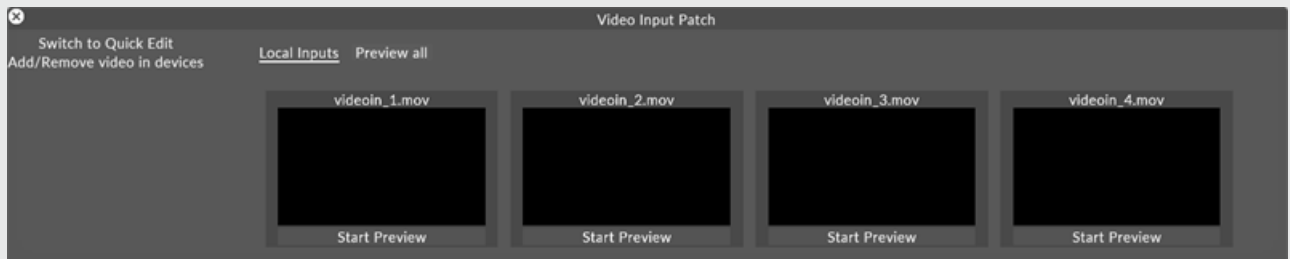

**Local inputs:** shows only the local incoming signals on the selected machine.

**Preview all:** shows all incoming signals on the selected machine.

**Switch to quick edit:** changes the format of the editor to a list view, for quick group editing of properties.

**Add/Remove video in devices:** opens the logicalVideoIn editor, allowing you to create new inputs and duplicate existing ones.



Each Video Input Clip can be selected by left clicking its thumbnail in the editor and the following properties appear on the left hand side of the editor.

**Placeholder Image:** If no capture device is mapped locally for this Video Input Clip, the Placeholder Image will be shown instead. This is useful for pre-site sequencing.

**Input:** The physical input that the source is coming through on the machine.

**Format:** The desired format that you wish to capture for this Video Input Clip. If the desired capture format is not supported on the mapped capture device, Disguise will attempt to find the closest match.

**Local Preview:** A preview of the input selected on the local machine. You can start and stop the preview using the button below the thumbnail.

**Start/Stop preview:** this button below the thumbnail will toggle from showing nothing, to showing the current input. When you select **stop preview**, the thumbnail will return to black, but the video input is still being received.

## Configuration - Step by step

To configure a Video Input Clip execute the following steps

1. Ensure your video source is connected correctly (via SDI etc)
2. Right-click **devices** in the dashboard.
3. Left-click **Video Input Patch**.

By default, four Video Input Clips will be presented to you. Or if you are on a piece of Disguise hardware, whatever number of physical inputs the hardware has, will be displayed.



In the **Devices** section, you will find your local machine as the first item. Select the input source connection for your local machine (e.g. Bluefish 1A or Phoenix 1A).

4. For 4U v2.5 and older systems, you will need to select the **Format** of the source signal. On Pro and GX range machines, the signal will be auto-detected.

The live picture from this capture source will now show in the **Local Preview** section (only once you have clicked **start preview**).

You can now use the `videoin_1.mov` clip as a live source in the Video Content Layer on the timeline (see below).

## Duplicating video input sources

Sometimes it may be necessary to duplicate the video input sources, to gain additional virtual capture 'slots'. This can be useful for looping back internal cameras or for use with NDI.

1. Open the video clip editor by right clicking a video clip from the media picker.
2. Select **duplicate** and give the new input a name.

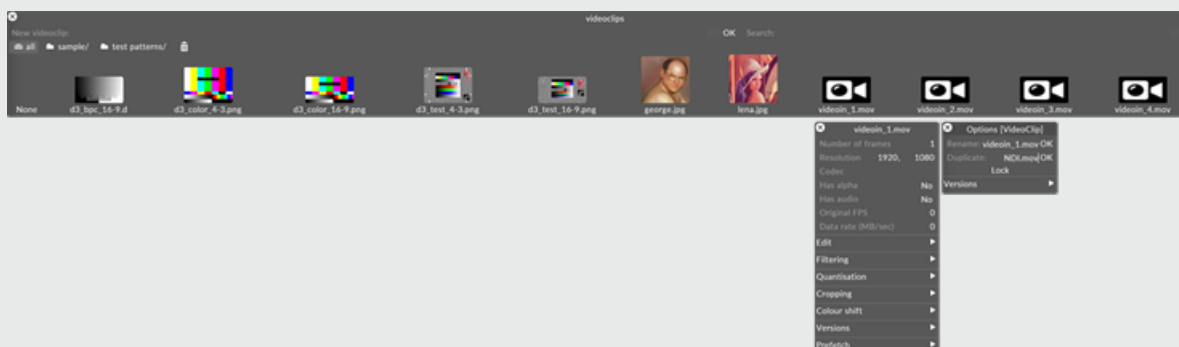

3. The new video input will now be available in the video input patch editor.

## Working with live video on the timeline

Live video is applied to the video keyframe editor using the special Video Input Clips: `videoin_1`, `videoin_2`, `videoin_3` and `videoin_4` respectively. As soon as the video inputs are configured, they are

treated just like normal video clips.

- For example, drop **videoin1** onto the keyframe editor to route video from the first sampler in the device manager, and so on.
- Use the appropriate Mapping type to map the camera input to the screens.
- Right-clicking the **videoin** thumbnail lets you edit colour correction and other clip properties, just like normal clips.

# 4k quad link capture

r14.3 introduced additional video capture functionality to enable 4K Quad link Capture over SDI.



**Warning: 4k Quad Capture is only supported on Pro and Gx machines, with the exception of gx 1.**

## Setting up Quad link 4k Capture

Right Click on **Devices** and then click onto **Video Input Patch Editor...** When opening the editor and left clicking on Input on one of the Video In Patches, there is the option for **New Capture Group** in the **Input** field.

When selecting this you will get an unmapped quad capture group.

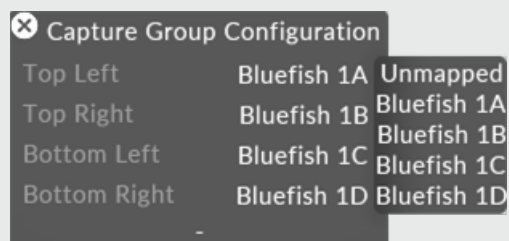

From there you can select and choose the input for that quad capture group i.e. Bluefish 1A/ 1B/ 1C/ 1D.

**Please note:** you cannot choose the integrated Webcam or any external capture cards for this feature.

To be able to do dual capture group, press the minus - symbol at the bottom of the capture group to make it Dual rather than Quad.

A key part to remember is to respect the Bandwidth of the Capture card. For more information contact [support@disguise.one](mailto:support@disguise.one).

# CITP

CITP is a protocol used by lighting desks for the transfer of thumbnails and asset specific naming for previewing when programming.

## Using CITP

- GrandMA2 3.12.5 supported. Version after 3.2.2.3 should also work.
- Hog OS 3.5.0
- CITP devices join with both multicast addresses, 224.0.0.180 and 239.224.0.180, and in that order.

## In Disguise software:

1. Right-click on Devices.
2. Create a new DMX Device.
3. Insert the desk's IP Address (this should ideally be set up on an isolated Art-Net switch).
4. Create a CITP Device and assign the DMX Device to it.
5. Add a Video Layer, assign a DMX patch to it.
6. Open the Bank Editor and populate the Video banks.

## In GrandMA2:

1. Go to Setup > CITP Network Configuration.
2. In the top-right corner of the windows that opens, ensure you set CITP to Enabled (the box should look green once you click it).
3. Right-click on "New" under the MediaServers tab.
4. The Disguise machine should appear in the list here. Click to select it.
5. Select a fixture layer (one with a Video layer fixture patched to it).
6. Select a Library SubAttribute (any sub-attribute seems to work as Disguise doesn't use this.)
7. Select an Image SubAttribute (this needs to be set to Video Slot)
8. Click on Update Thumbnails
9. Select the Video layerFixture and navigate to the Video Slot attribute
10. Clicking on the attribute should now display clickable thumbnails and file names on the lighting desk software

**Please note:** If the machine does not appear in the MediaServers list, double-check connection settings (use the DMX Monitor to ensure DMX is being received) and ensure the CITP Device is in the Device List.

# Device Recording

Device Recording is a tool to record the incoming data streams of different Devices (DMX, Automation & MIDI) for later playback without needing the device attached.



**Warning:** Once a device recording is deleted, it cannot be retrieved. This is because Disguise software treats recording files as content.

This can be useful for recording specific automation control data and enable the programmer to be able to play this data back into the system without the need of the operator being on hand.

## Using Device Recording

There are three modes for Device Recording; Live, Play & Record.

**Live:** Only the incoming 'Live' data will be actively allowed into Disguise software.

**Play:** Only the recorded data will be actively played back into Disguise software.

**Record:** That device is primed to record the incoming data into Disguise software.

To set it up:

1. Add either a MIDI, DMX or Automation Device to your device list and set them up appropriately.
2. Observe the change to the GUI:



These headings are created in the d3state bar to show that there are devices that are able to be recorded. There is a little symbol next to each indicating the mode the device is currently sitting in. As shown in the image above, these are currently set to live and will react to the incoming data. A small triangle 'play' symbol indicates the device is set to playback the recordings available, and a small circle indicates it is primed for recording.

- If you right click on the heading of the device you would like to set up for recording a new window appears.

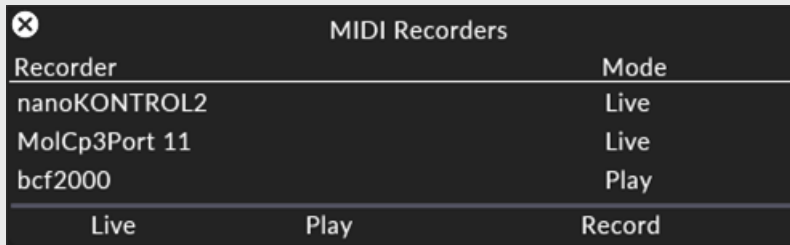

MIDI Recorders		
Recorder	Mode	
nanoKONTROL2	Live	
MolCp3Port 11	Live	
bcf2000	Play	
	Live	Play
		Record

Here you see the list of MIDI devices that are ready for recording. The devices are listed to the left, with the current mode on the right.

- A right click on the mode for each device will bring up another window where you can change the mode of the device.

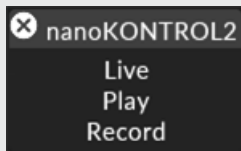

Whereas, the buttons along the bottom of the window are the global mode controls for the device type (changes all modes for the recorder).

- If we take the nanoKONTROL2 for example, it is currently set to Live and we want to record this devices input. To do this, right click on the mode for the device and set it to record. This will tell d3 we want to record this devices input.

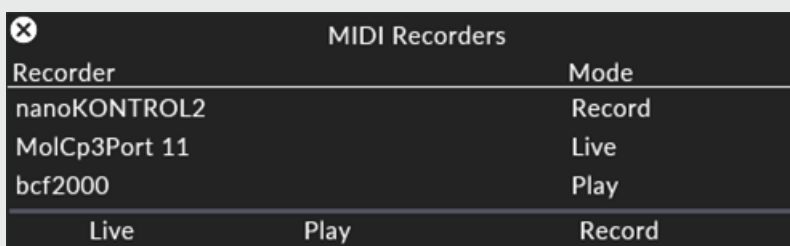

MIDI Recorders		
Recorder	Mode	
nanoKONTROL2	Record	
MolCp3Port 11	Live	
bcf2000	Play	
	Live	Play
		Record

- If you look to the transport controls on the timeline, you will notice an addition to the UI. A Small circle has been added next to the track change controls, this is the record button for Device Recording. With the device set up as above, this can be selected to prime the recording fully. If no device has been set to record, a pop up will appear alerting that this cannot be used as no devices are ready for recording. When it is primed successfully, it will turn red to show the change.



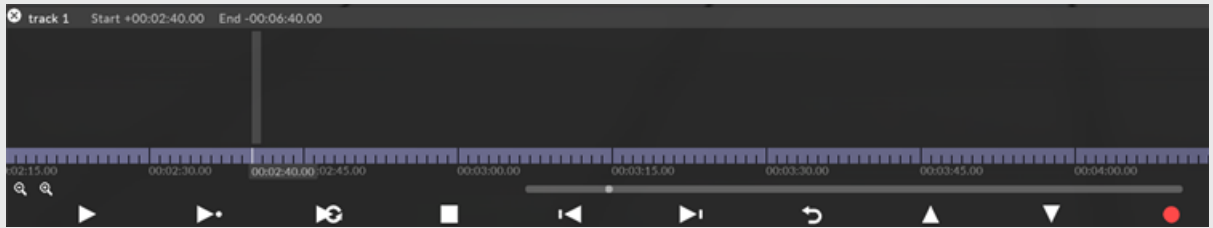

7. Now the track is ready to record the input so simply hitting play will start the recording and you will notice a new layer being created as the input stream is being received. This will grow as the recording grows with it. When you have captured all the data you want to record, hitting stop will cease the recording. All device recordings are saved under this tab and individual tabs are created for each device that has made a recording.

The recordings that have been made cannot output yet as they need to be set to 'Play' in the mode of the recorder.

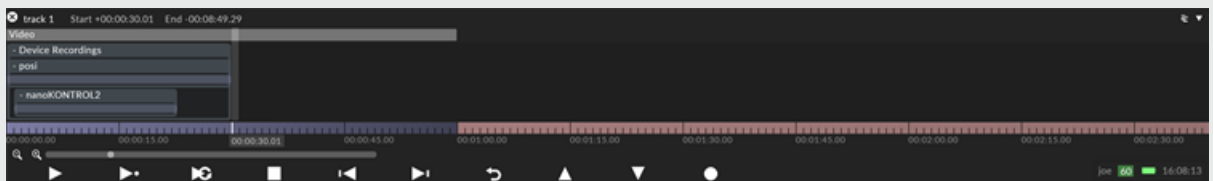

8. Each recording that is made has 3 settings when right clicked on; Disable (Stops outputting the recording), Reset (Puts the recording back to where it originated if it has been moved or edited) and Delete (Deletes the recording entirely - THIS CANNOT BE UNDONE)

**Please note:** Recordings are saved as .rec files and are stored in the object folder under recordingfiles. These are treated just like any other asset however they are highly reliant on project specific settings such as sections, cues, notes etc so may not work in other projects. As with any asset, they will need copying over to other machines in the same network environment (for example a slave) for them to function correctly.

# Expressions

## Expressions for numeric animations

Expressions allow you to have a more powerful control over animation properties. They can be used with any numeric animation property.



**Warning:** Disguise software does not support expressions that uses layer names that has spaces between the words, for example "video explosions". In this case you have to rename it to "video\_explosions". Expressions can only contain a-z A-Z 0-9 \_

## Setting up Expressions

To set up an Expression, right-click the property you want to control. This will open up the min/max/step viewer, which allows you to edit the limit values of the property and the value step used while animating. Below the min/max/step properties is a field called Expression, which initially contains a single word: **self**. This is the Expression.



The easiest Expression is **self**. It tells the system to use the value taken from the keyframe sequence. However, self can be built into more complex mathematical Expressions (formulae) to do useful things, such as :

**self \* 2**

**255 \* self multiplies the animated value by 255.**

When you type in an Expression, the property field turns green when the Expression has been correctly understood. If there is a mistake, the property field turns red; moving the mouse over the property field will open up a text message telling you what went wrong.

Expressions can refer to any property of any other object in the system. For example, if you want to read the x coordinate of the position of a screen called myscreen and multiply it by 2. The Expression to use would be:

**screen:mymScreen.pos.x \* 2**

In general, to access (property) of an object called (objectName) of type (type), we use:

**type:objectName.property**

## Expanded Functionality - r21

In previous releases, Expressions could only access keyframed values. Module/layer expressions were hard-coded to only support field sequences.

As of r21, the functionality of Expressions has been improved, enabling them to be used in all modules in Disguise software.

Support for properties like **frameNumberDisplay** - the current frame readout at the top of the video layer - have been added for additional functionality.

This new feature allows for an expression to be created that has the ability to get information about a resource, and they can be used with all module properties which have existed previously and any new ones that are to be added.

An example of where this can now be used is in the case of fading the brightness down at the end of a clip; an expression can now be used on the brightness field that reads the frame index to do the fade.

Example expression used on Brightness field:

**if(module:video.frameNumberDisplay >= 50, 0.5, 1.0)**

# Output Feeds overview

The Output Feeds level contains **Feed scenes**.

A Feed scene controls how content is copied and arranged from screens in the Stage level onto the physical output heads.

**Stage**



**Feed Scene**

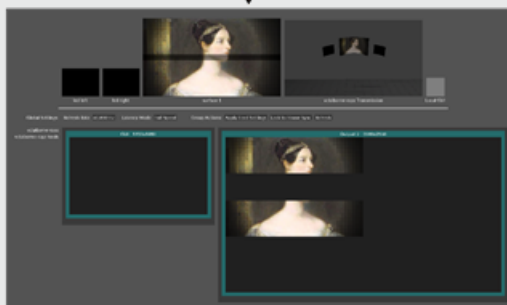

*Conceptual diagram illustrating how Feeds scenes in the Feed level are used to copy content arranged from screens in the Stage level*

Each Feed scene contains a list of Feed rectangles. Each Feed rectangle specifies how content is being transferred from a Screen and where on the output heads that content will arrive. Screen content is copied from the Stage and moved, cropped, scaled and/or rotated to its final position on an output head.

Each Feed scene can contain multiple Feed rectangles for each Screen, so it is possible to break up the content into smaller sections and rearrange these as required. Read the sections below for more information.

# Rendering Feed movies

The Disguise software can be used to play back media using a conventional media server by rendering the outputs into **Feed movies**. For more information please see the chapter [Rendering Video](#) page.

# Output Feeds overview

The Output Feeds level contains **Feed scenes**.

A Feed scene controls how content is copied and arranged from screens in the Stage level onto the physical output heads.

**Stage**



**Feed Scene**

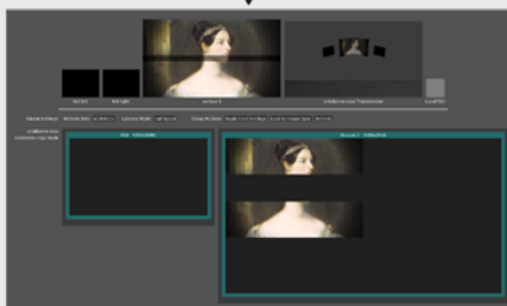

*Conceptual diagram illustrating how Feeds scenes in the Feed level are used to copy content arranged from screens in the Stage level*

Each Feed scene contains a list of Feed rectangles. Each Feed rectangle specifies how content is being transferred from a Screen and where on the output heads that content will arrive. Screen content is copied from the Stage and moved, cropped, scaled and/or rotated to its final position on an output head.

Each Feed scene can contain multiple Feed rectangles for each Screen, so it is possible to break up the content into smaller sections and rearrange these as required. Read the sections below for more information.

# Rendering Feed movies

The Disguise software can be used to play back media using a conventional media server by rendering the outputs into **Feed movies**. For more information please see the chapter [Rendering Video](#) page.

# Viewing the Feed level

To see what the current Feed scene looks like, left-click Feed in the dashboard. This swaps the Stage Visualiser with the Feed Visualiser view.

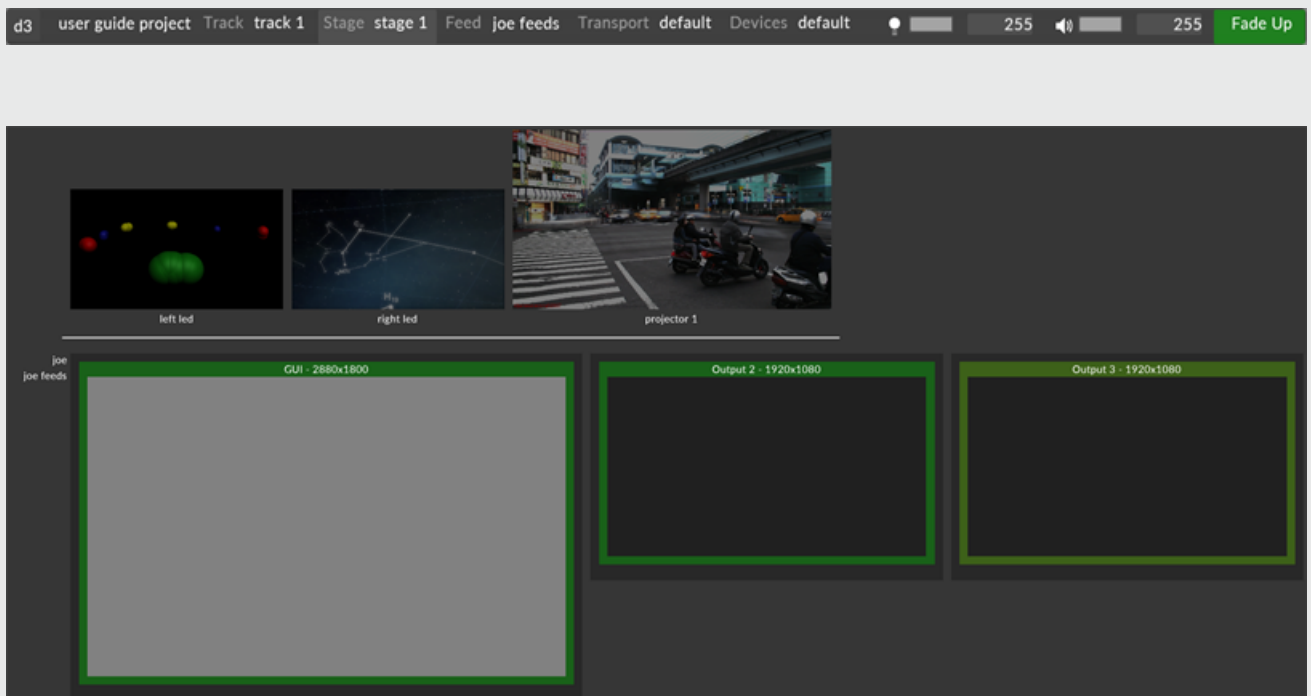

The Feed level is split into two sections: Screen section and Feed scenes, separated by a white horizontal line

The display is split into two sections, separated by a thick white horizontal line which separates the screen rectangles in the current stage above the line from the physical outputs below the line.



# Screen section

Above the line, you see a simplified view of the Screens in the Stage. Each Screen is represented by a rectangle containing its content. In the Screen section, the screen rectangle represents the area of the screen the rectangle copies content from.



# Feed scene

Below the white line, you see a virtual view of each of the output heads on your machine, or a virtual machine if you are using Designer, for example. In this Feed scene below the line, the green rectangles represent the area of the output display the content is to be copied to.

Each Feed rectangle is visible in both sections.

The Feed section is made up of a series of different displays.

# GUI (Graphical User Interface)

The GUI always represents the first display in the Feed scene and is therefore visually represented as the output display to the very left of the Feed scene. Note that the GUI can also be used as an output display if you add one (or more) Feed rectangles to the GUI display.

# Displays / Virtual Displays

The Display always represents the second or more displays in the Feed scene and is therefore visually represented as the output display to the very right of the Feed scene. The Disguise software will automatically detect the graphic capabilities of the machine it's connected to and create output heads based on that information.

# Feed level navigation

## Panning the viewpoint

- Hold down the mouse scroll wheel and drag.
- Hold down the **Tab** key and move the mouse left/right/up/down.

**Please note:** do not hold down either mouse button; this will only work when the Feed level has focus.

## Zooming in and out

### Option 1

- Scroll the mouse wheel up/down to zoom in/out.

## Option 2

- Hold down the right mouse button and drag the mouse down to zoom in.
- Hold down the right mouse button and drag the mouse up to zoom out.

## More options

- Hit **1** to go to 1:1 zoom level (where each pixel on the monitor is equal to one pixel on the actual output head).
- Hit **F** to focus on selected rectangles.
- Hit **A** to view all of the Screens and output heads.

## Toggling between Display heads

1. Hit **Alt-F** to view the Feed rectangles in your Display heads pixel-perfectly.
2. Repeat hitting **Alt-F** to toggle each display head in pixel-perfect full screen mode in chronological order. This is very useful for when you want to make a pixel-perfect screenshot of the output display. To do so, first toggle to the output display and click **Alt-X**. You can also export the position and pixel dimension data as a table (readable in for example Excel). For more information please scroll down to the section [Export as table in the Feed rectangle editor sub-chapter](#).

**Please note:** these will only work if the Feed level has mouse focus; i.e. you should have clicked the background before these will work.

# Selecting feed rectangles

## Select a rectangle

- Left-click a rectangle to select a rectangle. When you continue clicking, you uncover more rectangles that may overlay each other.

## Selecting multiple rectangles

- Working with more than one Feed rectangle at a time is very common. Multi-select the rectangles by holding down the left-mouse button and drag.

## Toggling through rectangles

- **Ctrl**-clicking Feed rectangles toggles their selection, allowing you to extend the selection across areas which are not next to one another.

# Selecting Feed rectangles

There are three techniques for selecting rectangles:

## Uncovering rectangles

- Left click a rectangle to select one rectangle. When you continue clicking, you uncover more rectangles that share the same position but are hidden behind another rectangle.

## Selecting multiple rectangles

- Working with more than one Feed rectangle at a time is very common. Left clicking and dragging the mouse will select all rectangles which touch the area dragged over by the mouse.

## Toggling through rectangles

- **Ctrl**-clicking Feed rectangles toggles their selection, allowing you to extend the selection across areas which are not next to one another.

# Adding Feed rectangles for screens



**Warning:** Feed rectangles flash blue, every 5 minutes in the GUI. This is to prevent the GUI head being used as an un-authorized output. The blue flash is not visible on the outputs.

The image here shows a Screen in the Stage Visualiser:

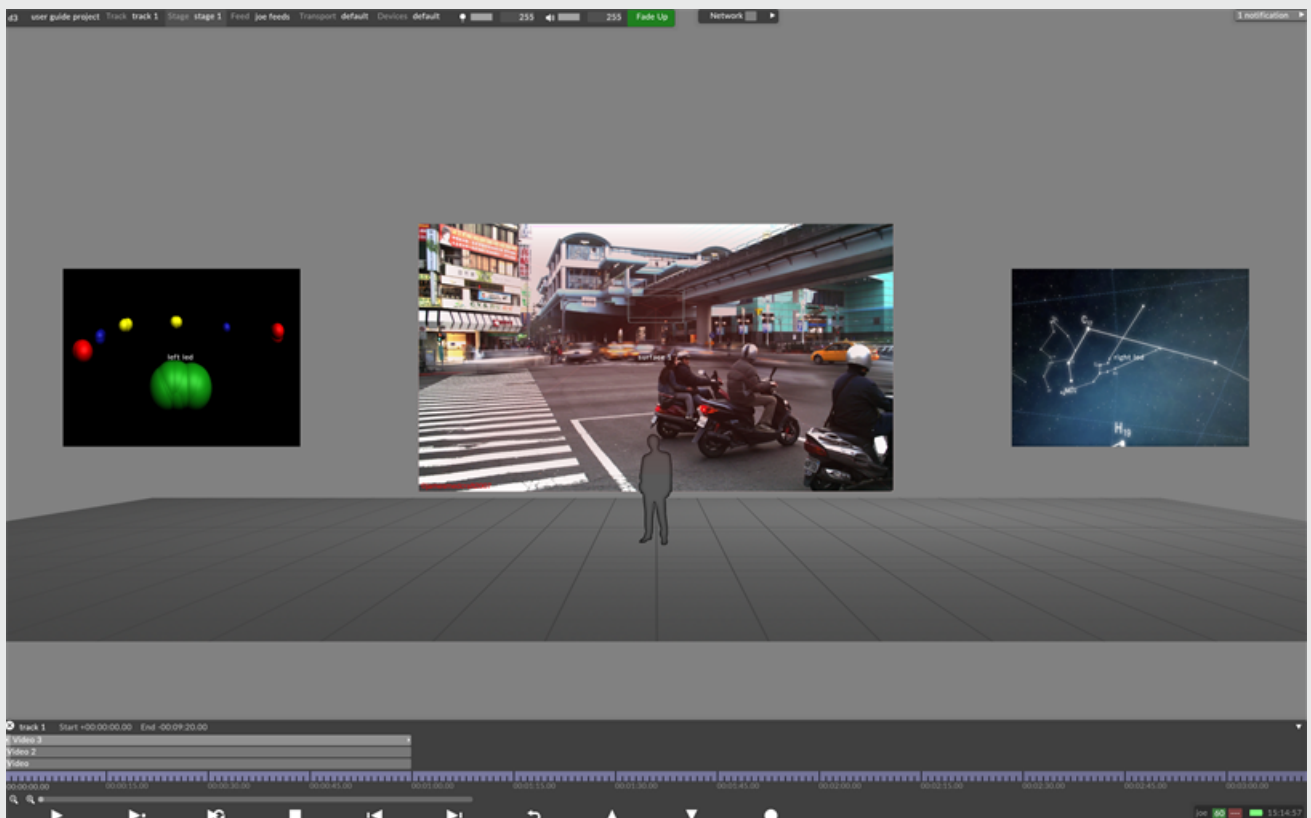

1. Left-click **feed** in the State editor (bar at the top of the screen). This will switch the Stage level with the Feed level. The Screen section (top half of the Feed level) now shows a simplified view of the Screen or the virtual projector output, depending on the type.

Screens from the Stage level are displayed in the Screen section (top half of the Feed level)

2. Right-click the Screen you want to create a Feed rectangle for. This will open the Feed rectangle menu.

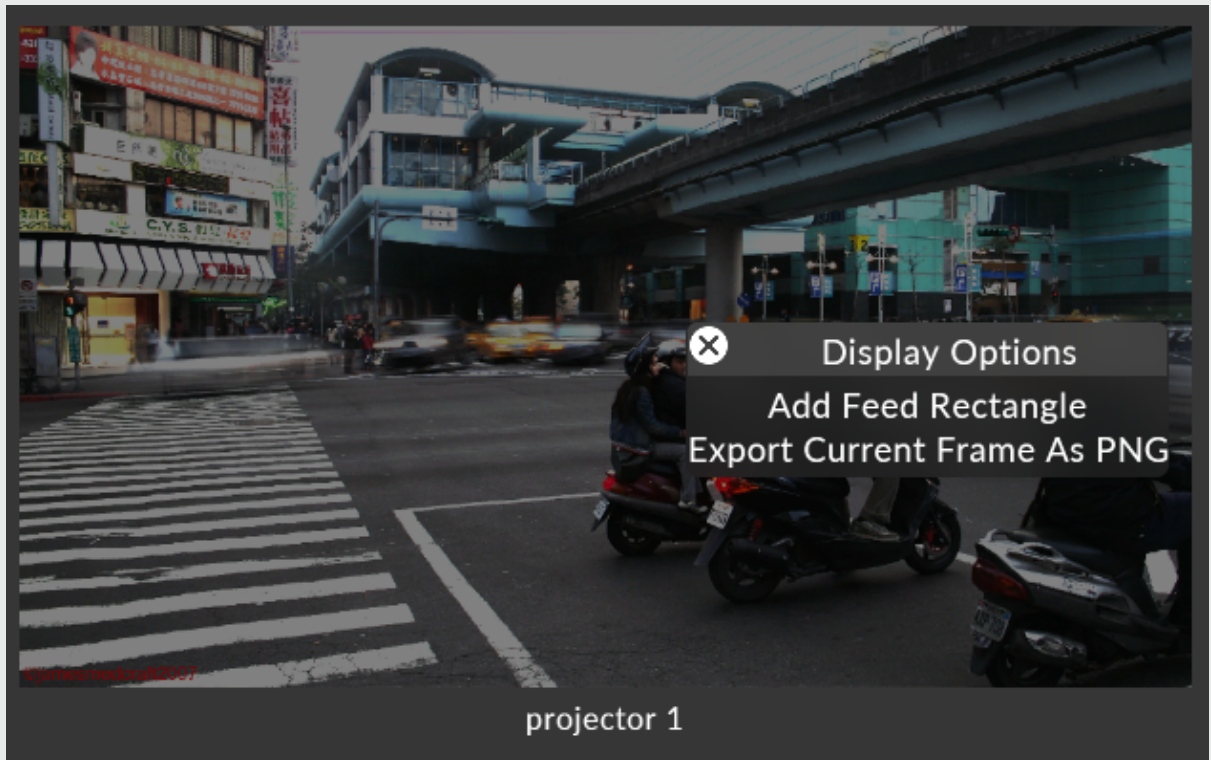

3. Left-click **add feed rectangle**. This will create the Feed rectangle.



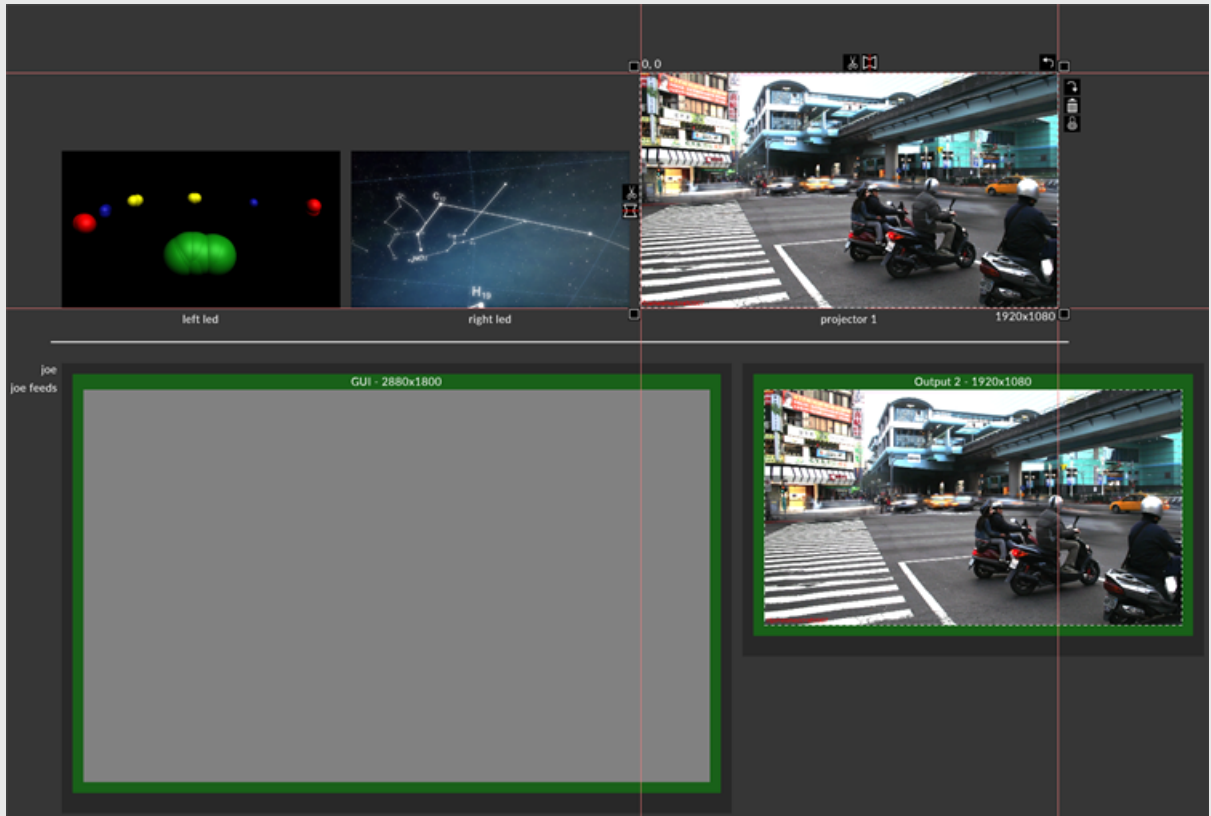

Feed rectangle samples content from the Screen you right-clicked to the output head, in this example Output 2

The Feed rectangle samples the whole of the Screen you right-clicked. The output head of the Feed rectangle, in this example Output 2, represents the area of the output display the content is copied to.

**Please note:** Feed rectangles can also be easily and quickly created using the Alt+Left Click shortcut to drag an arrow from a screen onto an output. To do this, simply press and hold the Alt key as you Left Click, hold and drag the mouse from a stage screen above the line to a desired output below it.

# Editing a Feed Rectangle

## Editing a feed rectangle

- Left-click the Feed rectangle. This will select the Feed rectangle and show a series of controls.

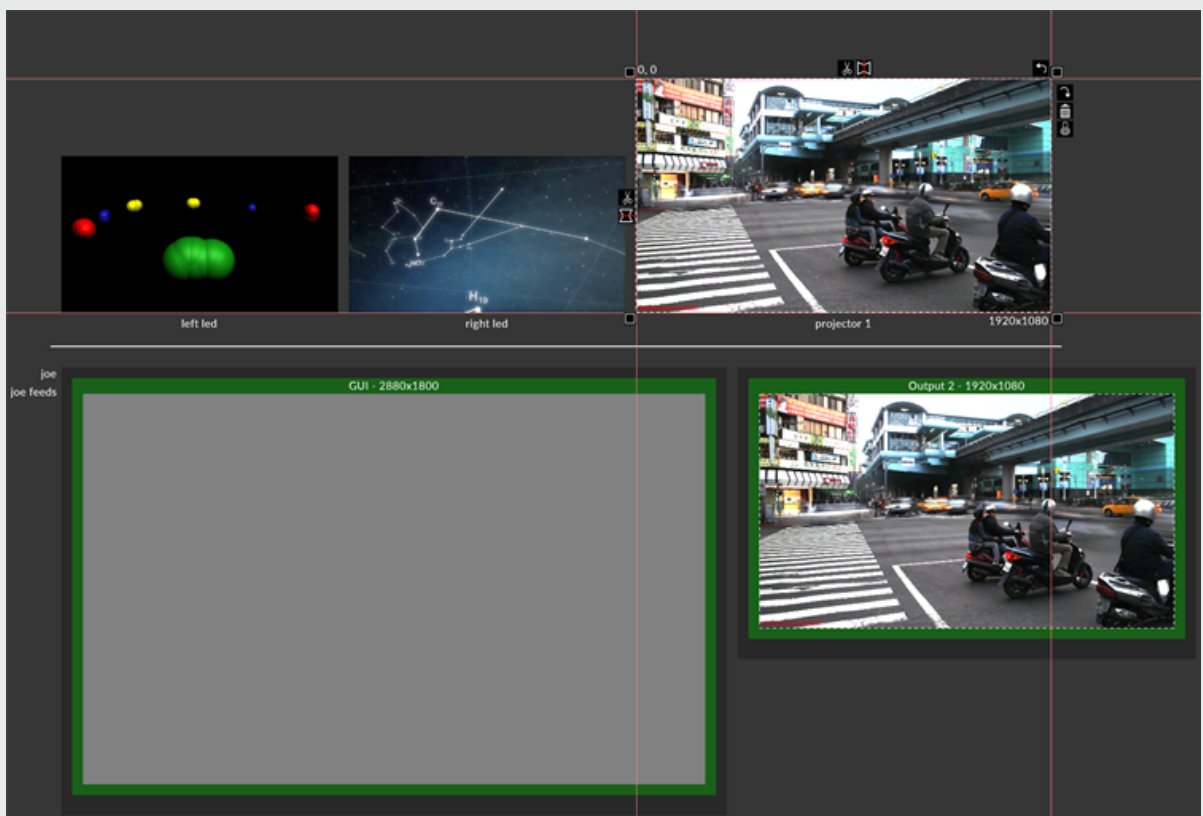

Quick editing controls for a Feed/sample rectangle, opened by left-clicking a Feed/sample rectangle

## Resize

The square shaped controls enable you to resize a Feed rectangle.



Square shaped controls are used to resize a Feed/sample rectangle

**Please note:** hold **Shift** whilst resizing to maintain the rectangles aspect ratio.

## Lock

The Lock control locks the current scale factor between the source and destination rectangles.



Lock control is used to lock the current scale factor between a sample rectangle and a Feed rectangle

## Resize while locked

When the Feed rectangle is locked, resizing the Feed rectangle resizes the Sample rectangle and vice versa.

- Left-click and drag a square shaped control to resize the Feed rectangle. In this example, we have used the right middle control to reduce the size of the Feed rectangle.



Lock control is locked causing the sample rectangle to resize when the Feed rectangle is resized, and vice versa

# Resize while unlocked

When the Feed rectangle is unlocked, resizing the Feed rectangle does not resize the Sample rectangle and vice versa.



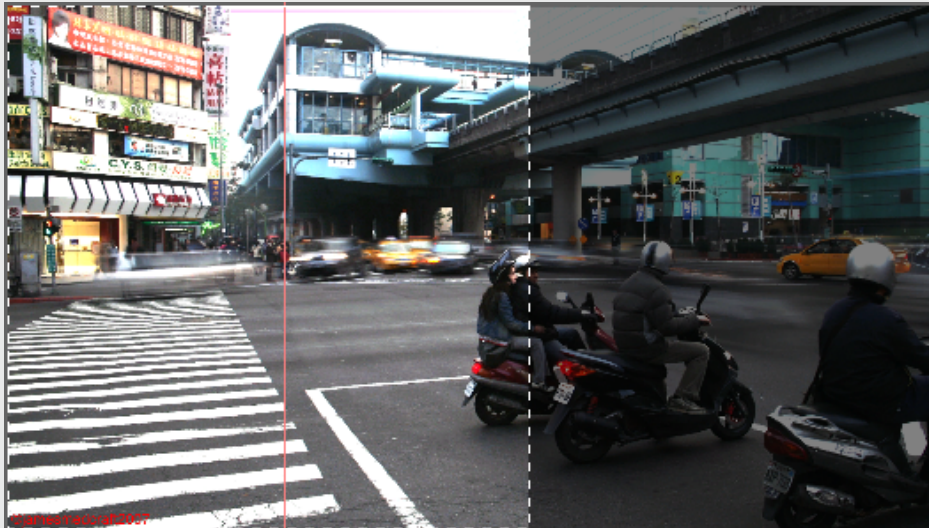

projector 1



Lock control is unlocked causing the sample rectangle to retain its size when the Feed rectangle is resized, and vice versa

## Split

The Scissor control enables you to split a Feed rectangle into smaller Feed rectangles.

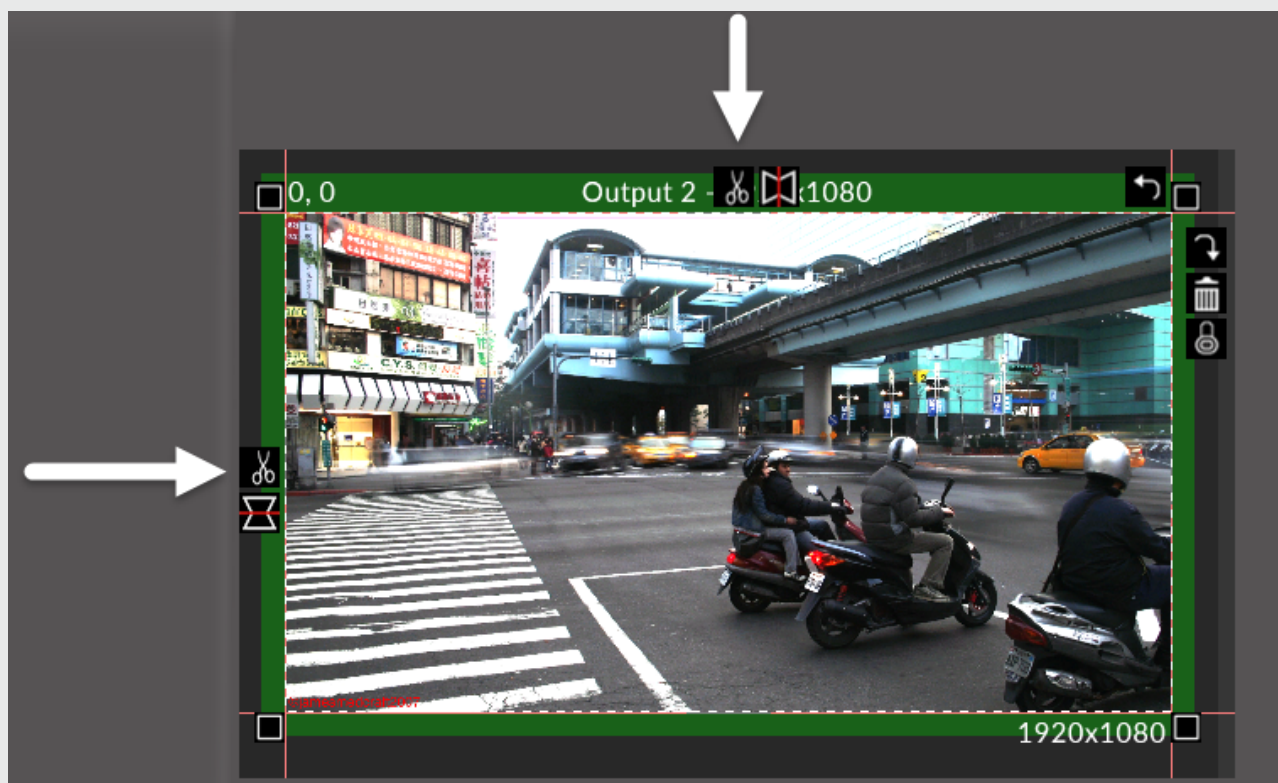

Scissor controls are used to split a Feed/sample rectangle into smaller Feed/sample rectangles

1. Left-click and drag the scissor. You will see a dashed white line that represents the line where the Feed rectangle will be split.





Splitting a Feed rectangle by click-dragging a Scissor control, the white dashed line represents where the Feed rectangle will be split

2. Release the left mouse button when you are happy with the position of the splitting line. The Feed rectangle will now be split into two rectangles.

## Mirror

The Mirror control enables you to flip the Sample rectangle or Feed rectangle horizontally or vertically.

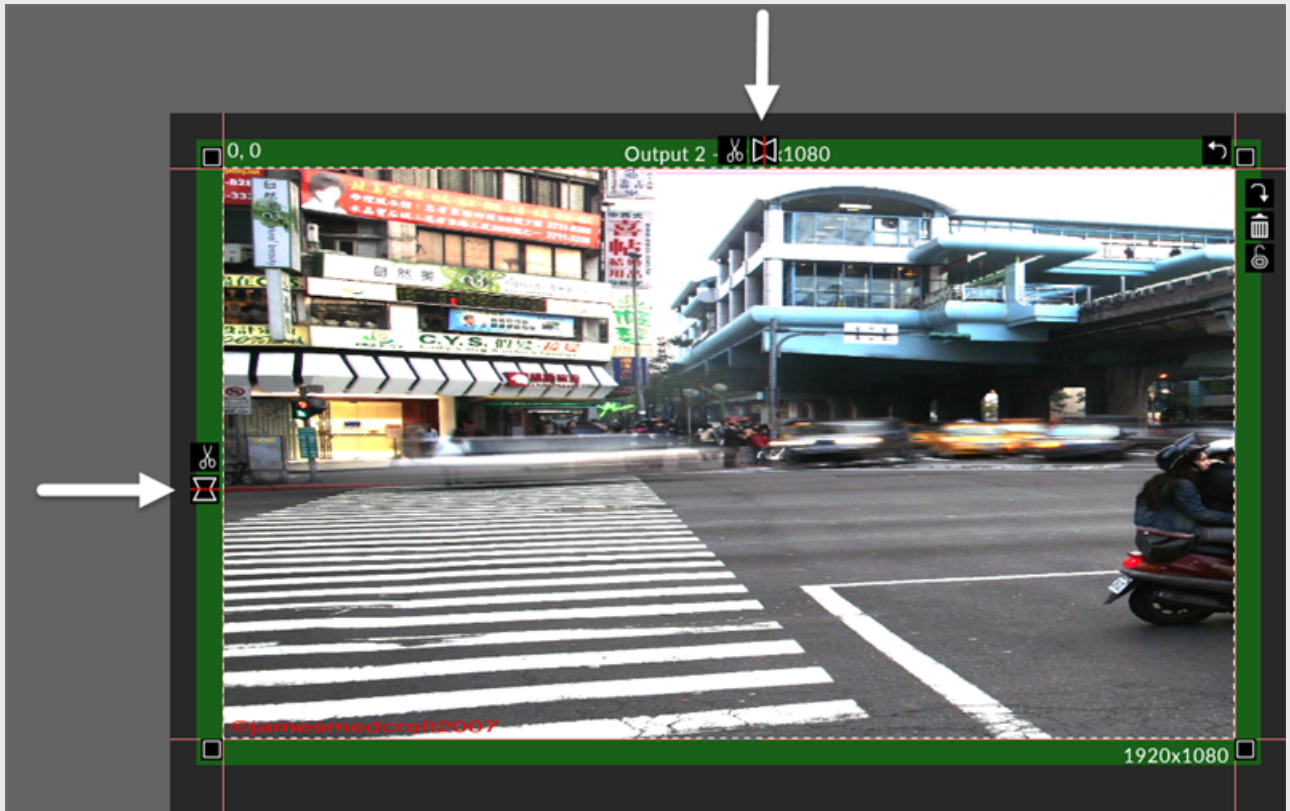

Mirror controls are used to flip a Feed/sample rectangle horizontally or vertically

- Left-click a Mirror control to mirror the Sample rectangle or Feed rectangle. In this example, we have used the top Mirror control to mirror the Feed rectangle horizontally. The left Mirror control will mirror the Sample rectangle or Feed rectangle vertically.

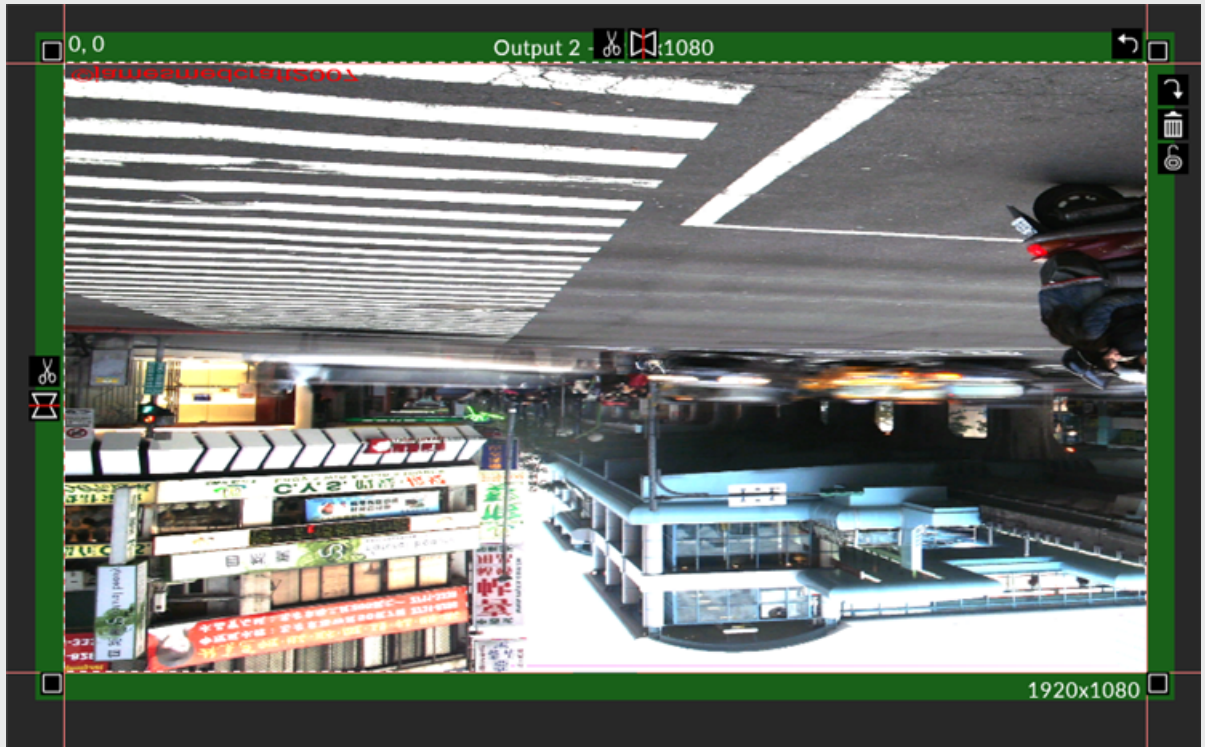

Mirroring a selected Feed rectangle, in this example horizontally, by left-clicking the top Mirror control

## Trash can

The Trash can control allows you to delete Sample rectangles or Feed rectangles.

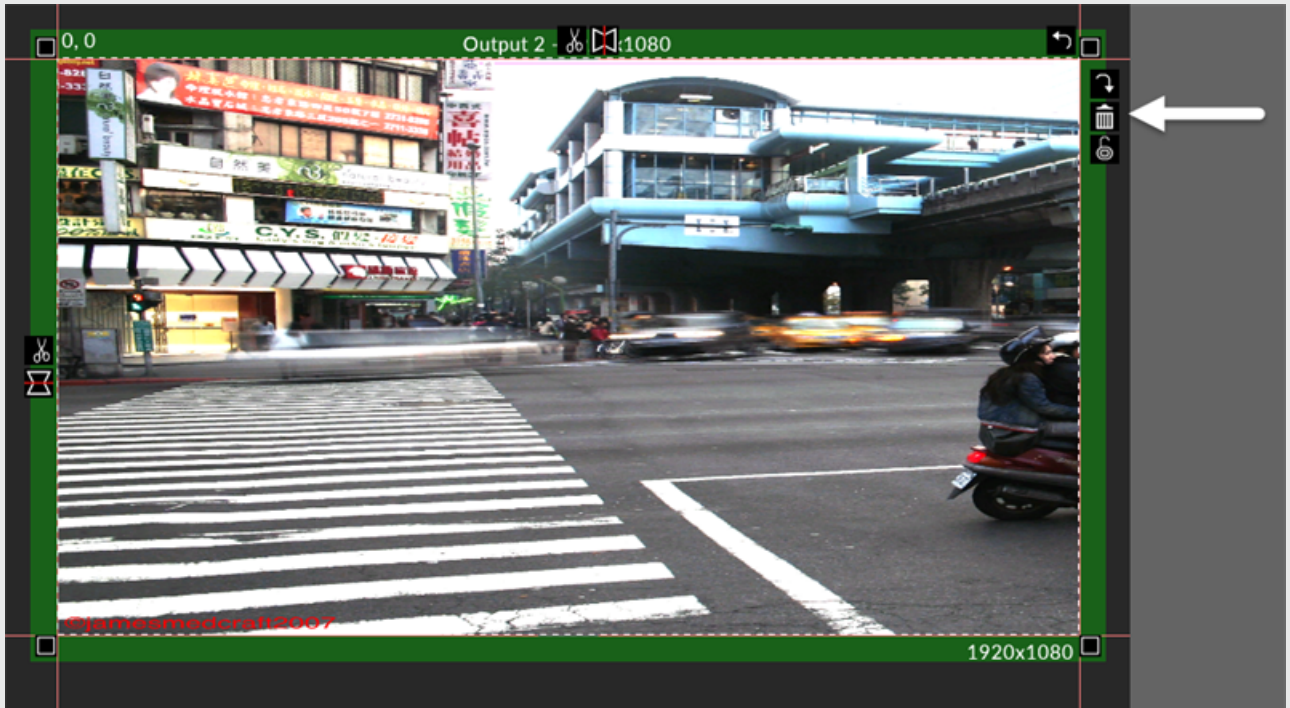

Trash can control is used to delete Feed/sample rectangles

1. Left-click the Feed rectangle or Sample rectangle you want to delete to open the rectangles controls.
2. Left-click the Trash can icon or hit **delete**.

## Rotate

The Rotate controls enable you to rotate the selected Sample or Feed rectangle(s) by 90 degrees clockwise or anti-clockwise.



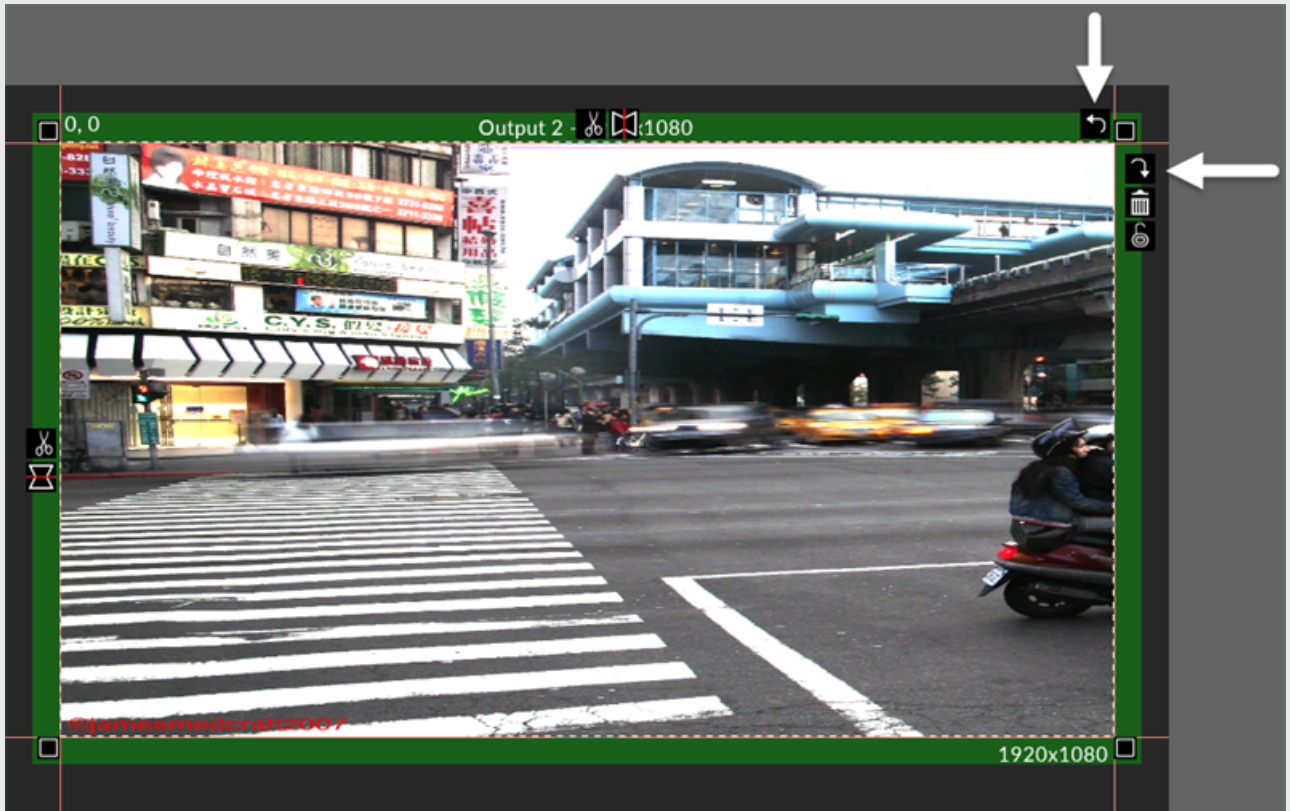

Rotate controls are used to rotate a Feed/sample rectangle 90 degrees clockwise or anti-clockwise

1. Left-click a Rotate control to rotate the Sample rectangle or Feed rectangle.

## Positioning - click and drag

1. Left-click the Feed rectangle to select it.
2. Position your mouse cursor over the middle of the Feed rectangle; arrow heads will appear on the edges of the cross shaped cursor.



3. Left-click and drag the Feed rectangle to the desired position. Note how Disguise displays the distance of the Feed rectangle from the top, left and bottom edges of the Display head in 3 separate boxes. These boxes measure the distance in pixels between the top, left and bottom edges of the Display head and Feed rectangle. The top left of the Display head starts at 0, 0.



**Please note:** zoom in for a finer control over moving the Feed rectangle by clicking and dragging. Alternatively, read the two other options below.

## Positioning - insert coordinates

The top left of the Feed rectangle displays the x and y coordinates of the top left corner of the Feed rectangle. These coordinates are measured in pixels.



Inserting x,y coordinates, measured from the top left of the display head, is another method for repositioning a selected Feed/sample rectangle

**Please note:** you can also edit the resolution of your Feed rectangle, displayed in the bottom right hand corner, in exactly the same way as how you edited the Feed rectangles x and y coordinates.

To insert co-ordinates:



1. Left-click the x and y coordinates to highlight their text fields.
2. Type the new coordinates. The Feed rectangle will now move to the new coordinates specified.

## Positioning - nudge

1. Left-click the Feed rectangle to select it.
2. Use the keyboard arrow keys. Each press of the arrow key will nudge the Feed rectangle by 1 pixel.

## Background colour

1. Right click the head
2. Select a background colour using the colour picker accessed through the **Background Colour** property
3. Feed level options window being used to open the Feed editor, opened by right-clicking the background of the Feed level

This will open the Feed editor. The Feed editor is explained in the sub-chapter [Configuring Feed scenes](#).

# Using duplicate multiple

Using duplicate multiple is an effective way of creating lots of Feed rectangles that follow a pattern.

## Using duplicate multiple

1. Add a Feed rectangle with a size of 256x192 at the position 0,0 on both the source and the output.

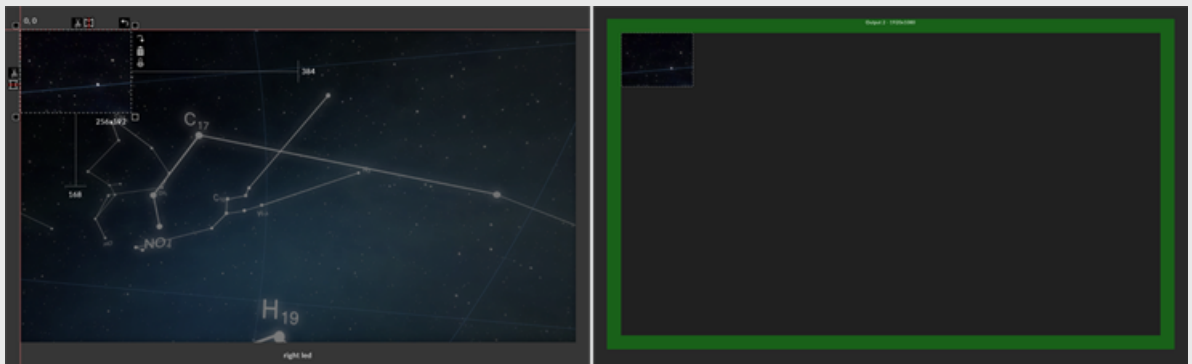

2. Right-click the Feed rectangle. This will open up the [Feed rectangle editor](#) .
3. Left-click **duplicate multiple** in the Feed rectangle editor.

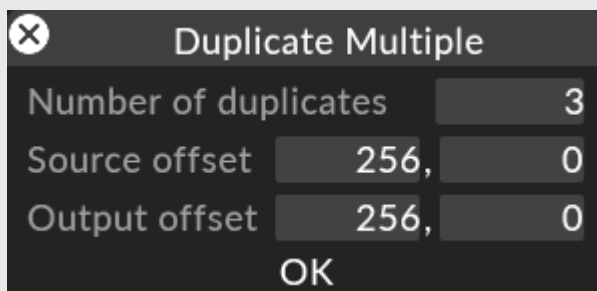
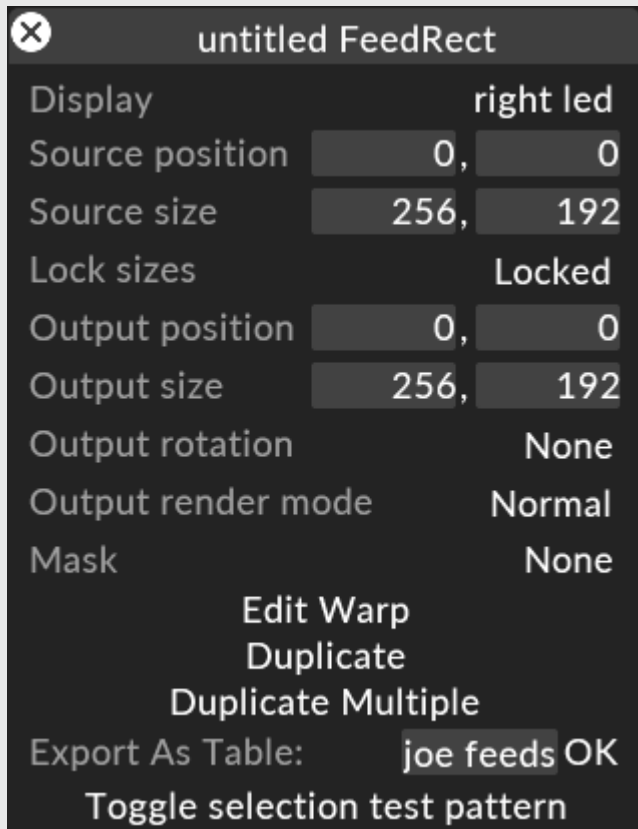

Duplicate Multiple option is used as a quick method of creating lots of Feed rectangles that follow a pattern

This will open up a window with the following options:

# Number of duplicates

This is the number of times you want to duplicate the Feed rectangle.

# Source offset

This is the offset from the original Feed rectangle in the source that you want to increment. The input is x, y.

# Destination offset

This is the offset from the original Feed rectangle in the feed output that you want to increment. The input is x, y.

1. Set the **number of duplicates** to 3 to duplicate it 3 times.
2. Set the x coordinate of the **source offset** and **output offset** to 256 and the y coordinate to 0.
3. Left-click **ok**. This will create 3 Feed rectangles at  $x + 256$  (with x being the x coordinate of the previous Feed rectangle) and at  $y + 0$ , placing them directly next to each other. This will create your first row.

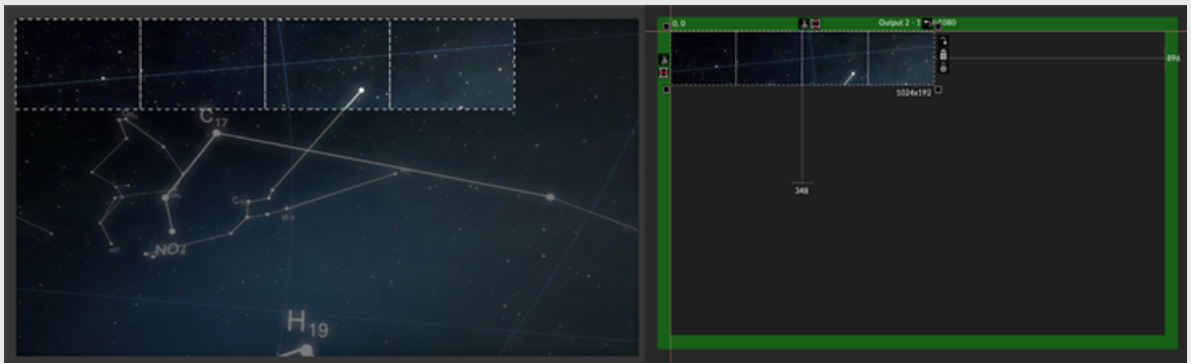

4. Select all the feed rectangles in the first row.
5. Set the **number of duplicates** to 3 to duplicate it 3 times.

6. Set the x coordinate of the **source offset** and **output offset** to 0 and the y coordinate to 192.
7. Left-click **ok** . This will duplicate each row below the previous row, completing the grid of Feed rectangles. As you can see, Disguise software will name the feed rectangles sequentially in the order they are created.

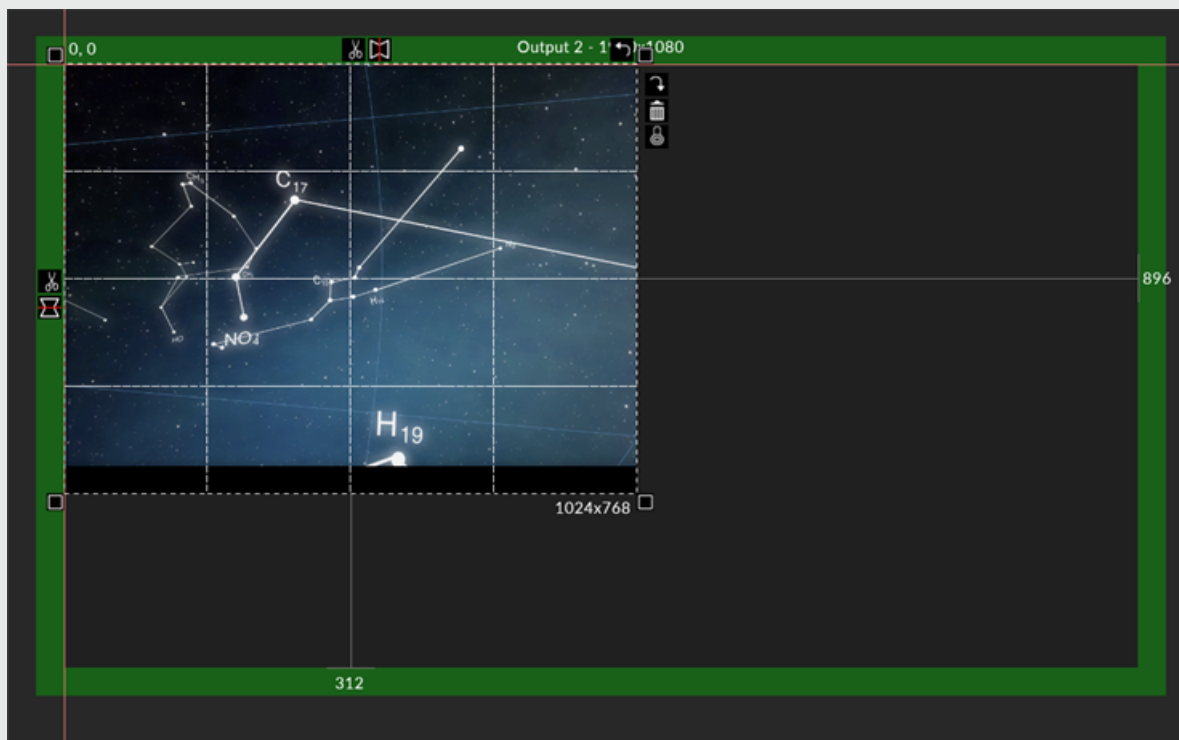

# Configuring d3Net and feed settings

The feed view closely links d3Net settings with the Feed Scene, allowing users to quickly access d3Net settings and assign feeds by simply right-clicking a machine's name.

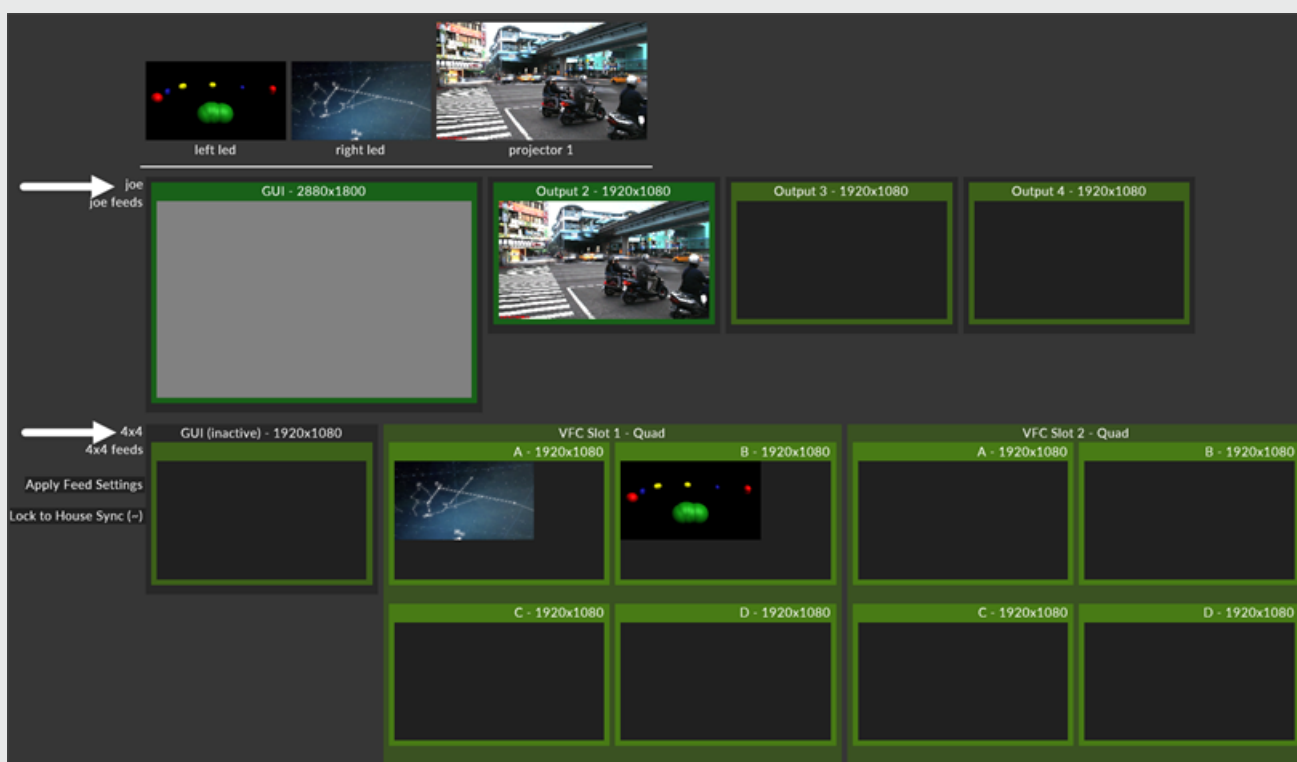

From those settings, you can assign and create new feeds for each machine connected to the network. For more information on how to set up and configure d3Net, please refer to our [d3Net overview](#) section and sub-sections.

# Configuring output settings



**Warning: Applying feed settings will cause the GUI and outputs to refresh several times as the settings, and may take longer than 10 seconds to complete. Please be patient while the process completes!**

## Output head colour

The Feed UI enables users to maintain a visual reference of the status of each head through a simple, colour coded system. This means users are now able to quickly and easily identify which display needs attention, as well as the severity of any issue encountered, simply by looking at the head's colour.

**Green** - Head configured

**Red** - Refresh rate is different

**Orange** - Head settings have changed, hit apply feed settings

**Blue** - Designer machine

**Grey** - output not connected or no machine present

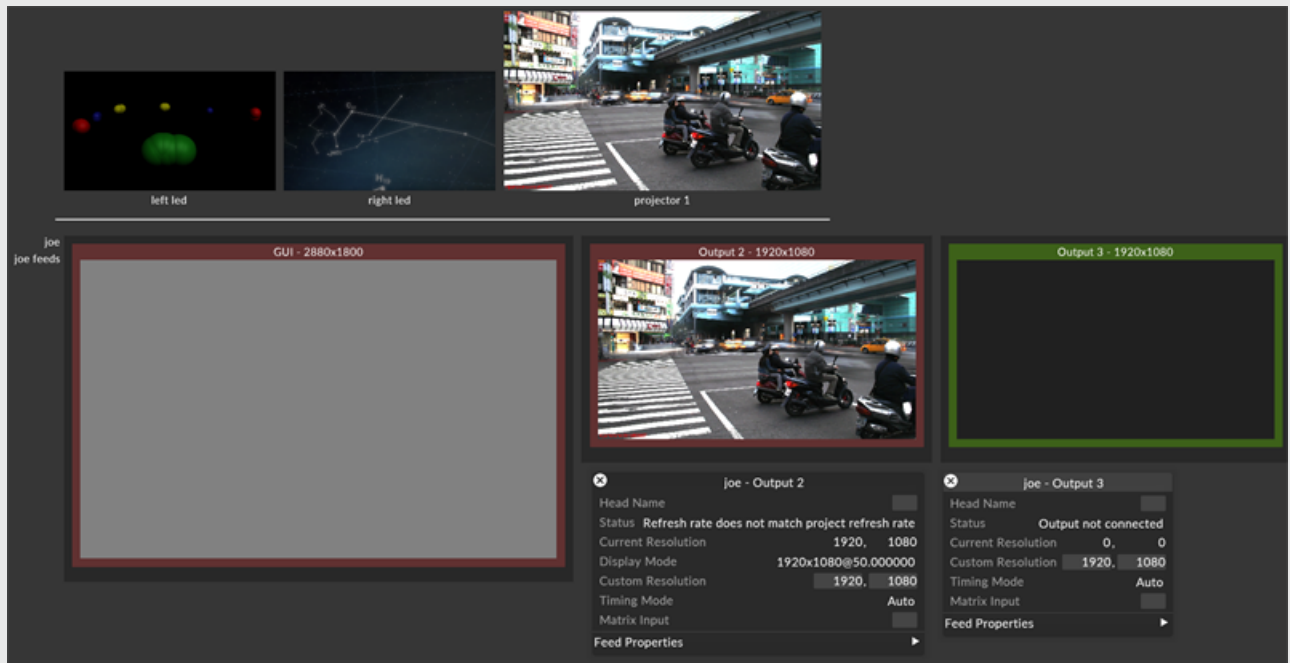

## Applying feed settings

There are specific feed settings related to resolution or timing modes that require users to manually apply the feed settings to the physical outputs. This can be done by simply left-clicking the **Apply Feed Settings** button to the far left-side of each feed.





## Output head settings

Each individual output head can be configured by using its settings menu, which allows users to both monitor and modify the head's settings. To access a head's settings menu, simply right-click the head's name or anywhere within the head's coloured box.

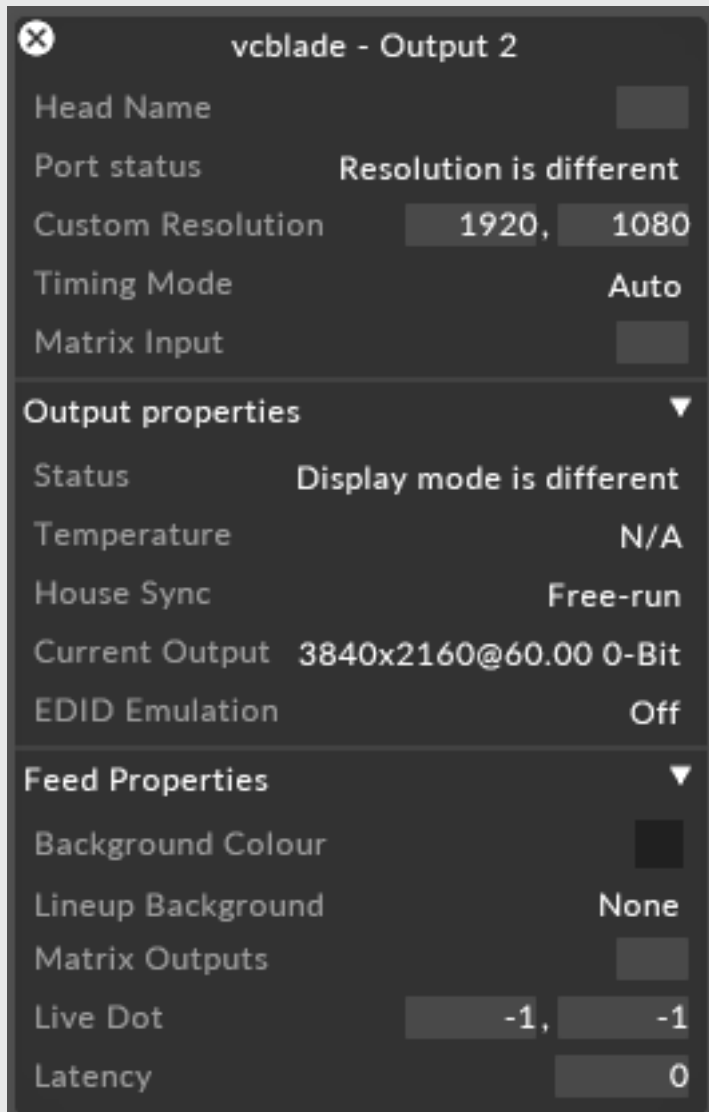

**Please note:** For optimal performance, all outputs should be configured with identical refresh rate and resolution on all output heads with all heads "genlocked" if a sync signal is present, or set to "none/internal " if no sync signal is present.

# Output Head Properties

## Head name

Allows users to type in specific names for each output head. Those names are set as Output 1, 2, etc by default on non-VFC machines, and as A, B, C and D for each individual Quad VFC head.

## Port Status

Allows users to monitor the status of each head. Any problems encountered will be listed here (see above section on Output head colour). If no problems are detected, it will say "Normal" and the head colour will be green.

## Custom Resolution

This field is used to set a custom resolution for ports that support it.

**Please note:** Any resolution changes need to be applied by using the "Apply Feed Settings" button to the left of the feed scene.

## Timing Mode

Allows users to select between Auto and SMPTE timing modes.

## Matrix Inputs

Allows users to directly route inputs when connected to a matrix. For more information, please refer to the [Direct Matrix Routing](#) page.

# Output Properties

The Output Properties drop-down menu contains properties related to the VFC output:

The screenshot shows a configuration window titled "vcblade - Output 2" with a close button (X) in the top-left corner. The window is divided into several sections:

- General Settings:**
  - Head Name: [Greyed out]
  - Port status: Resolution is different
  - Custom Resolution: 1920, 1080
  - Timing Mode: Auto
  - Matrix Input: [Greyed out]
- Output properties** (dropdown menu):
  - Status: Display mode is different
  - Temperature: N/A
  - House Sync: Free-run
  - Current Output: 3840x2160@60.00 0-Bit
  - EDID Emulation: Off
- Feed Properties** (dropdown menu):
  - Background Colour: [Black swatch]
  - Lineup Background: None
  - Matrix Outputs: [Greyed out]
  - Live Dot: -1, -1
  - Latency: 0

## Status

Indicates the status of the output's configuration and reports any issues if detected

## Temperature

Displays the current operating temperature for the output

## House-sync

Indicates whether the output detects Genlock

## Current Output

The current Resolution and Refresh rate for this output.

## EDID Emulation

Disables EDID Emulation functionality for this output.

## Feed Properties

The Feed Properties drop-down menu contains changes that are mostly related to the way a head appears in the feed scene:

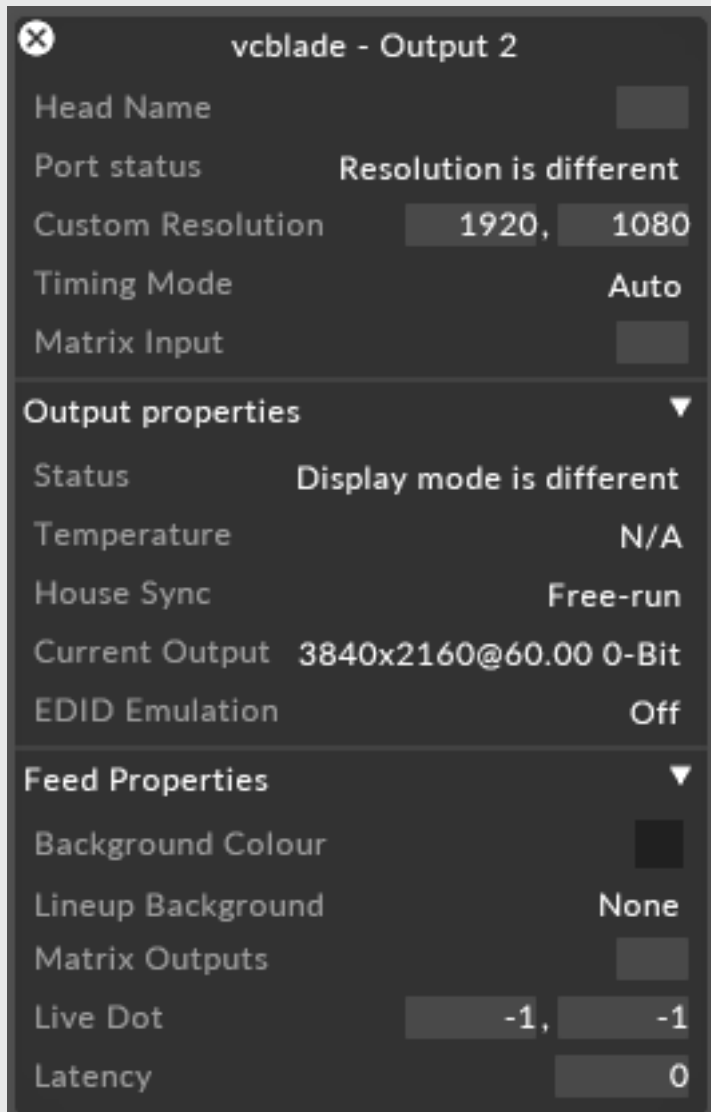

## Background Colour

This option allow users to change the background colour of each head, by using a colour from the colour picker. It is output to the connected display.

## Lineup Background

Allows the user to put a background image on the output to line up feed rectangles to. It is **NOT** output to the connected display.

## Matrix Outputs

Allows users to directly route outputs when connected to a matrix. For more information, please refer to the [Direct Matrix Routing](#) page.

## Live Dot

Allows users to add a single flashing pixel to provide visual reassurance that the output is in working order. Useful when outputting black or still content.

## Latency

Enables the user to add frames of latency for each head. A negative value adds the frame delay to all other heads.

# Configuring VFC card slots

Thanks to the new Feed UI, VFC card users are now able to configure and monitor each individual card slot through the VFC slot configuration menu.

To access this menu for any VFC slot, simply right-click the VFC card's displayed name or the outer box containing the output heads (which represents the VFC slot):

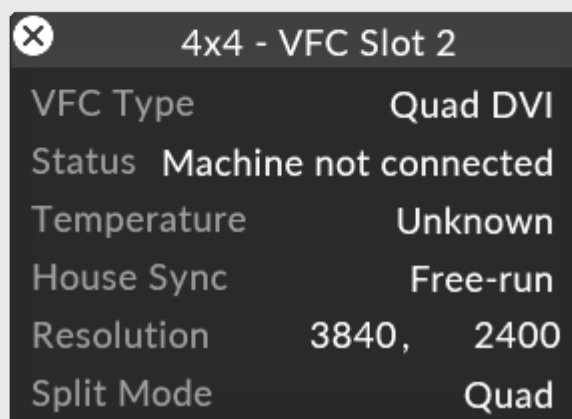
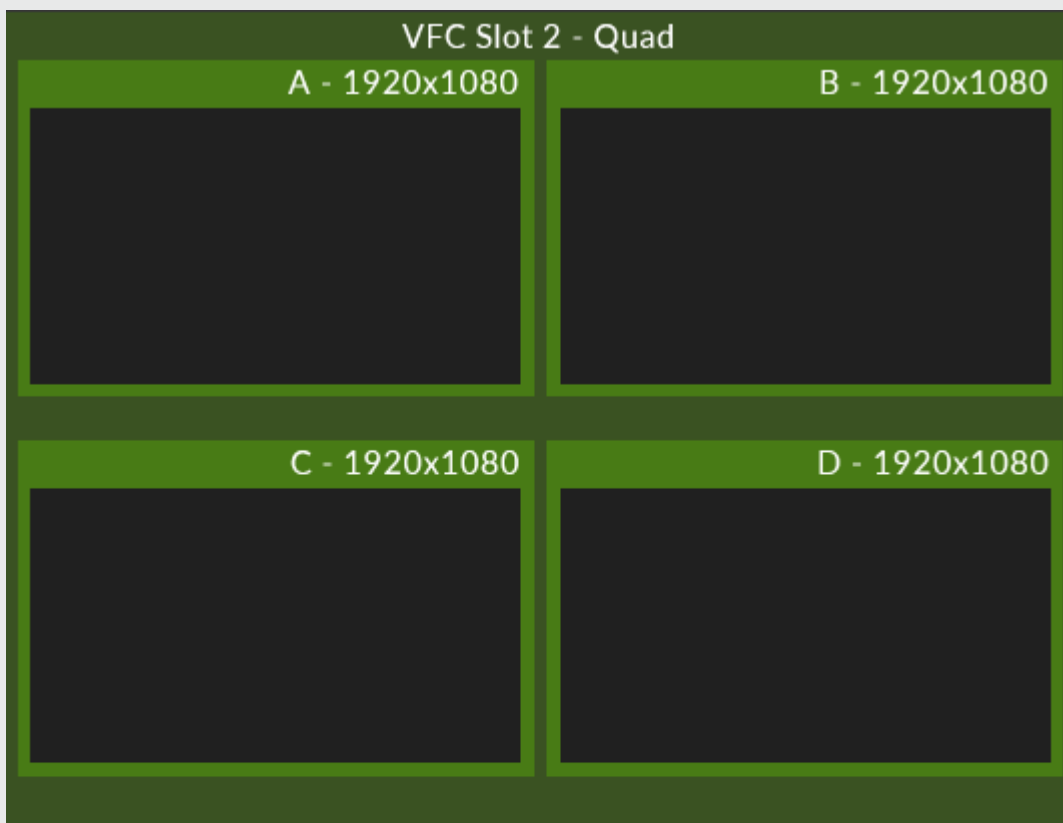



## VFC type:

Allows the user to select which type of VFC card a virtual machine is using prior to the machine being connected. Useful when working on a show off-site from a designer machine. These settings are auto-detected and do not need to be selected while a machine is connected.

## Status:

Allows the user to monitor the current status of the card. Issues such as display mode differences and connection problems are displayed here. If no issues are found, the status will appear as Normal.

## Resolution:

Displays the overall resolution of the VFC slot. This setting can only be changed manually on DP Passthrough cards.

## Split mode:

Enables the user to split the VFC card output in three different ways:

**Mirror:** One identical HD output repeated on all screens connected to the slot. Only one screen is displayed in the feed when in Mirror mode.

**Quad:** Four different HD capable screens, each with their own content

**Quad 4k:** Four HD "panels" arranged into a single 4k output.

**Please note:** The split options are only available with Quad DVI or SDI cards.

# Setting Project Refresh Rate

The refresh rate that a project is set to is inherently important for maintaining optimal d3 performance. The image shows the relationship between project refresh rate, content, timeline and Disguise's frame buffer.

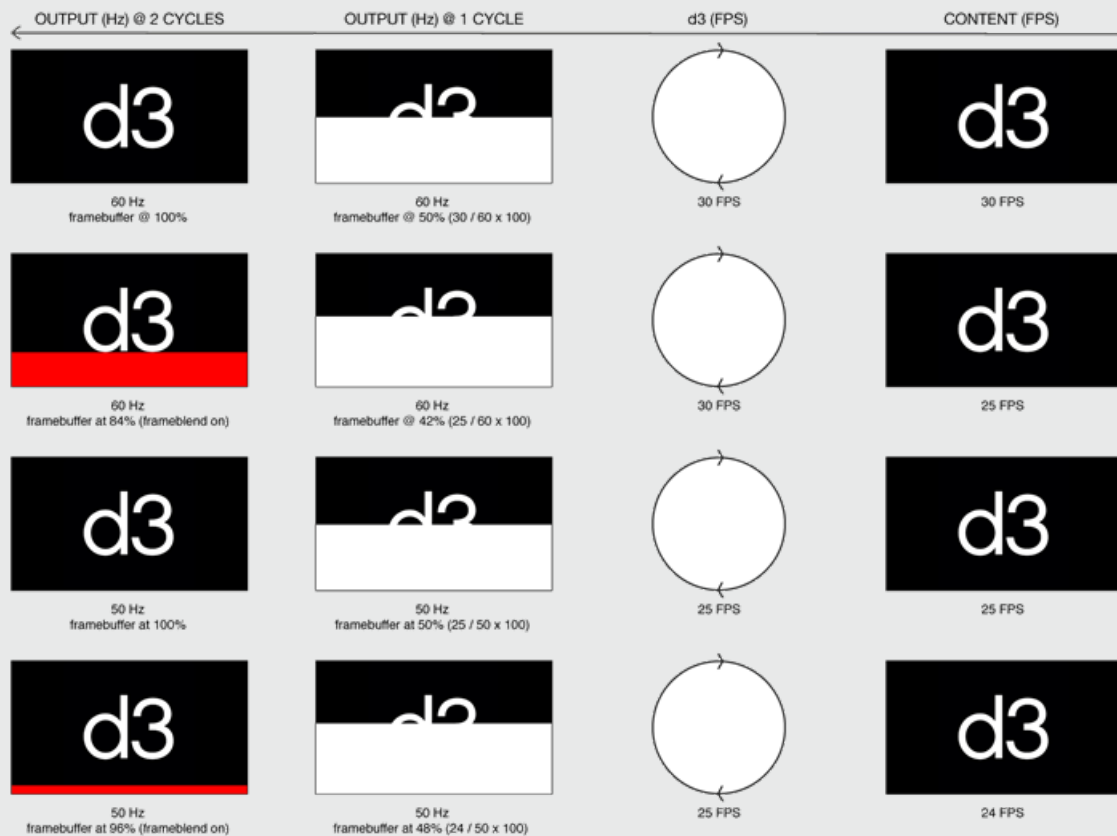

# Setting the project refresh rate

1. Open the state editor by right clicking the d3 icon in the left handside of the dashboard.
2. Open the Project Settings menu by left clicking the option in the state menu.
3. Set the project refresh rate to the desired setting.
4. In the feed view, click apply feed settings to apply the new project refresh rate.

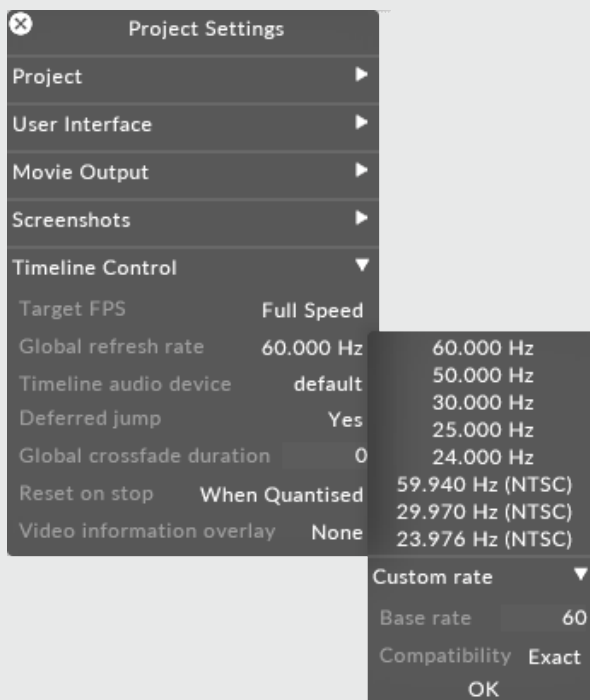

# Setting a custom project refresh rate

1. Open the state menu by right clicking the d3 icon in the left handside of the dashboard.
2. Open the Project Settings menu by left clicking the option in the state menu.
3. Set the custom project refresh rate to the desired setting and click OK.
4. In the feed view, click apply feed settings to apply the new project refresh rate.

# 10bit displays

Disguise software supports the playback of 10bit content on 10bit displays. This topic provides important information on configuring Disguise software for 10bit output.

## Requirements

1. You need to have a display that is capable of outputting 10bit.
2. You need to have the **enable10bitOutput** option switch enabled. See [Advanced Machine Settings](#) for more information.

## Workflow - gx 2c

1. You need to have the **enable10bitOutput** option switch enabled. See [Advanced Machine Settings](#) for more information.
2. In Disguise software, change the bit depth from 8-bit to 10bit in the feed settings. This is a global setting. This setting allows the renderer to work in 10bit. 8-bit displays will work as normal.
3. Quit Disguise software.
4. On a gx 2c, go to Nvidia settings, resolution settings, ensure the appropriate displays are set to 10bit mode in the bit-depth setting. If you're running DP cards, you'll be able to do 10bit RGB 4:4:4.  
  
SDI VFC cards will always down-sample to 4:2:2.

If you are running HDMI cards at 4K, it is recommended to calculate the bandwidth needed using a bandwidth calculator such as this [Video Timings Calculator](#).



## Change Resolution

You can adjust the amount of information appearing on the screen and reduce flickering.

### 1. Select the display you would like to change.



DELL U2414H



Eizo CG319X

### 2. Choose the resolution.

Connector:

 DisplayPort - PC display

Resolution:

PC

- 4096 × 2160 (native)
- 3840 × 2160
- 2560 × 1600
- 2560 × 1440
- 2048 × 1536
- 1920 × 1440
- 1920 × 1200

Refresh rate:

60Hz

Customize...

### 3. Apply the following settings.

Use default color settings

Use NVIDIA color settings

Desktop color depth:

SDR (24-bit color)

Output color depth:

10 bpc

Output color format:

RGB  
RGB  
YCbCr422  
YCbCr444

Output dynamic range:

Limited

5. Start Disguise software and you are now running in 10bit mode.

**Please note:** Do not press "apply feed settings" in the Feed output window within Disguise software as this will break the configuration set in the GPU display settings.

Genlock can be used; for more information on genlock visit [this link](#)

## Workflow - vx range

1. You need to have the **enable10bitOutput** option switch enabled. See [Advanced Machine Settings](#) for more information.
2. In Disguise software, change the bit depth from 8-bit to 10bit in the feed settings. This is a global setting. This setting allows the renderer to work in 10bit. 8-bit displays will work as normal.
3. Quit Disguise software.
4. On vx 4,vx 2, or vx 1 go to AMD Advanced settings, displays, and ensure that the appropriate displays are set to 10bitmode in the bit-depth setting. If you're running DP cards, you'll be able to do 10bit RGB 4:4:4.

SDI VFC cards will always down-sample to 4:2:2.

If you are running HDMI cards at 4K, it is recommended to calculate the bandwidth needed using a bandwidth calculator such as this [Video Timings Calculator](#).

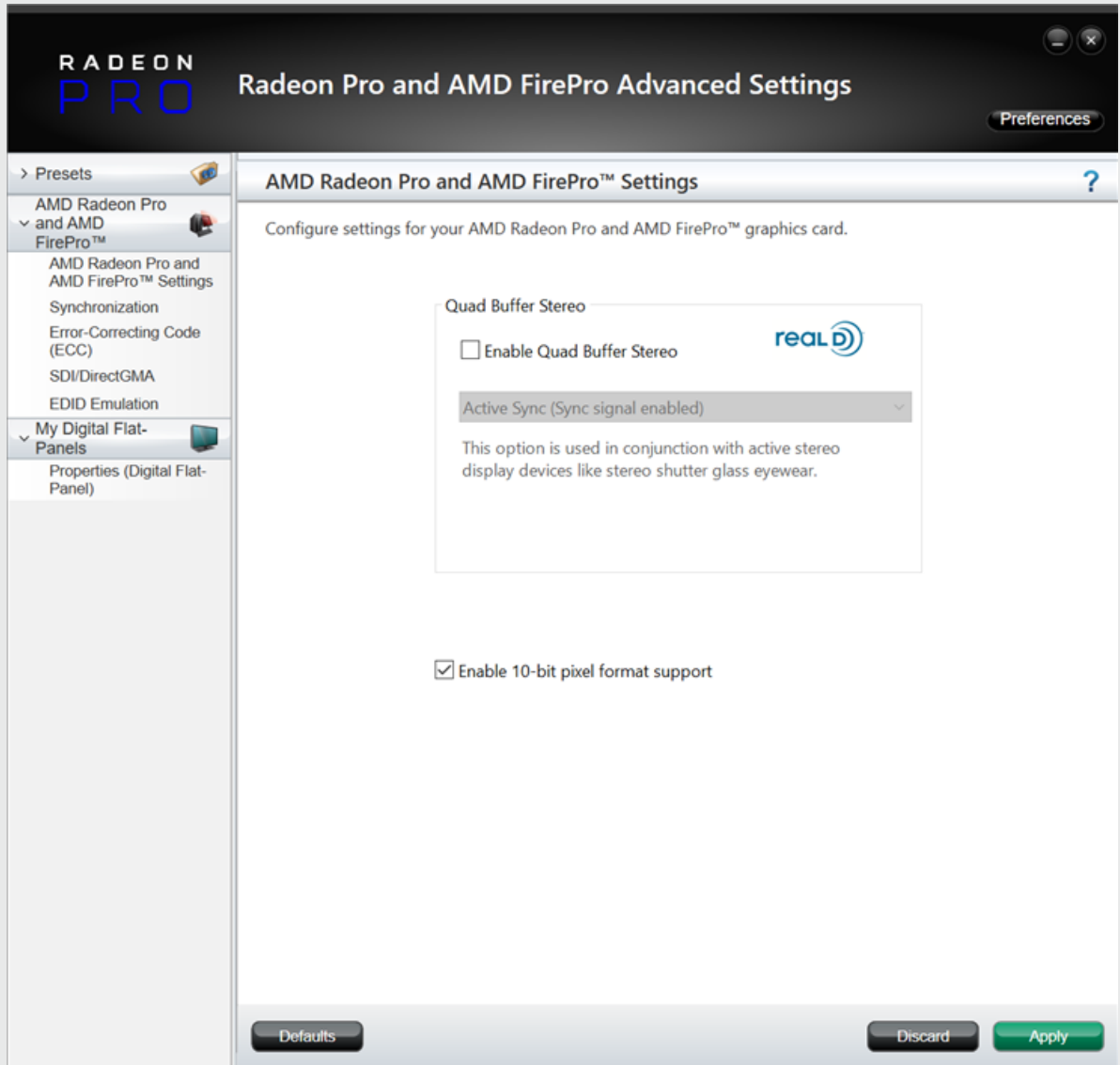

5. Start Disguise software and you are now running in 10bit mode.

**Please note:** Do not press "apply feed settings" in the Feed output window within Disguise software as this will break the configuration set in the GPU display settings.



Genlock can be used; for more information on genlock visit this [link](#)

## HDR

In order to enable HDR within disguise, follow these steps:

- 10bit in Windows - do NOT set HDR in Windows or for graphics card; this is not necessary
- Set **enable 10BitOutput** in Advanced Machine Settings
- Apply 10bit feed settings in Disguise software
- Restart
- Apply the output transform (ACES colour management) or colour profile (gamma colour management)

**Please note:** disguise does not send metadata - ensure the output device is set to match the HDR profile.

HDR displays must be set to force their HDR profile due to the InfoFrame not being set by Disguise software and therefore is not able to be detected by the screen.

## Known issues

- 10bit output is currently globally on or off, it is not possible to run a mix of 8bit and 10bit machines in a single session.
- DVI VFC cards cannot run 10bit content or input and so will not function when 10bit mode is enabled.
- When using 4K 50hz/60hz with HDMI 2.0, the HDMI available bandwidth means you need to make use of 4:2:2 chroma subsampling. Currently Disguise software only creates 4:4:4 EDIDs when applying feed settings, so this setting will need to be set in the GPU control panel.

- Depending on what the display device is, it may need to be in a specific mode to enable 10bit. This could be known as high performance, high colour mode or true colour mode. Refer to the manufacturer specifications on how to enable the 10bitmode for your display of choice.

For more information on 10bit workflows, please contact [support](#).

# Genlock

Locking to house sync can be applied through the BNC Genlock connector above the GUI port on the rear of all pro and gx range Machines.



**Warning:** Disguise software does not support Genlocking when VFC slot resolutions are different. All VFC slots must be the same resolution to be able to Genlock.

Disguise software supports both BlackBurst and Tri-Level Genlock signals.

There are two ways to apply Genlock: one within the Software, and the other through the Graphics Card Driver itself.

**Please note:** VFC cards typically add some lines of latency to output, this should be considered when configuring Genlock. This is typically around 4-8 lines, but may be up to 50 for SDI signals. Genlock is performed at the GPU level, so the outputs may be slightly out of Genlock and you may need to use an external re-synchroniser to get it back into Genlock.

**Please note:** We cannot determine the interlaced field from the Genlock signal, so interlaced outputs may be a full field out of sync.



**Warning:** When using the SDI VFC cards with an interlaced video signal there is a chance that the output signal from the VFC card will not match the field of the incoming genlock signal. To correct this state it is necessary to repeat the Apply Feed Settings process, this will re-sync the VFC card and reset which field is being output. Due to GPU genlock limitations this process may need to be repeated until the VFC card field sync matches that of the incoming genlock signal. In a multi-machine sessions this should be repeated across all machines at the same time to ensure they are locked to the same field together.

# Locking to House Sync within Disguise

- Left click on **Feed** in the dashboard to access the Feed View.
- You will notice that under **Apply Feed Settings** there is also **Lock to House Sync**.
- When pressed the machine will perform the process to then Lock to House Sync.

When locked you will see a coloured icon within each VFC card header, indicating whether that VFC card is Genlocked. If the indicator is green, this means that the machine has locked successfully.

**Please note:** The indicator will be blue under internal lock.

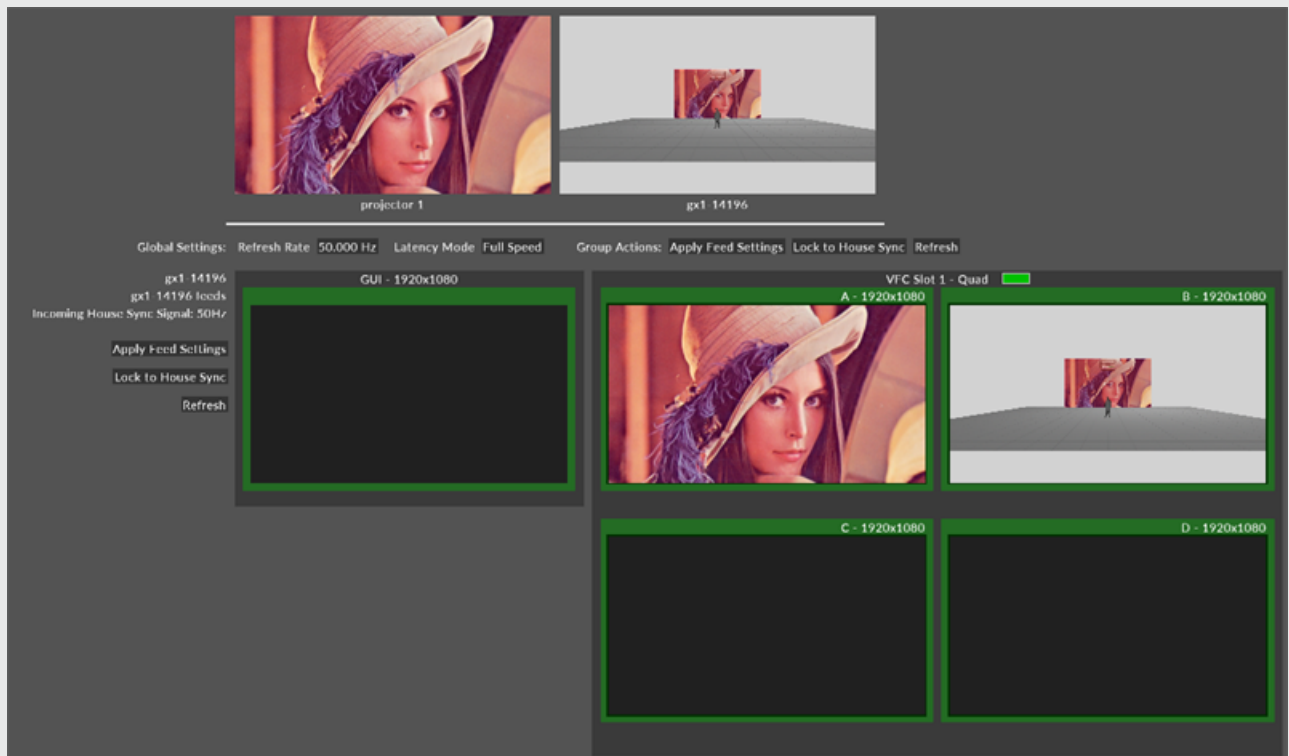

On multi-server set ups, you can apply Lock to House sync from the Director through to all of the other machines.

## Configuring Genlock externally to the software (vx 4)

Genlock configuration is completed via the [AMD Software: Pro Edition Control panel](#). For assistance with configuring Genlock, please contact [disguise support](#).

## Configuring Genlock externally to the software (4x4, 4x2)

For detailed help on the Genlock card, please see the in-built help center in the Catalyst Control Center.

To access the Catalyst Control Center to start synchronizing from an external house source please follow these steps:

1. Right click on the desktop and select **AMD Fire Pro Control Center**
2. Open the AMD Fire Pro Tab and click on Synchronization
3. Click **refresh** under House Sync
4. Once the House Sync indicator goes Green and displays the correct Genlock signal that you are using, click on the displays (under timing clients) that you wish to lock to the Genlock source and hit apply

Your selected displays are now genlocked

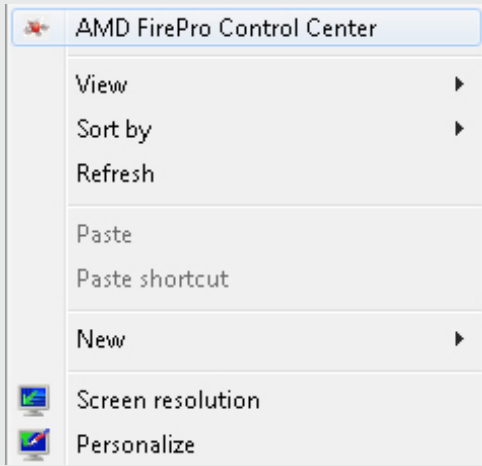

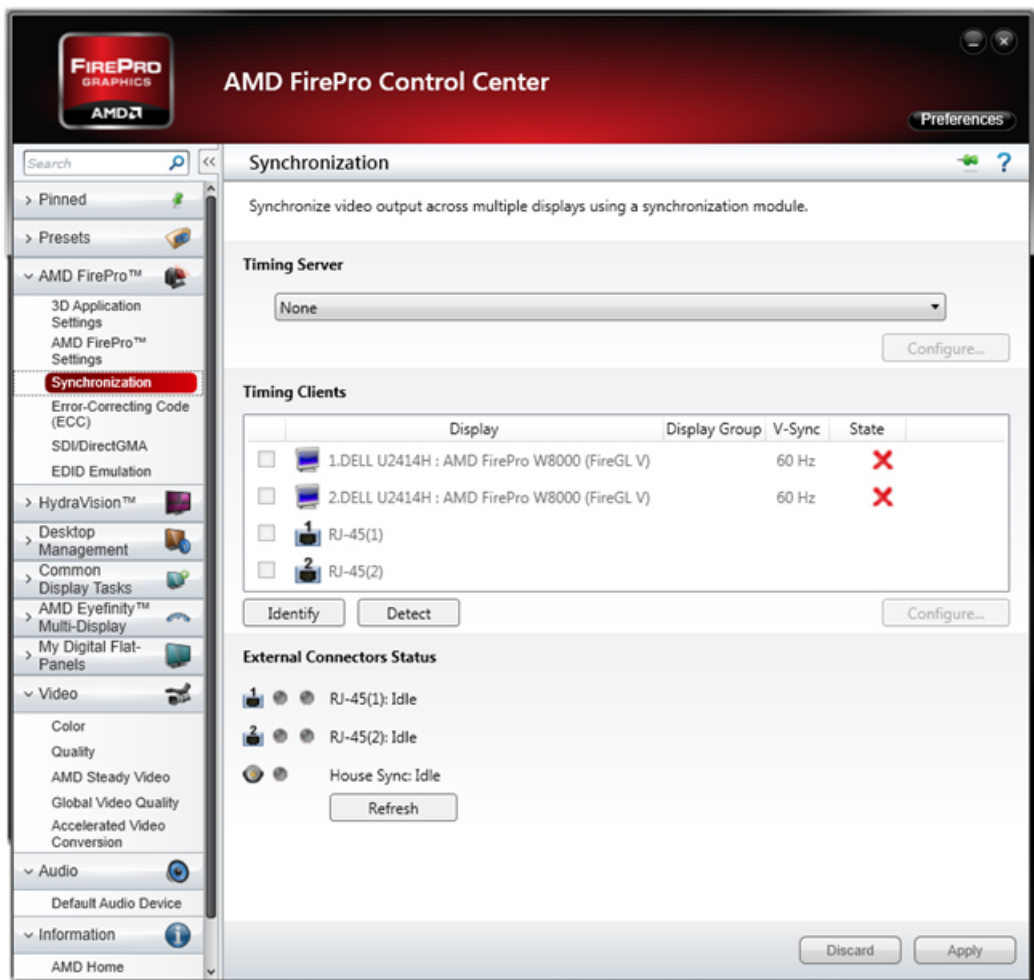

5. Right click selection (top) and AMD FirePro Control Center interface (bottom)

# Configuring Genlock externally (2x4pro, gx machines)

Follow the guide below with allocated images to complete Genlock with NVIDIA.

1. Right click on the desktop and select the NVIDIA Control Panel.

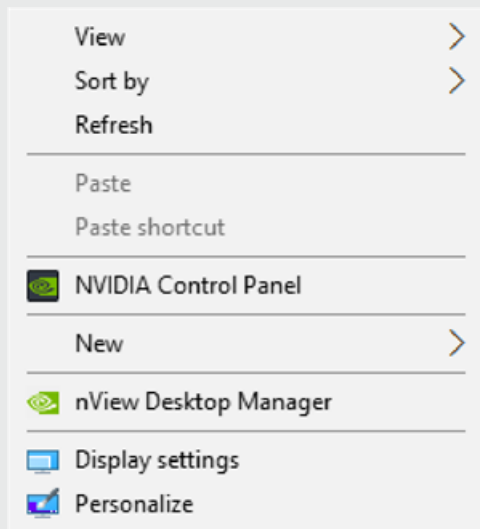

2. The **Synchronize displays** tab should automatically open. Once on this window click on all displays that you wish to be Genlocked and ensure that the boxes are ticked below. After all displays are selected go back to highlighting your main display and select the **Server Settings** button.



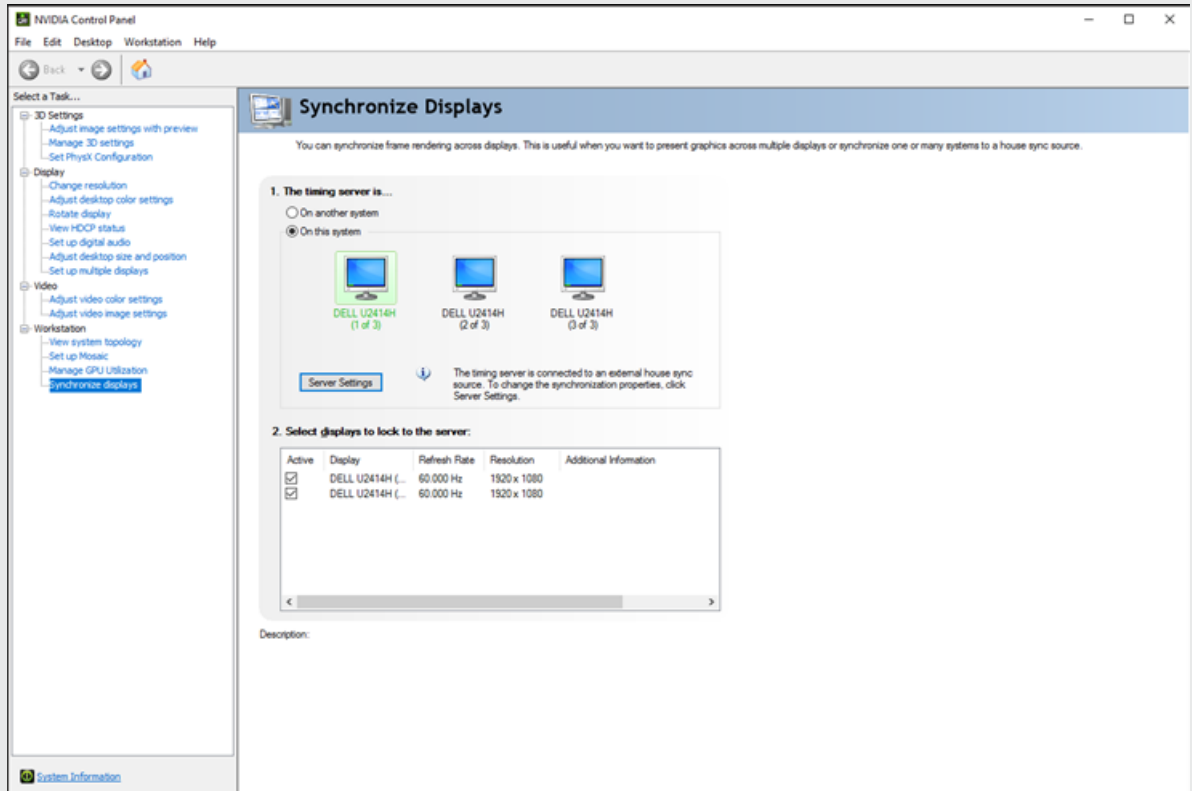

3. The Server Settings popup will show what the current Synchronization is. Change the selection from **Internal timing** to **external house sync** and apply the changes before pressing **Ok**.

## Synchronize Displays

You can synchronize frame rendering across displays. This is useful when you want to present graphics across multiple displays or synchronize one or many systems to a house sync source.

### 1. The timing server is...

On another system  
 On this system

  
DELL U2414H  
(1 of 3)

Server Settings

### 2. Select displays to lock to

Active	Display
<input checked="" type="checkbox"/>	DELL U2414H (...)
<input checked="" type="checkbox"/>	DELL U2414H (...)

### Server Settings

Edit the properties of the frame synchronization pulses generated by the timing server.

Server refresh rate: **60.00 Hz**

The synchronization pulses are based on:

The server refresh rate (Internal timing)  
 An external house sync signal

Sync frequency: **60.00 Hz**

Sync signal detection: **Composite**

The signal is interlaced

Trigger sync pulses from the frame start signal using:

Leading edges  
 Falling edges  
 Both edges (applies to TTL signals only)

Outgoing sync interval:  Sync delay:   $\mu$ s

OK Cancel Apply

Description:  
Click this button to edit the timing server settings.

Apply Cancel

**Server Settings** [X]

Edit the properties of the frame synchronization pulses generated by the timing server.

Server refresh rate: **60.00 Hz**

The synchronization pulses are based on:

The server refresh rate (Internal timing)

An external house sync signal

Sync frequency: **60.00 Hz**

Sync signal detection: Composite

The signal is interlaced

Trigger sync pulses from the frame start signal using:

Leading edges

Falling edges

Both edges (applies to TTL signals only)

Outgoing sync interval:  Sync delay:   $\mu\text{s}$

 Some settings have been automatically updated to match the incoming house sync signal.

**Please note:** Nvidia machines need to use the "Refresh" button to see the correct state.

4. When back out of **Server Settings** click on the **View System Topology** tab. Select **Yes** on the popup to apply the changes previously made. Once on the **View System Topology** window you will now see if Genlock has been completed if **External Sync Signal** has a green tick next to it and stating **Present (In use)**.

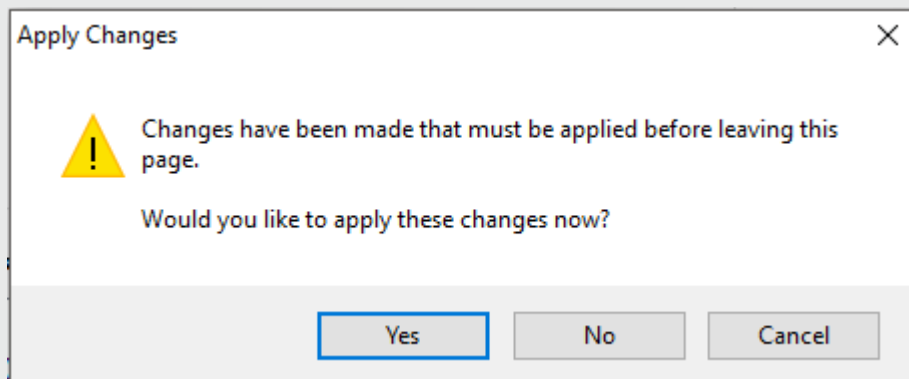

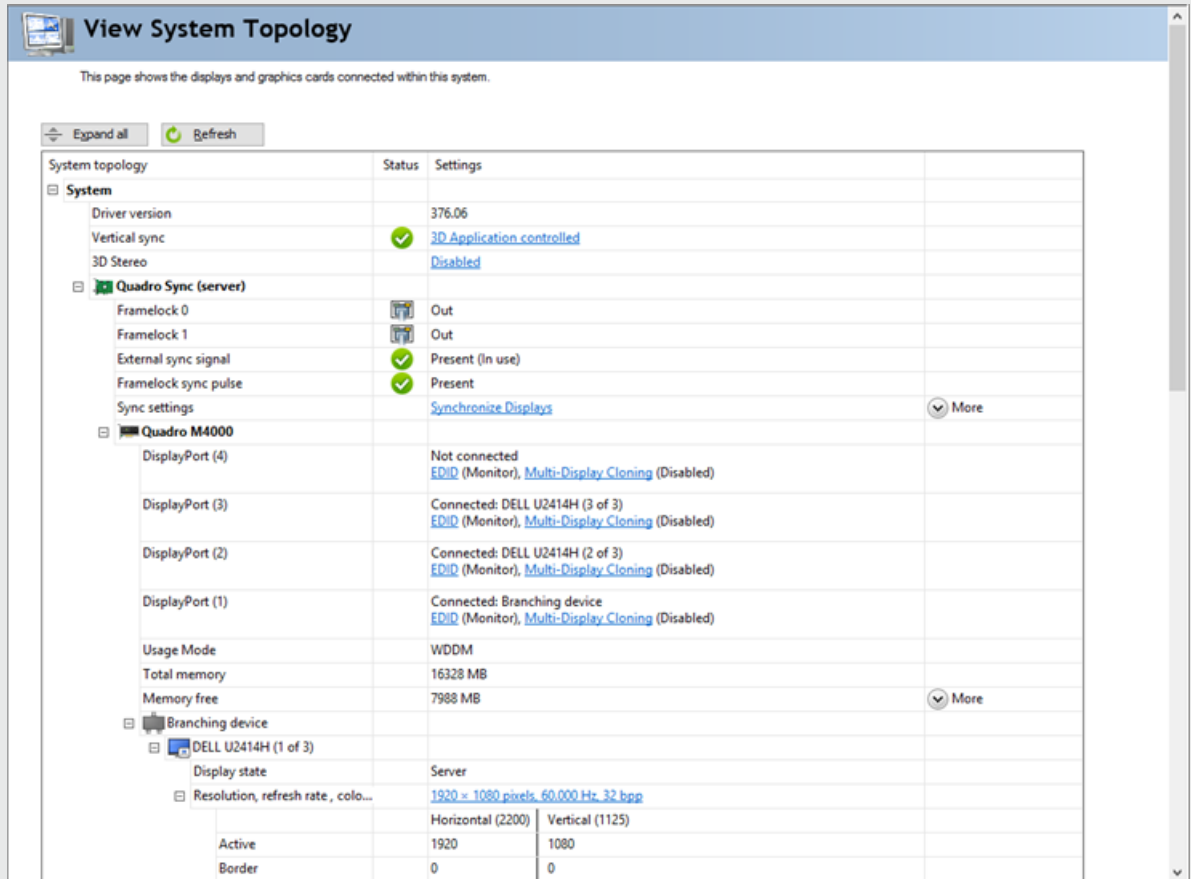

## Internal Timing Sync

To access the Catalyst Control Center to start synchronizing Internal Timing:

1. Right click on the desktop and select AMD Fire Pro Control Center.
2. Open the AMD Fire Pro Tab and click on Synchronization.
3. Under the Timing Server tab, select the last listed display. (For example in the image shown it was number 5)

4. Tick all screens that you wish to sync in the list below.
5. Your selected displays are now Internally genlocked.

Use the image below for reference of how the correct setup will look.

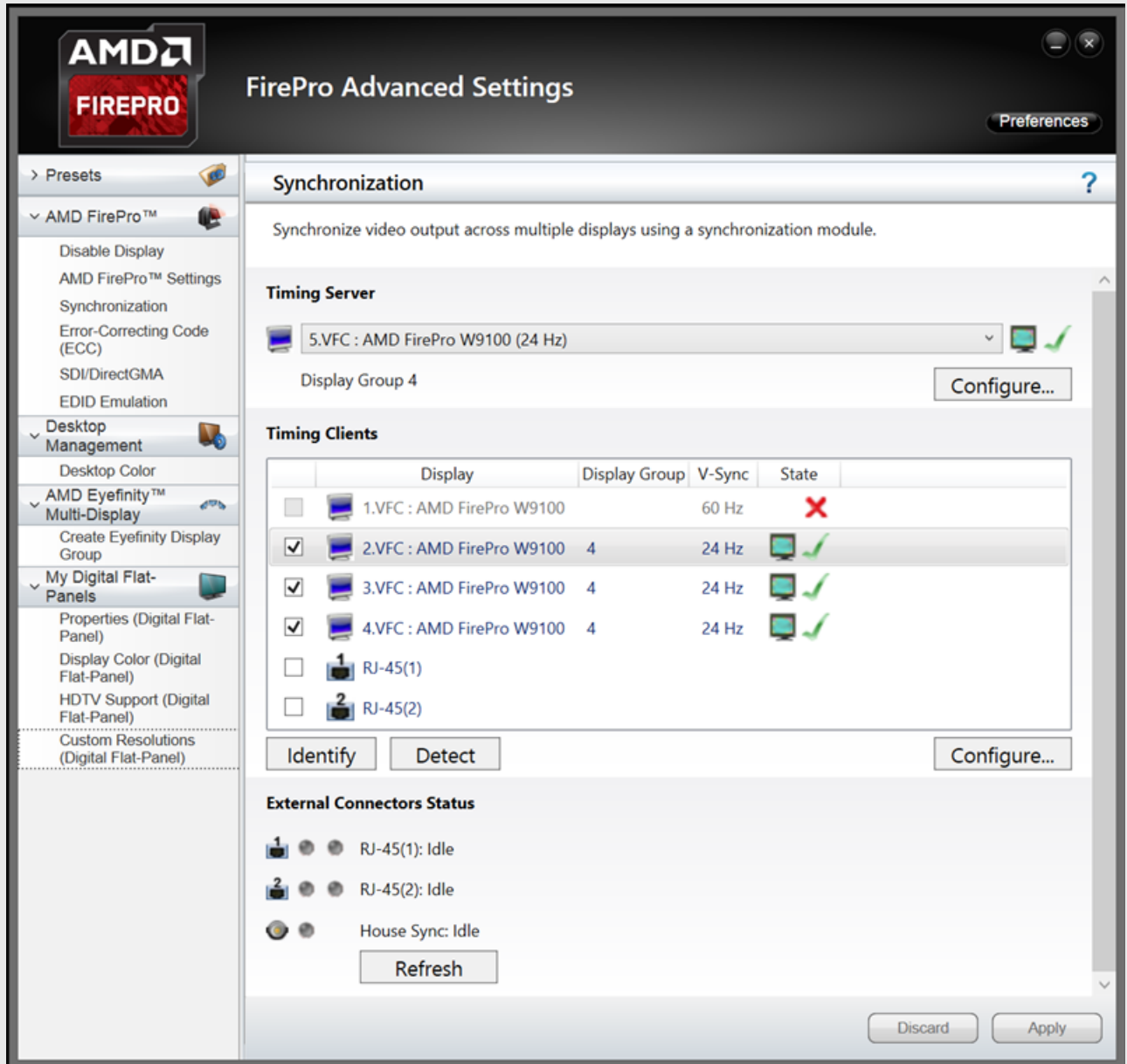

# Genlock

Locking to house sync can be applied through the BNC Genlock connector above the GUI port on the rear of all pro and gx range Machines.



**Warning:** Disguise software does not support Genlocking when VFC slot resolutions are different. All VFC slots must be the same resolution to be able to Genlock.

Disguise software supports both BlackBurst and Tri-Level Genlock signals.

There are two ways to apply Genlock: one within the Software, and the other through the Graphics Card Driver itself.

**Please note:** VFC cards typically add some lines of latency to output, this should be considered when configuring Genlock. This is typically around 4-8 lines, but may be up to 50 for SDI signals. Genlock is performed at the GPU level, so the outputs may be slightly out of Genlock and you may need to use an external re-synchroniser to get it back into Genlock.

**Please note:** We cannot determine the interlaced field from the Genlock signal, so interlaced outputs may be a full field out of sync.



**Warning:** When using the SDI VFC cards with an interlaced video signal there is a chance that the output signal from the VFC card will not match the field of the incoming genlock signal. To correct this state it is necessary to repeat the Apply Feed Settings process, this will re-sync the VFC card and reset which field is being output. Due to GPU genlock limitations this process may need to be repeated until the VFC card field sync matches that of the incoming genlock signal. In a multi-machine sessions this should be repeated across all machines at the same time to ensure they are locked to the same field together.

# Locking to House Sync within Disguise

- Left click on **Feed** in the dashboard to access the Feed View.
- You will notice that under **Apply Feed Settings** there is also **Lock to House Sync**.
- When pressed the machine will perform the process to then Lock to House Sync.

When locked you will see a coloured icon within each VFC card header, indicating whether that VFC card is Genlocked. If the indicator is green, this means that the machine has locked successfully.

**Please note:** The indicator will be blue under internal lock.

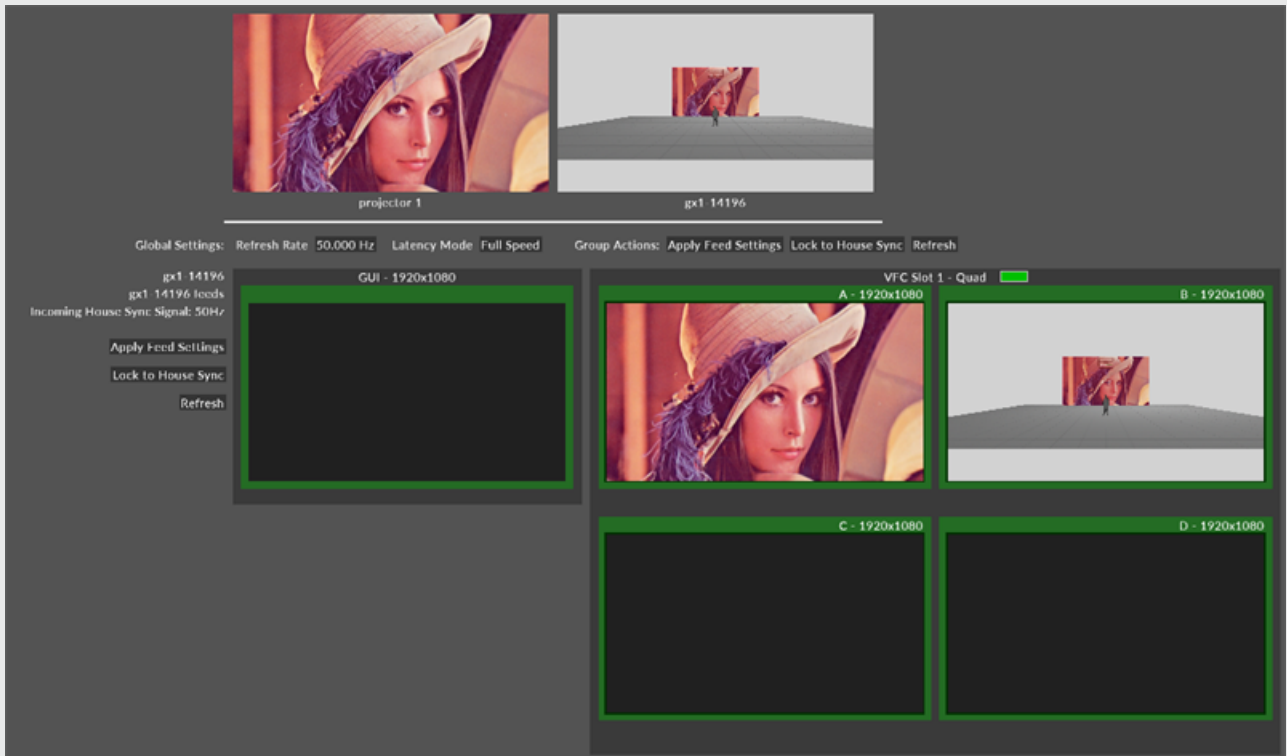



On multi-server set ups, you can apply Lock to House sync from the Director through to all of the other machines.

## Configuring Genlock externally to the software (vx 4)

Genlock configuration is completed via the [AMD Software: Pro Edition Control panel](#). For assistance with configuring Genlock, please contact [disguise support](#).

## Configuring Genlock externally to the software (4x4, 4x2)

For detailed help on the Genlock card, please see the in-built help center in the Catalyst Control Center.

To access the Catalyst Control Center to start synchronizing from an external house source please follow these steps:

1. Right click on the desktop and select **AMD Fire Pro Control Center**
2. Open the AMD Fire Pro Tab and click on Synchronization
3. Click **refresh** under House Sync
4. Once the House Sync indicator goes Green and displays the correct Genlock signal that you are using, click on the displays (under timing clients) that you wish to lock to the Genlock source and hit apply

Your selected displays are now genlocked

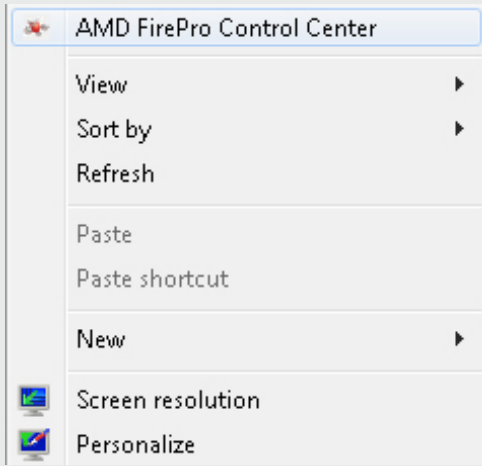

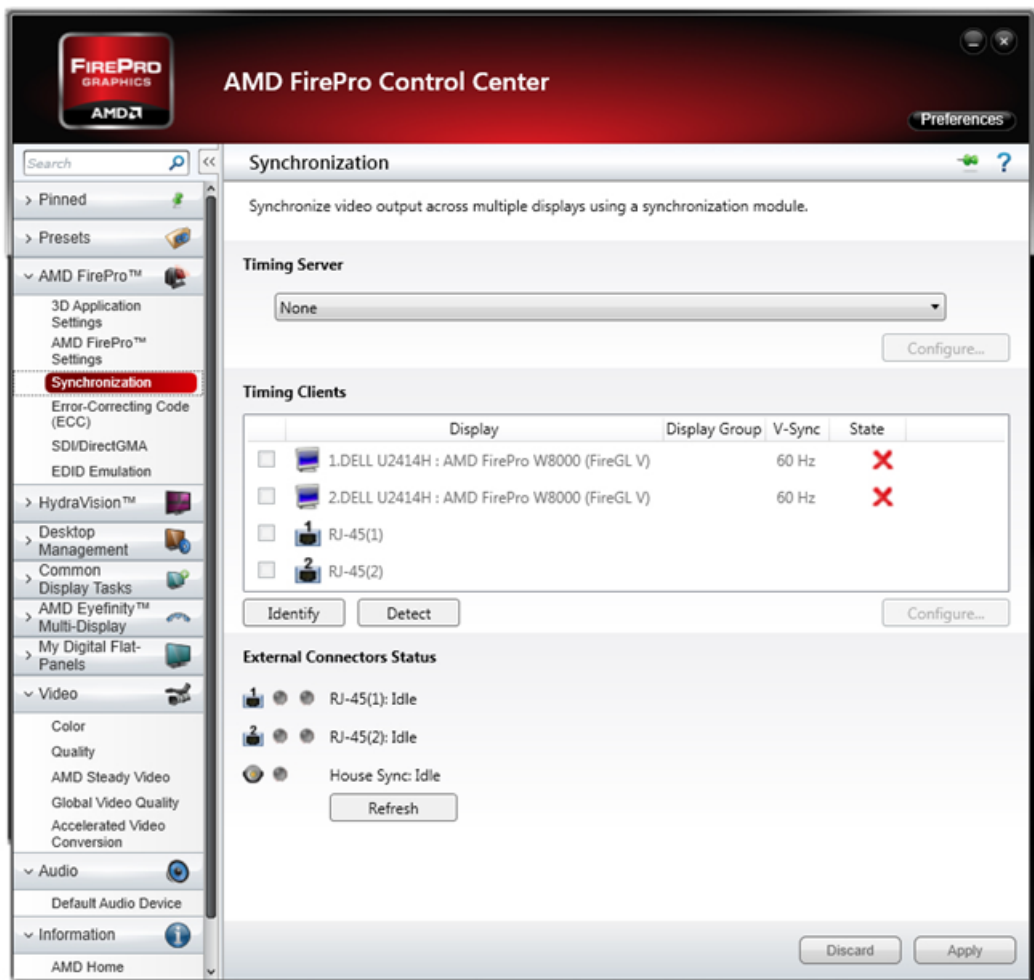

5. Right click selection (top) and AMD FirePro Control Center interface (bottom)

# Configuring Genlock externally (2x4pro, gx machines)

Follow the guide below with allocated images to complete Genlock with NVIDIA.

1. Right click on the desktop and select the NVIDIA Control Panel.

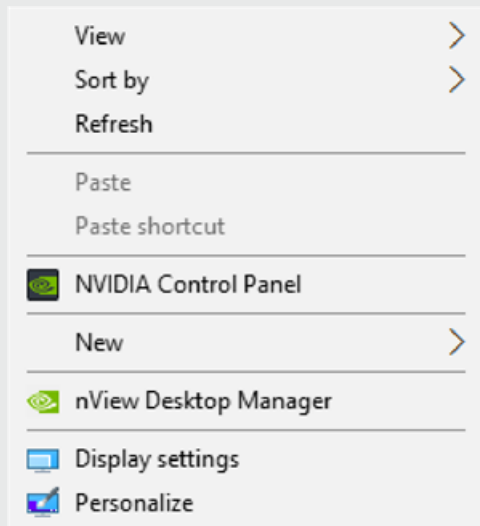

2. The **Synchronize displays** tab should automatically open. Once on this window click on all displays that you wish to be Genlocked and ensure that the boxes are ticked below. After all displays are selected go back to highlighting your main display and select the **Server Settings** button.

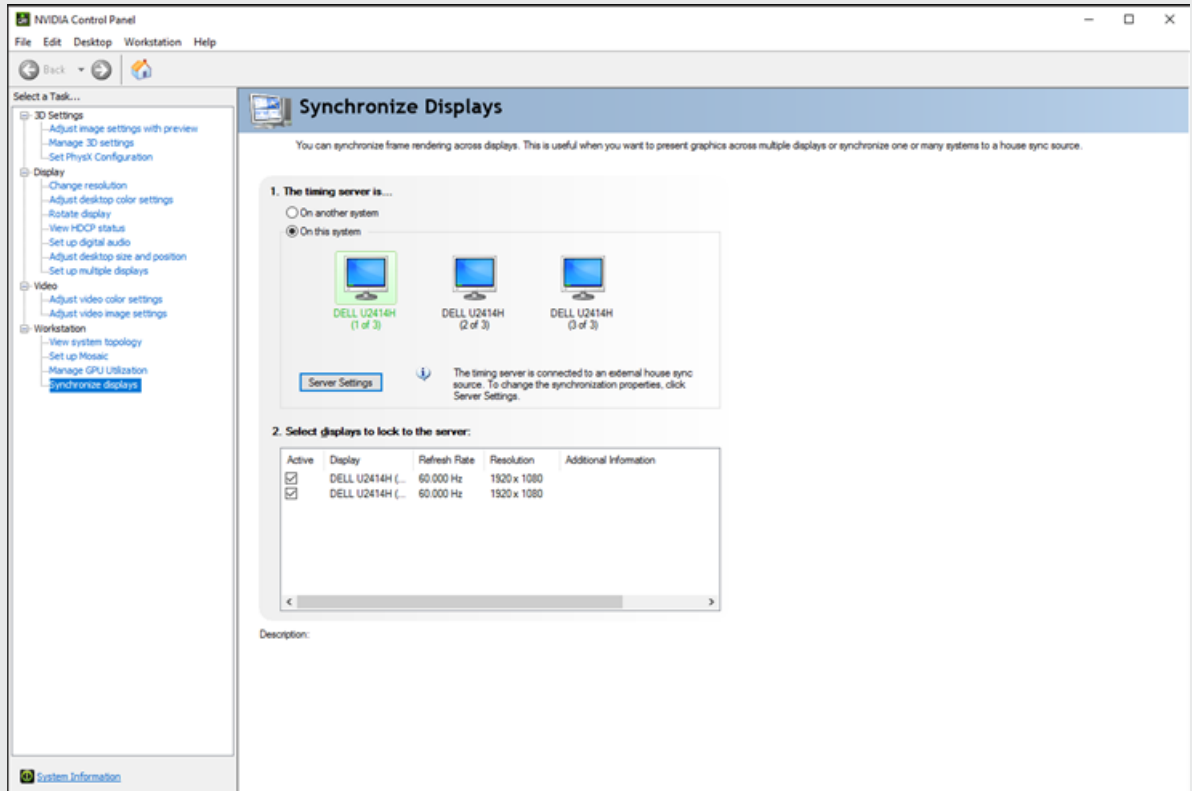

3. The Server Settings popup will show what the current Synchronization is. Change the selection from **Internal timing** to **external house sync** and apply the changes before pressing **Ok**.

## Synchronize Displays

You can synchronize frame rendering across displays. This is useful when you want to present graphics across multiple displays or synchronize one or many systems to a house sync source.

### 1. The timing server is...

On another system  
 On this system

  
DELL U2414H  
(1 of 3)

Server Settings

### 2. Select displays to lock to

Active	Display
<input checked="" type="checkbox"/>	DELL U2414H (...)
<input checked="" type="checkbox"/>	DELL U2414H (...)

### Server Settings

Edit the properties of the frame synchronization pulses generated by the timing server.

Server refresh rate: **60.00 Hz**

The synchronization pulses are based on:

The server refresh rate (Internal timing)  
 An external house sync signal

Sync frequency: **60.00 Hz**

Sync signal detection: **Composite**

The signal is interlaced

Trigger sync pulses from the frame start signal using:

Leading edges  
 Falling edges  
 Both edges (applies to TTL signals only)

Outgoing sync interval:  Sync delay:   $\mu$ s

OK Cancel Apply

Description:  
Click this button to edit the timing server settings.

Apply Cancel

**Server Settings** [X]

Edit the properties of the frame synchronization pulses generated by the timing server.

Server refresh rate: **60.00 Hz**

The synchronization pulses are based on:

The server refresh rate (Internal timing)

An external house sync signal

Sync frequency: **60.00 Hz**

Sync signal detection: Composite

The signal is interlaced

Trigger sync pulses from the frame start signal using:

Leading edges

Falling edges

Both edges (applies to TTL signals only)

Outgoing sync interval:  Sync delay:   $\mu\text{s}$

 Some settings have been automatically updated to match the incoming house sync signal.

**Please note:** Nvidia machines need to use the "Refresh" button to see the correct state.

4. When back out of **Server Settings** click on the **View System Topology** tab. Select **Yes** on the popup to apply the changes previously made. Once on the **View System Topology** window you will now see if Genlock has been completed if **External Sync Signal** has a green tick next to it and stating **Present (In use)**.

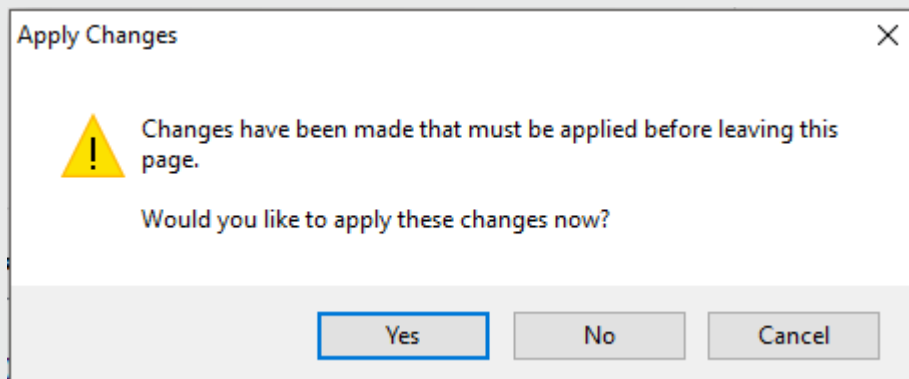



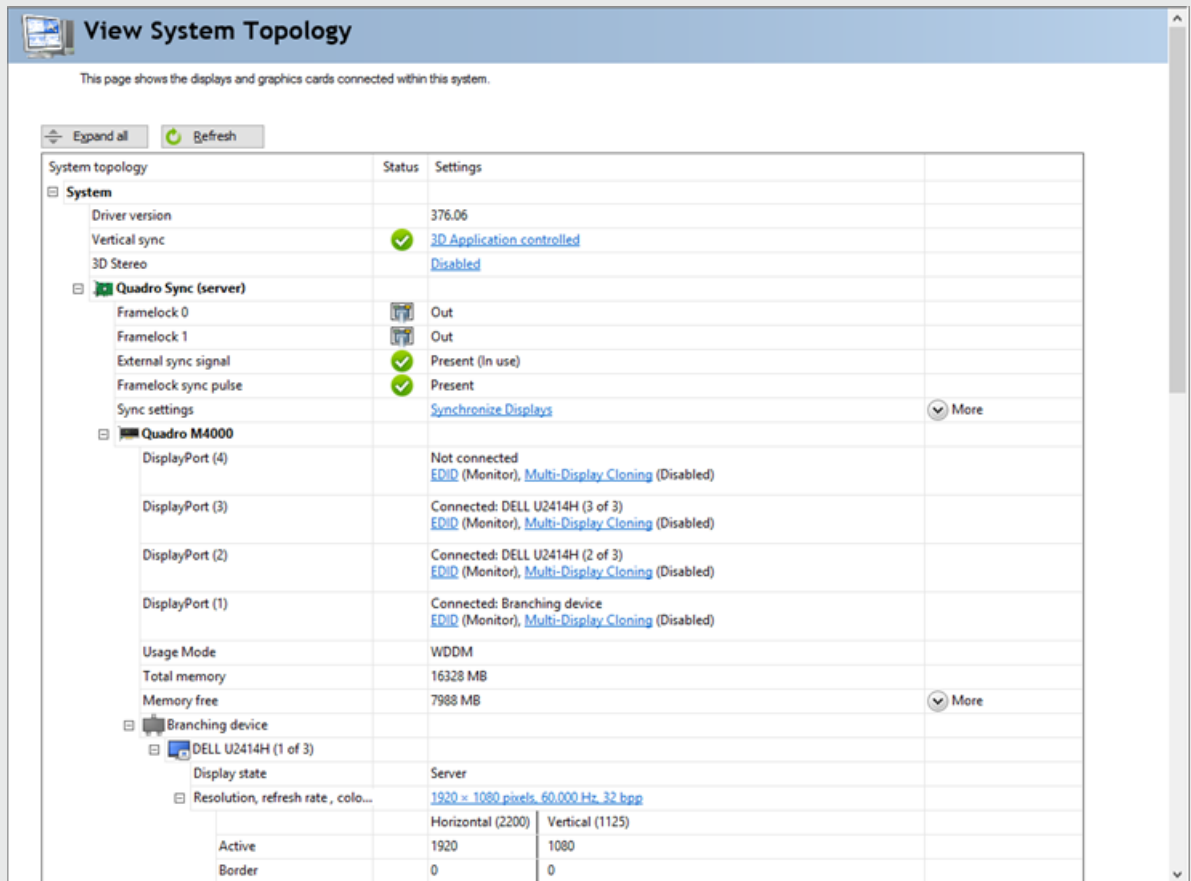

## Internal Timing Sync

To access the Catalyst Control Center to start synchronizing Internal Timing:

1. Right click on the desktop and select AMD Fire Pro Control Center.
2. Open the AMD Fire Pro Tab and click on Synchronization.
3. Under the Timing Server tab, select the last listed display. (For example in the image shown it was number 5)
4. Tick all screens that you wish to sync in the list below.
5. Your selected displays are now Internally genlocked.

Use the image below for reference of how the correct setup will look.

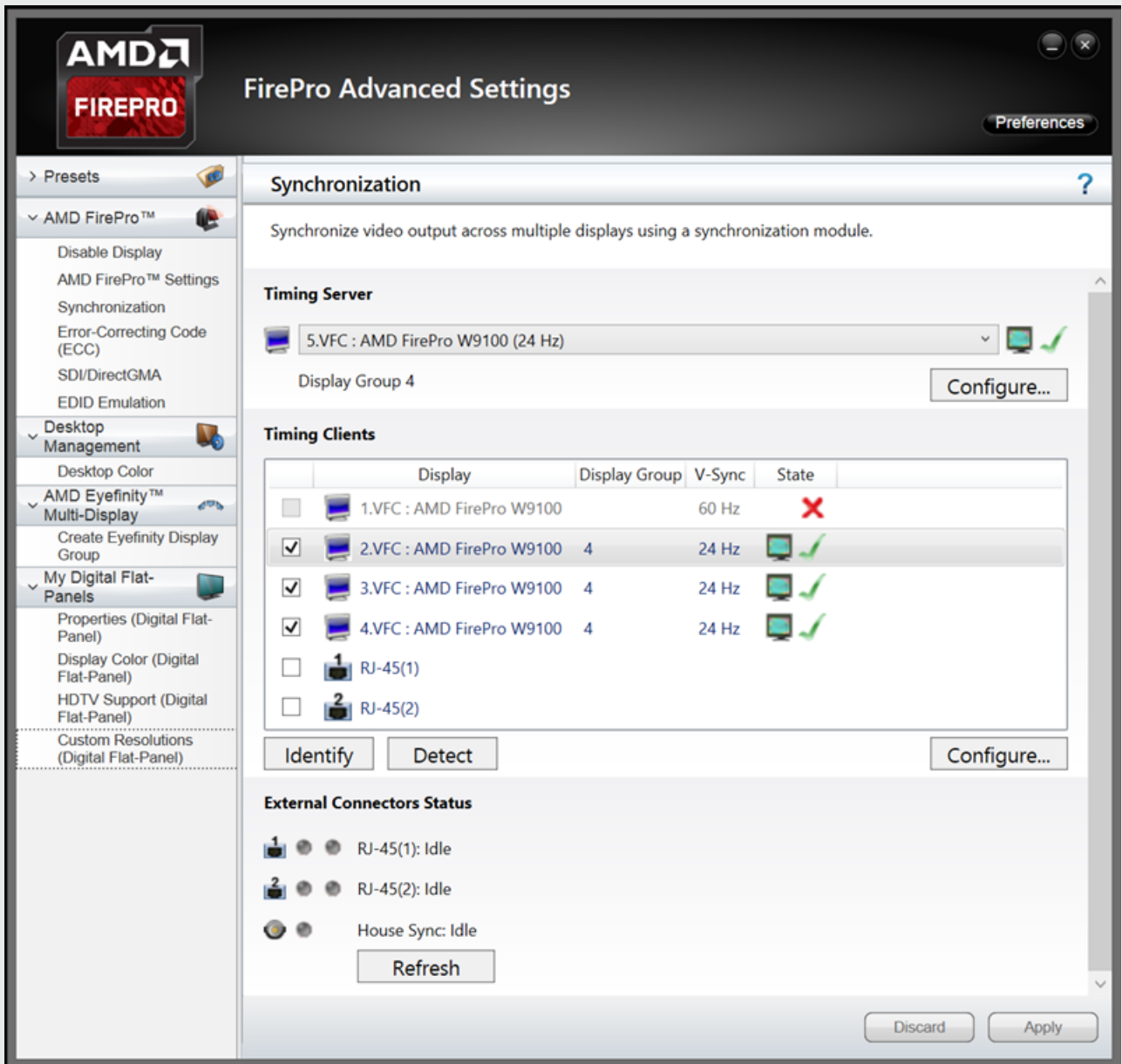

# Transports overview

The Disguise software can chase external SMPTE timecode, either as LTC (timecode over audio) or MTC (timecode over MIDI). The software can also respond to external cue commands, in the form of MIDI notes, MIDI Show Control cues, OSC, or Art-Net commands, and combine multiple cue types in the same show.

- The Transport Manager lets you configure what signals the track will receive.
- Tags let you mark points in your track that Disguise should jump to when it receives either timecode or a 'go to cue' command from an external device.
- OSC control allows for iPads, iPhones or other OSC-compatible devices to control the Disguise timeline but also to control layer properties.

# DMX Transports Overview

DMX Transports allow d3's transport controls to be controlled by external DMX sources, mainly lighting desks.

# Setup DMX transports

This sub-chapter explains how to configure Disguise software to control the [Timeline](#) with Art-Net.

Please note: GrandMA2 users can find a pre-built Timeline personality on our [download page](#).

## Creating a EventTransportDmx Object

1. Right-click on the Transport menu from the d3 State menu bar.
2. Under the **Event Transports** tab click the + icon and create a new **EventTransportDmx** object. This will open the **EventTransportDmx** editor.

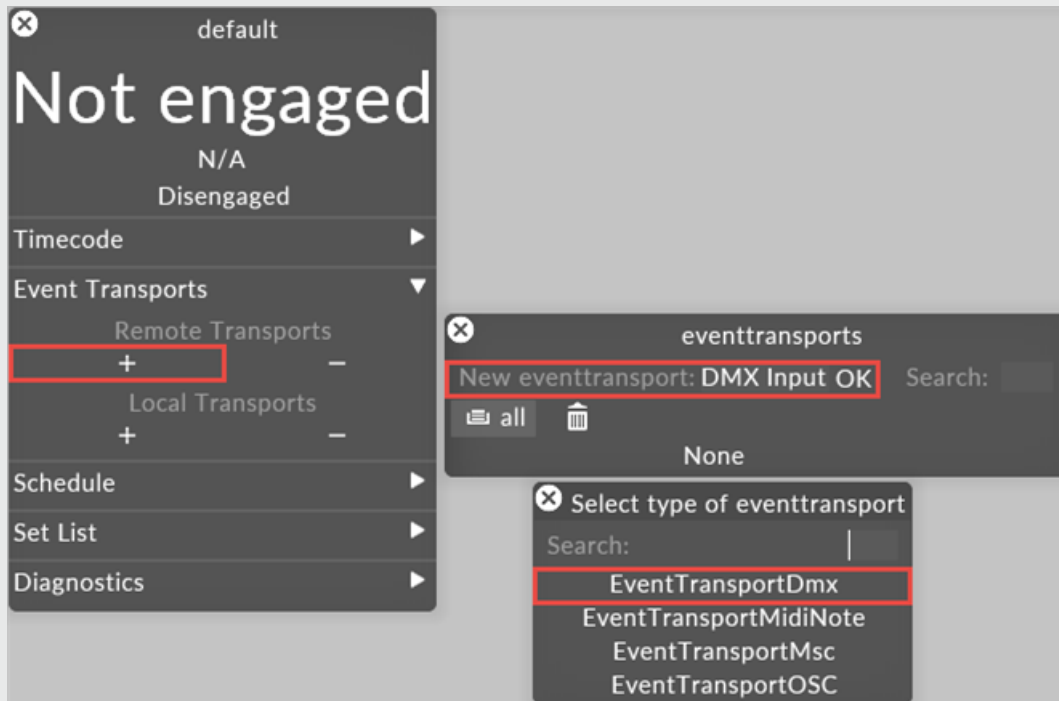

## State Listen/Command operating modes

Before creating a EventTransportDmx object it is important to understand the difference between the **state listen** and **command** operating modes.

The Disguise software offers two operating modes to utilise DMX as a show control protocol:

- State Listen mode
- Command mode



## Universe (1-base)

This is the universe Disguise software will listen on for Art-Net commands.

## Channel (1-base)

This is the channel Disguise software will listen on for Art-Net commands.

## Personality Section

### Command Channel (1-base)

**Command operating mode only.**

This is the channel Disguise software will listen for commands. When the value sent to this channel is within a range defined in the command ranges section, and the trigger channel is set to 255, Disguise will perform that command. For example, to trigger a next section command with the default settings, send a value in the range defined in the next section field, and send the value 255 to the trigger channel.

### Parameter Channel (1-base)

**Command operating mode only.**

The parameter is used when the track select command is issued. It defines which track to select.

### Trigger Channel (1-base)

**Command operating mode only.**

This is the channel Disguise will listen for triggers. A trigger triggers the command the command channel is set to when the value is 255

## Play Mode

This the play mode to be in when jumping to a cue.

### Play Status (1-base)

**State Listen Mode only**



This is the channel Disguise will listen to for play state changes.

## Brightness Channel (1-base)

This is the channel Disguise will listen to for any changes to the master brightness.

## Cue XX Number (1-base)

The value sent to this channel will set the cue xx number for any *go to cue* commands when in command operating mode. In state listen mode, Disguise will automatically jump to the cue when the value sent changes.

## Cue YY Number (1-base)

The value sent to this channel will set the cue yy number for any *go to cue* commands when in command operating mode. In state listen mode, Disguise will automatically jump to the cue when the value sent changes.

## Cue ZZ Number (1-base)

The value sent to this channel will set the cue zz number for any *go to cue* commands when in command operating mode. In state listen mode, Disguise will automatically jump to the cue when the value sent changes..

## Command Ranges Section

Command operating mode only.

This section is where you define the ranges for commands

## State Ranges Section

**State listen operating mode only.**

This section is where you define the ranges for play status channel.

## Behaviour Section

### Cues Are

This option defines where cues are global or local to the current track.

When set to **global (all tracks)**, Disguise will change track if jumping to a cue that is not on the current track. This means that all cue tags need to be unique over multiple.

When set to local (**current track**), Disguise will only jump to cues on the current track. This means cue tags do not need to be unique over multiple tracks.

## State Listen mode

In State Listen mode, Disguise listens to the state of various channels to understand how it should be responding.

State Listen utilises five channels to control the Disguise show and reacts instantly to changes in these channel values. A list of the default channels used in State Listen mode can be seen in the section EventTransportDmx Personality properties above. It allows jumping to cues at any point on any track in your project and allows you to control the play mode in which it should be.

For most purposes the State Listen mode is the most appropriate methodology.

**Please note:** If Disguise software is receiving a play status instruction via DMX, this overrides the GUI play status controls so after receiving the command from the GUI, the DMX instruction will override again. Cueing this parameter to 0 (Idle) will keep the play status and allow for the GUI controls to override.

## Command mode

In Command mode, you build a command utilising two (or more) channels and then use a trigger channel (spiking to 255) to issue the command.

In this mode two actions are required for a command to be executed:

- You construct a command by setting values in various channels
- You issue the command using a trigger channel

**Please note:** When a command has been triggered by spiking the trigger channel to 255, the trigger channel should be returned to 0 before triggering the next command.

The only exception to this is the brightness channel, which constantly matches the channel value.

Now that you understand the difference between the State Listen and Command modes, you can take the first step to controlling the Timeline with Art-Net.

# Switching tracks with DMX

## Switching tracks with DMX

1. Open the Track editor by right-clicking the titlebar of the Track Player.
2. Open the **track-select** section by left-clicking the tab.
3. Enter a value into the **track ID** text field (this value should be programmed into the lighting desk).

**Please note:** in Disguise software the **track ID** should be written in decimal format.

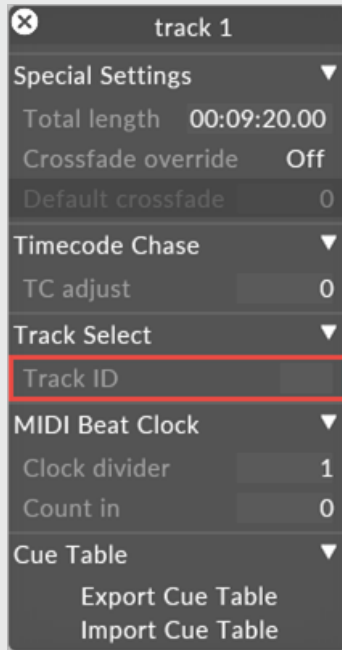

Track ID property of the Track editor is used to assign a note number to the current track, this number can then be programmed into the lighting desk

4. Set the **parameter channel** value within the EventTransportDmx object editor to match the **track ID** value.
5. Set the **command channel** value within the EventTransportDmx object object editor to within 81...90 (default).
6. Execute the trigger (with a value move from 0 to 255).

For more information on the Track editor please see [The track editor page](#).

# Triggering cues with DMX

The format for Art-Net, OSC and MSC cues is `xx.yy.zz`. (e.g. 3.1.1) and is communicated via three channels.

In State Listen mode, Disguise constantly monitors the three cue channels. If a change in any of the three channels is detected, it will attempt to go to the specified cue on the Timeline within Disguise software. These cues can be set at any Timeline point in any track.

## How to create a DMX cue

For this example we are going to use the DMX cue 1.1.3.

1. Right-click on the bar you want to jump to and create a **CUE** tag.
2. Type in the DMX cue number using the CUE tag format ( `xx.yy.zz` )into the **tag** text field.

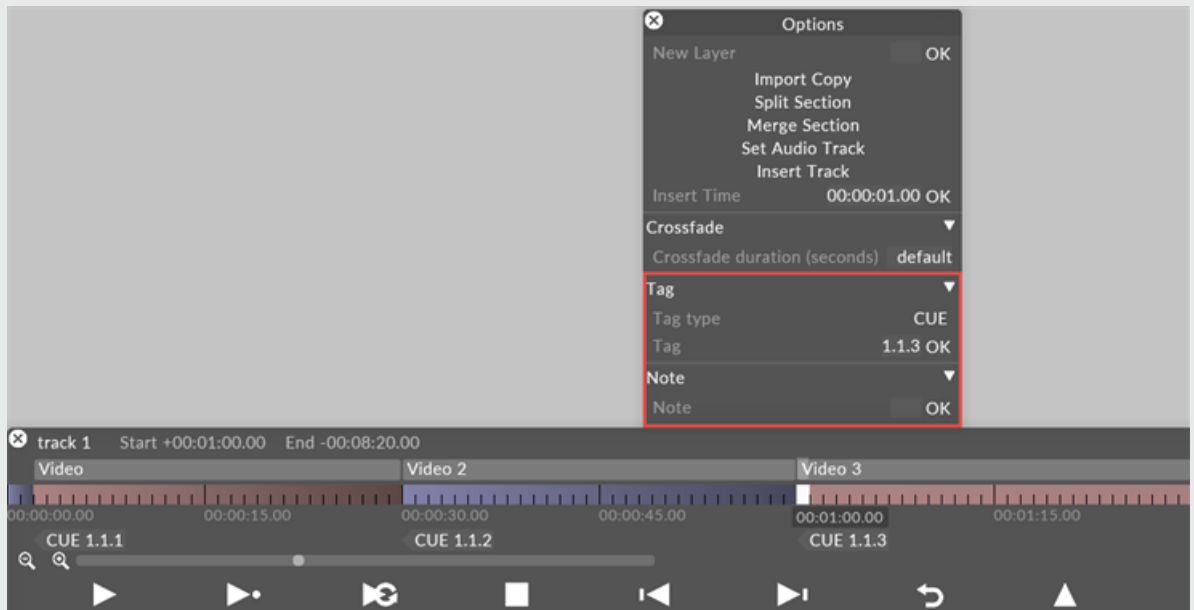

To jump to this cue the DMX channels have be set to:

- Channel 5 = 1
- Channel 6 = 1
- Channel 7 = 3

**Please note:** If Disguise cannot find the specified cue, it will simply ignore the cue and not jump to any point. Cues can be in any position on the Timeline and on any track.

# Midi Transports Overview

Delete this text and replace it with your own content.

## Midi Transports Overview

Delete this text and replace it with your own content.



# Mixing MIDI cue types

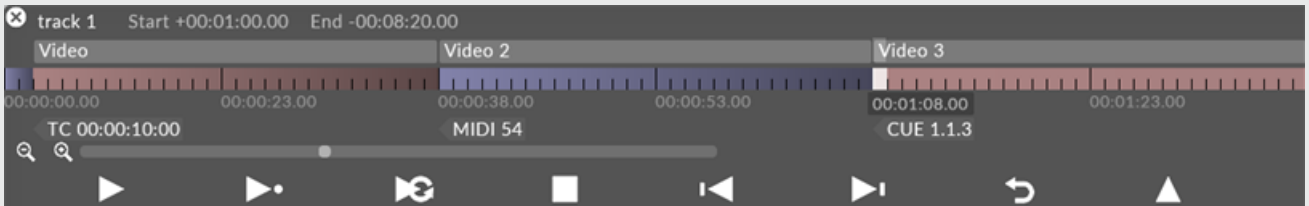

Timecode cue, MIDI note cue and Show Control cue being used simultaneously on the Timeline

In many shows, it is necessary to use different types of synchronisation at different times. For example, one song may require MIDI timecode ( MTC ) chase, another may need MIDI Show Control ( MSC ) cues, and a third one may require midi-note cueing.

To enable this, Disguise allows MIDI note and MSC commands to override its default timecode chasing behaviour. If d3 receives a MIDI note or MSC command while chasing timecode, it will immediately obey the command and stop responding to timecode. This mode is known as 'ignore MTC mode'.

When Disguise goes into this mode, the Controls editor displays the message **ignoring MTC** below the timecode readout.

Once d3 is in ignore-MTC mode, it will not respond to timecode unless either the timecode value jumps to a different position or the timecode stops and restarts.

When in ignore-MTC mode, you can manually return to normal MTC chasing mode by disengaging and re-engaging (double-click on the **engaged** button of the Controls editor).

**Please note:** if you select 'play-to-end-section or loop section play mode for MTC chasing, Disguise will go into ignore- MTC mode if it bumps into a section break while chasing.

# Sending MIDI Timecode

You can configure Disguise software to send MIDI timecode (MTC) based on the position of the playhead on the timeline. This is useful if you want Disguise to control the cues of other devices in the show, such as lighting desks, fireworks etc. To see how to configure MTC output see the [MTC layer page](#).

# Setup MIDI Note

The Disguise software can respond to MIDI notes in several ways. You can use MIDI notes to select different tracks, trigger transport commands (play, stop, next/previous section, etc) or to jump to particular sections.

## Creating a EventTransportMIDI Object

1. Right click the transport button from the dashboard.
2. Click the + icon under the Events Transport section and create a new Event TransportMIDI object. The EventTransportMIDI editor will open.
3. Make sure to press the **engage** button to enable the MIDI note input.

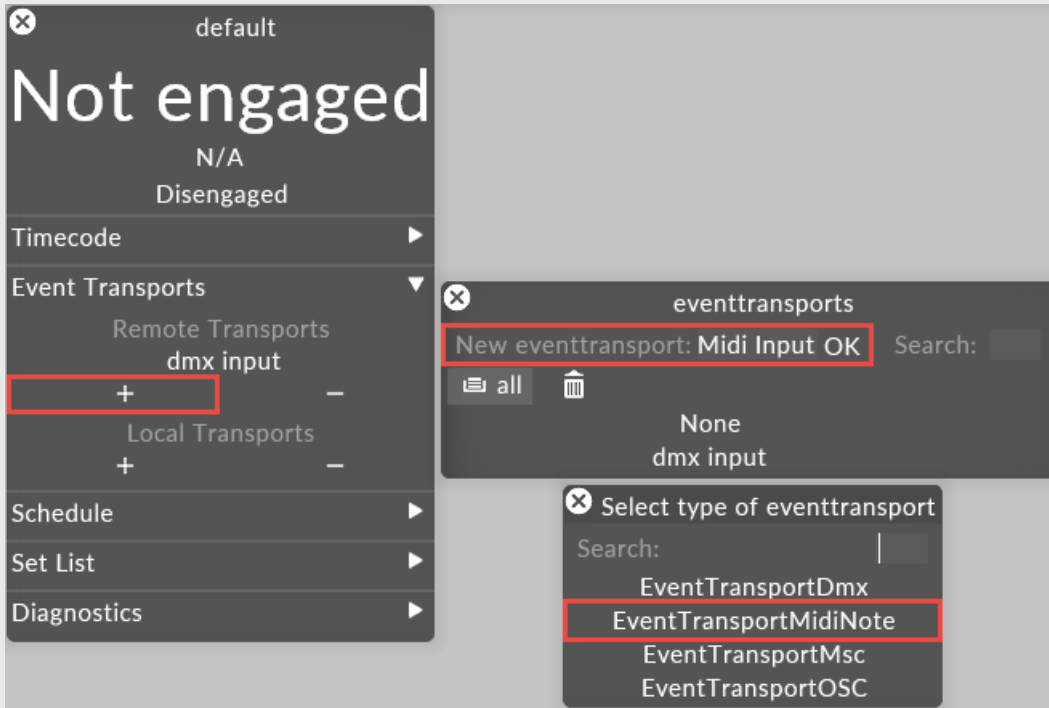

# EventTransportMIDI Editor



## MIDI Device

The MIDI device to use. You may need to download and install the driver for the MIDI device. Make sure that no other MIDI utilities (such as [MIDI/OX](#)) are open while inputting to d3 as they may conflict with d3.

## Input Channel (1 - 16)

Which MIDI channel to listen on.

## Next-Cue

The MIDI note, in decimal, to use to jump to the next cue.

## Play to End of Section

The MIDI note, in decimal, to use to set the play mode to play to end of section.

## Stop

The MIDI note, in decimal, to use to set the play mode to stop.

## Prev

The MIDI note, in decimal, to use to jump to the previous section.

## Next

The MIDI note, in decimal, to use to jump to the next section.

## Return to Start

The MIDI note, in decimal, to use to return to the first bar of the current track.

## On MIDI Note Jump

Defines what play mode to be in when jumping to a MIDI cue tag on the timeline.

## Behaviour

This option defines where cues are global or local to the current track. When set to **global (all tracks)**, Disguise will change track if jumping to a cue that is not on the current track. This means that all cue tags need to be unique over multiple tracks. When set to local (**current track**), Disguise will only jump to cues on the current track. This means cue tags do not need to be unique over multiple tracks.

## Issuing transport commands based on MIDI notes

You can use MIDI notes to issue transport commands (effectively hitting the play, play-to-end-section buttons via MIDI notes).

- Open up the MIDI control editor of the EventTransportMIDI editor and type in the note number (in decimal format) into the box next to the command you want to control. If the value of these numbers is 0, no note is assigned.

When executing a command from the MIDI device the corresponding property will flash in cyan.

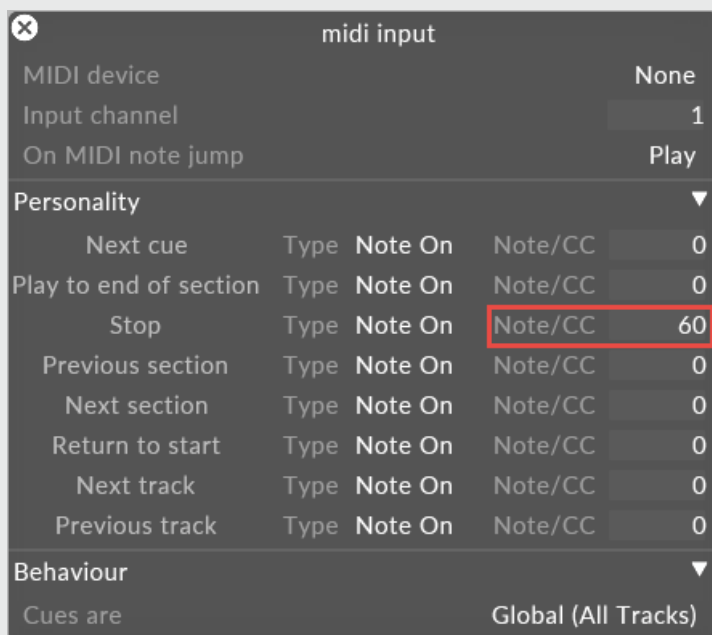

The MIDI property will flash in cyan as soon as Disguise receives the command from the MIDI device.

Please note: You can tag cues in the track as 'channel.note' if they are channel specific, and just 'note' to listen to all channels being sent.

**Please note:** You can tag cues in the track as "channel.note" if they are channel specific, and just "note" to listen to all channels being sent.

**Please note:** **midi next-cue** is a composite command. If Disguise software is stopped, **midi next-cue** will press the **play to end section** button; if Disguise software is playing, it will press the **next section** button. This allows you to use a single command to start tracks and to hit cues.

# Tagging a specific section with a specific MIDI note

You can also tag any bar of any track with a specific MIDI note by editing the tag on that bar. To do this:

- Go to the bar, right-click the bar or press **Ctrl-T**, then type into the **Tag** text box the note number and any other label text you like in the note box. When Disguise software receives that MIDI note, it will jump to that section.

For example, the following notes tag 'section 1' with MIDI note 53 and 'section 2' with MIDI note 54.

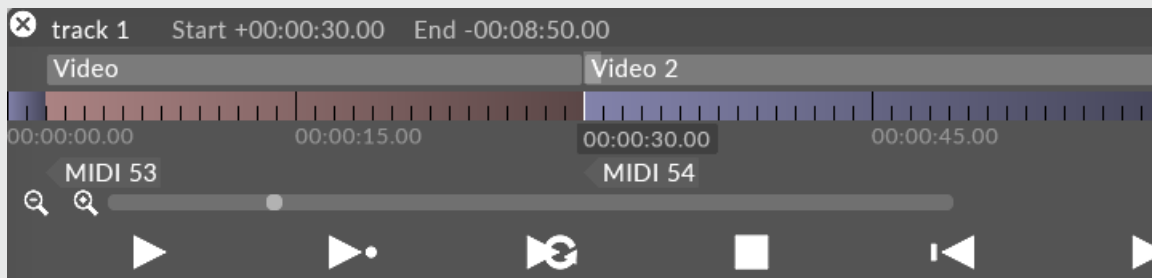



# Setup MIDI Show Control

The Disguise software can be set up to respond to MIDI Show Control ( MSC ) cues, usually issued by a lighting desk. Cue numbers are usually written as x.y.z, where x, y and z are integers. This allows for new cues to be easily inserted between existing cues. For example, if you have cues 1 and 2, you can insert a cue between them by numbering it 1.5, and so on.

You do not need to take any special action in order to set up MSC cue triggers. You only need to set up the incoming MIDI device using the **EventTransportMSC** object.

## Creating the EventTransportMSC

1. Open the **transport editor** from the dashboard by right clicking the **transport** button.
2. Click the **+** icon under **event transports** and create a new **EventTransportMSC** object.

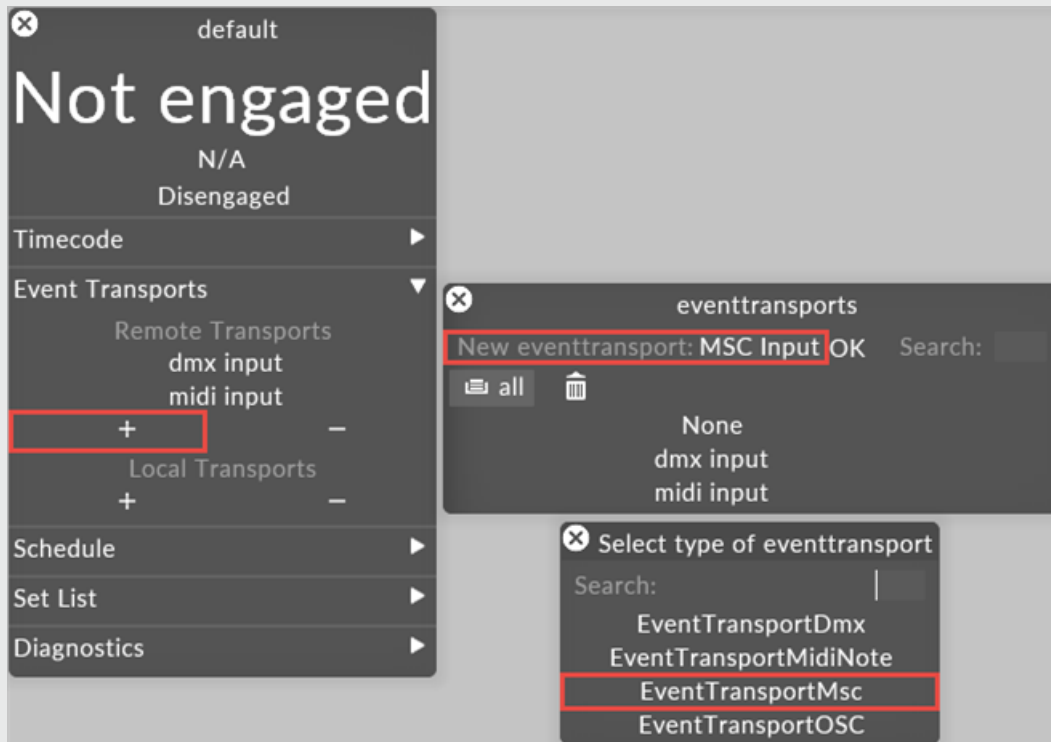

## EventTransportMsc Editor

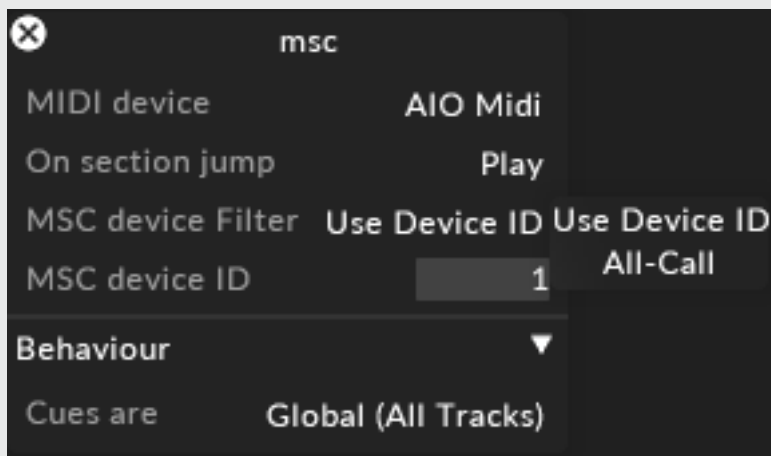

## Midi Device

The midi device used for MSC.

## On Section-Jump

What play mode to be in when jumping.

## MSC Device Filter

When set to Use Device ID, d3 will filter out incoming MSC commands that are only for this device.

When set to All-Call, d3 will listen to all incoming MSC commands regardless of the device ID

## MSC Device ID

Specific the Device ID of the receiving MIDI Transport.

## Cues Are

This option defines where cues are global or local to the current track.

When set to **global (all tracks)**, d3 will change track if jumping to a cue that is not on the current track.

This means that all cue tags need to be unique over multiple tracks.

When set to local (**current track**), d3 will only jump to cues on the current track. This means cue tags do not need to be unique over multiple tracks

## Jumping to cues using MSC

To jump to cues

- To mark a section of a track with a midi cue number, go to that section and right click to bring up the options. Under Tag type, right click and set the cue type to CUE. Then simply type in the cue number you'd like into the Tag field and hit OK. You can add a note to this cue by filling in the Note field and hitting OK.

For example, the following note sets up cue 1 to be **start**.

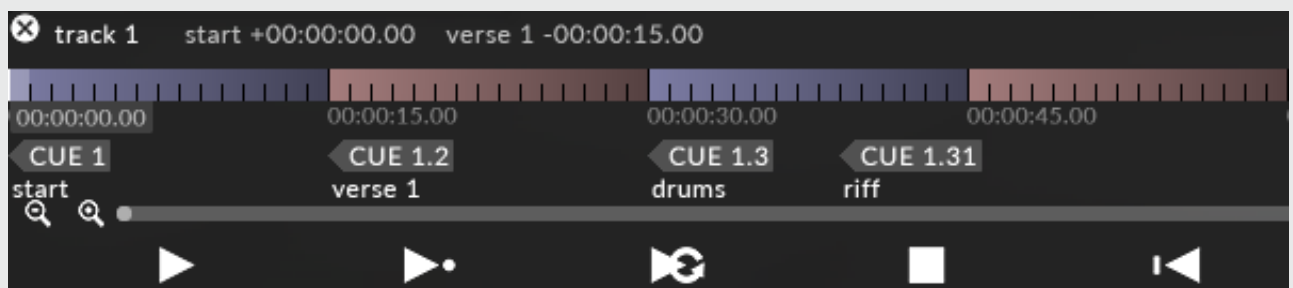
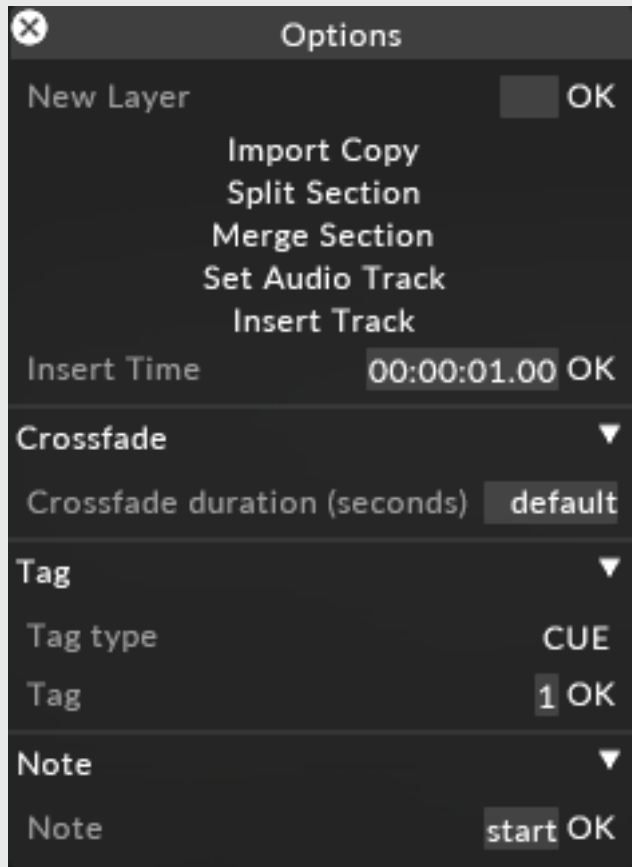

Marking Midi Show Control cue points (CueNumber: MyCueLabel) on a track

# Troubleshooting MIDI

## Proving MIDI Input

MIDI-OX is a multipurpose MIDI toolkit and is very useful for troubleshooting any MIDI related problems. You can check the MIDI input coming from an external source by doing the following.

1. Open up MIDI-OX, and select **Options > MIDI Devices**.

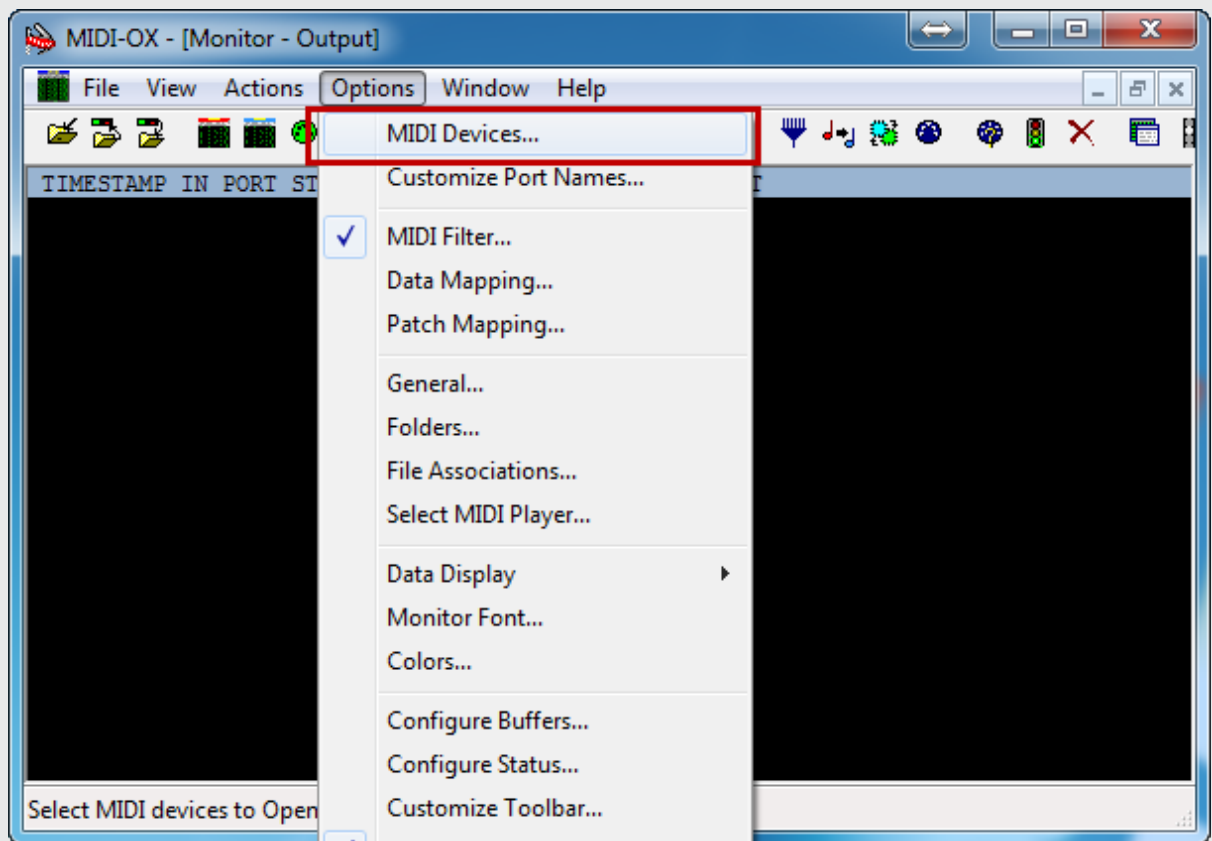

2. **Left-click** on you MIDI input. Click **OK**.

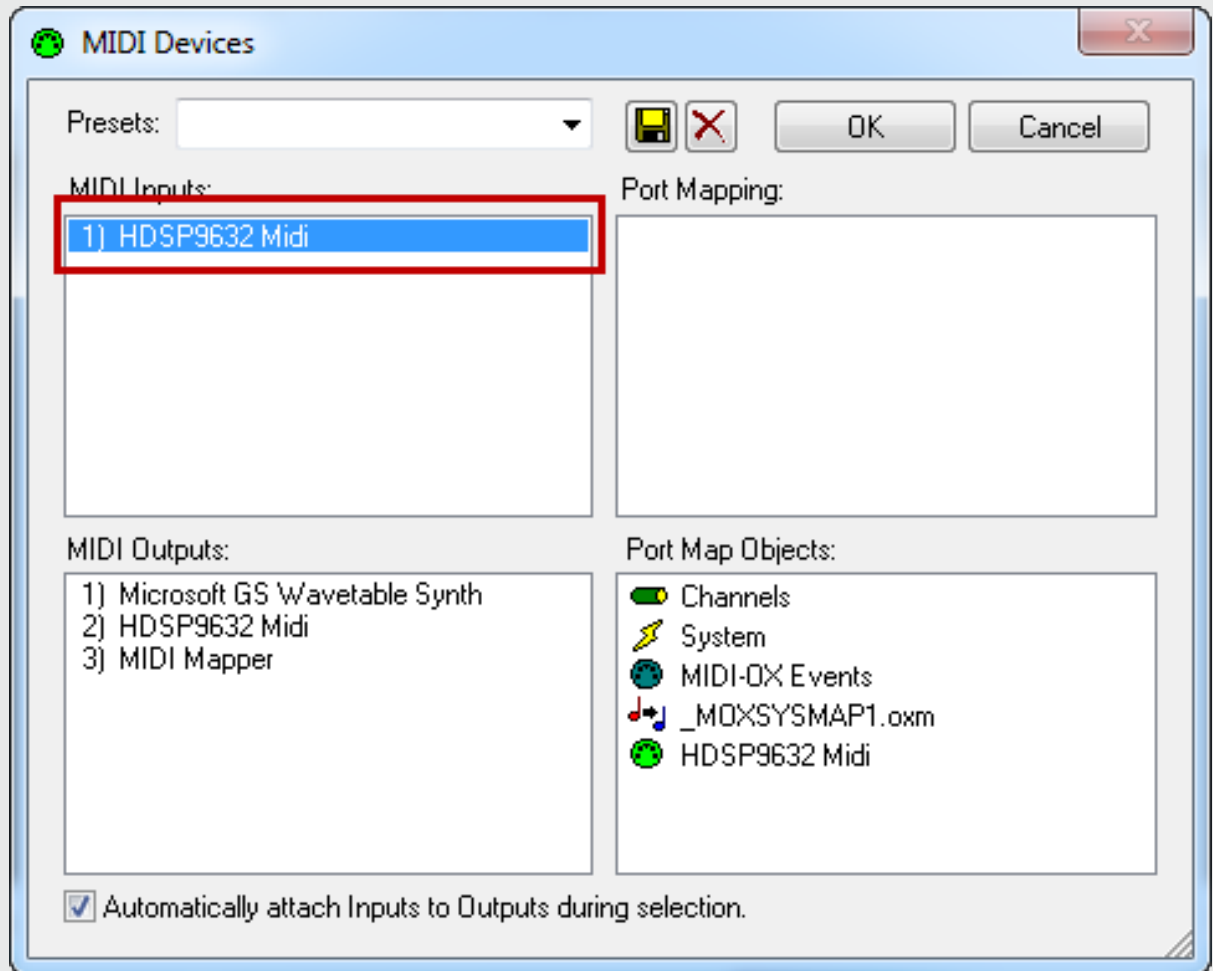

If there is a MIDI signal coming into the selected port you will see the data in the MIDI monitor window.

MIDI-OX - [Monitor - Output]

File View Actions Options Window Help

TIMESTAMP	IN	PORT	STATUS	DATA1	DATA2	CHAN	NOTE	EVENT
00035619	1	--	F1	72	--	--	--	MTC Quarter Frame
00035623	1	--	F1	08	--	--	--	MTC Quarter Frame
0003562D	1	--	F1	11	--	--	--	MTC Quarter Frame
00035637	1	--	F1	2A	--	--	--	MTC Quarter Frame
00035641	1	--	F1	30	--	--	--	MTC Quarter Frame
0003564B	1	--	F1	40	--	--	--	MTC Quarter Frame
00035655	1	--	F1	50	--	--	--	MTC Quarter Frame
0003565F	1	--	F1	64	--	--	--	MTC Quarter Frame
00035669	1	--	F1	72	--	--	--	MTC Quarter Frame
00035673	1	--	F1	01	--	--	--	MTC Quarter Frame
0003567D	1	--	F1	10	--	--	--	MTC Quarter Frame
00035687	1	--	F1	2B	--	--	--	MTC Quarter Frame
00035691	1	--	F1	30	--	--	--	MTC Quarter Frame
0003569B	1	--	F1	40	--	--	--	MTC Quarter Frame
000356A5	1	--	F1	50	--	--	--	MTC Quarter Frame
000356AF	1	--	F1	64	--	--	--	MTC Quarter Frame
000356B9	1	--	F1	72	--	--	--	MTC Quarter Frame
000356C3	1	--	F1	03	--	--	--	MTC Quarter Frame
000356CD	1	--	F1	10	--	--	--	MTC Quarter Frame

No Output Device | 1 Input Device | REC SYX MAP KYB LOG

# OSC

## OSC applications

There are several applications available for iOS that are capable of sending OSC commands. Two applications that Disguise uses are Liine by Lemur and TouchOSC by hexler.net.

To download examples of TouchOSC and Lemur layouts please go to the [OSC Downloads](#) page of the Disguise website.

**Please note:** the sliders within TouchOSC application are set as float values between 0 to 1.

## Creating OscDevices

An OscDevice is created in the same way as any other device type. Please see the earlier sub-chapter [Creating devices](#) for step-by-step instructions on how to create a device, and select **OscDevice** from the menu of different device types. Alternatively, by default d3 contains an OscDevice called **osc 1**, which can be selected from the Devices manager.

## OSCDevice properties

### sendIPAddress

This property specifies the IP value of the machine/device for out going commands to be sent to.



## sendPort

This property specifies the port number of the machine/device for out going commands to be sent to.

## receivePort

This property specifies the port number for incoming commands.

For more information on setting the IP address please see the sub-chapter [Windows Settings](#).

## OSC Transport Control

For information how to use OSC expressions on the timeline please see the [OSC Transport Control](#) page.

## Controlling layer properties with OSC

For information how to use OSC expressions to control layer properties please see the [Controlling layer properties with OSC](#) page.

# OSC templates

Disguise have made two OSC templates available for the iOS applications; [TouchOSC](#) and [Lemur](#).

- To use the template layout first download the [TouchOSC](#) or Lemur from iTunes.
- Please see the [Lemur support page](#) and [TouchOSC support page](#) for how the install the interface.

Download our pre-made [Lemur OSC template](#).



Download our pre-made [Touch OSC template](#).



# OSC syntax library

This section lists the objects in Disguise software that can be controlled by OSC. Furthermore, it outlines the message strings and arguments required to control each object with OSC.

**Please note:** These messages are simply the default entries. They are use configurable through the [OSC transport editor](#).

## Input messages

From a device broadcasting OSC, messages can be sent using the following addresses and arguments to control Disguise software.

### Play

Sets the playhead to play.

Address: `/d3/showcontrol/play`

Argument: responds to a message with no arguments, a float with a value of 1.0, or any other data.

### Play to end of section

Sets the playhead to play to end of section.

Address: `/d3/showcontrol/playsection`

Argument: responds to a message with no arguments, a float with a value of 1.0, or any other data.

### Loop section

Sets the playhead to play and loop section.

Address: `/d3/showcontrol/loop`

Argument: responds to a message with no arguments, a float with a value of 1.0, or any other data.

## Stop

Sets the current track to stop.

Address: `/d3/showcontrol/stop`

Argument: responds to a message with no arguments, a float with a value of 1.0, or any other data.

## Previous section

Sets the playhead to jump to the previous section.

Address: `/d3/showcontrol/previoussection`

Argument: responds to a message with no arguments, a float with a value of 1.0, or any other data.

## Next section

Sets the playhead to jump to the next section.

Address: `/d3/showcontrol/nextsection`

Argument: responds to a message with no arguments, a float with a value of 1.0, or any other data.

## Return to start

Sets the playhead to return to the first bar of the current track.

Address: `/d3/showcontrol/returntostart`

Argument: responds to a message with no arguments, a float with a value of 1.0, or any other data.

## Previous track

Sets the playhead to jump to the previous track.

Address: `/d3/showcontrol/previoustrack`

Argument: responds to a message with no arguments, a float with a value of 1.0, or any other data.

## Next track

Sets the playhead to jump to the next track.

Address: `/d3/showcontrol/nexttrack`

Argument: responds to a message with no arguments, a float with a value of 1.0, or any other data.

## Cue

Sets the playhead to jump to a specified cue.

Address: `/d3/showcontrol/cue`

Argument: responds to a message with a float between 0.0 and 1.0, or integer values.

For further information see the [Triggering Cues with OSC](#) page.

## Float cue

The float cue is a special derivative of the cue. It is designed to receive floats from programs that cannot send multiple arguments.

Address: `/d3/showcontrol/floatcue`

**Please note:** when using the float cue the cues should be padded out to the hundredths place (IE: 1.1 should be 1.10)

For further information see the [Triggering Cues with OSC](#) page.

## Cue play mode

Sets the playback mode when a specified cue is triggered.

The following options are available:

- no change
- stop

- play
- play to end of section
- loop section

## Fade up

Sets the master brightness to fade up.

Address: `/d3/showcontrol/fadeup`

Argument: responds to a message with no arguments, a float with a value of 1.0, or any other data.

## Fade down

Sets the master brightness to fade down.

Address: `/d3/showcontrol/fadedown`

Argument: responds to a message with no arguments, a float with a value of 1.0, or any other data.

## Volume

Sets the master volume.

Address: `/d3/showcontrol/volume`

Argument: responds to a message with a float between 0.0 and 1.0.

## Brightness

Sets the master brightness.

Address: `/d3/showcontrol/brightness`

Argument: responds to a message with a float between 0.0 and 1.0.

## Output messages

d3 broadcasts OSC messages using the following strings and arguments to an OSC device.

## Heartbeat

Sends an on/off heartbeat signal for every frame.

Address: /d3/showcontrol/heartbeat

Argument: sends a message with a float between 0.0 and 1.0.

## Track position

Sends a string which contains the current track timecode.

Address: /d3/showcontrol/trackposition

## Track name

Sends a string which contains the current track name.

Address: /d3/showcontrol/trackname

## Current section name

Sends a string which contains the current section name.

Address: /d3/showcontrol/currentsectionname

## Next section name

Sends a string which contains the next section name.

Address: /d3/showcontrol/nextsectionname

## Section Hint

Address /d3/showcontrol/sectionhint

Outputs the current section cue tag, note, and time elapsed as well as the upcoming sections cue tag, note, and time remaining until that section.

## Volume

Sends a string which represents the master volume.



Address: /d3/showcontrol/volume

Argument: sends a message with a float between 0.0 and 1.0.

## Brightness

Sends a string which represents the master brightness.

Address: /d3/showcontrol/brightness

Argument: sends a message with a float between 0.0 and 1.0.

## BPM

Sends a string which represents the current track BPM.

Address: /d3/showcontrol/bpm

Argument: sends an integer value.

## Feedback mode

Changes how Disguise software sends output messages.

- Send changes only: Sends output messages only when values change (heartbeat still sends every frame). Please note, this mode may behave unreliably if on a wireless network.
- Always send - Sends all output messages every frame. Please note, this mode is reliable but at the expense of a small increase in network traffic.
- Never send - Send no output messages.

# Setup OSC transport

To use OSC transport control please follow the steps described below. Please note that if jumping to a specific section in the timeline you need to tag the timeline with a specific cue syntax.

## Step 1: Create an OSC device

An OscDevice is created in the same way as any other device type. Please see the earlier sub-chapter [Creating devices](#) for step-by-step instructions on how to create a device, and select **OscDevice** from the menu of different device types. Alternatively, by default d3 contains an OscDevice called **osc 1**, which can be selected from the Devices manager.

## Step 2: Create an OSC transport control event

1. Right click **transport**.



This will open the transport controls dialog.

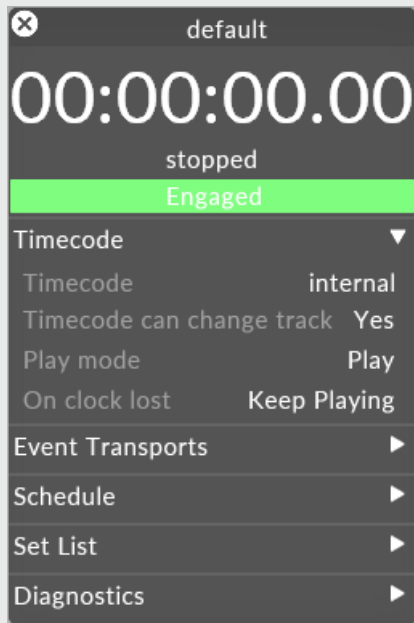

2. **Left click** on the **+** button.
3. Create a new **eventtransport**.
4. Select **EventTransportOSC** from the transport list.

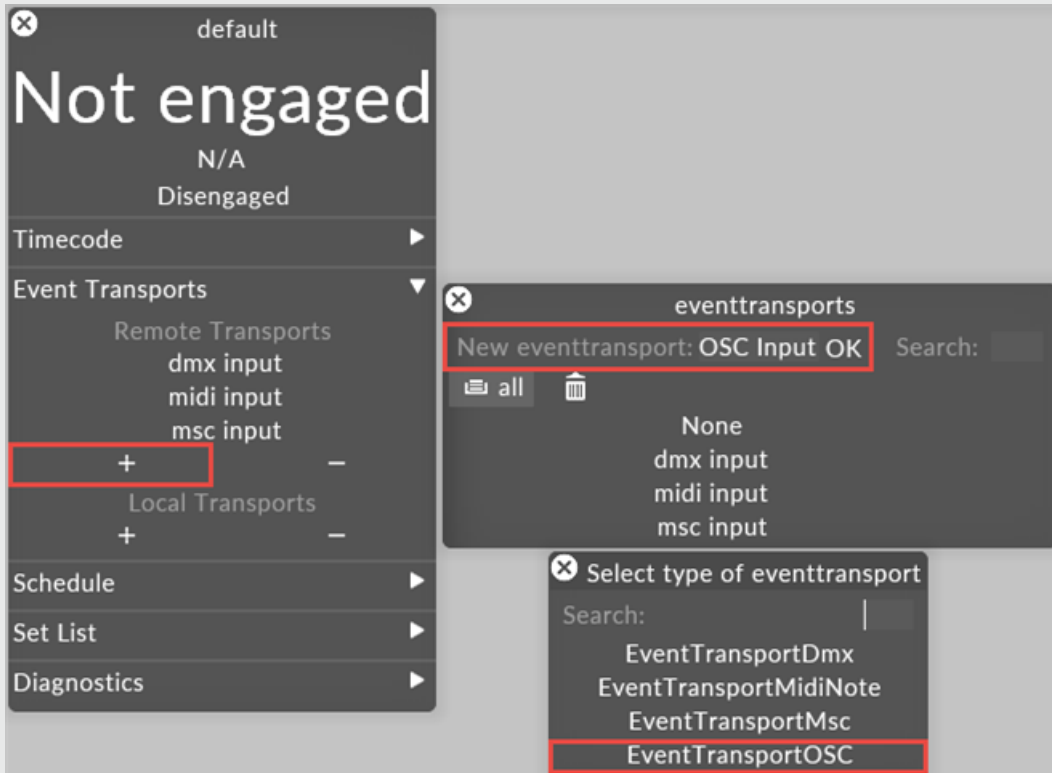

## Step 3: Configure OSC Control

A new OSC event transport dialog will open. Remember to select the OSC device you created in step 1.

default

# Not engaged

N/A  
Disengaged

**Timecode** ▼

Timecode tap tempo  
Timecode can change track Yes  
Play mode Play  
On clock lost Keep Playing

**Event Transports** ▼

Remote Transports  
dmx input  
midi input  
msc input  
osc input

+ -  
Local Transports  
+ -

**Schedule** ▼

Schedule schedule 1

**Set List** ▼

Set list automatic

**Diagnostics** ▼

Trace level Off

osc input

OSC device osc

**Input Messages** ▼

Play /d3/showcontrol/play  
Play to end of section /d3/showcontrol/playsection  
Loop section /d3/showcontrol/loop  
Stop /d3/showcontrol/stop  
Previous section /d3/showcontrol/previoussection  
Next section /d3/showcontrol/nextsection  
Return to start /d3/showcontrol/returntostart  
Previous track /d3/showcontrol/previoustrack  
Next track /d3/showcontrol/nexttrack  
Track name /d3/showcontrol/trackname  
Track ID /d3/showcontrol/trackid  
Cue /d3/showcontrol/cue  
Float cue /d3/showcontrol/floatcue  
Cue play mode No Change  
Fade up /d3/showcontrol/fadeup  
Fade down /d3/showcontrol/fadedown  
Volume /d3/showcontrol/volume  
Brightness /d3/showcontrol/brightness

**Output Messages** ▼

Heartbeat /d3/showcontrol/heartbeat  
Track position /d3/showcontrol/trackposition  
Track name /d3/showcontrol/trackname  
Track ID /d3/showcontrol/trackid  
Current section name /d3/showcontrol/currentsectionname  
Next section name /d3/showcontrol/nextsectionname  
Section hint /d3/showcontrol/sectionhint  
Volume /d3/showcontrol/volume  
Brightness /d3/showcontrol/brightness  
BPM /d3/showcontrol/bpm  
Feedback mode Always Send

**Behaviour** ▼

Cues are Global (All Tracks)

## Step 4: Engage OSC Transport Control

To engage OSC transport control, left-click on **disengaged** in the transport window.

The button will flash green which means that the all transports controls are engaged.

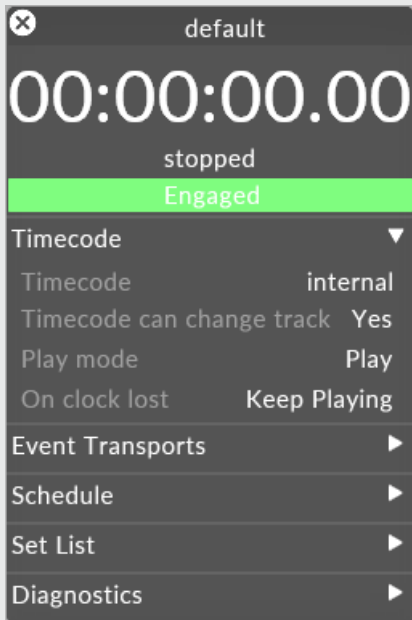

**Please note:** If you want changes you make in Disguise to appear on the OSC application you are using, feedback mode needs to be set to always send or only send changes.

# Triggering cues with OSC

The track on the Timeline can have cues assigned to it, which can then be triggered by incoming OSC messages.

## Step 1

To trigger a track bar with OSC, first ensure Disguise software is setup with an OSC device and an OSC transport. To read more about OSC setup for Disguise, see the [Configuring OSC Control](#) page.

## Step 2

Create an OSC interface following the example below, which can be downloaded [here](#). This was created in [TouchOSC](#) but any application capable of sending OSC is adequate, for example [Lemur](#).

**Please note:** To open the TouchOSC interface, first run TouchOSC, then open the layout from inside the application.

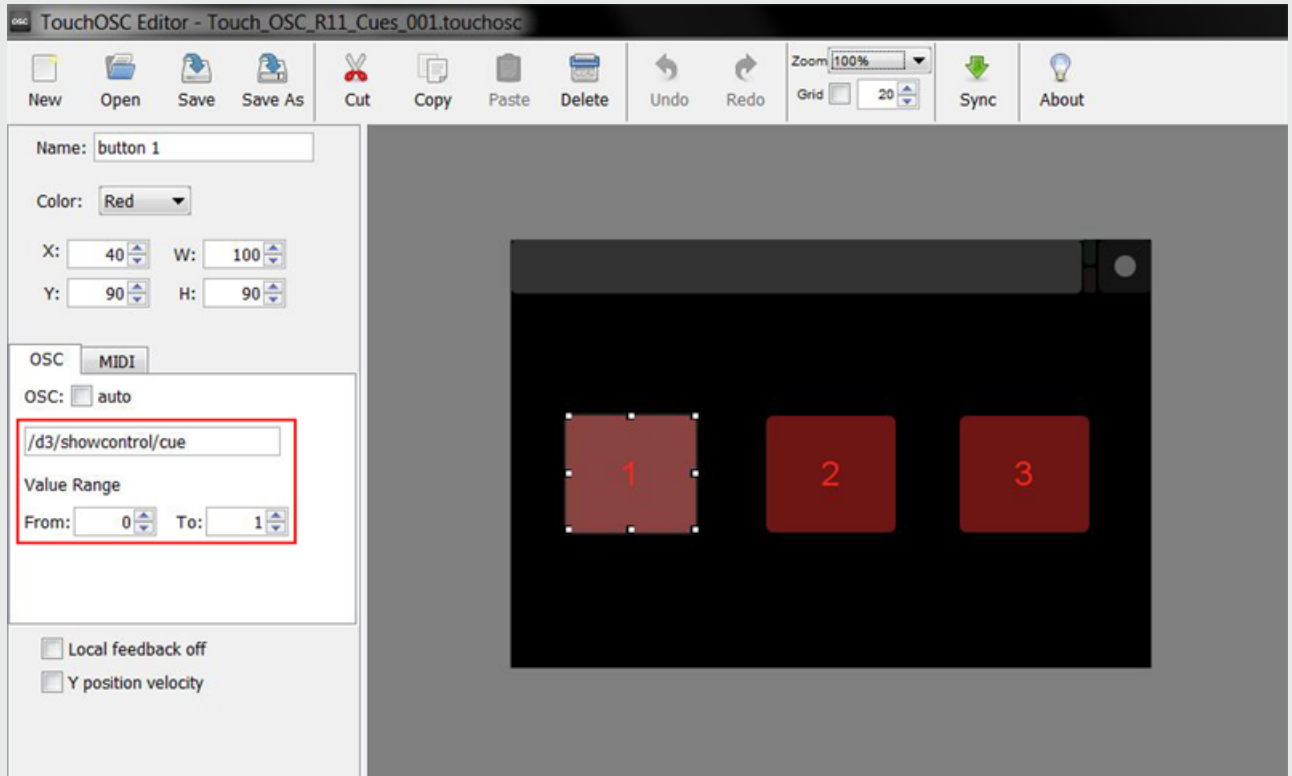

The OSC layout above shows three buttons each having an assigned string and argument.

String: `d3/showcontrol/`

Arguments: button 1 sends a message with float values between 0 and 1, button 2 sends a message with float values between 0 and 2 (shown below), and button 3 sends a message with float values between 0 and 3.



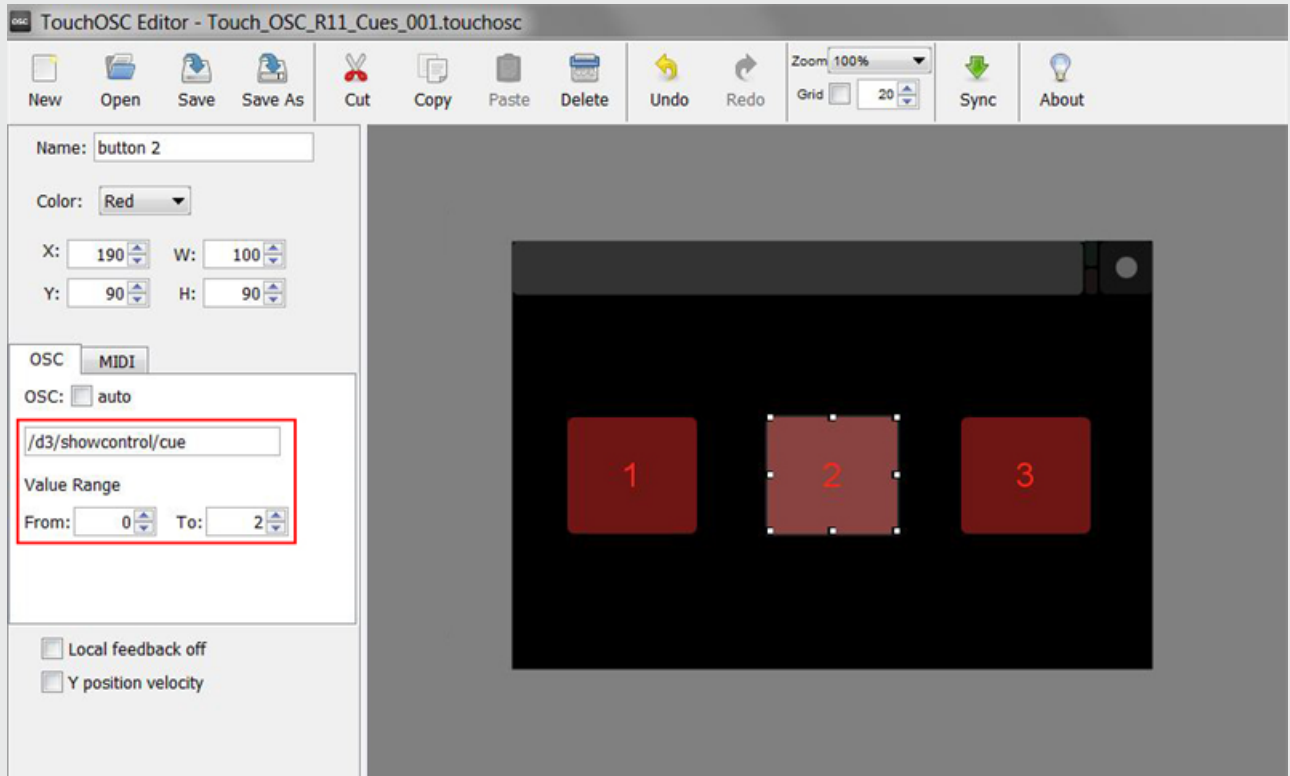

TouchOSC layout with button 2 assigned values 0 and 2 as an argument.



**Warning:** Because TouchOSC sends a cue value of 0 when you release the button, it will cause Disguise to jump to CUE 0 on the track. This is a limitation of TouchOSC, the workaround being to not have CUE 0 assigned to the track.

## Step 3

Setup the Timeline to receive incoming OSC messages. Assign cues to the track following a format that matches the argument(s) being received. In the example below, three cues were assigned to a track, each corresponding to a different argument.

- CUE 1 will be triggered by an OSC message sending a single argument value of 1.
- CUE 2 will be triggered by an OSC message sending a single argument value of 2.
- CUE 3 will be triggered by an OSC message sending a single argument value of 3.



Cues assigned to a track on the Timeline following three different formats for receiving three different incoming OSC messages.

**Please note:** You can trigger cue x.y and x.y.z by sending a double or triple argument from a supported OSC system.

## ETC Eos OSC cue triggering

Use the string `/d3/showcontrol/cue=%3,%4`

This will send an OSC message with every cue of the integer and the float past the decimal point. So, cue 1.1 on the Eos will trigger cue 1.1 in disguise.

**Please note:** Disguise software understands cues as xx.yy, not xx.xx. This means that leading zeros are ignored (cue 1.1 and cue 1.01 both read as cue 1.1 inside Disguise software) Only in the last decimal point will this be an issue.

For more granular control, this can be changed to be `/d3/showcontrol/cue=%2,%3,%4`. That allows the first number to be cue list, second cue integer and third float. So `cuelist 3 cue 4.5` will trigger cue tag 3.4.5

**Please note:** The arguments are separated by commas in the Eos output section, but are sent as period separated.

## Qlab OSC cue triggering

An OSC message from Qlab can hold multiple arguments, separated by a space. So in Qlab make a generic OSC cue and for it's string set it to `/d3/showcontrol/cue 7 8 9` and this will trigger cue 7.8.9 inside Disguise software.

**Please note:** Qlab messages can have a varied number of arguments, Disguise software will only accept three or less.

# Timecode Transports Overview

The Disguise software is able to receive incoming timecode signals, and trigger transport commands from those signals.

The following timecode formats are supported.

- LTC
- Midi Beat Clock
- MTC
- Tap Tempo
- Internal tester
- System time (Windows clock)

# Transports overview

The Disguise software can chase external SMPTE timecode, either as LTC (timecode over audio) or MTC (timecode over MIDI). The software can also respond to external cue commands, in the form of MIDI notes, MIDI Show Control cues, OSC, or Art-Net commands, and combine multiple cue types in the same show.

- The Transport Manager lets you configure what signals the track will receive.
- Tags let you mark points in your track that Disguise should jump to when it receives either timecode or a 'go to cue' command from an external device.
- OSC control allows for iPads, iPhones or other OSC-compatible devices to control the Disguise timeline but also to control layer properties.

# Transport manager

External synchronisation is managed by the Transport manager.

Transport Managers in disguise allow for the control of playback to be sent via external commands to keep all cues across devices in sync. Transports can be controlled by timecode, Midi Show Control, Midi Note, DMX and OSC devices. Transports can contain multiple tracks, as defined by their assigned Set List.

The control of multiple Transport Managers can be done through a MultiTransport controller.

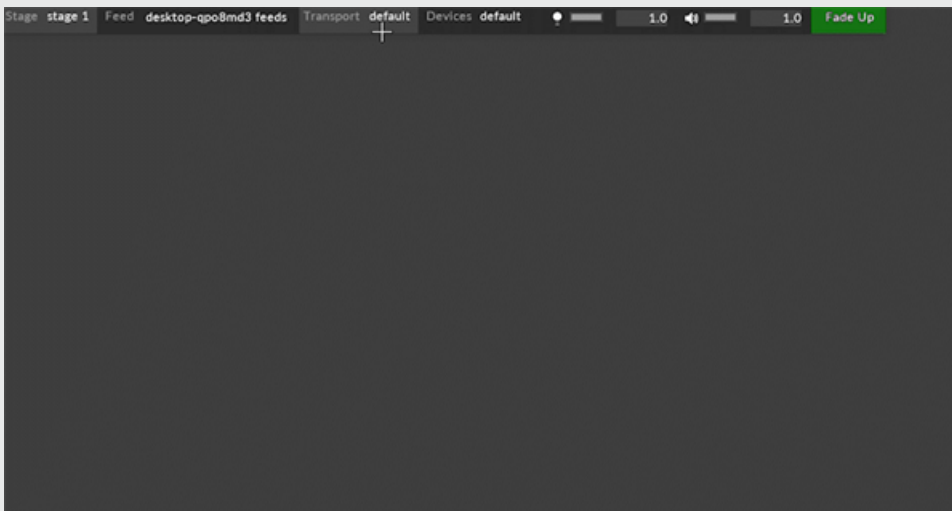

## Opening the Transport manager

To open the Transport manager:

Right-click **transport** in the dashboard.



Right-click Transport to open the Transport Manager

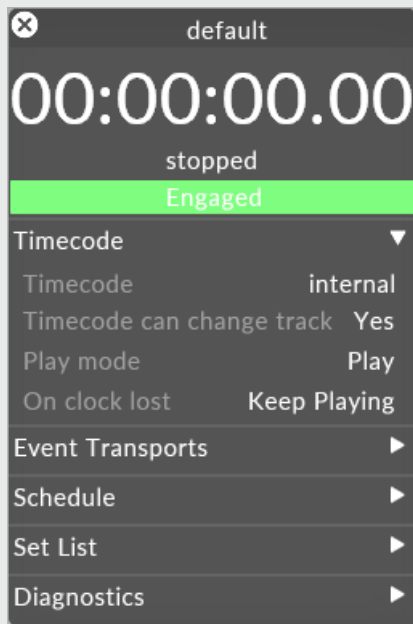

The transport manager manages external synchronisation

The transport manager gives you a large-format readout of the current clock time received when a transport device is connected to Disguise, and information about whether external synchronisation is **engaged** or **disengaged**.

**Please note:** while working with external synchronisation, it can be useful to make the Transport editor sticky by `Ctrl+ left-clicking` the close button of the editor. From this point on, the Controls editor will remain open so you can always see its state. For more

information, scroll down to the section 'Making menu windows sticky' in the [object editor overview](#) sub-chapter.

## Transport Editor properties

### Timecode readout

This shows the current value of the incoming clock signal, if any. This is a raw clock value, i.e. no adjustment has been applied to it. If you are chasing LTC or MIDI timecode, the display shows the standard hours:minutes:seconds:frames.

### Chase status

Below the timecode readout is a status message. This is usually blank, but gives you useful status information about the current chase scenario.

### Engaged/disengaged

The Engaged/Disengaged button allows you to turn synchronisation on or off. When set to **disengaged**, all external control signals are ignored. This is particularly useful when you are in a rehearsal situation and want to edit while the rehearsals are taking place.

- To engage, left-click the button; it will then begin flashing green and say **engaged**. The state of the Engaged/Disengaged button is persistent. This means that if you restart the software, it will be in the same state you left it in.

### Timecode

The **transport** property contains a **TimecodeTransport** object, used for syncing to LTC or MTC. See [Setting up LTC in Disguise](#), [Setting up MTC in Disguise](#).

**Please note:** There can only be one timecode transport active at a time.



## Timecode can change track

When timecode is received, Disguise searches through timecode tags on the timeline to determine where to jump to. If this option is set to 'yes', Disguise will search across all tracks in the currently selected track box, and jump to the first matching track it finds. If this option is set to 'no', Disguise will only search within the currently selected track.

## Play mode

This specifies what play mode Disguise should select when chasing timecode - play normal (ignore section breaks), play-to-end-of-section, or loop. If the play head hits the end of the section in play-to-end-mode while chasing timecode, the playhead will hold at the end of the section and go into 'ignore timecode' mode; it will stay in this mode until timecode either restarts or jumps elsewhere.

## On clock lost

In a rehearsal situation, timecode stop usually means a pause in rehearsal; in this scenario, it's more convenient for Disguise to stop playback when timecode is interrupted or stops. In a show situation, on the other hand, timecode loss is usually an accident (someone tripped over a cable, or a device failed) and it's better to keep playing ("the show must go on"). This switch selects which behaviour to use.

## Local & Remote Transports

Event transports allow Disguise to be controlled externally by Art-net, OSC, MSC and MIDI notes. Please see Controlling the timeline with [Artnet Control](#), [MIDI Show Control](#), [MIDI Note Control](#), [OSC Control](#).

- Remote Transports affect the d3Net network at all times that the Transport Manager is engaged. This is generally items like a controlling Lighting Desk or a master show control system (e.g. Alcorn McBride).
- Local Transport are for local control surfaces on Editors. They only affect the d3Net timeline when the Editor is **Locked to the Master**

## Schedule

A schedule allows Disguise to run automatically according to a schedule. Please see [Scheduling](#).

## Set List

User defined lists used to reorder tracks for playback. Please see [Set List](#).

## Trace Level

When set to on, Disguise will print out all transport events to the console ( accessible with **ALT-C** ).

# Setup LTC

## Setting up LTC input

First connect your LTC source to you hardware's soundcard and then open up the transport editor. Please see [Using Timecode in Disguise](#) to see how to setup the software to chase timecode.

1. From the main **transport** editor, create a new timecodetransport object and select the type **TimecodeTransportLtc**.

2. Make sure to press the **engage** button to enable the timeline to slave to the incoming LTC.

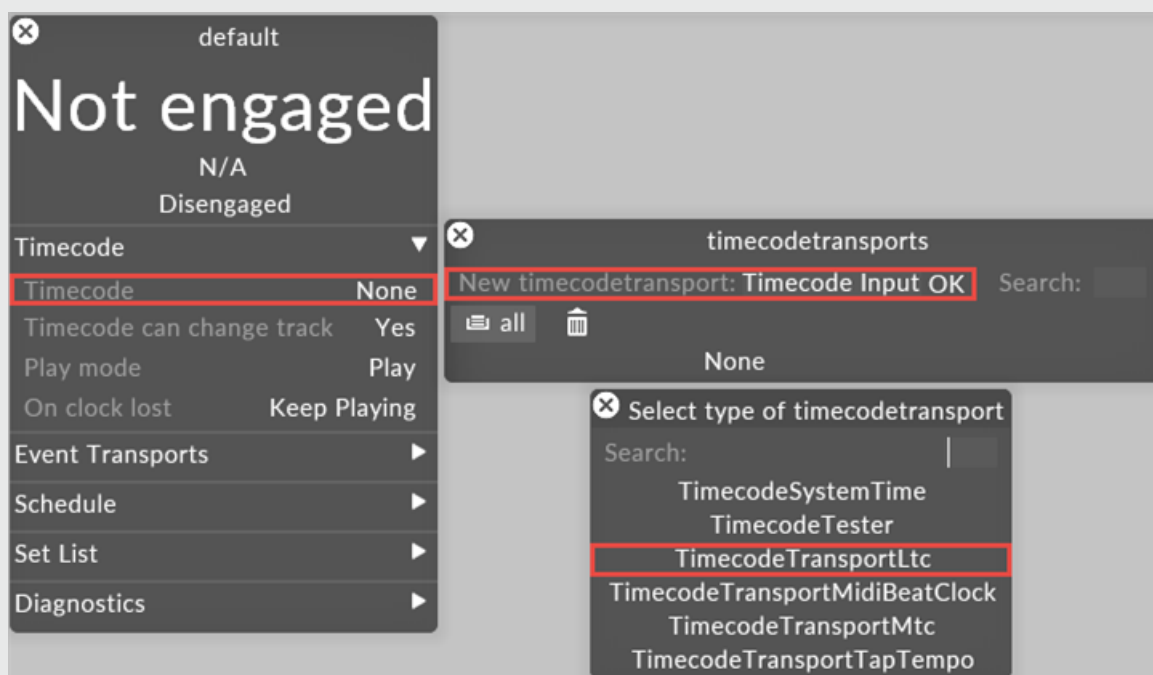

## LTC Transport Properties

### Timecode Readout

Displays the current incoming timecode. If there is no line-in selected, it will report 'No valid clock found'. If there is no incoming signal, it will report 'Clock not running'.

### Line-in

This is the audio input to use for LTC.

Note, that on the Solo, LTC can be received through the microphone connector on the rear of the machine.

### SMPTE clock type

The clock type (FPS) if the incoming LTC. The options are:

- 23.976fps
- 24fps
- 25fps
- 29.97fps drop frame
- 30fps

## Adjust (sec)

Allows you to add a delay (in seconds) to the incoming timecode.

## Setting up the line-in

The next step is to setup the line in to use for LTC. To do so, left-click on the line-in property of the LTC transport editor and create a new audioline. This will open up the audioline editor for your new audioline.

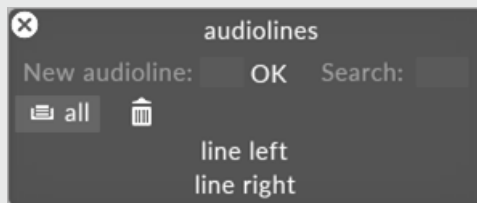

## Audioline editor

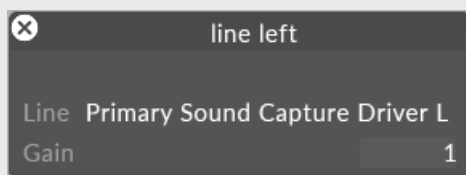

## Signal Meter

Displays the levels of the incoming signal from the selected iLine. By default, this shows an plot of incoming EQ levels (bass on the left, treble on the right); click on the signal meter to switch to a direct

view of the signal, with clipping highlighted in red.

## iLine

This is the audio input to use.

## Gain

If the incoming audio level is too low to extract a reliable clock signal from, you can boost the signal using the gain control. Incoming audio levels are simply multiplied by this number. Note however that if gain is too high, clipping will result, which can make clock detection unstable.

Once the audioline is setup and receiving signal, you will see the timecode readout update with the current time reference.

## Notes on playback behaviour

**Please note:** When a clip is set to Mode: Locked and includes a timecode trigger, the content will 'jam sync' to incoming timecode, jumping from one section to another with timecode

**Please note:** When a clip is set to Mode: Normal and includes a timecode trigger, the content will be fired at the moment of the timecode trigger but is then free-running relative to timecode

**Please note:** In case there is an overlap of the time code of the section you're in and the next / a TC tag, it will not trigger

# Setup MIDI Beat Clock

MIDI beat-clock chase is particularly useful for shows with electronic music of which the tempo may change compared to the guide audio in the track. It can also be used in rock shows where the drummer is playing to (or generating) a click-track.

MIDI beat-clock is effectively a regular metronome. When chasing beat-clock, Disguise will match the tempo and phase of the incoming signal, varying its playback speed accordingly. This is useful for shows that rely on rhythmic, to-the-beat editing and quantised video playback. MIDI beat-clock carries tempo and phase information but does not carry song position information. This makes it possible to combine it with manual or MIDI-based cue and track selection.

## Setting MIDI Beat Clock chase

1. Create a new timecode object in the **transports** editor.
2. Choose **TimecodeTransportMidiBeatClock**.
3. Make sure to press the **engage** button to enable the MIDI beat-clock.

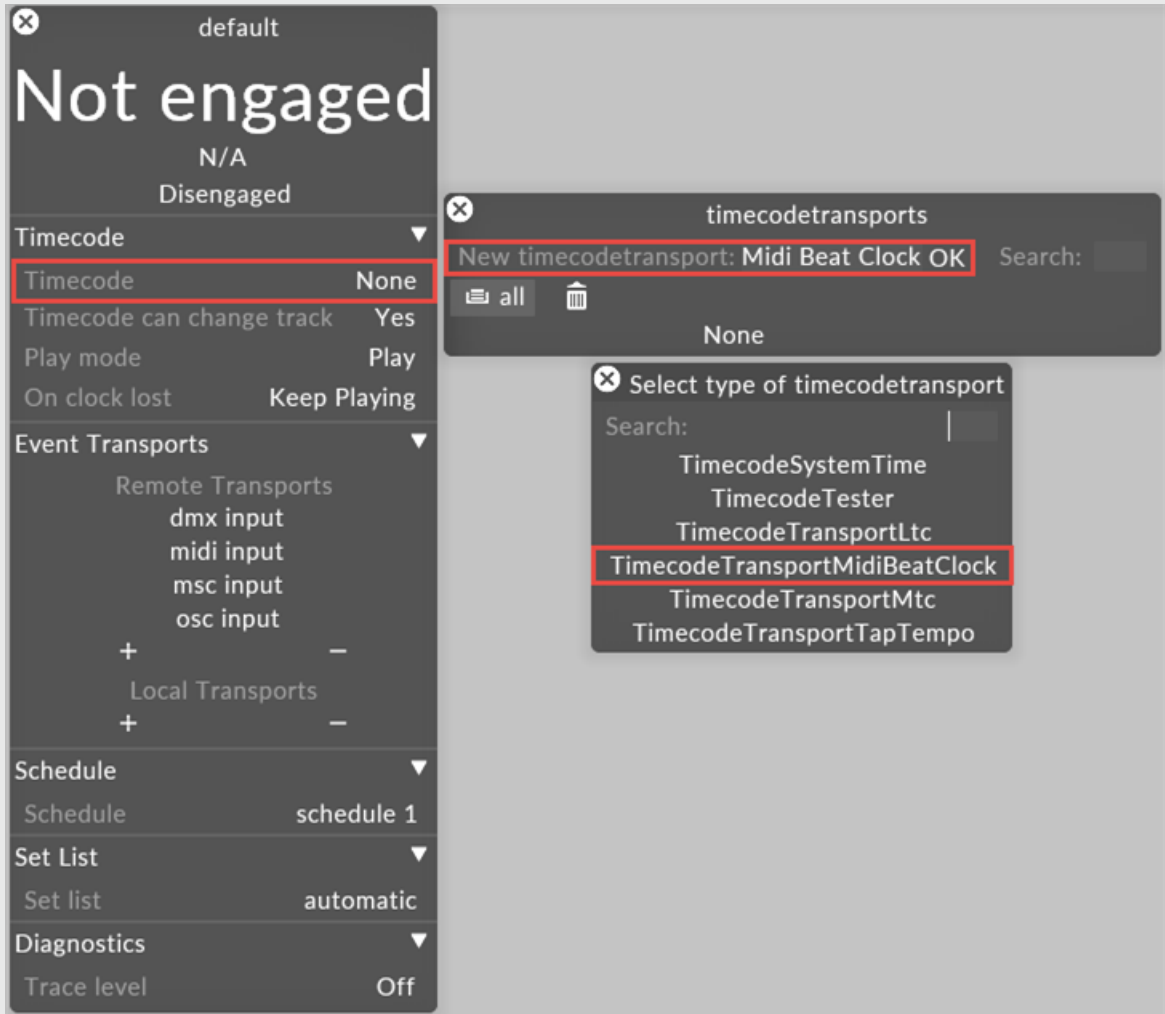

## Midi Beat Clock Properties

### Clock device

As with MTC chasing, this can be set to the same device as the main MIDI input device or to a different device if necessary.



## Input lock type

This should be set to **beat clock**.

## Play mode

This selects the play mode that Disguise uses when chasing beat-clock it can be normal **play**, **play to end section**, or **loop section**.

## On clock lost

When Disguise stops receiving clock beats (or receives a stop command), it can either stop or continue playing. For rehearsals, you will usually select **stop** mode, and then switch to **keep playing** mode during the live show.

## On clock regained

If d3 loses and then regains clock, it can either start from the beginning of the track or continue from where it currently is in the Timeline. Again, **reset to start** is the norm for rehearsals, and **play from current** is the best response during a live show.

## Adjust

As with MTC , the adjust property allows you to delay the video signal relative to the audio. Positive values will make video events happen earlier, negative values will delay the video in relation to the audio.

## MIDI beat-clock track settings

To change the per-track settings, open up the track you want to change, right-click the title bar to open the Track editor and open up the **midi beat-clock** tab.

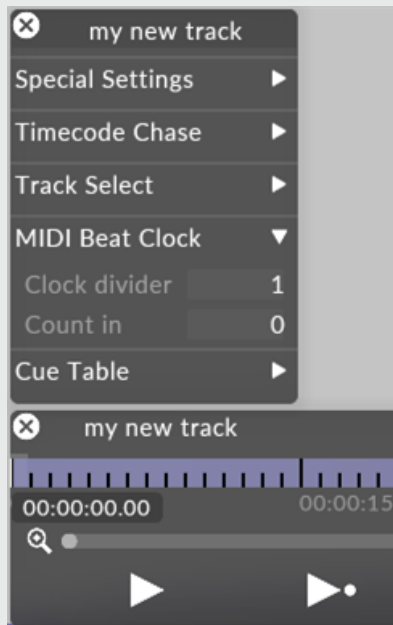

Midi Beat-Clock properties of the Track Editor are used to change the track tempo and add a beats count in

## Clock divider

When working with quantised guide audio, it can happen that you quantise a track and end up with a different bpm than the musician has assigned to the track. For example, you might quantise a track to 120 bpm and then find that the clock signal for that track is coming in at 240 bpm. The **clock divider** property is useful in such a situation: the tempo of the incoming clock signal is simply divided by this number. In this example, you should simply set the clock divider to 2 in order to take the incoming 240-bpm signal and down-step it to 120 bpm, allowing d3 to play back at the correct speed. Similarly, in the opposite case (quantising at 240 bpm, but then receiving at 120 bpm), you should set the divider to 0.5 (1/2).

## Count in

When starting a song, it is usual for the clock to issue a count-in: a number of beats that indicates the start of the track, but happens before the song starts. For example, if you set **count in** to 4 beats,

Disguise will wait four beats after clock-start before starting to play the track. During count-in, the bpm indicator in the Controls editor shows the letter **c** after the beat-count.

For more information on the other properties contained in the Track editor please see the [Editing tracks](#) sub-chapter.

## Jumping during beat-clock chase

When Disguise is chasing beat-clock, it will always remain in the correct phase, so that it always stays locked to the beat. If you issue a transport command (for example jump-to-next-section), d3 will remain locked to the beat even if you issue the command midway through a beat. For example, if you issue a jump-to-next-section command when the beat counter is 0.5, d3 will jump to the next section and then jump 0.5 beats forward in the Timeline. This enables you to move around the track while knowing that Disguise will always remain on time.

# Setup MTC

## Setting up MTC

1. First connect your MTC source to the MIDI input on your hardware.
2. From the main **transport** editor, create a new timecodetransport object and select the type **TimecodeTransportMtc**.
3. Make sure to press the **engage** button to enable the timeline to slave to the incoming MTC.

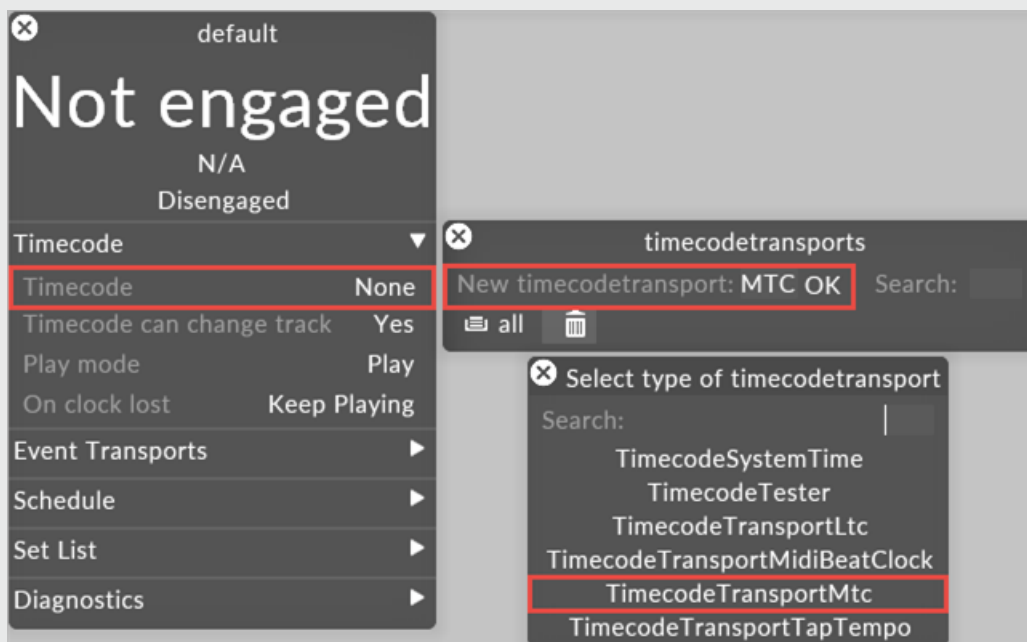

# MTC Properties

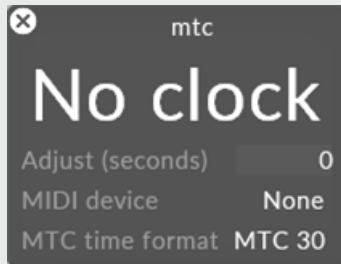

## Adjust

This option lets you add a delay to the incoming clock signal. This is useful for adjusting for front-of-house delay in different stage situations. The number, measured in seconds, is added to the time value received; so a negative number will delay the visuals relative to the audio.

## MIDI device

The MIDI device to use for MTC input.

**Please note:** Designer does not support MTC output.

## MTC Time Format

The time format of the incoming MTC (fps). Options are;

- 24fps
- 25fps
- 29.97fps drop frame
- 30fps

Please see the [Using Timecode in Disguise](#) page for how to setup syncing to timecode.

# Setup Tap Tempo

The Tap Tempo feature lets the user define a bpm of the active track based on keyboard input. This feature is useful for live operation when you want visuals to match tightly to the beat but where no other timecode input is available.

## How to setup Tap Tempo

1. From the main **transport** editor, create a new timecodetransport object and select the type **TimecodeTapTempo**.
2. Make sure to press the **engage** button to enable Tap Tempo.

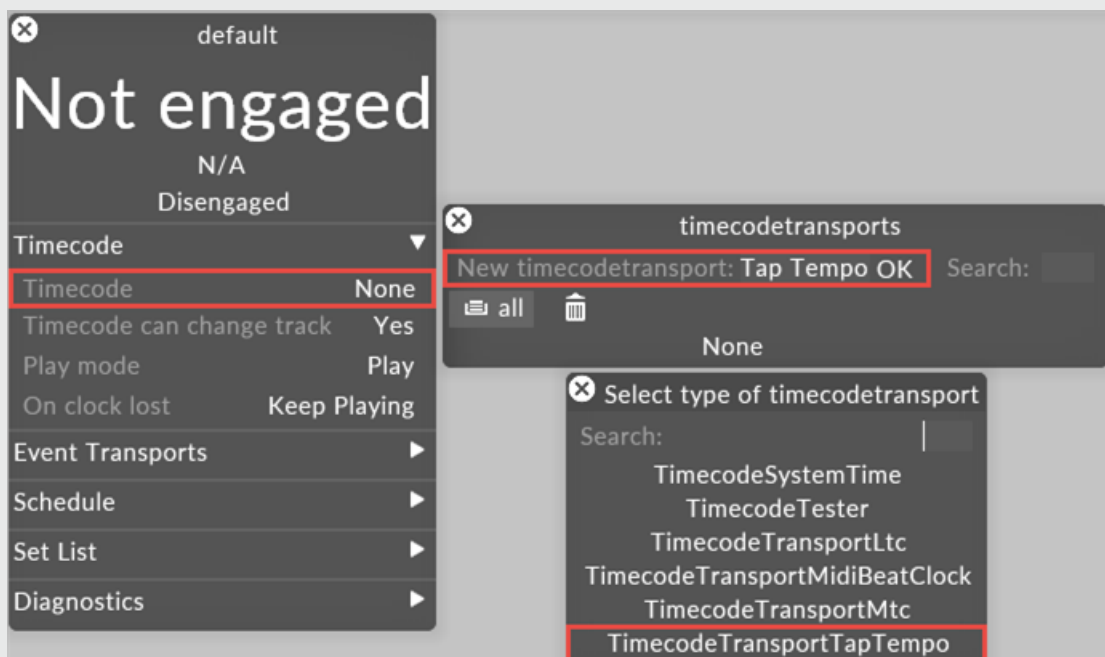

# How to use TapTempo

1. To set a bpm, click the down the **INS** button as many times as set in the **min bpm taps** property described below. If using a MacBook Pro you may need to click **Fn+INS** to do this.
2. To jump to a specific bar while keeping the current bpm just click on that bar with the mouse.
3. If **Chase beat count** mode is active and you wish to place the playhead in the very beginning of the timeline, hold to the **DEL** key. If using a MacBook Pro you may need to click **Fn+Backspace** to do this. This feature is rarely needed.
4. Tapping **delete** will reset the beat counter to zero.

## TapTempo editor

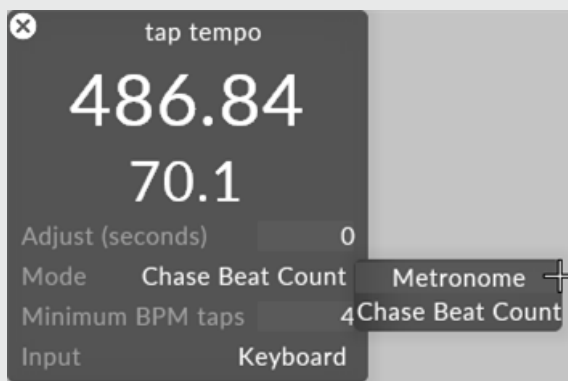

### Beat read-out

Displays the total number of beats that has been played.

### Bpm read-out

Displays the current bpm based on keyboard input.

### Adjust

A value set in seconds that compensates for a potential delay. This values is usually ranging between 0-0.5 sec. This feature is rarely used and will be most likely removed in future releases.

## Mode

### Metronome

When Metronome mode is active the bpm will change as to the keyboard input without affecting the position of the timeline playhead. Metronome mode is set to default and is considered to be and used in most cases of live operation using TapTempo.

### Chase beat count

Chase beat count mode automatically sets the playhead position on the timeline, based of to the total number of beats and the current bpm. For example, if being in Metronome mode, then switching to Chase beat count the playhead will automatically jump to a bar.

This feature is rarely used and will be most likely removed in future releases.

### Min bpm taps

This value decides how many clicks the user need to input before calculating an average bpm.

### Input

The interface for controlling the TapTempo parameters. Currently only keyboard input is supported.



# Timecode Tester

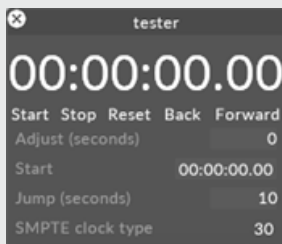

The Timecode Tester is now an available Timecode input option in the Transports Manager. Once the Timecode Tester is assigned as the input source, a widget will appear allowing you to Start, Stop, Pause and Jump the timecode tester. It is simply a way of streaming timecode internally.

# Triggering cues with Timecode

## Marking timecode cue points on a track

1. Open the track and go to the bar you want to assign timecode to. This will generally be the first bar of the audio region corresponding to the song you want to chase. If the track contains a single song, this will usually be the first bar of the track. If the track contains multiple songs, this will be the first bar of the audio section for that song.

The most commonly used system is to assign a different timecode start position to each song. For example, song 1 might be 10:00:00:00 (10 hours, 0 minutes, 0 seconds, 0 frames), song 2 might be 20:00:00:00, and so on. Once you are on the right bar of the right track, you can edit the tag attached to that bar: right-click the bar or hit **Ctrl-T**, and select the **tag** type **TC**. Type into the **tag** text box that pops up.

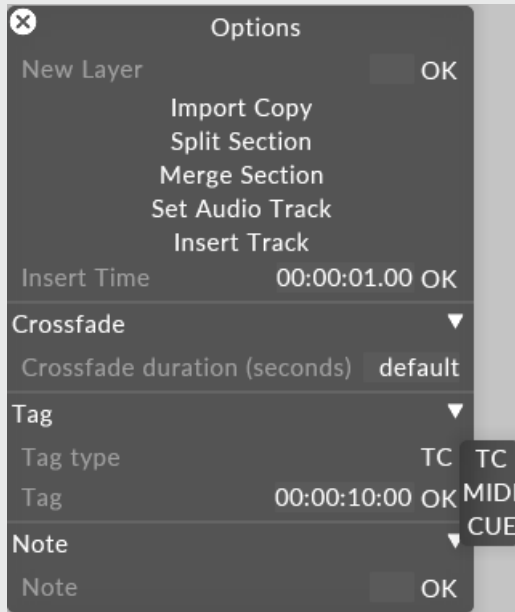

2. In the **tag:** field, enter the timecode for when you want Disguise to play from this bar and sync to timecode. You the following syntax, `hour:minute:second:frame`.

Example `00:00:10:00`.

A new tag will be created below the timeline at the selected bar.

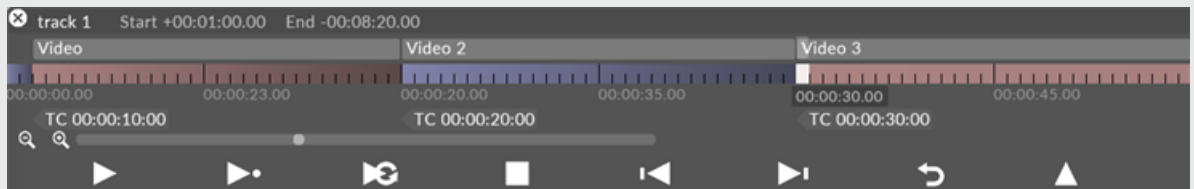

3. Now when the incoming timecode reaches `01:00:10:00`, the track will start playing, locked to timecode, from that bar.

**Please note:** Don't set a timecode note at the first bar of a track, always leave a few bars for pre-roll, otherwise there's a risk will not hit the note on time.

## Per-track delay adjust

If, for any reason, you need to delay various tracks differently, you can do this by right-clicking the track titlebar to open the Track editor, opening up the **timecode chase** tab and editing the **TC adjust** property. This option lets you add a delay to the incoming clock signal just for the selected track. This is useful for adjusting for front-of-house delay in different stage situations. The number, measured in seconds, is added to the time value received; so a negative number will delay the visuals relative to the audio.

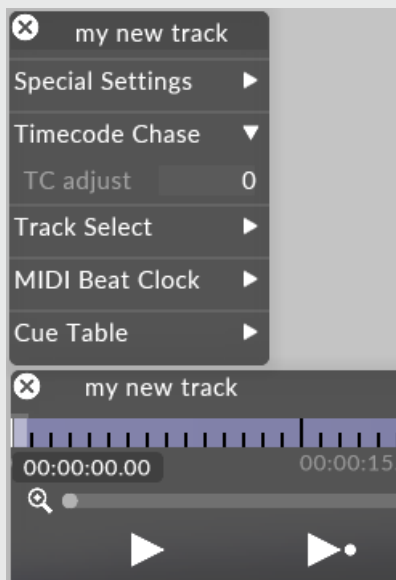

*TC Adjust property of the Track editor controls how to delay a track*

For more information on the Track editor please see the sub-chapter [Editing tracks](#).

# Setting active tracks

If your show has multiple tracks, Disguise can automatically jump to the correct track that matches its incoming timecode. When timecode is received, Disguise will search through all tracks in the currently selected box in the Track manager. If there is more than one matching track for an incoming timecode, Disguise will select the first one in the list.

To ensure that only the tracks you want to use are searched through, create a **set-list**. For step-by-step instructions on how to create a set-list scroll down to the section 'Creating a set-list in the [Creating/managing tracks](#) sub-chapter.

# Troubleshooting LTC

No audio is coming in through the RME 9362 soundcard (only applicable on a 4u 2.5 server)

1. Check that the levels on the HDSP mixer are at 0db.
2. Open the start menu and type **hdspmix**. Open **hdspmix.exe**.

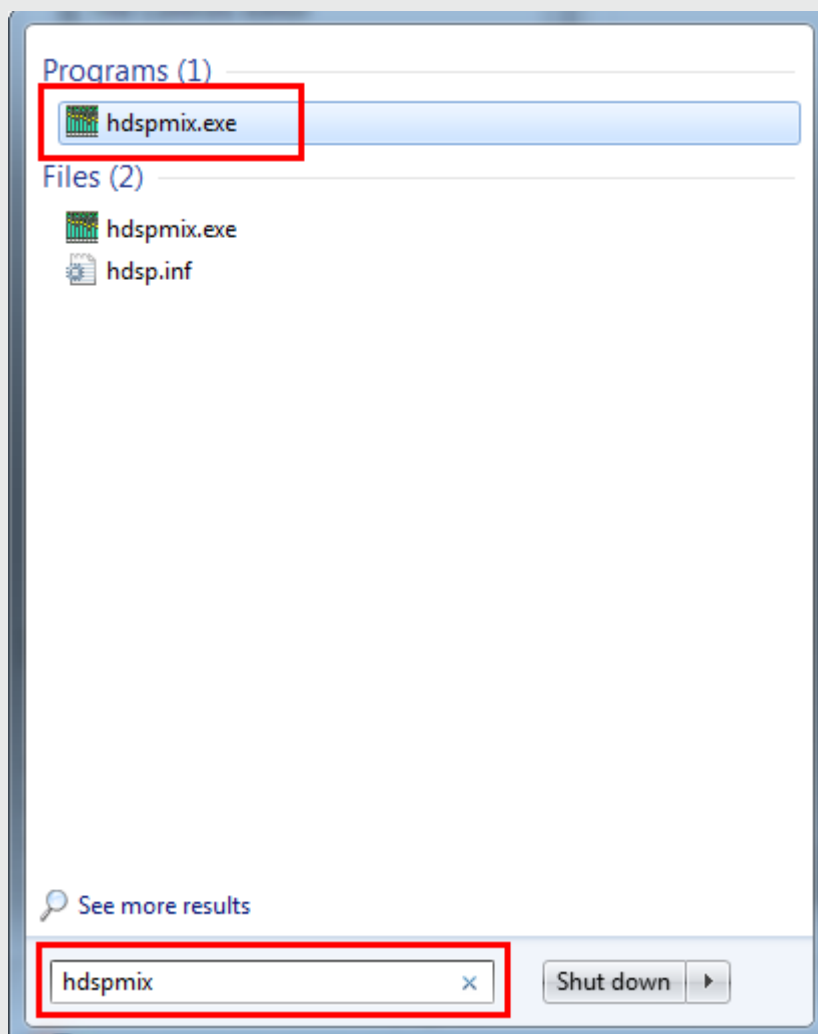

3. In the HDSP mixer, check that In 1 and In 2 levels are at 0db.

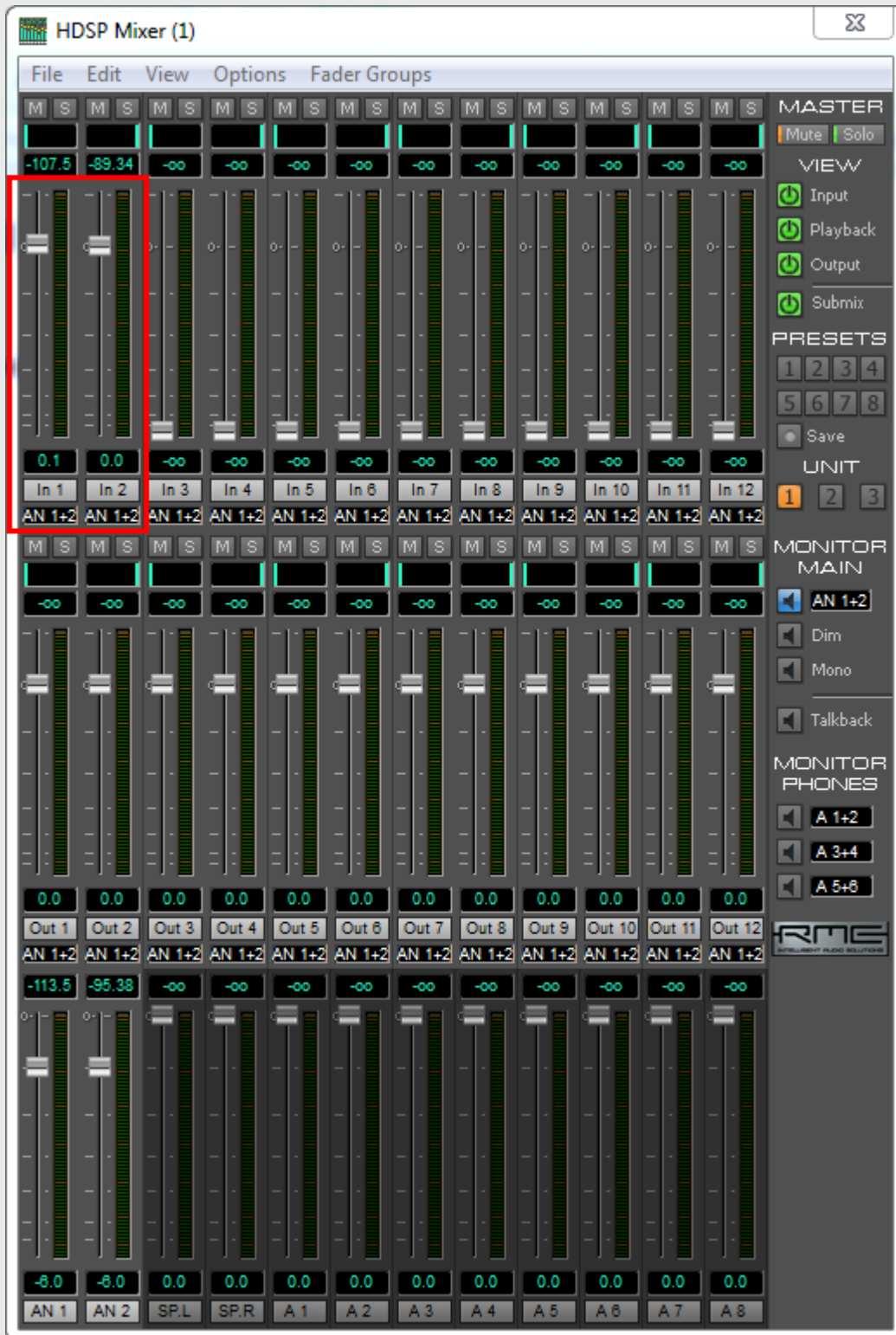

# Transport manager

External synchronisation is managed by the Transport manager.

Transport Managers in disguise allow for the control of playback to be sent via external commands to keep all cues across devices in sync. Transports can be controlled by timecode, Midi Show Control, Midi Note, DMX and OSC devices. Transports can contain multiple tracks, as defined by their assigned [Set List](#).

The control of multiple Transport Managers can be done through a [MultiTransport controller](#).

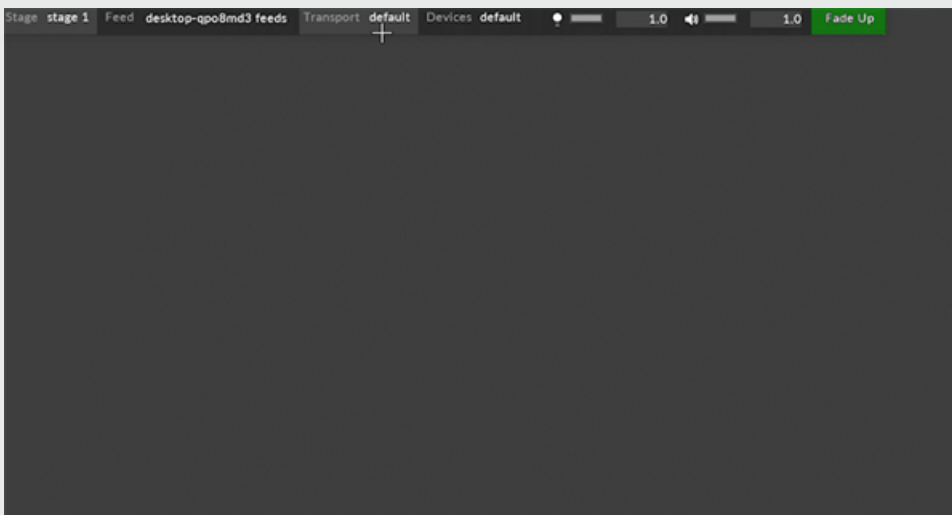

## Opening the Transport manager

To open the Transport manager:



Right-click **transport** in the dashboard.



Right-click Transport to open the Transport Manager

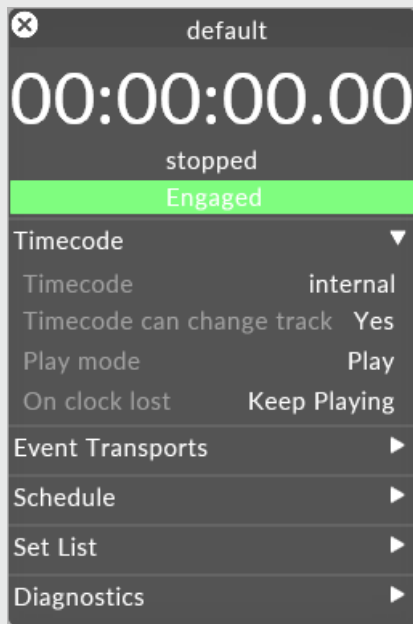

The transport manager manages external synchronisation

The transport manager gives you a large-format readout of the current clock time received when a transport device is connected to Disguise, and information about whether external synchronisation is **engaged** or **disengaged**.

**Please note:** while working with external synchronisation, it can be useful to make the Transport editor sticky by `Ctrl+ left-clicking` the close button of the editor. From this point on, the Controls editor will remain open so you can always see its state. For more

information, scroll down to the section 'Making menu windows sticky' in the [object editor overview](#) sub-chapter.

## Transport Editor properties

### Timecode readout

This shows the current value of the incoming clock signal, if any. This is a raw clock value, i.e. no adjustment has been applied to it. If you are chasing LTC or MIDI timecode, the display shows the standard hours:minutes:seconds:frames.

### Chase status

Below the timecode readout is a status message. This is usually blank, but gives you useful status information about the current chase scenario.

### Engaged/disengaged

The Engaged/Disengaged button allows you to turn synchronisation on or off. When set to **disengaged**, all external control signals are ignored. This is particularly useful when you are in a rehearsal situation and want to edit while the rehearsals are taking place.

- To engage, left-click the button; it will then begin flashing green and say **engaged**. The state of the Engaged/Disengaged button is persistent. This means that if you restart the software, it will be in the same state you left it in.

### Timecode

The **transport** property contains a **TimecodeTransport** object, used for syncing to LTC or MTC. See [Setting up LTC in Disguise](#), [Setting up MTC in Disguise](#).

**Please note:** There can only be one timecode transport active at a time.

## Timecode can change track

When timecode is received, Disguise searches through timecode tags on the timeline to determine where to jump to. If this option is set to 'yes', Disguise will search across all tracks in the currently selected track box, and jump to the first matching track it finds. If this option is set to 'no', Disguise will only search within the currently selected track.

## Play mode

This specifies what play mode Disguise should select when chasing timecode - play normal (ignore section breaks), play-to-end-of-section, or loop. If the play head hits the end of the section in play-to-end-mode while chasing timecode, the playhead will hold at the end of the section and go into 'ignore timecode' mode; it will stay in this mode until timecode either restarts or jumps elsewhere.

## On clock lost

In a rehearsal situation, timecode stop usually means a pause in rehearsal; in this scenario, it's more convenient for Disguise to stop playback when timecode is interrupted or stops. In a show situation, on the other hand, timecode loss is usually an accident (someone tripped over a cable, or a device failed) and it's better to keep playing ("the show must go on"). This switch selects which behaviour to use.

## Local & Remote Transports

Event transports allow Disguise to be controlled externally by Art-net, OSC, MSC and MIDI notes. Please see Controlling the timeline with [Artnet Control](#), [MIDI Show Control](#), [MIDI Note Control](#), [OSC Control](#).

- Remote Transports affect the d3Net network at all times that the Transport Manager is engaged. This is generally items like a controlling Lighting Desk or a master show control system (e.g.

Alcorn McBride).

— Local Transport are for local control surfaces on Editors. They only affect the d3Net timeline when the Editor is **Locked to the Master**

## Schedule

A schedule allows Disguise to run automatically according to a schedule. Please see [Scheduling](#).

## Set List

User defined lists used to reorder tracks for playback. Please see [Set List](#).

## Trace Level

When set to on, Disguise will print out all transport events to the console ( accessible with **ALT-C** ).

# MultiTransport

## What is a MultiTransport?

Multitransports allow for the control of multiple tracks within a project simultaneously, instead of sequentially.

A Multitransport is comprised of multiple Transport Managers. More information on Transport controls can be found [here](#) .

Common uses of MultiTransports include dividing shows by main content tracks and live content elements, or in a multi-programmer scenario, where one programmer sequences control commands in one track, and the other sequences content in a new track. Then, at show time, both tracks can be controlled independently from each other, but still interact.

In the Workflow and Example tabs on this page, example uses of MultiTransports in broadcast, theater, and touring situations are outlined, but there are many creative uses of MultiTransports beyond those outlined here.

## Example Workflows

### **Broadcast**

Below we will compare the same broadcast scenario, with one project set up in a singular track setup, and the other with the use of a MultiTransport.

The project is of a TV Studio that requires the following elements: test patterns, studio graphic overlays, backgrounds, a live video feed, and Picture in Picture video elements for each different news segment (PiPs).

In this first example of a singular track setup, the project has multiple video layers, all stacked up on top of each other to determine hierarchy. The majority of these are backgrounds and studio graphics, all running beneath every other layer in the timeline (Video layers 8-13), with the live feed as its own section in the timeline. It is then up to the operator to navigate to the correct PiP for each news segment.

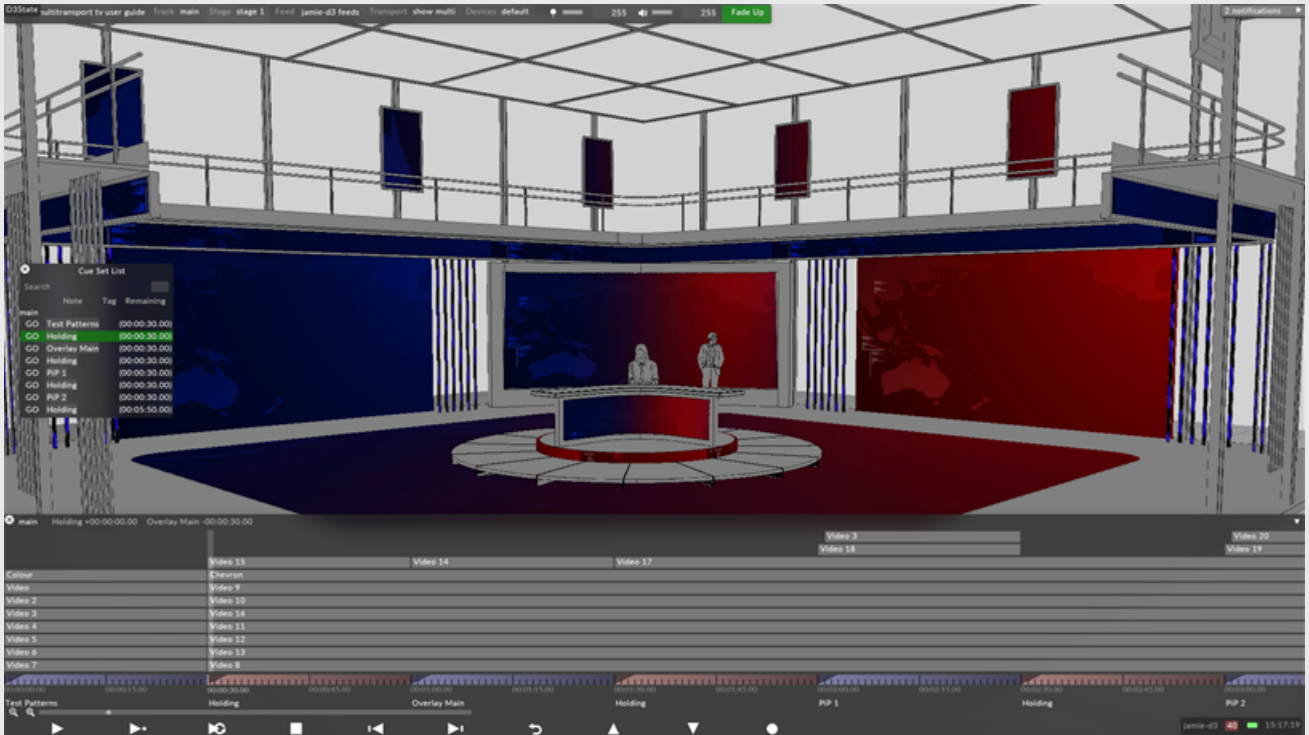

Image 1: Stacked layers

This creates a very rigid and manual timeline structure, in an environment that is needs to have a fluid and dynamic structure (for example, in the event of breaking news.) This is a reason a single Transport and Timeline structure will not be effective for this production.

In this second project, the production utilizes a MultiTransport to organize all their separate elements and allow for more flexible control.

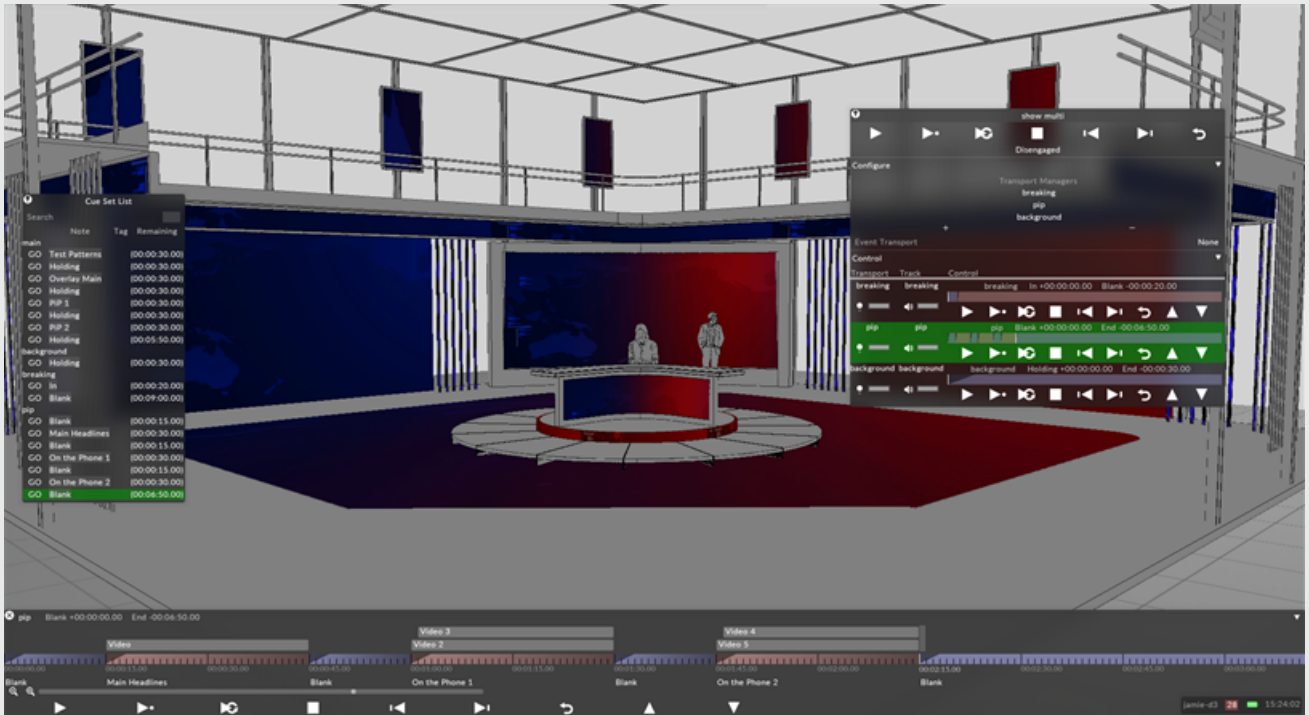

Image 2: MultiTransport

There are three separate tracks in the MultiTransport editor. The first is titled "breaking" and covers the breaking news issue from earlier. This track contains a graphic saying "Breaking News" and a live video feed of the reporter on the scene.

It can be made live at any point during the show by hitting the Play command for that track on the MultiTransport editor, and because it is above all other tracks in the editor, it will show on top of whatever other content is playing back on the assigned screens.

Because there is a universal crossfade option enabled on the track, the feed will always fade in and out at the assigned duration, so the operator does not need to worry about a hard cut when activating the live feed.



Image 3: Breaking News

The second track is titled PiP and contains sequentially cued news segments. Because each PiP is contained in its own section, they can be played back one by one by the operator until the anchor has completed discussion for each segment. Because the PiP track is beneath the breaking track, the breaking news live video feed will always take precedence over the PiP when it is activated.

The third and final track is titled background, because that is all it contains. It is the lowest track, so all elements will appear on top of it. Because there is only one section, the operator can continually loop this background video for however long the broadcast is and does not have to worry about accidentally overriding it by cueing up a new piece of content in another track.

Finally, note that the cue list pinned to the left hand side of the GUI reflects all cues in all three of the tracks. This allows for great flexibility of the operator to control all separate graphic and video elements from one UI element. More information on the cue list can be found [here](#).

## Theatre

This example project is a theatrical show where the MultiTransport divides the Control Layers for the projector shutters from the content sequencing.



This can be useful in a tech rehearsal situation for any holds where the projectors need to be quickly shuttered and the commands have not been built into every cue, or a show where the timing of the projector control changes every night.

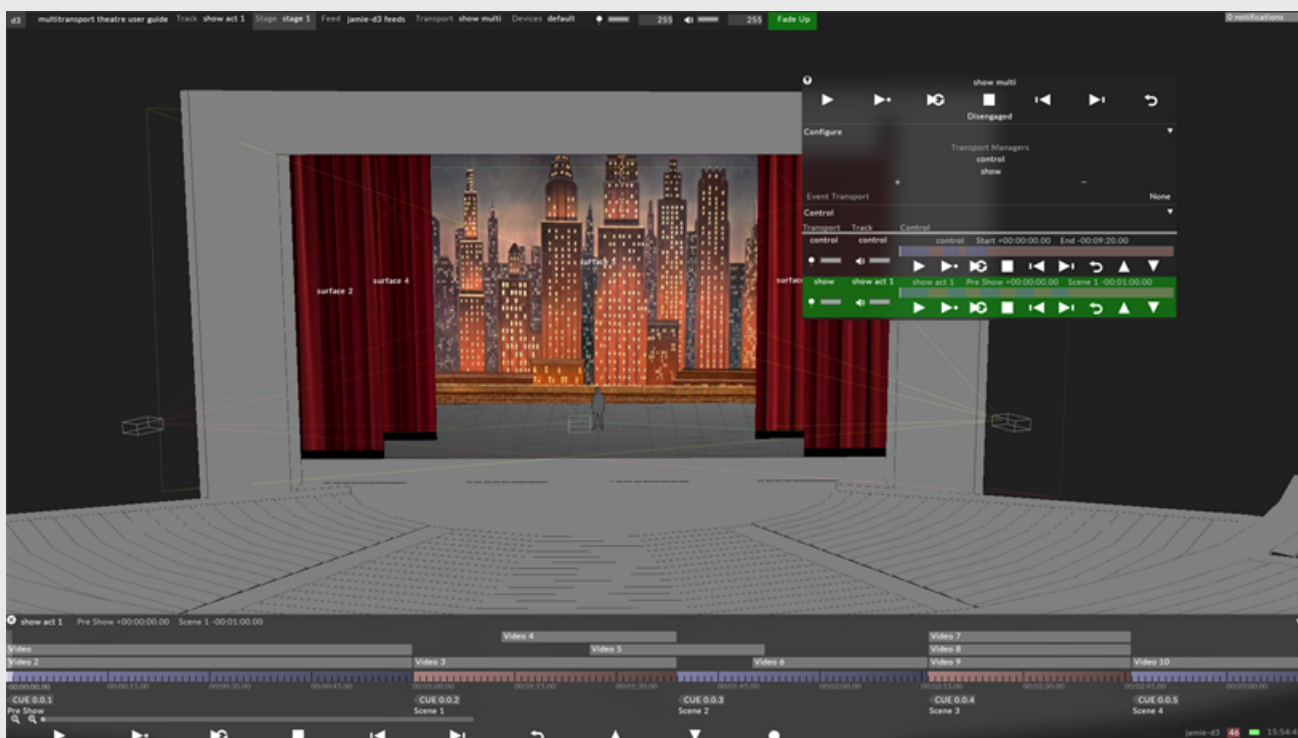

Image 4: Theatre

### Concert Touring

In this example project file, the live video feed IMAG is one track, and all the song's video content is in the track called song 1 beneath it. This will allow the operator control of the IMAG live feed without having to cue it into every song's track, and is especially helpful when IMAG cues are being called by a camera director or stage manager. This is a similar concept to the broadcast studio, as it allows greater flexibility for a live show environment for unexpected cues.

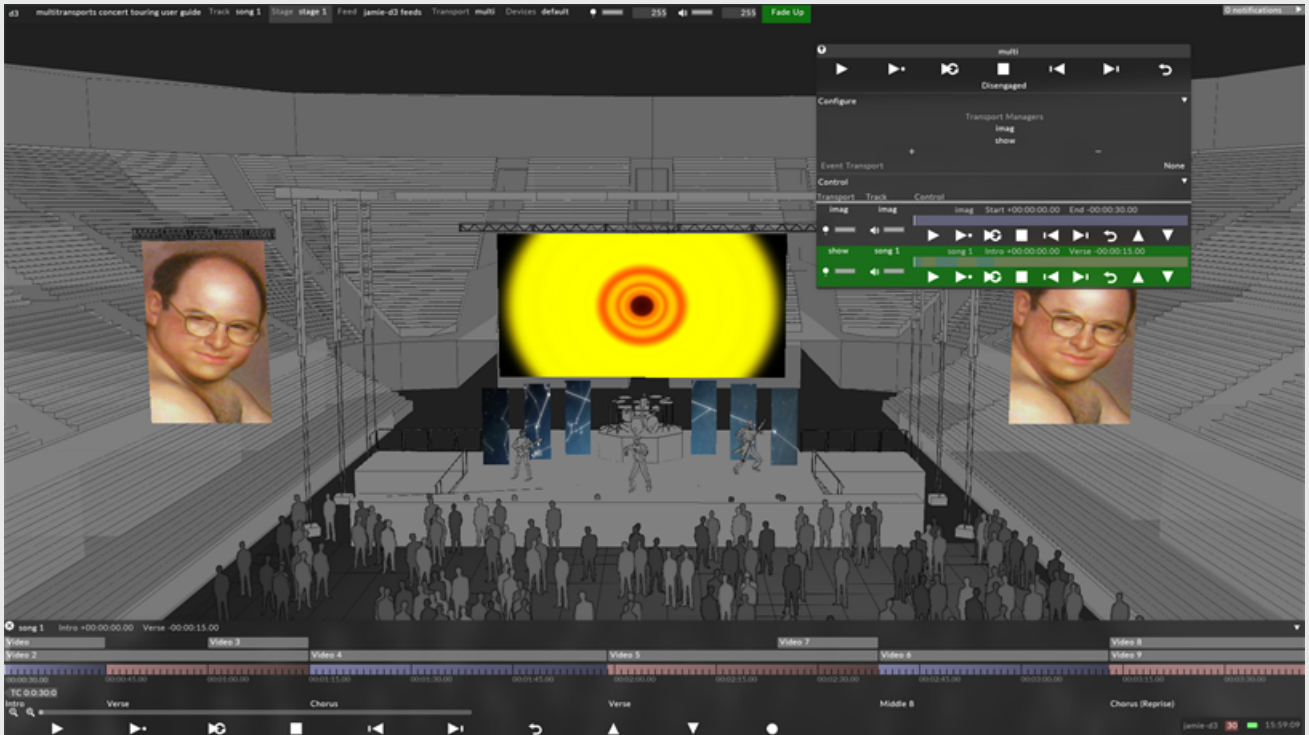

Image 5: Concert Touring

Breaking up every song into individual tracks also allows for the flexibility to create different multitransports based on individual set lists. For a concert touring example, a common practice is creating a set list for each new stop on the tour, where the song list and order is different in each stop. More information on creating set lists can be found [here](#).

## Workflow

### Creating a Multitransport Manager

1. Create a TransportManager. For more information on TransportManager properties, see <http://help.disguise.one/Content/Configuring/Transports/Transport-manager.html>

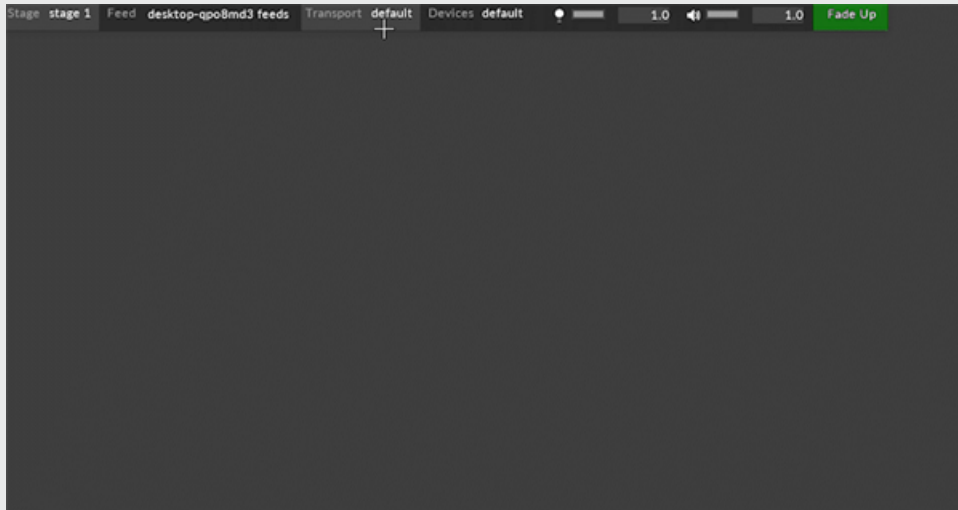

2. Create a Set List by left clicking on the tracks editor in the top toolbar, and click on the Active Set List option.

You can either create different set lists, or use the automatic one populated, containing all tracks created in the project.

For this example, we will be making three set lists: one for all songs video content (which would contain all individual song tracks), one for the IMAG live video feed track, and one for projector control commands track.

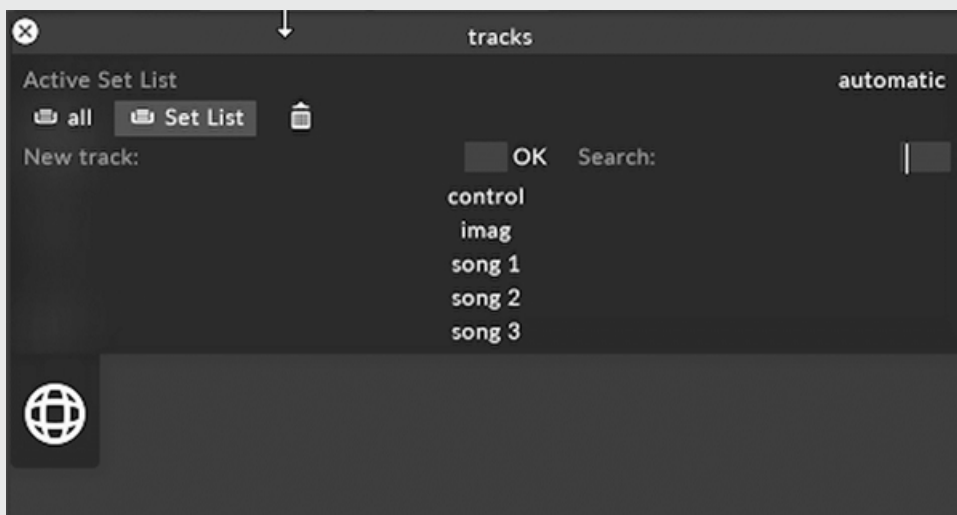

3. Left click to open the Transport Manager and assign the set list containing the tracks you wish to control.
4. Repeat Step 3 for all other set lists you wish to have active in the MultiTransport. For this example, we will create three separate Transport Managers for each of our set lists: titled song content, IMAG, and control.

5. Create a new transport from the Transport editor like in Step 1, but choose MultiTransportManager as the type.
6. Under the Configure tab, click the + icon and the names of the Transport Managers you wish to control. This will then create a menu with the tracks editor for the active track in each set list. For our example, we will add all three Transports we created earlier.
7. To reorder these Transport Managers, left click on one of the names in the Configure tab, and drag it above or below the others. This editor will still respect the top/bottom hierarchy of disguise, similar to layers in the Timeline, so the topmost tracks will always appear on top of those beneath it.
8. If you will be controlling this MultiTransport externally, for example through Midi or OSC, assign the proper transport under the Control tab.
9. Left click Disengaged at the top of the MultiTransport editor to engage. Select a playback option in the top Global Transport Control.

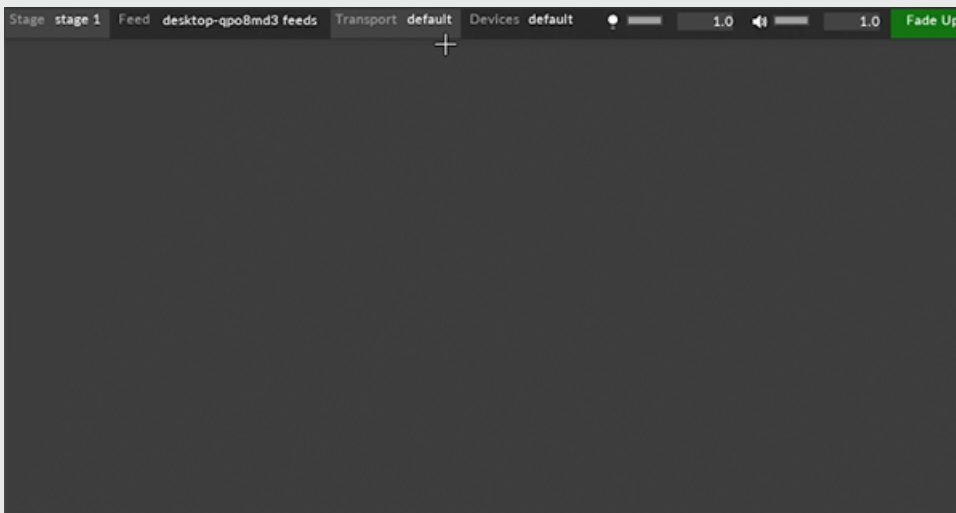

10. Click on the individual playback controls for each individual track to control them separately. Use the Global playback controls at the top of the Multitransport editor to control all tracks at once.

### Properties

- Global Transport - Controls of all Transports in the list
- Global Engage/ Disengage
- Transport Managers List - These are where individual Transport Managers are added to then be controlled by a MultiTransportManager
- Event Transport - Gives the ability to control the MultiTransportManager through Telnet (JSON Strings).
- Control - Contains the list of TransportManagers to then configure and control.

# Telnet commands

Disguise provides a way to gather key information on the status of a Disguise session whilst also providing some basic timeline control.

All commands are formatted in JSON and sent over the telnet protocol.

## Setup

1. Create a new Multitransport Manager
2. Assign transport(s) to Multitransport Manager
3. Assign tracks to transports or use the automatic setlist
4. In the Multitransport Manager add an event transport and set its listening port

## Queries

Queries is the method used to extract information out of Disguise. They are formatted in JSON using the following structure.

```
{"request":<request_number>,"query":{"q":"<Query>"} }\n
```

**Please note:** The '\n' denotes a newline character, programs such as PuTTY and NetCat automatically add the newline character when you send the string.

All Queries return data as JSON. It de-serialises into a dictionary that has three entries.

- **Request number:** Same number that has been given to Disguise in the initial request, can be used to synchronize requests / replies in a multithreaded environment. If no number has been supplied it defaults to 0. If an error has occurred the number is -1.
- **Status** - Defaults to "OK" but will provide context for an error if it occurs.

- **Results** - A list of dictionaries that contains the requested information. This is always a list, even if one element is returned back.

## Available Queries

**Machine list:** {"query":{"q":"machineList"}}

Returns a list of dictionaries containing information about the machine: d3 name, hostname role and machine type.

Example return : {"request":0,"status":"OK","results":

```
[{"machine":"4x4-demo","hostname":"4X4-DEMO","role":"Pure master","type":"4x4pro"}]}
```

**Machine status:** {"query":{"q":"machineStatus"}}

Returns extra information about a machine: session status, failover status and current FPS.

Example return: {"request":0,"status":"OK","results":[{"active":true,

```
"Failed":false, "fps":32.345558166503909}]}
```

**Player list:** {"query":{"q":"playerList"}}

Returns a list of all transports that have been assigned to the multi-event transport

**Example return:** {"request":0,"status":"OK","results":[{"player":"transport 1"}, {"player":"transport2"}, {"player":"transport 3"}, {"player":"transport 4"}]}

**Track list:** {"query":{"q":"trackList"}}

Returns a list of all the tracks that have been assigned to players

**Example return:** {"request":0,"status":"OK","results":[{"track":"track 4", "length":560.0}, {"track":"track 3", "length":560.0}, {"track":"track 2", "length":560.0}, {"track":"track", "length":560.0}]}

**Cue list:** {"query":{"q":"cueList <Track name>"}}

Returns a list of all the Sections breaks in a given track

**Example Return:** {"request":0,"status":"OK","results":[{"location":"","startTime":0.0,"length":15.0}, {"location":"a","startTime":15.0,"length":15.0}, {"location":"b","startTime":30.0,"length":15.0}, {"location":"c","startTime":45.0,"length":515.0}]}

## Commands

You can control the timeline using the following command format

```
{"track_command":{"command":"<Playmode>","track":"<Track>","location":"<location>","player":"<player name>","transition":"<transition time>"}}
```

### <Playmode>

- play - normal play mode, will ignore section breaks on the timeline
- playSection - play section mode - will hold at section breaks
- Loop - loop section mode - Will loop around section breaks
- Stop - stops the playhead

### <Track>

Any track that is in the setlist for the player that you select

### <Location>

Any valid timecode - "00:00:15:00"

Any valid Cues that are present on the timeline - "CUE 35"

<player name>

Any transport that is present inside the multi transport manager

<transition time>

Seconds - crossfades from current playhead position to the new requested position - e.g. "10"

<transition track> & <transition section>

Introduced in r17.1 you can assign actions to crossfades using track snippets. You can achieve something similar using the transitionTrack & transitionSection entries.

This is an example command

```
{ "track_command": { "player": "toptransport", "command": "playSection",  
"track": "toptrack", "location": "00:00:00:00", "transitionTrack":  
"transitions", "transitionSection": "woosh" }}
```

transitionTrack is the (string) name of a track, and must be paired with transitionSection which is the (string) note set at the section break.



# Cue List

The Cue List shows a list of all sections & tags on the tracks within the currently active set list, allows users to trigger specific tags with a 'go' button, view where they are in the Set List, create new Set Lists and trigger the show from one single interface.

## Opening the Cue List

The Cue List can be opened in two ways.

### Option 1

- Right click Transport in the dashboard
- Expand the Set List tab

Left click the **Open Cue List** button

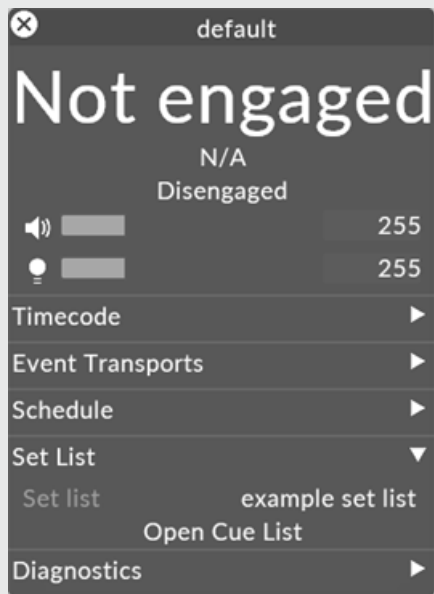

## Option 2

Use the keyboard shortcut - CTRL G to open the Cue List.

## Using the Cue List

### Auto scroll

The Cue List will scroll as the user plays through the timeline to allow the user to track where in the Cue List they are, without needing to manually scroll.

### Track jump

Left clicking on a track name in Cue List will take you to the beginning of that track in timeline.

## Active selection

The active Section will be highlighted in green, and the most recent cue will be highlighted in a lighter green.

## Row selection

- The row selection follows much the same behaviour as list editor. Users can select a track for playback by hovering over cue row and selecting it with a click, users can then click the GO button to trigger that cue, or the note or tag columns to edit.
- Users cannot select more than one row
- Once a track is selected users can select other tracks by pressing up and down.
- User can press CTRL + UP to jump to top of list.
- User can press CTRL + DOWN to jump to bottom of list.

## Adjustable size

Users can adjust the width as well as height of widget by hovering over the edge, then left clicking and dragging when the arrow icon is visible. The note column will truncate text (in the middle of the text) if there are large strings in the note column.

## Removing tracks from the Cue List

If the Set List is set to Automatic, then all tracks in the project will display in the Cue List. However this is inefficient and can cause performance issues with large projects, therefore we recommend the use of [Set Lists](#).

Removing a track from the Cue List can be done by specifying a Set List that does not contain that particular track.

# Set List configuration

A show often uses many tracks. To make this easier to manage the tracks can be organised into **Set List**. A Set List can be created from either the Cue List or the transport manager.

It is important to use the Set List functionality to effectively manage what data the Cue List is showing.

1. Open the Cue List either through the Transport Manager, or by pressing CTRL G.
2. Left click the **Set List** tab.
3. Right click the Set List, the Set List manager opens.

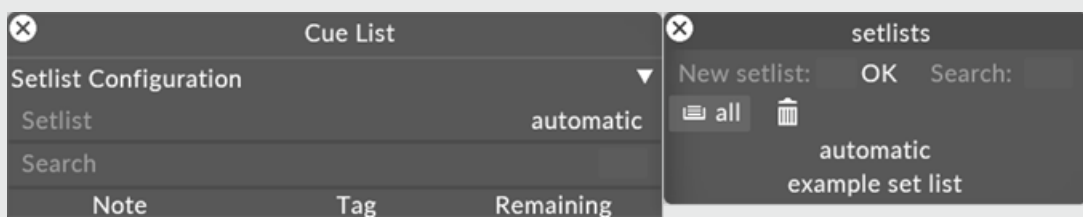

4. Create a new Set List in the manager or select an already created Set List.
5. Add the desired tracks to the Set List.

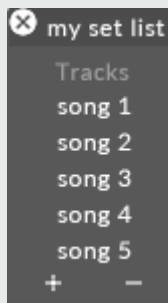

## Editing items within the Cue List

- Double click the note field to edit or add a note to the track.
- Double click the tag field to edit the tag after it has been added to the timeline. Once a tag has been added using the traditional tag workflow specified in the [tags topic](#), users can edit that tag in the Cue List. Double clicking the tag column when before a tag is added will do nothing.

## Searching the Cue List

As well as the standard text search (looking for matches in track name, notes and tags), you can filter your search by type, with the following syntax:

**track: name** will return only tracks that match the search text.

**note: name** will return only notes that match the search text.

**tag: name** will return only tags that match the search text.

**cue: name** will return notes and tags that match the search text.

# Set Lists

Set lists are a way of managing the order the tracks are played back in Disguise software and are especially useful for managing which tracks the Cue List displays.

## Creating a Set List

A show often uses many tracks. To make this easier to manage the tracks can be organised into **Set List**. A Set List can be created from either the Cue List or the transport manager.

It is important to use the Set List functionality to effectively manage what data the Cue List is showing.

1. Open the Cue List either through the Transport Manager, or by pressing CTRL G.
2. Left click the **Set List** tab.
3. Right click the Set List, the Set List manager opens.

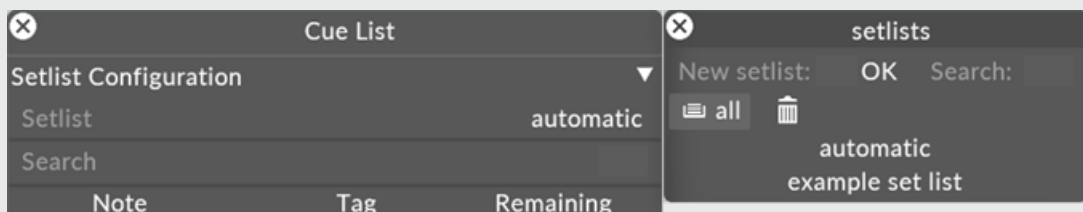

4. Create a new Set List in the manager or select an already created Set List.

5. Add the desired tracks to the Set List.

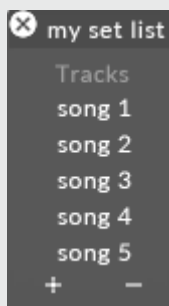

## Switching from one Set List to another

Select the Set List you want to use from the Transport Manager or the Cue List. The currently active track in the Timeline will not change immediately. To change the active track, left click on the track within the Cue List or select it from the track manager.

# MultiTransport

## What is a MultiTransport?

Multitransports allow for the control of multiple tracks within a project simultaneously, instead of sequentially.

A Multitransport is comprised of multiple Transport Managers. More information on Transport controls can be found [here](#) .

Common uses of MultiTransports include dividing shows by main content tracks and live content elements, or in a multi-programmer scenario, where one programmer sequences control commands in one track, and the other sequences content in a new track. Then, at show time, both tracks can be controlled independently from each other, but still interact.

In the Workflow and Example tabs on this page, example uses of MultiTransports in broadcast, theater, and touring situations are outlined, but there are many creative uses of MultiTransports beyond those outlined here.

## Example Workflows

### **Broadcast**

Below we will compare the same broadcast scenario, with one project set up in a singular track setup, and the other with the use of a MultiTransport.

The project is of a TV Studio that requires the following elements: test patterns, studio graphic overlays, backgrounds, a live video feed, and Picture in Picture video elements for each different news segment (PiPs).

In this first example of a singular track setup, the project has multiple video layers, all stacked up on top of each other to determine hierarchy. The majority of these are backgrounds and studio graphics, all running beneath every other layer in the timeline (Video layers 8-13), with the live feed as its own section in the timeline. It is then up to the operator to navigate to the correct PiP for each news segment.



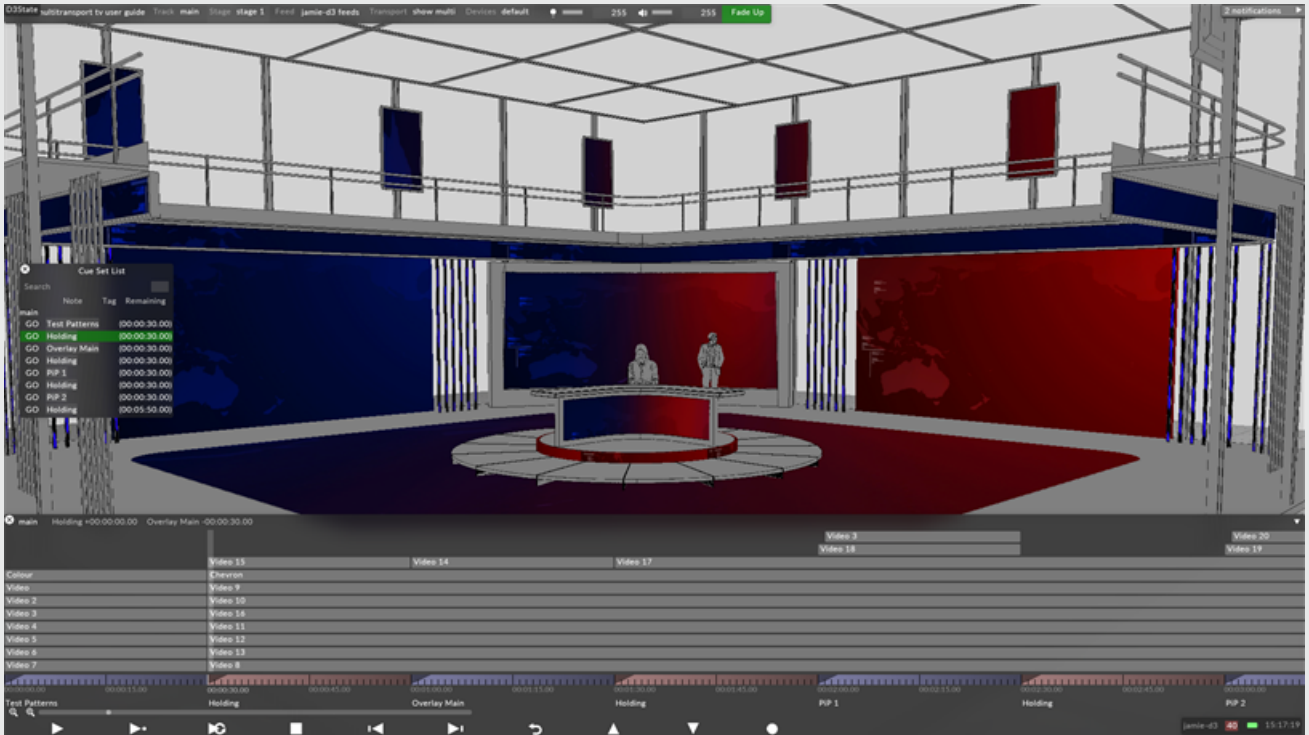

Image 1: Stacked layers

This creates a very rigid and manual timeline structure, in an environment that is needs to have a fluid and dynamic structure (for example, in the event of breaking news.) This is a reason a single Transport and Timeline structure will not be effective for this production.

In this second project, the production utilizes a MultiTransport to organize all their separate elements and allow for more flexible control.

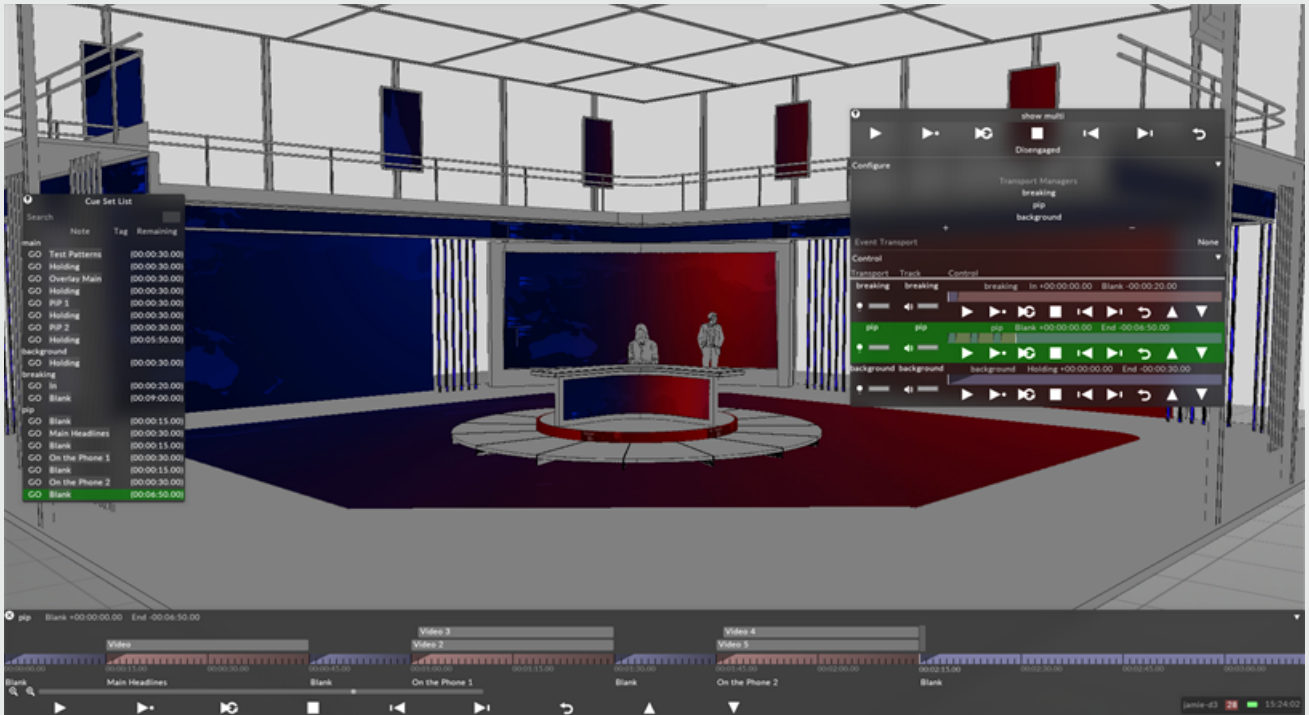

Image 2: MultiTransport

There are three separate tracks in the MultiTransport editor. The first is titled 'breaking' and covers the breaking news issue from earlier. This track contains a graphic saying "Breaking News" and a live video feed of the reporter on the scene.

It can be made live at any point during the show by hitting the Play command for that track on the MultiTransport editor, and because it is above all other tracks in the editor, it will show on top of whatever other content is playing back on the assigned screens.

Because there is a universal crossfade option enabled on the track, the feed will always fade in and out at the assigned duration, so the operator does not need to worry about a hard cut when activating the live feed.



Image 3: Breaking News

The second track is titled PiP and contains sequentially cued news segments. Because each PiP is contained in its own section, they can be played back one by one by the operator until the anchor has completed discussion for each segment. Because the PiP track is beneath the breaking track, the breaking news live video feed will always take precedence over the PiP when it is activated.

The third and final track is titled background, because that is all it contains. It is the lowest track, so all elements will appear on top of it. Because there is only one section, the operator can continually loop this background video for however long the broadcast is and does not have to worry about accidentally overriding it by cueing up a new piece of content in another track.

Finally, note that the cue list pinned to the left hand side of the GUI reflects all cues in all three of the tracks. This allows for great flexibility of the operator to control all separate graphic and video elements from one UI element. More information on the cue list can be found [here](#).

## Theatre

This example project is a theatrical show where the MultiTransport divides the Control Layers for the projector shutters from the content sequencing.

This can be useful in a tech rehearsal situation for any holds where the projectors need to be quickly shuttered and the commands have not been built into every cue, or a show where the timing of the projector control changes every night.



Image 4: Theatre

## Concert Touring

In this example project file, the live video feed IMAG is one track, and all the song's video content is in the track called song 1 beneath it. This will allow the operator control of the IMAG live feed without having to cue it into every song's track, and is especially helpful when IMAG cues are being called by a camera director or stage manager. This is a similar concept to the broadcast studio, as it allows greater flexibility for a live show environment for unexpected cues.

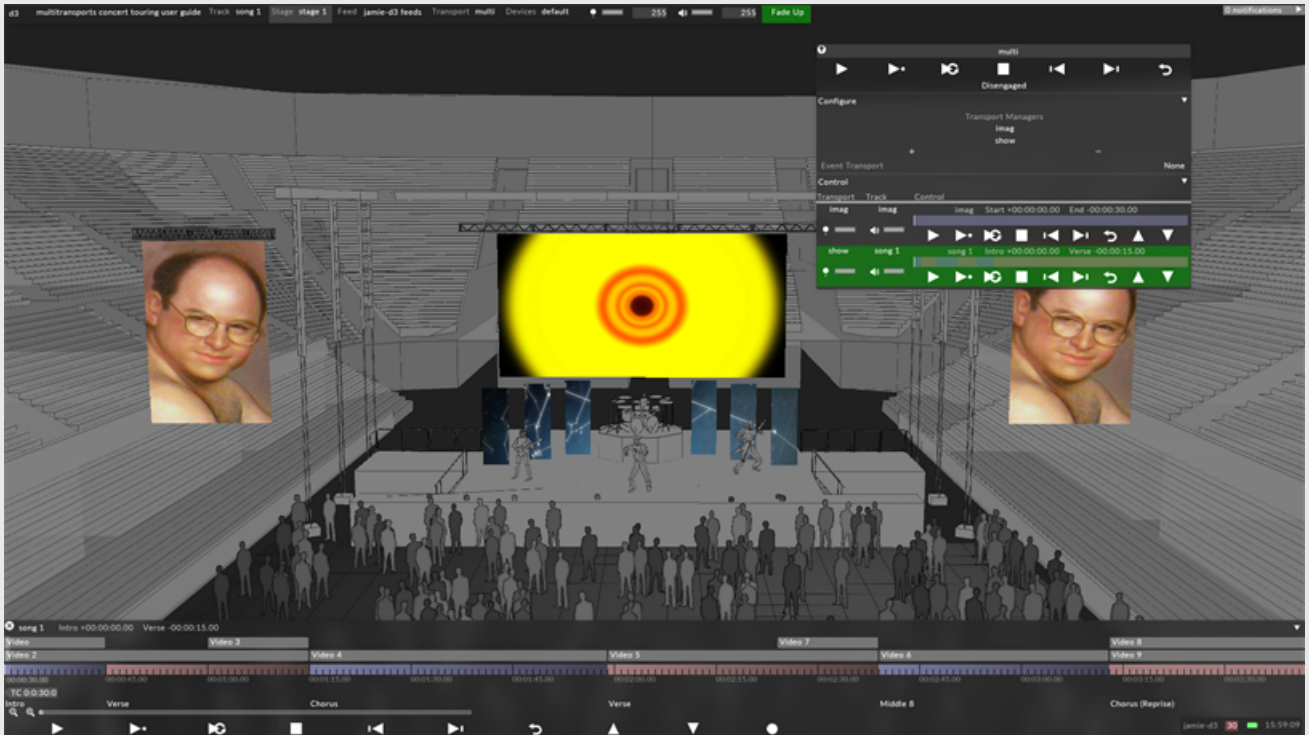

Image 5: Concert Touring

Breaking up every song into individual tracks also allows for the flexibility to create different multitransports based on individual set lists. For a concert touring example, a common practice is creating a set list for each new stop on the tour, where the song list and order is different in each stop. More information on creating set lists can be found [here](#).

## Workflow

### Creating a Multitransport Manager

1. Create a TransportManager. For more information on TransportManager properties, see <http://help.disguise.one/Content/Configuring/Transports/Transport-manager.html>

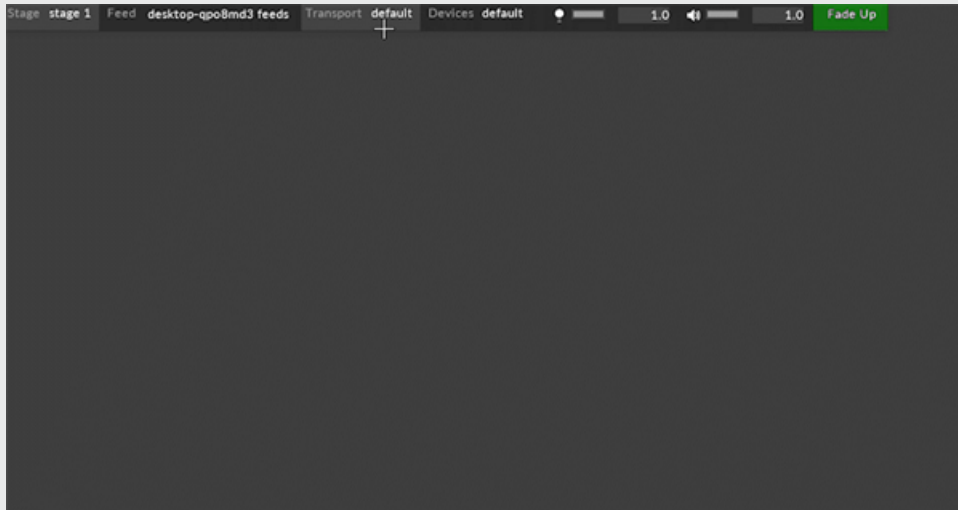

2. Create a Set List by left clicking on the tracks editor in the top toolbar, and click on the Active Set List option.

You can either create different set lists, or use the automatic one populated, containing all tracks created in the project.

For this example, we will be making three set lists: one for all songs video content (which would contain all individual song tracks), one for the IMAG live video feed track, and one for projector control commands track.

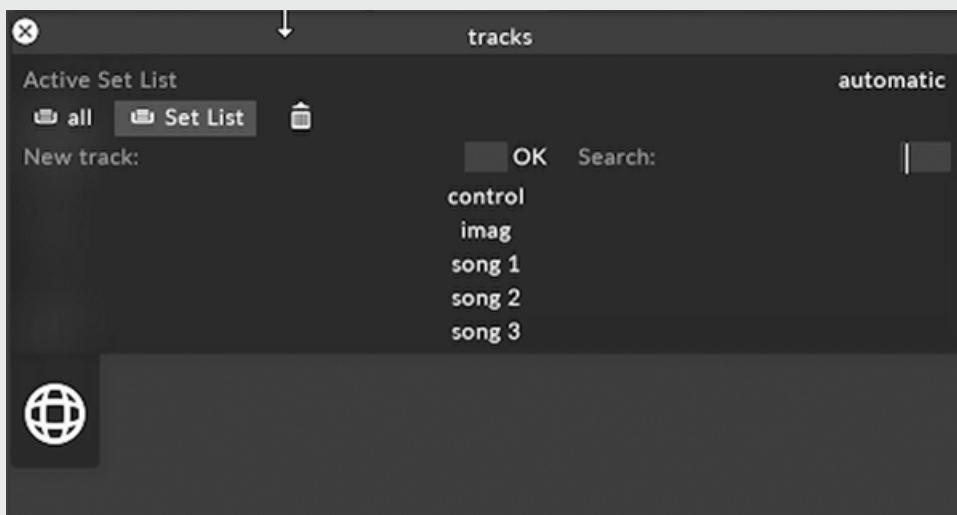

3. Left click to open the Transport Manager and assign the set list containing the tracks you wish to control.
4. Repeat Step 3 for all other set lists you wish to have active in the MultiTransport. For this example, we will create three separate Transport Managers for each of our set lists: titled song content, IMAG, and control.



5. Create a new transport from the Transport editor like in Step 1, but choose MultiTransportManager as the type.
6. Under the Configure tab, click the + icon and the names of the Transport Managers you wish to control. This will then create a menu with the tracks editor for the active track in each set list. For our example, we will add all three Transports we created earlier.
7. To reorder these Transport Managers, left click on one of the names in the Configure tab, and drag it above or below the others. This editor will still respect the top/bottom hierarchy of disguise, similar to layers in the Timeline, so the topmost tracks will always appear on top of those beneath it.
8. If you will be controlling this MultiTransport externally, for example through Midi or OSC, assign the proper transport under the Control tab.
9. Left click Disengaged at the top of the MultiTransport editor to engage. Select a playback option in the top Global Transport Control.

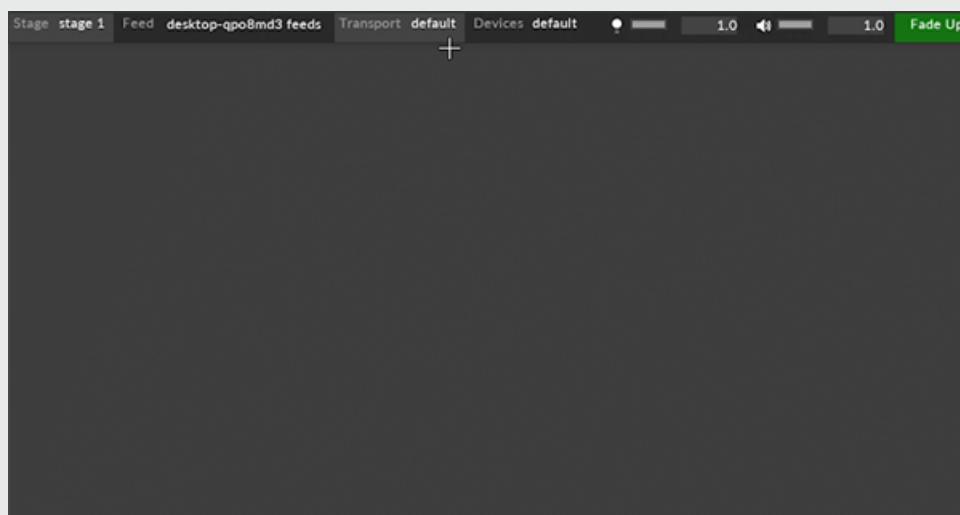

10. Click on the individual playback controls for each individual track to control them separately. Use the Global playback controls at the top of the Multitransport editor to control all tracks at once.

### Properties

- Global Transport - Controls of all Transports in the list
- Global Engage/ Disengage
- Transport Managers List - These are where individual Transport Managers are added to then be controlled by a MultiTransportManager
- Event Transport - Gives the ability to control the MultiTransportManager through Telnet (JSON Strings).
- Control - Contains the list of TransportManagers to then configure and control.

## Telnet commands

Disguise provides a way to gather key information on the status of a Disguise session whilst also providing some basic timeline control.

All commands are formatted in JSON and sent over the telnet protocol.

## Setup

1. Create a new Multitransport Manager
2. Assign transport(s) to Multitransport Manager
3. Assign tracks to transports or use the automatic setlist
4. In the Multitransport Manager add an event transport and set its listening port

## Queries

Queries is the method used to extract information out of Disguise. They are formatted in JSON using the following structure.

```
{"request":<request_number>,"query":{"q":"<Query>"} }\n
```

**Please note:** The '\n' denotes a newline character, programs such as PuTTY and NetCat automatically add the newline character when you send the string.

All Queries return data as JSON. It de-serialises into a dictionary that has three entries.

- **Request number:** Same number that has been given to Disguise in the initial request, can be used to synchronize requests / replies in a multithreaded environment. If no number has been supplied it defaults to 0. If an error has occurred the number is -1.
- **Status** - Defaults to "OK" but will provide context for an error if it occurs.



- **Results** - A list of dictionaries that contains the requested information. This is always a list, even if one element is returned back.

## Available Queries

**Machine list:** {"query":{"q":"machineList"}}

Returns a list of dictionaries containing information about the machine: d3 name, hostname role and machine type.

Example return : {"request":0,"status":"OK","results":

```
[{"machine":"4x4-demo","hostname":"4X4-DEMO","role":"Pure master","type":"4x4pro"}]}
```

**Machine status:** {"query":{"q":"machineStatus"}}

Returns extra information about a machine: session status, failover status and current FPS.

Example return: {"request":0,"status":"OK","results":[{"active":true,

```
"Failed":false, "fps":32.345558166503909}]}
```

**Player list:** {"query":{"q":"playerList"}}

Returns a list of all transports that have been assigned to the multi-event transport

**Example return:** {"request":0,"status":"OK","results":[{"player":"transport 1"}, {"player":"transport2"}, {"player":"transport 3"}, {"player":"transport 4"}]}

**Track list:** {"query":{"q":"trackList"}}

Returns a list of all the tracks that have been assigned to players

**Example return:** {"request":0,"status":"OK","results":[{"track":"track 4", "length":560.0}, {"track":"track 3", "length":560.0}, {"track":"track 2", "length":560.0}, {"track":"track", "length":560.0}]}

**Cue list:** {"query":{"q":"cueList <Track name>"}}

Returns a list of all the Sections breaks in a given track

**Example Return:** {"request":0,"status":"OK","results":[{"location":"","startTime":0.0,"length":15.0}, {"location":"a","startTime":15.0,"length":15.0}, {"location":"b","startTime":30.0,"length":15.0}, {"location":"c","startTime":45.0,"length":515.0}]}

## Commands

You can control the timeline using the following command format

```
{"track_command":{"command":"<Playmode>","track":"<Track>","location":"<location>","player":"<player name>","transition":"<transition time>"}}
```

### <Playmode>

- play - normal play mode, will ignore section breaks on the timeline
- playSection - play section mode - will hold at section breaks
- Loop - loop section mode - Will loop around section breaks
- Stop - stops the playhead

### <Track>

Any track that is in the setlist for the player that you select

### <Location>

Any valid timecode - "00:00:15:00"

Any valid Cues that are present on the timeline - "CUE 35"

<player name>

Any transport that is present inside the multi transport manager

<transition time>

Seconds - crossfades from current playhead position to the new requested position - e.g. "10"

<transition track> & <transition section>

Introduced in r17.1 you can assign actions to crossfades using track snippets. You can achieve something similar using the transitionTrack & transitionSection entries.

This is an example command

```
{ "track_command": { "player": "toptransport", "command": "playSection",  
"track": "toptrack", "location": "00:00:00:00", "transitionTrack":  
"transitions", "transitionSection": "woosh" }}
```

transitionTrack is the (string) name of a track, and must be paired with transitionSection which is the (string) note set at the section break.

# Hardware ranges overview

## The Disguise Platform

Deliver challenging creative projects with confidence. Our production toolkit and high-performance hardware produce pixel-perfect live imagery on vast, complex surfaces.

The disguise software-on-hardware platform manages any live, projection-mapped, fixed installation or extended reality experience with stunning results.

[Pro range](#)

[gx range](#)

[Plus range](#)

[rx range](#)

# Hardware ranges overview

## The Disguise Platform

Deliver challenging creative projects with confidence. Our production toolkit and high-performance hardware produce pixel-perfect live imagery on vast, complex surfaces.

The disguise software-on-hardware platform manages any live, projection-mapped, fixed installation or extended reality experience with stunning results.

[Pro range](#)

[gx range](#)

[Plus range](#)

[rx range](#)

# Server/ Software Compatibility

## Product Support

The table below provides full compatibility information on disguise hardware and software products.

Product	Version of Designer that introduces hardware support	Version of Designer that was tested against	Can I load the latest version of Designer onto this product?	Recommended OS
4x4pro	r11.3	r18.1	No	<u><a href="#">Current OS as found here</a></u>
4x2pro	r11.3	r18.1	No	<u><a href="#">Current OS as found here</a></u>
2x4pro*	r14.2	<u><a href="#">Latest version of Designer found here</a></u>	Yes	<u><a href="#">Current OS as found here</a></u>
2x2plus	r12	r18.1	No	<u><a href="#">Current OS as found here</a></u>

solo*	r14.4.7	<u>Latest version of Designer found here</u>	Yes	<u>Current OS as found here</u>
EX 3	r24.2	<u>Latest version of Designer found here</u>	Yes	<u>Current OS as found here</u>
gx 1*	r14.3	<u>Latest version of Designer found here</u>	Yes	<u>Current OS as found here</u>
gx 2*	r14.3	<u>Latest version of Designer found here</u>	Yes	<u>Current OS as found here</u>
gx 2c*	r15.3.1	<u>Latest version of Designer found here</u>	Yes	<u>Current OS as found here</u>
gx 3	r22	<u>Latest version of Designer found here</u>	Yes	<u>Current OS as found here</u>
vx 1	r17.4 r20.1 with Matrox capture card	<u>Latest version of Designer found here</u>	Yes	<u>Current OS as found here</u>

vx 2*	r17.4 r20.1 with Matrox cap- ture card	<u>Latest version of Designer found here</u>	Yes	<u>Current OS as found here</u>
VX 2+	r26.4	<u>Latest version of Designer found here</u>	Yes	<u>Current OS as found here</u>
vx 4*	r15.2 with Deltacast capture card  r20.1 with Matrox capture card	<u>Latest version of Designer found here</u>	Yes	<u>Current OS as found here</u>
vx 4+	r21.4	<u>Latest version of Designer found here</u>	Yes	<u>Current OS as found here</u>
rx	r18	<u>Latest version of Designer found here</u>	Yes	<u>Current OS as found here</u>



rxII	r19	<u>Latest version of Designer found here</u>	Yes	<u>Current OS as found here</u>
OmniCal wired kit	r15	<u>Latest version of Designer found here</u>	Yes	N/A
OmniCal wireless kit	r15	r19	No	N/A

\*We test our latest Designer releases on current hardware platforms only. These products will continue to support the latest version of Designer; however we cannot guarantee that the hardware will be able to use newer features in the way in which it was designed due to the advancements made in technology implemented in our current hardware platforms today.

Last updated: January 2024

# Plus range overview

Power to you.

The plus range gives you the creative control to bring your vision to life.

With the plus range you have the flexibility to make changes on the fly, the freedom to craft and the power to make your ideas a reality.

[Solo product page](#)

# Solo overview



**Warning: do not open or remove the case unless you are instructed to do so by a certified Disguise Engineer**

The machines come pre-installed with the latest software version, enabling you to design, configure and sequence the show on the same machines as you later use for show playback.

For detailed information on the specifications for each machine, as well as the other software and hardware bundles offered by Disguise, please see the products section of our [web site](#).

# Solo machine

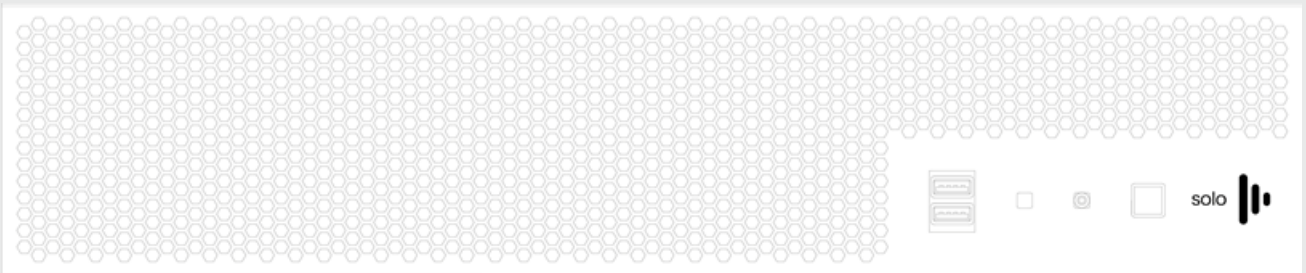

Front view of Solo

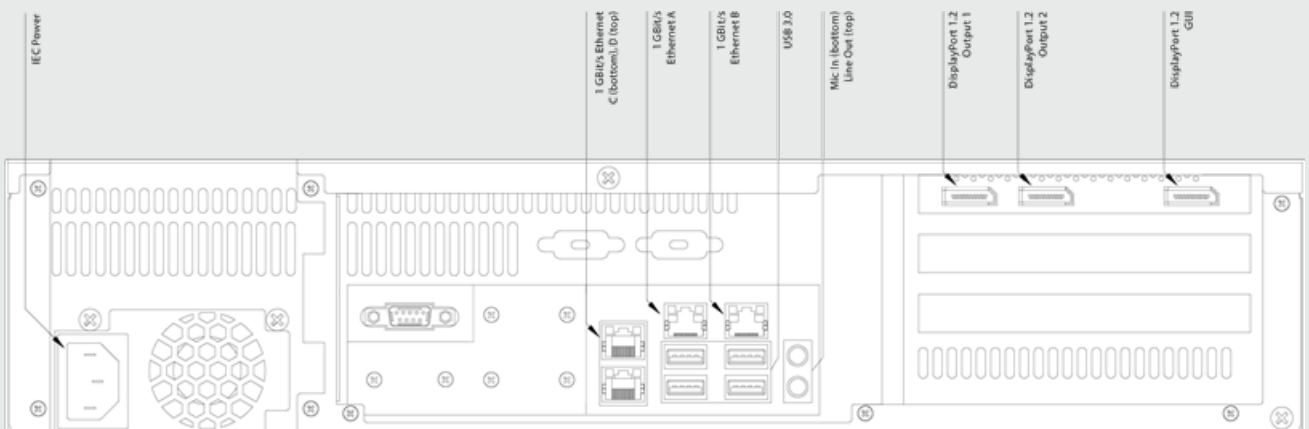

Rear view of Solo

**Please note:** If you experience any problems with hardware please contact the [support team](#).

# Solo diagrams

## Solo base unit

The base unit has no video capture and comes with onboard audio.

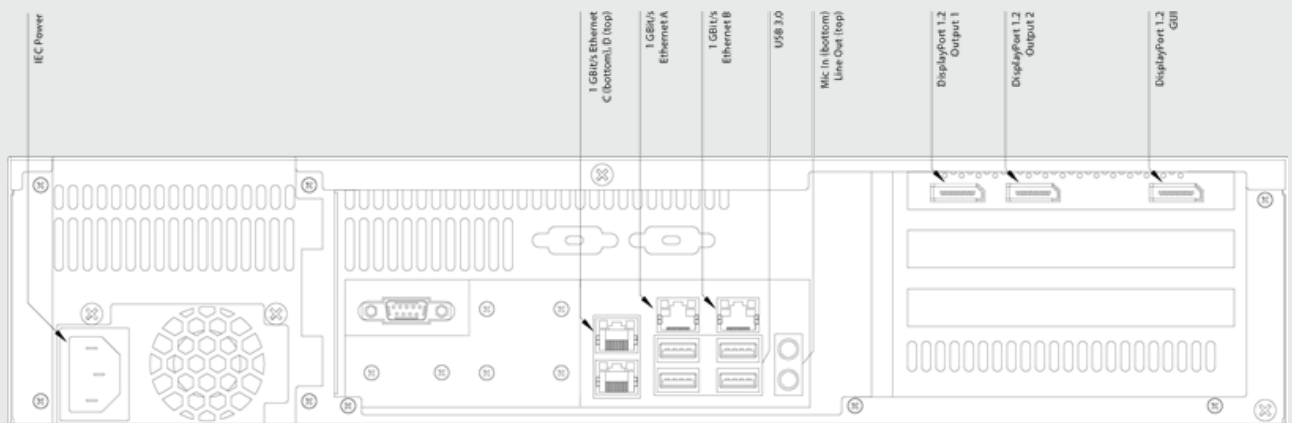

Base unit diagram

## Solo Configuration A

Pro Audio & SDI capture options installed.

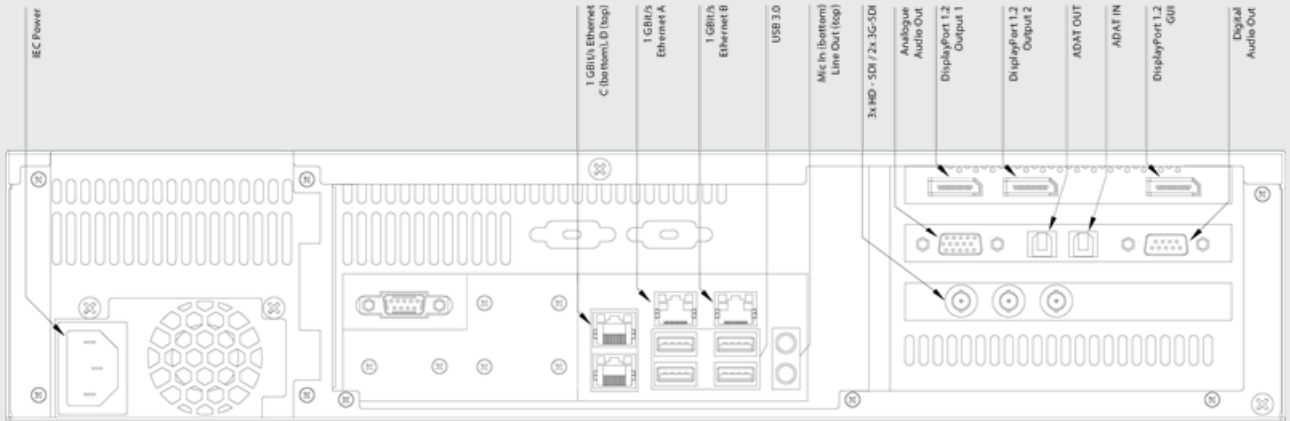

Rear panel diagram

## Solo Configuration B

Pro Audio & HDMI Capture options installed.

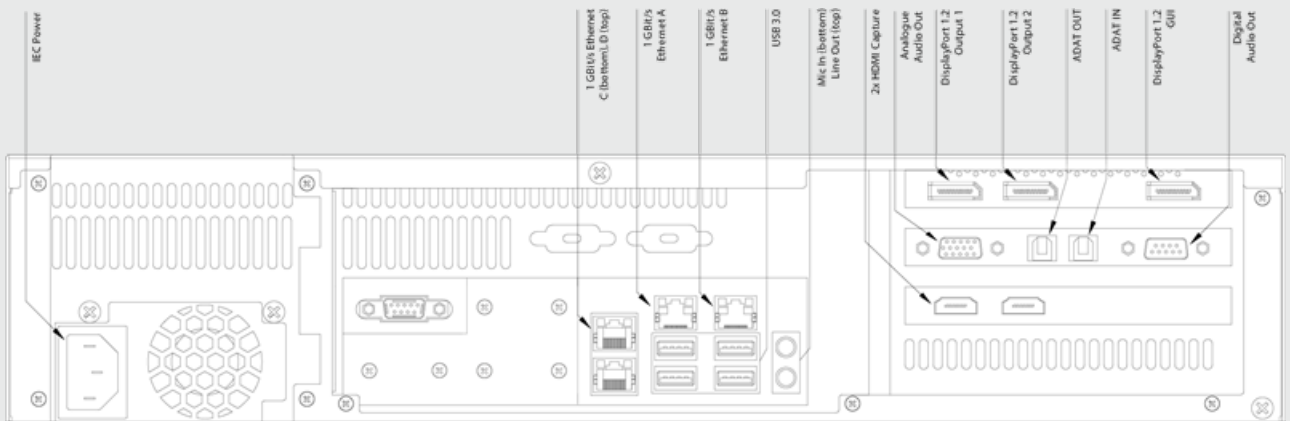

Rear panel diagram

# Solo Configuration C

Pro Audio & 10G network options installed

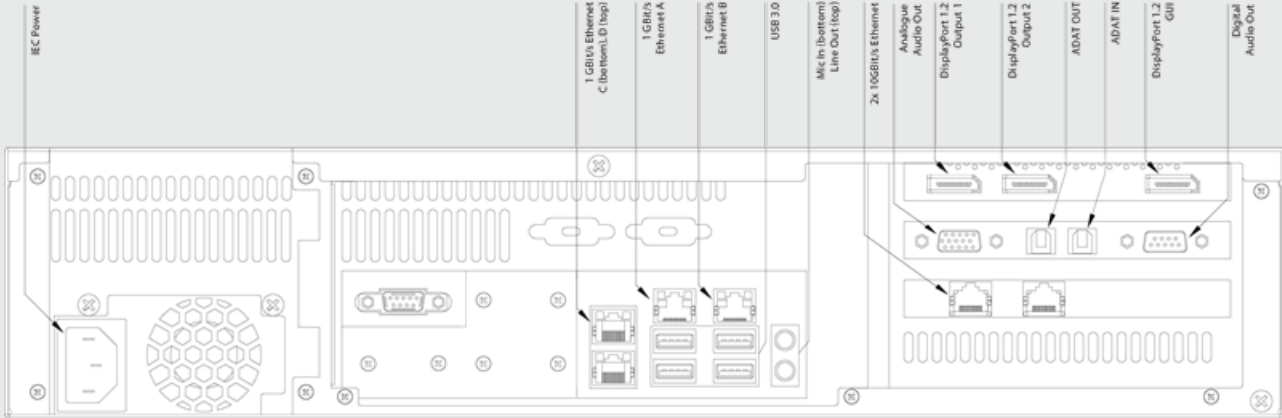

Rear panel diagram

# Powering the system

1. Make sure you have connected a keyboard, mouse and monitor to the primary graphics output.
2. Press the power button on the front of the unit and wait for the system to load into Windows.

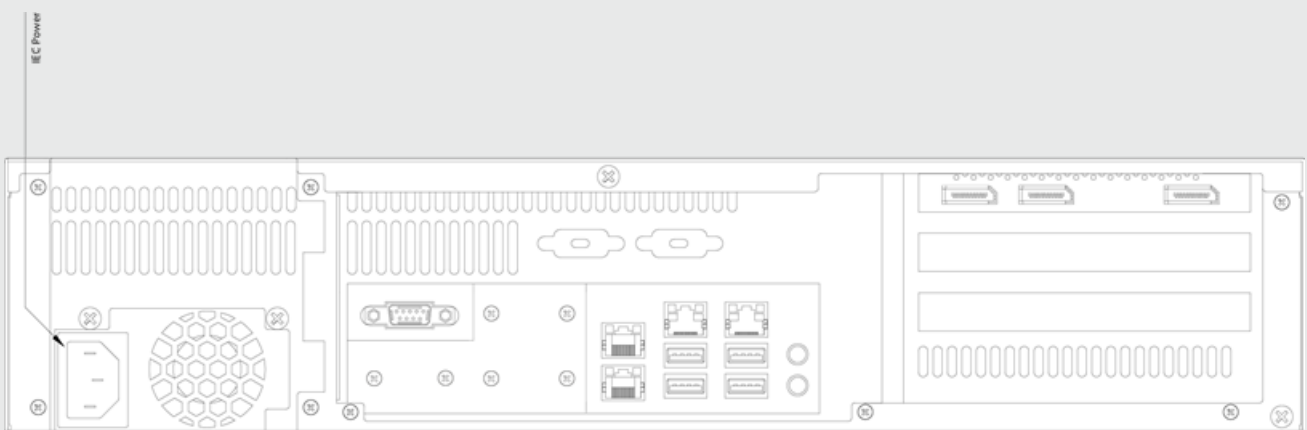

Location of power input on rear of the plus range unit

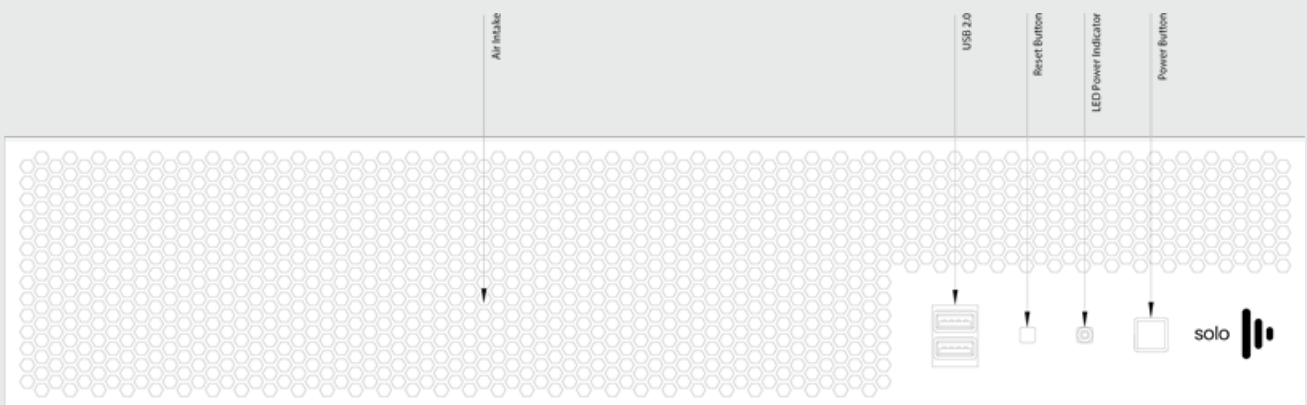

Location of power switch on front of unit



# Filter replacement

You should regularly inspect the air filter on the front of the unit to prevent loss of cooling efficiency.

To access the filter, remove the 3 top fascia screws and the bottom 3 fascia screws. Then simply pull the entire fascia off to get access to the filter.

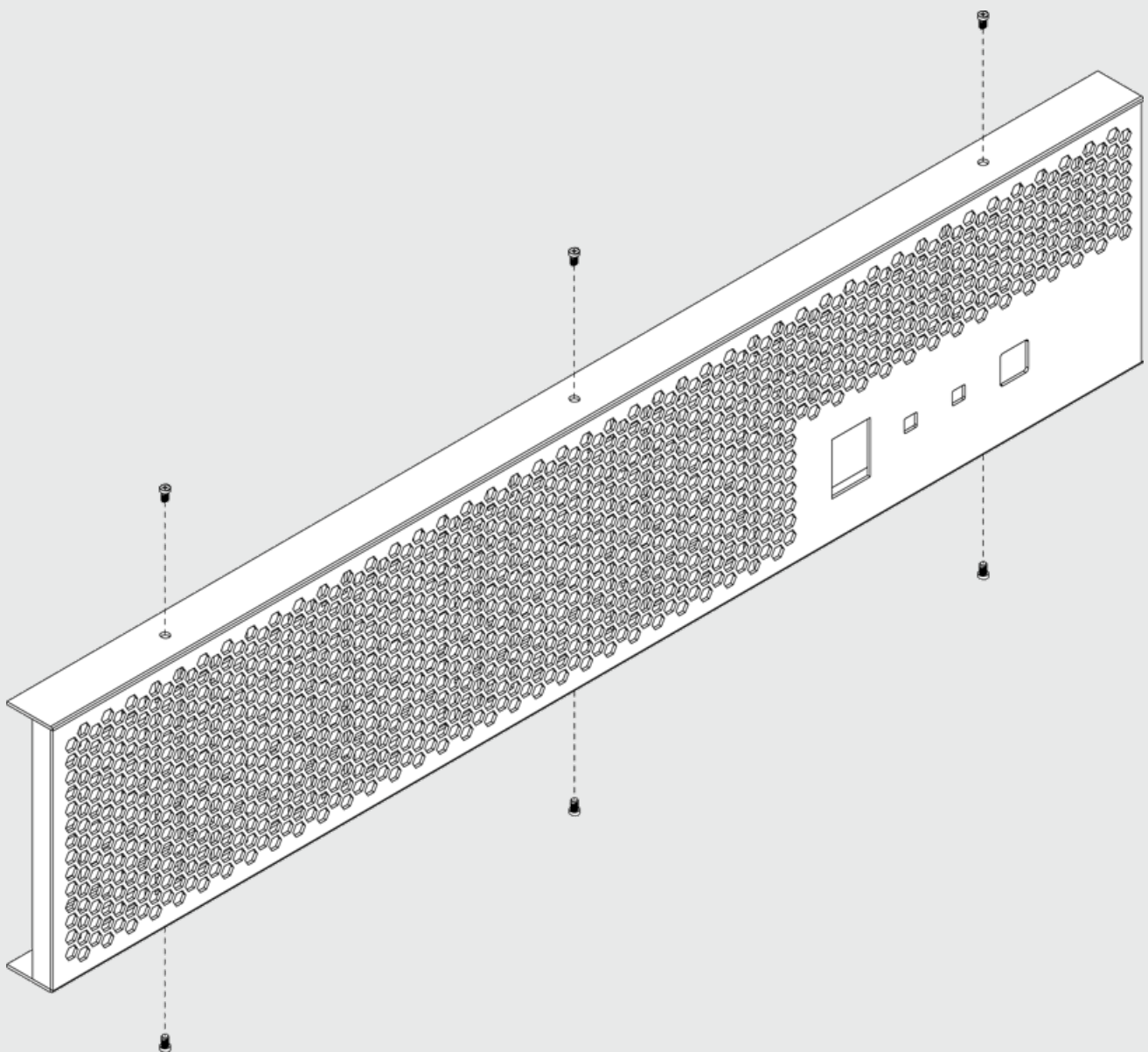

*Air filter housing front*

**Please note:** It is recommended that you service the air filter when the unit is powered off. If the unit is on you will be exposed to the system fans

To remove the perforated metal grid keeping the filter in place, please pull from the middle out.

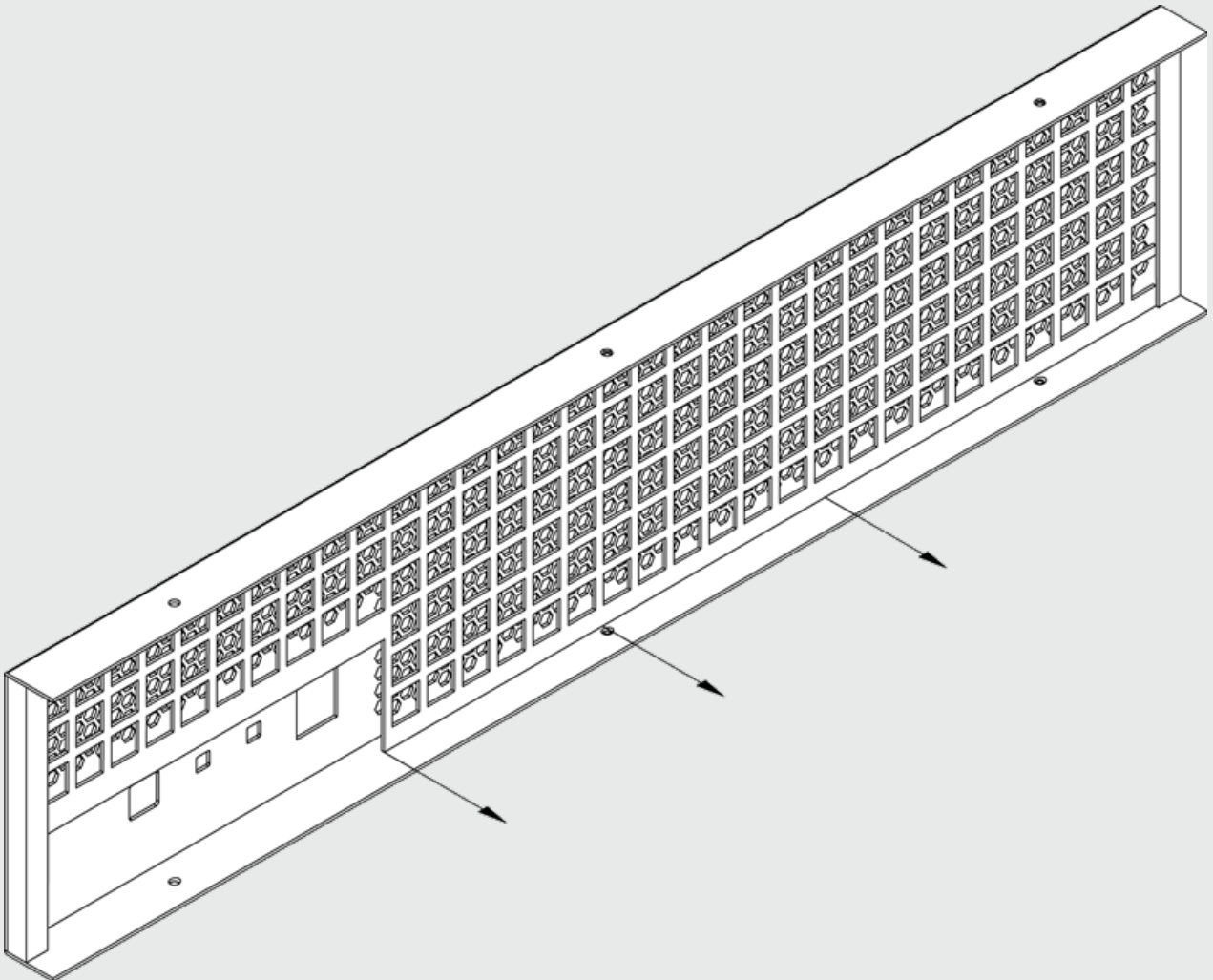

*Air filter housing rear*

Give the filter a clean, replace the filter in the metal frame and reattach the fascia to the front of the unit.

# Card Configuration

The Disguise Solo comes in a variety of optional factory fitted configurations. Your machine configuration can only be changed by sending it back to Disguise to be upgraded. The following configurations are available:

- No capture, a choice of on-board audio or Pro Audio
- 10Gb Ethernet, a choice of on-board audio or Pro Audio
- HDMI capture, a choice of on-board audio or Pro Audio
- SDI capture, a choice of on-board or Pro Audio

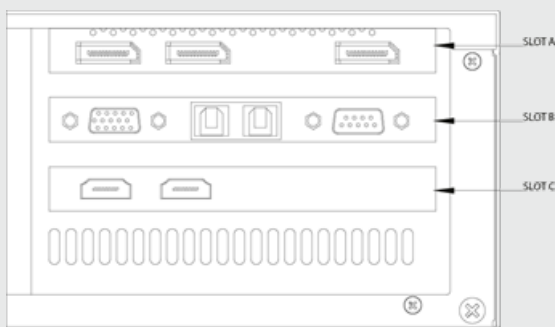

*Rear view card configuration*

## Slot A

Slot A is video output and is non-configurable. The Solo has 1 control / GUI output and 2 dedicated DisplayPort stage outputs.



## Video output card

The solo has three DP 1.2 outputs (1x dedicated GUI, 2x Outputs)

The GUI output is located on the previously highlighted port. This port CANNOT be used to output to the stage.

Supported resolutions on the DisplayPort outputs are up to 4096x2160 @60hz.

## Slot B

Slot B is by default blank, so the on-board audio is used but can be configured to be Pro Audio I/O when the order is placed.

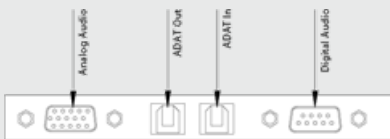

## Slot C

Slot C has four options - blank, HDMI capture, SDI capture or 10G Ethernet. Capture/Ethernet options are factory fitted.

## HDMI Capture card



Max resolution: 1x 4096x2160 @30 Hz or 2x 1920x1080p @60Hz

## SDI Capture card



Max resolution 3x HD - SDI or 2x 3G - SDI

## 10G Ethernet card



# HDMI capture

Your Disguise system is can be equipped with optional capture cards. These cards have the ability to capture live video.

## Maximum number of unique inputs

The Solo machine can take two HDMI inputs. Max resolution: 1x 4096x2160 @30 Hz or 2x 1920x1080p @60Hz

## Back-Plate layout



*Diagram of HDMI Video capture connections on rear of Solo.*

**Please note:** Live Video input inherently introduces frame latency during playback. Please contact [Support](#) for guidance on performance standards.

## Technical limitations



**Warning:** Colour Sampling Supported: RGB 8-8-8, YUV 4-4-4

## Configuring presented EDID to source device

Please open the **Configure Vision** application and click the **Configure** button

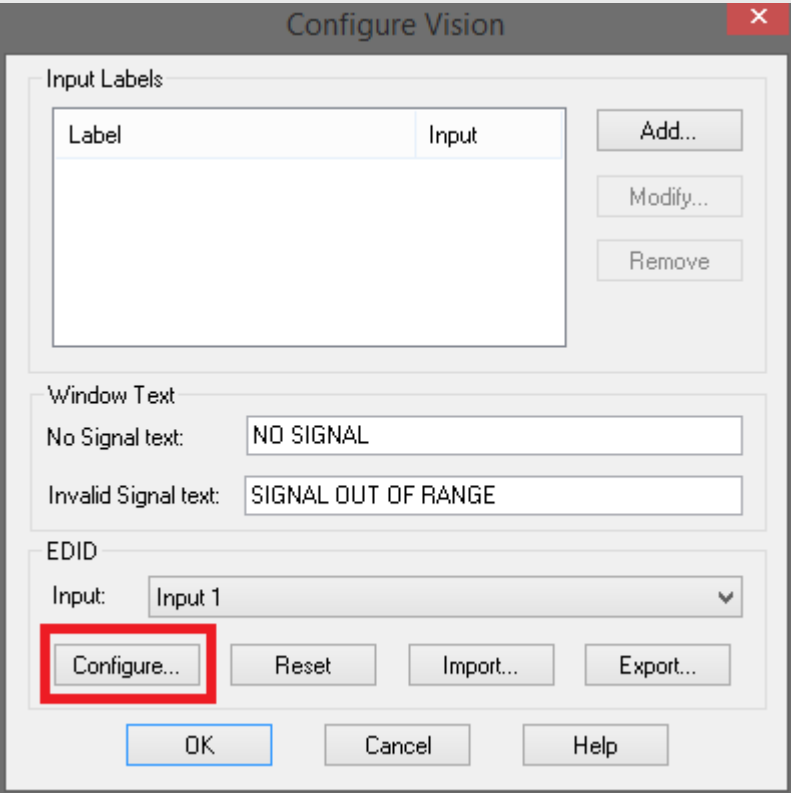

Create an EDID to present to the source device, for example a laptop

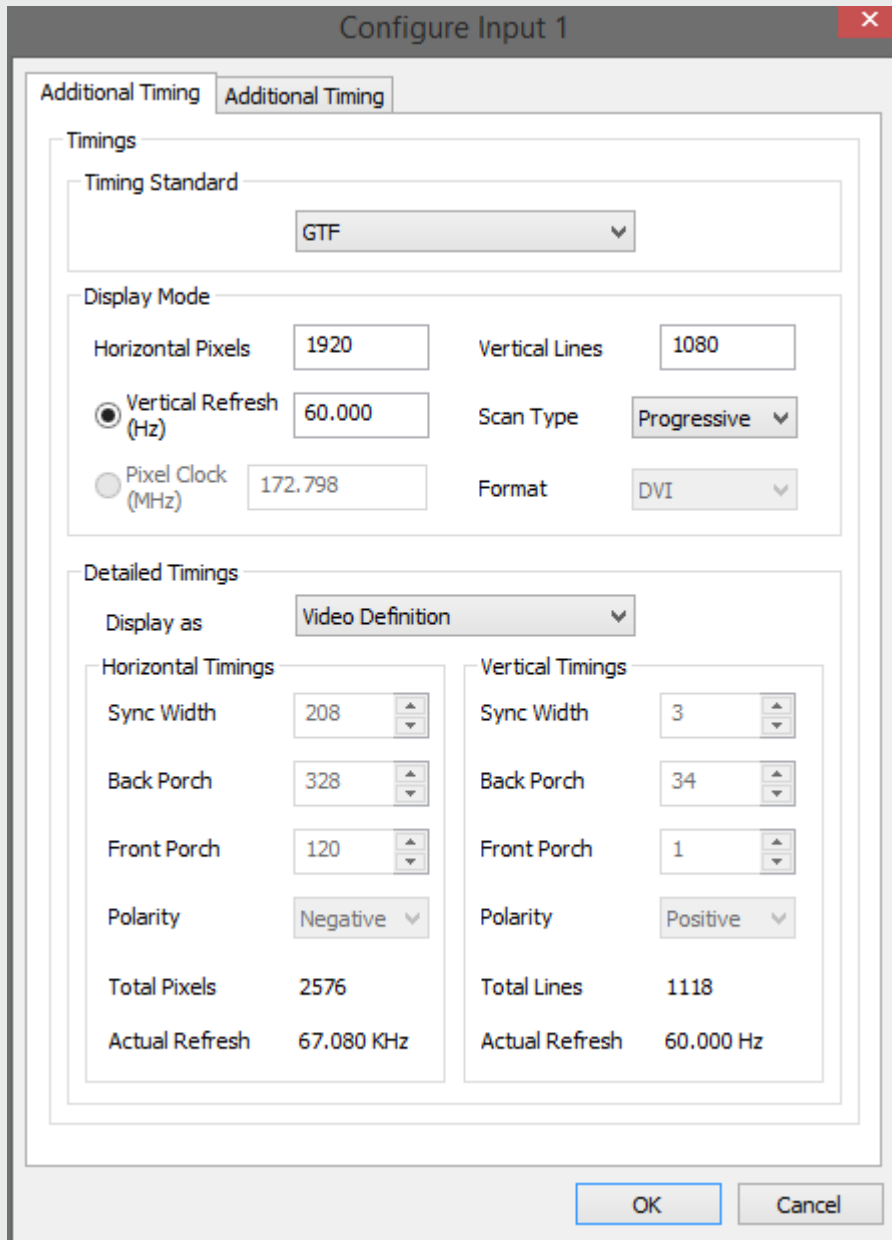

## Preview HDMI Input outside Disguise software

Please open the **Vision Window application** to show HDMI capture outside the software



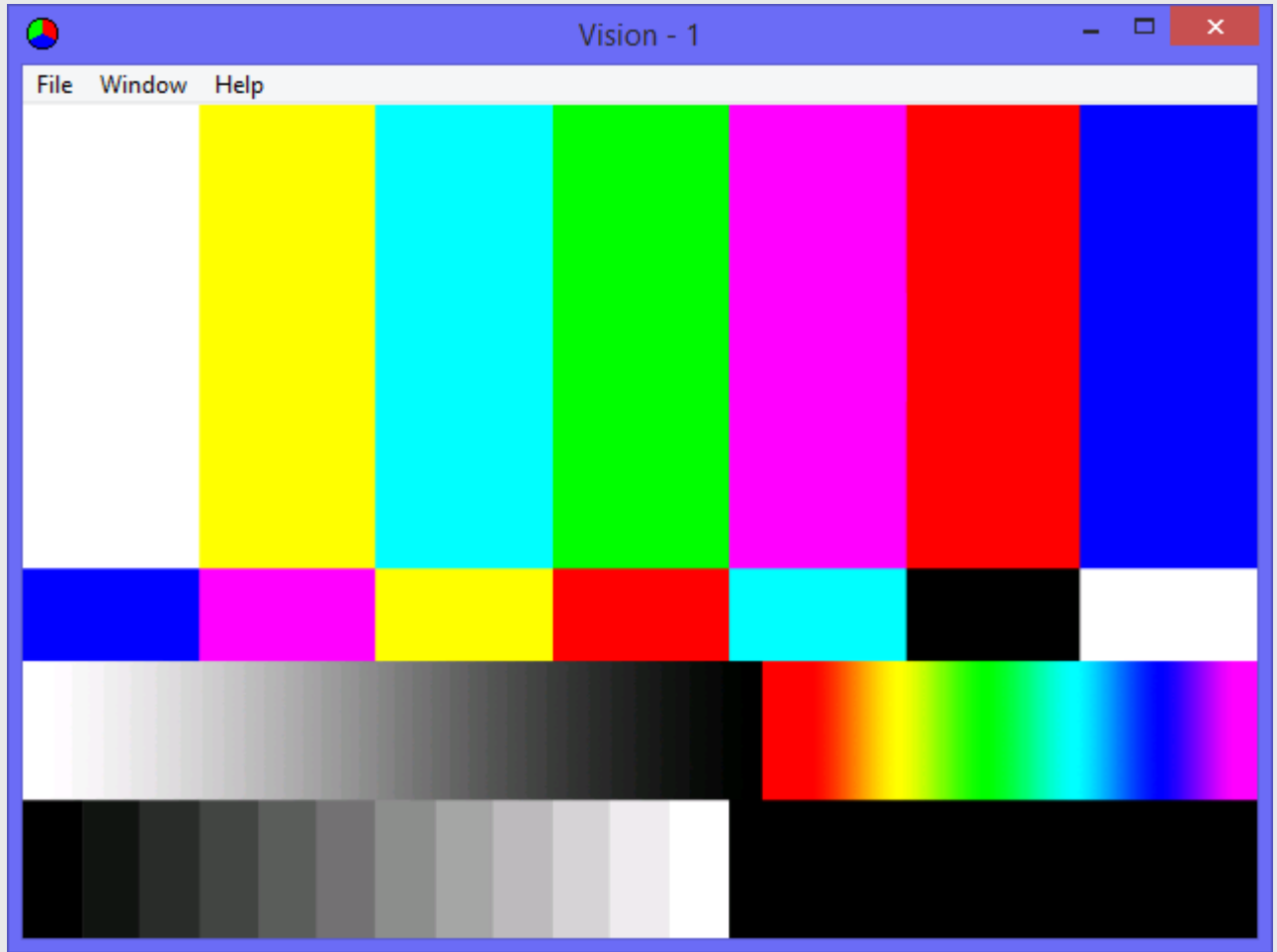

# SDI capture

Your Disguise system is can be equipped with optional capture cards. These cards have the ability to capture live video from either SD-SDI or HD-SDI video sources with up to three unique feeds, or two unique 3G-SDI feeds per machine.

## Max Number of Unique Inputs

The Solo machine can take three HD-SDI inputs or two 3G SDI inputs.

## Supported formats

720x486i @ 59.94 Hz NTSC

720x576i @ 50.00 Hz PAL

1280x720p @ 23.976Hz, 24Hz, 25Hz, 29.97Hz, 30Hz, 50Hz, 59.94Hz, 60Hz

1920x1080i @ 47.96Hz, 48Hz, 50Hz, 59.94Hz, 60Hz

1920x1080PsF @ 23.976Hz, 24Hz, 25Hz, 29.97Hz, 30Hz

1920x1080p @ 23.976Hz, 24Hz, 25Hz, 29.97Hz, 30Hz, 47.96Hz, 48Hz, 50Hz, 59.94Hz, 60Hz

2048X1080p @ 23.976Hz, 24Hz, 25Hz, 29.97Hz, 30Hz, 47.96Hz, 48Hz, 50Hz, 59.94Hz, 60Hz

2048X1080i @ 47.96Hz, 48Hz, 50Hz, 59.94Hz, 60Hz

2048x1556PsF @ 14.98Hz, 15Hz, 18.98Hz, 19Hz

It is possible to have a different format on each input, However the limitations are a maximum of 1x 4k or 2x 1080p60.

If you are using 1x 4k or 2x 1080p it is not possible to use any other video inputs on the unit due to hardware limitations.

## Back-Plate Layout



*Diagram of Video Capture BNC connections on rear of Solo.*

**Please note:** Live Video input inherently introduces frame latency during playback. Please contact [Support](#) for guidance on performance standards.

# 10G Ethernet

Your Disguise system is can be equipped with an optional 10G Ethernet card.

The 10G Ethernet card is a newly available option for the Solo, that allows for media transfer at 10gb/s speeds which aligns with the gx and pro ranges of products.

## Back-Plate Layout



*Diagram of Ethernet connections on rear of Solo.*

# Onboard Audio

The onboard audio card has one channel of audio input and one channel of audio output.

These connections are made over mini-jack (3.5 mm) connections. There is 1 point of connection both for input and output.

One is for line level audio and one is for mic level audio

Solo can receive LTC input through the microphone input but care must be taken to set the correct volume values. If the volume is set too loud, it will not work properly. The recommended settings in windows is +0db (off).

**Please note:** Audio does not appear as a configurable device unless a mini-jack is connected on the back of the system

# Pro Audio

## Digital breakout cable

This digital breakout cable provides the following inputs and outputs:

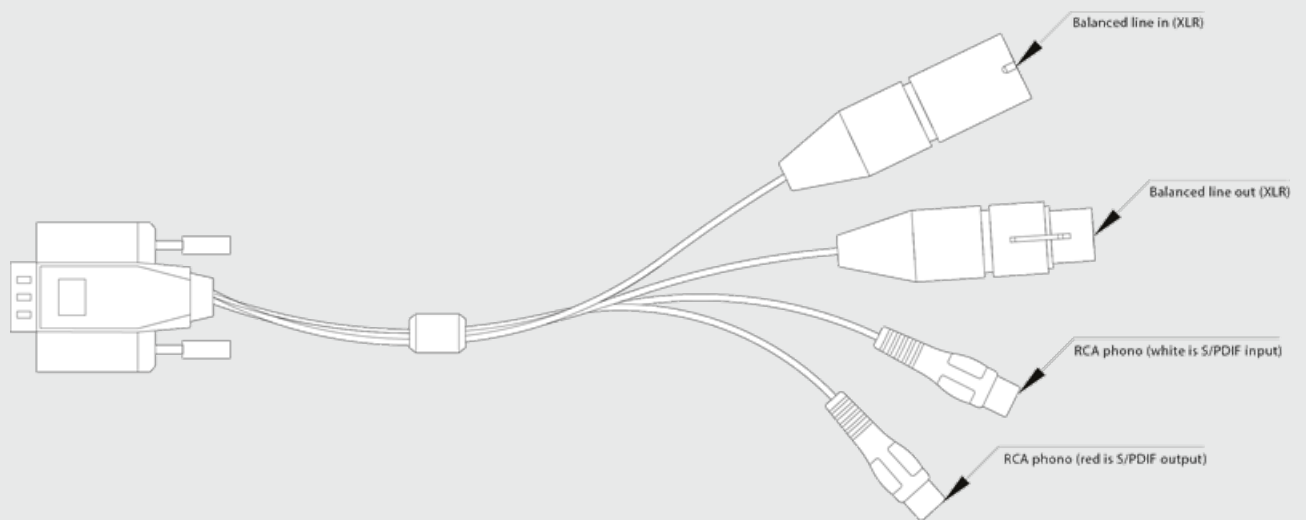

## Analog breakout cables

The Pro audio option comes with analog breakout cables which lets you choose which input/output to use.

# HDSPe AIO: Analog breakout cable, balanced

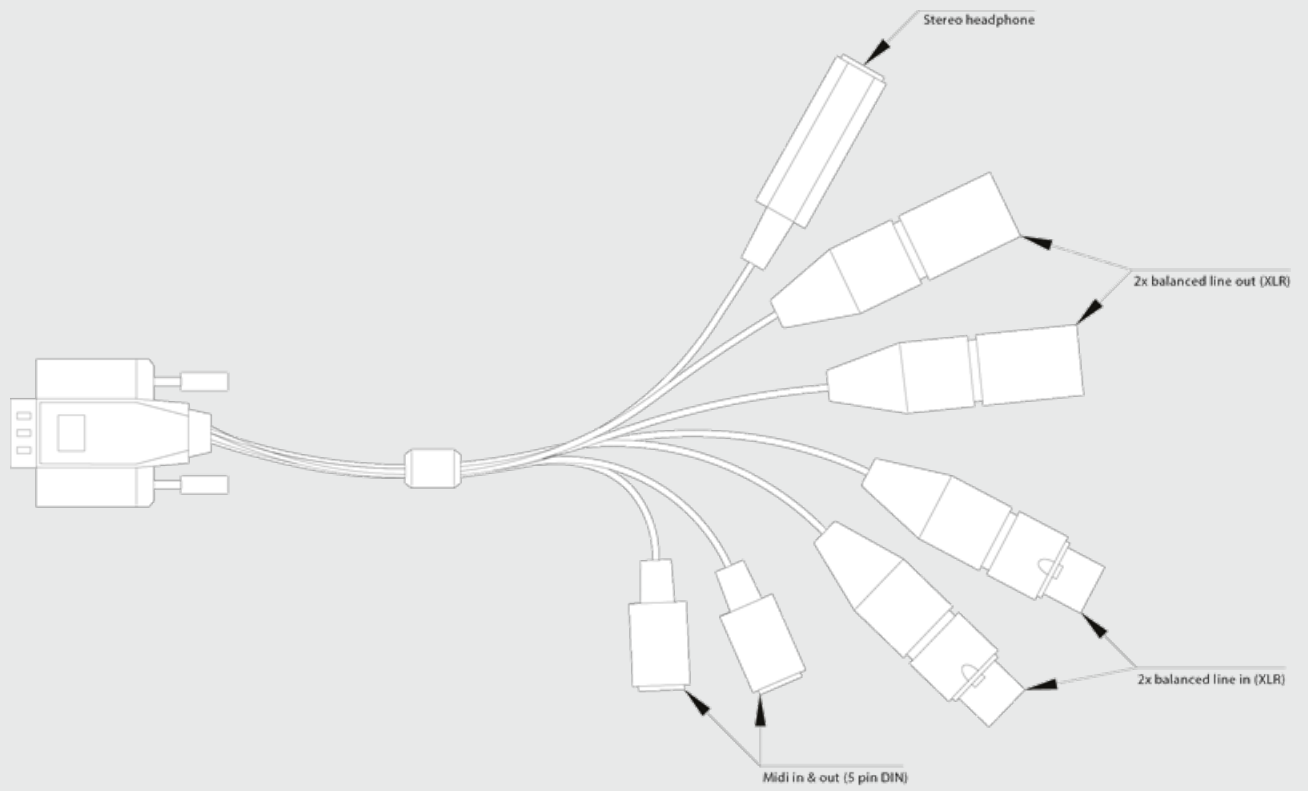

## HDSPe AIO: Analog breakout cable, un-balanced

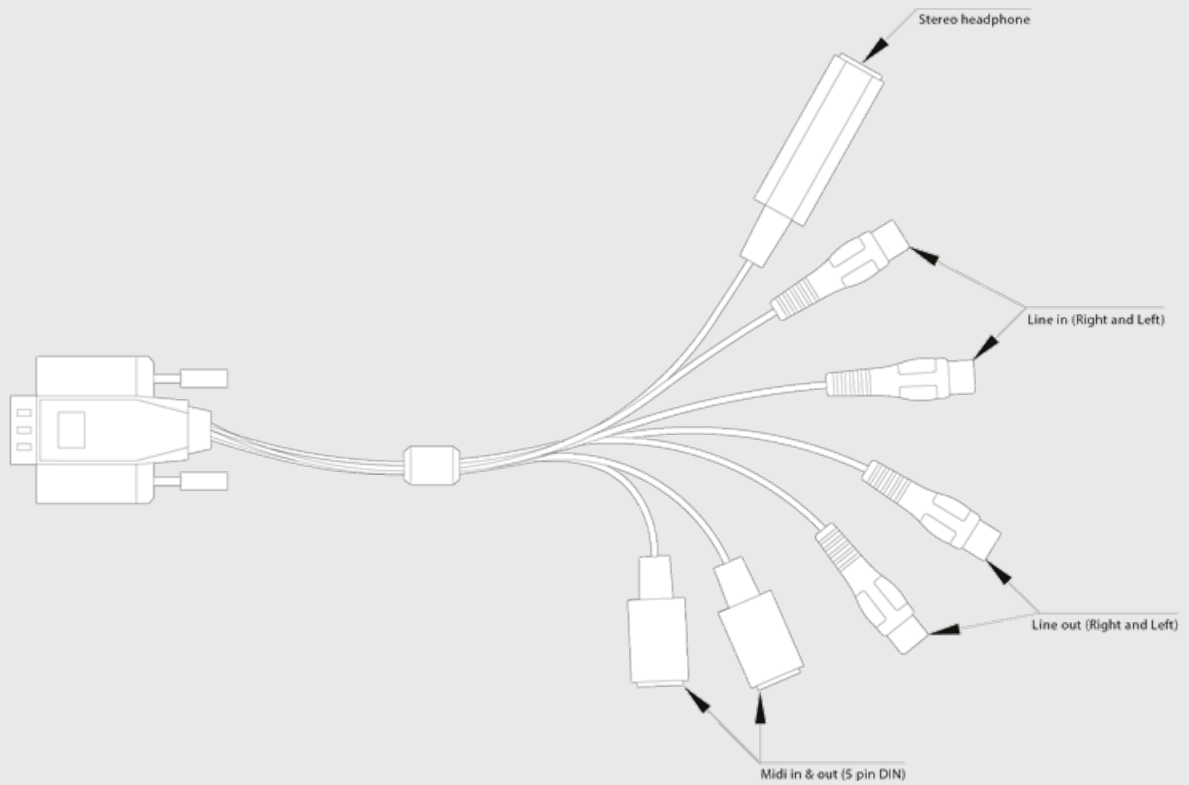

## Are different breakout cables available?

There are several variations of the audio breakout cables available.

Please refer to the [RME website](#) for more information.

# Resetting Pro-audio mixer to default settings

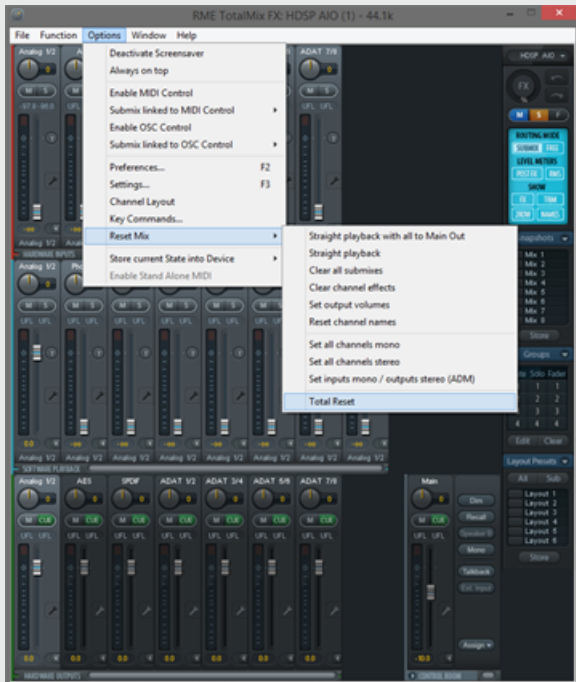

Please see the [audio output patch](#) topic for more information on how to configure your output channels



# Update & restore

Update & restore is the process of doing an update or restore on the system using a bootable USB drive. This process does not affect the media drive.

Please note: If you experience any problems during updating or restoring the system, or any of these instructions are unclear, please contact the [support team](#).



**Warning:** The system needs to be connected to the internet during this procedure

This process can be used to update to a newer OS image, or revert to a previous OS image.

To tell what OS image your system is on please go to the help menu in [Manager](#) and select **About Manager**.

## You will need

- A 32Gb USB memory stick
- A version of [Rufus](#) to turn it into a bootable disk. Make sure the volume name of the usb is: "REDISGUISE".
- An internet connection to the machine you are re-imaging
- Download and install a version of [7Zip](#)
- Download and unzip the multi file archive using 7Zip

- OS images can be found [here](#).

**Please note:** You do not need to extract all parts individually. Simply place them in the same directory and then use 7zip to extract the ISO by selecting any part. 7zip will automatically unzip all parts to create the image file.

## Create Bootable USB device

1. Download and unzip the multi file archive using 7Zip (NOTE: you will only need to unzip file 001):

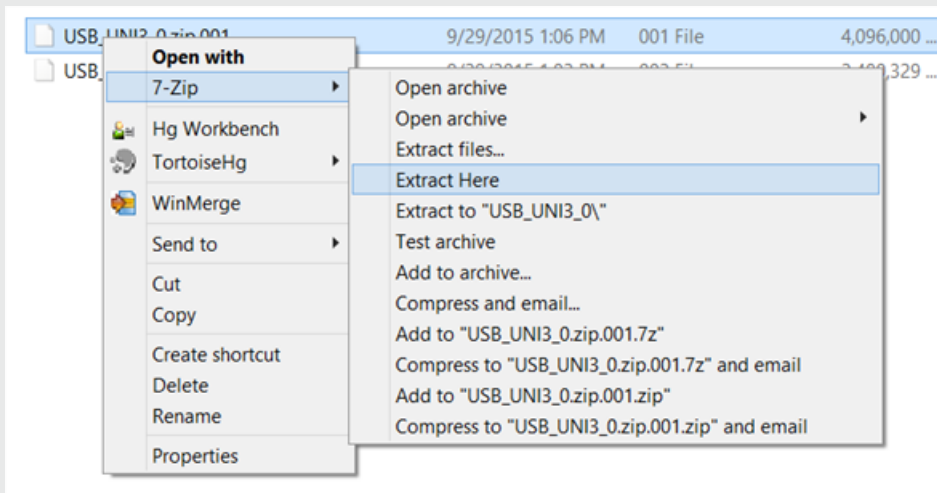

2. Create Bootable USB stick with the unzipped ISO.

The settings should be:

- **Partition scheme** - MBR
- **Target system** - BIOS (or UEFI-CSM)

- **Volume label** - automatically pulled from the ISO file
- **File system** - NTFS



**Warning:** These settings are critically important. The re-image process will fail if they are not set correctly.

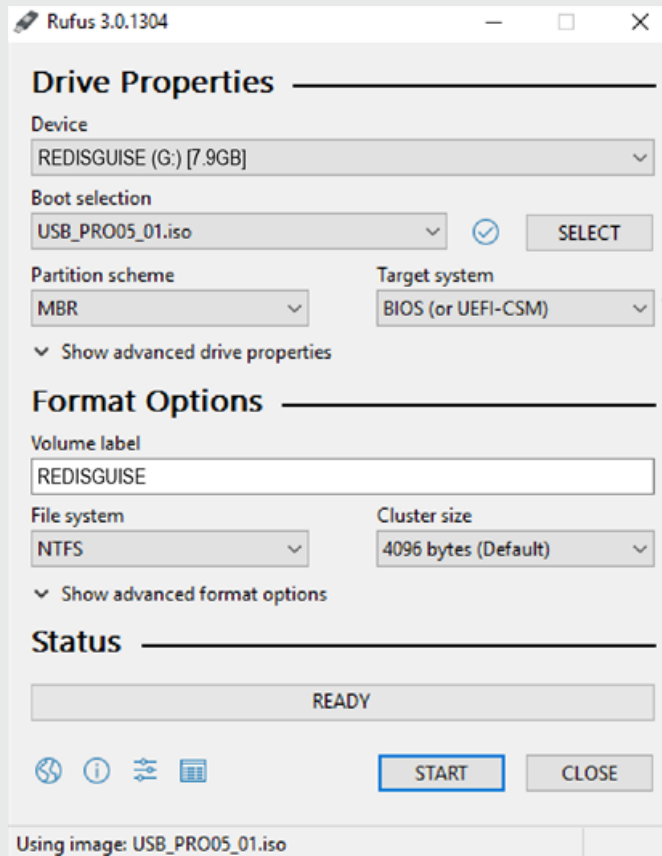

## Booting into the USB

1. Insert the USB Device and go into the BIOS by hitting **Delete** on the logo splash screen during boot.

2. Navigate to the **Boot** tab using the arrow keys and change the Boot option #1 to the **P0: SQF-SDMM2-128GB(OS Drive)**.
3. Navigate to the **Save & Exit** tab and press enter on **Save Changes** and **Exit**. The server will boot into the desktop.
4. Restart with the USB plugged in and go into the BIOS by hitting **Delete** on the logo splash screen during boot.
5. Navigate to the **Save & Exit** tab and select your USB stick from the Boot override menu. Press **Enter**.
6. Be ready to hit any key to confirm USB boot immediately after.
7. You can download the latest version of Disguise software from [here](#) and you will be good to go!

# Overview

## Overview

### gx Range Overview

The gx range is the future of live show design.

Generative content - the coming wave of live show design.

Render in real-time for a show that responds to its environment. Whether it's smoke that moves as it's touched or water that ripples as performers pass by, the immersive experiences you'll create will captivate audiences like never before.

[gx 2c product page](#)

[gx 3 product page](#)

## gx 2c Overview

The gx 2c comes pre-installed with the latest software version, enabling you to design, configure and sequence the show on the same machines as you later use for show playback.

For detailed information on the specifications for each machine, as well as the other software and hardware bundles offered by , please see the products section of our [website](#).

# gx 2c diagrams

## gx 2c Machine

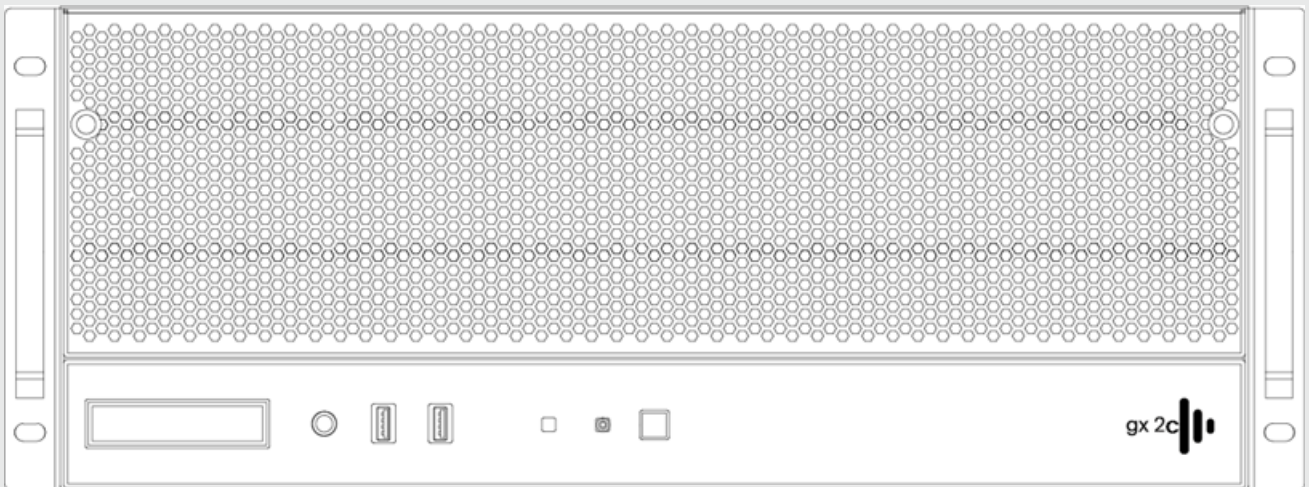

Front view of gx 2c

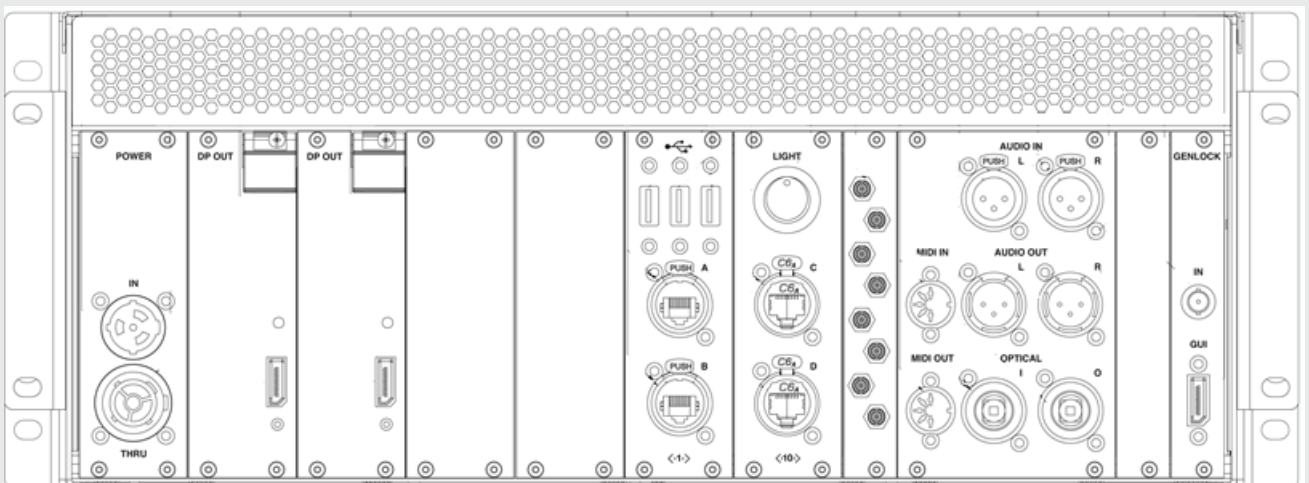

rear view of gx 2c

# gx 2cPerformance

## Playback

The following table shows how many layers can simultaneously be played back per codec:

Video Codec	Content Data Rate	Max Layers
HD HAP 30	27.8 MB/s	48
HD HAPQ 30	31.3 MB/s	40
HD Animation 30	107 MB/s	21
HD TIFF Sequence 30	237 MB/s	12
UHD HAP 30	95.4 MB/s	23
UHD HAPQ 30	143 MB/s	16
UHD Animation 30	697 MB/s	4
HD NotchLC 30	63.51 MB/s	35
UHD NotchLC 30	233.91 MB/s	12
UHD DPX Sequence, 8-bit, RGB, 30	712 MB/s	4
UHD DPX Sequence, 8-bit, RGB, 60	1428 MB/s	1
UHD DPX Sequence, 10-bit, RGB, 30	949 MB/s	3
UHD DPX Sequence, 10-bit, RGB, 60	1898 MB/s	1
UHD TGA Sequence, 8-bit, RGB, 30	711 MB/s	8
UHD TGA Sequence, 8-bit, RGB, 60	1422 MB/s	3
UHD TGA Sequence, 8-bit, RGBA, 30	949 MB/s	6
UHD TGA Sequence, 8-bit, RGBA, 60	1898 MB/s	1
UHD TIFF Sequence, 8-bit, RGB, 30	712 MB/s	7
UHD TIFF Sequence, 8-bit, RGB, 60	1424 MB/s	3
UHD TIFF Sequence, 8-bit, RGBA, 30	949 MB/s	6
UHD TIFF Sequence, 8-bit, RGBA, 60	1898 MB/s	2

### NOTES:

- All content is 30 fps
- Readings are taken from an Actor



- VFC-compatible machines run with pass-through style cards (HDMI or DP)
- 60Hz project
- Genlock on all machines which support it
- One unique video file per layer, all mapped onto one screen
- Absolute maximum level of performance
- One more layer means the system starts to drop frames
- Measured against 16.0.4, build 60742

## Capture Latency

The following table provides data on how many frames of latency the gx 2c requires from capture to output:

### gx 2c SDI

Refresh Rate	Normal mode (frames)	Low Latency mode (frames)	Ultra-Low Latency (frames)
60Hz	5	4	3
50Hz	5	4	3
30Hz	5	4	3

### gx 2c NDI

Refresh Rate	Normal mode (frames)	Low Latency mode (frames)	Ultra-Low Latency (frames)
60Hz	6	5	4
50Hz	6	5	4
30Hz	6	5	4

# Video input

Your Disguise system is equipped with capture cards. These cards have the ability to capture live video from either SD-SDI or HD-SDI video sources with up to four unique feeds, or two unique 3G-SDI feeds per machine.

## Max Number of Unique Inputs

	SD-SDI	HD-SDI	3G-SDI
gx 2c	4	4	2
gx 2c	8	8	8



**Warning:** 4K resolutions is currently only supported over quad split HD-SDI

## Supported formats

720x486i @ 59.94 Hz NTSC

720x576i @ 50.00 Hz PAL

1280x720p @ 23.976Hz, 24Hz, 25Hz, 29.97Hz, 30Hz, 50Hz, 59.94Hz, 60Hz

1920x1080i @ 47.96Hz, 48Hz, 50Hz, 59.94Hz, 60Hz

1920x1080PsF @ 23.976Hz, 24Hz, 25Hz, 29.97Hz, 30Hz

1920x1080p @ 23.976Hz, 24Hz, 25Hz, 29.97Hz, 30Hz, 47.96Hz, 48Hz, 50Hz, 59.94Hz, 60Hz

2048X1080p @ 23.976Hz, 24Hz, 25Hz, 29.97Hz, 30Hz, 47.96Hz, 48Hz, 50Hz, 59.94Hz, 60Hz

2048X1080i @ 47.96Hz, 48Hz, 50Hz, 59.94Hz, 60Hz

2048x1556PsF @ 14.98Hz, 15Hz, 18.98Hz, 19Hz

4K UHD 3840x2160, 4K P/PsF @ 23, 24, 25, 29, 30fps

4K DCI 4096x2160, 4K P/PsF, @23, 24, 25, 29, 30fps

It is possible to have a different format on each input, However the limitations are a maximum of 1x 4k or 2x 1080p60.

If you are using 1x 4k or 2x 1080p it is not possible to use any other video inputs on the unit due to hardware limitations.

# Back-Plate Layout



Diagram of Video Capture BNC connections on rear gx 2c

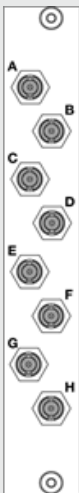

Diagram of Video Capture BNC connections on rear of a gx 2c.

**Please note:** Live Video input inherently introduces frame latency during playback. Please contact [Support](#) for guidance on performance standards.

# Unit rear light - gx 2c

Disguise servers in the pro and gx ranges come with the addition of an LED light on the back of the unit that illuminates the connections on the rear panel.

The light can be turned on or off using the switch labeled "light" with power in.

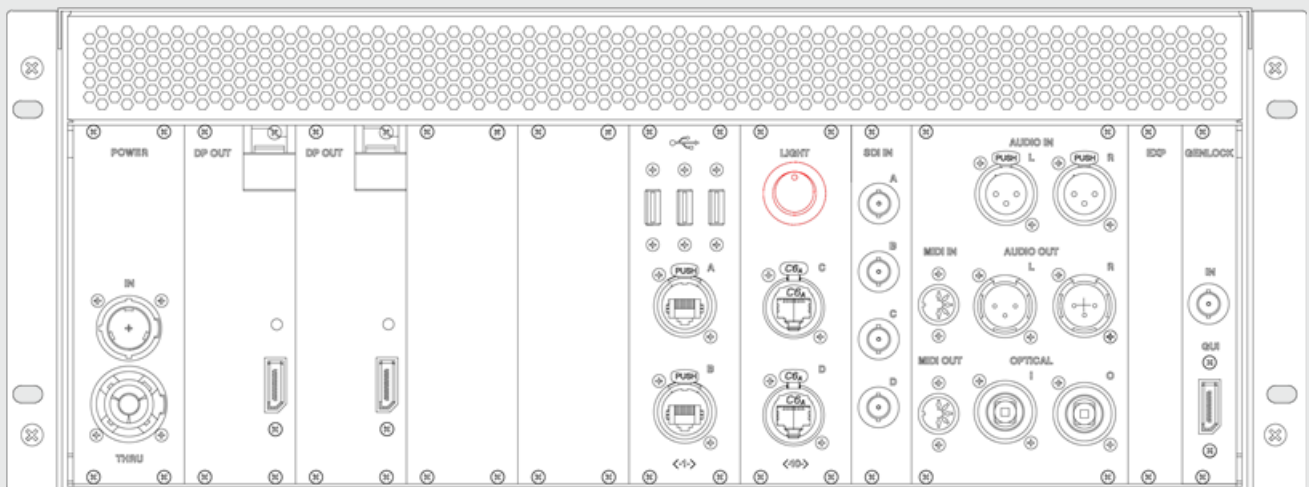

Location of light switch on rear of a gx 2c

# System Restore - gx 2c

The processes for restoring and reimaging a gx 2c

Internal system restore is the process of doing a factory restore on the system.

REDISGUISE is the process of doing an update or restore on the system using a bootable USB drive.

Neither of these restore processes affects the media drive of the server.

**Please note:** This procedure will only work with OS version 10 and greater.

To locate your OS version please go to **d3manager- Help - About d3manager**.

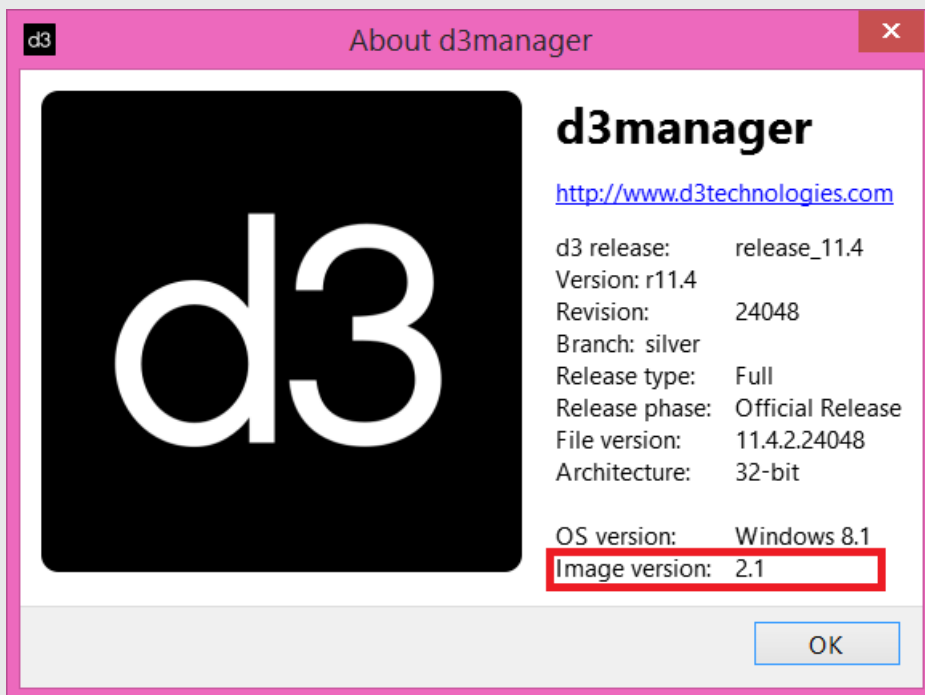

**Warning:** The system needs to be connected to the internet during this procedure. If it is not, or it loses internet connection during the process - windows activation will fail.

---

Re-imaging the system

1. Hold down **shift** whilst restarting the system.

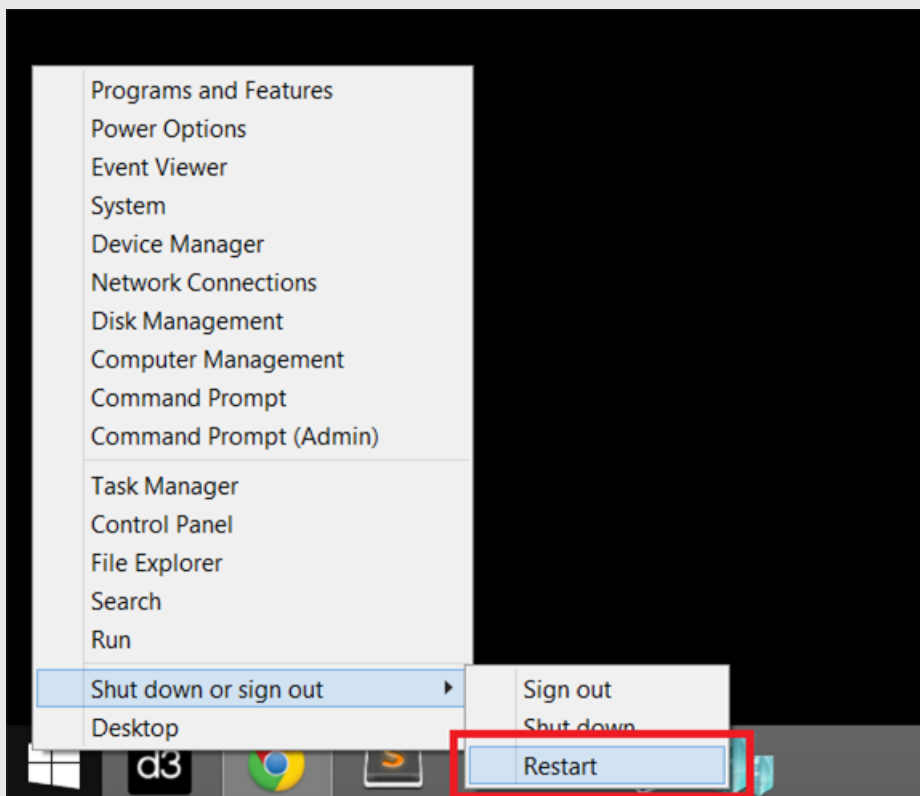

- 
2. Select **Use another operating system**

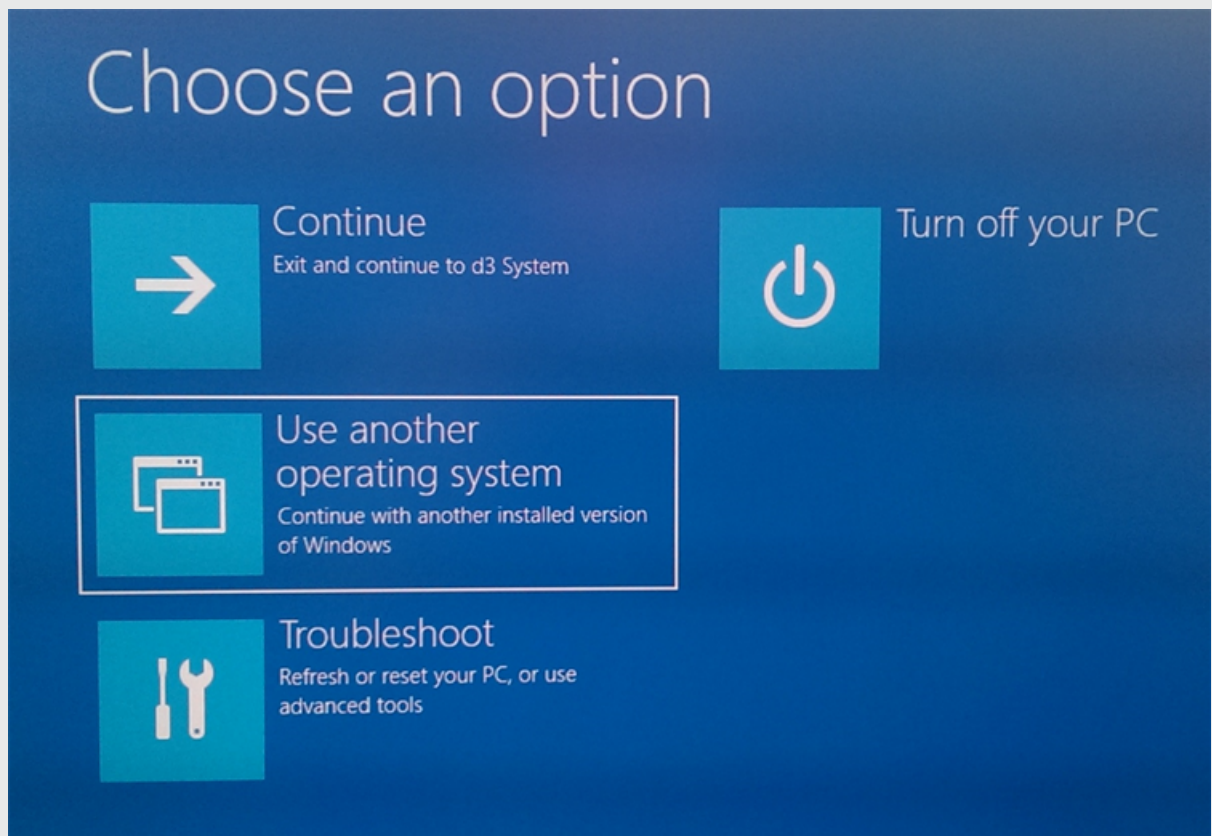

- 
3. Select **Reset OS**.

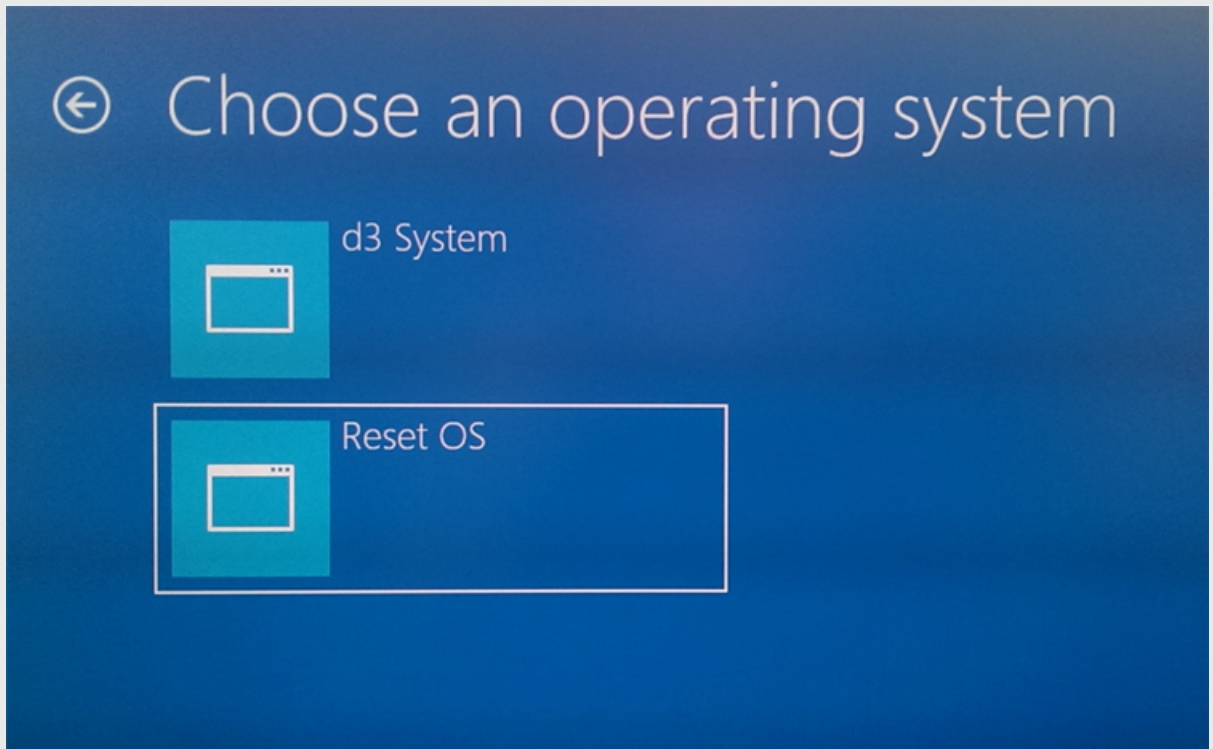

4. The system will reboot into the internal re-imaging system which will reinstall the Operating System and revert settings to factory
-



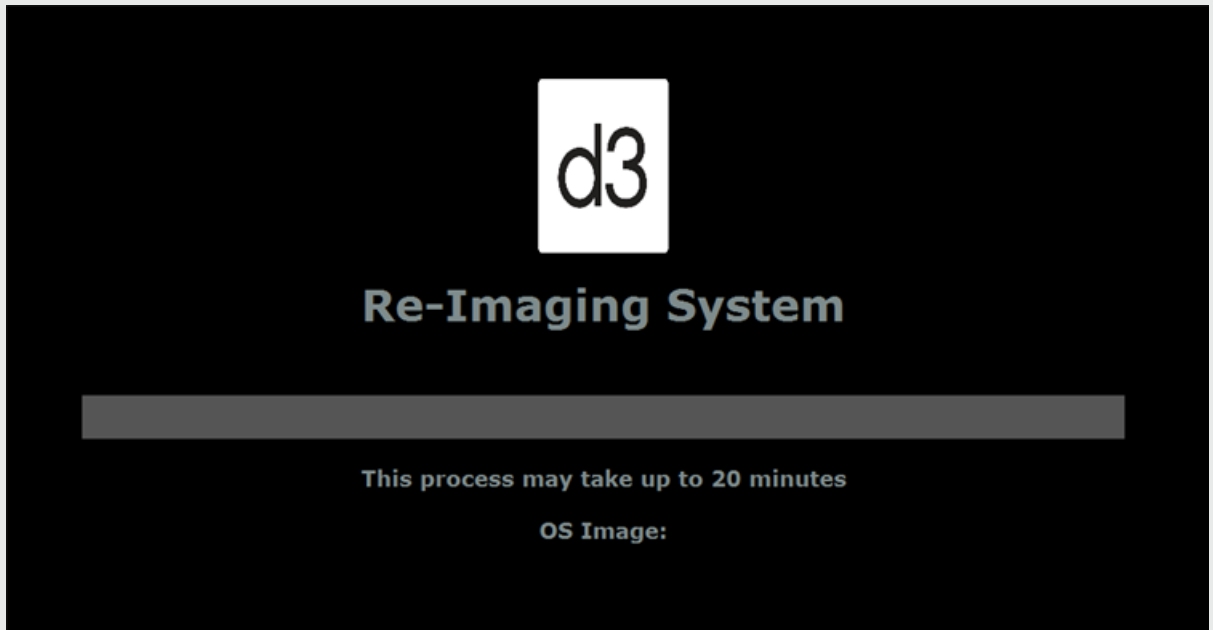

#### Activating windows

Windows should activate automatically, as long as the machine was connected to the internet for the duration of the re-imaging process.

If windows does not activate during the re-imaging process, follow these steps.

1. Wait for a few minutes after the re-imaging process has completed to allow the server time to activate Windows.
-

2. Navigate to the System tab by right clicking on the Windows start menu and selecting **System**

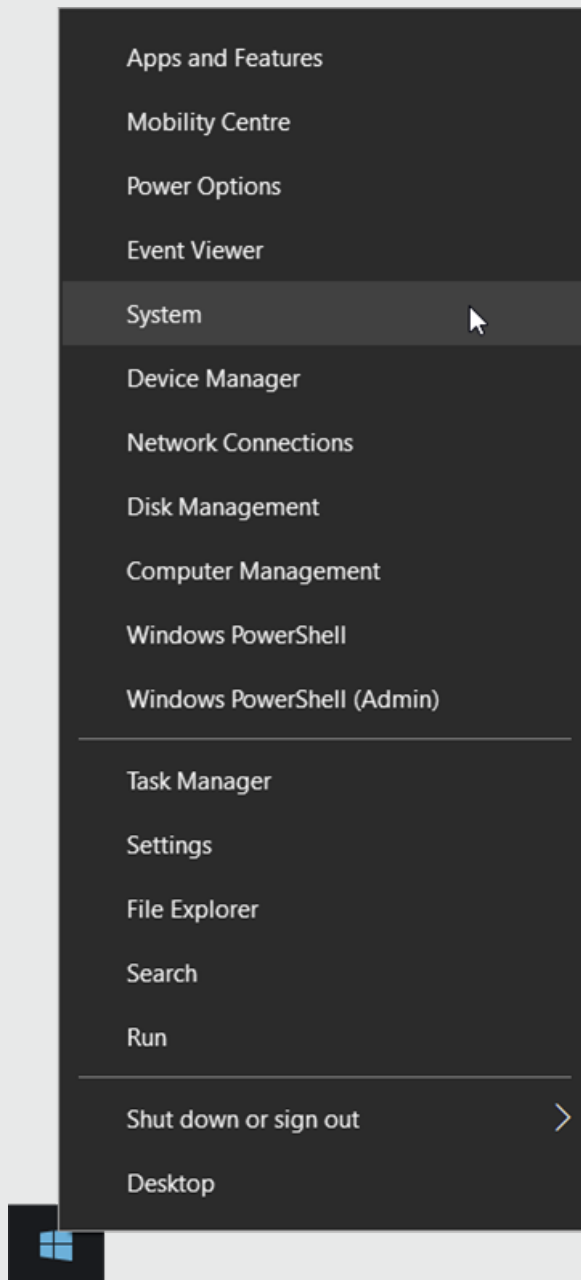

3. In the System window, check to see if you have valid Windows license information visible. If you do not, contact the [disguise support team](#).
-

**Please note:** If you experience any problems during updating or restoring the system, or any of these instructions are unclear, please contact the [support team](#).



**Warning:** The system needs to be connected to the internet during this procedure

The gx range handles updates through the use of installers, which are firmware package that encompass updates from the ground up

This process can be used to update to a newer OS image, or revert to a previous OS image.

To tell what OS image your system is on please go to the **Help** menu in **d3manager** and select **About Manager**.

---

You will need

- A 32Gb USB memory stick
- A version of [Rufus](#) to turn it into a bootable disk. Make sure the volume name of the USB is: "REDISGUISE" as per image
- An internet connection to the machine you are re-imaging
- Download and install a version of [7Zip](#)
- Download and unzip the multi file archive using 7Zip
- OS images can be found [here](#).

**Please note:** You do not need to extract all parts individually. Simply place them in the same directory and then use 7zip to extract the ISO by selecting any part. 7zip will automatically unzip all parts to create the image file.

Create Bootable USB device

1. Download and unzip the multi-file archive using 7Zip (NOTE: you will only need to unzip file 001):

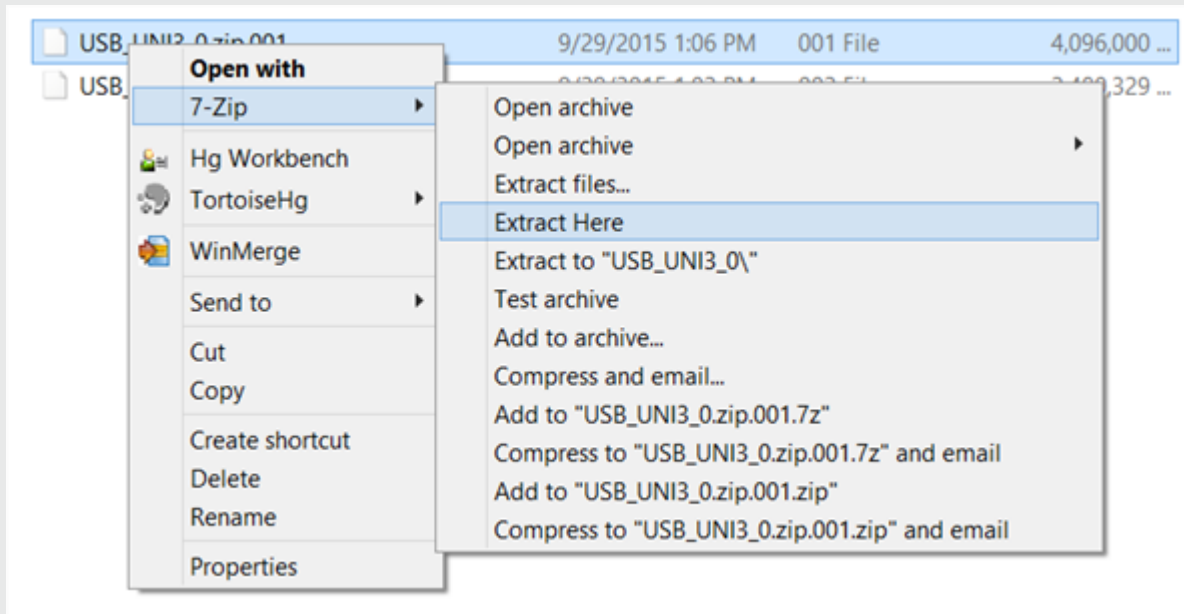

2. Create Bootable USB stick with the unzipped ISO.

The settings should be:

---

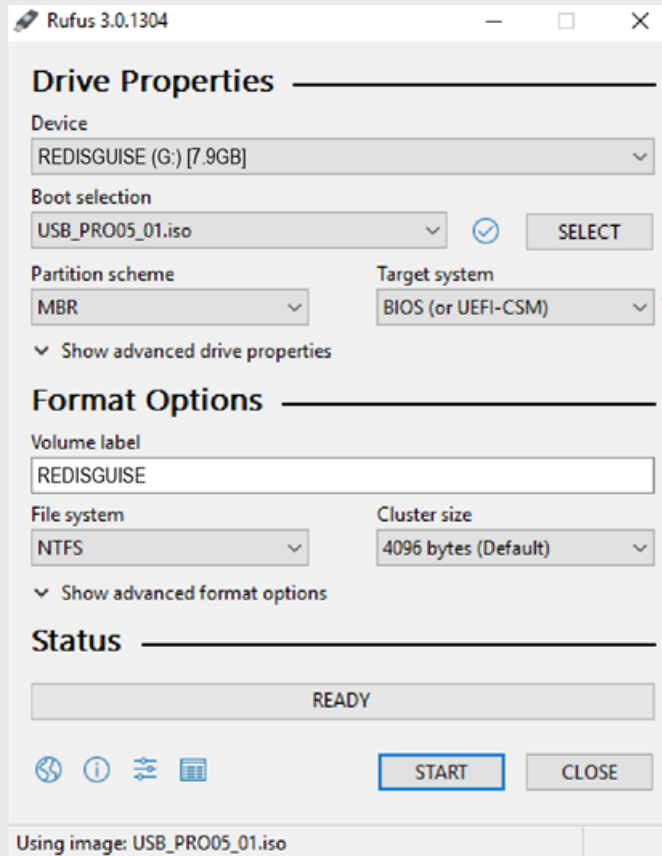

- **Partition scheme** - MBR
- **Target system** - BIOS (or UEFI-CSM)
- **Volume label** - automatically pulled from ISO file
- **File system** - NTFS



**Warning:** These settings are critically important. The re-image process will fail if they are not set correctly.

**Please note:** On the latest versions of Rufus you may see this warning. This is expected and does not apply to current disguise hardware. Please click **OK** to continue as normal.



---

Booting into the USB

1. Enter the UEFI/BIOS by hitting delete on the disguise logo splash screen during boot.
  2. Navigate to the **Boot** tab.
  3. Select **Hard Drive BBS Priorities**.
  4. Change Boot Option #1 to your USB thumb drive (the name will look different depending on the manufacturer of the drive).
  5. Press **ESC** to return to the main section.
  6. Navigate to the **Save & Exit** tab.
-

7. In the “Boot Override” section, select the USB thumb drive that matches the name of your thumb drive. **DO NOT** select the one that starts with UEFI.
  8. The system should now reboot and begin the reimaging process.
  9. Once the copying and installing of the image is complete, the system will reboot automatically. Remove the thumb drive at this point to prevent the system from entering a boot loop.
  10. The OS will now boot and run a script to make changes to the settings of the system and install necessary programs. Wait for this to complete and your system should be reimaged.
- 

**Please note:** performing a system restore from the new disk image will erase any valuable data on your system drive. Please ensure you make a back up of any essential files from your system (C:) drive before initialising this process. The process does NOT destroy any media or projects on your media drive.

## gx 3 Overview

The gx 3 comes pre-installed with the latest software version, enabling you to design, configure and sequence the show on the same machines as you later use for show playback.

For detailed information on the specifications for each machine, as well as the other software and hardware bundles offered by , please see the products section of our [website](#).



# gx 3 diagrams

## Front view of gx 3

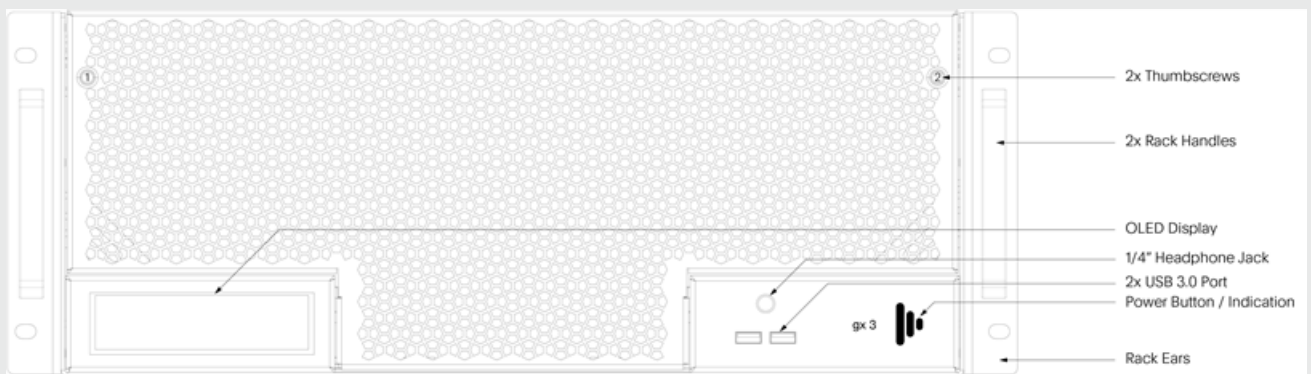

## Front grill down view of gx 3

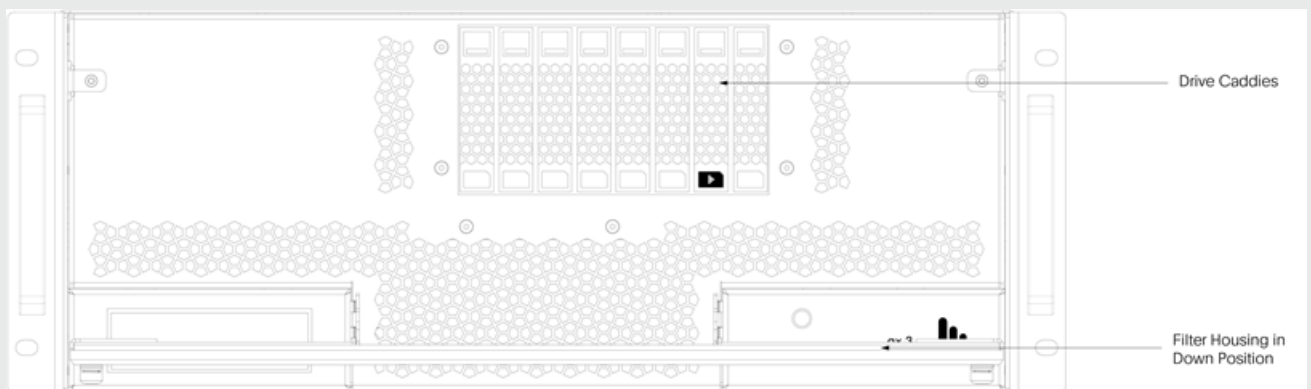

# Rear view of gx 3

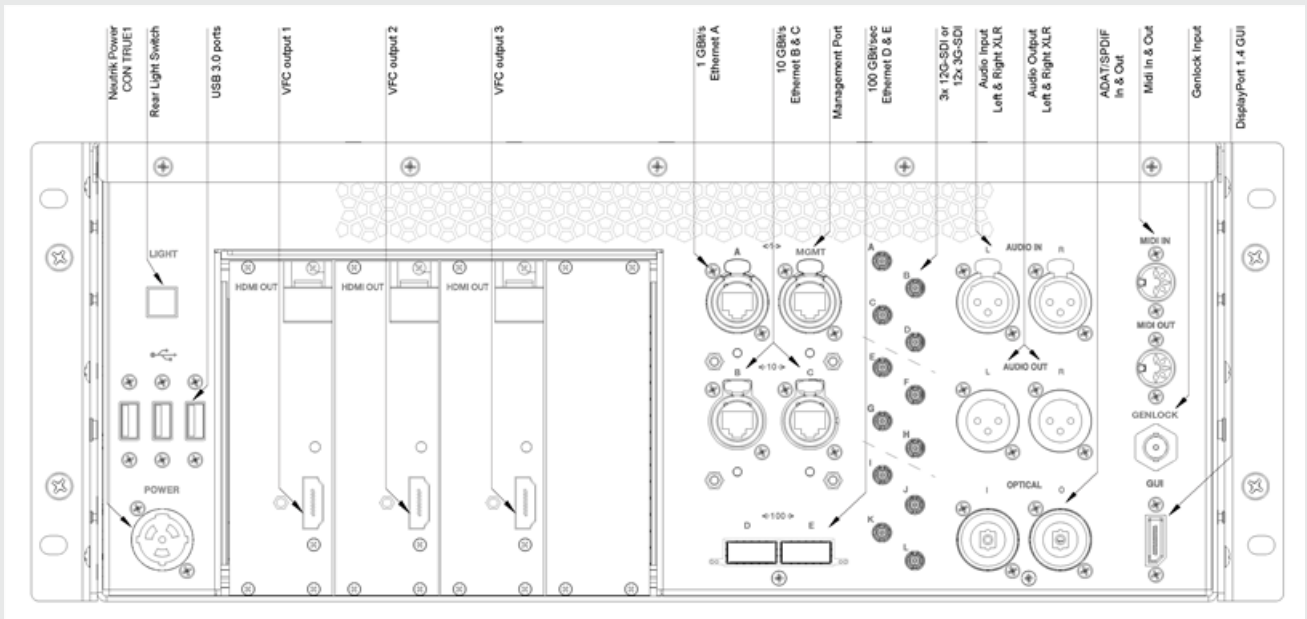

[View the full gx3 specification sheet here.](#)

# gx 3 Specifications

## Specifications

All video standards outlined here have been tested up to the following:

- Bit depth - 10-bit (all modes)
- Chroma subsampling - YCbCr 4:2:2 (all modes)
- Each SDI input supports 3G Level A and Level B when applicable All quadlink formats support either square division or two-sample interleave (2SI) methods.

## 4K DCI (4096 x 2160)

4K DCI 23.98p, 4K DCI 24p, 4K DCI 25p, 4K DCI 29.97p, 4K DCI 30p, 4K DCI 47.952p, 4K DCI 48p, 4K DCI 50p, 4K DCI 59.94p, 4K DCI 60p

## Quadlink 4K DCI (4096 x 2160 using 4x 2048 x 1080 inputs)

4K DCI 47.952p, 4K DCI 48p, 4K DCI 50p, 4K DCI 59.94p, 4K DCI 60p

## UHD (3840 x 2160)

2160p23.98, 2160p24, 2160p25, 2160p29.97, 2160p30, 2160p50, 2160p59.94, 2160p60

## Quadlink UHD (3840 x 2160 using 4x 1920 x 1080 inputs)

2160p50, 2160p59.94, 2160p60

---

## 2K DCI (2048 x 1080)

2K DCI 23.98p, 2K DCI 23.98psf, 2K DCI 24p, 2K DCI 24psf, 2K DCI 25p, 2K DCI 25psf, 2K DCI 29.97p, 2K DCI 29.97psf, 2K DCI 30p, 2K DCI 30psf, 2K DCI 47.952p, 2K DCI 48p, 2K DCI 50p, 2K DCI 59.94p, 2K DCI 60p

## Full HD (1920 x 1080)

1080p23.98, 1080psf23.98, 1080p24, 1080psf24, 1080p25, 1080psf25, 1080p29.97, 1080psf29.97, 1080p30, 1080psf30, 1080p50, 1080i50, 1080p59.94, 1080i59.94, 1080p60, 1080i60

## HD (1280 x 720)

720p25, 720p29.97, 720p30, 720p50, 720p59.94, 720p60

It is possible to have a different format on each input. However, the limitations are a maximum of 3x 2160p60 or 12x 1080p60.

## Hardware

GPU	NVIDIA RTX A6000
CPU	Intel Xeon 3.1Ghz
Memory	96GB RAM (6 x 16GB)
Storage	2x 256GB SDD (internal) 1x 3.84TB Removable NVMe SSD
Voltage	100-240V, 50-60Hz
Power Connection	Neutrik powerCON True1
Power Consumption Peak	700W
Heat Dissipation Peak	2,388 BTU/hr
Max Decibel Rating	56db
OS	2x 256GB SSD

The gx 3 does not contain a RAID controller.

Download the full specifications [here](#)

# gx 3

## Performance

## Playback

Performance specifications listed here outline the maximum amount of video layers that are achievable on a single gx 3. These can fluctuate in future releases.

### Benchmarks - Video Layers (Full HD)

Video Codec	Content Data Rate (MB/s)	Max Layers on gx 3
HAP 30	31	48
HAP 60	62	47
HAPQ 30	61.25	44
HAPQ 60	122.5	24
Animation 30	187.25	16
Animation 60	374.5	8
TIFF Sequence 30	237	12
TIFF Sequence 60	474	6
NotchLC 30	78.375	39
NotchLC 60	156.75	20

## Benchmarks - Video Layers (4k DCI)

Video Codec	Content Data Rate (MB/s)	Max Layers on gx 3
HAP 30	132	24
HAP 60	264	12
HAPQ 30	107 MB/s	12
HAPQ 60	237 MB/s	6
Animation 30	95.4 MB/s	4
Animation 60	143 MB/s	2
TIFF Sequence 30	697 MB/s	3
TIFF Sequence 60	63.51 MB/s	2
NotchLC 30	331.5	9
NotchLC 60	663	5
DPX Sequence, 8-bit, RGB, 30	759	4
DPX Sequence, 8-bit, RGB, 60	1518	2
DPX Sequence, 10-bit, RGB, 30	1011	3
DPX Sequence, 10-bit, RGB, 60	2022	1
TGA Sequence, 8-bit, RGB, 30	759	4
TGA Sequence, 8-bit, RGB, 60	1518	2
TGA Sequence, 10-bit, RGB, 30	1011	3
TGA Sequence, 10-bit, RGB, 60	2022	1
TIFF Sequence, 8-bit, RGB, 30	759	4
TIFF Sequence, 8-bit, RGB, 60	1518	2
TIFF Sequence, 10-bit, RGB, 30	1011	3
TIFF Sequence, 10-bit, RGB, 60	2022	1

NOTES:

- Content is played back at 30 fps and 60 fps as outlined in the video codec above.
- All HD codecs listed above have an output resolution relevant to Full-HD (1920 x 1080).
- All UHD codecs listed above have an output resolution relevant to 4K DCI (4096 x 2160).
- One codec and frame rate tested per track.
- One unique video file per layer.
- One LED screen per resolution tested (Full-HD and DCI 4k)
- The test machine is run as an actor with its GUI disabled.
- Absolute maximum level of performance. One more layer means that the system will start to drop frames.
- Measured against r26, build 164886.

## Capture Latency

The following table provides data on how many frames of latency the gx 3 requires from capture to output:

### gx 3 SDI

Refresh Rate	Normal mode (frames)	Low Latency mode (frames)	Ultra-Low Latency (frames)
60Hz	5	4	3
50Hz	5	4	3
30Hz	5	4	3

### gx 3 NDI

Refresh Rate	Normal mode (frames)	Low Latency mode (frames)	Ultra-Low Latency (frames)
60Hz	6	5	4
50Hz	6	5	4
30Hz	6	5	4



# Video input

Your Disguise system is equipped with capture cards. These cards have the ability to capture live video from either SD-SDI or HD-SDI video sources with up to four unique feeds, or two unique 3G-SDI feeds per machine.

## Max Number of Unique Inputs

	3G-SDI	12G-SDI
gx 3	12	3

## Supported formats

720x486i @59.94 Hz NTSC

720x576i @50.00 Hz PAL

1280x720p @23.976Hz, 24Hz, 25Hz, 29.97Hz, 30Hz, 50Hz, 59.94Hz, 60Hz

1920x1080i @47.96Hz, 48Hz, 50Hz, 59.94Hz, 60Hz

1920x1080PsF @23.976Hz, 24Hz, 25Hz, 29.97Hz, 30Hz

1920x1080p @23.976Hz, 24Hz, 25Hz, 29.97Hz, 30Hz, 47.96Hz, 48Hz, 50Hz, 59.94Hz, 60Hz

2048X1080p @23.976Hz, 24Hz, 25Hz, 29.97Hz, 30Hz, 47.96Hz, 48Hz, 50Hz, 59.94Hz, 60Hz

2048X1080i @47.96Hz, 48Hz, 50Hz, 59.94Hz, 60Hz

2048x1556PsF @14.98Hz, 15Hz, 18.98Hz, 19Hz

4K UHD 3840x2160, 4K P/PsF @23, 24, 25, 29, 30fps

4K DCI 4096x2160, 4K P/PsF, @23, 24, 25, 29, 30fps

It is possible to have a different format on each input, However the limitations are a maximum of 1x 4k or 2x 1080p60.

If you are using 1x 4k or 2x 1080p it is not possible to use any other video inputs on the unit due to hardware limitations.

# Back-Plate Layout



Diagram of Video Capture BNC connections on rear of gx 3.

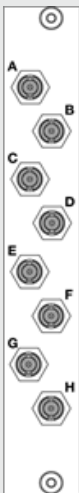

Diagram of Video Capture BNC connections on rear of a gx 3.

**Please note:** Live Video input inherently introduces frame latency during playback. Please contact [Support](#) for guidance on performance standards.

# Unit rear light - gx 3

## Rear panel LED light

disguise Servers in the pro and gx ranges come with the addition of an LED light on the back of the unit that illuminates the connections on the rear panel.

The light can be turned on or off using the switch labeled "light" with power in.

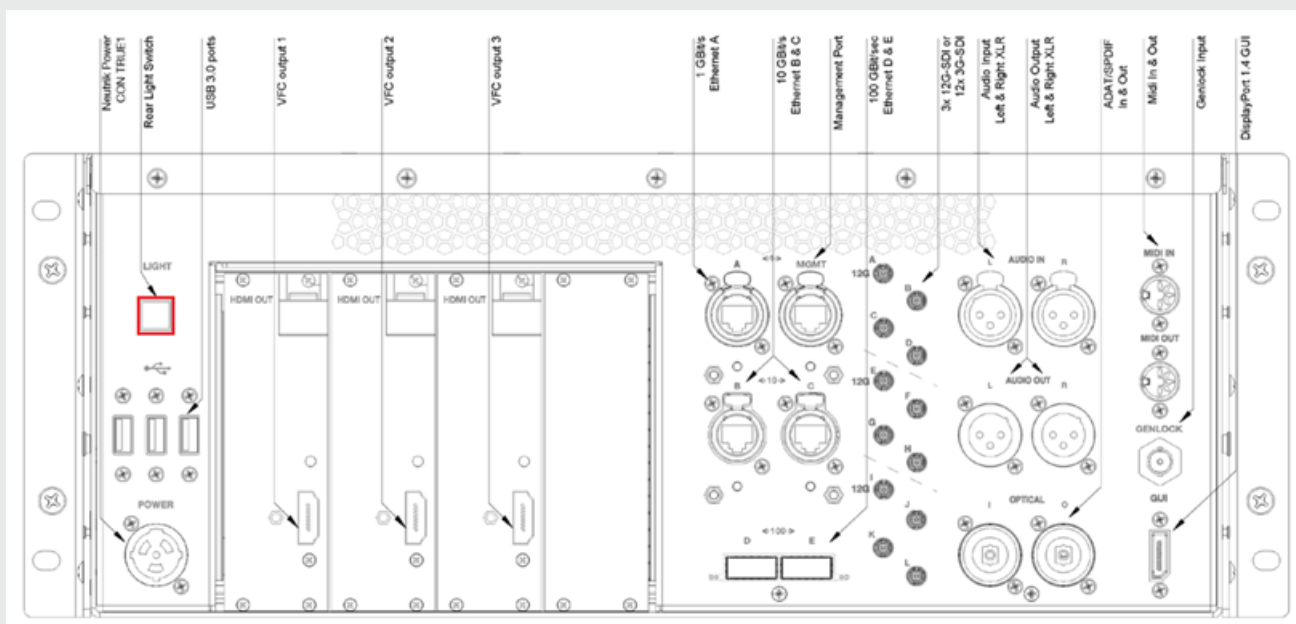

Location of light switch on rear of a gx 3

# Update & restore

Update & restore is the process of doing an update or restore on the system using a bootable USB drive. This process does not affect the media drive.

Please note: If you experience any problems during updating or restoring the system, or any of these instructions are unclear, please contact the [support team](#).



**Warning:** The system needs to be connected to the internet during this procedure

## You will need

- A 16Gb USB memory stick
- A version of [Rufus](#) to turn it into a bootable disk. Make sure the volume name of the usb is: "REDISGUISE".
- An internet connection to the machine you are re-imaging
- Download and install a version of [7Zip](#)
- Download and unzip the multi file archive using 7Zip
- OS images can be found [here](#).

**Please note:** You do not need to extract all parts individually. Simply place them in the same directory and then use 7zip to extract the ISO by selecting any part. 7zip will automatically unzip all parts to create the image file.

## Create a Bootable USB

1. Download and unzip the multi file archive using 7Zip (NOTE: you will only need to unzip file 001):

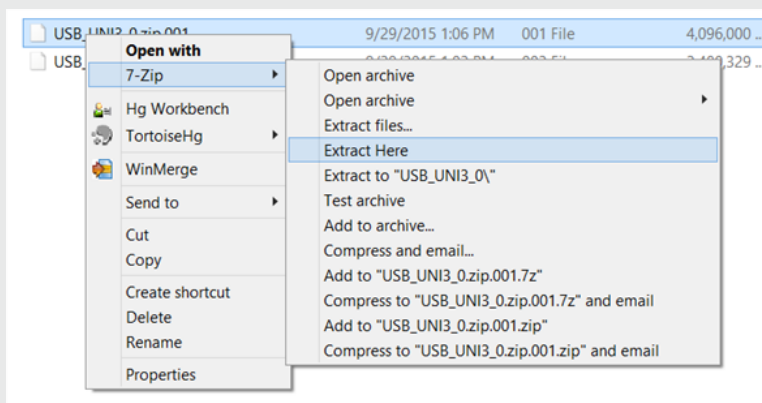

2. Create Bootable USB stick with the unzipped ISO.

The settings should be:

- **Partition scheme** - GPT
- **Target system** - UEFI - non CSM
- **Volume label** - automatically pulled from ISO file
- **File system** - NTFS



**Warning:** These settings are critically important. The re-image process will fail if they are not set correctly.

**Please note:** On the latest versions of Rufus you may see this warning. This is expected and does not apply to current disguise hardware. Please click **OK** to continue as normal.

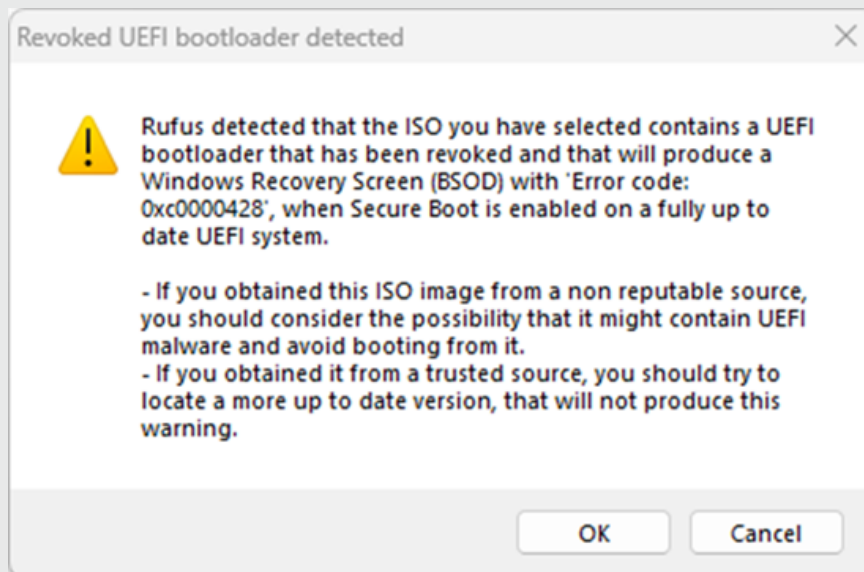

## Booting into the USB

1. Go into the BIOS by hitting Delete on the logo splash screen during boot.
2. Change the Boot option #1 to the USB stick
3. Navigate to the Save & Exit tab. It is just to the right of the Boot tab.
4. In the Boot Override section at the bottom there is a UEFI: USB, Partition 2. This may vary depending on the manufacturer of USB stick in use. Select this option to begin the OS upgrade process.

**Please note:** performing a system restore from the new disk image will erase any valuable data on your system drive. Please ensure you make a back up of any essential files from your

system (C:) drive before initialising this process. The process does NOT destroy any media or projects on your media drive.

# SMC

System Management Controller

## What is System Management Controller - SMC?

SMC is an out-of-band management system that allows for:

**1. Constant and up-to date access to information about the status of the main disguise server it is contained within such as:**

- Power state
- VFC cards currently inserted
- Network adapter details and configuration
- Server session details

**2. Communication with the BMC on the Motherboard allowing for:**

- Turning on and off machines remotely
- Monitoring physical metrics such as power draw and temperature

**To make life easier, all this information is generally available in three different ways:**

- OLED screen on the front of the servers
- Webpage
- REST API

The SMC system is currently present in the following disguise machines:

- vx 1
- vx 2
- vx 4



— vx 4+

— gx 3

## Connecting externally from a different machine

1. Connect to the MGMT port via ethernet
2. Open a browser and navigate to the IP address displayed on the front OLED screen of the server, this should open the web page, if it does not, or the IP does not appear on front screen then see **Troubleshooting**

### User Account Control

To use the website and some of the API endpoints in SMC v3 and above, a user account must be created. This is to protect against unauthorised access to critical machine functions (like turning off a server mid-show)

1. Once navigated to the IP address and the login page is visible, click 'Sign Up'
2. A four digit number will appear on the front screen which will need to be put in the 'Screen Number' field whilst filling out the form. This number will only appear for 30s, click 'Resend Verification' to generate a new number

### Designing into a network infrastructure

Each of the aforementioned disguise servers have a MGMT ethernet port on the back which is solely for access to the SMC system. This can be built into an existing network infrastructure but care should be taken to isolate this network from all others by using VLANs or maintaining a separate physical network. The reasons for this are two-fold:

- Security - Since the SMC system has access to lower-level functionality that bypasses the Windows OS on the servers, this shouldn't be connected to the internet on a permanent basis
- Reliability - One of the main features of the SMC system is to provide out-of-band management

and help configure or change the disguise server - this cannot happen if the network is down or not configured correctly!

## Connecting Internally from same disguise machine

If operating on the disguise server itself, the process is exactly the same as Connecting Externally, except the IP address is always **172.31.250.9**

## Functionality

### Front OLED Screen

The front OLED screen displays data that is organised into pages that are in a table-based format. In SMC v2 and v3, the only available pages are default information and VFC card information. From v4 onwards there will be a selection of different pages that can be displayed which the user can configure at any time from the webpage and REST API.

## Default Page

### Field Name-Description (Example)

- **Machine**-The model of the disguise server (vx 4)
- **Name** - The name of the disguise server (vx-44150)
- **Role** - The role of the machine set by d3 net manager (understudy)
- **MGMT IP** - The status of the SMC MGMT IP:  
  
**Link Down** -Physical layer is down (something is unplugged or disabled)

### Assigning IP...

**ip address**

## VFC Page

This page displays information about the currently installed VFCs. If the disguise server is powered off then this information may be out of date. (This can only be a 'left' page)

**Slot** - Which slot the VFC card is installed in (left-most looking at the rear is slot 1 (1))

**Card** - The type of VFC card installed in the slot (HDMI)

## Network Config Page

This page displays information about the network adapters in the disguise server

**Name** - The name of the interface set in Windows (A - d3net 1Gbit)

**IP** - The IPv4 address of the interface (10.0.0.34)

## System Temps

This page displays the readings of temperature sensors in the system

**Name** - The IPMI component name (CPU0\_TMP)

**Temp** - Temperature sensor reading in degrees Celsius (42 C)

## System Status

This page displays the readings of temperature sensors in the system

**Name** - The name of the status (System Power)

**Status** - The value of the status (On)

## Webpage

- Most user-friendly method of controlling SMC functionality
- Only place to create an account (see User Account Control)
- See Connecting Externally/Internally for access details

- Some features may be available in the REST API before the webpage
- The current page updates every 10 - 15 seconds to ensure that all data is up to date

## Status Page

Main (index) page - account creation required to access.

## Network Servers

This section displays all the other SMC servers that can be found on the same subnet.

Clicking on a row will navigate to that machine's management page.

## Stats Page

Gathers all sensor and important status messages from the IPMI system. This page self-updates every 10-15 seconds. System statistics such as temperature, voltage and fan speeds are recorded.

## Remora Page

Contains details about the Remora system present in the disguise server such as firmware and hardware version as well the current MGMT IP. Also provides an ease of access link to the update page.

## REST API

- Features and new status information tend to appear here first
- Navigate to **ip.address/api** to access the example page and view what features are available
- Can use any http client to send requests to the API (curl, python etc)
- Generally any request that involves getting information will not require authentication, anything that modifies the state will require basic authentication tokens (log in on the example API page)

# Install an update

1. Navigate to **ip.address:9998** in a browser and a SWUpdate landing page should appear
2. Download the most recent update to install from the link at the top of this page
  - a. It is **NOT** recommended to install an older version than currently installed
  - b. Currently installed version can be found by entering **ip.address/api/remora** into the browser, the current version will be listed as 'Firmware Version'
3. Drag and drop the .swu file to the window and the update will start - a progress bar will also appear on the front screen
4. Once updated the SMC system will restart - this will not affect the operation of the main disguise server in any way

# Troubleshooting

## How to start SMC

Without removing power from disguise server:

- Navigate to Install an update page - ip.address:9998
- Click 'Restart System' on top navigation bar of the page
- If the reboot method above does not work then perform a cold boot

## Front screen is blank/ jumbled data/ frozen

- Follow 'How to restart SMC' to restart the system and see if the screen starts working again
- If the screen is not fixed try to install an update (either the same or newer version if available)
- There is a known issue which happens when a new version of remora is replaced with v0.12 during a server reimage or similar process. This will cause the screen to freeze or be blank and the system will possibly be uncontactable through the normal channels. See *Fixing Backdated Version Issue* below for details on fix

- If the screen is still frozen or not working after trying BOTH of the restart methods then contact support

### **MGMT IP stuck on Link Down**

This means that there is a problem with the physical network connection

- Check all cables are plugged in correctly and functional
- Check that any network infrastructure such as switches are powered on and connected
- Check that connected network cards are enabled

### **MGMT IP stuck on Assigning IP**

Generally means that the physical layer is operating correctly but there are problems in the network stack configuration

- Check that the network is on the correct subnet: If the IP is of type 169.254 then link-local so subnet is 255.255.0.0
- If connected to DHCP server then check this can 'see' the SMC system
- If connected directly to a windows computer, install Bonjour and/or give the NIC an IP in the correct subnet. (Link-local addressing on the SMC side should sort out any address conflicts)

### **MGMT IP assigned but still can't connect**

- If connected straight to a windows computer, install Bonjour and/or give the NIC an IP in the correct subnet. (Link-local addressing on the SMC side should sort out any address conflicts)
- If connected to DHCP server then check this can 'see' the SMC system
- Try accessing the SMC webpage via the disguise server itself (see Connecting Internally)
- If all else fails try restarting SMC both ways

### **Fixing Backdated Version Issue (vx4 only)**

1. Connect the MGMT port to any of the other ports on the server
2. Open Chrome and try the following IP addresses to open the update page, if they do not work proceed with further steps  
172.31.250.9:9998  
10.0.0.102:9998
3. Set the connected port to DHCP (Obtain address automatically)
4. Install Wireshark
5. Point Wireshark at the port connected to the MGMT port
6. In Windows, disable the connected port
7. Accept the Wireshark notifications telling you that it's not connected
8. Re-enable the port
9. Look for ARP packets from a device named RASPBERR (The internal raspberry pi) in Wireshark
10. These packets should contain the IP that the remora system is self-assigning
11. Open chrome and type in the IP found PLUS port 9998 (for example, 169.254.123.145:9998)
12. This will open the Remora update page
13. Drag the latest Remora update into the browser (can be found at top of page)
14. Allow update to happen
15. Remove the cable between MGMT and other port
16. Restart d3service

# Common Operations - gx range



**Warning: Opening hardware may void your warranty. Consult Disguise support before opening the hardware.**



**Warning: do not open or remove the case unless you are instructed to do so by a certified Disguise Engineer**

**Please note: If you experience any problems with hardware please contact the [support team](#)**

## Common Operations

These operations are common to all servers in the gx range:

- [4K Output](#)
- [DisplayPort adapters](#)
- [How to start the gx](#)
- [Unit Rear light](#)
- [Powering the gx](#)
- [Internal restore](#)
- [Redisguise](#)
- [Audio Input and Output](#)
- [SMC \(gx 3\)](#)
- [Background removal guidance](#)



# Powering the gx range

## Power input

The pro and gx ranges of disguise servers use Neutrik powerCON TRUE1 as the power input.

The TRUE1 is:

- Lockable
- Live-Mating (safely)
- Extendable
- Dust and water resistant according to IP65 in mated condition

## Cabling

To power a server, you should use a cable with the following attributes:

- SJT flexible cord, min. 12AWG, min. 300V, min. 60v dm;C, max 4.5 m long
- One end terminated with NEMA 5-15P/BS 1363/CEE 7 plug
- Other end terminated with appliance coupler type Neutrik AG, type NAC3FX

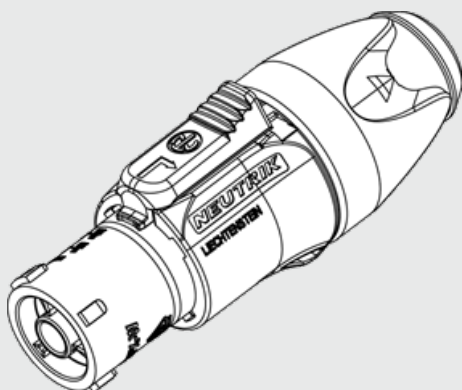

*Neutrik powerCON TRUE1 connector*

# How to start the unit

## Starting the Unit

1. Connect Power cord to the gx server.
2. Make sure you have connected a keyboard, mouse and monitor to the primary graphics output.
3. Press the power button on the front of the unit and wait for the system to load into Windows.

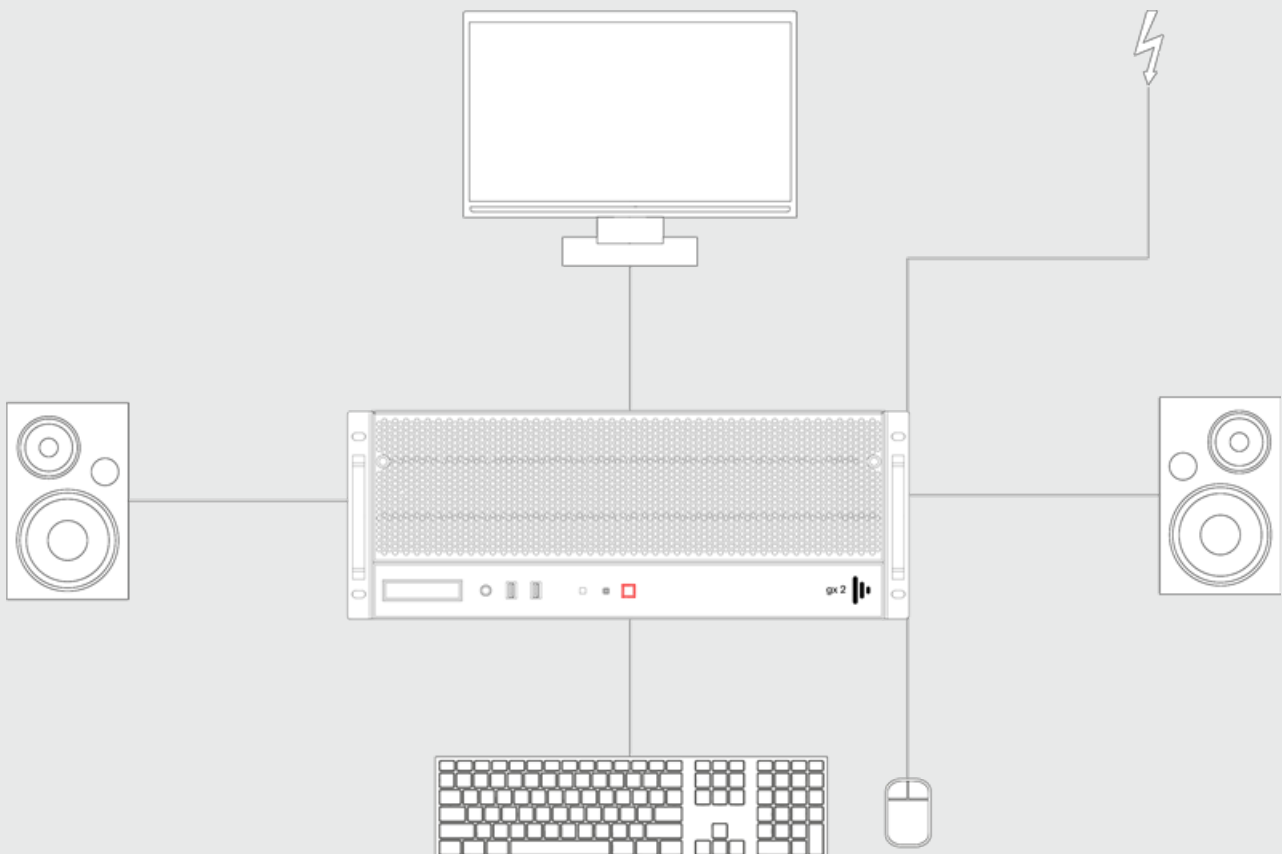

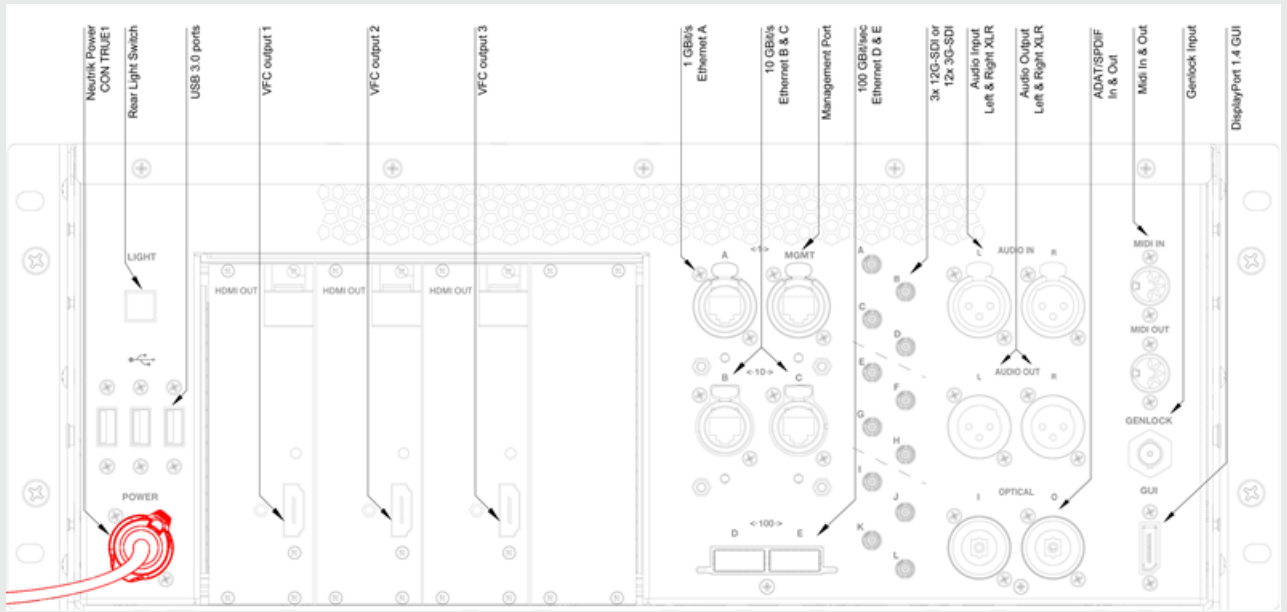

# Audio input and output

The gx 3 is equipped with a broadcast quality pro audio card which uses the latest 192kHz AD and DA converters.

## Back panel connections

- XLR Left + Right Input
- XLR Left + Right Output
- ADAT/SPDIF Input
- ADAT/SPDIF Output
- MIDI Input
- MIDI Output

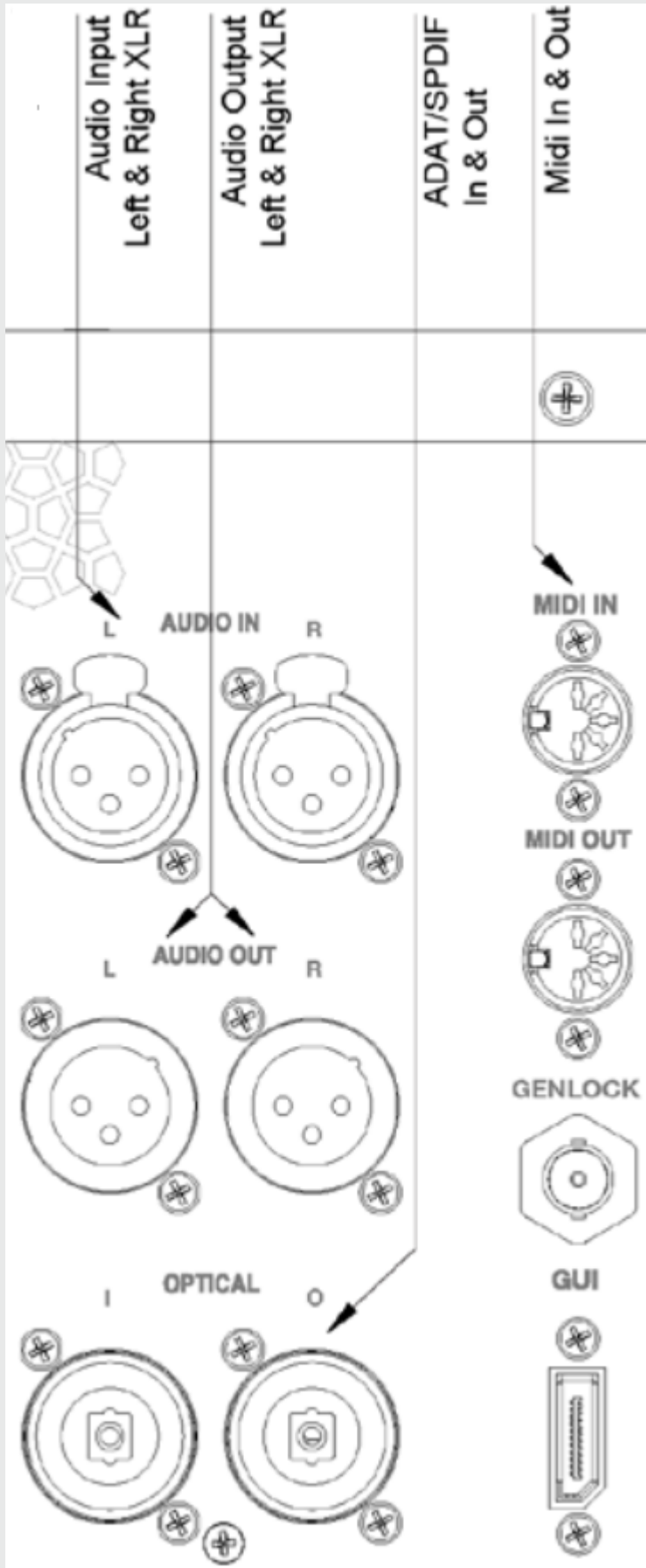

Audio connections on rear of the gx 3

## Front panel connections

- 1/4inch Stereo Monitoring socket

It is possible to monitor audio output from the unit from the 1/4inch stereo socket with a pair of headphones.

# Managing EDIDs

## Emulating EDIDs

1. Navigate to the "View system topology" tab

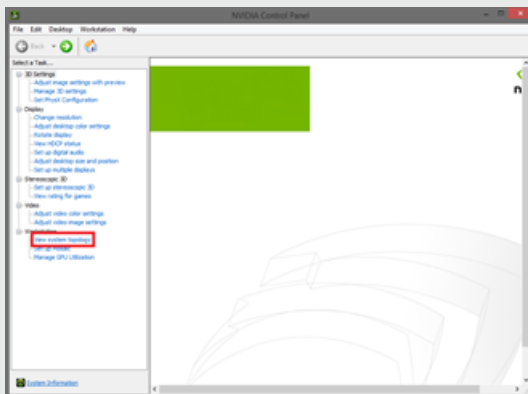

2. Click the EDID button next to a card connection (DVI or DisplayPort)

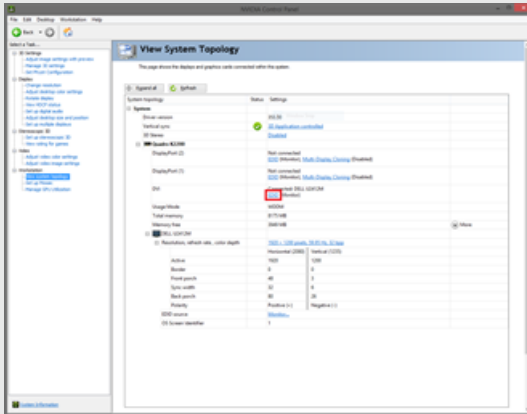

3. Navigate to the "Load" tab inside the Manage EDID window

4. Browse to your preferred EDID and select which display connections you want to emulate the EDID on.

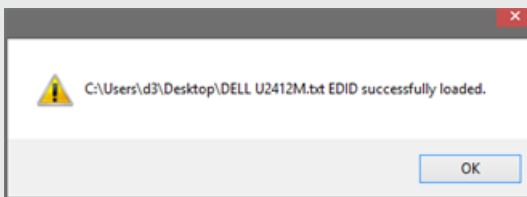
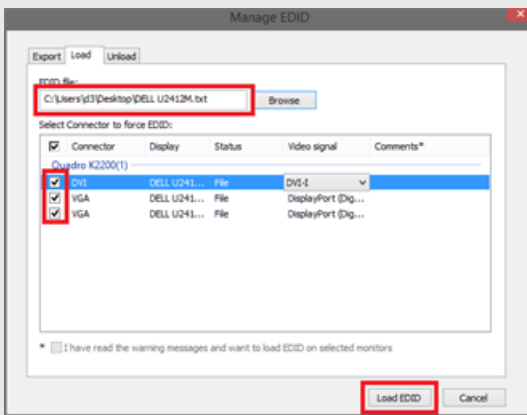



- After the EDID is successfully applied you will see this  small icon which indicates that the display connection has an emulated EDID associated with it.

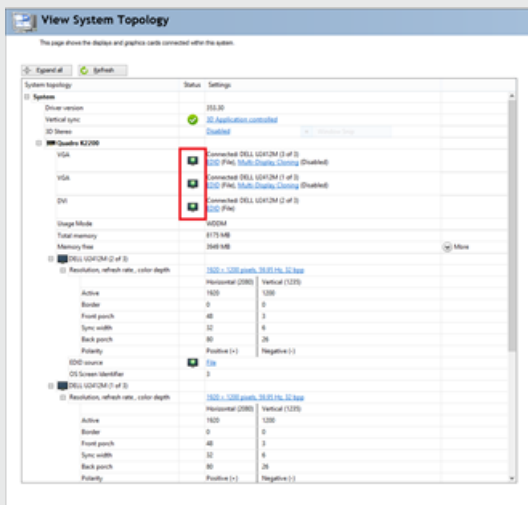

## Exporting EDIDs

- Navigate to the "View system topology" tab

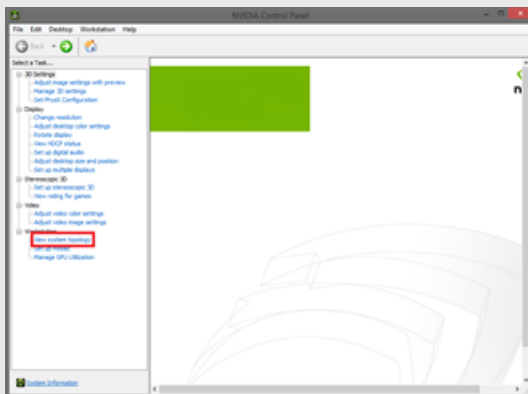

2. Click the EDID button next to a card connection (DVI or DisplayPort)

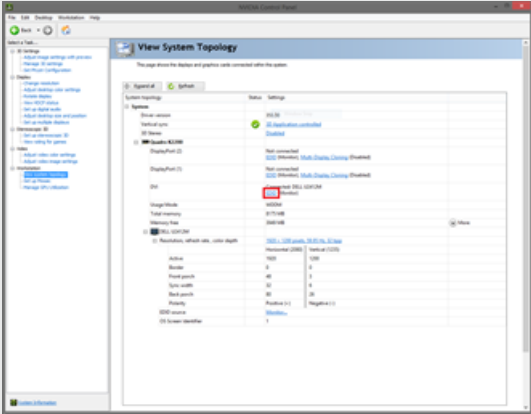

3. Export your preferred EDID to the desktop or documents folder

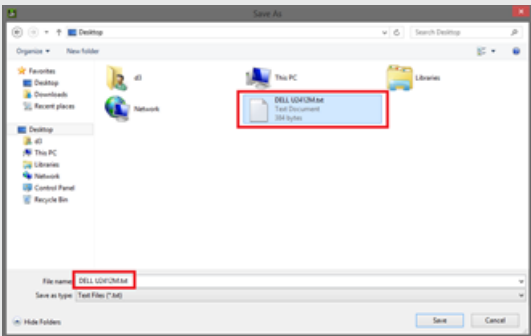
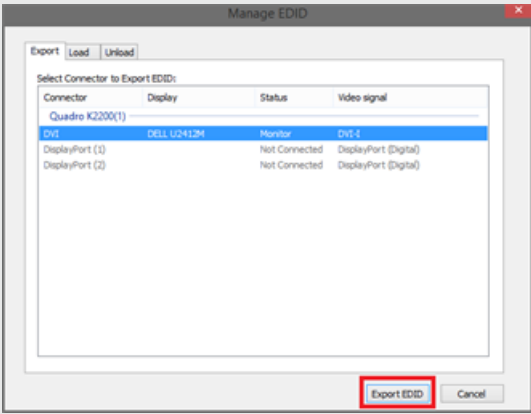

# Resetting EDIDs

EDIDs on all outputs of all connected VFC cards can be reset to a neutral state easily using the keyboard shortcut FFS (Four Finger Salute) as follows:

- Hold CTRL + ALT + SHIFT + F12
- disguise will display several status messages on the screen during the reset process; please wait until reset process has completed before continuing

# Video output

The pro and gx ranges of disguise servers come with a range of possible output configurations. It is possible to use a combination of any of the types of four VFC cards below.

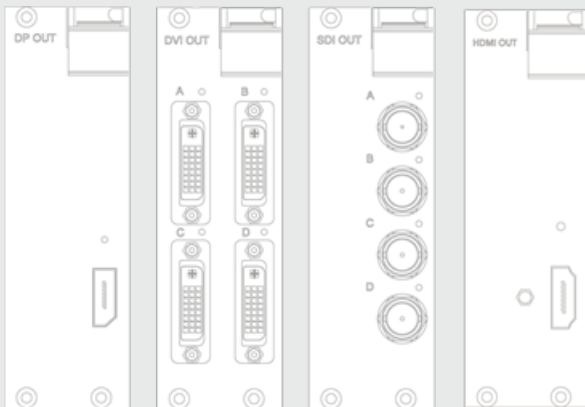

<b>Display Port 1.2</b>	<b>Quad DVI</b>	<b>Quad SDI</b>	<b>HDMI</b>
-------------------------	-----------------	-----------------	-------------

1 Output per card	4 Outputs per card	4 Outputs per card	1 Output per card
Max res: 4096x2160	Single Link DVI: (up to) 1920 x 1200	Max res: 1920 x 1080	Max res: 4096x2160 @60 YCbCr444 8bit 3840x2160 @60 YCbCr422 10bit* 3840x2160 @30 YCbCr444 10bit
LED indicator	LED indicator	LED indicator	LED indicator
Genlocked	All outputs genlocked	All outputs genlocked	Genlocked

# Pro range overview

## Play huge video content

We created the pro range with one mission in mind: to play huge video content across massive canvases, in the toughest of live environments.

Drive large shows with fewer servers, reducing space, time, setup, risk, and management overhead. Every feature of the pro range is focused on delivering the smoothest possible video playback experience.

[vx 4+ product page](#)

[vx 4 product page](#)

[vx 2 product page](#)

[vx 1 product page](#)

# vx 1 Overview



The vx 1 comes pre-installed with the latest software version, enabling you to design, configure and sequence the show on the same machines as you later use for show playback.

For detailed information on the specifications for the vx 1 as well as the other software and hardware bundles offered by Disguise, please visit [this link](#).



**Warning:** Opening hardware may void your warranty. Consult Disguise support before opening the hardware.



**Warning:** do not open or remove the case unless you are instructed to do so by a certified Disguise Engineer

**Please note:** If you experience any problems with hardware please contact the [support team](#)

# vx 1 diagrams

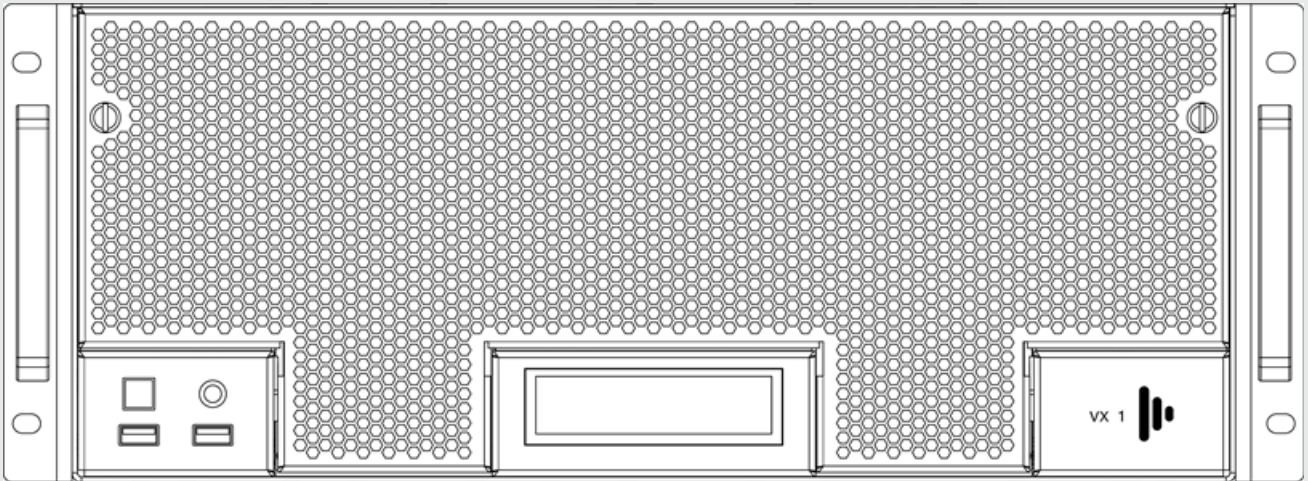

vx 1 front panel

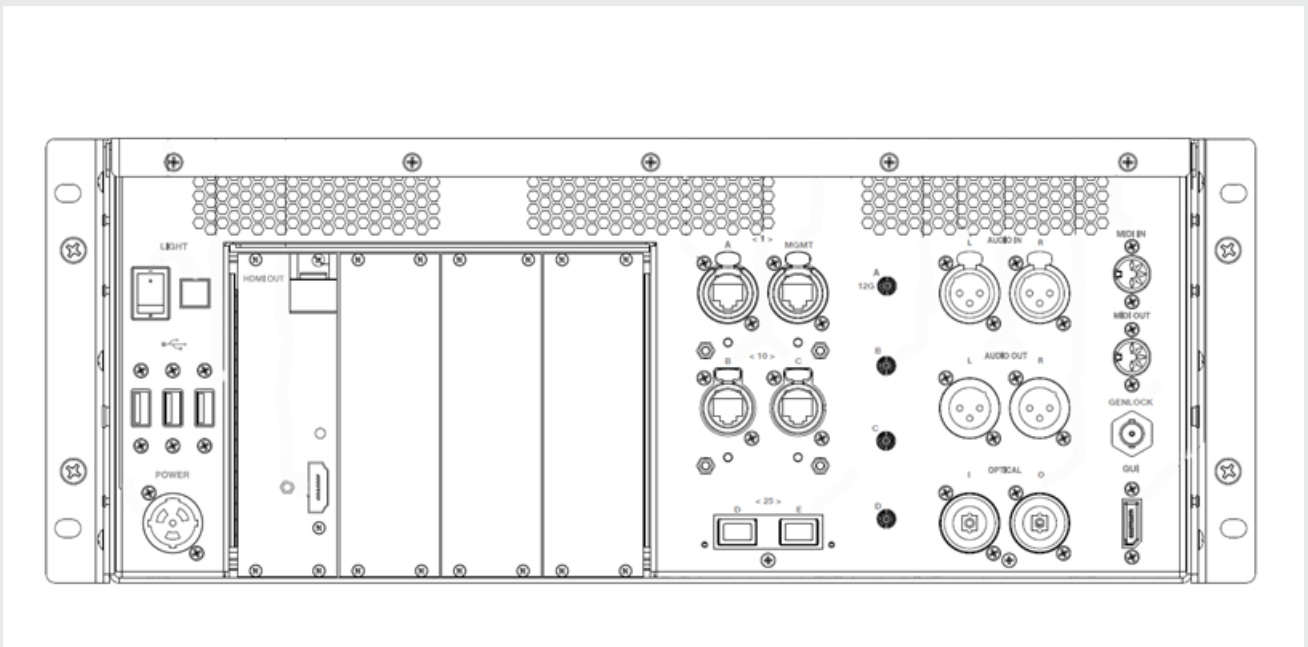

vx 1 rear panel

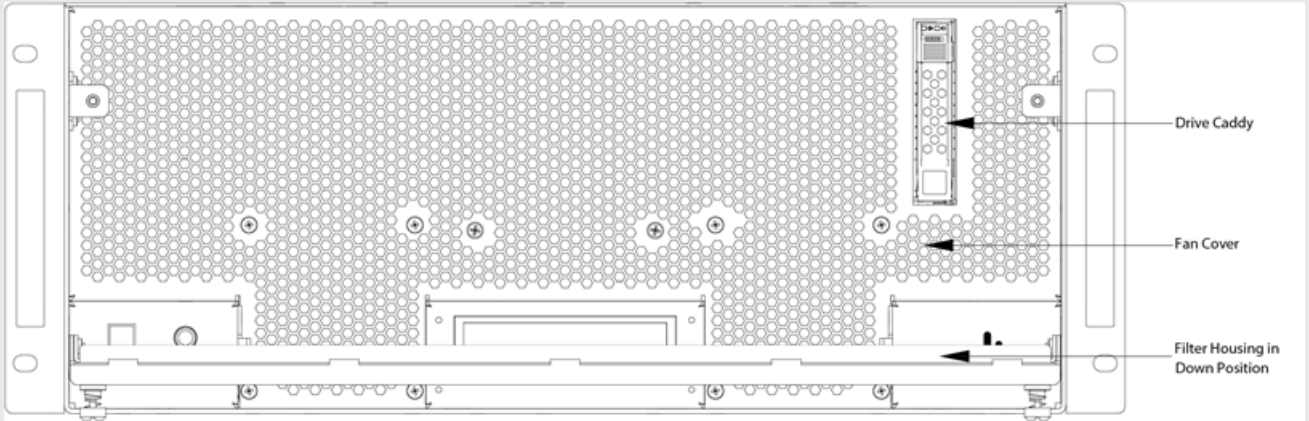

vx 1 front panel grill down

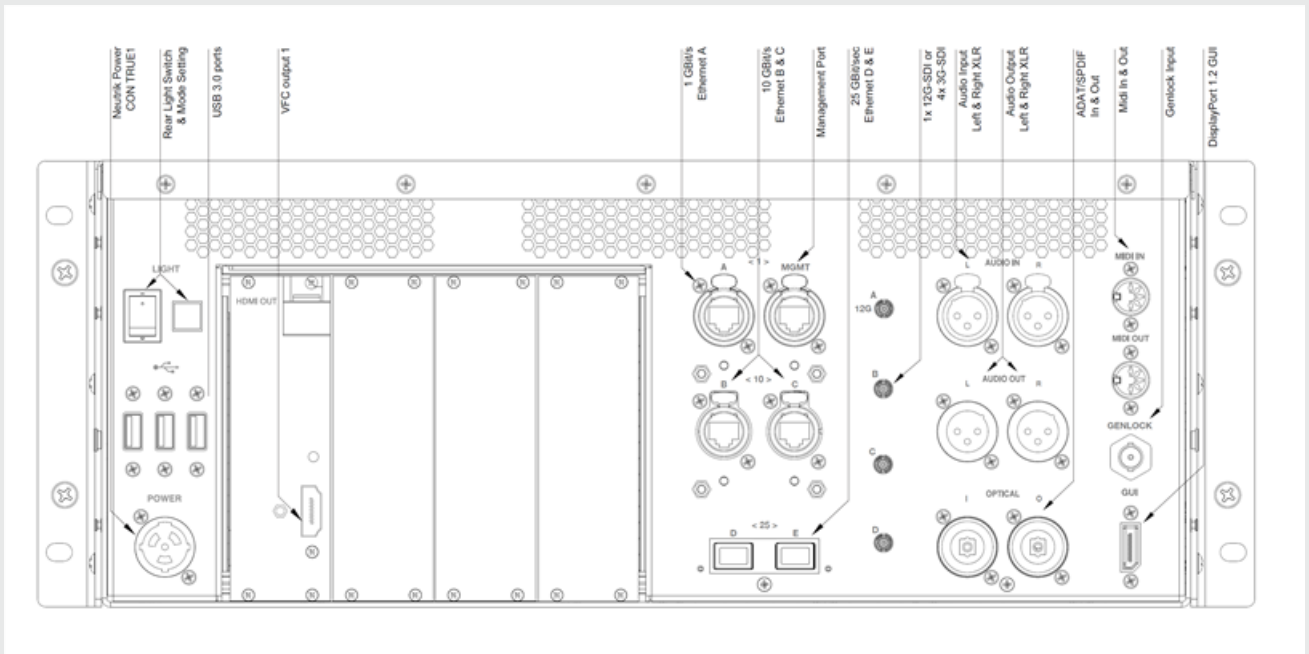

vx 1 rear panel annotated



# Hard drive configuration - vx 1



**Warning:** Do not remove drives when the machine is on as data may be corrupted if this occurs.

**Please note:** If you ever need to replace or exchange your media drive it is recommended that you use a drive with similar read/write speeds. For further information please contact the [support team](#).

## Media Drives

The vx 1 comes with 1x NVMe drive.

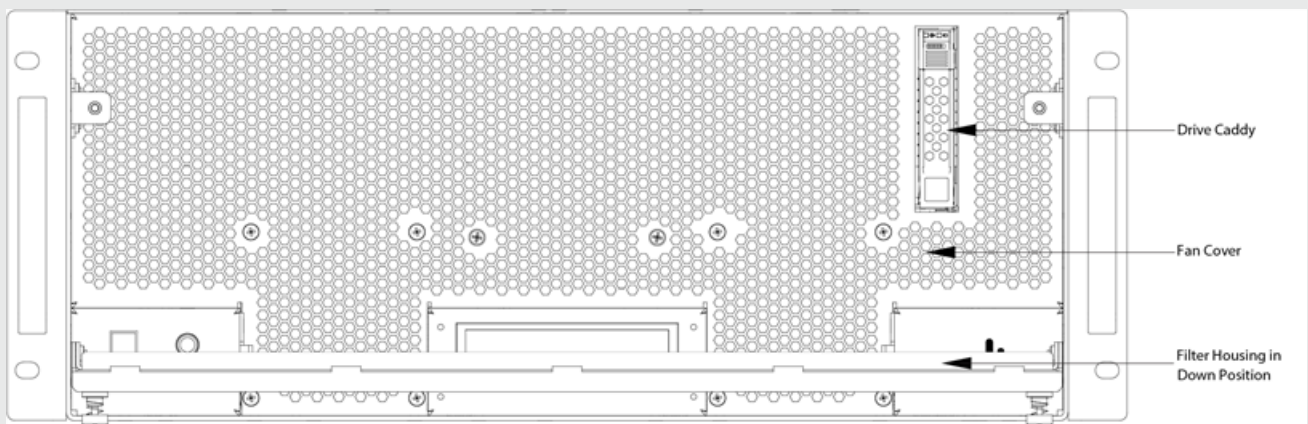

*Location of drive bay on the vx 1 unit.*

# vx 1 Video input

Your vx 1 system is equipped with a capture card. This card has the ability to capture live video from the following input types.

## Max Number of Unique Inputs

	3G-SDI	12G-SDI
vx 1	4	1

## Supported formats

Resolution	Format	Hz
625i (PAL)	interlaced	50.00
525i (NTSC)	interlaced	59.94
1280x720	progressive	23.98, 24, 25, 29.97, 30, 50, 59.94, 60
1920x1080	progressive	23.98, 24, 25, 29.97, 30, 50, 59.94, 60
1920x1080	interlaced	50, 59.94, 60
1920x1080	PsF (Progressive segmented Frame)	23.98, 24, 25, 29.97, 30
1920x1080	A/B	50, 59.94, 60
2048X1080	progressive	23.98, 24, 25, 29.97, 30, 47.952, 48, 50, 59.94, 60
2048x1080	PsF	23.98, 24, 25, 29.97, 30
3840x2160 or 4096x2160	progressive, 8 or 10bit, 2 Sample Interleave or Square Division	23.98, 24, 25, 29.97, 30, 50, 59.94, 60

## Back-Plate Layout



*Diagram of Video Capture BNC connections on rear of unit*

**Please note:** Live Video input inherently introduces frame latency during playback. Please contact [Support](#) for guidance on performance standards.

# Redisguise vx

The process for reimaging a vx server from a USB drive.

The reimaging process we refer to as **Redisguise** is the process of performing an update or restore on the system using a bootable USB drive. This process does not affect the media drive.

**Please note:** If you experience any problems during updating or restoring the system, or any of these instructions are unclear, please contact the [support team](#).



**Warning:** The system needs to be connected to the internet during this procedure

This process can be used to update to a newer OS image, or revert to a previous OS image.

To tell what OS image your system is on please go to the **Help** menu in **d3manager** and select **About Manager**.

If you are updating from an OS earlier than **3.0** your system will do a cold reboot as it performs firmware level updates to some of the components. Please don't be alarmed, just switch the system back on again using the power button

## You will need

- A 32Gb USB memory stick
- A version of [Rufus](#) to turn it into a bootable disk. Make sure the volume name of the usb is: "REDISGUISE" as per image
- An internet connection to the machine you are re-imaging
- Download and install a version of [7Zip](#)
- Download and unzip the multi file archive using 7Zip
- OS images can be found [here](#).

**Please note:** You do not need to extract all parts individually. Simply place them in the same directory and then use 7zip to extract the ISO by selecting any part. 7zip will automatically unzip all parts to create the image file.

## Create Bootable USB device

1. Download and unzip the multi file archive using 7Zip (NOTE: you will only need to unzip file 001):

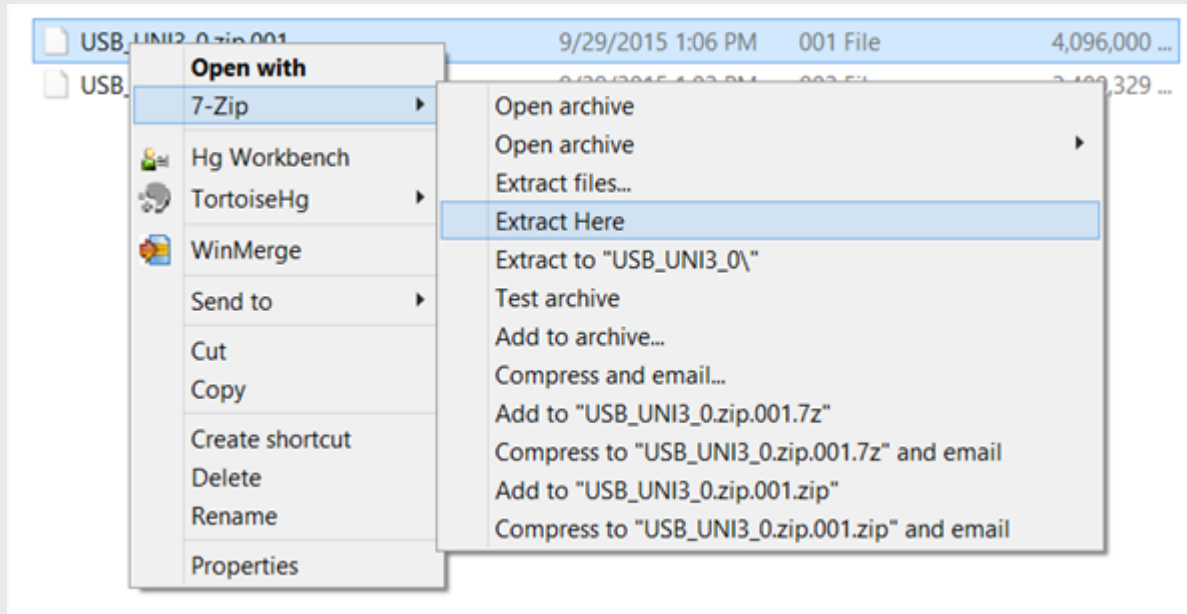

2. Create Bootable USB stick with the unzipped ISO.

The settings should be:

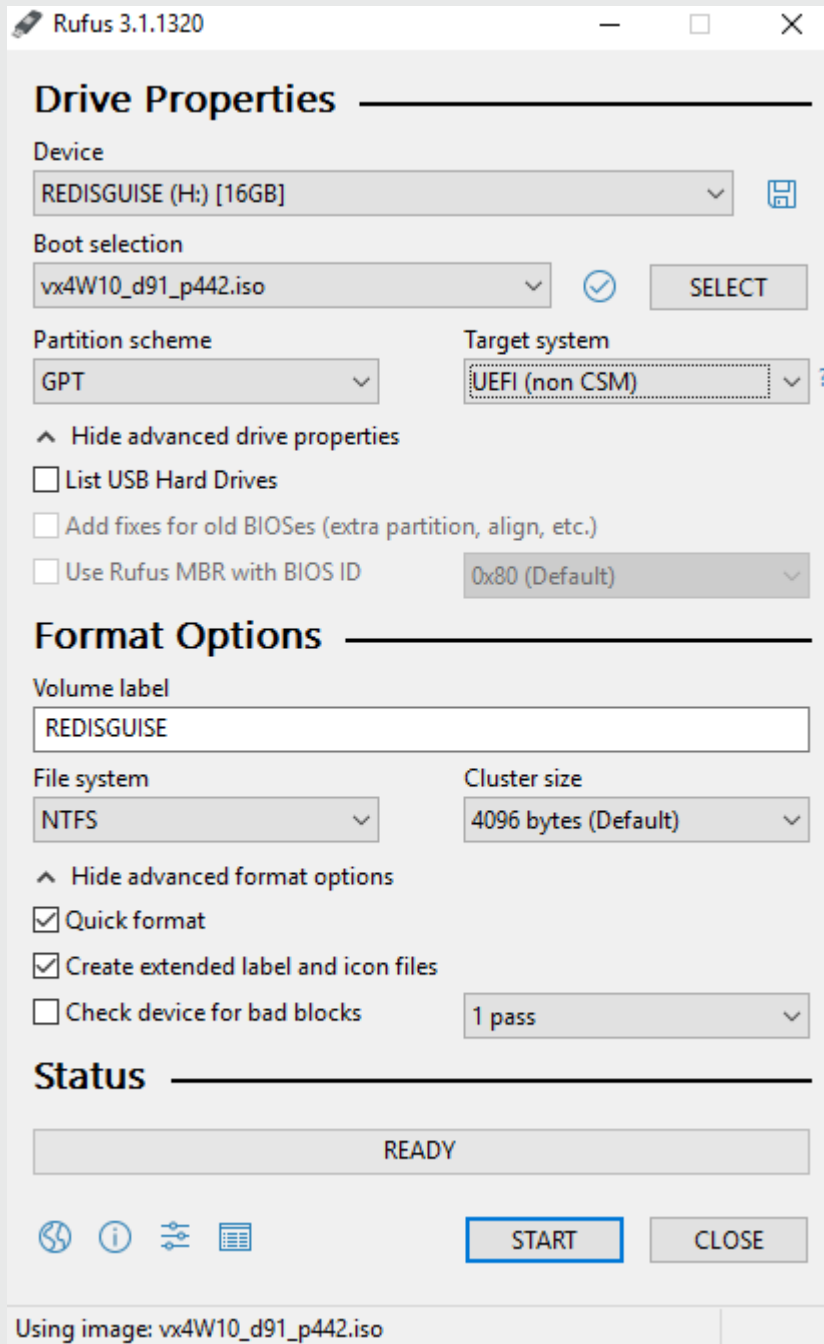

- **Partition scheme** - GPT (vx range)
- **Target system** - UEFI - non CSM
- **Volume label** - automatically pulled from ISO file
- **File system** - NTFS



**Warning:** These settings are critically important. The re-image process will fail if they are not set correctly.

## Booting into the USB

1. Go into the BIOS by hitting Delete on the logo splash screen during boot.
2. Change the Boot option #1 to the USB stick
3. Navigate to the Advanced tab and press enter to view the CSM Configuration and ensure that Boot option filter is set to [UEFI and Legacy]. Change it if it is not, then press F4, confirm and re-enter BIOS.
4. Once this setting is confirmed, navigate to the Save & Exit tab. It is just to the right of the Boot tab.
5. In the Boot Override section at the bottom there is a UEFI: USB, Partition 2. This may vary depending on the manufacturer of USB stick in use. Select this option to begin the OS upgrade process.

**Please note:** performing a system restore from the new disk image will erase any valuable data on your system drive. Please ensure you make a back up of any essential files from your system (C:) drive before initialising this process. The process does NOT destroy any media or projects on your media drive.



## vx 2 overview

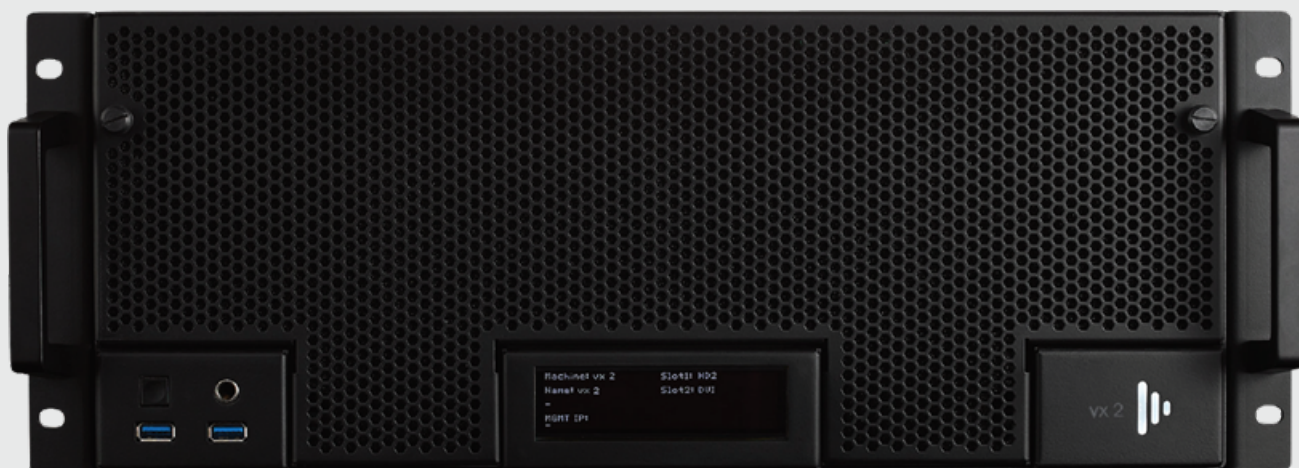

The vx 2 comes pre-installed with the latest software version, enabling you to design, configure and sequence the show on the same machines as you later use for show playback.

For detailed information on the specifications for the vx 1 as well as the other software and hardware bundles offered by Disguise, please visit [this link](#).



**Warning:** Opening hardware may void your warranty. Consult Disguise support before opening the hardware.



**Warning:** do not open or remove the case unless you are instructed to do so by a certified Disguise Engineer

**Please note:** If you experience any problems with hardware please contact the [support team](#)

# vx 2 diagrams

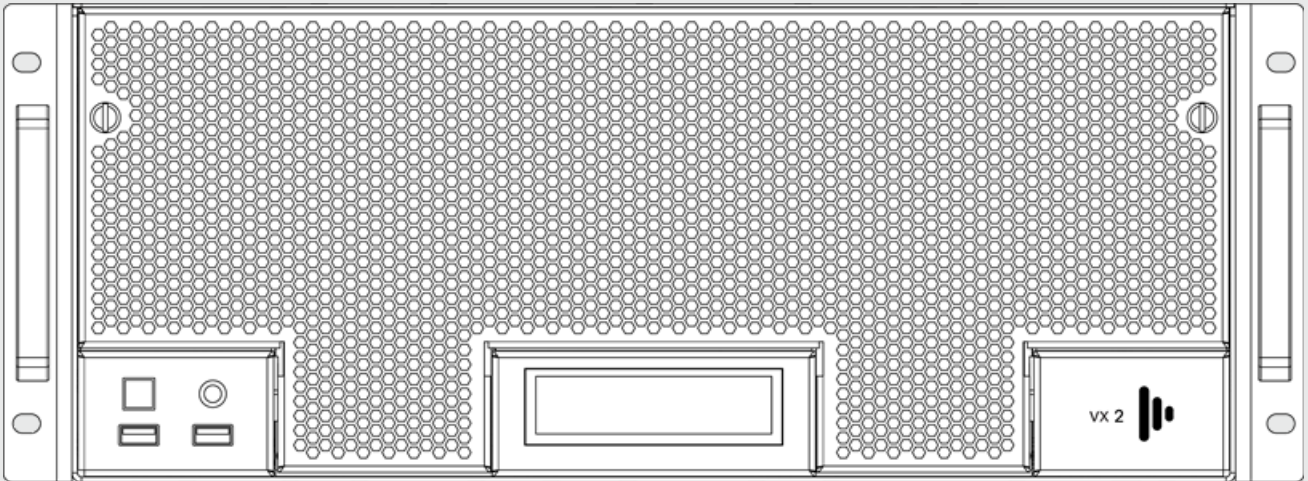

vx 2 front panel

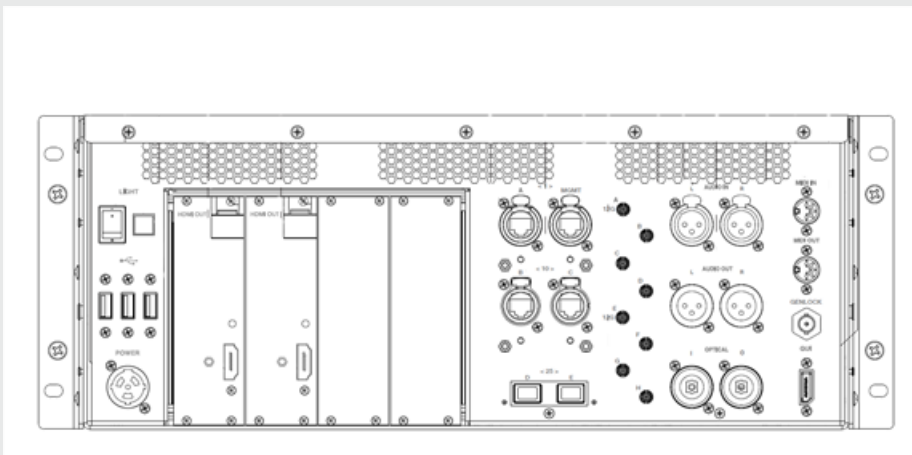

vx 2 rear panel

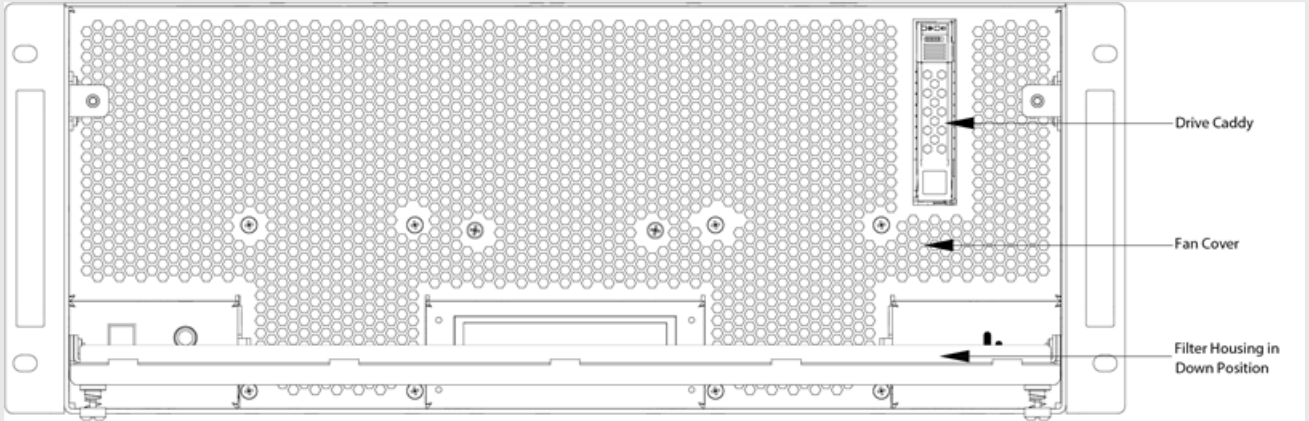

vx 2 front panel grill down

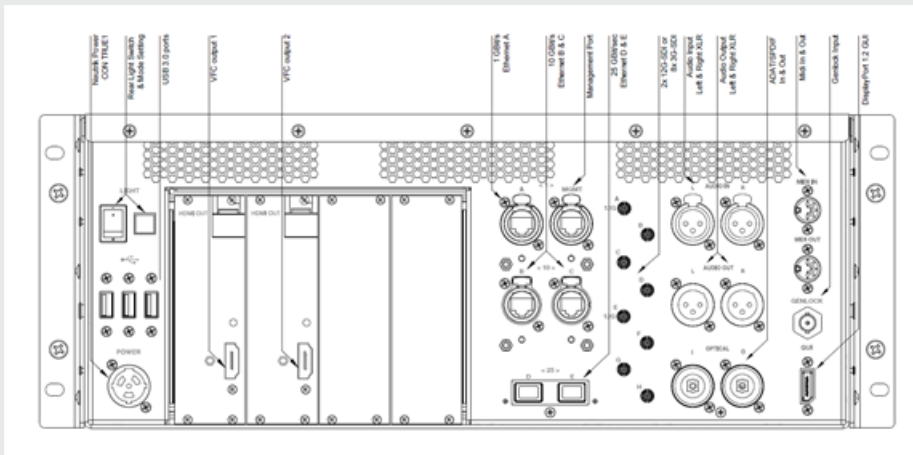

vx 2 rear panel annotated

# Hard drive configuration - vx 2



**Warning:** Do not remove drives when the machine is on as data may be corrupted if this occurs.

**Please note:** If you ever need to replace or exchange your media drive it is recommended that you use a drive with similar read/write speeds. For further information please contact the [support team](#).

## Media Drives

The vx 2 comes with 1x NVMe drive.

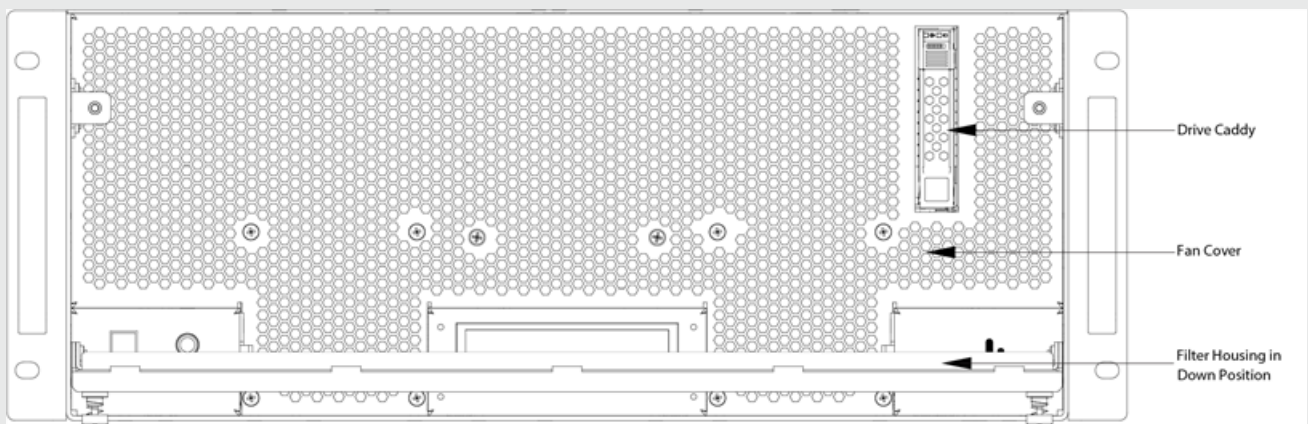

*Location of drive bay on the vx 2 unit.*

## vx 2 Video input

Your vx 2 system is equipped with a capture card. This card has the ability to capture live video from the following input types.

### Max Number of Unique Inputs

	3G-SDI	12G-SDI
vx 2	8	2

### Supported formats

Resolution	Format	Hz
625i (PAL)	interlaced	50.00
525i (NTSC)	interlaced	59.94
1280x720	progressive	23.98, 24, 25, 29.97, 30, 50, 59.94, 60
1920x1080	progressive	23.98, 24, 25, 29.97, 30, 50, 59.94, 60
1920x1080	interlaced	50, 59.94, 60
1920x1080	PsF (Progressive segmented Frame)	23.98, 24, 25, 29.97, 30
1920x1080	A/B	50, 59.94, 60
2048X1080	progressive	23.98, 24, 25, 29.97, 30, 47.952, 48, 50, 59.94, 60
2048x1080	PsF	23.98, 24, 25, 29.97, 30
	progressive, 8 or 10bit, 2 Sample Interleave or Square Division	23.98, 24, 25, 29.97, 30, 50, 59.94, 60
3840x2160 or 4096x2160		59.94, 60

## Back-Plate Layout



*Diagram of Video Capture BNC connections on rear of unit*

**Please note:** Live Video input inherently introduces frame latency during playback. Please contact [Support](#) for guidance on performance standards.

# Redisguise vx

The process for reimaging a vx server from a USB drive.

The reimaging process we refer to as **Redisguise** is the process of performing an update or restore on the system using a bootable USB drive. This process does not affect the media drive.

**Please note:** If you experience any problems during updating or restoring the system, or any of these instructions are unclear, please contact the [support team](#).



**Warning:** The system needs to be connected to the internet during this procedure

This process can be used to update to a newer OS image, or revert to a previous OS image.

To tell what OS image your system is on please go to the **Help** menu in **d3manager** and select **About Manager**.

If you are updating from an OS earlier than **3.0** your system will do a cold reboot as it performs firmware level updates to some of the components. Please don't be alarmed, just switch the system back on again using the power button

## You will need

- A 32Gb USB memory stick
- A version of [Rufus](#) to turn it into a bootable disk. Make sure the volume name of the usb is: "REDISGUISE" as per image
- An internet connection to the machine you are re-imaging
- Download and install a version of [7Zip](#)
- Download and unzip the multi file archive using 7Zip
- OS images can be found [here](#).

**Please note:** You do not need to extract all parts individually. Simply place them in the same directory and then use 7zip to extract the ISO by selecting any part. 7zip will automatically unzip all parts to create the image file.

## Create Bootable USB device

1. Download and unzip the multi file archive using 7Zip (NOTE: you will only need to unzip file 001):



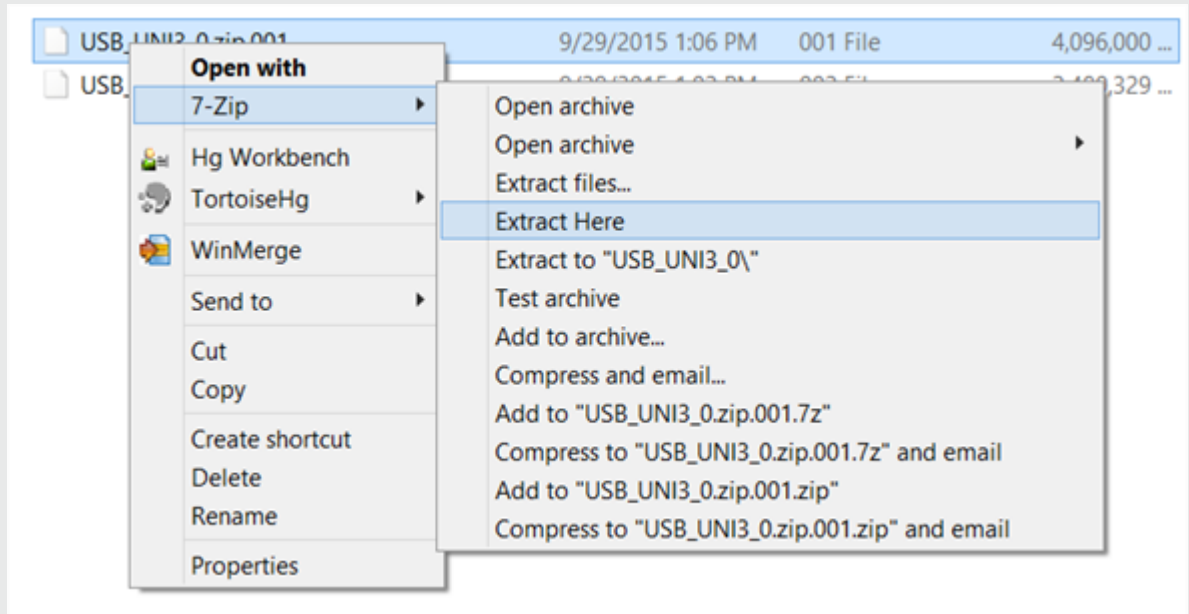

2. Create Bootable USB stick with the unzipped ISO.

The settings should be:

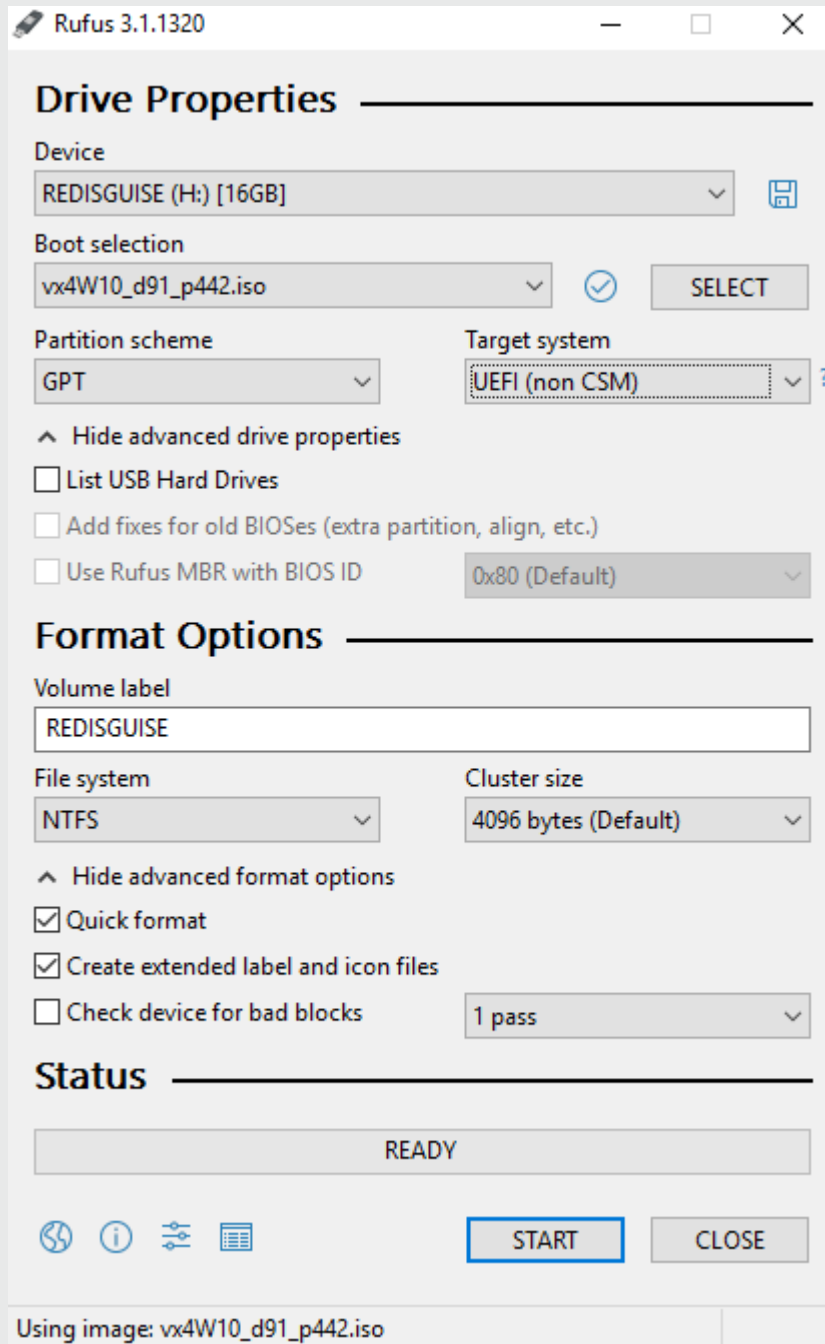

- **Partition scheme** - GPT (vx range)
- **Target system** - UEFI - non CSM
- **Volume label** - automatically pulled from ISO file
- **File system** - NTFS



**Warning:** These settings are critically important. The re-image process will fail if they are not set correctly.

## Booting into the USB

1. Go into the BIOS by hitting Delete on the logo splash screen during boot.
2. Change the Boot option #1 to the USB stick
3. Navigate to the Advanced tab and press enter to view the CSM Configuration and ensure that Boot option filter is set to [UEFI and Legacy]. Change it if it is not, then press F4, confirm and re-enter BIOS.
4. Once this setting is confirmed, navigate to the Save & Exit tab. It is just to the right of the Boot tab.
5. In the Boot Override section at the bottom there is a UEFI: USB, Partition 2. This may vary depending on the manufacturer of USB stick in use. Select this option to begin the OS upgrade process.

**Please note:** performing a system restore from the new disk image will erase any valuable data on your system drive. Please ensure you make a back up of any essential files from your system (C:) drive before initialising this process. The process does NOT destroy any media or projects on your media drive.

# VX 2+ Overview

The VX 2+ comes pre-installed with the latest software version, enabling you to design, configure and sequence the show on the same machines as you later use for show playback.

## VX 2+

### Overview

The VX 2+ is the evolution of the vx 2 media server, with later-gen CPU, GPU, and motherboard and increased networking capabilities.

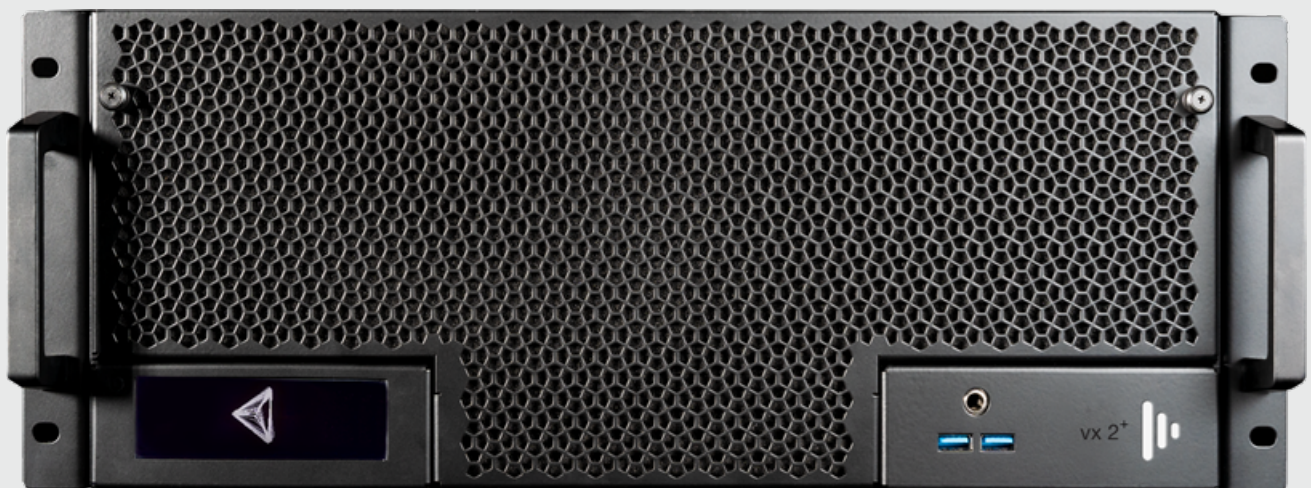

Learn more about:

- [Diagrams](#)
- [Specifications](#)
- [Performance](#)
- [Video Input](#)
- [Redisguise](#)

For detailed information on the specifications for each machine, as well as the other software and hardware bundles offered by Disguise, please see the products section of our [website](#).

# VX 2+ Overview

The VX 2+ comes pre-installed with the latest software version, enabling you to design, configure and sequence the show on the same machines as you later use for show playback.

## VX 2+

### Overview

The VX 2+ is the evolution of the vx 2 media server, with later-gen CPU, GPU, and motherboard and increased networking capabilities.

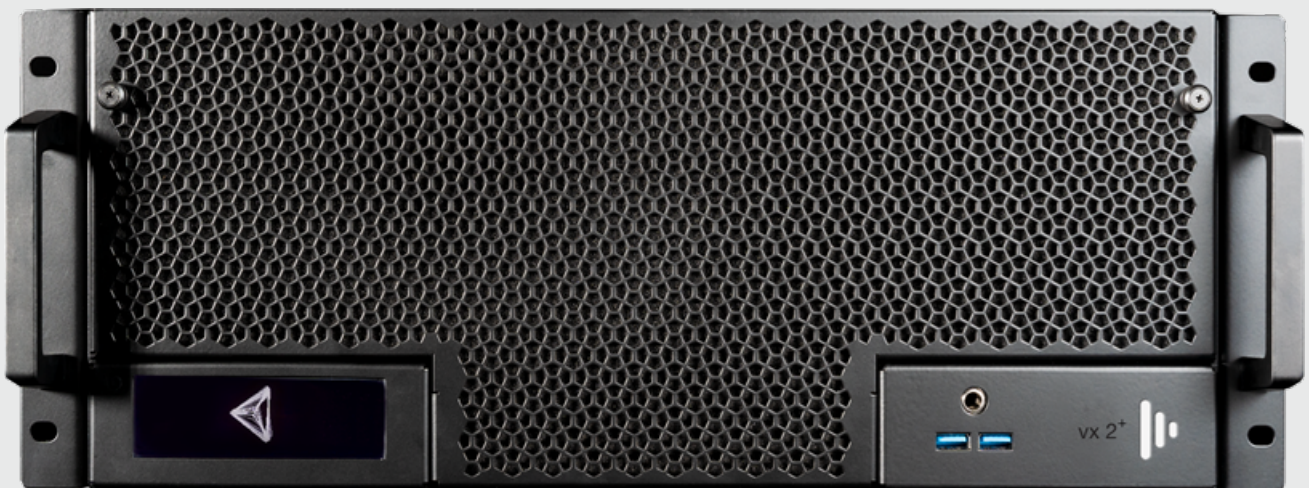

Learn more about:

- [Diagrams](#)
- [Specifications](#)
- [Performance](#)
- [Video Input](#)
- [Redisguise](#)

For detailed information on the specifications for each machine, as well as the other software and hardware bundles offered by Disguise, please see the products section of our [website](#).

# VX 2+ diagrams

## VX 2+ Diagrams

### Front view of VX 2+

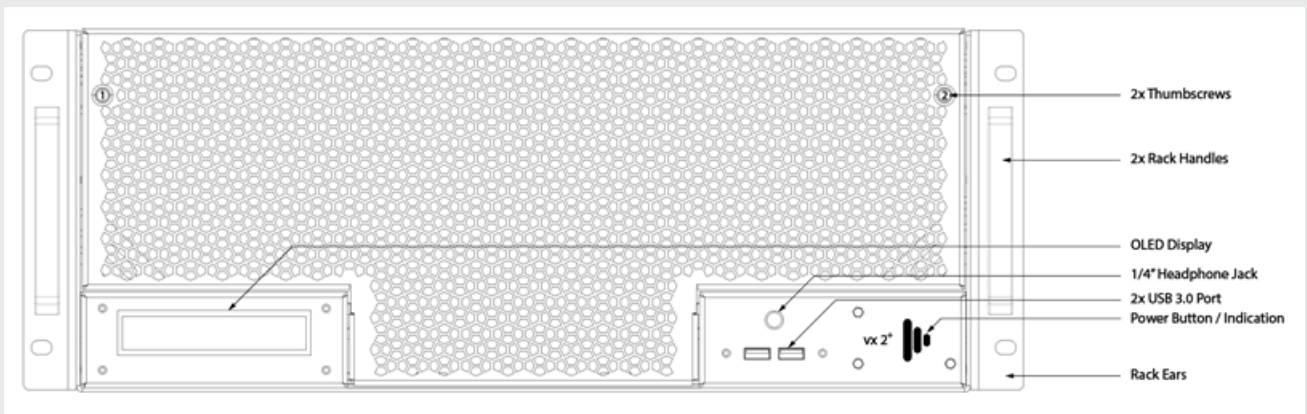

### Front grill down view of VX 2+

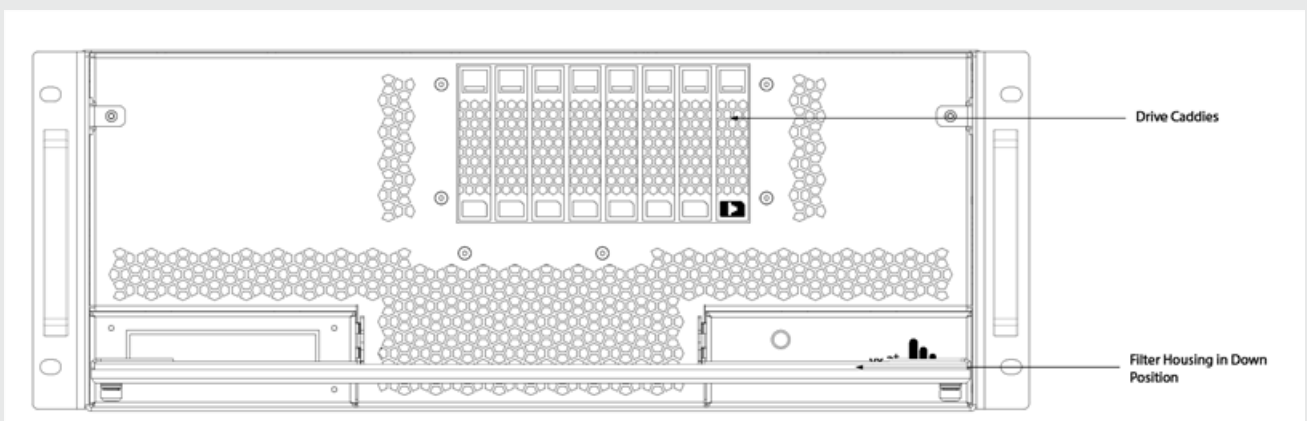



# Rear view of VX 2+

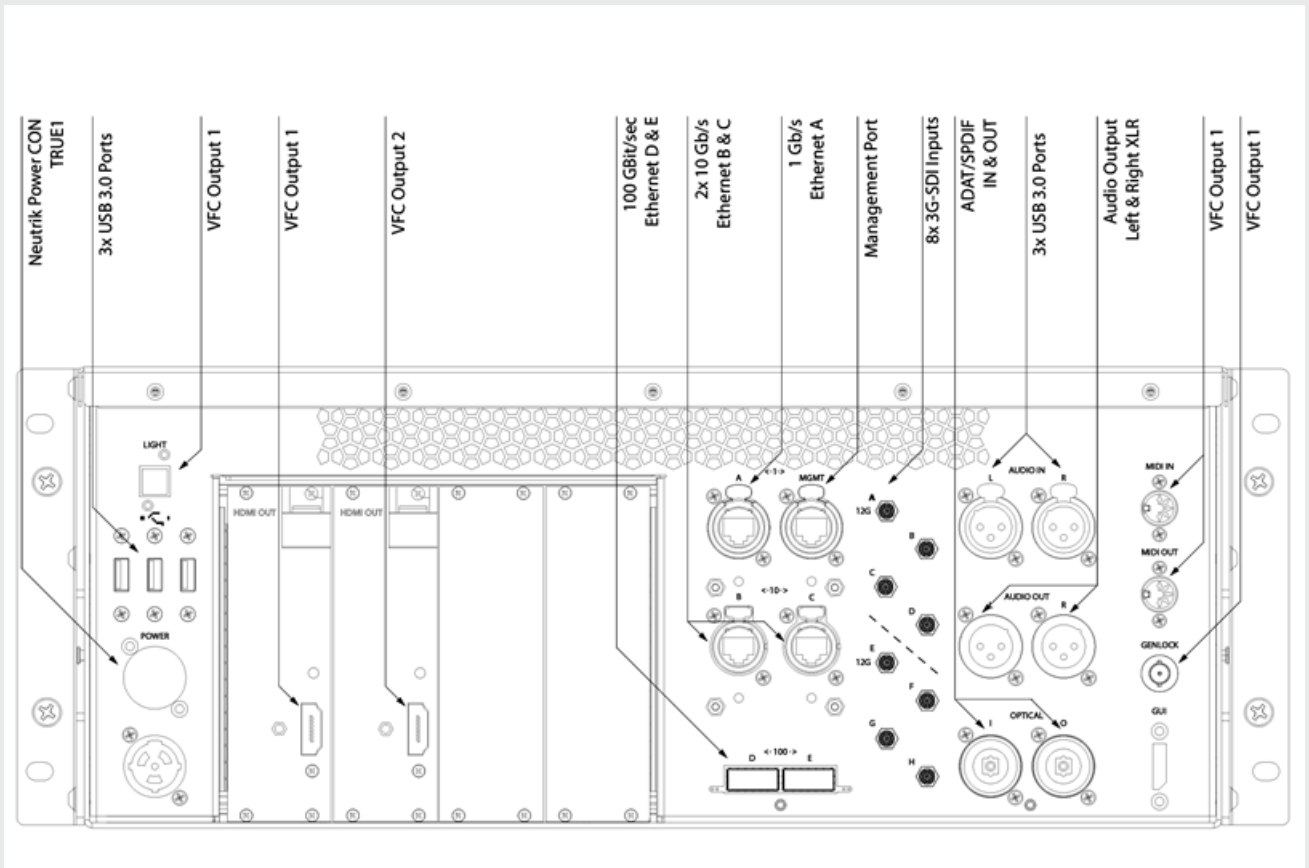

[View the full VX 2+ specification sheet here.](#)

# VX 2+ Specifications

## Hardware

4K inputs	2x 12G inputs (or 8x 3G inputs)
4K outputs (VFC)	2 +1 GUI port
Video Sync	1x BNC Genlock
Network ports	General Network: 1GbE LAN (management port) General Network: 2x 10GbE LAN Media Network: Dual-port 100GbE LAN
GPU	NVIDIA RTX A4500
CPU	Intel Xeon 3.1Ghz
Motherboard	PCI Express 4.0
Storage	2x Internal Storage Drives 1x 3.84TB Removable NVMe SSD
Memory	96GB RAM (6 x 16GB)
Notchmarks	Notch playback license is not included TBC Notchmarks

## Specifications

All video standards outlined here have been tested up to the following:

- Bit depth - 10-bit (all modes)
- Chroma subsampling - YCbCr 4:2:2 (all modes)

- Each SDI input supports 3G Level A and Level B when applicable
- All quadlink formats support either square division or two-sample interleave (2SI) methods.

## 4K DCI (4096 x 2160)

4K DCI 23.98p, 4K DCI 24p, 4K DCI 25p, 4K DCI 29.97p, 4K DCI 30p, 4K DCI 47.952p, 4K DCI 48p, 4K DCI 50p, 4K DCI 59.94p, 4K DCI 60p

## Quadlink 4K DCI (4096 x 2160 using 4x 2048 x 1080 inputs)

4K DCI 47.952p, 4K DCI 48p, 4K DCI 50p, 4K DCI 59.94p, 4K DCI 60p

## UHD (3840 x 2160)

2160p23.98, 2160p24, 2160p25, 2160p29.97, 2160p30, 2160p50, 2160p59.94, 2160p60

## Quadlink UHD (3840 x 2160 using 4x 1920 x 1080 inputs)

2160p50, 2160p59.94, 2160p60

## 2K DCI (2048 x 1080)

2K DCI 23.98p, 2K DCI 23.98psf, 2K DCI 24p, 2K DCI 24psf, 2K DCI 25p, 2K DCI 25psf, 2K DCI 29.97p, 2K DCI 29.97psf, 2K DCI 30p, 2K DCI 30psf, 2K DCI 47.952p, 2K DCI 48p, 2K DCI 50p, 2K DCI 59.94p, 2K DCI 60p

## Full HD (1920 x 1080)

1080p23.98, 1080psf23.98, 1080p24, 1080psf24, 1080p25, 1080psf25, 1080p29.97, 1080psf29.97, 1080p30, 1080psf30, 1080p50, 1080i50, 1080p59.94, 1080i59.94, 1080p60, 1080i60

## HD (1280 x 720)

720p25, 720p29.97, 720p30, 720p50, 720p59.94, 720p60

It is possible to have a different format on each input. However, the limitations are a maximum of 2x 2160p60 or 8x 1080p60 at any one time.

The VX 2+ does not contain a RAID controller.

Download the full specifications here. [insert link when website is live]

# VX 2+ Performance

## Playback

Performance specifications listed here outline the maximum amount of video layers that are achievable on a single VX 2+. These can fluctuate in future releases.

### Benchmarks - Video Layers (Full HD)

Video Codec	Content Data Rate (MB/s)	Max Layers on VX 2+
HAP 30	31	49
HAP 60	62	49
HAPQ 30	61.25	45
HAPQ 60	122.5	28
Animation 30	187.25	19
Animation 60	374.5	9
TIFF Sequence 30	237	14
TIFF Sequence 60	474	7
NotchLC 30	78.375	39
NotchLC 60	156.75	23

## Benchmarks - Video Layers (4k DCI)

Video Codec	Content Data Rate (MB/s)	Max Layers on VX 2+
HAP 30	132	27
HAP 60	264	13
HAPQ 30	261.25	14
HAPQ 60	522.5	7
Animation 30	798.25	5
Animation 60	1596.5	2
TIFF Sequence 30	949	3
TIFF Sequence 60	1898	2
NotchLC	331.5	11
NotchLC	663	5
DPX Sequence, 8-bit, RGB, 30	759	4
DPX Sequence, 8-bit, RGB, 60	1518	1
DPX Sequence, 10-bit, RGB, 30	1011	3
DPX Sequence, 10-bit, RGB, 60	2022	1
TGA Sequence, 8-bit, RGB, 30	759	4
TGA Sequence, 8-bit, RGB, 60	1518	2
TGA Sequence, 10-bit, RGB, 30	1011	3
TGA Sequence, 10-bit, RGB, 60	2022	1
TIFF Sequence, 8-bit, RGB, 30	759	4
TIFF Sequence, 8-bit, RGB, 60	1518	2
TIFF Sequence, 10-bit, RGB, 30	1011	3
TIFF Sequence, 10-bit, RGB, 60	2022	1

## NOTES:

- Content is played back at 30 fps and 60 fps as outlined in the video codec above.
- All HD codecs listed above have an output resolution relevant to Full-HD (1920 x 1080).
- All UHD codecs listed above have an output resolution relevant to 4K DCI (4096 x 2160).
- One codec and frame rate tested per track.
- One unique video file per layer.
- One LED screen per resolution tested (Full-HD and DCI 4k)
- The test machine is run as an actor with its GUI disabled.
- Absolute maximum level of performance. One more layer means that the system will start to drop frames.
- Measured against r26.4, build 174820.

## Capture Latency

The following table provides data on how many frames of latency the VX 2+ requires from capture to output:

### VX 2+ SDI

Refresh Rate	Normal mode (frames)	Low Latency mode (frames)	Ultra-Low Latency (frames)
60Hz	5	4	3
50Hz	5	4	3
30Hz	5	4	3

# VX 2+ Video input

Your Disguise system is equipped with capture cards. These cards have the ability to capture live video from either SD-SDI or HD-SDI video sources with up to four unique feeds, or two unique 3G-SDI feeds per machine.

## Max Number of Unique Inputs

	3G-SDI	12G-SDI
VX 2+	8	2

## Supported formats

720x486i @ 59.94 Hz NTSC

720x576i @ 50.00 Hz PAL

1280x720p @ 23.976Hz, 24Hz, 25Hz, 29.97Hz, 30Hz, 50Hz, 59.94Hz, 60Hz

1920x1080i @ 47.96Hz, 48Hz, 50Hz, 59.94Hz, 60Hz

1920x1080PsF @ 23.976Hz, 24Hz, 25Hz, 29.97Hz, 30Hz

1920x1080p @ 23.976Hz, 24Hz, 25Hz, 29.97Hz, 30Hz, 47.96Hz, 48Hz, 50Hz, 59.94Hz, 60Hz

2048X1080p @ 23.976Hz, 24Hz, 25Hz, 29.97Hz, 30Hz, 47.96Hz, 48Hz, 50Hz, 59.94Hz, 60Hz

2048X1080i @ 47.96Hz, 48Hz, 50Hz, 59.94Hz, 60Hz

2048x1556PsF @ 14.98Hz, 15Hz, 18.98Hz, 19Hz

4K UHD 3840x2160, 4K P/PsF @ 23, 24, 25, 29, 30fps

4K DCI 4096x2160, 4K P/PsF, @23, 24, 25, 29, 30fps

It is possible to have a different format on each input, However the limitations are a maximum of 1x 4k or 2x 1080p60.

If you are using 1x 4k or 2x 1080p it is not possible to use any other video inputs on the unit due to hardware limitations.



## Back-Plate Layout



Diagram of Video Capture BNC connections on rear of gx 3.



Diagram of Video Capture BNC connections on rear of a VX2+.

**Please note:** Live Video input inherently introduces frame latency during playback. Please contact [Support](#) for guidance on performance standards.

# Update & restore

Update & restore is the process of doing an update or restore on the system using a bootable USB drive. This process does not affect the media drive.

Please note: If you experience any problems during updating or restoring the system, or any of these instructions are unclear, please contact the [support team](#).



**Warning:** The system needs to be connected to the internet during this procedure

## You will need

- A 16Gb USB memory stick
- A version of [Rufus](#) to turn it into a bootable disk. Make sure the volume name of the usb is: "REDISGUISE".
- An internet connection to the machine you are re-imaging
- Download and install a version of [7Zip](#)
- Download and unzip the multi file archive using 7Zip
- OS images can be found [here](#).

**Please note:** You do not need to extract all parts individually. Simply place them in the same directory and then use 7zip to extract the ISO by selecting any part. 7zip will automatically unzip all parts to create the image file.

## Create a Bootable USB

1. Download and unzip the multi file archive using 7Zip (NOTE: you will only need to unzip file 001):

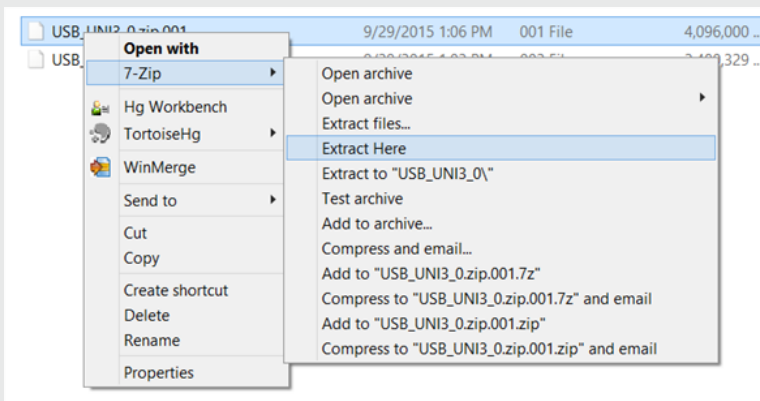

2. Create Bootable USB stick with the unzipped ISO.

The settings should be:

- **Partition scheme** - GPT (vx range)
- **Target system** - UEFI - non CSM
- **Volume label** - automatically pulled from ISO file
- **File system** - NTFS



**Warning:** These settings are critically important. The re-image process will fail if they are not set correctly.

**Please note:** On the latest versions of Rufus you may see this warning. This is expected and does not apply to current disguise hardware. Please click **OK** to continue as normal.

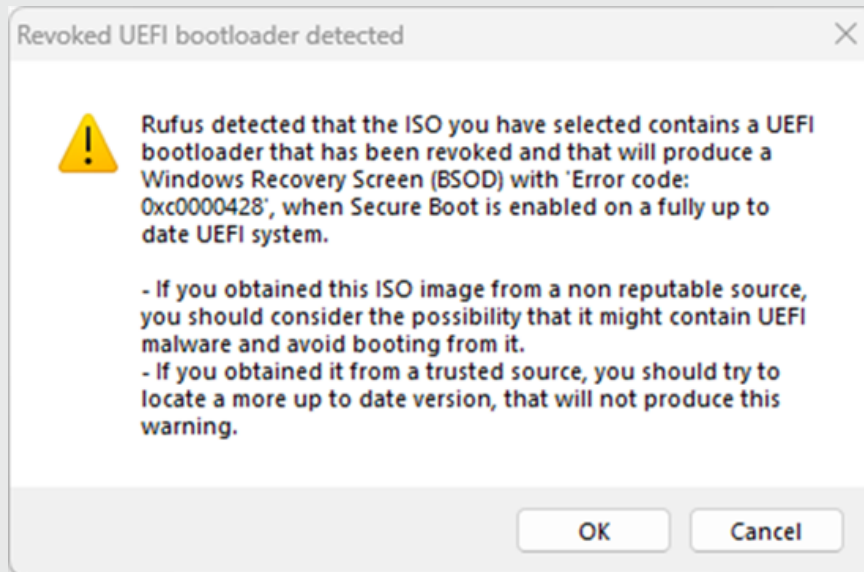

## Booting into the USB

1. Go into the BIOS by hitting Delete on the logo splash screen during boot.
2. Change the Boot option #1 to the USB stick
3. Navigate to the Save & Exit tab. It is just to the right of the Boot tab.
4. In the Boot Override section at the bottom there is a UEFI: USB, Partition 2. This may vary depending on the manufacturer of USB stick in use. Select this option to begin the OS upgrade process.

**Please note:** performing a system restore from the new disk image will erase any valuable data on your system drive. Please ensure you make a back up of any essential files from your

system (C:) drive before initialising this process. The process does NOT destroy any media or projects on your media drive.

## vx 4 overview



**Warning: Opening hardware may void your warranty. Consult Disguise support before opening the hardware.**



**Warning: do not open or remove the case unless you are instructed to do so by a certified Disguise Engineer**

**Please note: If you experience any problems with hardware please contact the [support team](#)**

The machines come pre-installed with the latest software version, enabling you to design, configure and sequence the show on the same machines as you later use for show playback.

For detailed information on the specifications for each plus and pro machine, as well as the other software and hardware bundles offered by Disguise, please see the products section of our web site.

## vx 4

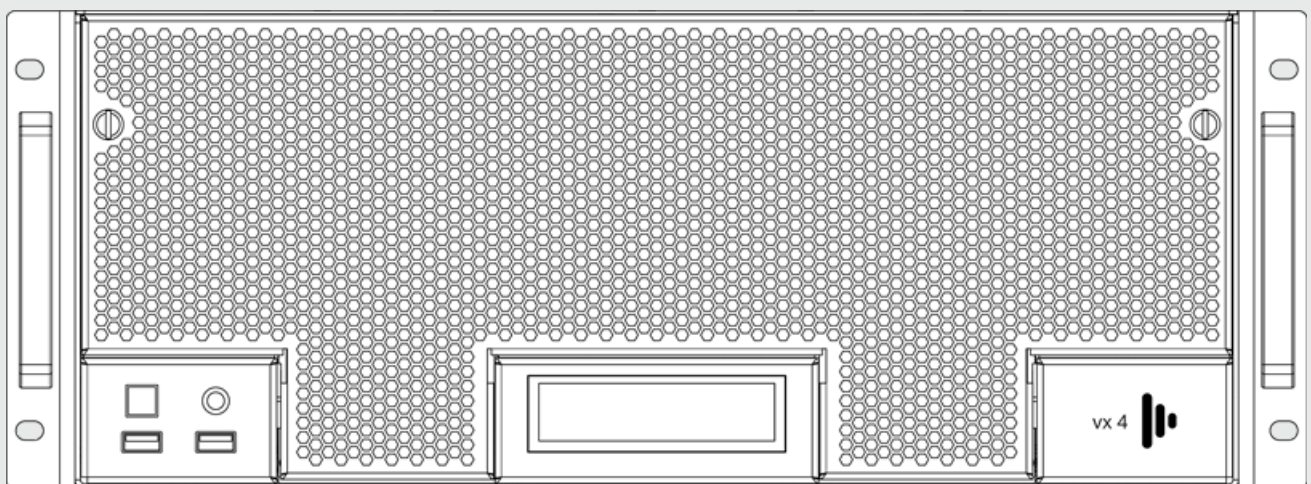

*vx 4 front panel*

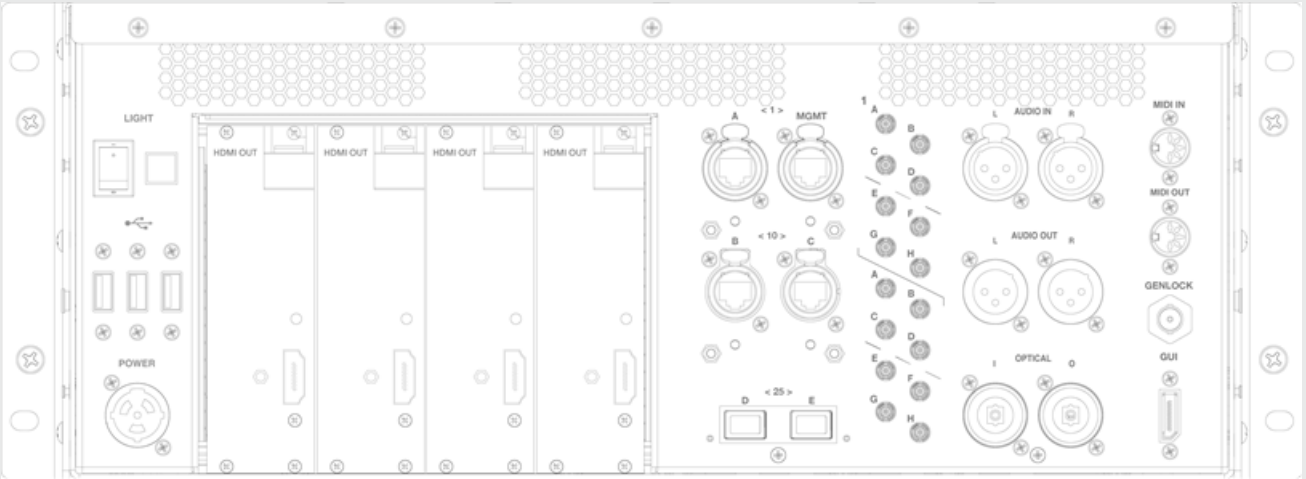

vx 4 rear panel

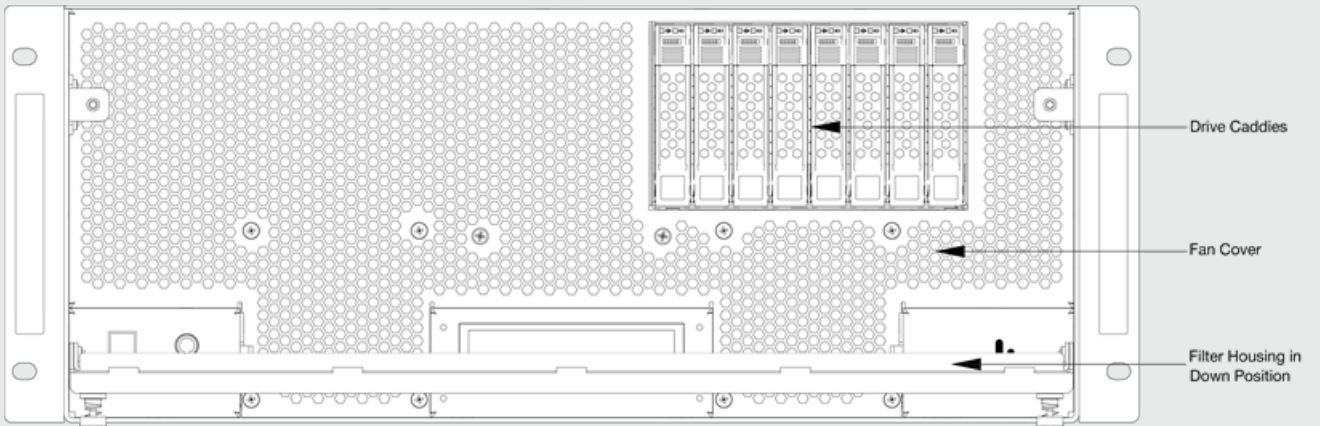

vx 4 front panel grill down

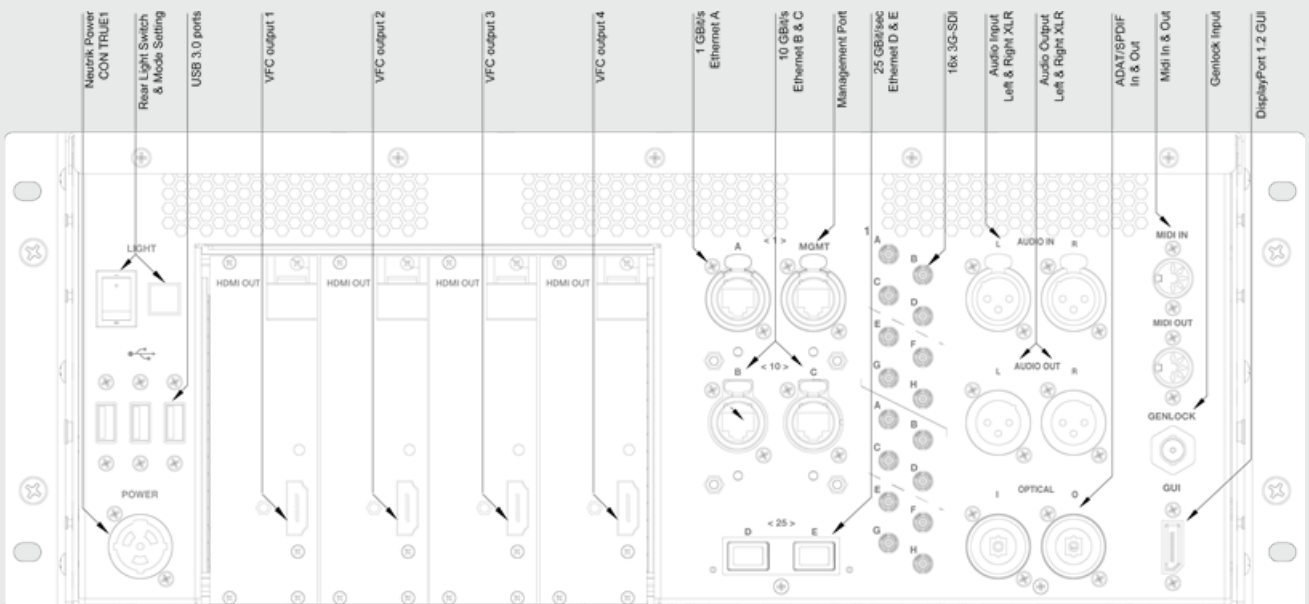

vx 4 rear panel annotated

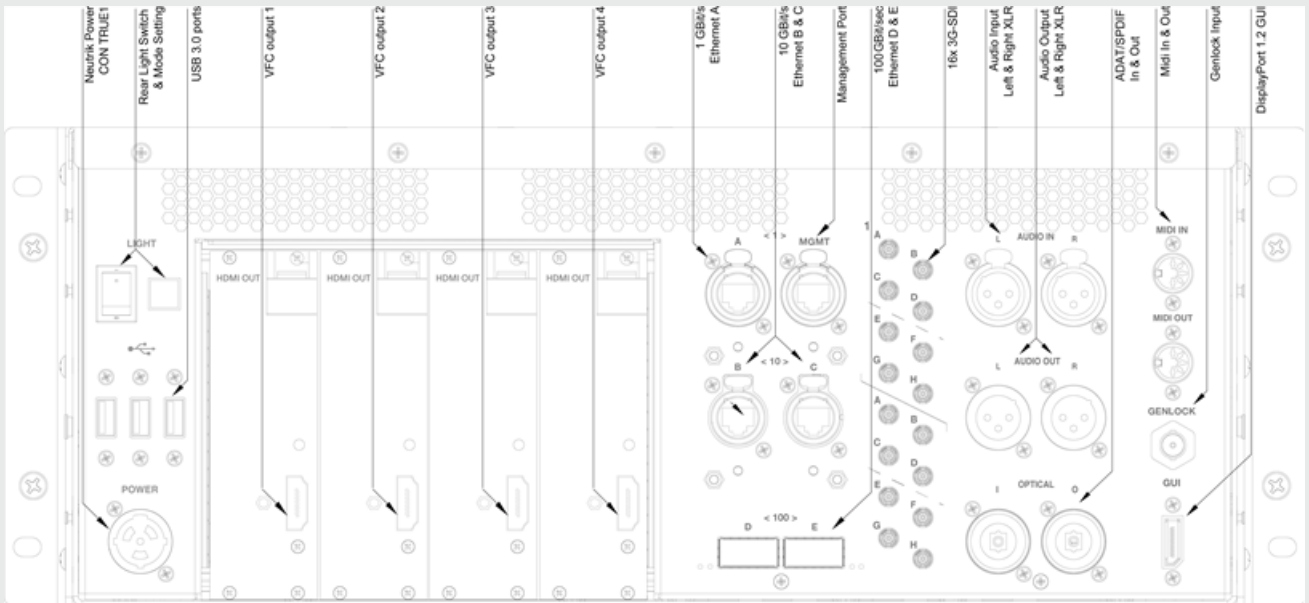

vx 4+ rear panel annotated



# vx 4 diagrams

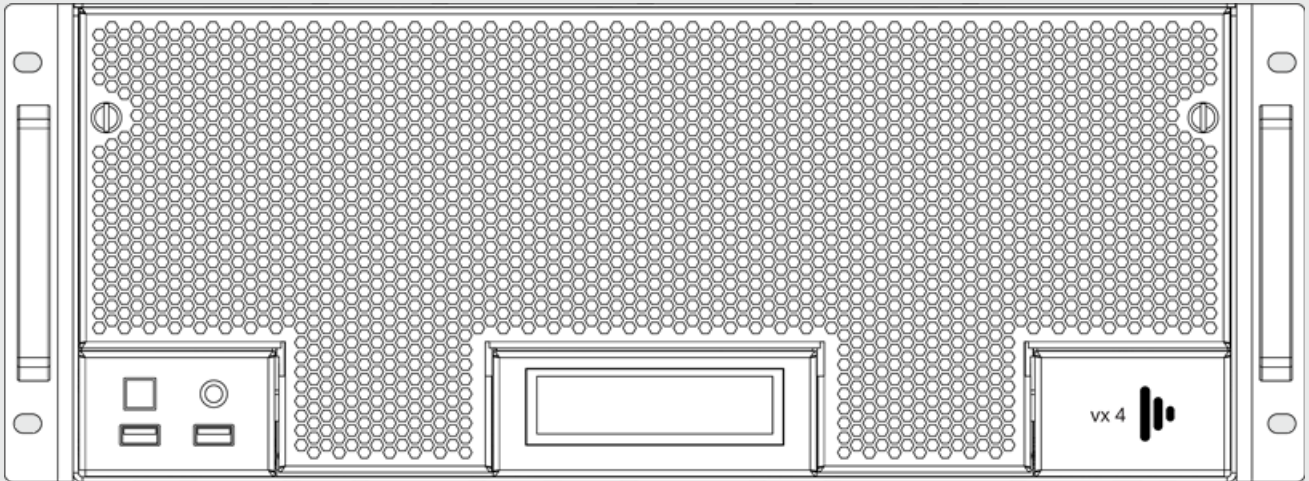

vx 4 front panel

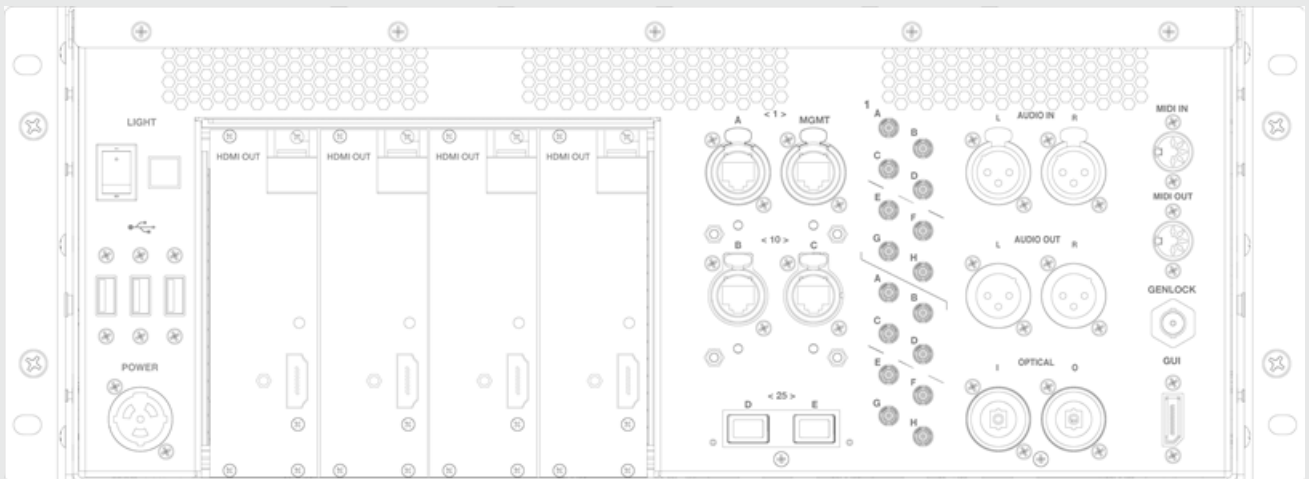

vx 4 rear panel

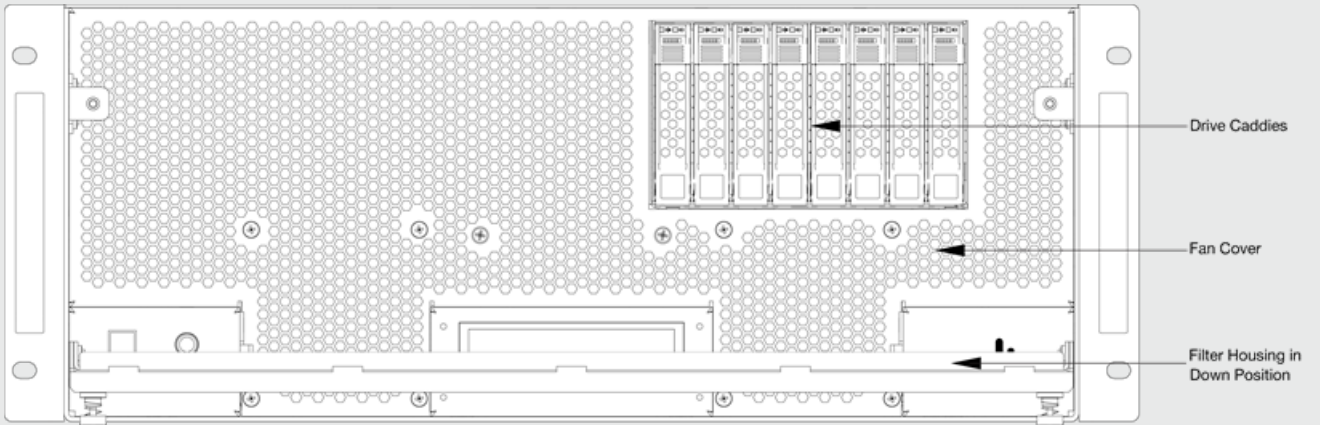

vx 4 front panel grill down

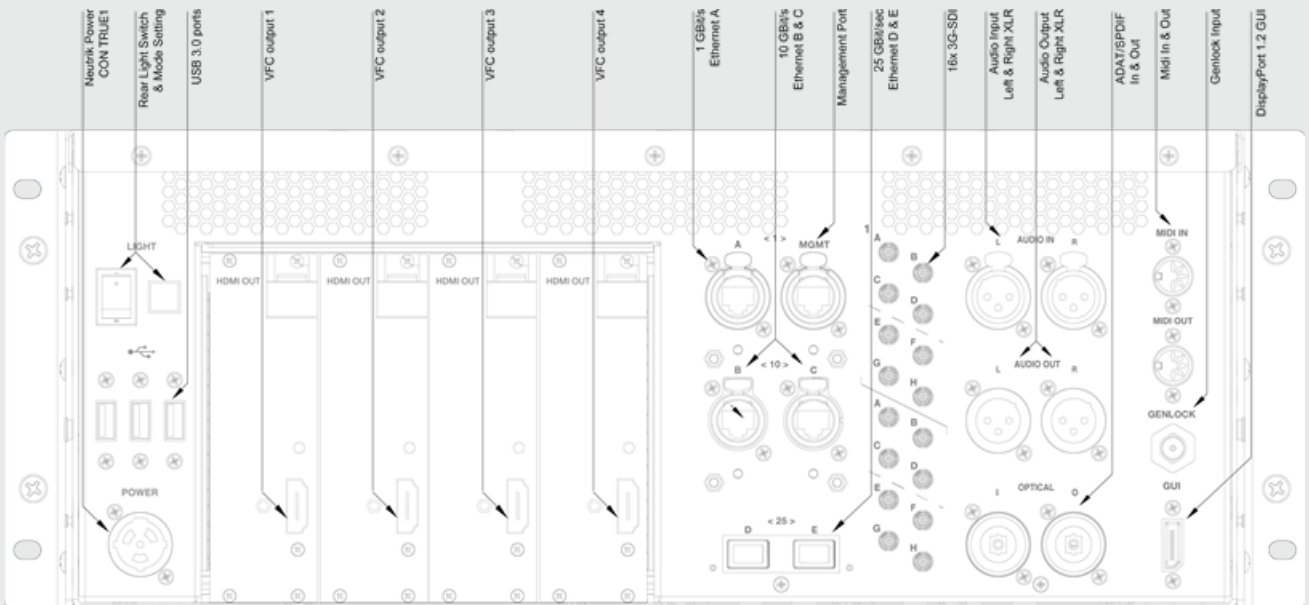

vx 4 rear panel annotated

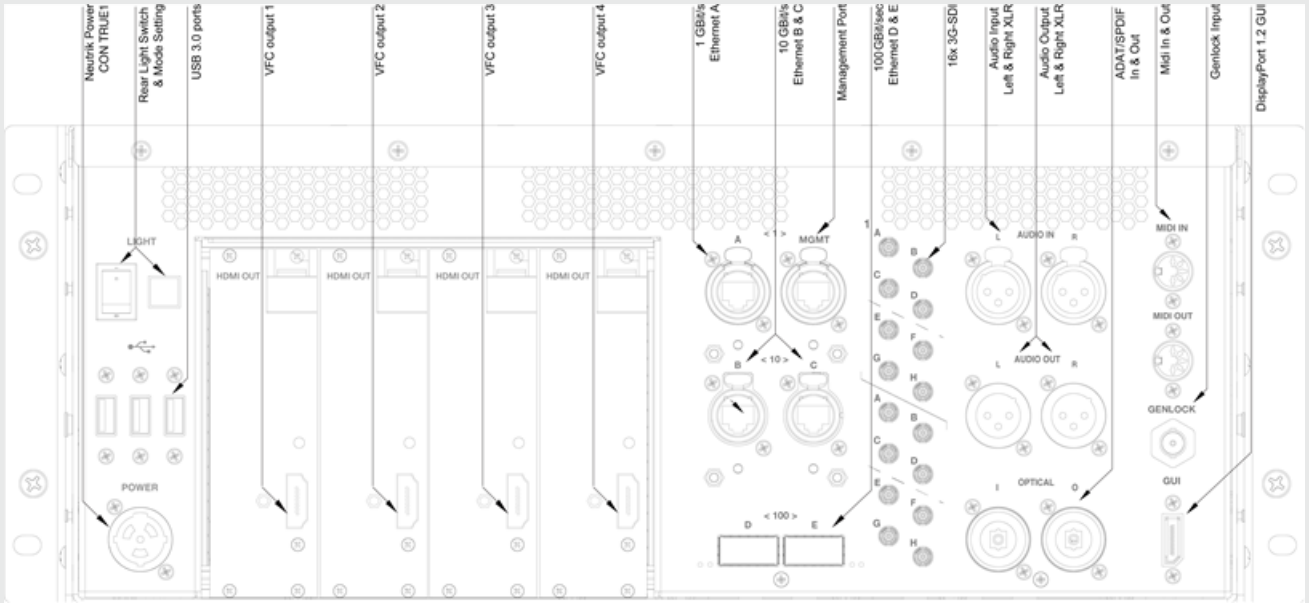

vx 4+ rear panel annotated

# Hard drive configuration



**Warning:** Do not remove drives when the machine is on as data may be corrupted if this occurs.

**Please note:** If you ever need to replace or exchange your media drive it is recommended that you use a drive with similar read/write speeds. For further information please contact the [support team](#).

## Media drives

The vx 4 comes with 4x NVMe SSD drives.

These drives are removable from the drive bay. It is possible to user-reconfigure the RAID configuration using software in Windows to control the dedicated RAID controller hardware.

The cage contains eight caddies, four populated with 4x NVMe drives. Drives are configured as RAID10.

To reveal the drive bay undo the two thumb screws on the front of the unit. See diagram below.

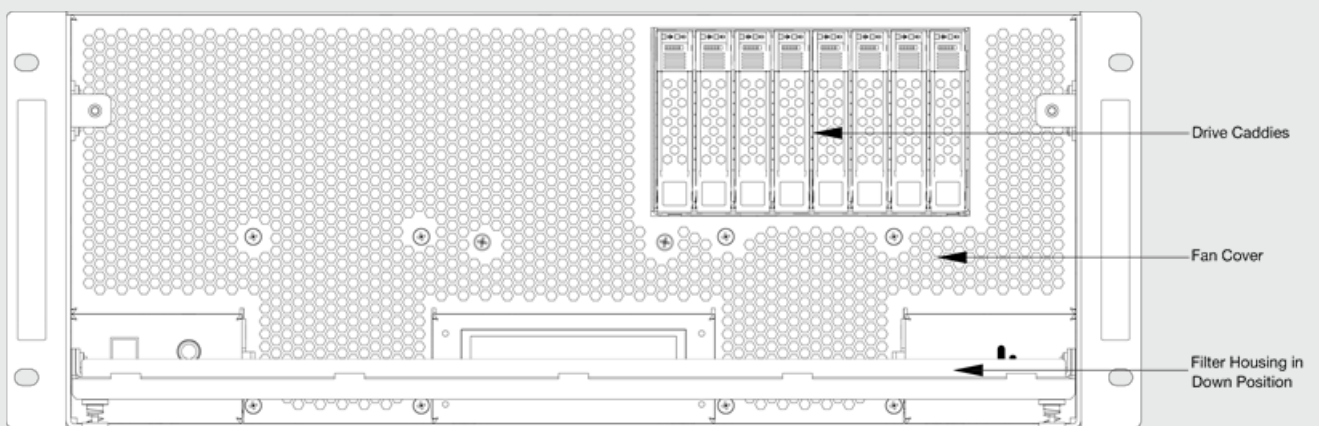

*Location of drive bays on the vx 4 unit.*

# RAID Configuration

Please note: The drives used in this guide were for examples and you will likely have a different setup in your RAID. If you want to know information about what drives are required/ recommended then please contact the [disguise Support team](#)

## Logging in to the RAID controller

In order to login and configure your RAID, you must ensure that your server has a password setup for the user account.

1. Open the Windows start menu and select LSA.
2. On the LSA landing page, select the server with your local IP address (multiple will show if on a network with more than one vx 4).

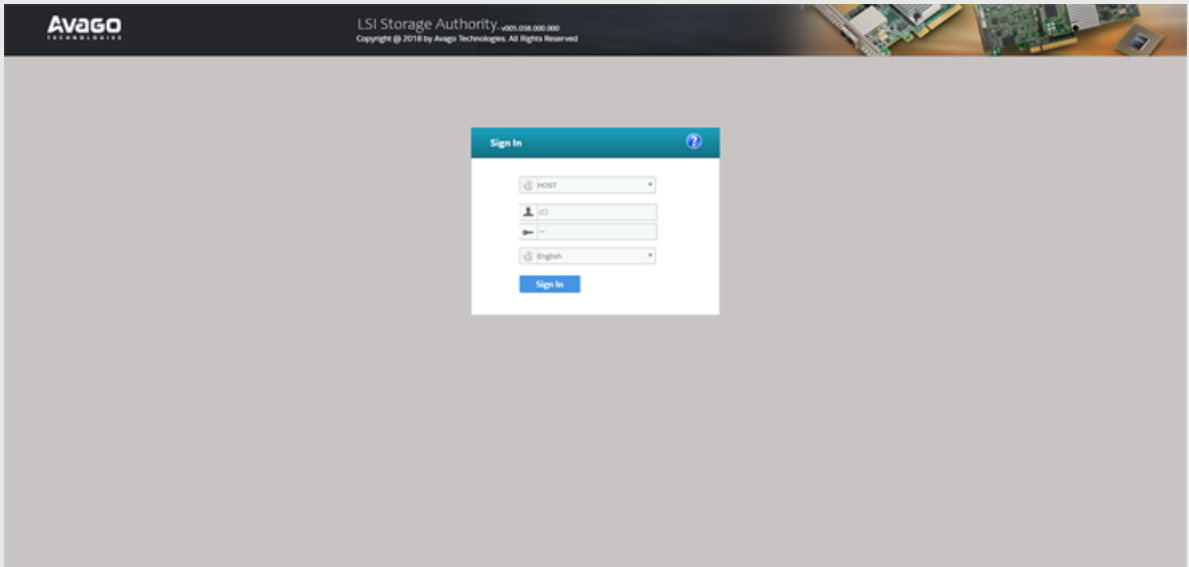

3. Enter your login details of the local user account (default is Username: d3, Password: NOT SET)

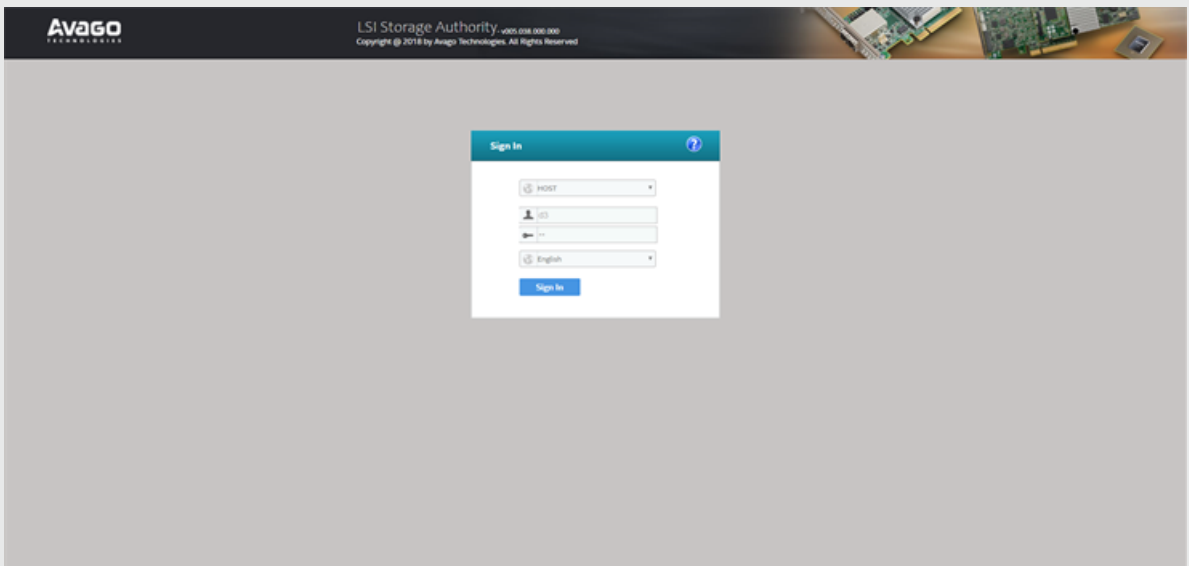

# Overview of the RAID

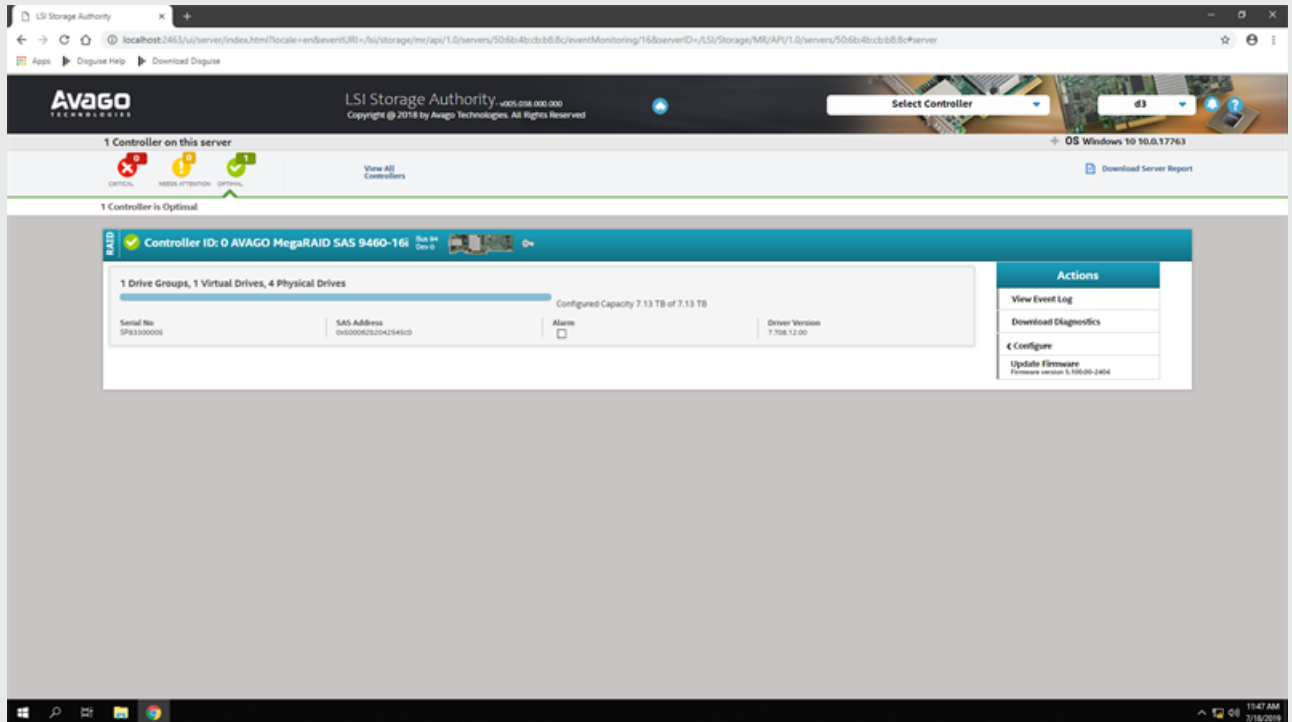

On the landing page you will see information about the controller within the system. This will alert you to any issues, the current capacity and how many drives are present.

1. Select the controller from the **Select Controller** dropdown menu at the top of the page.

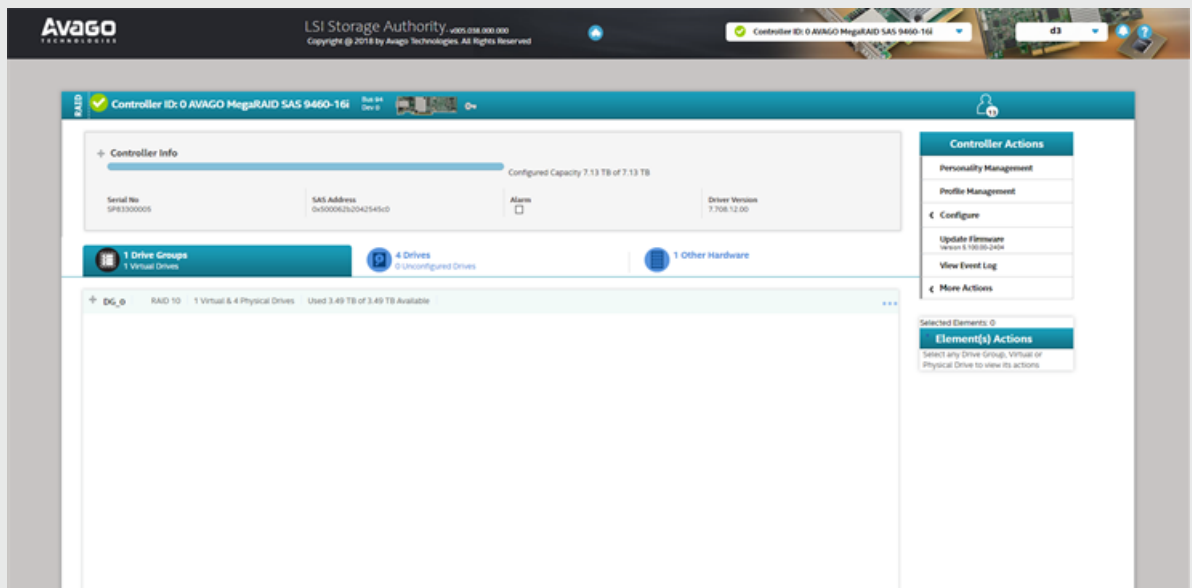

2. On the controller landing page you are able to find out more detailed information about the controller itself and the drives within the system.
3. The first tab shown contains extra information into the Virtual Drive, RAID Level etc.



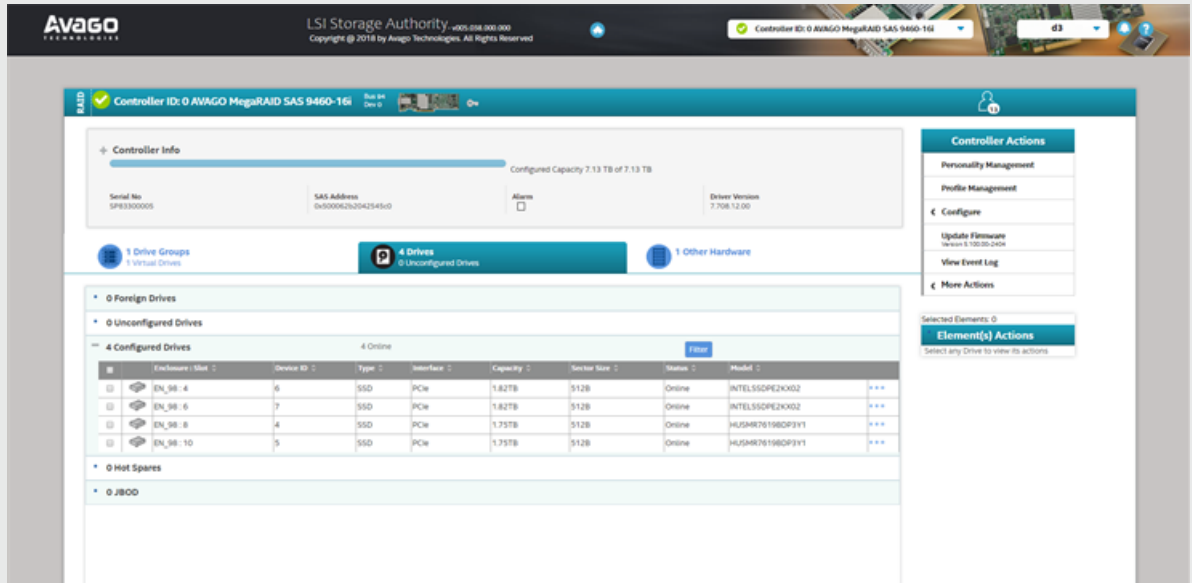

4. From the drive information page you should look to do any configuration.

## Creating a RAID

1. If you want to create a new RAID, click on the **Configure** tab on the far right of the page.
2. Select **Advanced Configuration** to ensure you get all available options.

Controller ID: 0 AVAGO MegaRAID SAS 9460-16i

Configured Capacity 0 KB of 7.13 TB

Serial No: 9P8330005 SAS Address: 00000000000000000000000000000000 Alarm:  Driver Version: 7.706.13.00

0 Drive Groups 0 Virtual Drives 4 Drives 4 Unconfigured Drives 1 Other Hardware

Advanced Configuration: Default (customize) process

Simple Configuration: Storage Configuration: 0 Health Clear Configuration

Controller Actions: Personality Management, Profile Management, Configure, Update Firmware (version: 5.100.00-2404), View Event Log, More Actions

Selected Elements: 0 Element(s) Actions: Select any Drive to view its actions

#	Enclosure / Slot	Device ID	Type	Interface	Capacity	Sector Size	Status	Model
1	EN_08 - 4	6	SSD	PCIe	1.82TB	512B	Unconfigured good	INTELSSDPE2K052
2	EN_08 - 6	7	SSD	PCIe	1.82TB	512B	Unconfigured good	INTELSSDPE2K052
3	EN_08 - 8	4	SSD	PCIe	1.75TB	512B	Unconfigured good	HUSM876198CP3Y1
4	EN_08 - 10	5	SSD	PCIe	1.75TB	512B	Unconfigured good	HUSM876198CP3Y1

- The default and recommended setup is RAID 10. This should be selected to meet any performance stats released by disguise.



**Warning:** If the RAID is set up at a different level you could be at risk of losing your data without redundancy.

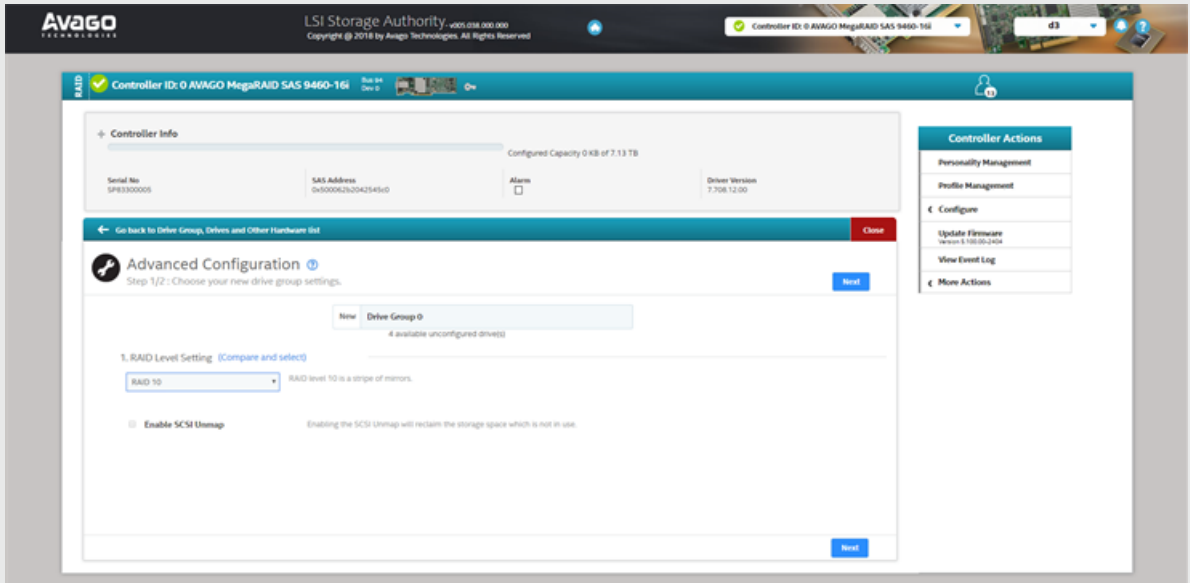

- Continue to the next page and select **Add Physical Drives** to choose which drives you are going to put into an array. RAID 10 requires a minimum of 4 drives to be set up.

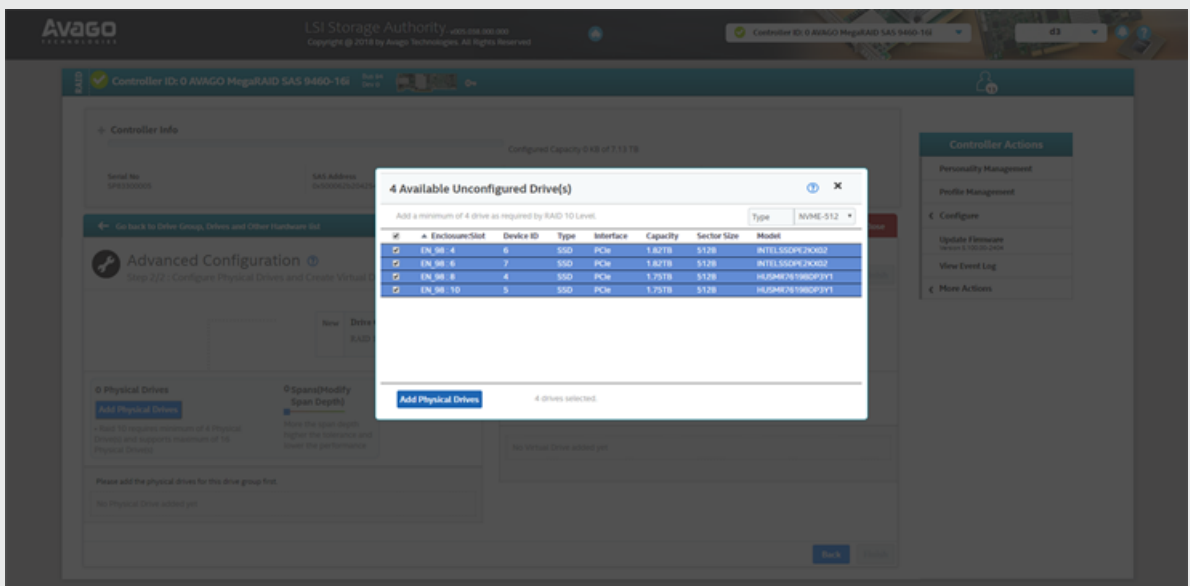

5. Once the drives have been selected, click on **Add Virtual Drives**. The default configuration is as below and should be followed to ensure no issues.

- **Virtual Drive Name** - Media
- **Strip size** - 256 KB
- **Initialization State** - No Initialization
- **Read Policy** - Always Read Ahead
- **Write Policy** - Write Through
- **I/O Policy** - Direct IO
- **Disk Cache Policy** - Unchanged

6. When all settings are set. Click **Add Virtual Drives**.

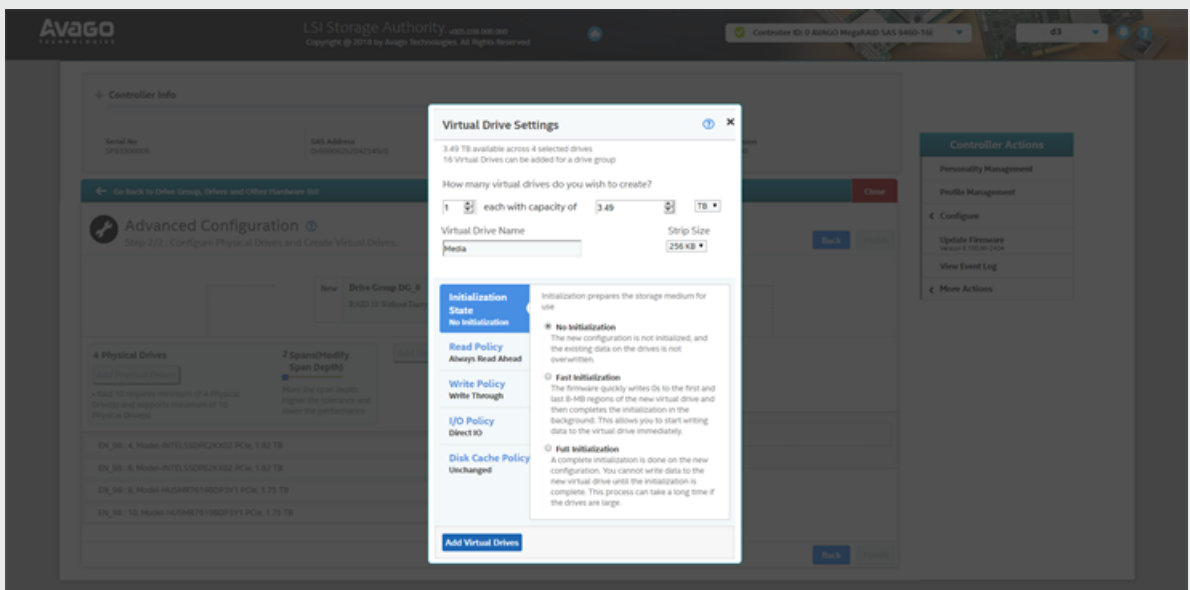

7. Continue through the wizard by selecting **Finish**.

8. You will then be presented a completion page showing the details of the configured RAID.

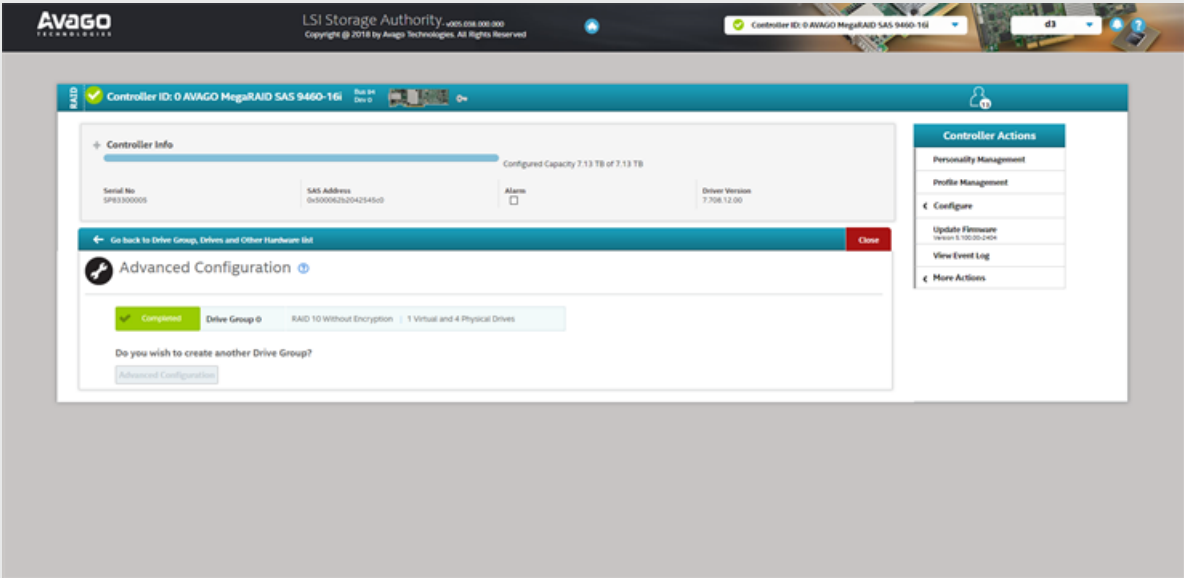

# Unconfigured Good/Bad

Unconfigured Good drives are ready to be configured into a RAID.

Avago Technologies LSI Storage Authority v09.038.000.000 Copyright © 2018 by Avago Technologies. All Rights Reserved

Controller ID: 0 AVAGO MegaRAID SAS 9460-16i Bus on Dev 0

Configured Capacity 0 KB of 7.13 TB

Serial No: SP83300005 SAS Address: 0x500062b2042545c0 Alarm:  Driver Version: 7.308.12.00

0 Drive Groups (0 Virtual Drives) 4 Drives (2 Unconfigured) 1 Other Hardware

Foreign Drives: 4 Unconfigured good

#	Enclosure Slot	Device ID	Type	Interface	Capacity	Sector Size	Status	Model	
1	EN_98 : 4	6	SSD	PCIe	1.82TB	512B	Unconfigured good	INTELSSDPE2X002	***
2	EN_98 : 6	7	SSD	PCIe	1.82TB	512B	Unconfigured good	INTELSSDPE2X002	***
3	EN_98 : 8	4	SSD	PCIe	1.75TB	512B	Unconfigured good	HUSMR76198DP3Y1	***
4	EN_98 : 10	5	SSD	PCIe	1.75TB	512B	Unconfigured good	HUSMR76198DP3Y1	***

0 Configured Drives

0 Hot Spares

0 JBOD

Controller Actions: Personality Management, Profile Management, Configure, Update Firmware (Version 5.100.00-2404), View Event Log, More Actions

Selected Element(s): 0

Element(s) Actions: Select any Drive to view its actions

Unconfigured Bad drives must first be made into unconfigured good drives before any configuration can be done. If a drive (or drives) is showing up as unconfigured bad then select it (one by one) and click on **Make Unconfigured Good** on the right hand side.

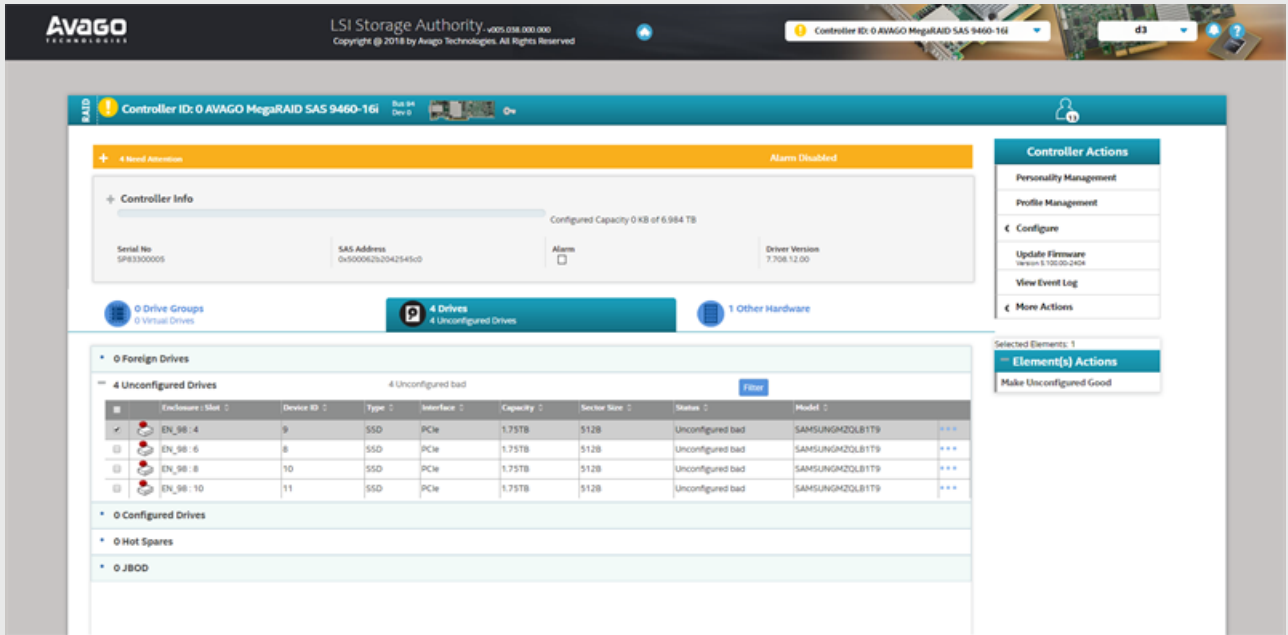

## Importing Foreign Config

Drives that have been imported from another system or that have been changed from unconfigured bad may show up as foreign drives or a foreign configuration.

To import the drives, select the drives that are labelled under **Foreign Drives** and select **Configure** and **Foreign Configuration** from the right side menu.

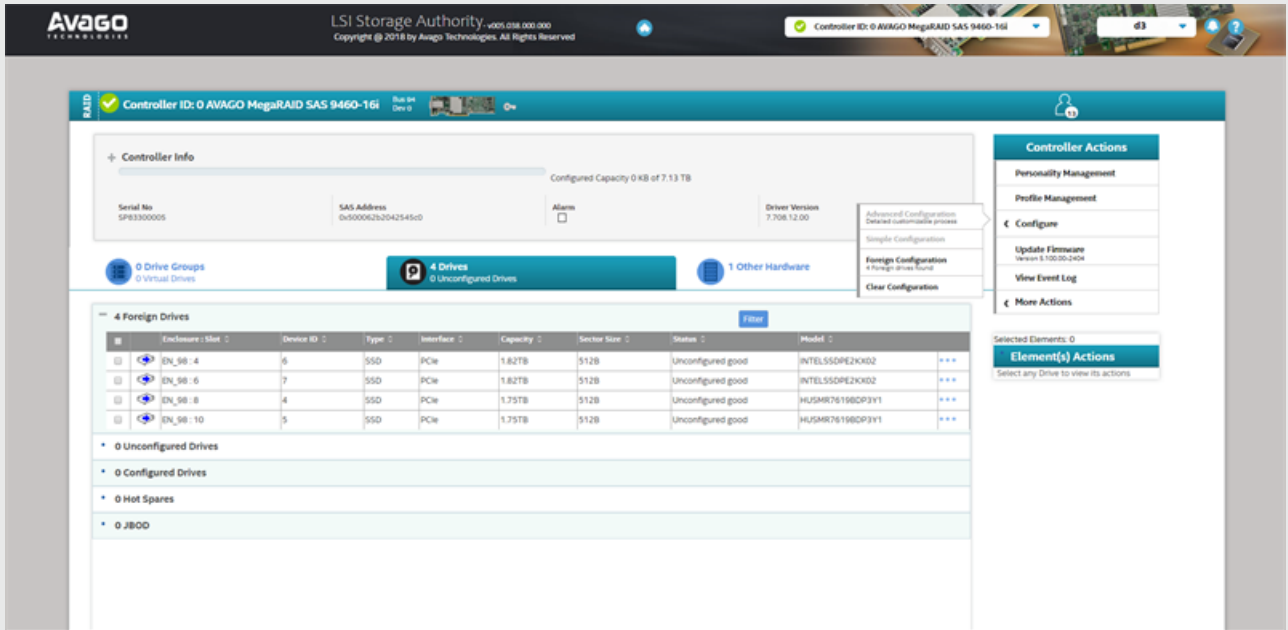

You will then be taken to a page where you can select 'Import' to adopt the foreign configuration. Details of the Virtual Drive will be shown on this page.

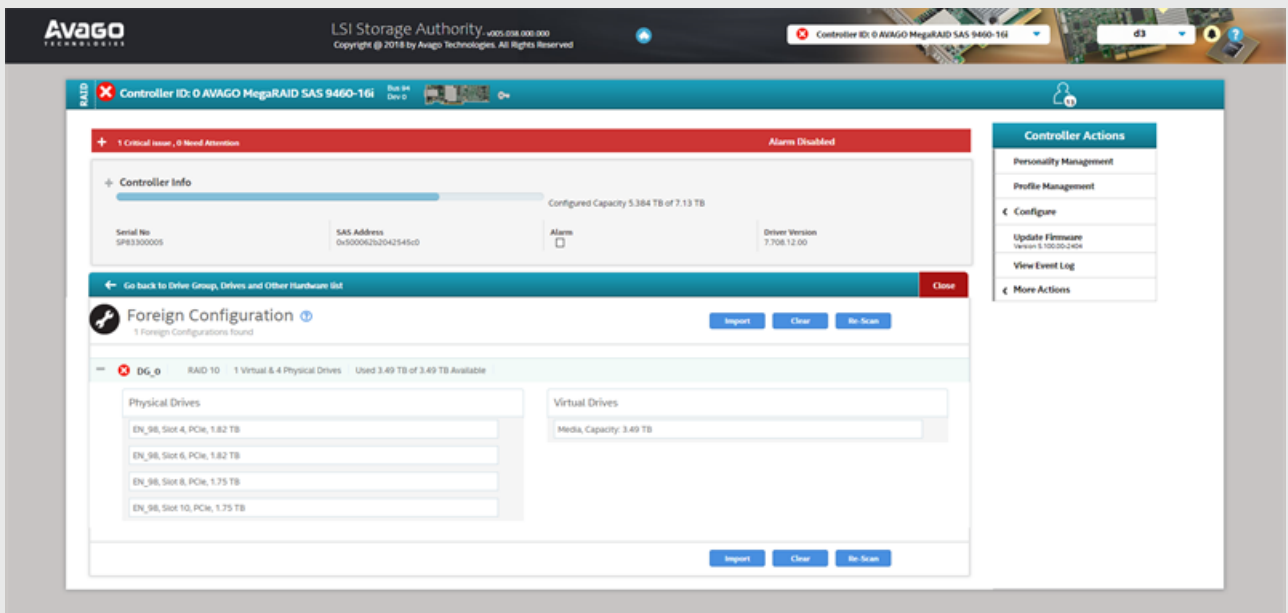



## vx 4 Video input

Your vx 4 system is equipped with a capture card. This card has the ability to capture live video from the following input types.

### Max Number of Unique Inputs

	3G-SDI	12G-SDI
vx 4	16*	0

\*16x 3G inputs with support for quad-3G for 4x 4K inputs (HD-BNC connectors)

### Supported formats

Resolution	Format	Hz
625i (PAL)	interlaced	50.00
525i (NTSC)	interlaced	59.94
1280x720	progressive	23.98, 24, 25, 29.97, 30, 50, 59.94, 60
1920x1080	progressive	23.98, 24, 25, 29.97, 30, 50, 59.94, 60
1920x1080	interlaced	50, 59.94, 60
1920x1080	PsF (Progressive segmented Frame)	23.98, 24, 25, 29.97, 30
1920x1080	A/B	50, 59.94, 60
2048X1080	progressive	23.98, 24, 25, 29.97, 30, 47.952, 48, 50, 59.94, 60
2048x1080	PsF	23.98, 24, 25, 29.97, 30
3840x2160 or 4096x2160	progressive, 8 or 10bit, 2 Sample Interleave or Square Division	23.98, 24, 25, 29.97, 30, 50, 59.94, 60

# Back-Plate Layout

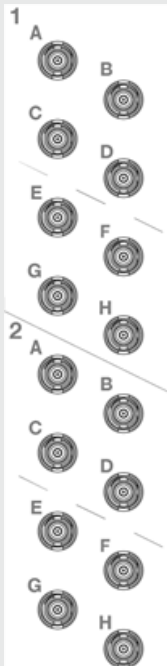

*Diagram of Video Capture BNC connections on rear of unit*

**Please note:** Live Video input inherently introduces frame latency during playback. Please contact [Support](#) for guidance on performance standards.

# Redisguise vx

The process for reimaging a vx server from a USB drive.

The reimaging process we refer to as **Redisguise** is the process of performing an update or restore on the system using a bootable USB drive. This process does not affect the media drive.

**Please note:** If you experience any problems during updating or restoring the system, or any of these instructions are unclear, please contact the [support team](#).



**Warning:** The system needs to be connected to the internet during this procedure

This process can be used to update to a newer OS image, or revert to a previous OS image.

To tell what OS image your system is on please go to the **Help** menu in **d3manager** and select **About Manager**.

If you are updating from an OS earlier than **3.0** your system will do a cold reboot as it performs firmware level updates to some of the components. Please don't be alarmed, just switch the system back on again using the power button

## You will need

- A 32Gb USB memory stick
- A version of [Rufus](#) to turn it into a bootable disk. Make sure the volume name of the usb is: "REDISGUISE" as per image
- An internet connection to the machine you are re-imaging

- Download and install a version of [7Zip](#)
- Download and unzip the multi file archive using 7Zip
- OS images can be found [here](#).

**Please note:** You do not need to extract all parts individually. Simply place them in the same directory and then use 7zip to extract the ISO by selecting any part. 7zip will automatically unzip all parts to create the image file.

## Create Bootable USB device

1. Download and unzip the multi file archive using 7Zip (NOTE: you will only need to unzip file 001):

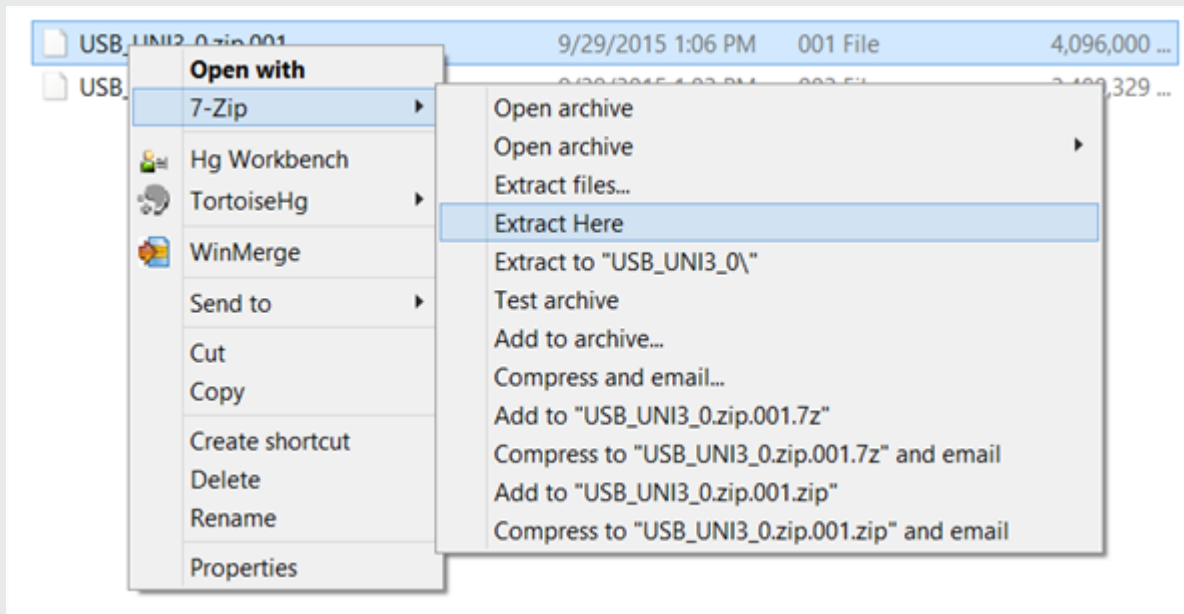

2. Create Bootable USB stick with the unzipped ISO.

The settings should be:

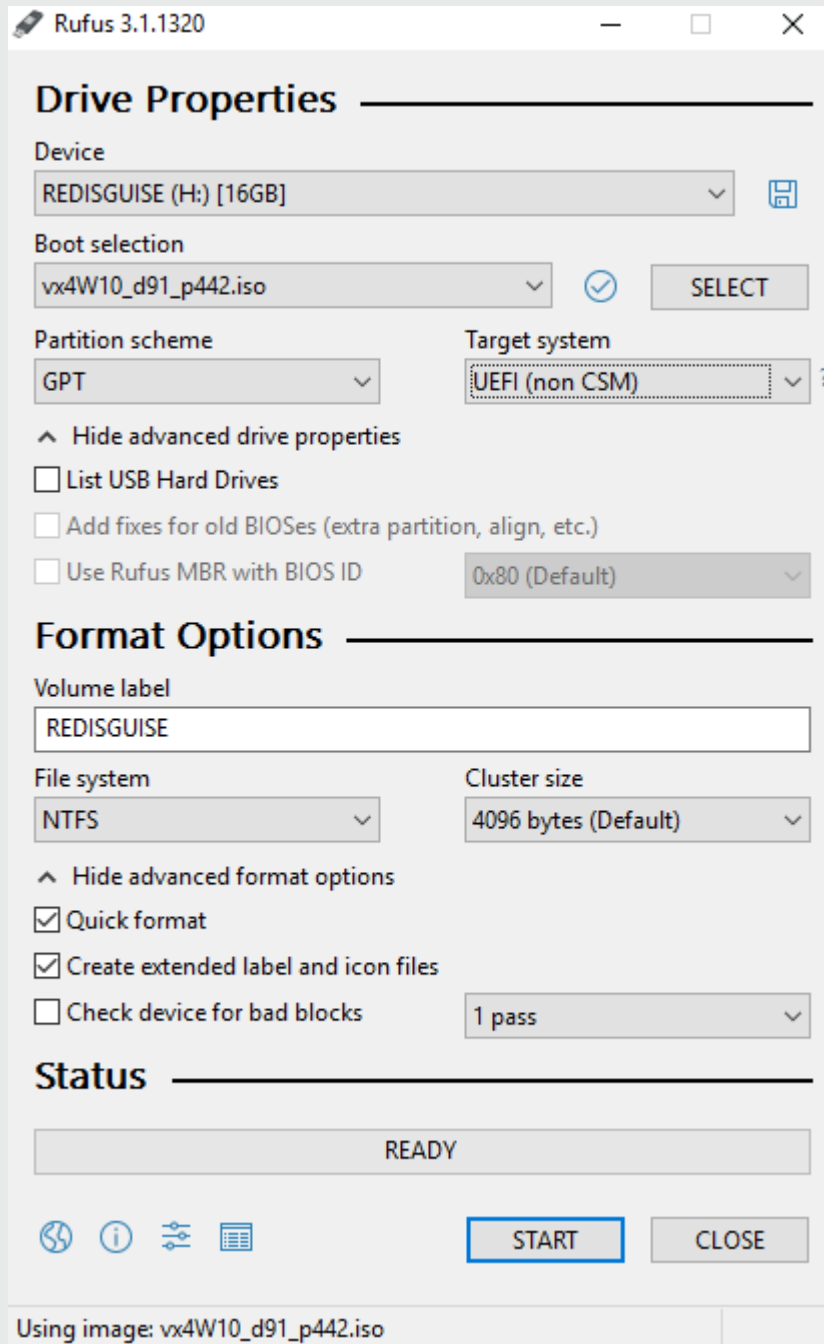

— **Partition scheme** - GPT (vx range)

— **Target system** - UEFI - non CSM

- **Volume label** - automatically pulled from ISO file
- **File system** - NTFS



**Warning:** These settings are critically important. The re-image process will fail if they are not set correctly.

## Booting into the USB

1. Go into the BIOS by hitting Delete on the logo splash screen during boot.
2. Change the Boot option #1 to the USB stick
3. Navigate to the Advanced tab and press enter to view the CSM Configuration and ensure that Boot option filter is set to [UEFI and Legacy]. Change it if it is not, then press F4, confirm and re-enter BIOS.
4. Once this setting is confirmed, navigate to the Save & Exit tab. It is just to the right of the Boot tab.
5. In the Boot Override section at the bottom there is a UEFI: USB, Partition 2. This may vary depending on the manufacturer of USB stick in use. Select this option to begin the OS upgrade process.

**Please note:** performing a system restore from the new disk image will erase any valuable data on your system drive. Please ensure you make a back up of any essential files from your system (C:) drive before initialising this process. The process does NOT destroy any media or projects on your media drive.

## vx 4+ overview



**Warning: Opening hardware may void your warranty. Consult Disguise support before opening the hardware.**

The vx 4+ comes pre-installed with the latest software version, enabling you to design, configure and sequence the show on the same machines as you later use for show playback.

For detailed information on the specifications for each plus and pro machine, as well as the other software and hardware bundles offered by Disguise, please see the [Products](#) section of our web site.

**Please note:** If you experience any problems with hardware please contact the [support team](#)

# vx 4+ diagrams

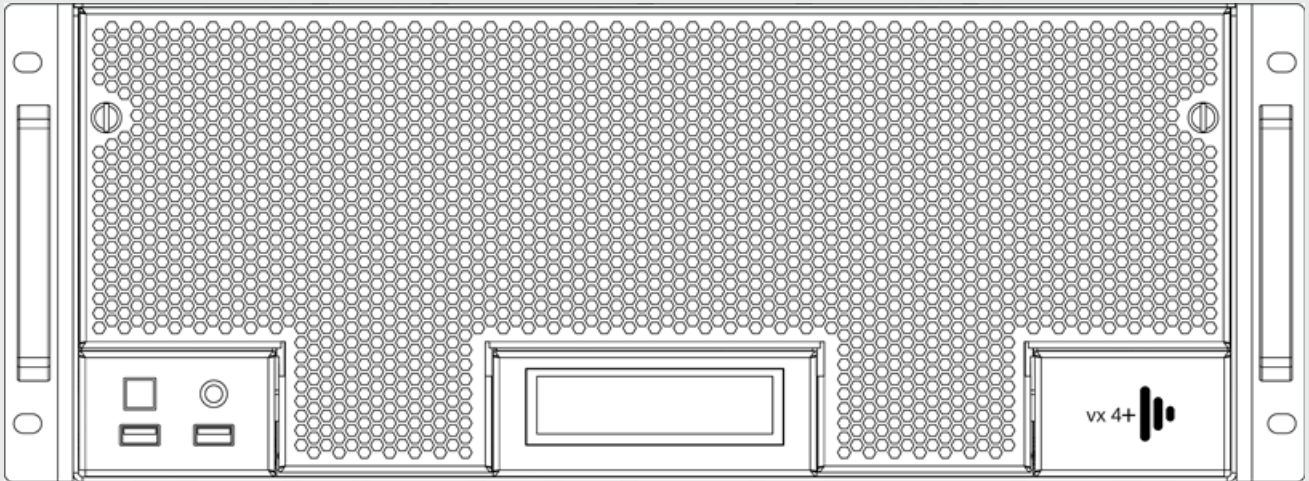

vx 4+ front panel

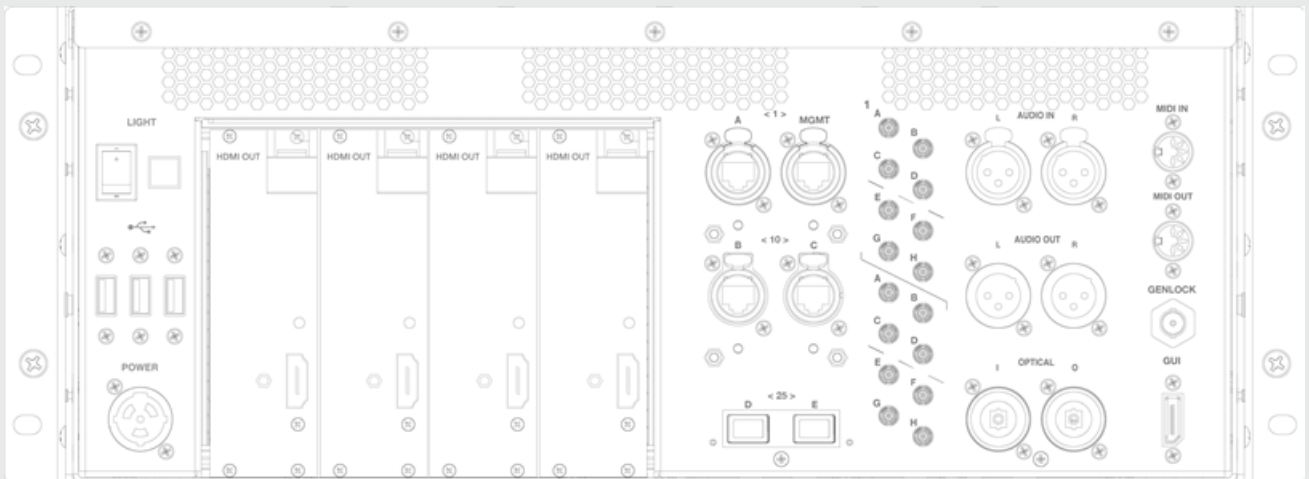

vx 4+ rear panel



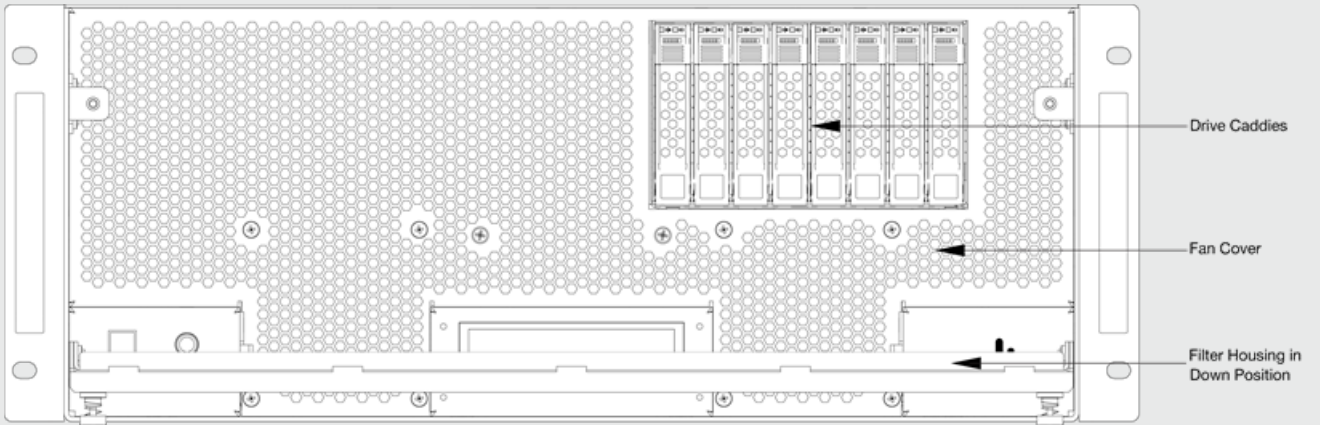

vx 4+ front panel grill down

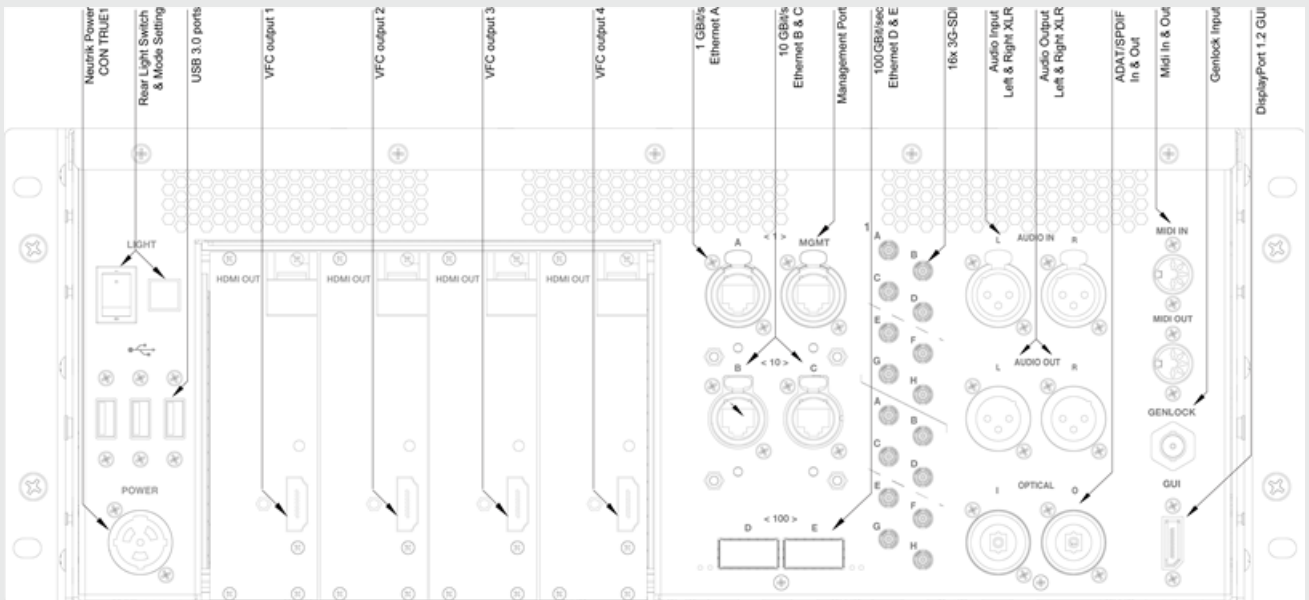

vx 4+ rear panel annotated

# vx 4+ Hard drive configuration



**Warning:** Do not remove drives when the machine is on as data may be corrupted if this occurs.

**Please note:** If you ever need to replace or exchange your media drive it is recommended that you use a drive with similar read/write speeds. For further information please contact the [support team](#).

## Media drives

The vx 4+ comes with 4x NVMe SSD drives.

These drives are removable from the drive bay. It is possible to user-reconfigure the RAID configuration using software in Windows to control the dedicated RAID controller hardware.

The cage contains eight caddies, four populated with a single SSD. Drives are configured as RAID10.

To reveal the drive bay undo the two thumb screws on the front of the unit. See diagram below.

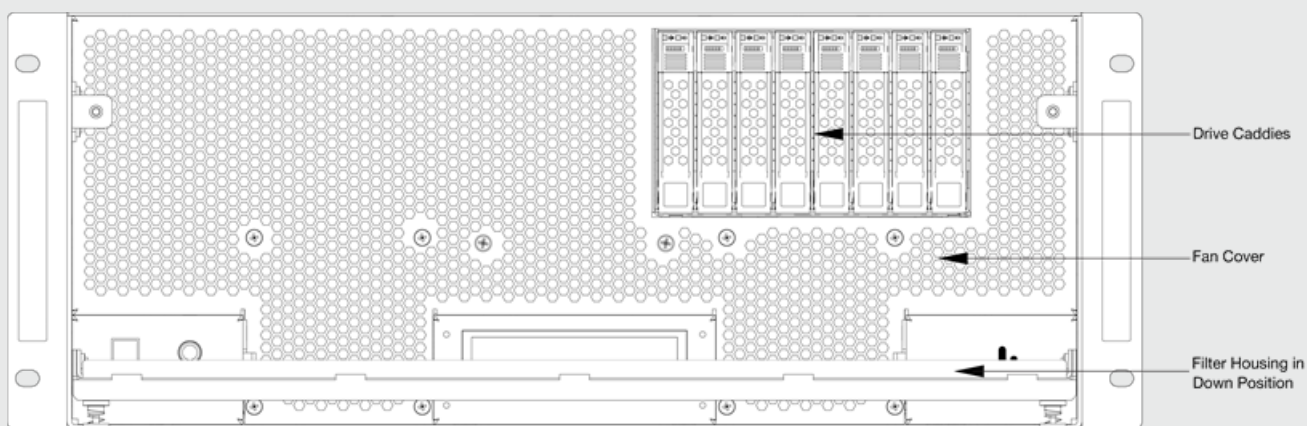

*Location of drive bays on the vx 4+units.*

# RAID Configuration

**Please note: The drives used in this guide were for examples and you will likely have a different setup in your RAID. If you want to know information about what drives are required/ recommended then please contact [support@disguise.one](mailto:support@disguise.one)**

## Logging in to the RAID controller

In order to login and configure your RAID, you must ensure that your server has a password setup for the user account.

1. Open the Windows start menu and select LSA.
2. On the LSA landing page, select the server with your local IP address (multiple will show if on a network with more than one vx 4).

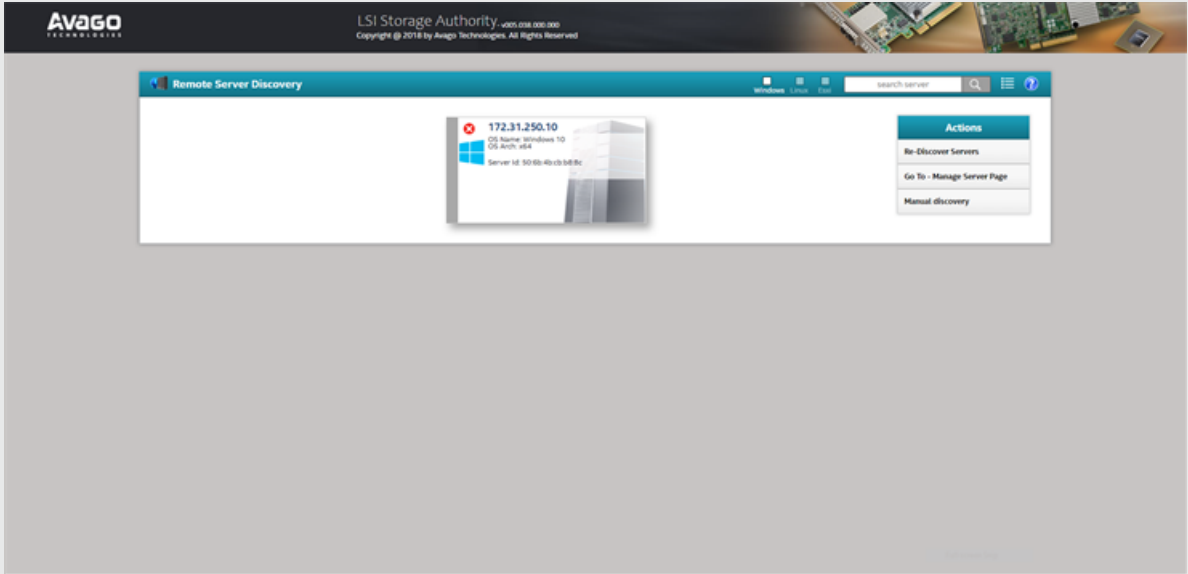

3. Enter your login details of the local user account (default is Username: d3, Password: NOT SET)

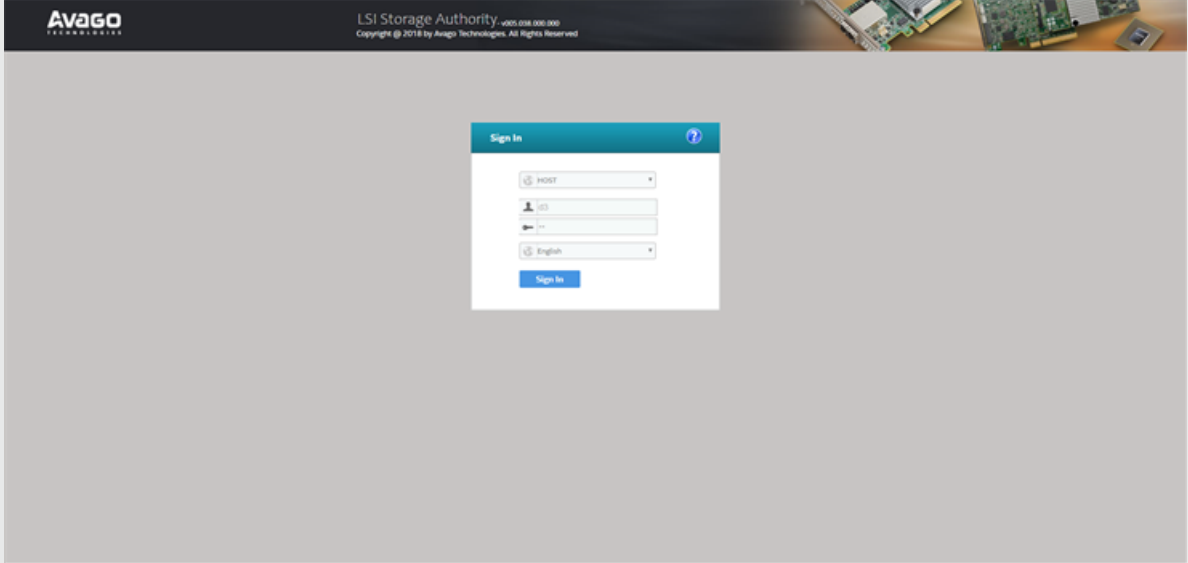

# Overview of the RAID

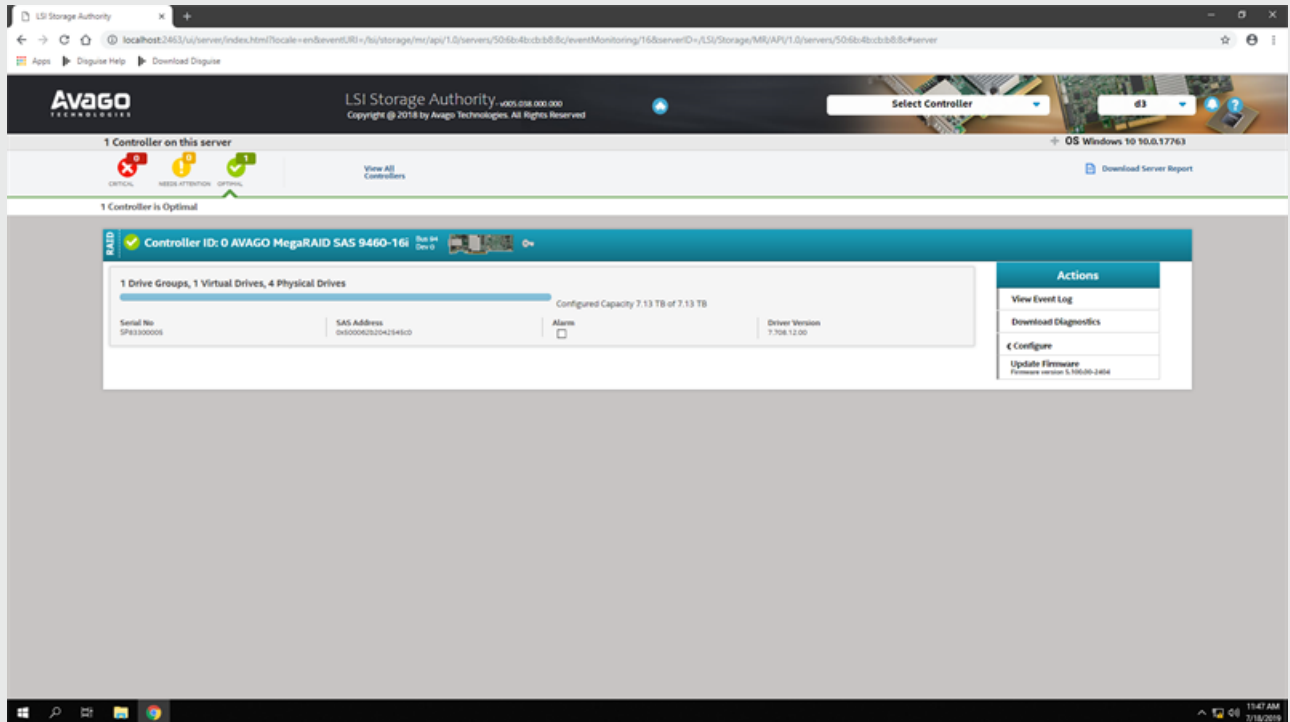

On the landing page you will see information about the controller within the system. This will alert you to any issues, the current capacity and how many drives are present.

1. Select the controller from the **Select Controller** dropdown menu at the top of the page.

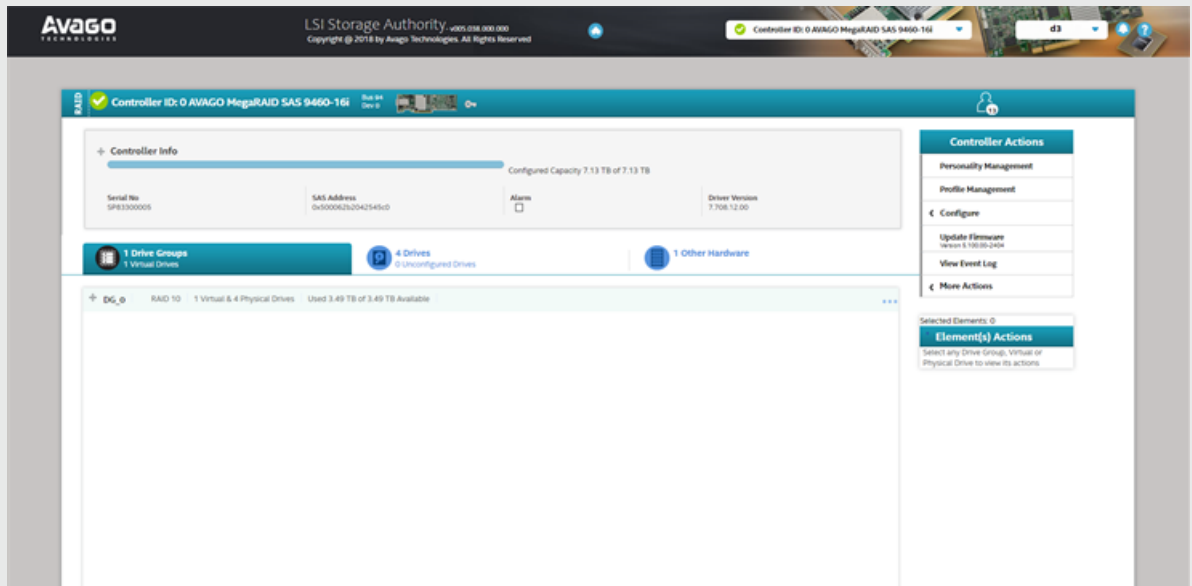

2. On the controller landing page you are able to find out more detailed information about the controller itself and the drives within the system.
3. The first tab shown contains extra information into the Virtual Drive, RAID Level etc.

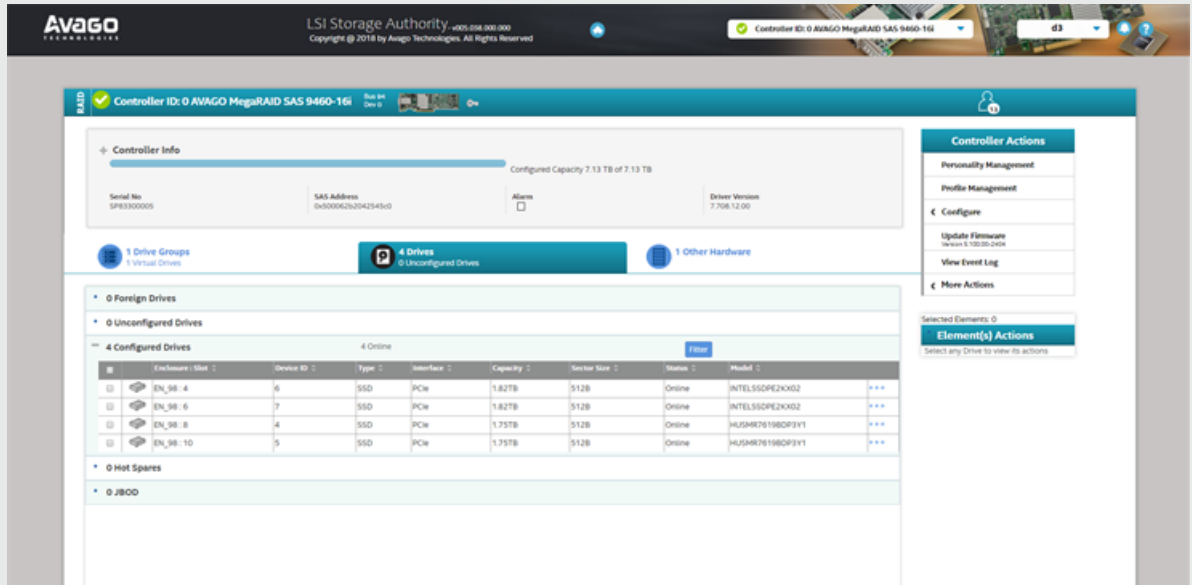

4. From the drive information page you should look to do any configuration.

## Creating a RAID

1. If you want to create a new RAID, click on the **Configure** tab on the far right of the page.
2. Select **Advanced Configuration** to ensure you get all available options.

Avago Technologies LSI Storage Authority v005.054.000.000 Copyright © 2018 by Avago Technologies. All Rights Reserved. Controller ID: 0 AVAGO MegaRAID SAS 9460-16i d3

RAID Controller ID: 0 AVAGO MegaRAID SAS 9460-16i Serial No: 9P83300005 SAS Address: 0x500042c0042545c0 Alarm: [ ] Driver Version: 7.706.13.000

Configured Capacity: 0 KB of 7.13 TB

0 Drive Groups 0 Virtual Drives 4 Drives 4 Unconfigured Drives 1 Other Hardware

Advanced Configuration: Default customizable profile  
Simple Configuration: Storage Configuration: 8 Health, Clear Configuration

Controller Actions: Personality Management, Profile Management, Configure, Update Firmware (version 8.100.00-2404), View Event Log, More Actions

Selected Elements: 0 Element(s) Actions: Select any Drive to view its actions

#	Enclosure / Slot	Device ID	Type	Interface	Capacity	Sector Size	Status	Model
4 Unconfigured Drives 4 Unconfigured good								
1	EN_08-4	6	SSD	PCIe	1.82TB	512B	Unconfigured good	INTELSSDPE2K002
2	EN_08-6	7	SSD	PCIe	1.82TB	512B	Unconfigured good	INTELSSDPE2K002
3	EN_08-8	4	SSD	PCIe	1.75TB	512B	Unconfigured good	HUSM876198CP3Y1
4	EN_08-10	5	SSD	PCIe	1.75TB	512B	Unconfigured good	HUSM876198CP3Y1
0 Configured Drives								
0 Hot Spares								
0 JBOD								

- The default and recommended setup is RAID 10. This should be selected to meet any performance stats released by disguise.



**Warning:** If the RAID is set up at a different level you could be at risk of losing your data without redundancy.



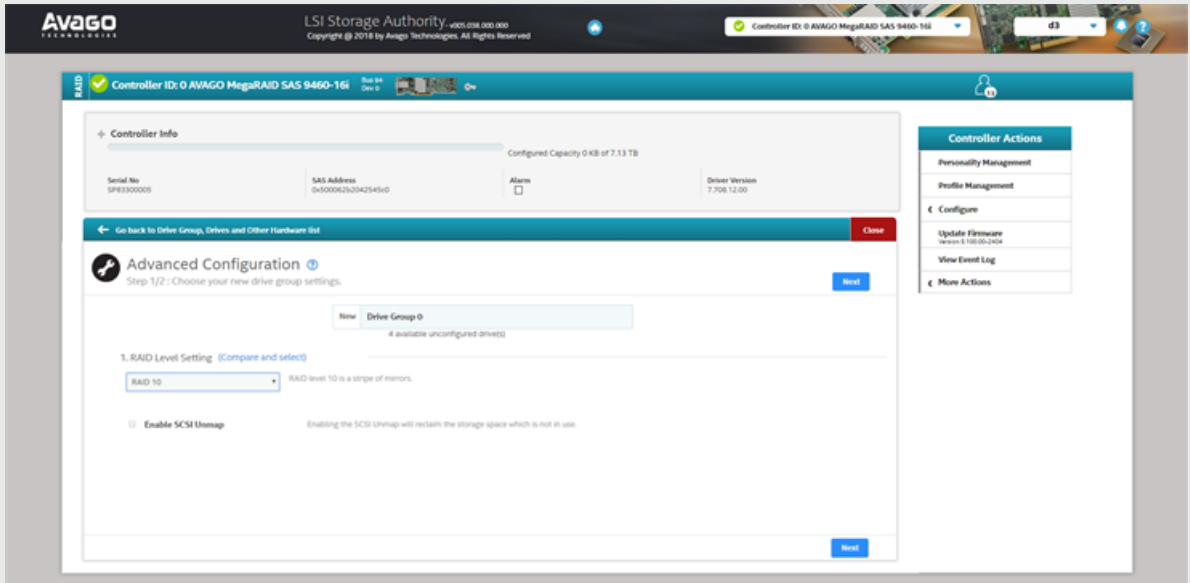

- Continue to the next page and select **Add Physical Drives** to choose which drives you are going to put into an array. RAID 10 requires a minimum of 4 drives to be set up.

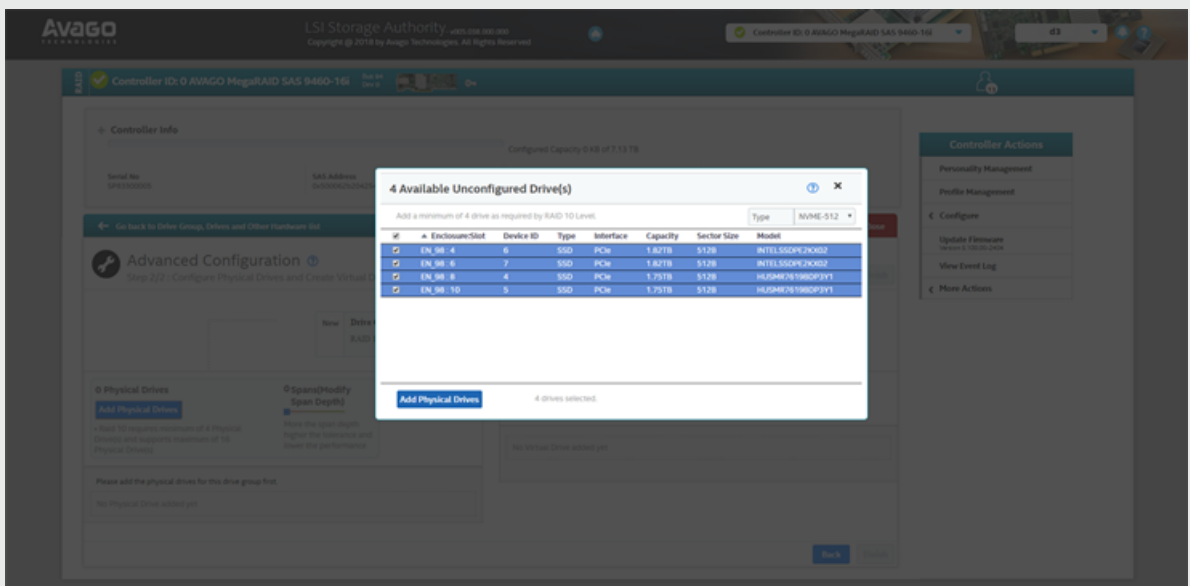

5. Once the drives have been selected, click on **Add Virtual Drives**. The default configuration is as below and should be followed to ensure no issues.

- **Virtual Drive Name** - Media
- **Strip size** - 256 KB
- **Initialization State** - No Initialization
- **Read Policy** - Always Read Ahead
- **Write Policy** - Write Through
- **I/O Policy** - Direct IO
- **Disk Cache Policy** - Unchanged

6. When all settings are set. Click **Add Virtual Drives**.

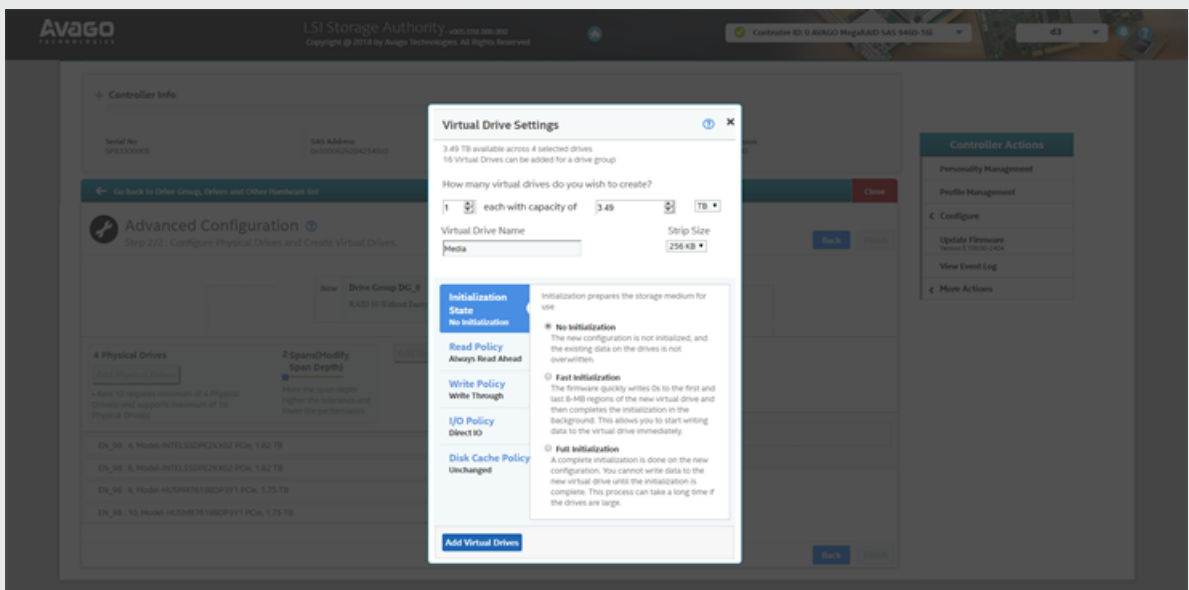

7. Continue through the wizard by selecting **Finish**.

8. You will then be presented a completion page showing the details of the configured RAID.

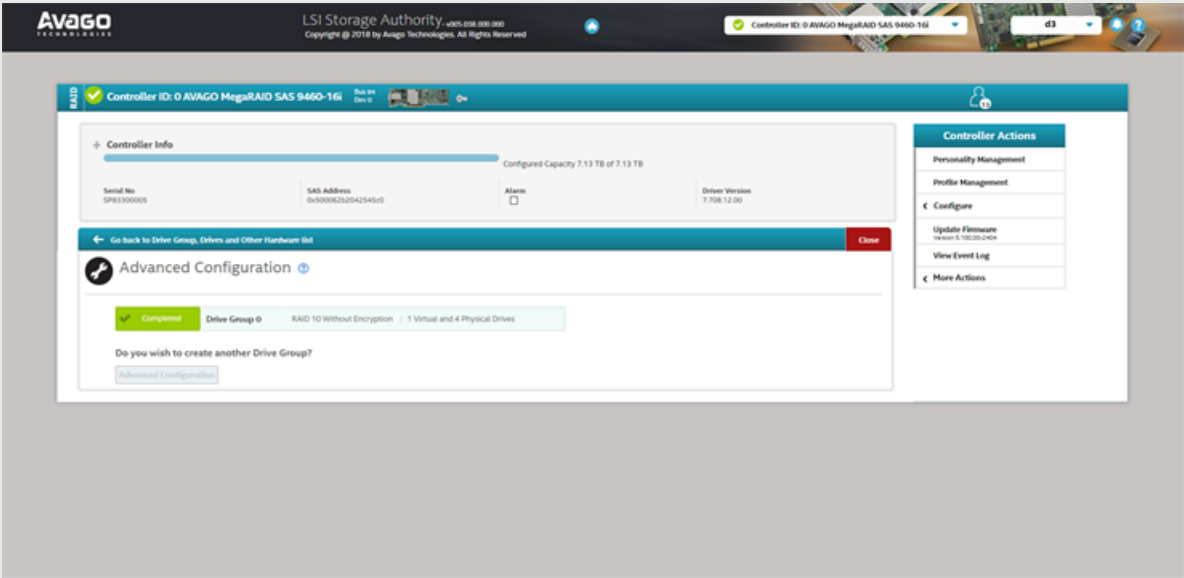

# Unconfigured Good/Bad

Unconfigured Good drives are ready to be configured into a RAID.

Avago Technologies LSI Storage Authority v001.038.000.000 Copyright © 2018 by Avago Technologies. All Rights Reserved

Controller ID: 0 AVAGO MegaRAID SAS 9460-16i Bus on Dev 0

Configured Capacity 0 KB of 7.13 TB

Serial No: SP83300005 SAS Address: 0x50000262042545c0 Alarm:  Driver Version: 7.308.12.00

0 Drive Groups (0 Virtual Drives) 4 Drives (2 Unconfigured) 1 Other Hardware

Foreign Drives: 4 Unconfigured good

#	Enclosure Slot	Device ID	Type	Interface	Capacity	Sector Size	Status	Model	
1	EN_98: 4	6	SSD	PCIe	1.82TB	512B	Unconfigured good	INTELSSDPE2X002	***
2	EN_98: 6	7	SSD	PCIe	1.82TB	512B	Unconfigured good	INTELSSDPE2X002	***
3	EN_98: 8	4	SSD	PCIe	1.75TB	512B	Unconfigured good	HUSM876198DP3Y1	***
4	EN_98: 10	5	SSD	PCIe	1.75TB	512B	Unconfigured good	HUSM876198DP3Y1	***

0 Configured Drives

0 Hot Spares

0 JBOD

Controller Actions: Personality Management, Profile Management, Configure, Update Firmware (Version 5.100.00-2404), View Event Log, More Actions

Selected Elements: 0

Element(s) Actions: Select any Drive to view its actions

Unconfigured Bad drives must first be made into unconfigured good drives before any configuration can be done. If a drive (or drives) is showing up as unconfigured bad then select it (one by one) and click on **Make Unconfigured Good** on the right hand side.

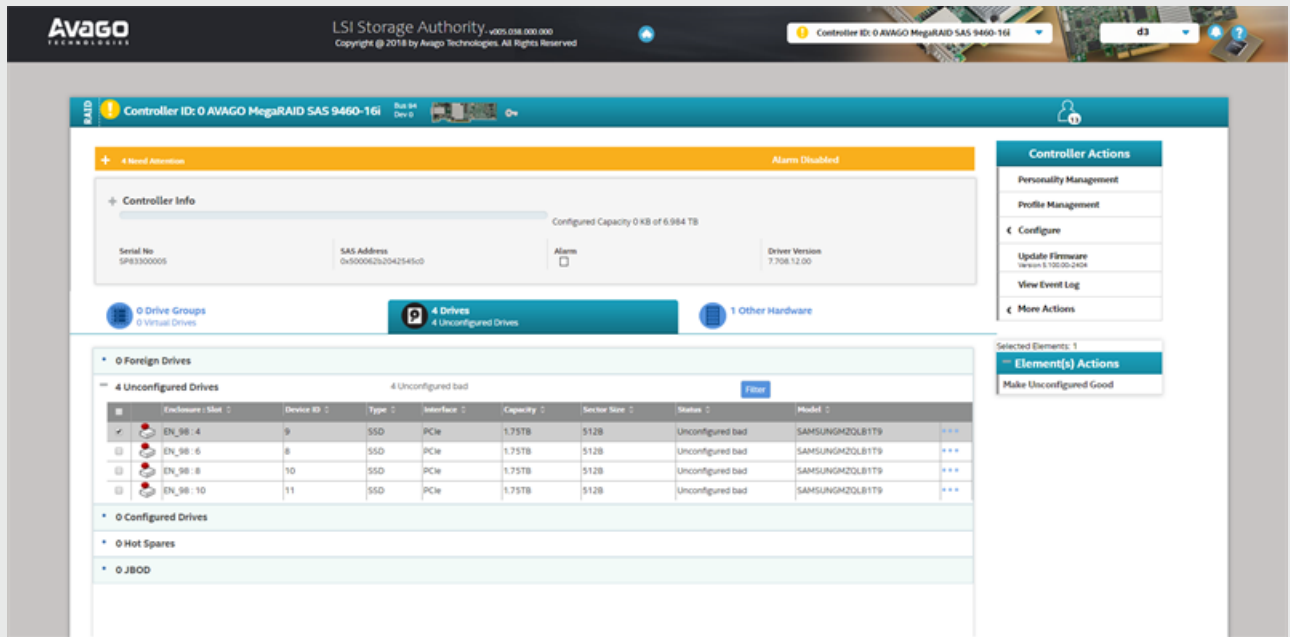

## Importing Foreign Config

Drives that have been imported from another system or that have been changed from unconfigured bad may show up as foreign drives or a foreign configuration.

To import the drives, select the drives that are labelled under **Foreign Drives** and select **Configure** and **Foreign Configuration** from the right side menu.

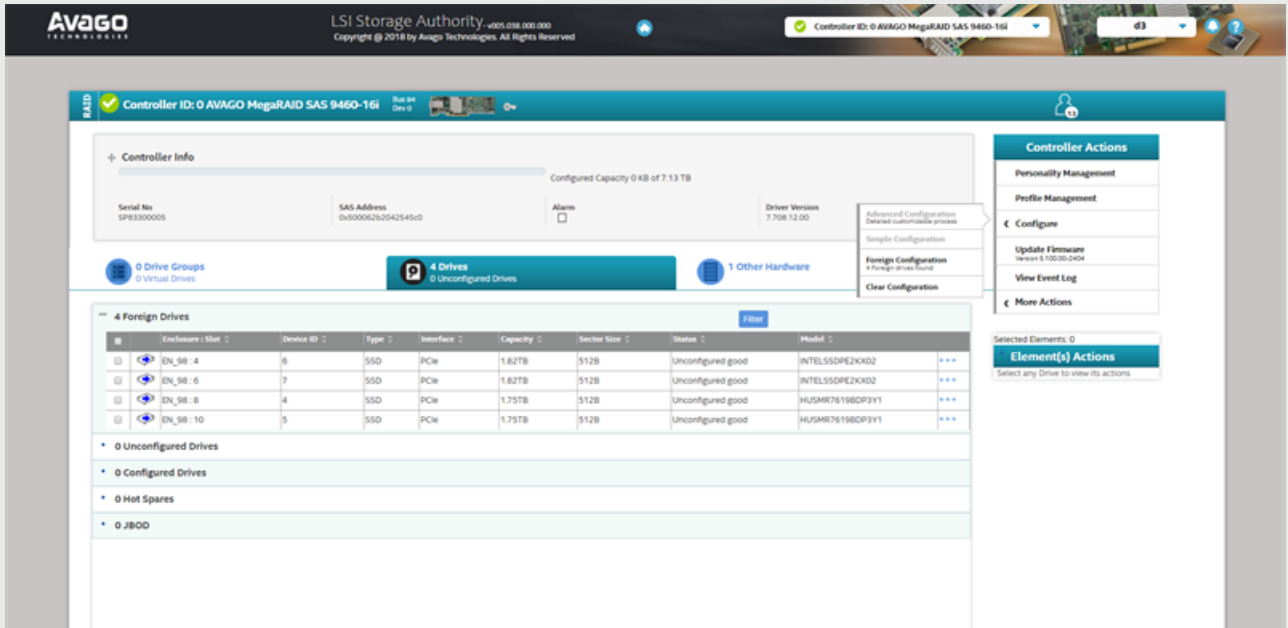

You will then be taken to a page where you can select 'Import' to adopt the foreign configuration. Details of the Virtual Drive will be shown on this page.

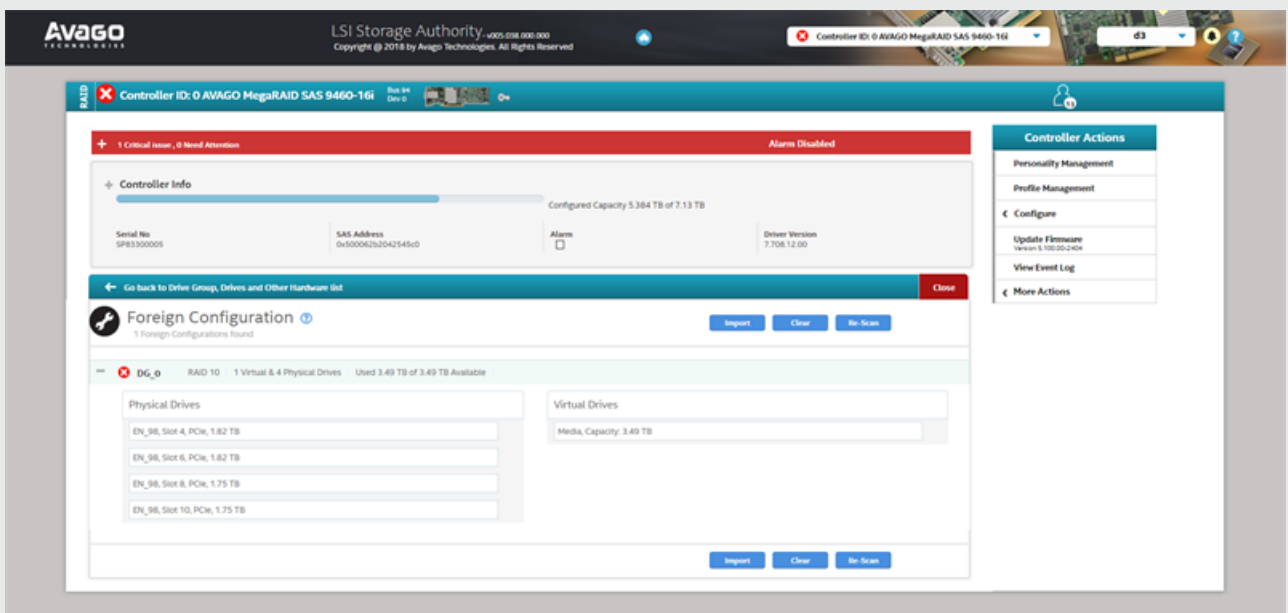

## vx 4+ Video input

Your vx 4+ system is equipped with a capture card. This card has the ability to capture live video from the following input types.

### Max Number of Unique Inputs

	3G-SDI	12G-SDI
vx 4+	16	4

### Supported formats

Resolution	Format	Hz
625i (PAL)	interlaced	50.00
525i (NTSC)	interlaced	59.94
1280x720	progressive	23.98, 24, 25, 29.97, 30, 50, 59.94, 60
1920x1080	progressive	23.98, 24, 25, 29.97, 30, 50, 59.94, 60
1920x1080	interlaced	50, 59.94, 60
1920x1080	PsF (Progressive segmented Frame)	23.98, 24, 25, 29.97, 30
1920x1080	A/B	50, 59.94, 60
2048X1080	progressive	23.98, 24, 25, 29.97, 30, 47.952, 48, 50, 59.94, 60
2048x1080	PsF	23.98, 24, 25, 29.97, 30
3840x2160 or 4096x2160	progressive, 8 or 10bit, 2 Sample Interleave or Square Division	23.98, 24, 25, 29.97, 30, 50, 59.94, 60

# Back-Plate Layout

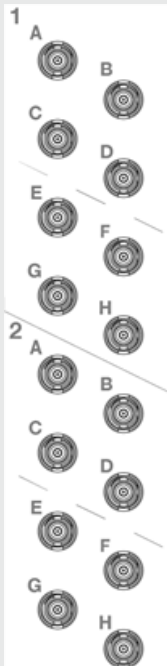

*Diagram of Video Capture BNC connections on rear of unit*

**Please note:** Live Video input inherently introduces frame latency during playback. Please contact [Support](#) for guidance on performance standards.



# Update & restore

Update & restore is the process of doing an update or restore on the system using a bootable USB drive. This process does not affect the media drive.

**Please note:** If you experience any problems during updating or restoring the system, or any of these instructions are unclear, please contact the [support team](#).



**Warning:** The system needs to be connected to the internet during this procedure

## You will need

- A 16Gb USB memory stick
- A version of [Rufus](#) to turn it into a bootable disk. Make sure the volume name of the usb is: "REDISGUISE".
- An internet connection to the machine you are re-imaging
- Download and install a version of [7Zip](#)
- Download and unzip the multi file archive using 7Zip
- OS images can be found [here](#).

**Please note:** You do not need to extract all parts individually. Simply place them in the same directory and then use 7zip to extract the ISO by selecting any part. 7zip will automatically unzip all parts to create the image file.

# Create a Bootable USB

1. Download and unzip the multi file archive using 7Zip (NOTE: you will only need to unzip file 001):

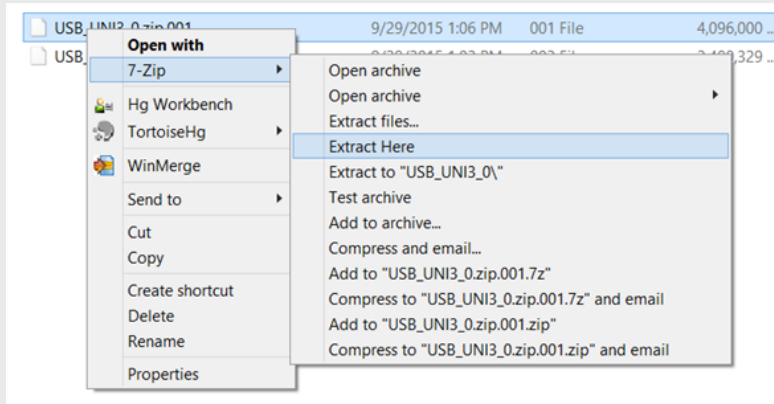

2. Create Bootable USB stick with the unzipped ISO.

The settings should be:

- **Partition scheme** - GPT (vx range)
- **Target system** - UEFI - non CSM
- **Volume label** - automatically pulled from ISO file
- **File system** - NTFS



**Warning:** These settings are critically important. The re-image process will fail if they are not set correctly.

**Please note:** On the latest versions of Rufus you may see this warning. This is expected and does not apply to current disguise hardware. Please click **OK** to continue as normal.

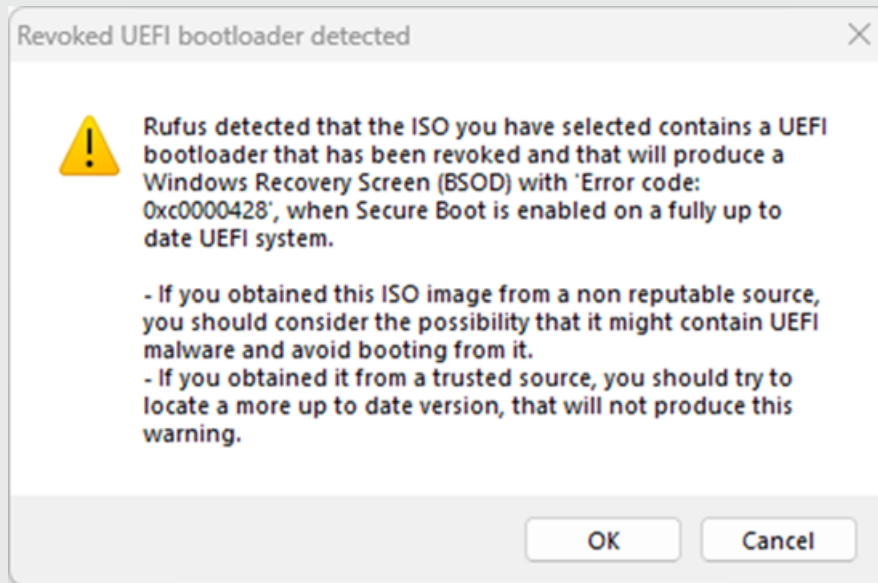

## Booting into the USB

1. Go into the BIOS by hitting Delete on the logo splash screen during boot.
2. Change the Boot option #1 to the USB stick
3. Navigate to the Save & Exit tab. It is just to the right of the Boot tab.
4. In the Boot Override section at the bottom there is a UEFI: USB, Partition 2. This may vary depending on the manufacturer of USB stick in use. Select this option to begin the OS upgrade process.

**Please note:** performing a system restore from the new disk image will erase any valuable data on your system drive. Please ensure you make a back up of any essential files from your system (C:) drive before initialising this process. The process does NOT destroy any media or projects on your media drive.

# Common Operations - vx range



**Warning: Opening hardware may void your warranty. Consult Disguise support before opening the hardware.**



**Warning: do not open or remove the case unless you are instructed to do so by a certified Disguise Engineer**

**Please note: If you experience any problems with hardware please contact the [support team](#)**

## Common Operations

These operations are common to all servers in the vx range:

- [How to start the vx](#)
- [Unit Rear light](#)
- [Powering the vx](#)
- [Audio Input and Output](#)
- [4K Output](#)
- [SMC](#)

# Powering the pro range

The pro and gx ranges of disguise servers use Neutrik powerCON TRUE1 as the power input. The TRUE1 is:

- Lockable
- Live-Mating (safely)
- Extendable
- Dust and water resistant according to IP65 in mated condition

To power a server, you should use a cable with the following attributes:

- SJT flexible cord, min. 12AWG, min. 300V, min. 60v dm;C, max 4.5 m long
- One end terminated with NEMA 5-15P/BS 1363/CEE 7 plug
- Other end terminated with appliance coupler type Neutrik AG, type NAC3FX

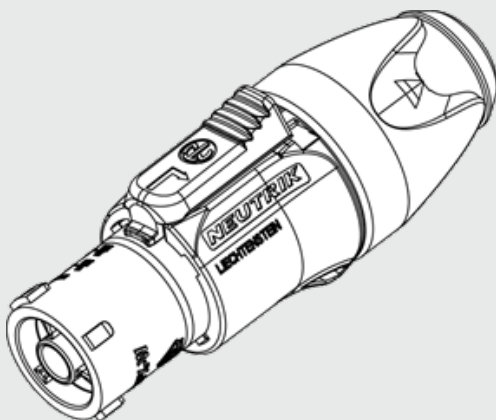

*Neutrik powerCON TRUE1 connector*

# How to start the vx

## Starting the Unit

1. Connect Power cord to the vx server.
2. Make sure you have connected a keyboard, mouse and monitor to the primary graphics output.
3. Press the power button on the front of the unit and wait for the system to load into Windows.

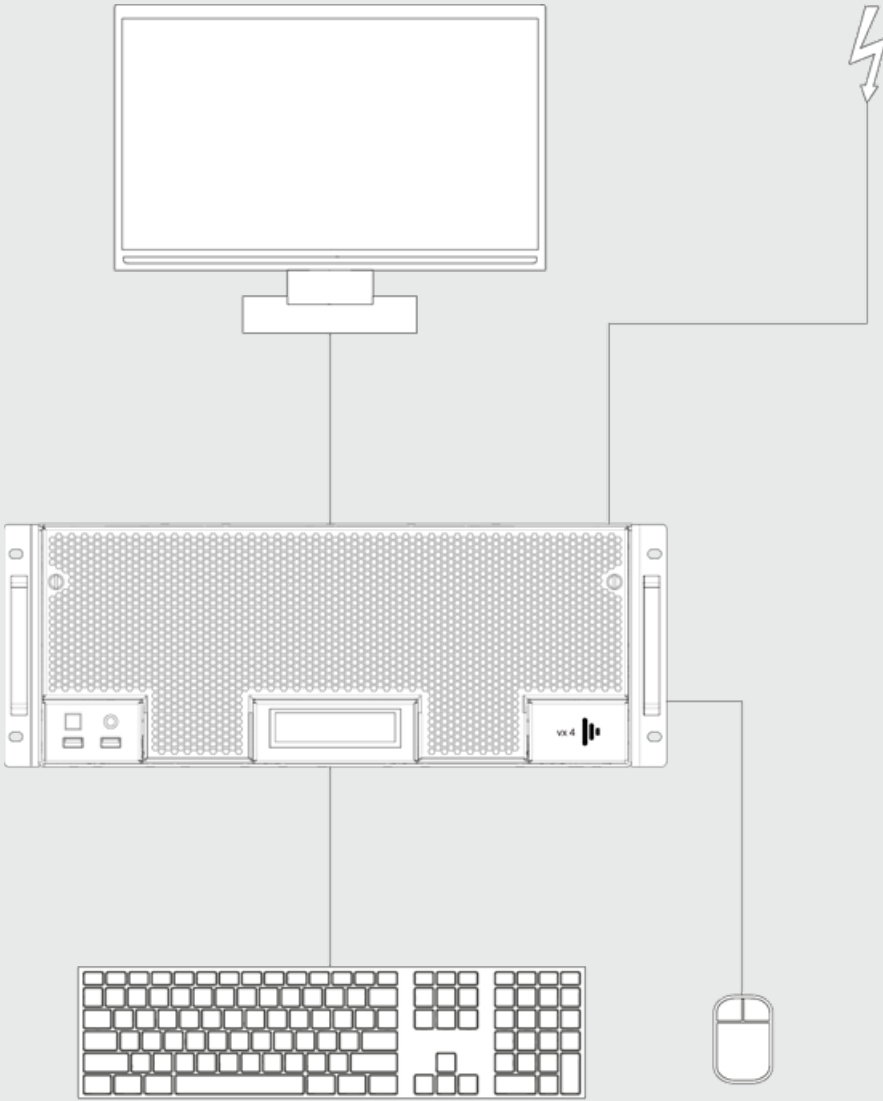

1

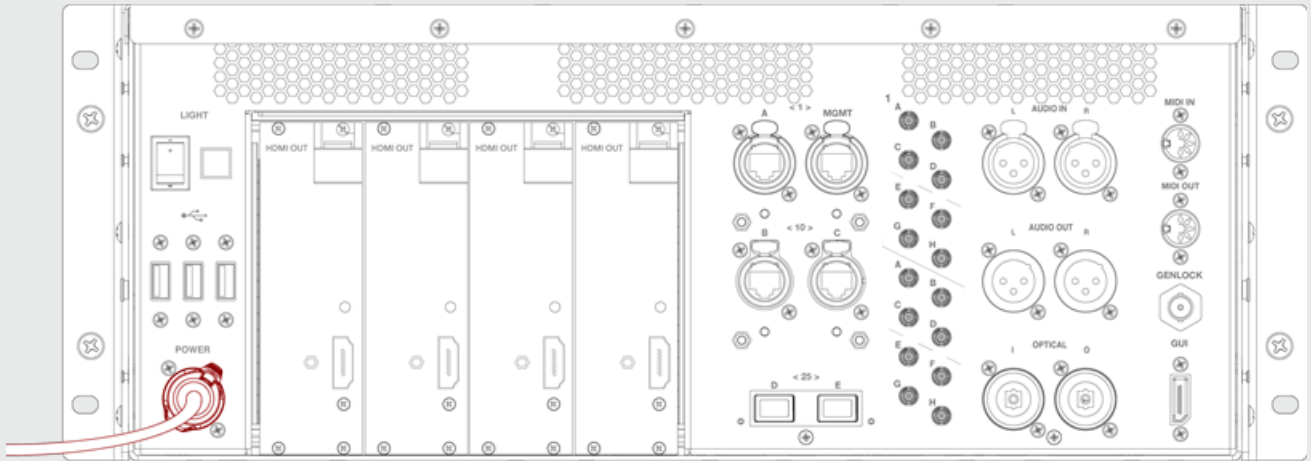



# Unit rear light

Disguise servers in the pro and gx ranges come with the addition of an LED light on the back of the unit that illuminates the connections on the rear panel.

The light can be turned on or off using the switch labeled "light" with power in. The intensity of the light can be altered using the button alongside the switch.

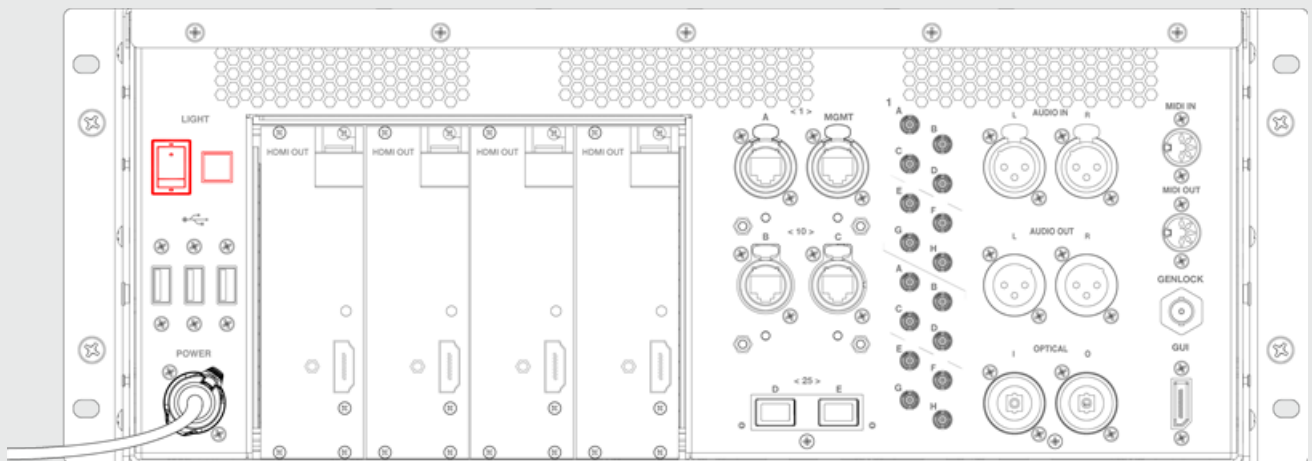

# Managing EDIDs

## Emulating EDIDs

1. Navigate to the "View system topology" tab

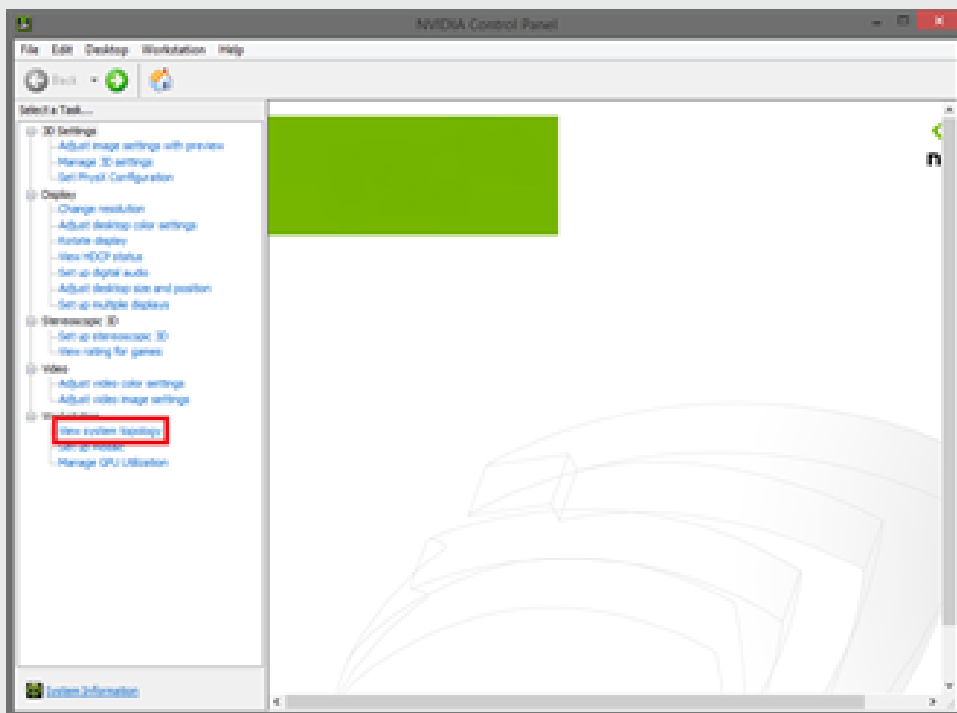

2. Click the EDID button next to a card connection (DVI or DisplayPort)

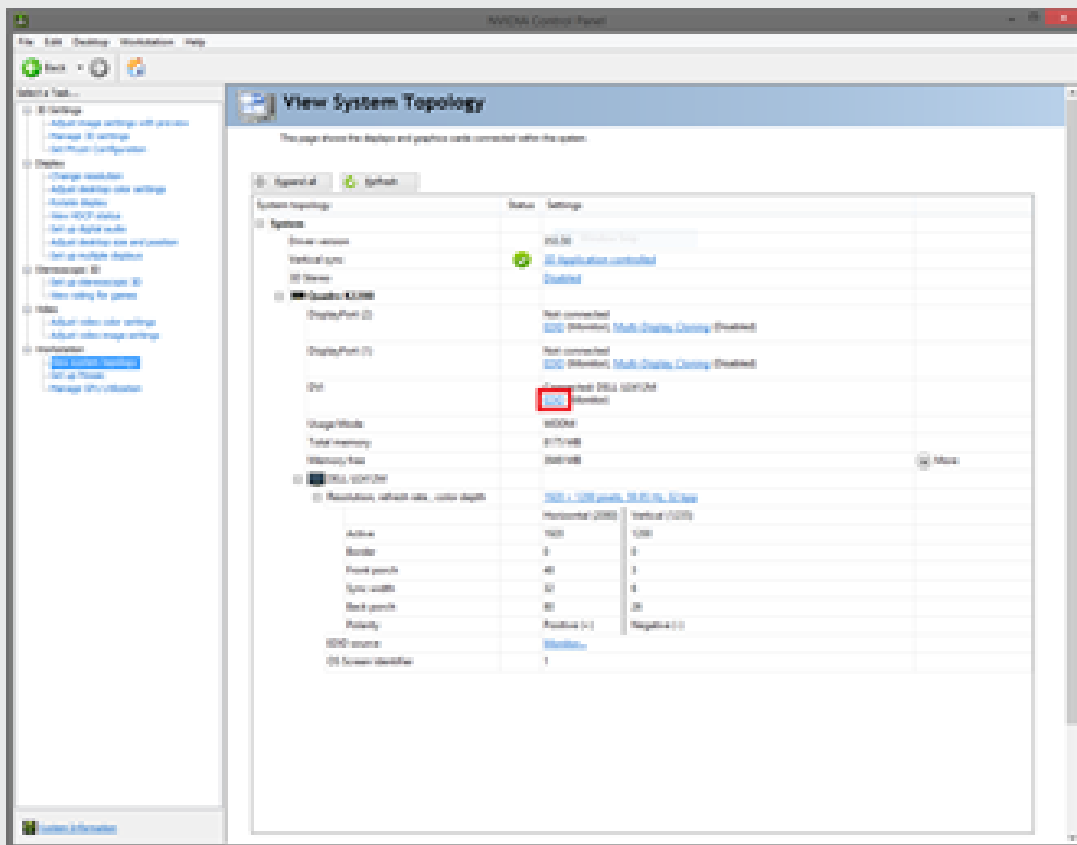

3. Navigate to the "Load" tab inside the Manage EDID window
4. Browse to your preferred EDID and select which display connections you want to emulate the EDID on.

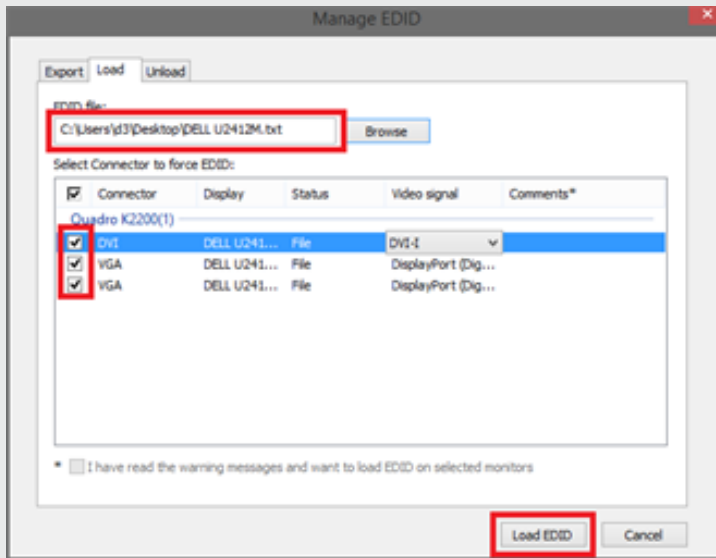

5. After the EDID is successfully applied you will see this  small icon which indicates that the display connection has an emulated EDID associated with it.

## View System Topology

This page shows the displays and graphics cards connected with the system.

Expand all Refresh

System topology	Status	Settings
<b>System</b>		
Driver version		314.39
Vertical sync	✔	3D Application controlled
3D Stereo		Disabled <span style="float: right;"><a href="#">Windows Setup</a></span>
<b>Quadro RTX 5000</b>		
VGA	✔	Connected (Dell U2412M (2 of 3) 120 (File) <a href="#">Multi-Display-Cleaning</a> (Disabled)
VGA	✔	Connected (Dell U2412M (1 of 3) 120 (File) <a href="#">Multi-Display-Cleaning</a> (Disabled)
DVI	✔	Connected (Dell U2412M (2 of 3) 120 (File)
Usage Mode		WDDM
Total memory		8175 MB
Memory free		3648 MB <span style="float: right;"><a href="#">More</a></span>
<b>Dell U2412M (2 of 3)</b>		
<b>Resolution, refresh rate, color depth</b> <a href="#">120 x 120 pixels, 60 Hz, 32-bit</a>		
		Horizontal (DPR) Vertical (LPR)
Active	1600	1200
Border	0	0
Front porch	48	3
Sync width	31	4
Back porch	80	26
Polarity	Positive (+)	Negative (-)
EDID source	✔	<a href="#">File</a>
OS Screen Identifier		3
<b>Dell U2412M (1 of 3)</b>		
<b>Resolution, refresh rate, color depth</b> <a href="#">120 x 120 pixels, 60 Hz, 32-bit</a>		
		Horizontal (DPR) Vertical (LPR)
Active	1600	1200
Border	0	0
Front porch	48	3
Sync width	31	4
Back porch	80	26
Polarity	Positive (+)	Negative (-)

# Exporting EDIDs

1. Navigate to the "View system topology" tab

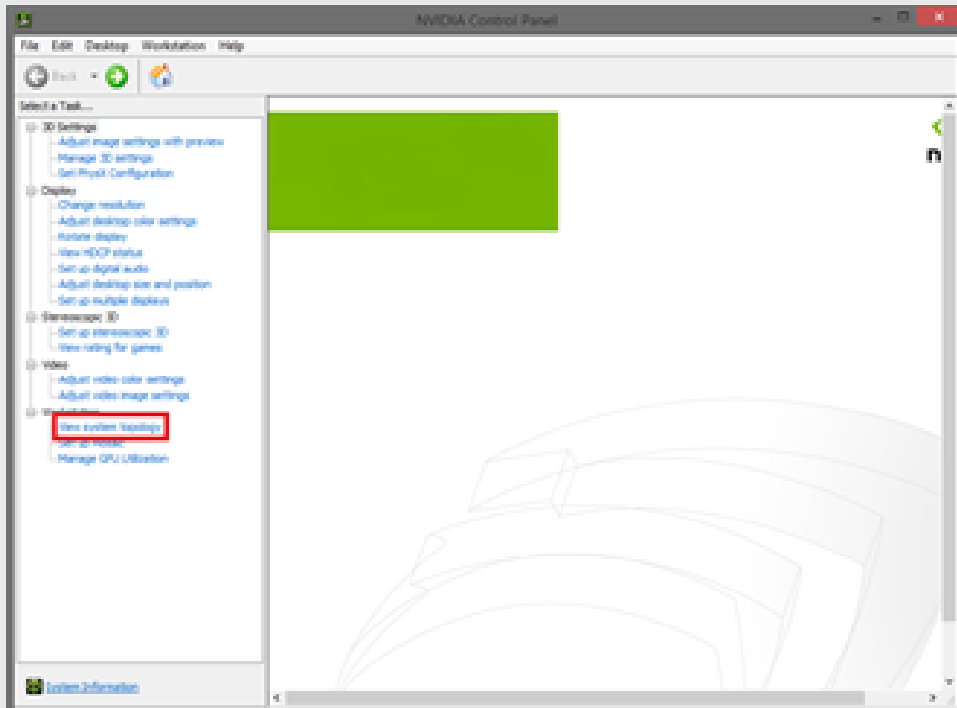

- Click the EDID button next to a card connection (DVI or DisplayPort)

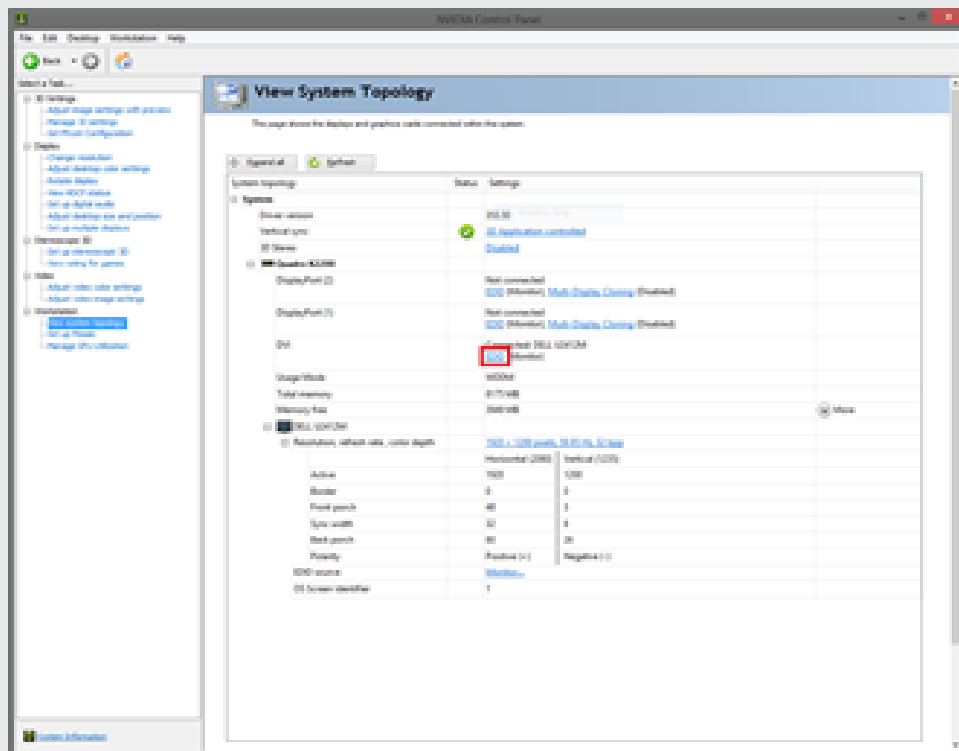

- Export your preferred EDID to the desktop or documents folder

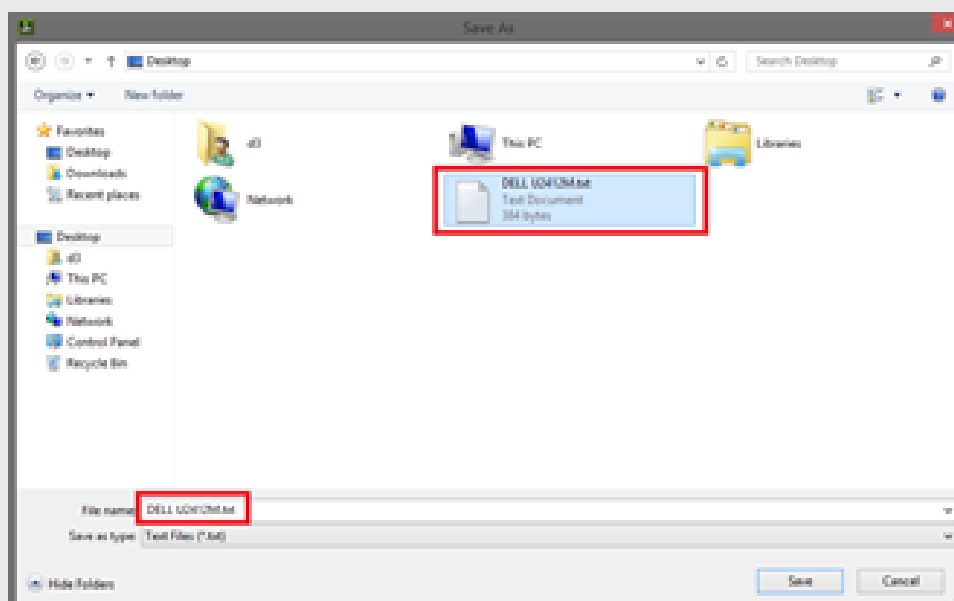
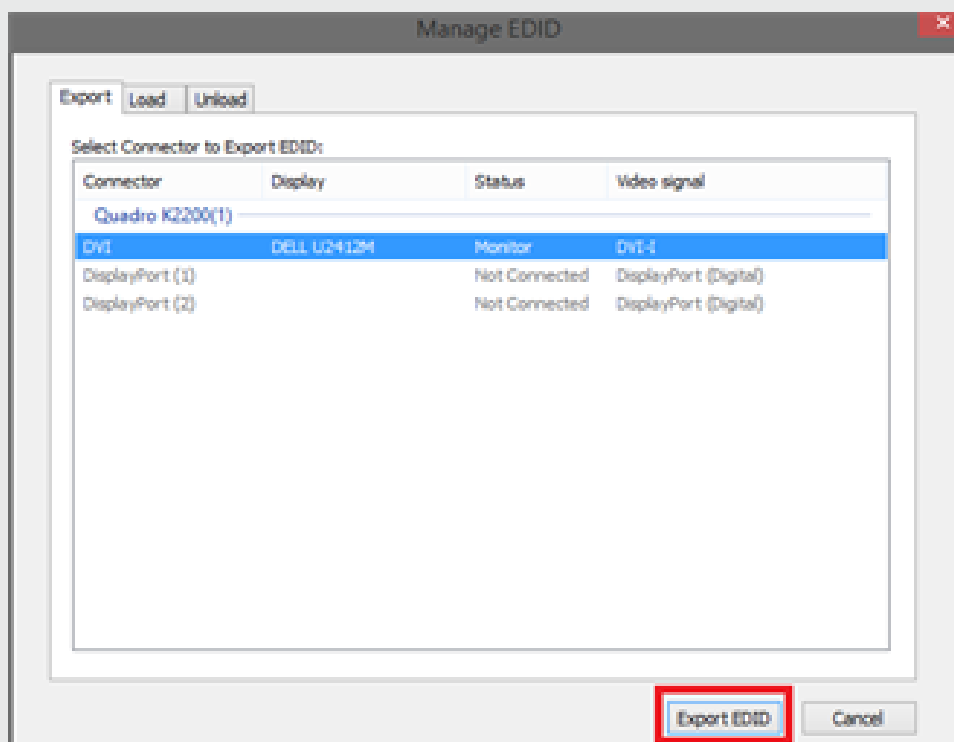



# Resetting EDIDs

EDIDs on all outputs of all connected VFC cards can be reset to a neutral state easily using the keyboard shortcut FFS (Four Finger Salute) as follows:

- Hold CTRL + ALT + SHIFT + F12
- disguise will display several status messages on the screen during the reset process; please wait until reset process has completed before continuing

# Audio input and output - vx

## Back panel connections

- XLR Left + Right Input
- XLR Left + Right Output
- ADAT/SPDIF Input
- ADAT/SPDIF Output
- MIDI Input
- MIDI Output

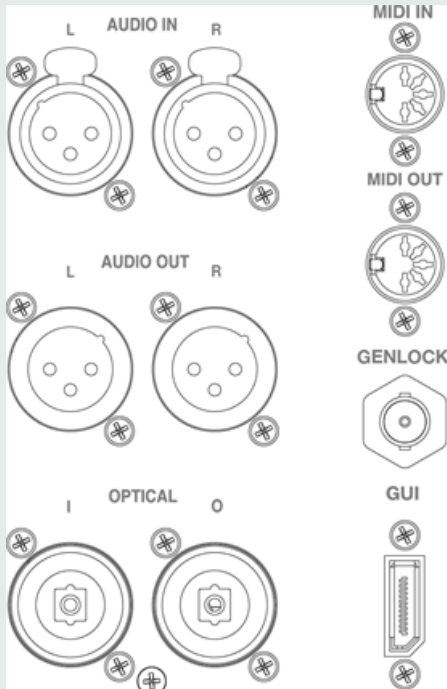

## Front panel connections

- 1/4inch Stereo Monitoring socket

It is possible to monitor audio output from the unit from the 1/4inch stereo socket with a pair of headphones.

# Video output

The pro and gx ranges of disguise servers come with a range of possible output configurations. It is possible to use a combination of any of the types of four VFC cards below.

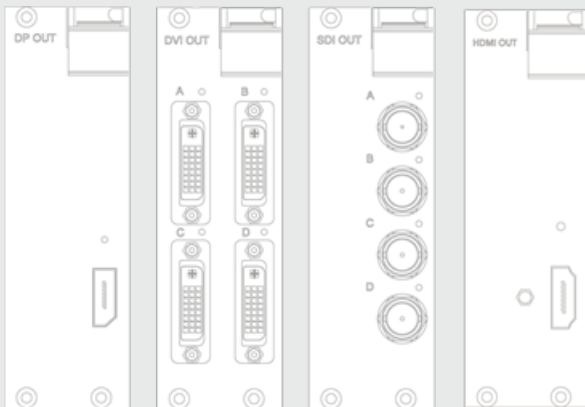

<b>Display Port 1.2</b>	<b>Quad DVI</b>	<b>Quad SDI</b>	<b>HDMI</b>
-------------------------	-----------------	-----------------	-------------

1 Output per card	4 Outputs per card	4 Outputs per card	1 Output per card
Max res: 4096x2160	Single Link DVI: (up to) 1920 x 1200	Max res: 1920 x 1080	Max res: 4096x2160 @60 YCbCr444 8bit 3840x2160 @60 YCbCr422 10bit* 3840x2160 @30 YCbCr444 10bit
LED indicator	LED indicator	LED indicator	LED indicator
Genlocked	All outputs genlocked	All outputs genlocked	Genlocked

# 4K Output



Warning: We highly advise using HDMI 2.0 cables.

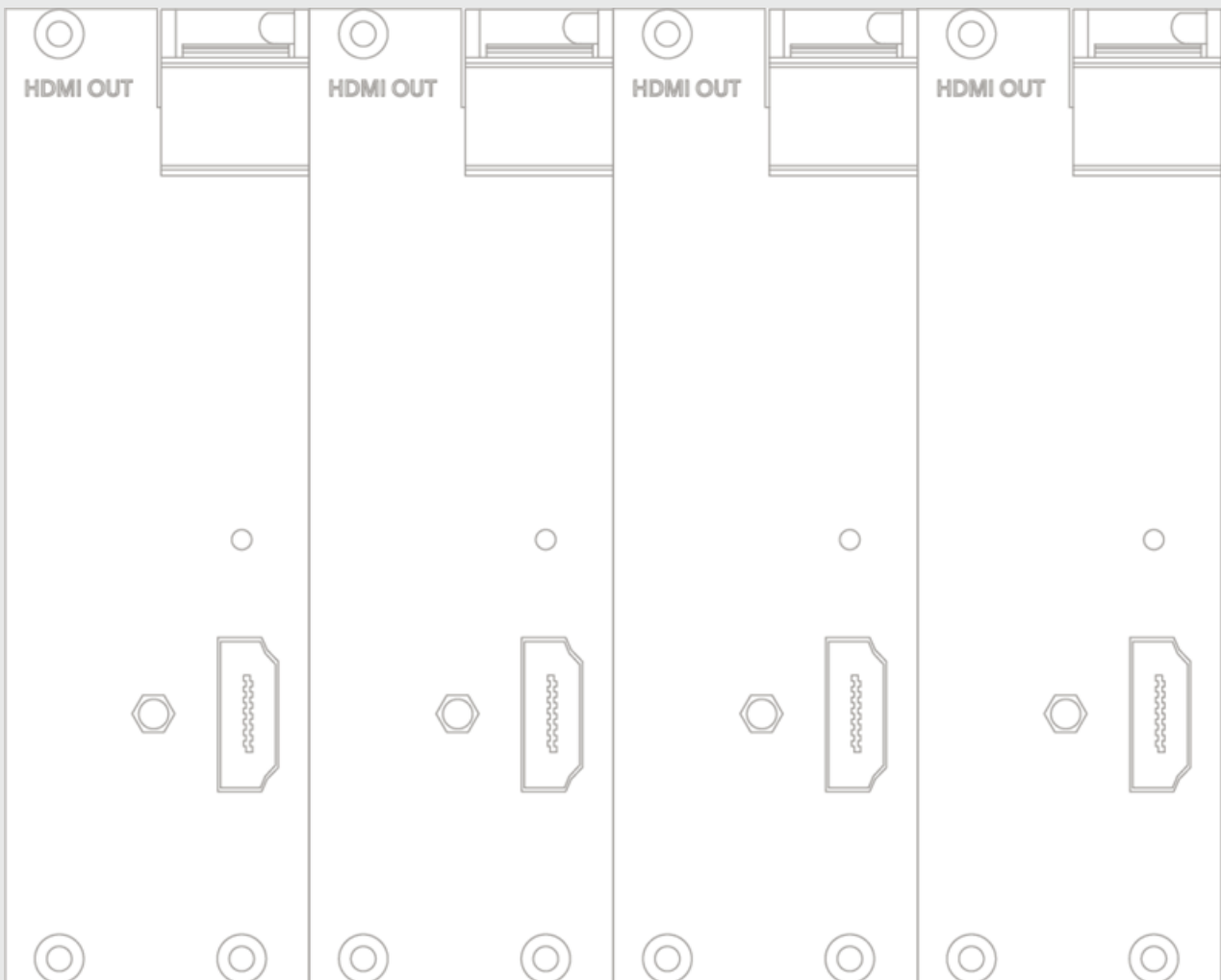

4 x HDMI 2.0 outputs on rear of the vx 4

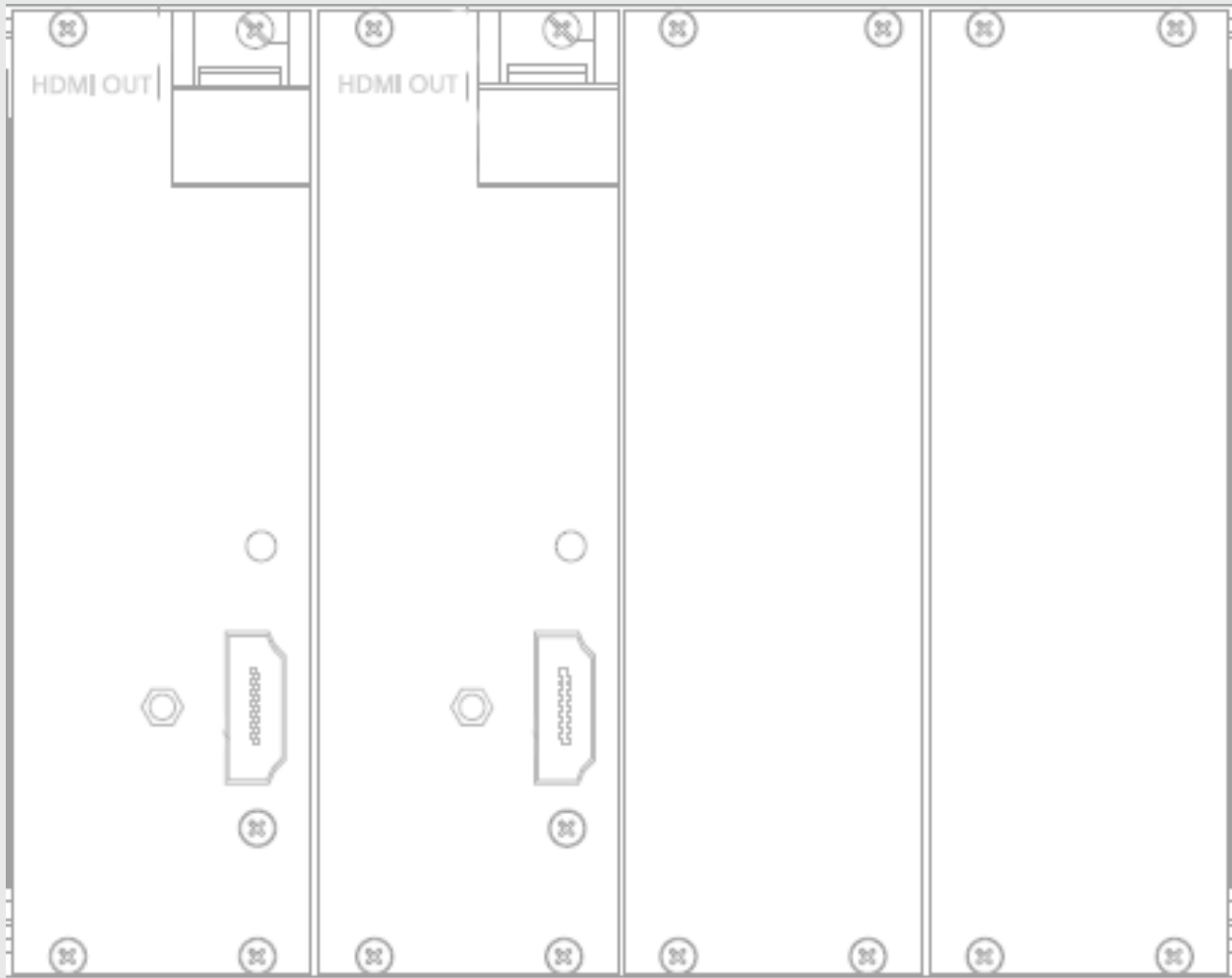

2 x HDMI 2.0 outputs on rear of the vx 2

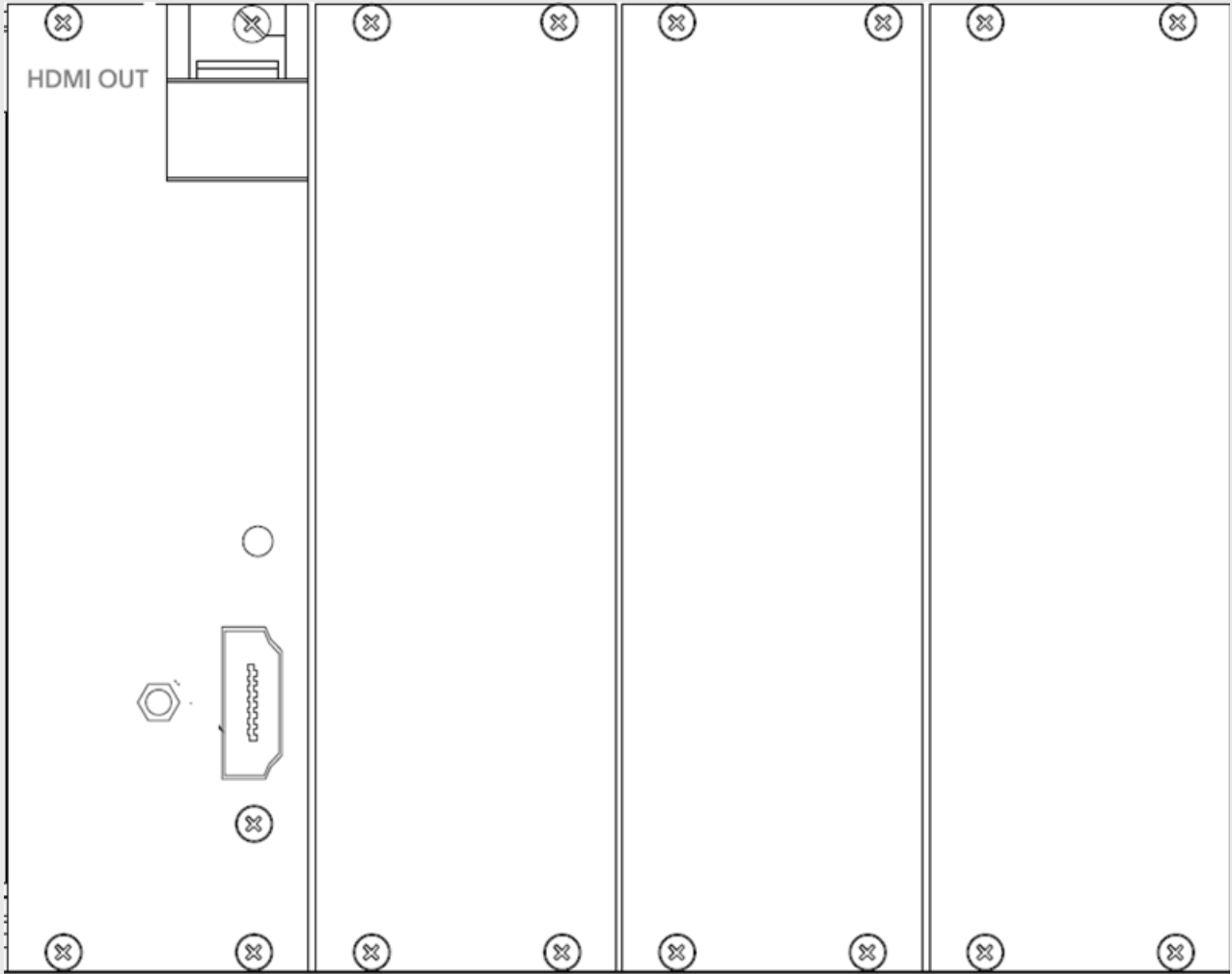

*1x HDMI 2.0 output on rear of the vx 1*

This enables the pro & gx ranges of disguise servers to support resolutions up to 4096x2160 60hz over Single Stream Transport.

# SMC

System Management Controller

## What is System Management Controller - SMC?

SMC is an out-of-band management system that allows for:

**1. Constant and up-to date access to information about the status of the main disguise server it is contained within such as:**

- Power state
- VFC cards currently inserted
- Network adapter details and configuration
- Server session details

**2. Communication with the BMC on the Motherboard allowing for:**

- Turning on and off machines remotely
- Monitoring physical metrics such as power draw and temperature

**To make life easier, all this information is generally available in three different ways:**

- OLED screen on the front of the servers
- Webpage
- REST API

The SMC system is currently present in the following disguise machines:

- vx 1
- vx 2
- vx 4



— vx 4+

— gx 3

## Connecting externally from a different machine

1. Connect to the MGMT port via ethernet
2. Open a browser and navigate to the IP address displayed on the front OLED screen of the server, this should open the web page, if it does not, or the IP does not appear on front screen then see **Troubleshooting**

### User Account Control

To use the website and some of the API endpoints in SMC v3 and above, a user account must be created. This is to protect against unauthorised access to critical machine functions (like turning off a server mid-show)

1. Once navigated to the IP address and the login page is visible, click 'Sign Up'
2. A four digit number will appear on the front screen which will need to be put in the 'Screen Number' field whilst filling out the form. This number will only appear for 30s, click 'Resend Verification' to generate a new number

### Designing into a network infrastructure

Each of the aforementioned disguise servers have a MGMT ethernet port on the back which is solely for access to the SMC system. This can be built into an existing network infrastructure but care should be taken to isolate this network from all others by using VLANs or maintaining a separate physical network. The reasons for this are two-fold:

- Security - Since the SMC system has access to lower-level functionality that bypasses the Windows OS on the servers, this shouldn't be connected to the internet on a permanent basis
- Reliability - One of the main features of the SMC system is to provide out-of-band management

and help configure or change the disguise server - this cannot happen if the network is down or not configured correctly!

## Connecting Internally from same disguise machine

If operating on the disguise server itself, the process is exactly the same as Connecting Externally, except the IP address is always **172.31.250.9**

## Functionality

### Front OLED Screen

The front OLED screen displays data that is organised into pages that are in a table-based format. In SMC v2 and v3, the only available pages are default information and VFC card information. From v4 onwards there will be a selection of different pages that can be displayed which the user can configure at any time from the webpage and REST API.

## Default Page

### Field Name-Description (Example)

- **Machine**-The model of the disguise server (vx 4)
- **Name** - The name of the disguise server (vx-44150)
- **Role** - The role of the machine set by d3 net manager (understudy)
- **MGMT IP** - The status of the SMC MGMT IP:

**Link Down** -Physical layer is down (something is unplugged or disabled)

**Assigning IP...**

**ip address**

## VFC Page

This page displays information about the currently installed VFCs. If the disguise server is powered off then this information may be out of date. (This can only be a 'left' page)

**Slot** - Which slot the VFC card is installed in (left-most looking at the rear is slot 1 (1))

**Card** - The type of VFC card installed in the slot (HDMI)

## Network Config Page

This page displays information about the network adapters in the disguise server

**Name** - The name of the interface set in Windows (A - d3net 1Gbit)

**IP** - The IPv4 address of the interface (10.0.0.34)

## System Temps

This page displays the readings of temperature sensors in the system

**Name** - The IPMI component name (CPU0\_TMP)

**Temp** - Temperature sensor reading in degrees Celsius (42 C)

## System Status

This page displays the readings of temperature sensors in the system

**Name** - The name of the status (System Power)

**Status** - The value of the status (On)

## Webpage

- Most user-friendly method of controlling SMC functionality
- Only place to create an account (see User Account Control)
- See Connecting Externally/Internally for access details

- Some features may be available in the REST API before the webpage
- The current page updates every 10 - 15 seconds to ensure that all data is up to date

## Status Page

Main (index) page - account creation required to access.

## Network Servers

This section displays all the other SMC servers that can be found on the same subnet.

Clicking on a row will navigate to that machine's management page.

## Stats Page

Gathers all sensor and important status messages from the IPMI system. This page self-updates every 10-15 seconds. System statistics such as temperature, voltage and fan speeds are recorded.

## Remora Page

Contains details about the Remora system present in the disguise server such as firmware and hardware version as well the current MGMT IP. Also provides an ease of access link to the update page.

## REST API

- Features and new status information tend to appear here first
- Navigate to **ip.address/api** to access the example page and view what features are available
- Can use any http client to send requests to the API (curl, python etc)
- Generally any request that involves getting information will not require authentication, anything that modifies the state will require basic authentication tokens (log in on the example API page)

# Install an update

1. Navigate to **ip.address:9998** in a browser and a SWUpdate landing page should appear
2. Download the most recent update to install from the link at the top of this page
  - a. It is **NOT** recommended to install an older version than currently installed
  - b. Currently installed version can be found by entering **ip.address/api/remora** into the browser, the current version will be listed as 'Firmware Version'
3. Drag and drop the .swu file to the window and the update will start - a progress bar will also appear on the front screen
4. Once updated the SMC system will restart - this will not affect the operation of the main disguise server in any way

# Troubleshooting

## How to start SMC

Without removing power from disguise server:

- Navigate to Install an update page - ip.address:9998
- Click 'Restart System' on top navigation bar of the page
- If the reboot method above does not work then perform a cold boot

## Front screen is blank/ jumbled data/ frozen

- Follow 'How to restart SMC' to restart the system and see if the screen starts working again
- If the screen is not fixed try to install an update (either the same or newer version if available)
- There is a known issue which happens when a new version of remora is replaced with v0.12 during a server reimage or similar process. This will cause the screen to freeze or be blank and the system will possibly be uncontactable through the normal channels. See *Fixing Backdated Version Issue* below for details on fix

- If the screen is still frozen or not working after trying BOTH of the restart methods then contact support

### **MGMT IP stuck on Link Down**

This means that there is a problem with the physical network connection

- Check all cables are plugged in correctly and functional
- Check that any network infrastructure such as switches are powered on and connected
- Check that connected network cards are enabled

### **MGMT IP stuck on Assigning IP**

Generally means that the physical layer is operating correctly but there are problems in the network stack configuration

- Check that the network is on the correct subnet: If the IP is of type 169.254 then link-local so subnet is 255.255.0.0
- If connected to DHCP server then check this can 'see' the SMC system
- If connected directly to a windows computer, install Bonjour and/or give the NIC an IP in the correct subnet. (Link-local addressing on the SMC side should sort out any address conflicts)

### **MGMT IP assigned but still can't connect**

- If connected straight to a windows computer, install Bonjour and/or give the NIC an IP in the correct subnet. (Link-local addressing on the SMC side should sort out any address conflicts)
- If connected to DHCP server then check this can 'see' the SMC system
- Try accessing the SMC webpage via the disguise server itself (see Connecting Internally)
- If all else fails try restarting SMC both ways

### **Fixing Backdated Version Issue (vx4 only)**

1. Connect the MGMT port to any of the other ports on the server
2. Open Chrome and try the following IP addresses to open the update page, if they do not work proceed with further steps  
172.31.250.9:9998  
10.0.0.102:9998
3. Set the connected port to DHCP (Obtain address automatically)
4. Install Wireshark
5. Point Wireshark at the port connected to the MGMT port
6. In Windows, disable the connected port
7. Accept the Wireshark notifications telling you that it's not connected
8. Re-enable the port
9. Look for ARP packets from a device named RASPBERR (The internal raspberry pi) in Wireshark
10. These packets should contain the IP that the remora system is self-assigning
11. Open chrome and type in the IP found PLUS port 9998 (for example, 169.254.123.145:9998)
12. This will open the Remora update page
13. Drag the latest Remora update into the browser (can be found at top of page)
14. Allow update to happen
15. Remove the cable between MGMT and other port
16. Restart d3service

# rx range Overview

The rx and the rx II machines are used to host third party render engines and act as a remote render node to a d3net session.



rx (top) and rx II (bottom)

## Topics

- [How to start the unit](#)
- [Redisguise](#)
- [Powering the rx / rx II](#)
- [Diagrams](#)



# rx + rx II diagrams

## rx

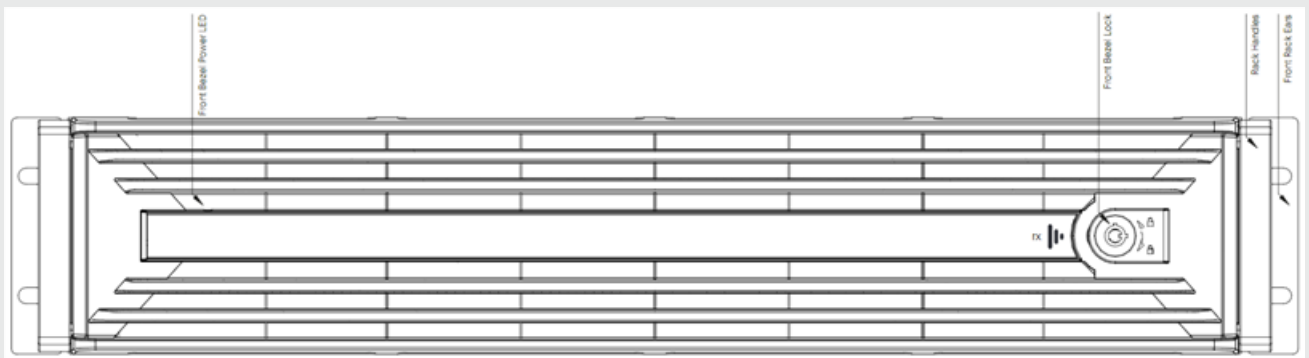

## rx Front Panel

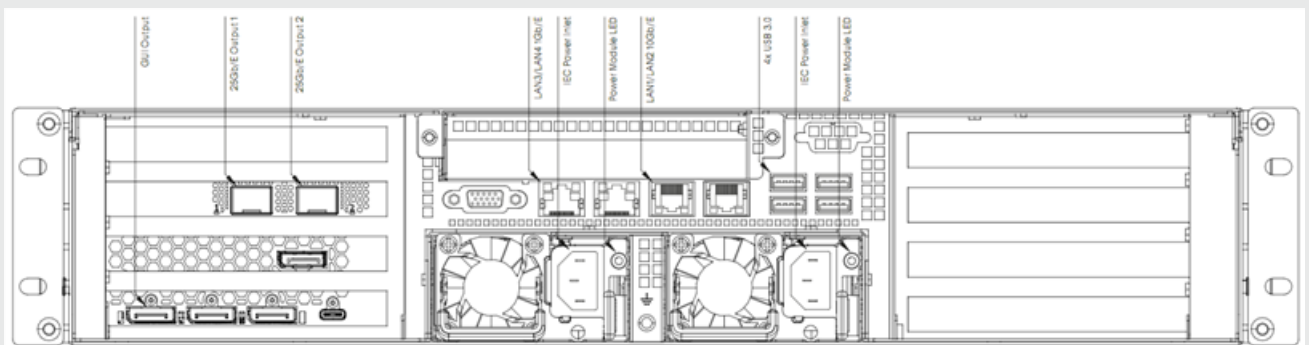

## rx Rear Panel Annotated

# rx II

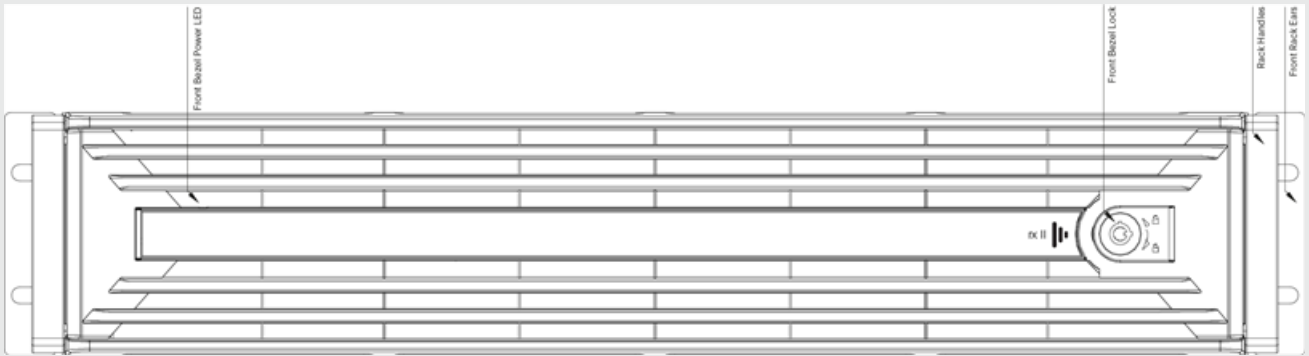

## rx II Front Panel

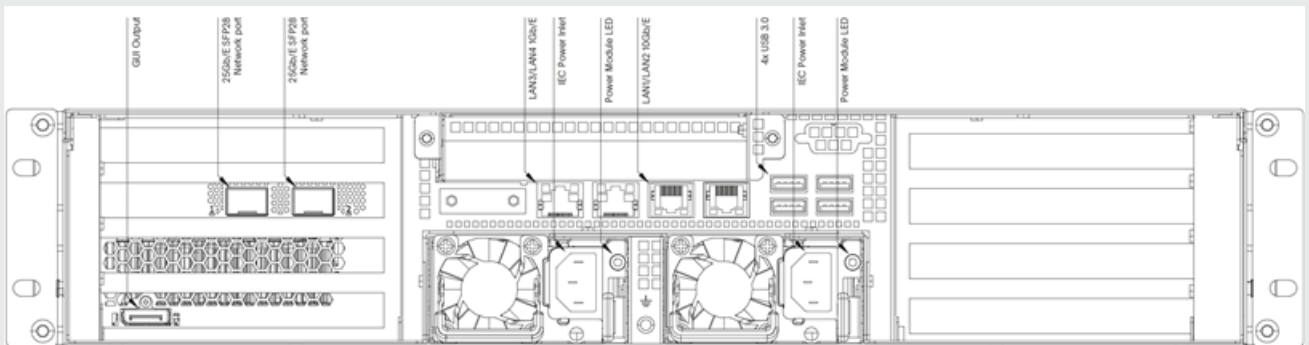

## rx II Rear Panel Annotated

# Powering the rx

1. Make sure you have connected a keyboard, mouse and monitor to the primary graphics output.
2. Press the power button on the front of the unit and wait for the system to load into Windows.

# How to start the unit

1. Connect Power cord to the gx 1gx 2 gx 2c rx
2. Make sure you have connected a keyboard, mouse and monitor to the primary graphics output.
3. Press the power button on the front of the unit and wait for the system to load into Windows.

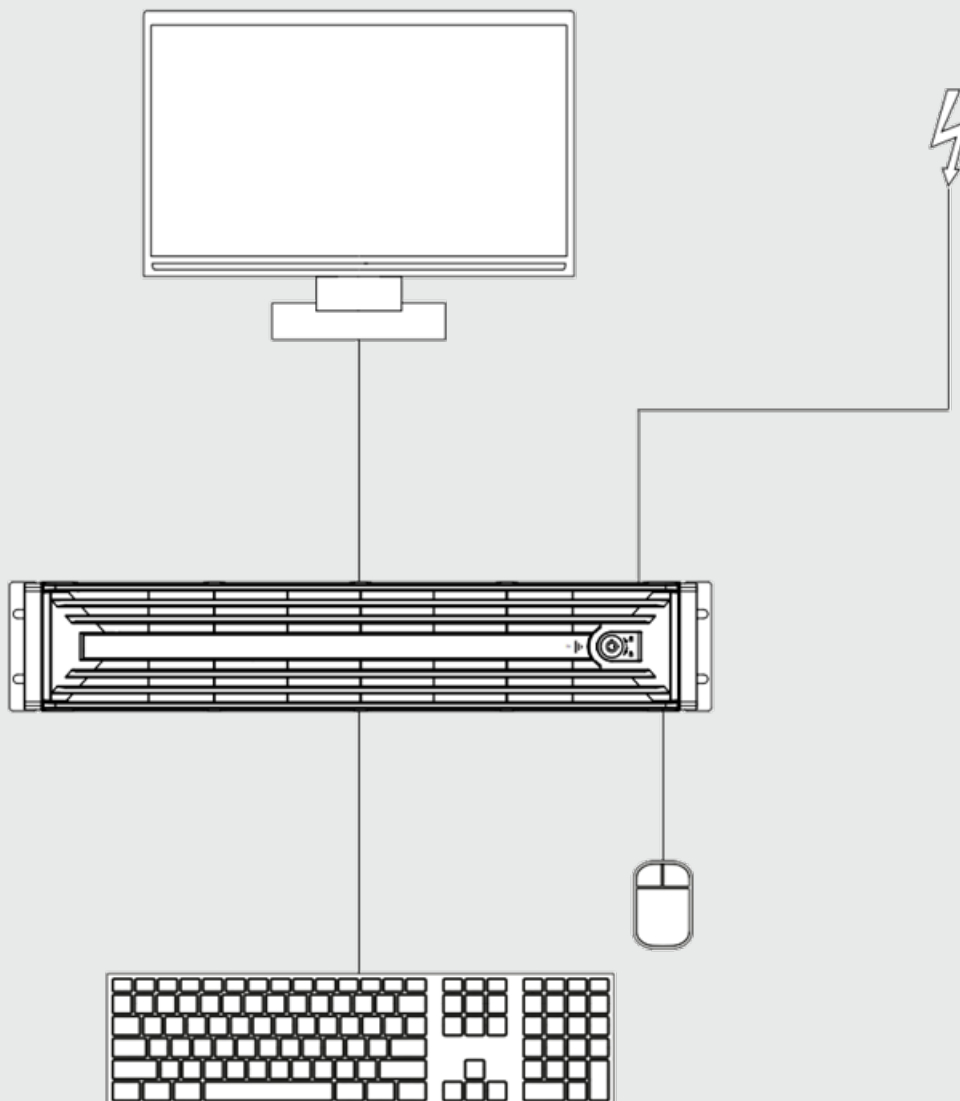

# Redisguise - rx range

The process for reimaging an rx server from a USB drive.

The reimaging process we refer to as **Redisguise** is the process of performing an update on the system using a bootable USB drive. This process does not affect the media drive.

**Please note:** If you experience any problems during updating or restoring the system, or any of these instructions are unclear, please contact the [support team](#).



**Warning:** The system needs to be connected to the internet during this procedure

This process can be used to update to a newer OS image, or revert to a previous OS image.

To tell what OS image your system is on please go to the **Help** menu in **d3manager** and select **About Manager**.

If you are updating from an OS earlier than **3.0** your system will do a cold reboot as it performs firmware level updates to some of the components. Please don't be alarmed, just switch the system back on again using the power button

## You will need

- A 32Gb USB memory stick
- A version of [Rufus](#) to turn it into a bootable disk. Make sure the volume name of the usb is: "REDISGUISE" as per image
- An internet connection to the machine you are re-imaging
- Download and install a version of [7Zip](#)
- Download and unzip the multi file archive using 7Zip
- OS images can be found [here](#).

**Please note:** You do not need to extract all parts individually. Simply place them in the same directory and then use 7zip to extract the ISO by selecting any part. 7zip will automatically unzip all parts to create the image file.

## Create Bootable USB device

1. Download and unzip the multi file archive using 7Zip (NOTE: you will only need to unzip file 001):

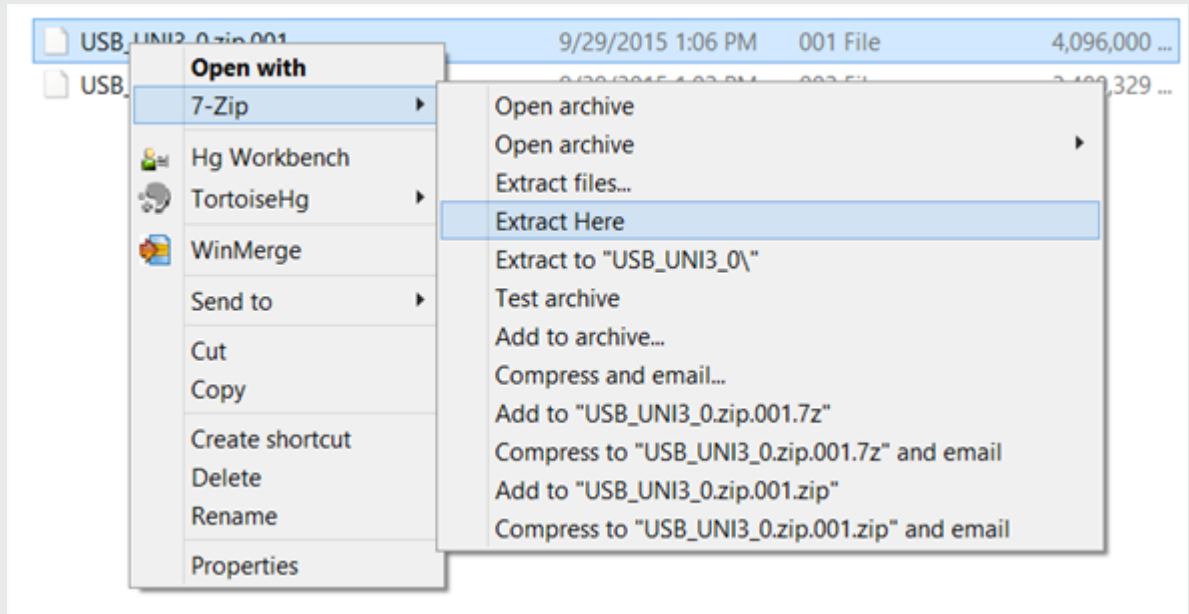

2. Create Bootable USB stick with the unzipped ISO.

The settings should be:

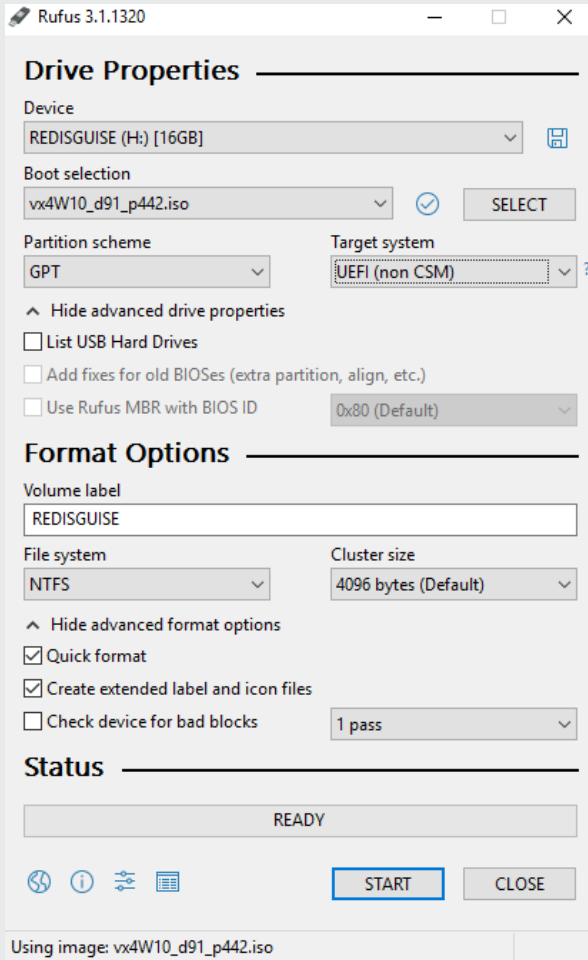

- **Partition scheme** - GPT
- **Target system** - UEFI - non CSM
- **Volume label** - automatically pulled from ISO file
- **File system** - NTFS





**Warning:** These settings are critically important. The re-image process will fail if they are not set correctly.

**Please note:** On the latest versions of Rufus you may see this warning. This is expected and does not apply to current disguise hardware. Please click OK to continue as normal.

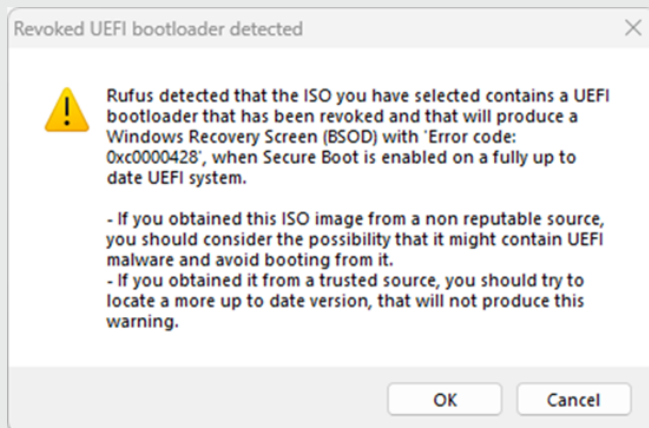

## Booting into the USB

1. Plug in your USB Drive to your disguise server and switch it on.
2. Go into the BIOS by waiting for the disguise logo to appear and then keep tapping Delete on the keyboard until the blue BIOS screen appears.
3. Use the left and right arrow keys to scroll through the tabs until you get to the "Save and Exit" tab.

**Note:** Do not select 'Save Changes', as you only need use the 'BootOverride' Section here.

4. Use the up and Down arrow keys to navigate to the 'Boot Override' section. In this section you will see all of the boot options available to you.

5. In the Boot Override section, look for this option:

**UEFI: [diskname], Partition 2**

This may vary depending on the manufacturer of the USB stick in use.

6. Select this option, then press enter to begin the OS upgrade process.

7. Redisguise will then load automatically, completing the reimage. If the reimage is not successful, a log file will be accessible on the USB flash disk. This is useful if contacting [disguise support](#).

**Please note:** performing a system restore from the new disk image will erase any valuable data on your system drive. Please ensure you make a back up of any essential files from your system (C:) drive before initialising this process. The process does NOT destroy any media or projects on your media drive.

# EX 3 Overview

The EX 3 is a powerful video playback solution specifically designed for fixed installations and location-based experiences.



The EX 3 is a powerful video playback solution specifically designed for fixed installations and location-based experiences (LBX). These immersive spectacles can be located in theme parks, museum and visitor attractions, and architectural spaces with the intention of offering a shared experience for their audiences. Global audiences who want to attend unique experiences in the physical world, and then be able to share that experience in the digital world.



*Illuminarium*

It harnesses the power and scalability of Designer to visualise, design and sequence shows of varied complexity, with pixel-perfect 3D visualisation.

## Technical Overview

The EX 3 features 3x DisplayPort 1.4 outputs for 4K video within a 2U chassis.

It also includes sufficient networking capabilities for fixed installations with the inclusion of dual 1GbE, 10GbE and 25GbE ports.

## What's Different?

The EX 3 has been designed specifically for video playback, and as a result there is no physical video inputs or audio inputs and outputs on the EX 3. There is no support for inputting video via USB devices on the EX 3. Users can feed a NDI video signal into the EX 3, and there will be future support for a ST 2110 video signal input. USB Audio Interfaces can also be used if needed.

The EX 3 can be used as a Director, Actor, Understudy and Editor within a d3net session with other EX 3 only. The EX 3 will not be able to be used within the same d3net session as other machines in the pro range (vx or gx).

The EX 3 does not support VFC cards.

There is also an optional realtime connector licence to be purchased if a user wishes to run generative content on their EX 3, including a Notch block. There is also no support for RenderStream, ACES mode or mixed reality set extension within the EX 3.

## EX 3 and the Disguise Platform

The EX 3 can be used alongside Designer's new APIs to let developers easily build custom solutions and workflows for non-specialist users, in addition to both OSC and DMX for external triggers.

The EX 3 can also be used alongside disguise Cloud to collate project content from one place, as well as access and share 3D visualisations via Previz.

OmniCal, our camera-based projector calibration system, can be combined with the EX 3 for accurate alignments on a fixed installation projection.

# EX 3 Overview

The EX 3 is a powerful video playback solution specifically designed for fixed installations and location-based experiences.



The EX 3 is a powerful video playback solution specifically designed for fixed installations and location-based experiences (LBX). These immersive spectacles can be located in theme parks, museum and visitor attractions, and architectural spaces with the intention of offering a shared experience for their audiences. Global audiences who want to attend unique experiences in the physical world, and then be able to share that experience in the digital world.



*Illuminarium*

It harnesses the power and scalability of Designer to visualise, design and sequence shows of varied complexity, with pixel-perfect 3D visualisation.

## Technical Overview

The EX 3 features 3x DisplayPort 1.4 outputs for 4K video within a 2U chassis.

It also includes sufficient networking capabilities for fixed installations with the inclusion of dual 1GbE, 10GbE and 25GbE ports.

## What's Different?

The EX 3 has been designed specifically for video playback, and as a result there is no physical video inputs or audio inputs and outputs on the EX 3. There is no support for inputting video via USB devices on the EX 3. Users can feed a NDI video signal into the EX 3, and there will be future support for a ST 2110 video signal input. USB Audio Interfaces can also be used if needed.

The EX 3 can be used as a Director, Actor, Understudy and Editor within a d3net session with other EX 3 only. The EX 3 will not be able to be used within the same d3net session as other machines in the pro range (vx or gx).

The EX 3 does not support VFC cards.

There is also an optional realtime connector licence to be purchased if a user wishes to run generative content on their EX 3, including a Notch block. There is also no support for RenderStream, ACES mode or mixed reality set extension within the EX 3.

## EX 3 and the Disguise Platform

The EX 3 can be used alongside Designer's new APIs to let developers easily build custom solutions and workflows for non-specialist users, in addition to both OSC and DMX for external triggers.

The EX 3 can also be used alongside disguise Cloud to collate project content from one place, as well as access and share 3D visualisations via Previz.

OmniCal, our camera-based projector calibration system, can be combined with the EX 3 for accurate alignments on a fixed installation projection.



# EX 3 diagrams

## Front Panel

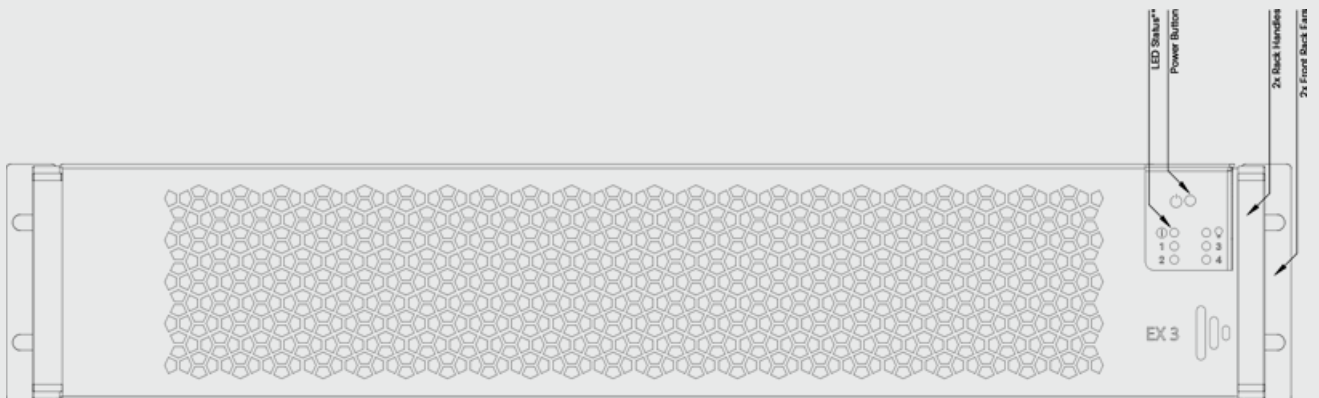

## EX 3 Front Panel



## EX 3 Front Panel - cover removed

## Front Panel LED

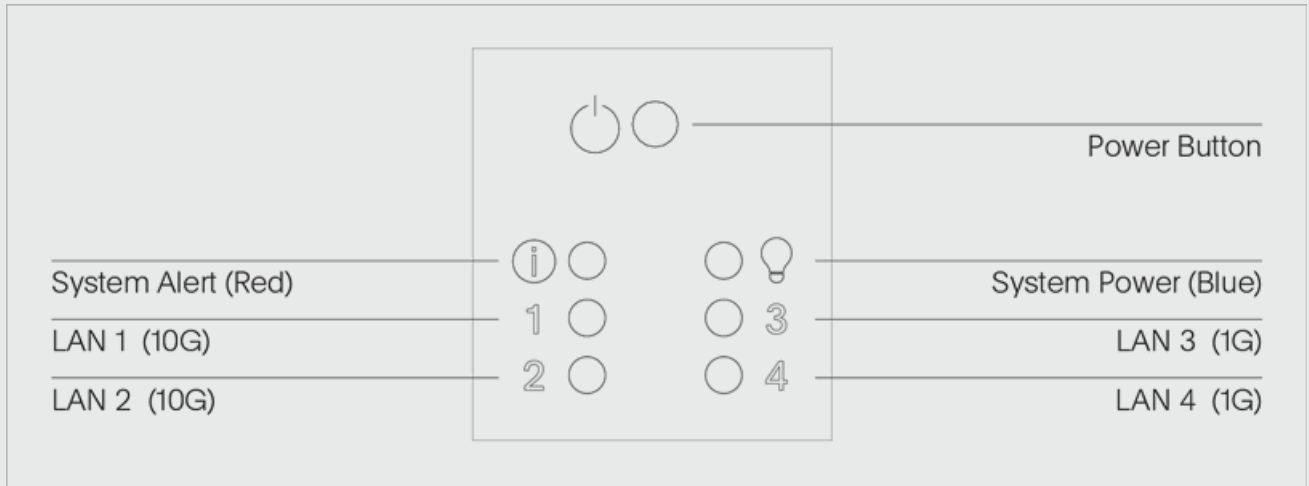

## EX 3 Panel Indicators

## Rear Panel

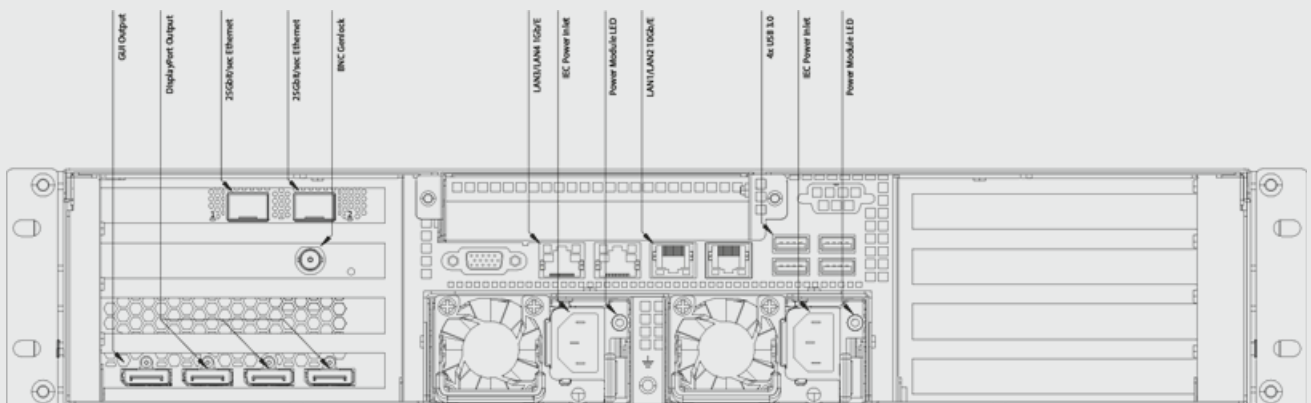

## EX 3 Rear Panel

To view full screen images, right-click on a diagram and open it in a new tab.



# EX 3 Licensing Options

## EX 3 Licensing Options

The EX 3 will be available with the option of a perpetual licence version at the time of launch. We will then be offering an EX licence version in the future. Both options and the differences can be seen below.

### Perpetual licence

- EX 3 server
- Perpetual Designer licence
- One-time charge (buy as today)
- No internet connection required
- Video over IP inputs (NDI)

### Options

- Real-time connector licence
- Premium Support

### EX licence

- EX 3 server
- Annual EX licence (recurring charge)

- Premium Support
- Internet connection required
- Video over IP inputs (NDI)

## Options

- Real-time connector licence

# EX 3 Performance

## Video Playback Performance - Full HD

Codec	Data Rate (MB/s)	Max. Layers on EX 3
HD HAP 30	31	34
HD HAP 60	62	30
HD HAPQ 30	61.25	29
HD HAPQ 60	122.5	17
HD Animation 30	187.25	12
HD Animation 60	374.5	6
HD TIFF Sequence 30	237	9
HD TIFF Sequence 60	474	4
HD NotchLC 30	78.375	24
HD NotchLC 60	156.75	13

Testing completed on r24 98098

## Video playback performance - 4K DCI

Codec	Data Rate (MB/s)	Max. Layers on EX 3
UHD HAP 30	132	15
UHD HAP 60>	264	8
UHD HAPQ 30	261.25	8
UHD HAPQ 60	522.5	4
UHD Animation 30	798.25	3
UHD Animation 60	1596.5	1
UHD TIFF Sequence 30	949	3
UHD TIFF Sequence 60	1898	2
UHD NotchLC 30	331.5	6
UHD NotchLC 60	663	3

Testing completed on r24 98098

## Video playback performance - Uncompressed

Codec	Data Rate (MB/s)	Max. Layers on EX 3
UHD DPX Sequence, 8-bit, RGB, 30	759	3
UHD DPX Sequence, 8-bit, RGB, 60	1518	1
UHD DPX Sequence, 10-bit, RGB, 30	1011	2
UHD DPX Sequence, 10-bit, RGB, 60	2022	1
UHD TGA Sequence, 8-bit, RGB, 30	759	3
UHD TGA Sequence, 8-bit, RGB, 60	1518	2
UHD TGA Sequence, 10-bit, RGB, 30	1011	2
UHD TGA Sequence, 10-bit, RGB, 60	2022	1
UHD TIFF Sequence, 8-bit, RGB, 30	759	3
UHD TIFF Sequence, 8-bit, RGB, 60	1518	2
UHD TIFF Sequence, 10-bit, RGB, 30	1011	2
UHD TIFF Sequence, 10-bit, RGB, 60	2022	0

Testing completed on r24 98098



Performance specifications listed here outline the maximum amount of video layers that are achievable on a single EX 3. These can fluctuate in future releases.

All HD codecs listed above have an output resolution relevant to Full-HD (1920 x 1080). All UHD codecs listed above have an output resolution relevant to 4K DCI (4096 x 2160).

# Update & restore - EX 3

Update & restore is the process of doing an update or restore on the system using a bootable USB drive. This process does not affect the media drive.

Please note: If you experience any problems during updating or restoring the system, or any of these instructions are unclear, please contact the [support team](#).



**Warning:** The system needs to be connected to the internet during this procedure

## You will need

- A 32Gb USB memory stick
- A version of [Rufus](#) to turn it into a bootable disk. Make sure the volume name of the usb is: "REDISGUISE".
- An internet connection to the machine you are re-imaging
- Download and install a version of [7Zip](#)
- Download and unzip the multi file archive using 7Zip
- OS images can be found [here](#).

**Please note:** You do not need to extract all parts individually. Simply place them in the same directory and then use 7zip to extract the ISO by selecting any part. 7zip will automatically unzip all parts to create the image file.

## Create a Bootable USB

1. Download and unzip the multi file archive using 7Zip (NOTE: you will only need to unzip file 001):

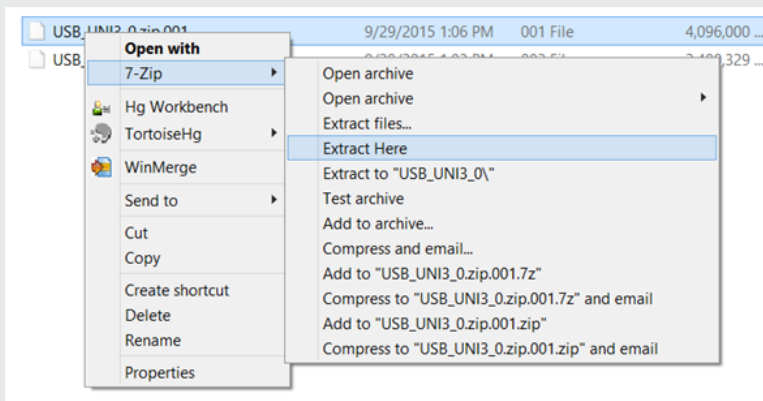

2. Create Bootable USB stick with the unzipped ISO.

The settings should be:

- **Partition scheme** - GPT
- **Target system** - UEFI - non CSM
- **Volume label** - automatically pulled from ISO file
- **File system** - NTFS

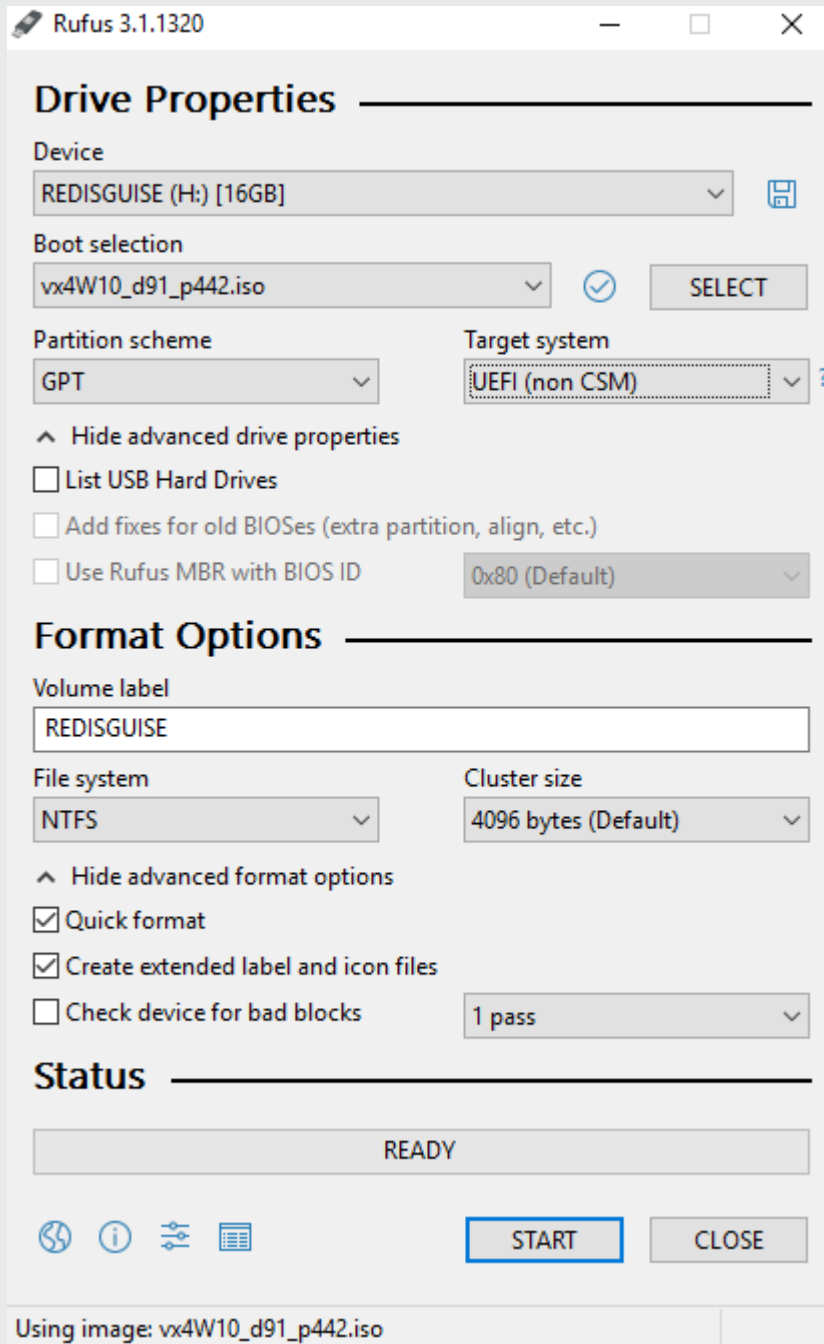



**Warning:** These settings are critically important. The re-image process will fail if they are not set correctly.

**Please note:** On the latest versions of Rufus you may see this warning. This is expected and does not apply to current disguise hardware. Please click **OK** to continue as normal.

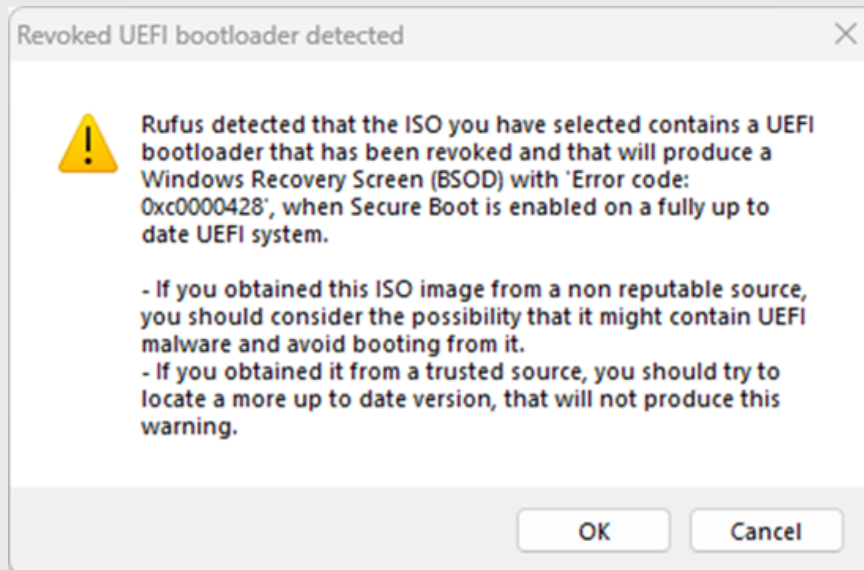

## Booting into the USB

1. Go into the BIOS by hitting Delete on the logo splash screen during boot.
2. Change the Boot option #1 to the USB stick
3. Navigate to the Advanced tab and press enter to view the CSM Configuration
4. Ensure that Boot option filter is set to [UEFI and Legacy]. Change it if it is not, then press F4, confirm and re-enter BIOS. The system will reboot and you will need to tap Delete to re-enter the BIOS.

5. Once this setting is confirmed, navigate to the Save & Exit tab. It is just to the right of the Boot tab.
6. Do not select Save and Exit.
7. In the Boot Override section at the bottom there is a UEFI:  
UEFI: "The Name of your USB Disk", Partition 2  
This may vary depending on the manufacturer of USB stick in use.
8. Select this option to begin the OS upgrade process.
9. Redisguise will then load automatically, completing the reimage. If the reimage is not successful, a log file will be accessible on the USB flash disk. This is useful if contacting disguise support.

**Please note:** performing a system restore from the new disk image will erase any valuable data on your system drive. Please ensure you make a back up of any essential files from your system (C:) drive before initialising this process. The process does NOT destroy any media or projects on your media drive.

# Legacy Machines

## Legacy Servers

Powerful machines that have reached the end of their development cycles but are out there still in the wild

For questions on any of these products, please reach out to the [disguise support team](#)

[v2.5 Hardware](#)

[2x2plus](#)

[2x4pro](#)

[4x2pro](#)

[4x4pro](#)

gx 2

gx 1

# v2.5 hardware overview

Hardware comes in two machine types, the 2U and the 4U.



The machines come pre-installed with the latest software version, enabling you to design, configure and sequence the show on the same machines as you later use for show playback. We also offers a software only version, [Designer](#).

## 4U machine

The v2.5 is the latest model of the 4U machine. Other earlier versions of the 4U machine are the v1.0, v1.5 and v2.0.

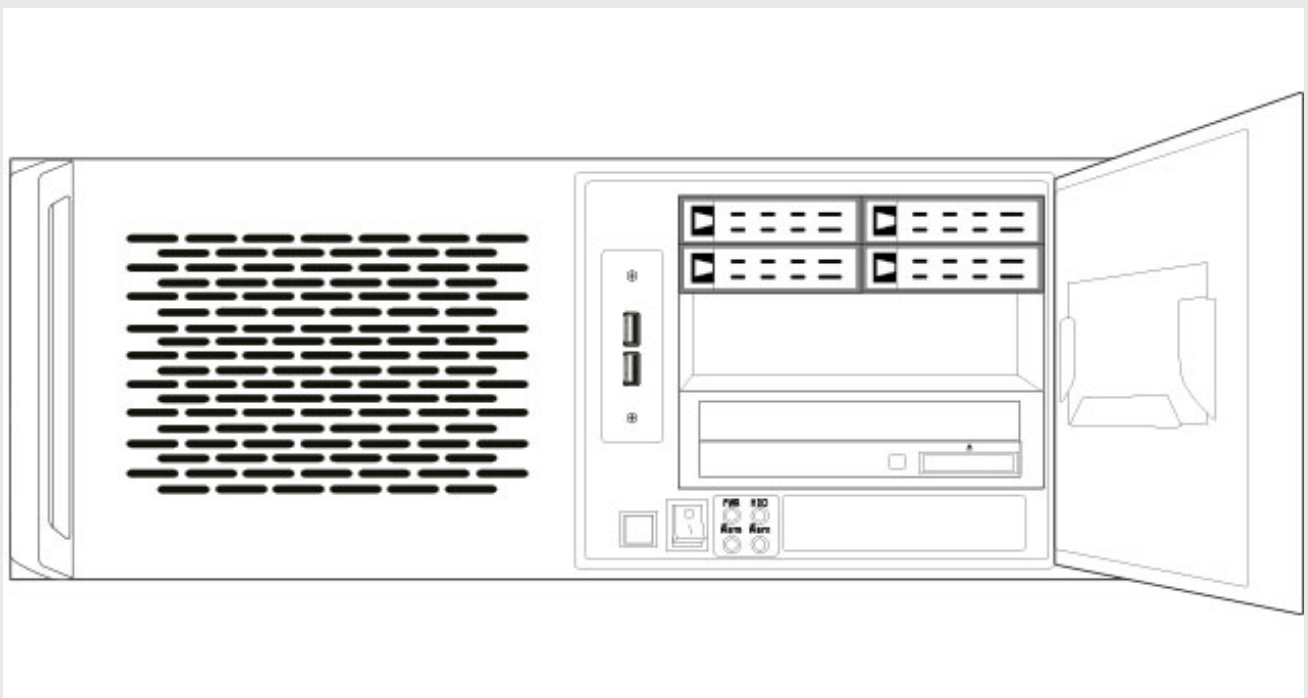

Front view of 4u v2.5 with front door open

The diagram below illustrates the configuration of the 4U v2.5 machines back panel. Parts of this diagram will be used throughout this chapter to explain specific hardware components.



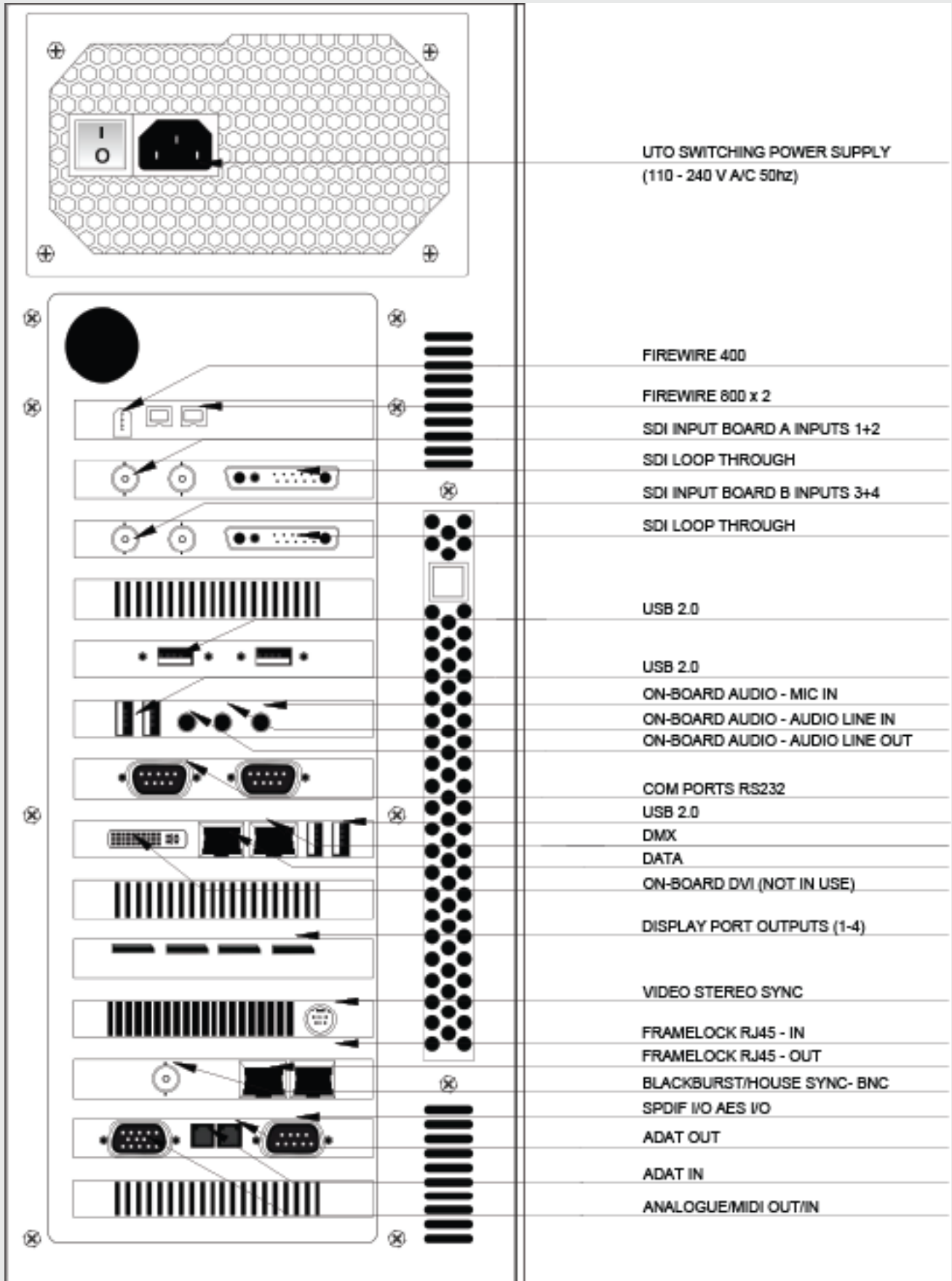

Architectural configuration of the 4U v2.5 machines back panel

# Support

If you experience any problems with hardware please contact the [disguise support team](#).



**Warning:** do not open the case unless you are instructed to do so by a certified Engineer

# v2.5 hardware overview

Hardware comes in two machine types, the 2U and the 4U.



The machines come pre-installed with the latest software version, enabling you to design, configure and sequence the show on the same machines as you later use for show playback. We also offers a software only version, [Designer](#).

## 4U machine

The v2.5 is the latest model of the 4U machine. Other earlier versions of the 4U machine are the v1.0, v1.5 and v2.0.

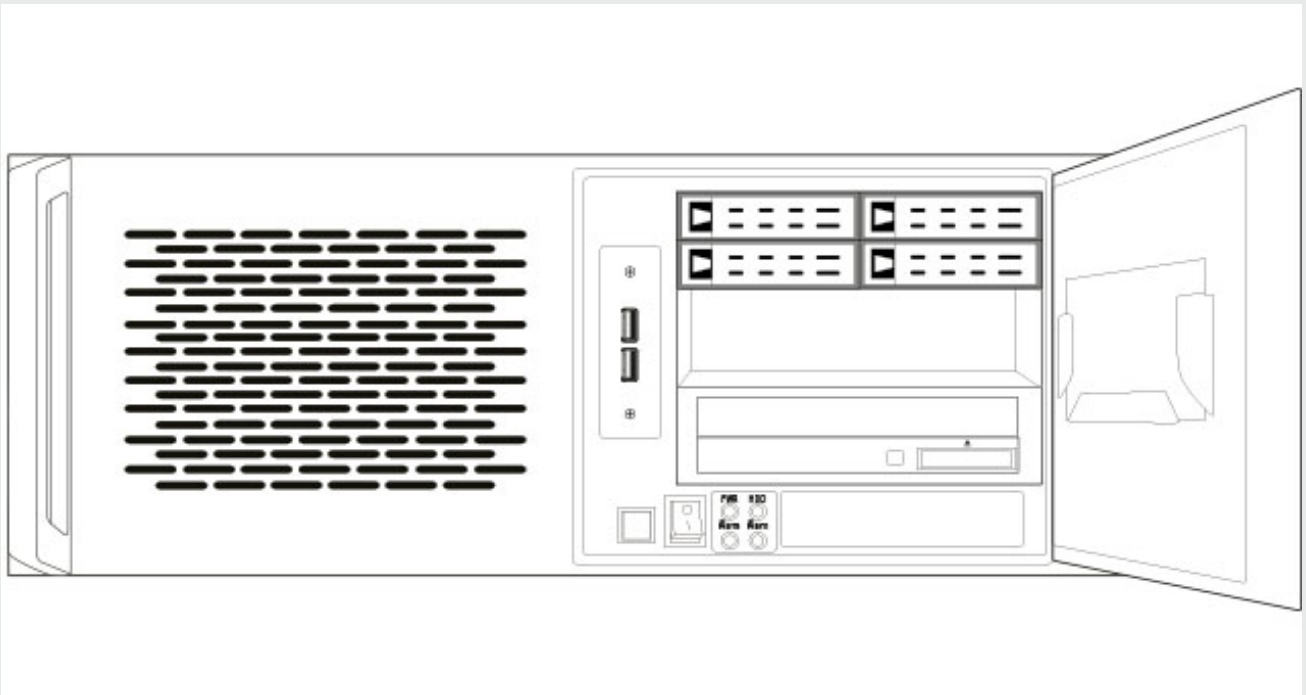

Front view of 4u v2.5 with front door open

The diagram below illustrates the configuration of the 4U v2.5 machines back panel. Parts of this diagram will be used throughout this chapter to explain specific hardware components.

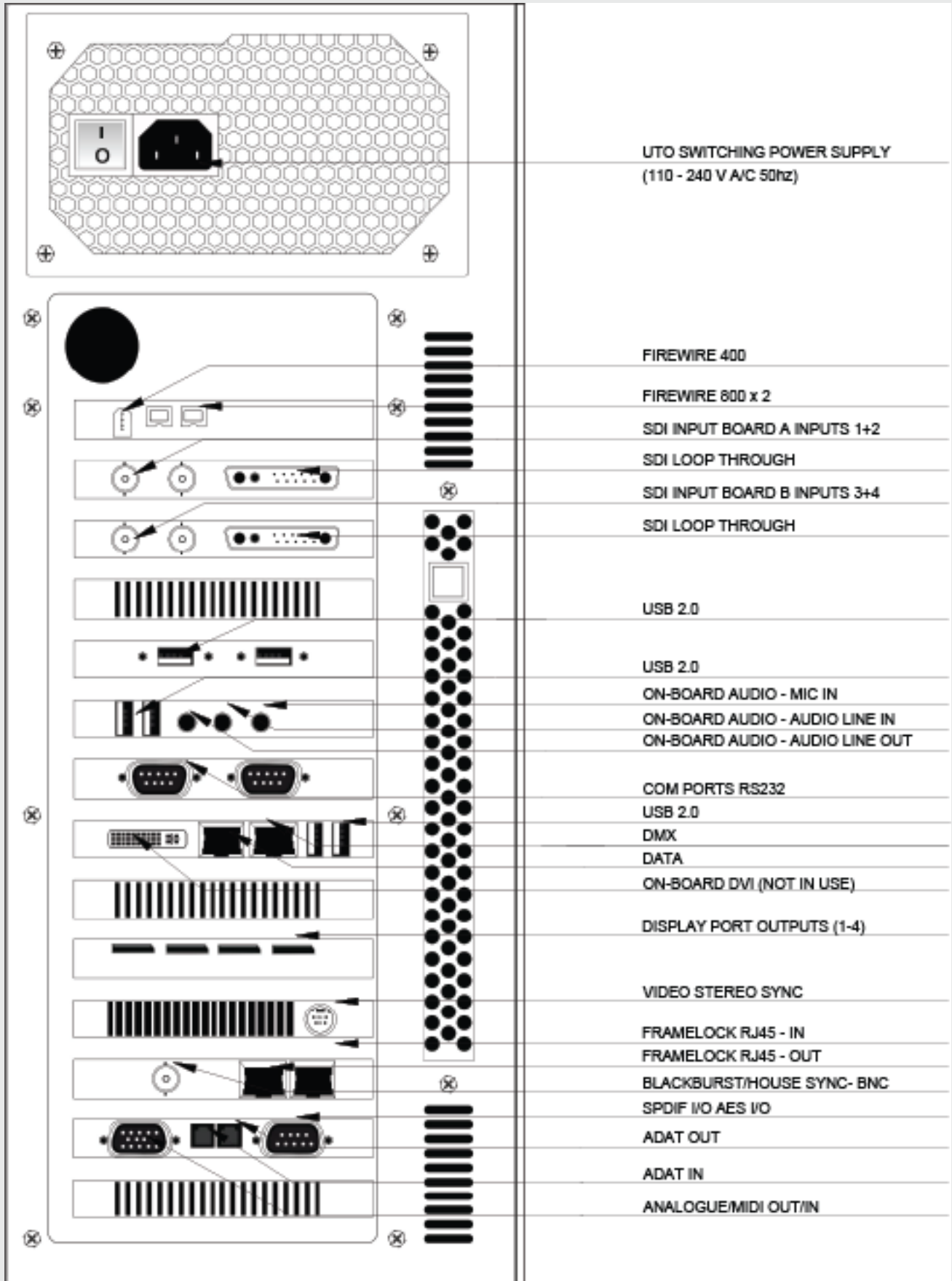

Architectural configuration of the 4U v2.5 machines back panel

# Support

If you experience any problems with hardware please contact the [disguise support team](#).



**Warning:** do not open the case unless you are instructed to do so by a certified Engineer

# Removable media drives

## How are the removable drive bays arranged?

Your d3 machine contains four drive bays, which are found on the front panel behind the door.

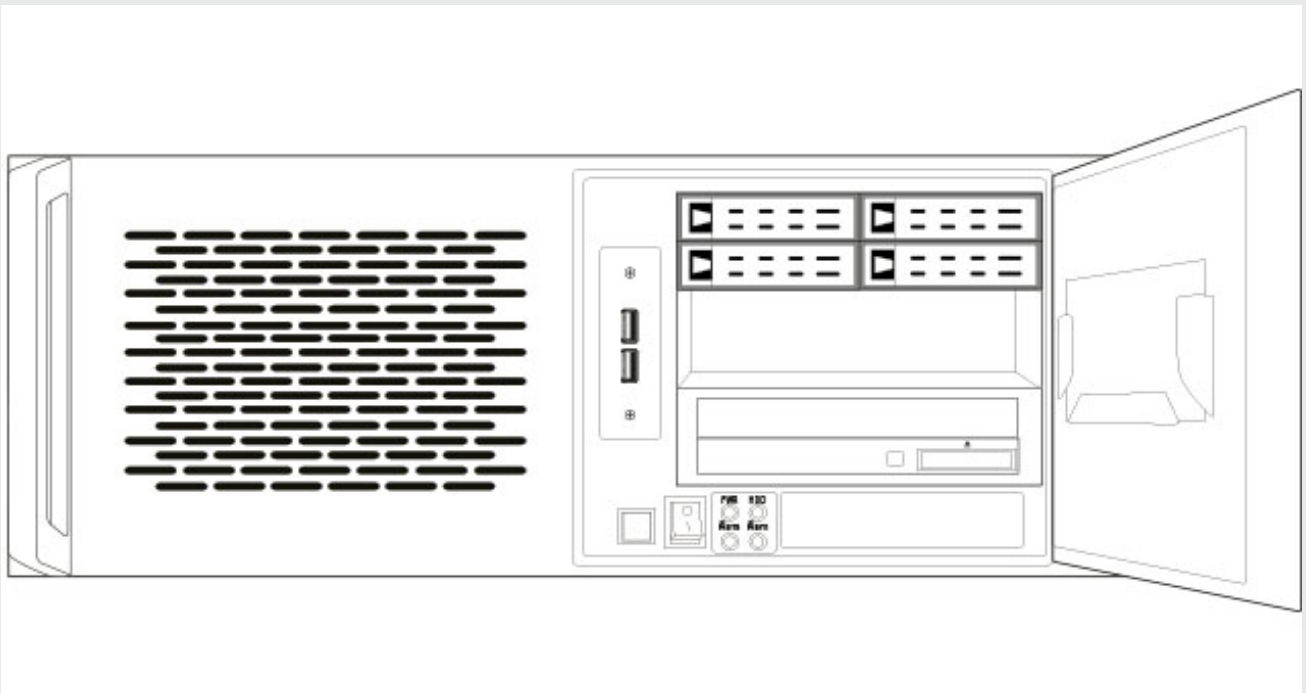



Every d3 machine contains four bays, and are shipped with a single 512Gb OCZ Vertex 4 Solid State Drive ( SSD ) located in drive bay 1

Out of the four drive bays there are two fast SATA3 drive bays ( bays 1 and 2 ) and two SATA2 drive bays ( bays 3 and 4 ).

To ensure optimal performance always populate bay 1 and 2 first. Your d3 machine ships with a single 512Gb OCZ Vertex 4 Solid State Drive ( SSD ). The SSD will be located in drive bay 1 and is capable of 461.9 MB/s sequential read and 462.9 MB/s sequential write.

**Please note:** if you ever need to replace or exchange your media drive it is recommend that you use a drive with similar read/write speeds. For further information please contact the [d3 Support team](#).



**Warning:** Do not remove drives when the machine is on.

# Flashing an Active Silicon card

It is sometimes necessary to program the Flash memory on all Phoenix boards with updated information to match that in the current driver set. To do this:

1. First, check the current firmware version. Open the Phoenix Capture application and click Phoenix > Control Center and navigate to the status tab. You can see the firmware version next to the Software Library box.



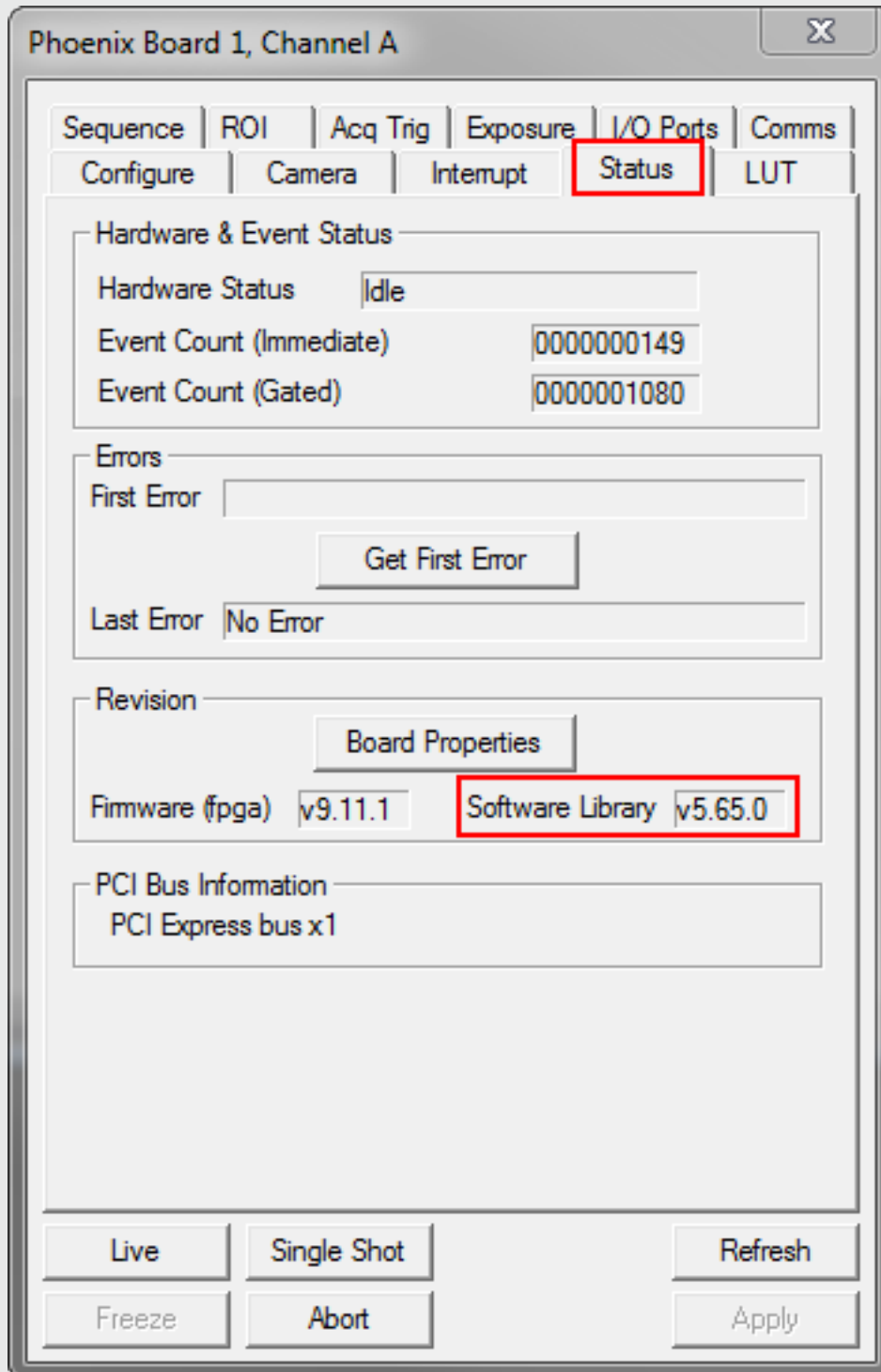

2. Check the current firmware version of your boards, in this example a Phoenix board, using the cards control window before flashing an Active Silicon card
3. Shut down the host computer and remove all Phoenix boards from the machine.
4. Ensure that the jumper marked FLASH PROG is in the enabled ( EN ) position on each board.

Look at the pictures below to find the position of this jumper on the Active Silicon card. They all show the jumper in the enabled position.

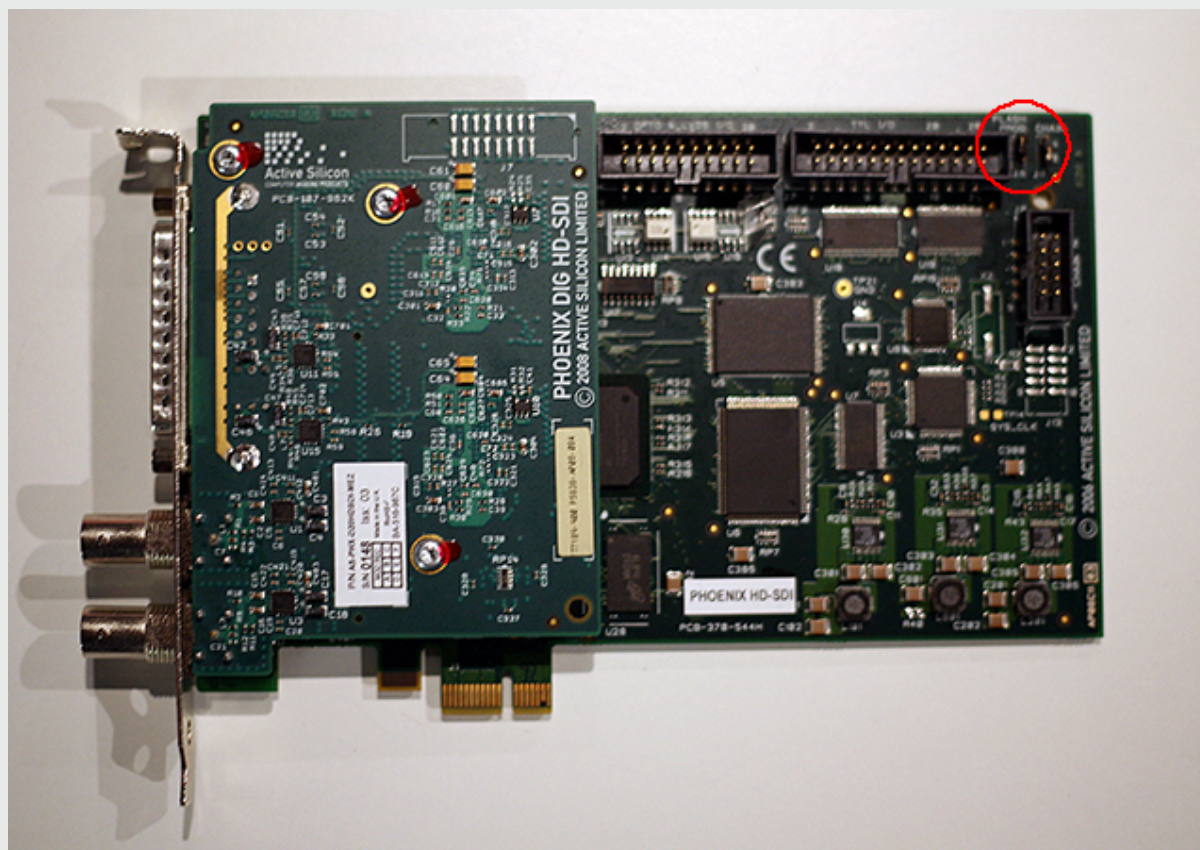

Position the jumper on the board ( top-right ), in this example a Phoenix board, to enabled (EN) in order to flash the card

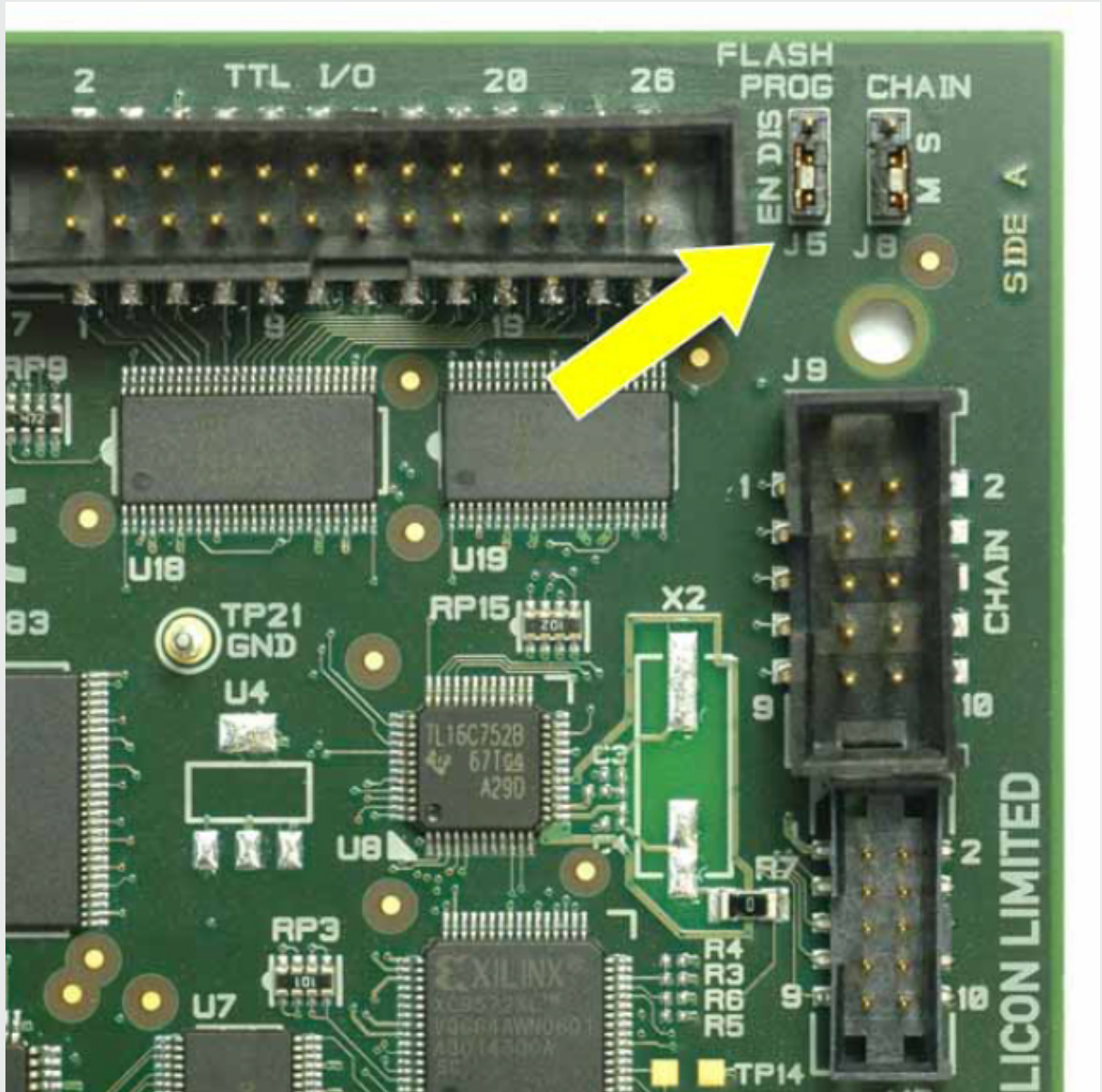

Jumper marked FLASH PROG on your Active Silicon card should be set to enabled (EN)

5. Replace the Phoenix boards in to the host computer and reboot.
6. When the operating system has loaded, run the PfwProg ( Phoenix Firmware Updater ) application, and press the Program button.
7. When the application has completed, shut down the computer.
8. The FLASH PROG jumper may now be set back to the DIS position.
9. Reboot the computer and continue to use the Phoenix boards.

# Overview of SDI input

## How many inputs can each machine have?

Your 4U v2.5 system is equipped with 2x Active Silicon Phoenix PHX-D20HDSDI capture cards. These cards have the ability to capture live video from either SD-SDI or HD-SDI video sources with up to four unique SD or two unique HD feeds per machine.

## What formats do my capture cards accept?

The 4U v2.5 system can have the following SDI inputs:

Inputs	525i TSC	N-625 AL	P-720 50	720p/60	1080i/60	1080p/24	1080p/30
2	✓	✓	✓	✓	✓	✓	✓
4	✓	✓	✓	X	X	X	X

## Capture card performance

The Active Silicon capture card operates with a 2/3 frame delay at 24/30 fps.

## What connections do the capture cards have?

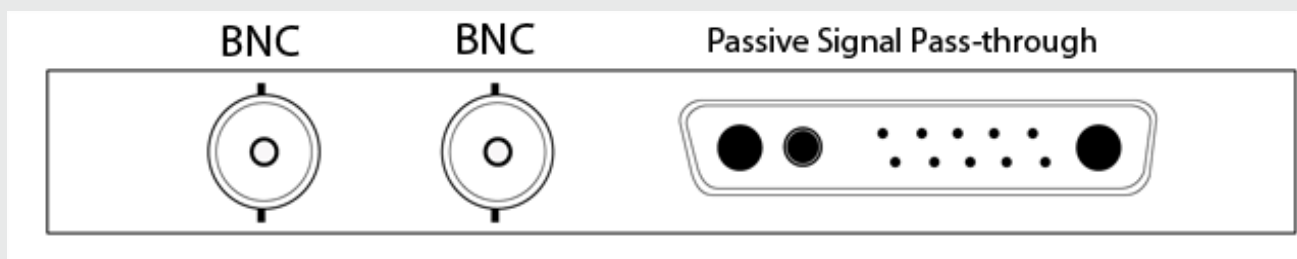

Capture cards connections

# Configuring SDI capture



**Warning:** Live Video input inherently introduces frame latency during playback. Please contact [d3 support](#) for guidance on performance standards.

The first step to getting SDI inputs into d3 is to configure the Active Silicon SDI capture card outside d3. To do this:

1. Run the Active Silicon Phoenix Capture 32-bit application ( Start > All Programs > Active Silicon PhoenixCapture (32-Bit) ). You will now be presented with a screen as in the image below.
2. Select Phoenix > Control Centre .

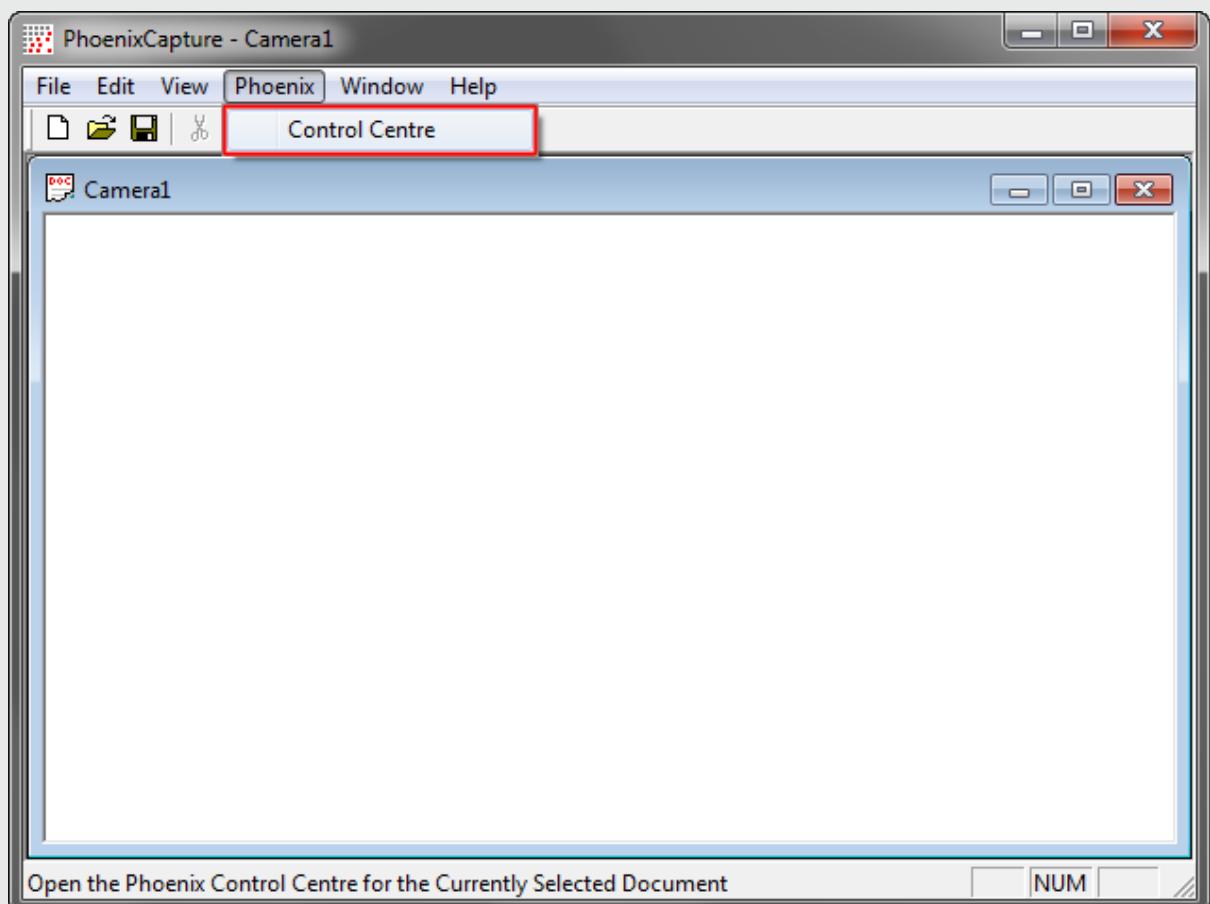



Use the cards capture application, in this example the Phoenix Capture application for a Phoenix card, to set up SDI capture

3. Select the board number and channel that you plugged your SDI source into then hit select file.

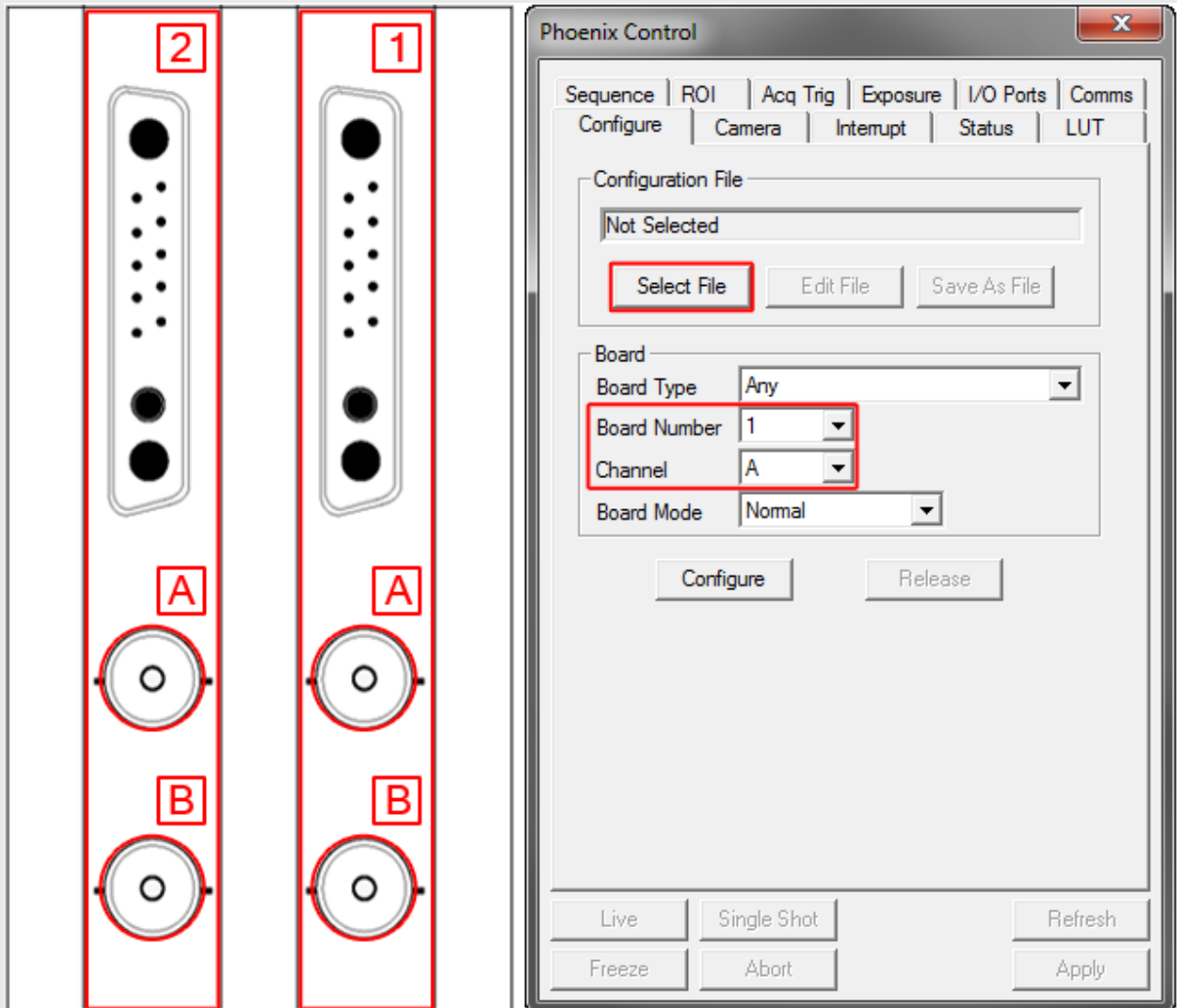

4. Select the board ( 1 ) or ( 2 ) and port ( A ) or ( B ) within the Phoenix Control window
5. Select the correct configuration file for the SDI signal you are capturing ( PAL , NTSC , 1080i or 1080p)

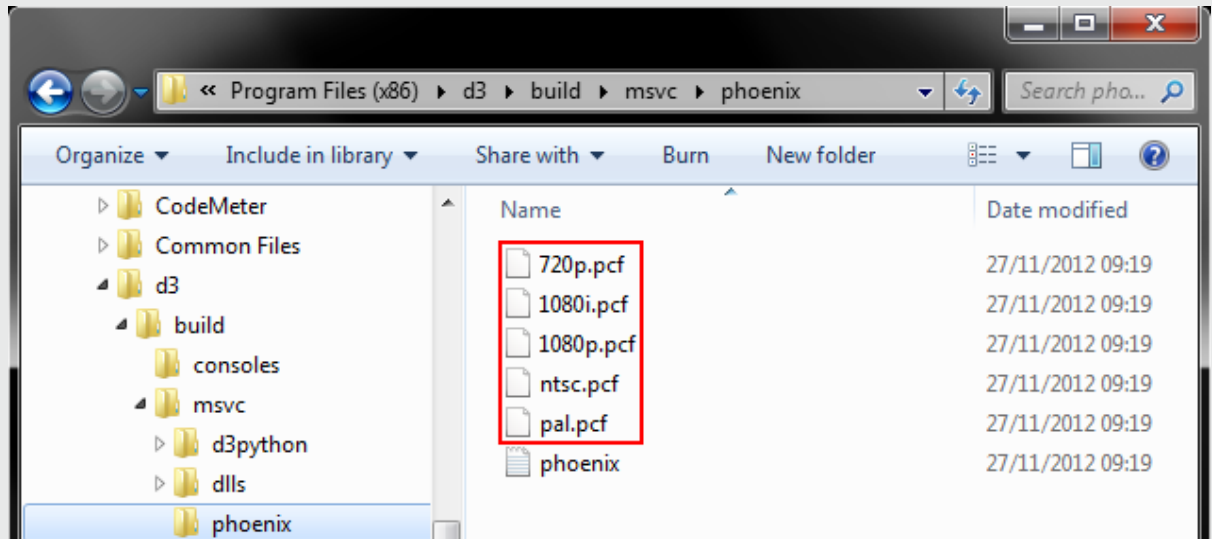

6. Choose the appropriate configuration file for the SDI signal
7. Click configure to save your settings.

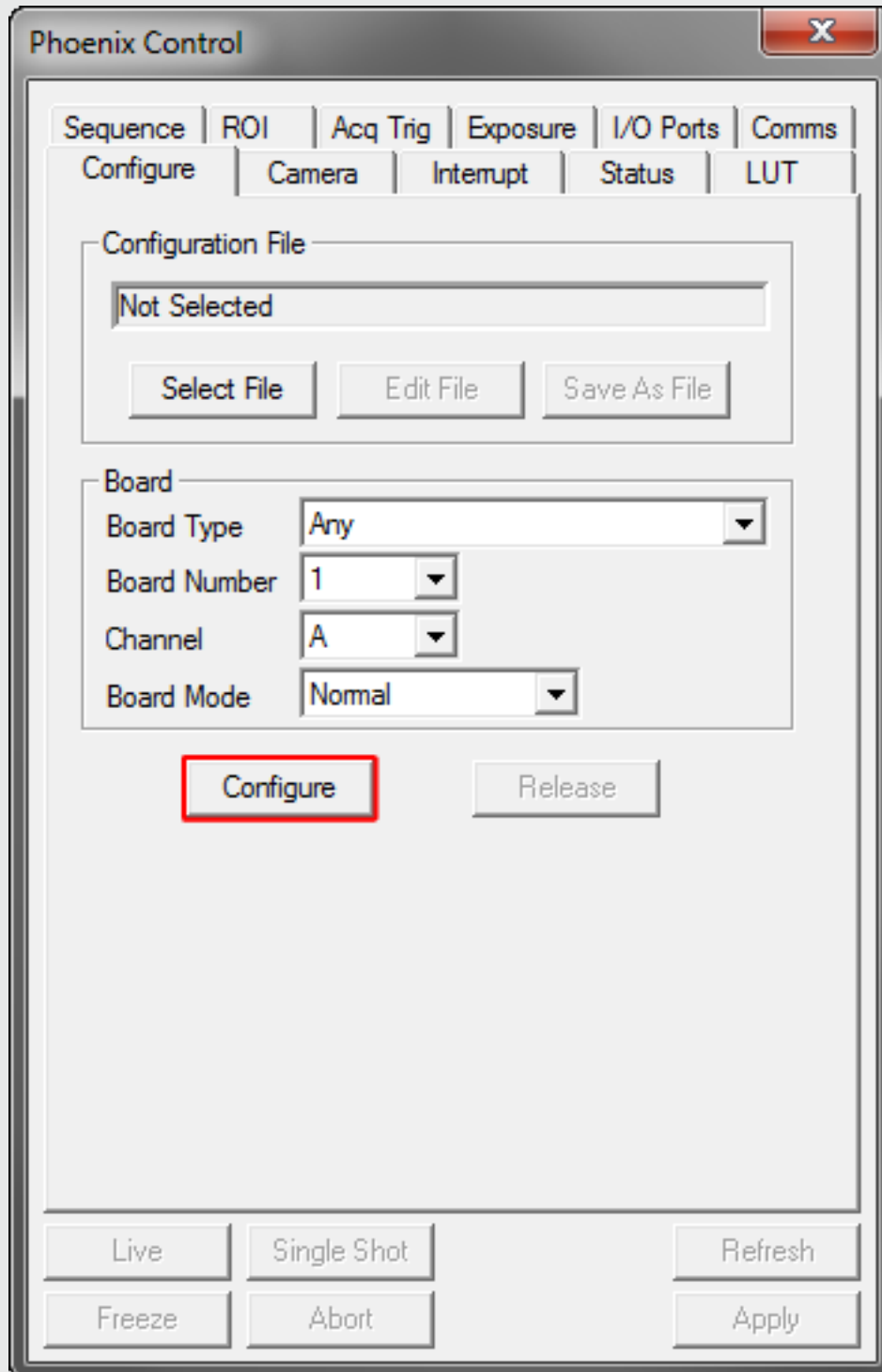

Click Configure to save your changes

8. Click Live to test your signals.



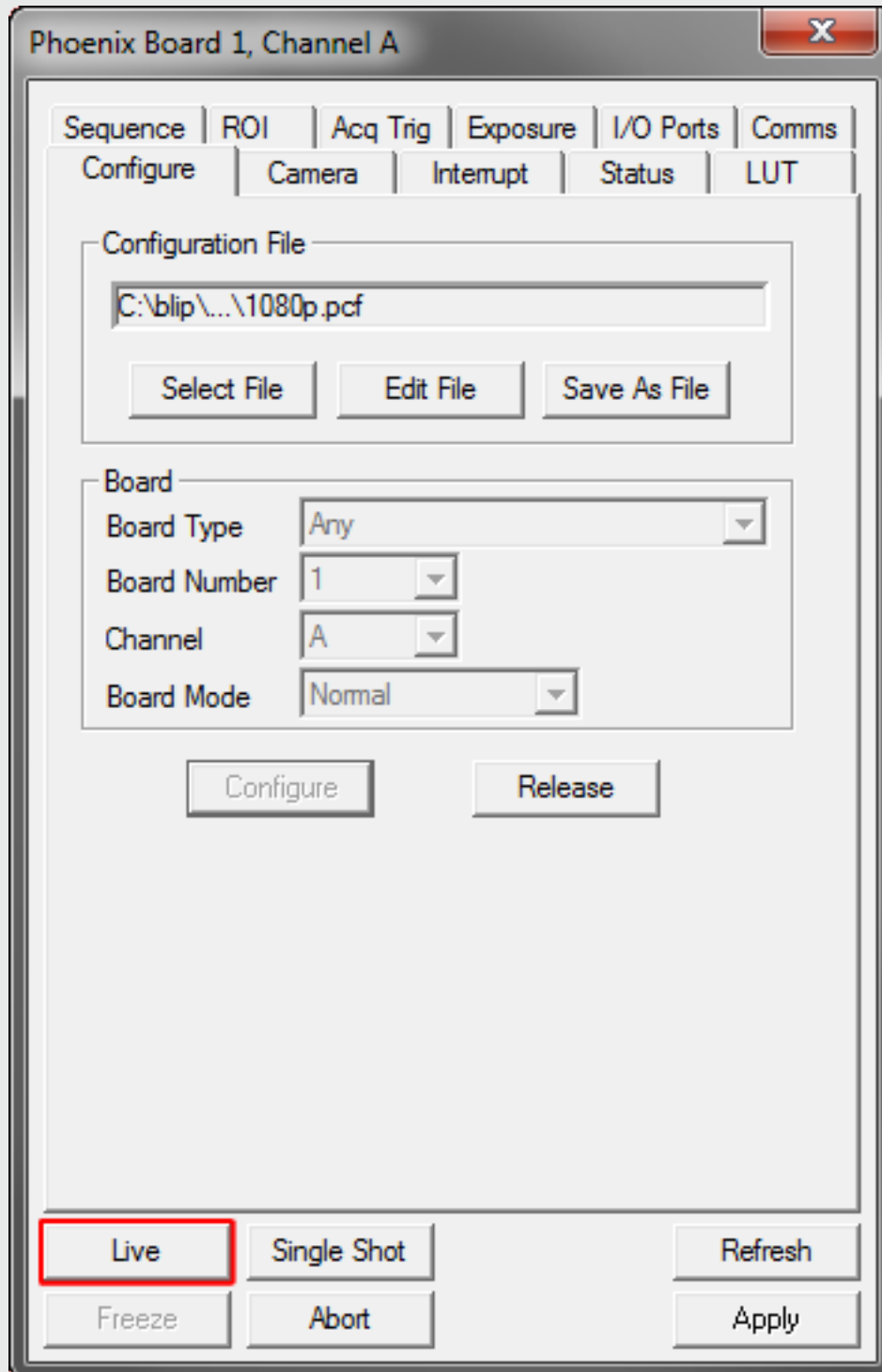

Click Live to test your signals

You should now see the SDI input in the camera window screen in the Active Silicon PhoenixCapture window.



Signals that are sent successfully will display an image in the camera window of the cards capture application

9. Click **Configure** to check the status of the card.

Please note: if an error message pops up it may be necessary to re-flash or update the driver software. For any other problems please contact the d3 support.

The capture card has now been configured and you can continue with creating a Video sampler device in d3.

# Setting up live video input in d3

Please see the [Setting up live video input page](#).

# Windows Updates

**Please note: that under most circumstances we do not recommend users to install Windows Updates on their own. There are, however, cases in which machines may require a specific Intel update in order to function properly within a network (Intel - LAN, LAN (Server) - Intel(R) 82579LM Gigabit Network Connection).**

Diagnosing this issue is fairly simple, as the main symptom is a noticeable decrease in performance and unstable frame rates occurring whenever the machine is networked.

## How to Install the Intel update

If you are experiencing the symptoms described above and require the Intel update, please follow the steps below:

1. Click on Start
2. Search for Control Panel
3. Click on Windows Update
4. Click on Check for updates

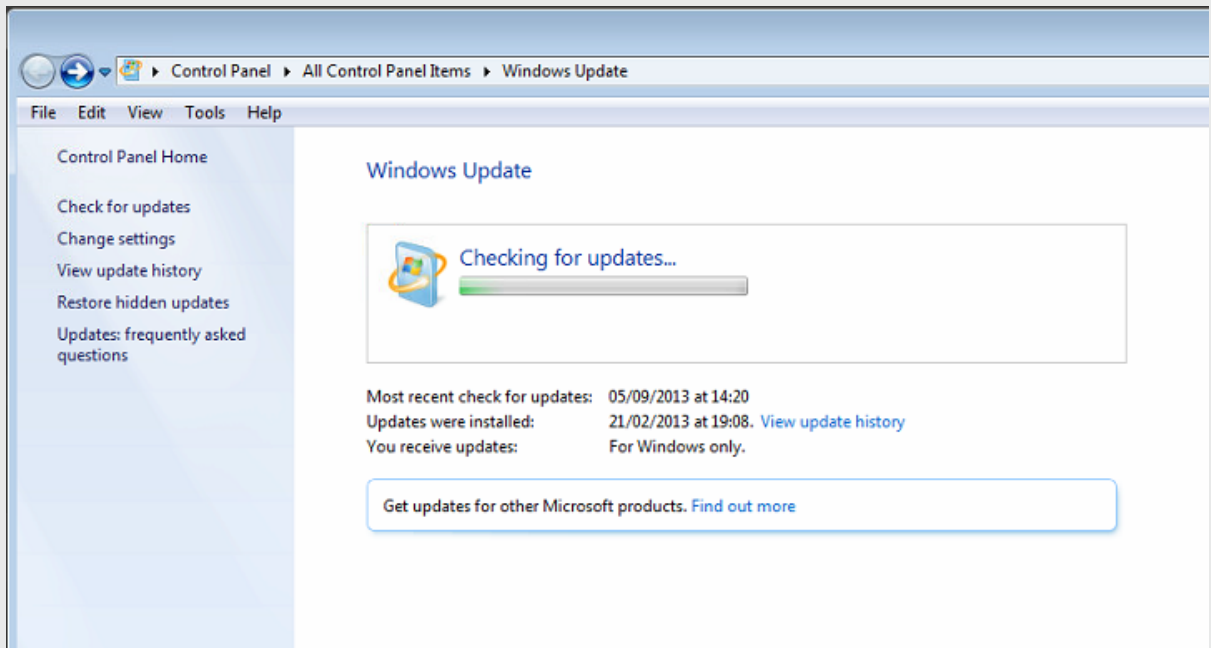

**Warning:** At this point, Windows may attempt to install updates automatically. DO NOT interrupt those automatic updates as they are required for the Intel update to successfully install.

5. Once the first automatic updates are installed and Windows has finished searching for updates, you will be able to view and select specific Important and Optional updates to install
6. Select to View Important updates and untick the box at the very top of the list to untick and de-select all Important updates
7. Navigate to the Optional updates tab and tick the box on the Intel update from there: Intel - LAN, LAN (Server) - Intel(R) 82579LM Gigabit Network Connection

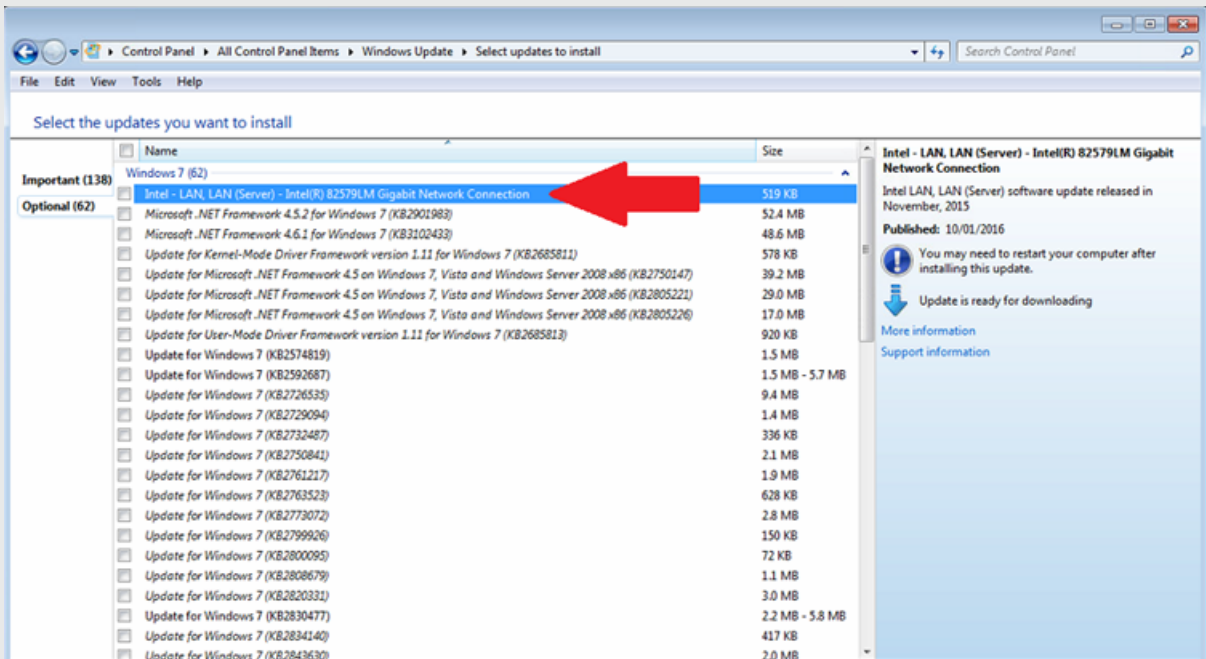

8. Ensure there are no selected updates from the Important tab, then install the Intel update on its own.

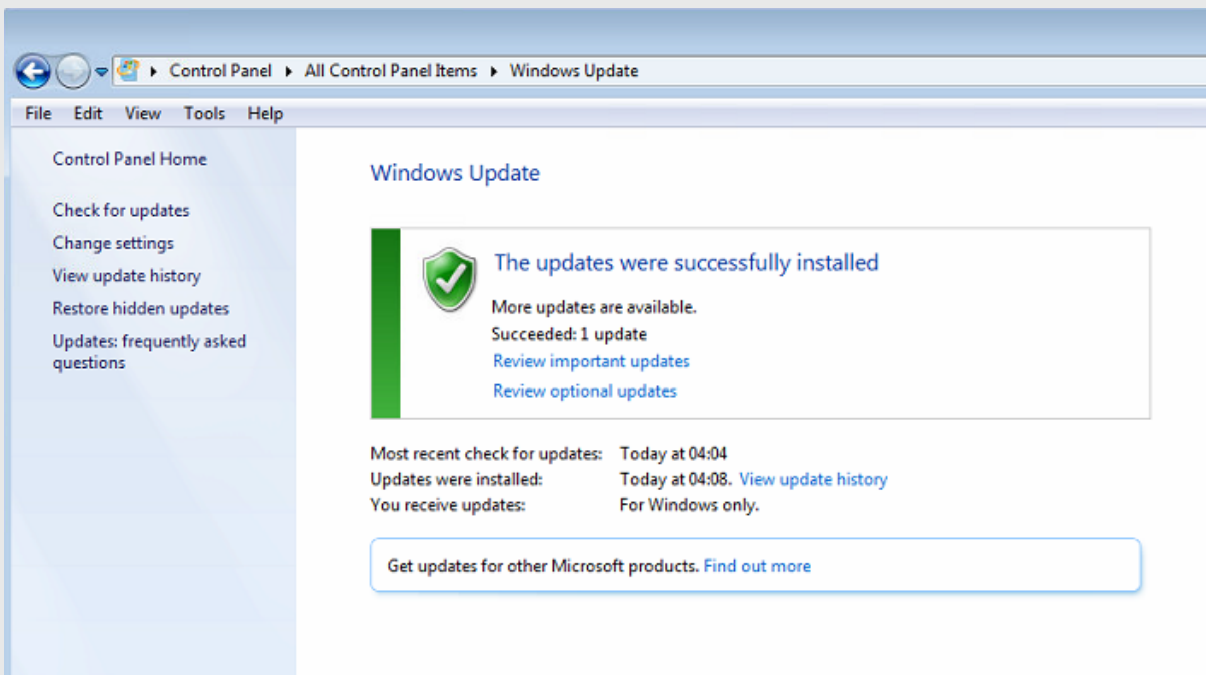

9. If the update is successful you should see the above screen.

At this point you should notice an increase in network performance right away. There is normally no need to restart the machine, although restarting is always recommended.

# Identifying the hardware version

For information on how to identify the current software version please see the software sub-chapter [Identifying the version](#).

## Locating the serial number

Every d3 machine has a 5 digit serial number, each 4u machine has the serial number in 3 locations.

- The front panel - open the door and it is located next to the power switch.
- The right hand side panel.
- On the rear panel

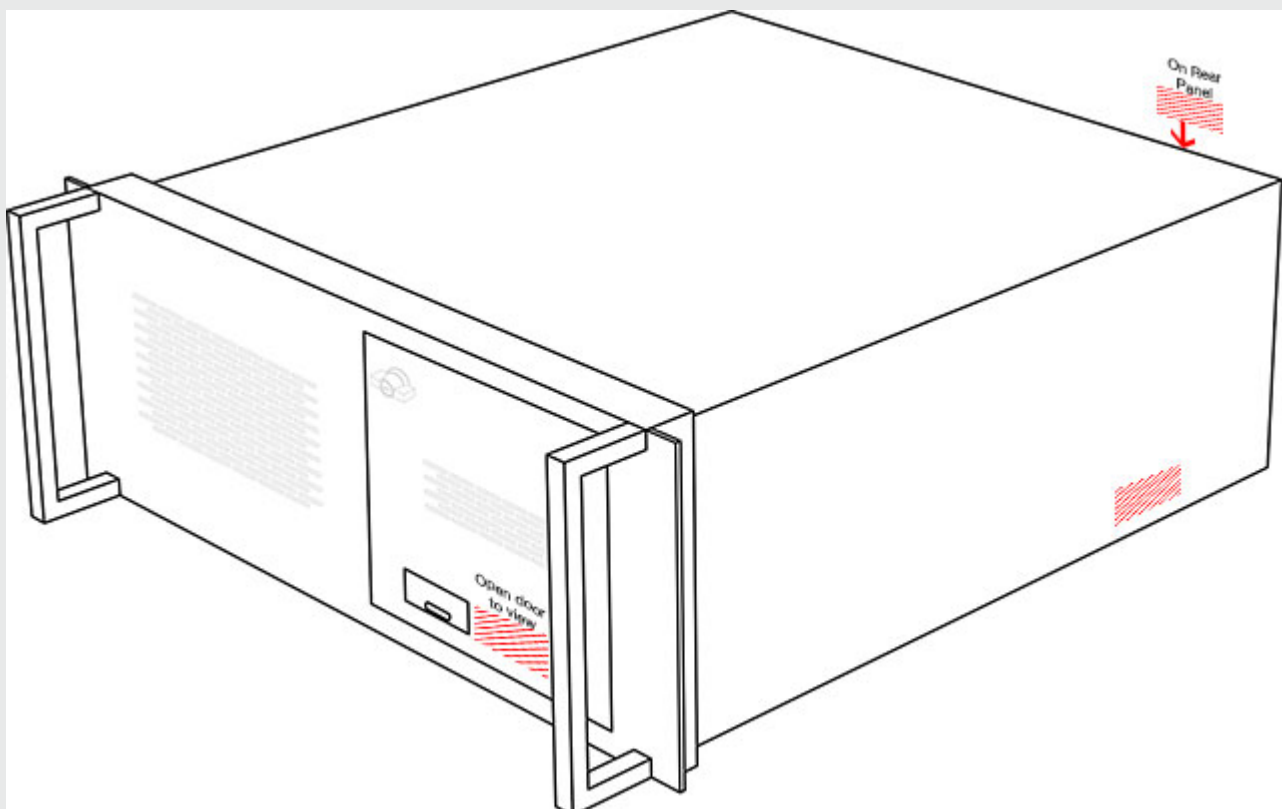

# Updating the software

For information on how to update the current software version to the latest release please see the software user guide sub-chapter [Updating the software](#).

**Please note:** to update to the latest release on your 2U or 4U machine please see the software user guide sub-chapter [System Requirements](#).



# Factory system restore - v2.5

This sub-chapter will outline the process involved in restoring your v2.5 server to its factory defaults and correctly configured to its original settings. To do this you need to restore the system from its restore partition on the C: drive . This process will return all settings back to the original configuration of your Disguise system.

**Please note:** only machines after January 2012 will have a populated restore partition. This includes all 4U v2.5s. If in doubt over whether your system is included, or if your machine is older than January 2012, please contact the [Support team](#).

**Please note:** If you need to reimage a machine completely please contact the [Support team](#) who will provide a download link to download a copy of the machine image.

## Preparing your system for restoration

To prepare your system for restoration:

1. Back up any important files or program installers stored on the C: drive onto an external disk as these will be replaced and lost by the system image.

Please note: this process will have no impact upon any data stored on your systems Media drive. However, to avoid confusion between disks it may be worthwhile removing the media drive from slot 1 on the systems hot swap drive caddy.

2. Make a note of your systems QuickTime Pro Registered To and Registration Code details. This information is in the paperwork you received with each of your systems.

If this is not to hand you will be able get this information by following these steps:

3. Open QuickTime Player (Start menu > All Programs > QuickTime > QuickTime Player ).
4. Select Edit > Preferences > Register . Here you can see who QuickTime Pro is registered to and the Registration Code.
5. Make a note of both of these details.

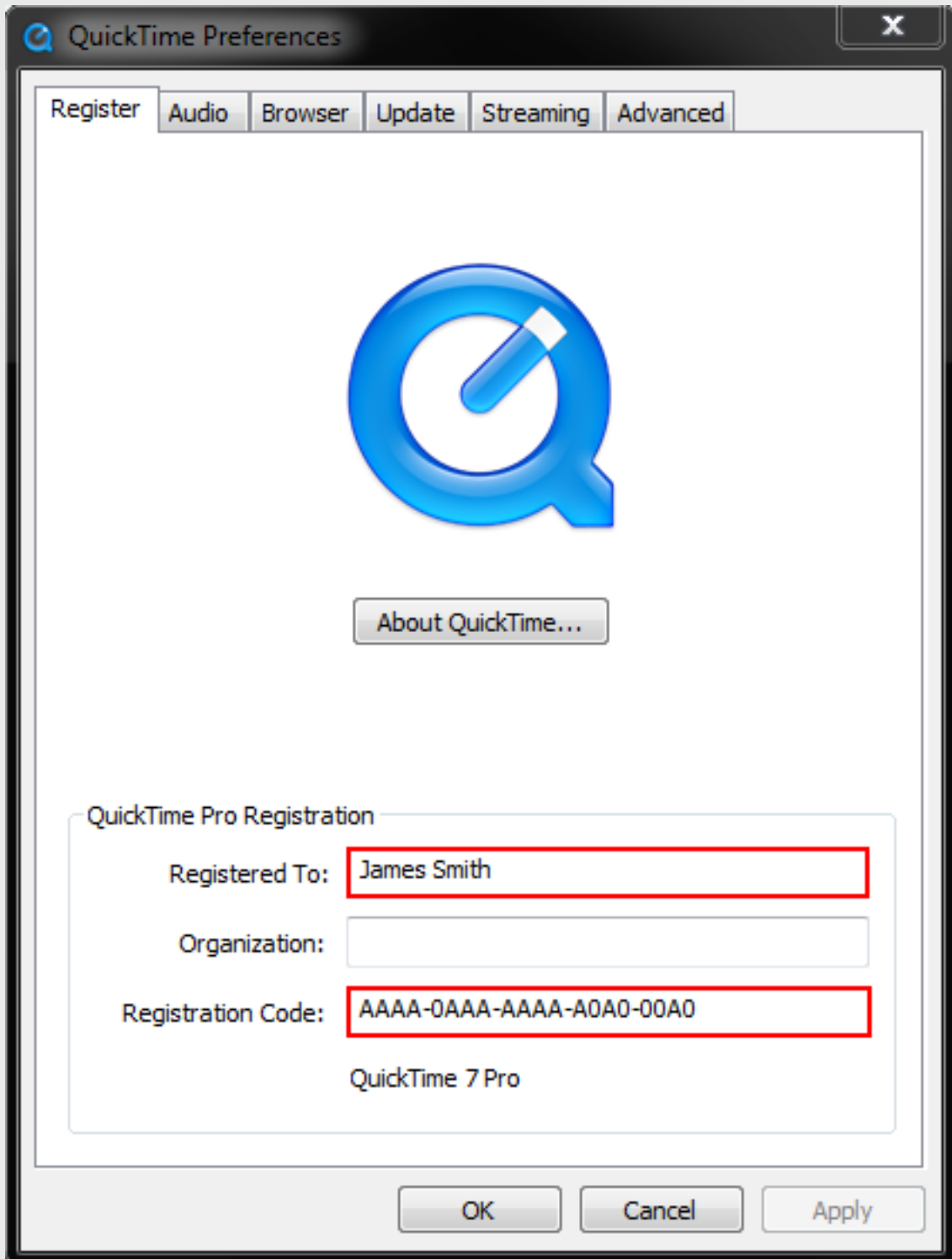

Make a note of your systems QuickTime Pro Registered To and Registration Code details

In addition you will need to deactivate MacDrive 9 before the system is restored.

To deactivate MacDrive 9:

1. Open MacDrive 9 Standard ( Start > All Programs > MacDrive 9 ).
2. Select Deactivate MacDrive Standard .
3. Make a note of the displayed serial number.

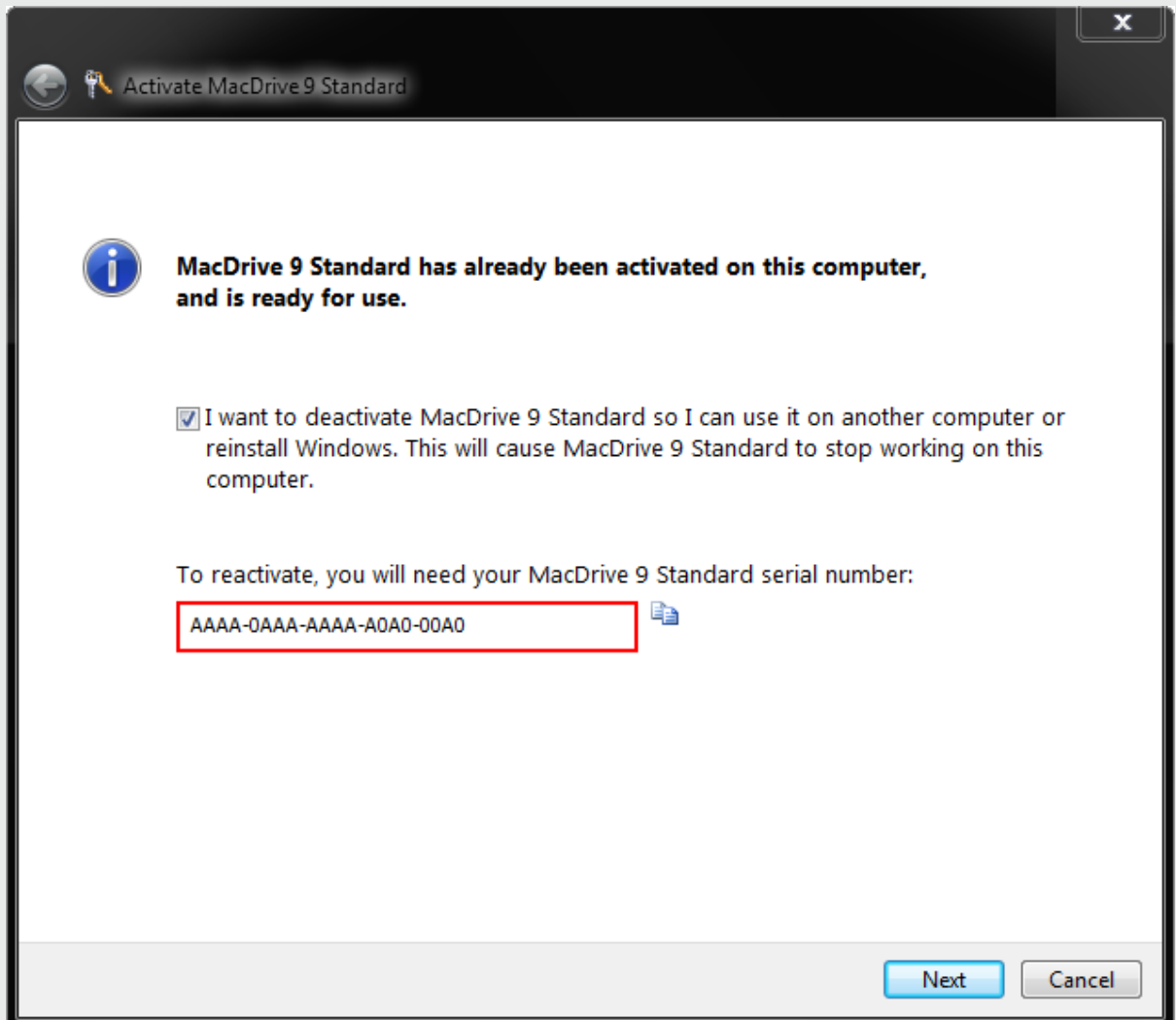

Make a note of the displayed serial number

4. Tick the box **I want to deactivate MacDrive 9 Standard so I can use** and select Next.

## Restoring your system

Once the above steps have been completed you are ready to start the system restore.

To start the system restore:

1. Open the Control Panel (Start menu > Control Panel ).
2. Select Backup and Restore .

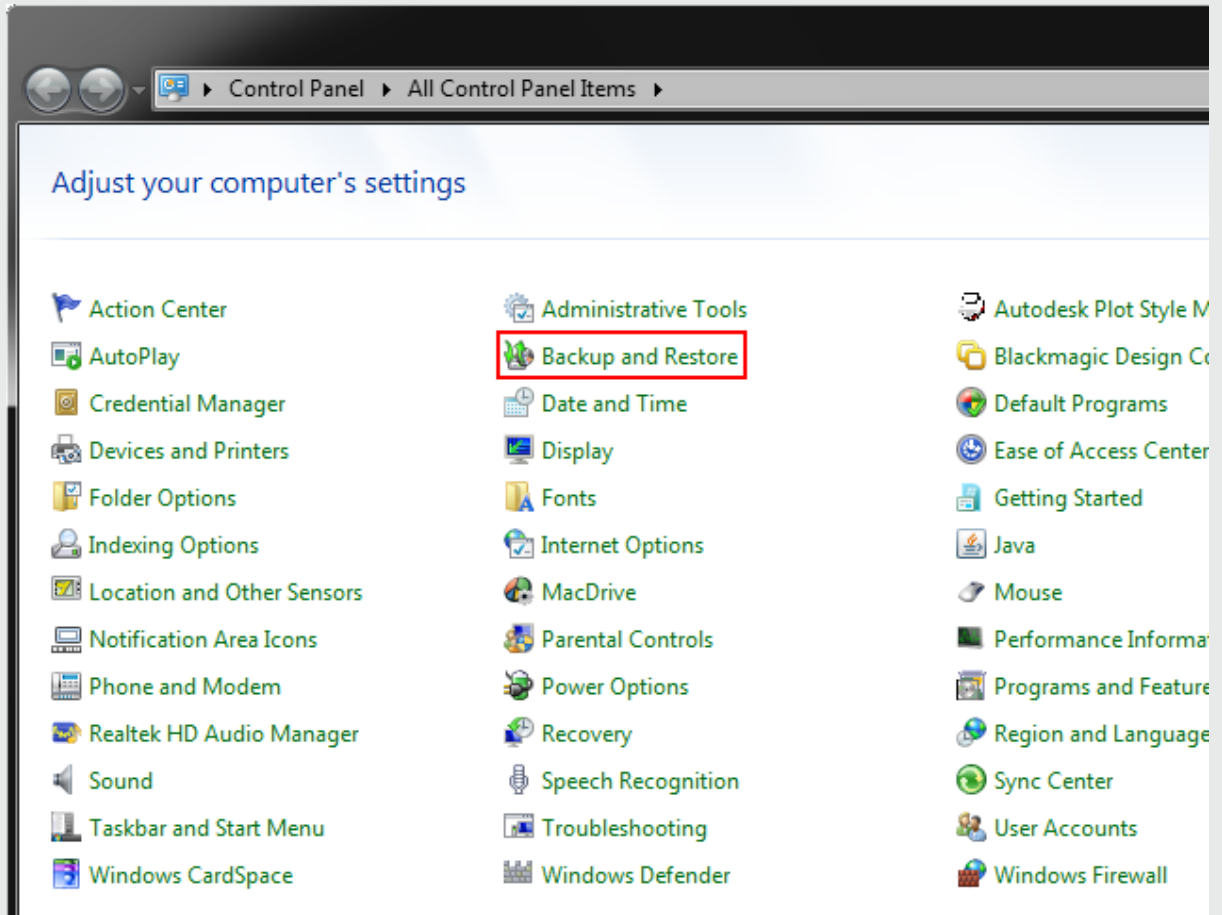

*Select Backup and Restore from the Control Panel*

3. Select Recover system settings or your computer.

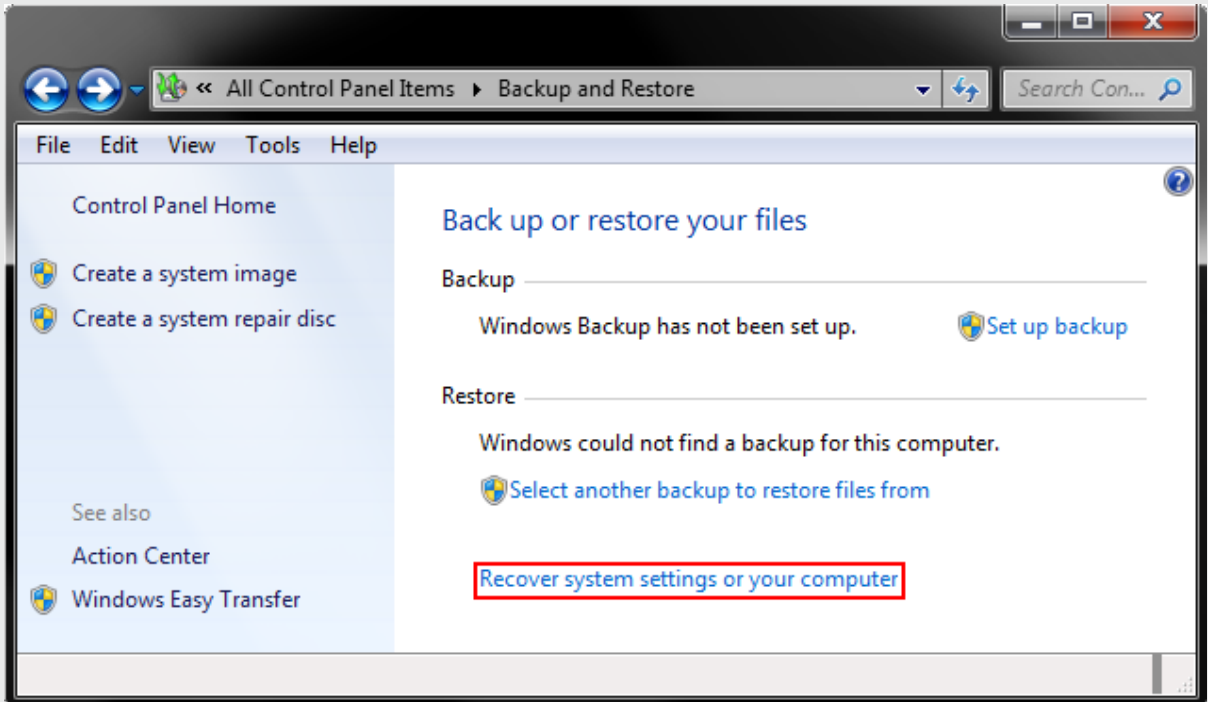

Select Recover system settings or your computer

4. Select Advanced recovery methods.

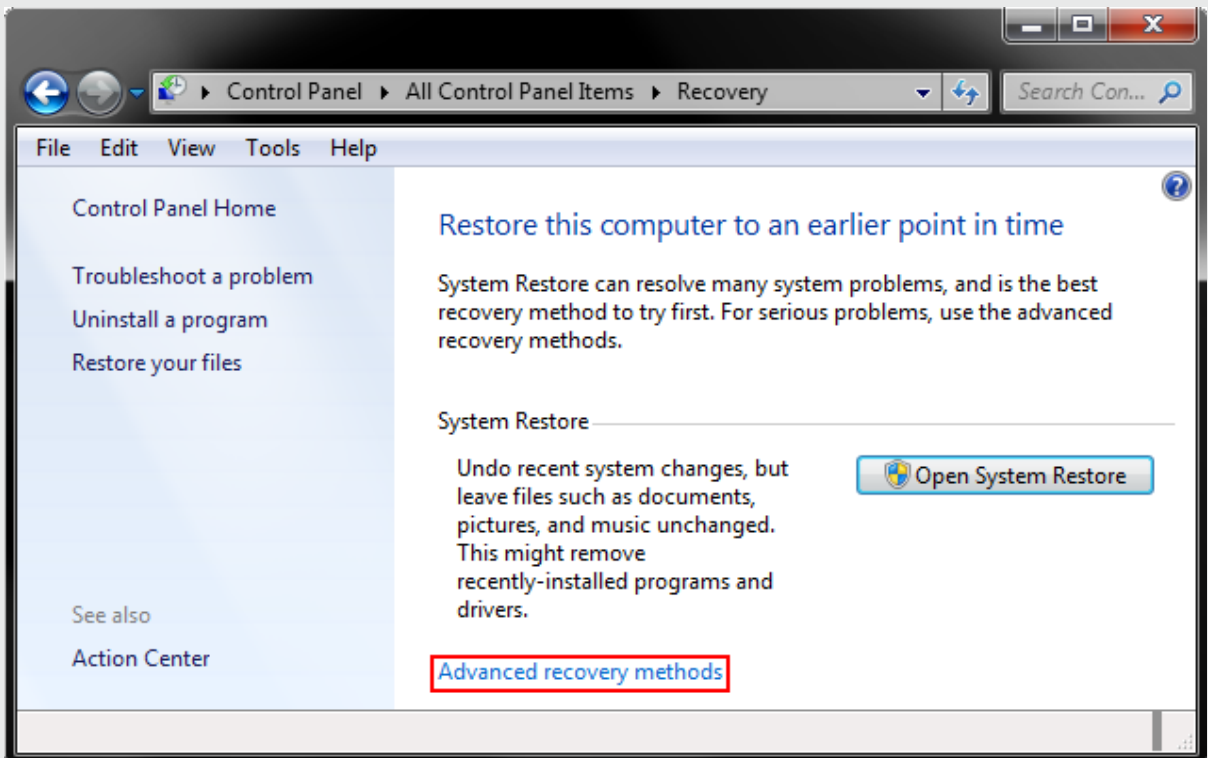

Select Advanced recovery methods

5. Select Use a system image you created earlier to recover your computer.

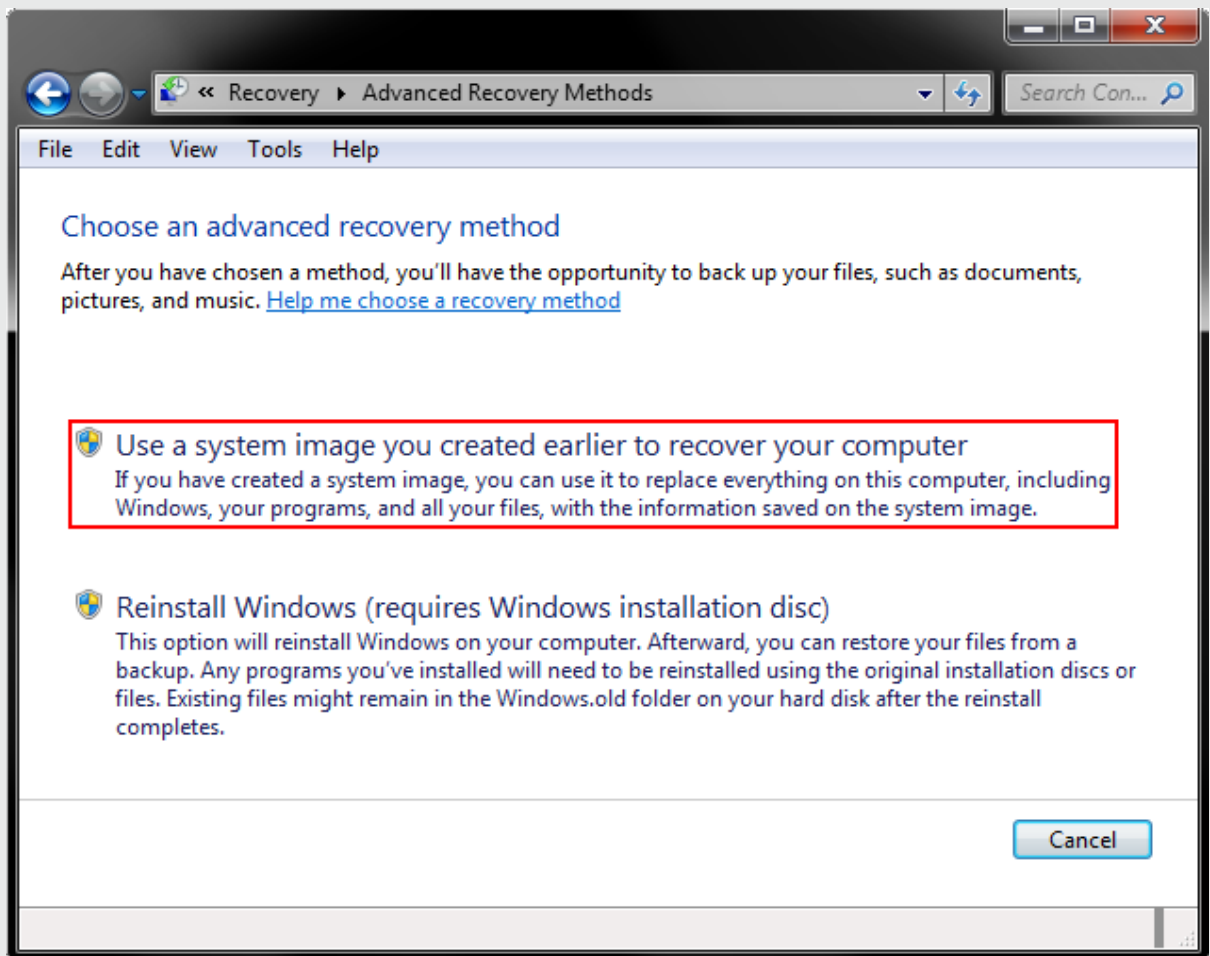

*Select Use a system image you created earlier to recover your computer*

6. You will then be asked Do you want to back up your files? Select Skip if you followed the instructions above and backed up any important files or program installers stored on the C: drive onto an external disk. If not please backup any important files.

**Please note:** this process will have no impact upon any data stored on your systems Media drive. However, to avoid confusion between disks it may be worthwhile removing the media drive from slot 1 on the systems hot swap drive caddy.

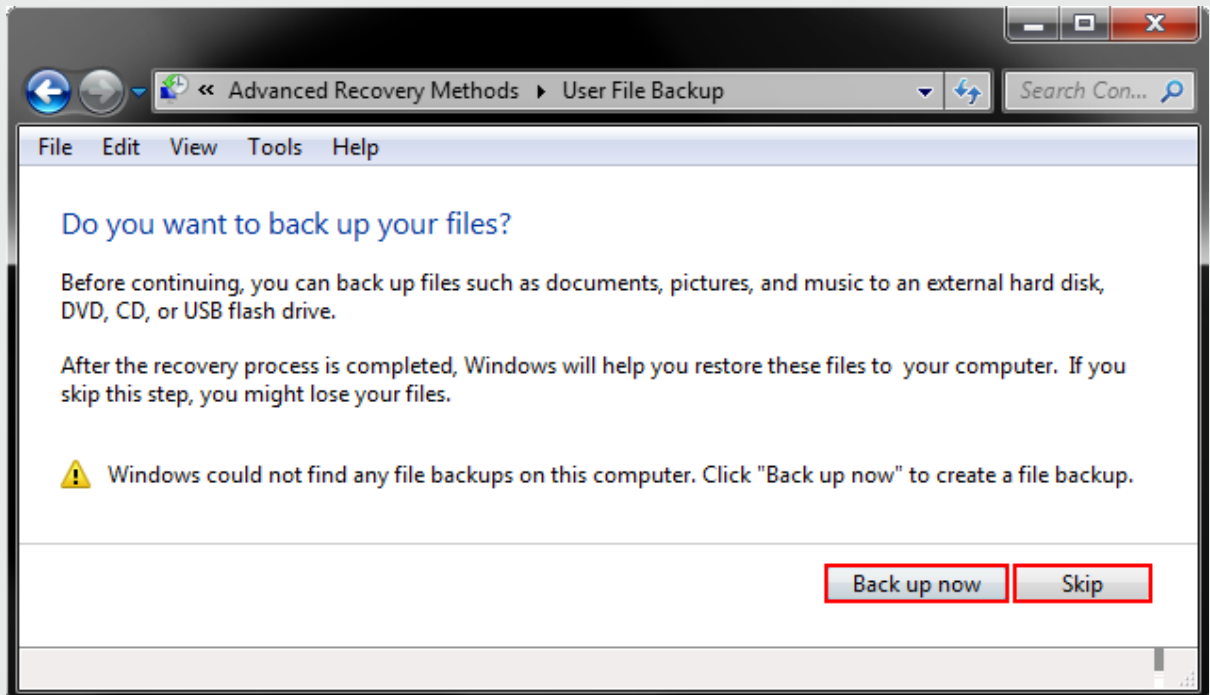

Select Skip if you backed up any important files or program installers stored on the C: drive, otherwise select Back up now

 **Warning:** everything saved on the (C:) drive since you received your system will be lost unless backed up.

7. From here you will be prompted to Restart your computer and continue the recovery. Select Restart.

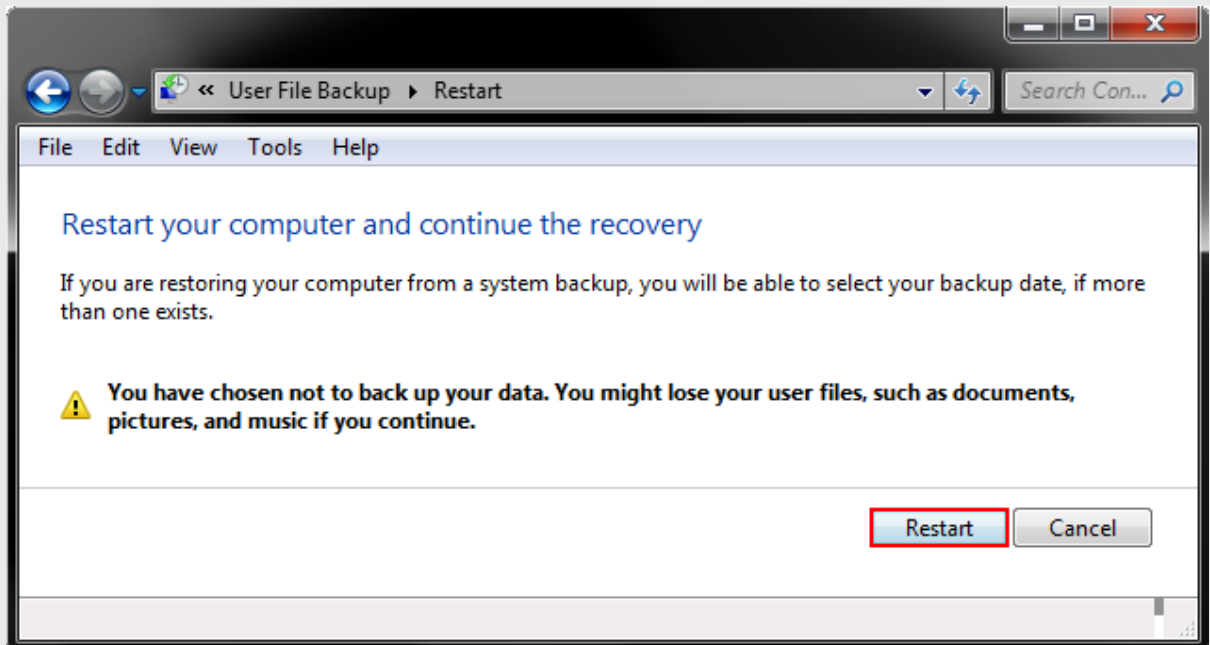

Select Restart

Your system will now reboot into the Windows Recovery Environment.

8. You will be presented with a window asking you to Select your keyboard input method . After doing this Select Next>.

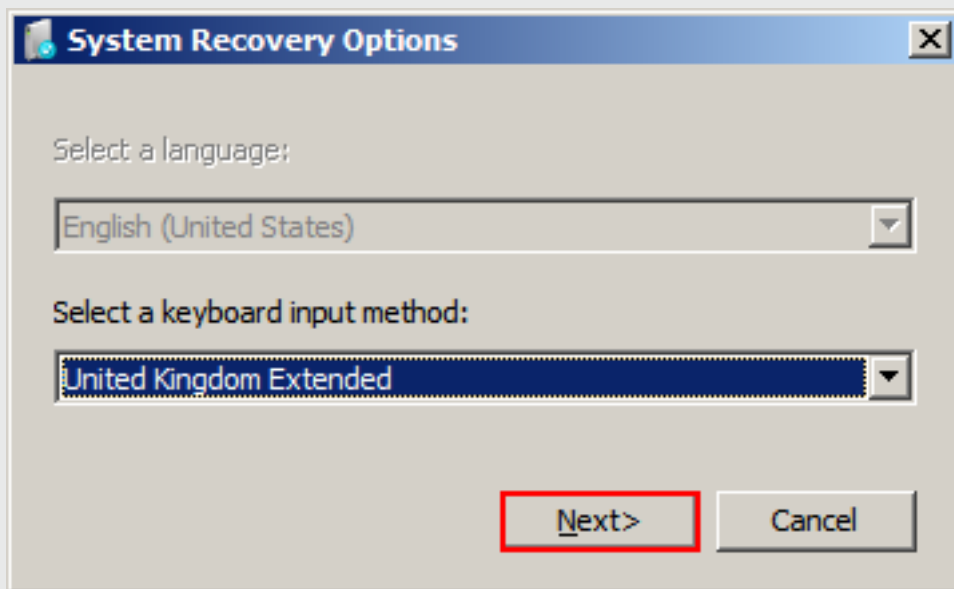

Select your keyboard input method and then select Next>



9. You will then be prompted to Select a System Image Backup. The location should be set to Restore (F:)

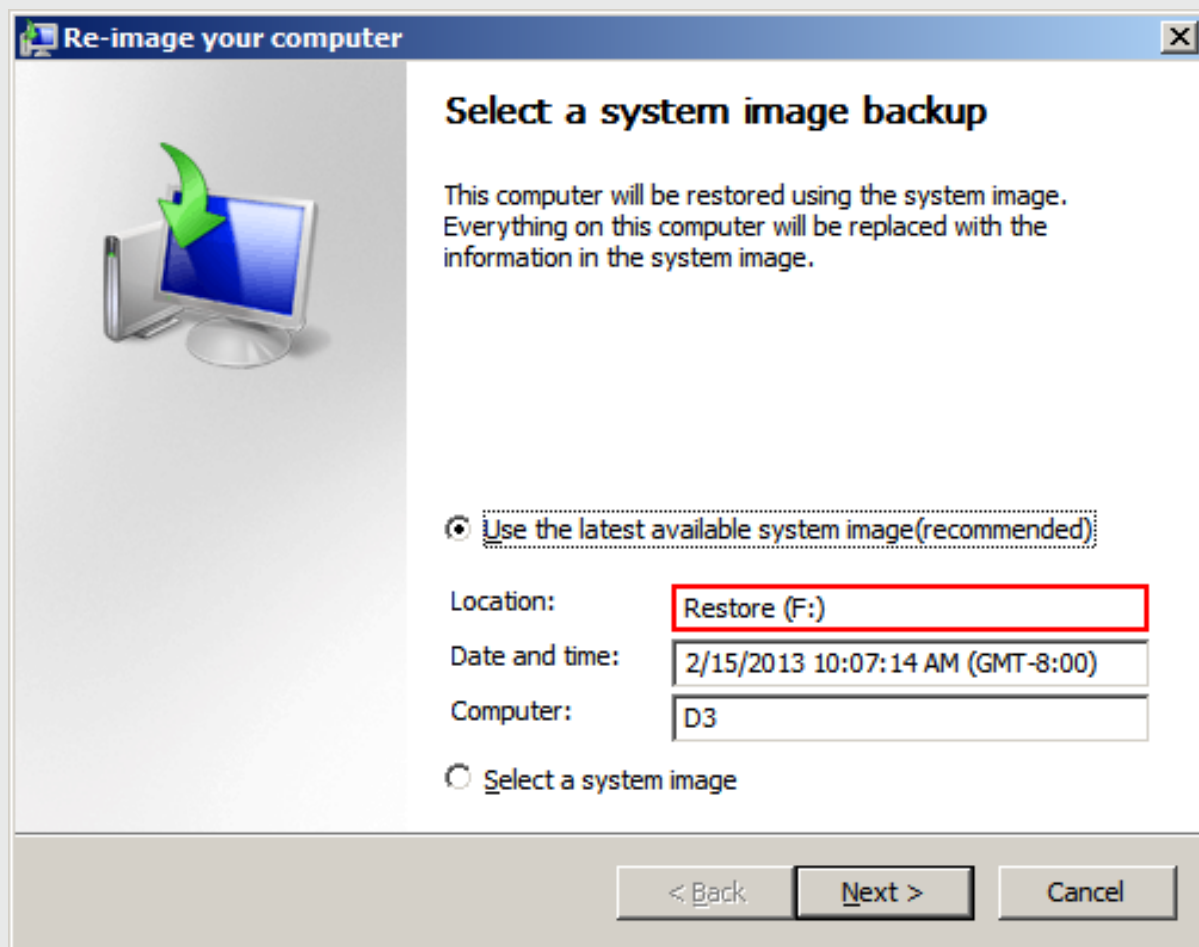

*Set the location for your System image backup to Restore (F:)*

10. Select Next>.
11. This will be followed by Choose Additional Restore Options, this can be ignored so just select Next>.

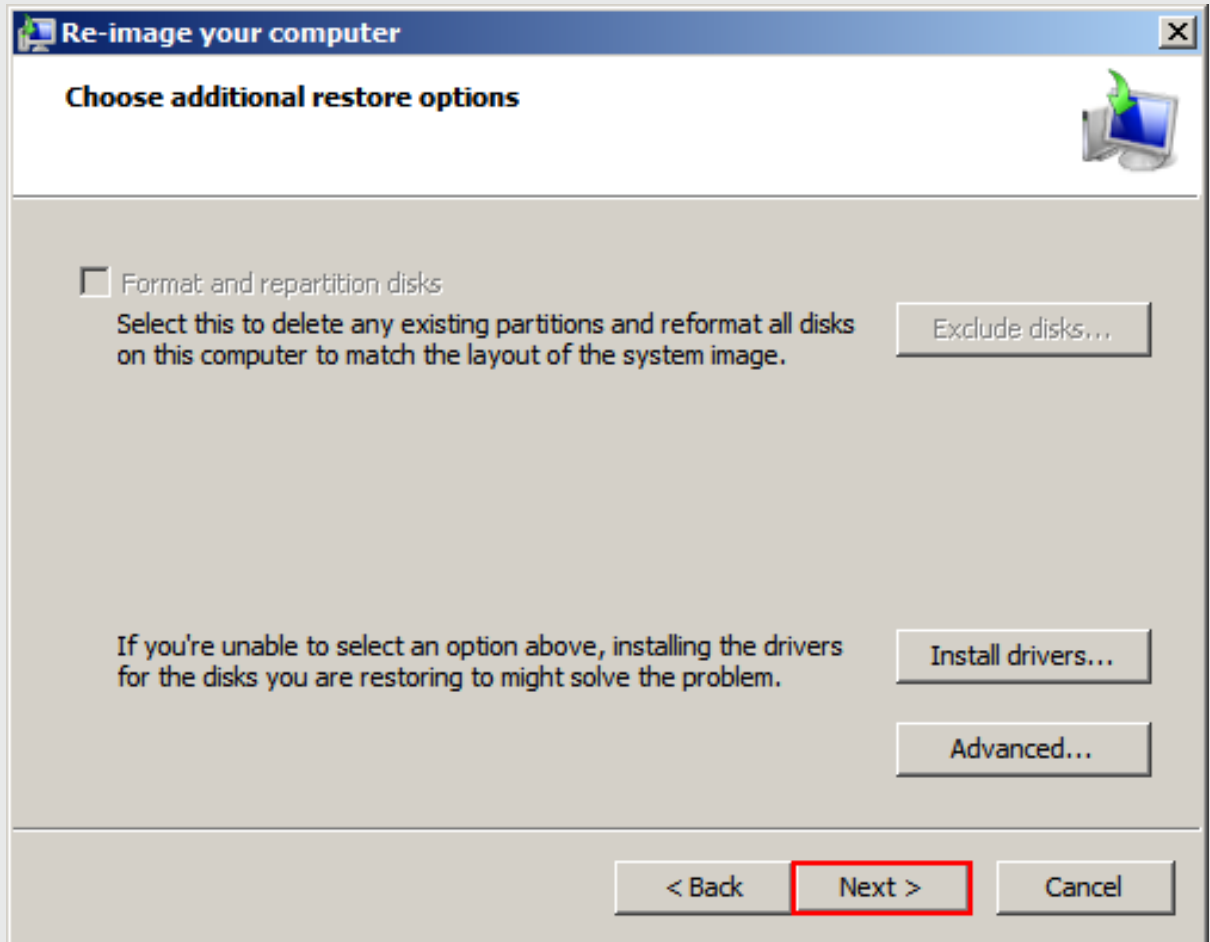

Select Next>

12. After selecting Finish on the following window you will need to confirm that All data on the drives to be restored (C:) will be replaced with the data in the system image. Select Yes.

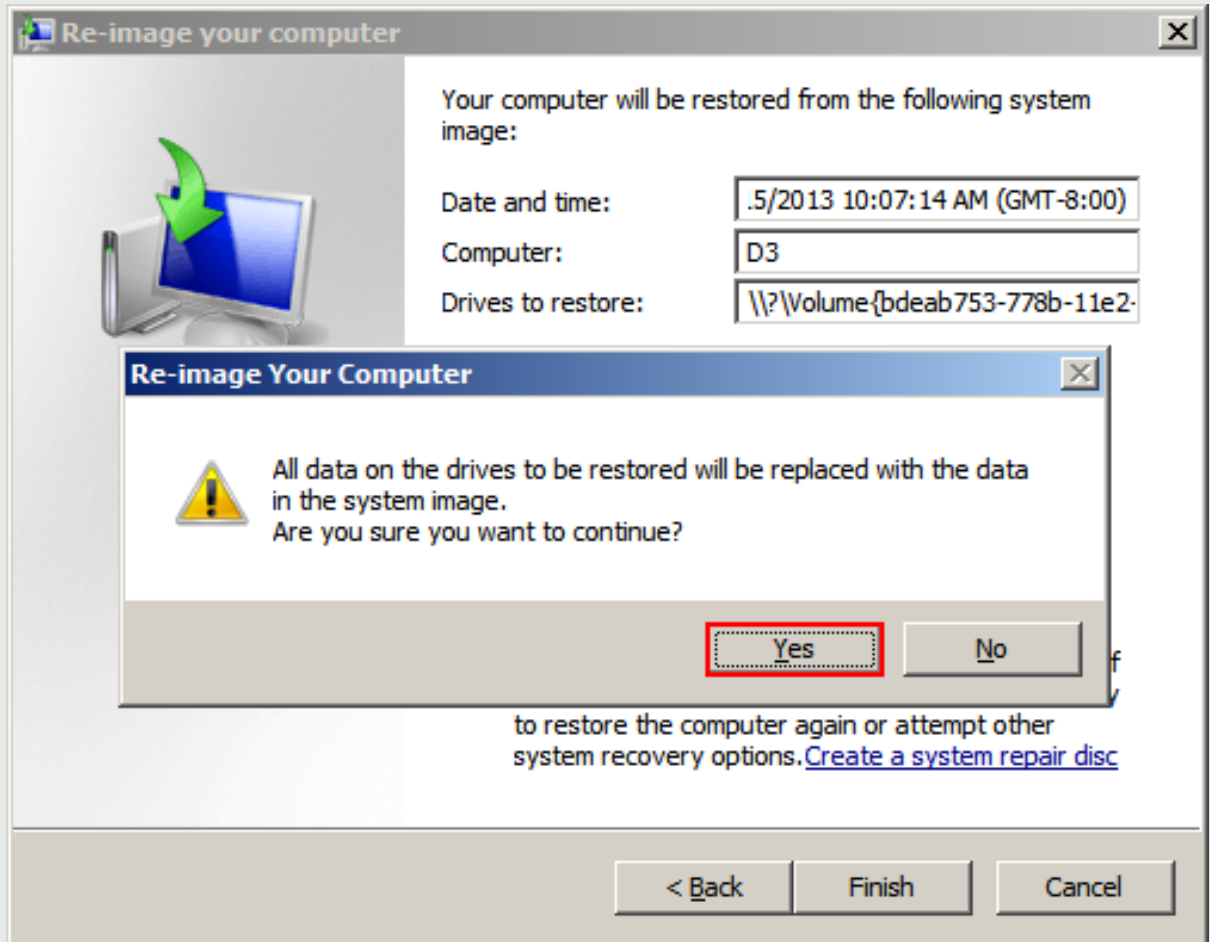

Select Yes

The restore process will then start automatically and should take no longer than 10mins.

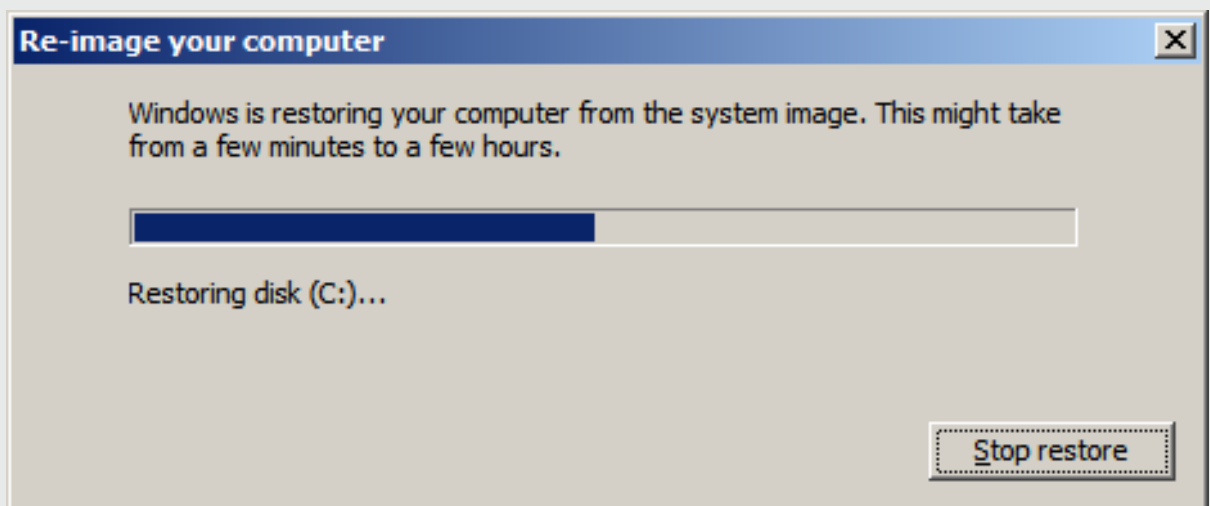

Restore process will start automatically

Once this has completed the system will automatically reboot and will be restored to the factory defaults.

## After a system has been restored

- Once the reboot is complete, you will need to select Cancel on the pop up window stating that Recovery has completed. Do you want to restore your user files?
- You will then need to restart the machine as prompted.
- Once the machine has finished its reboot cycle you will need to ensure that the QuickTime and MacDrive Registration keys and Serial numbers have been carried across. This should be the case, however if not you can reactivate the software by following the steps below.

**Please note:** Additionally, you may need to apply a specific Windows Update (though only apply if actually needed)

## QuickTime Pro

- Open QuickTime Pro (Start menu > All Programs > QuickTime > QuickTime Player ).
- Open the Edit tab > Preferences > Register. This will open the registration window.
- Re-enter the Registered To & Registration Code fields recorded earlier.

## MacDrive 9

- Open MacDrive 9 Standard (Start menu > All Programs > MacDrive 9 Standard ).
- Select Activate MacDrive Standard . This will open the Activation window.
- Enter the Serial number recorded earlier.

## Graphics cards configuration

### What graphics card does my d3 machine have?

Your d3 4U v2.5 uses AMDs Firepro V8800 graphics card. It is capable of driving 4 individual outputs at up to 2560 x 1600 pixels using the DisplayPort interface.



### What connections does the V8800 graphics card have?

The V8800 graphics card has 4 DisplayPort connectors, please see example below:

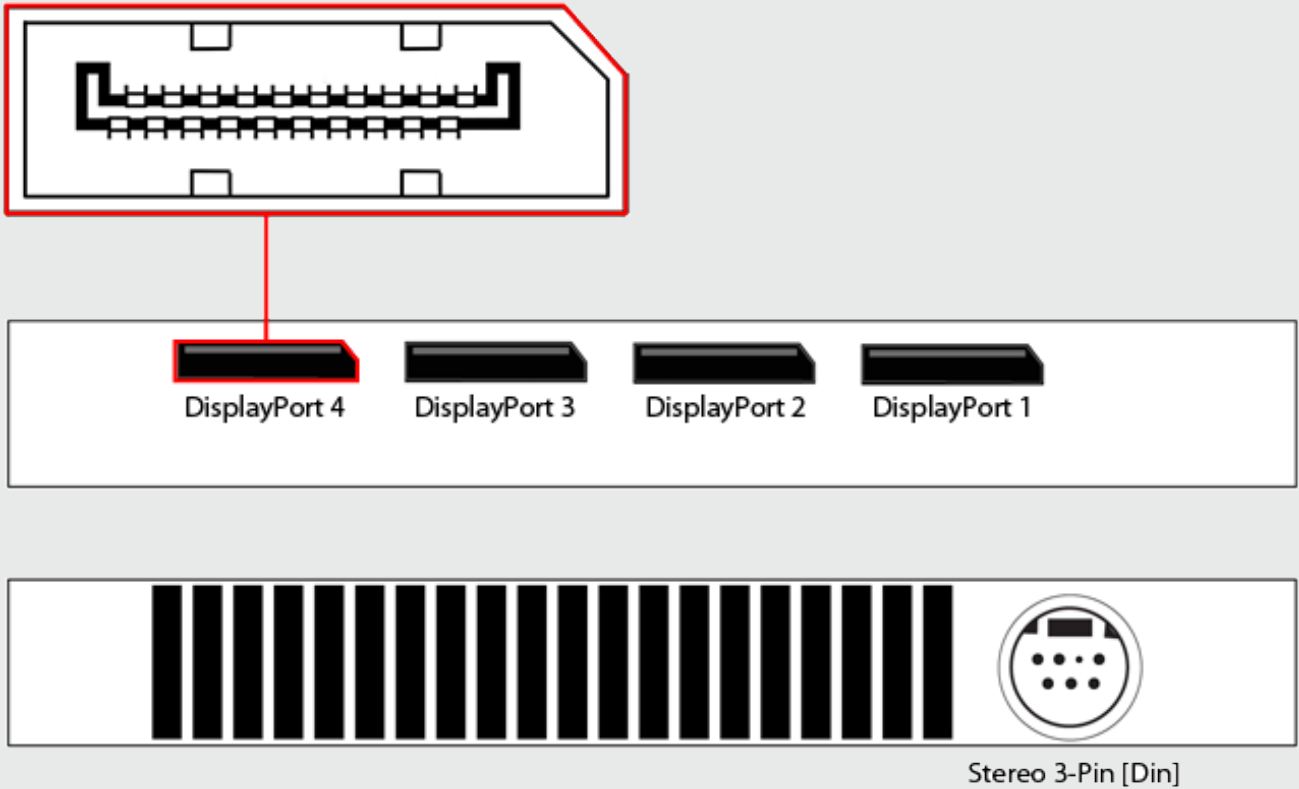

AMD FirePro V8800 graphics card is used by the 4U v2.5 machine and has four DisplayPort connectors

In order to use the DVI interface please use the active DisplayPort adapters supplied with your 4U v2.5 system.

## Settings for your V8800 graphics card

- Once you have opened Catalyst Control Center, expand the AMD FirePro option on the left side pane and select AMD FirePro Settings.

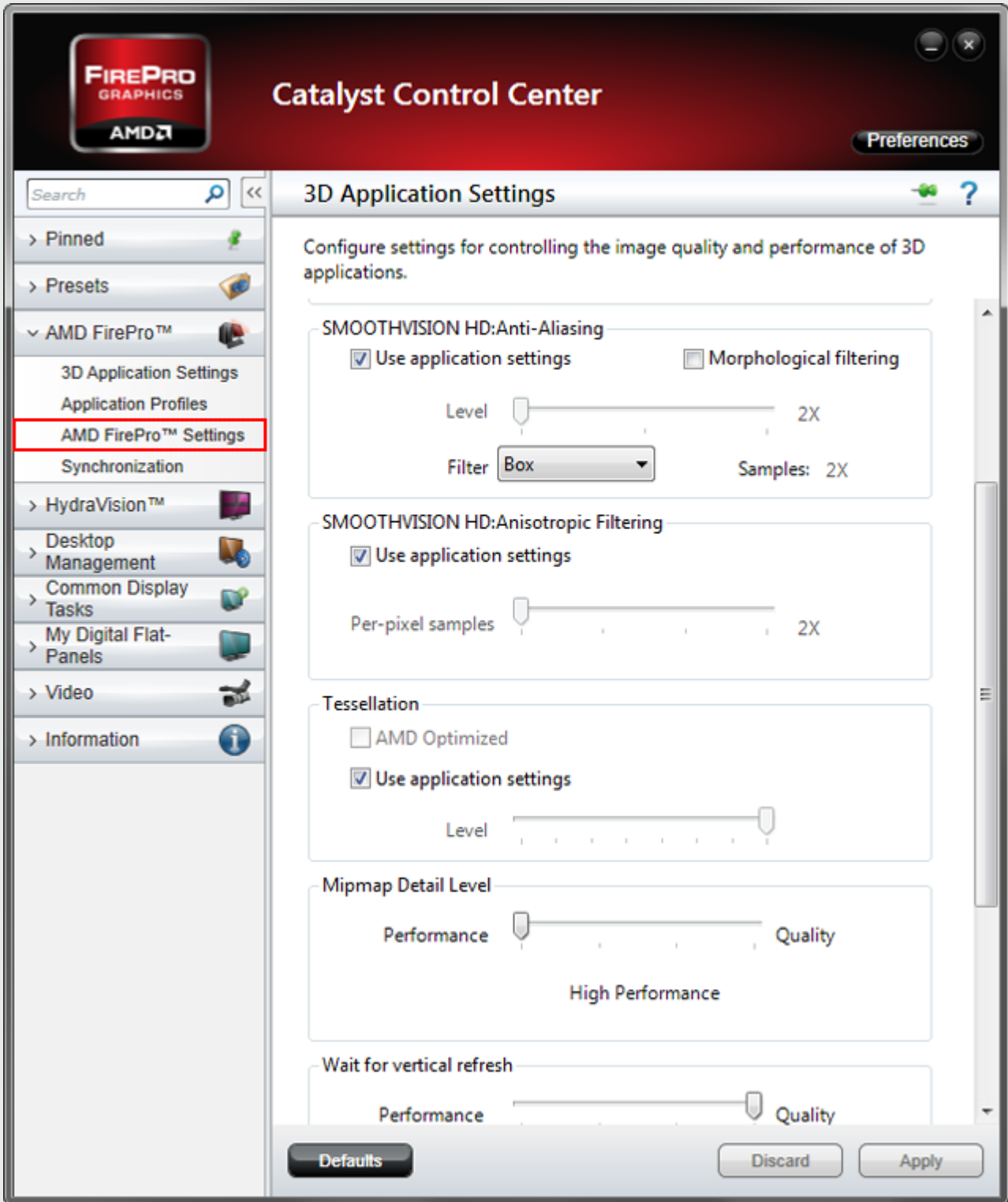

Select AMD FirePro Settings under AMD FirePro from the Catalyst Control Center and change the settings to those shown below to maximise performance for a AMD FirePro graphics card

Change the configurations to the following:

## SMOOTHVISION HD: Anti-Aliasing

- Use application settings: On
- Morphological filtering: Off

## SMOOTHVISION HD: Anisotropic Filtering

- Use Application Settings: On

## Tessellation

- AMD Optimized: Off
- Use application settings: On

## Mipmap Detail Level

- High Performance

## Wait for vertical refresh

- Always On
- Left-click Apply.

## Managing Displays

To enabling and configuring your displays open up the Windows Display settings by right-clicking the desktop and select screen resolutions.

For more precise advanced display configuration options open up the Catalyst Control Center:

1. Right-click on the desktop and select Catalyst Control Center.
2. Under Desktop Management, select Creating and Arranging Desktops, then select the ? icon.



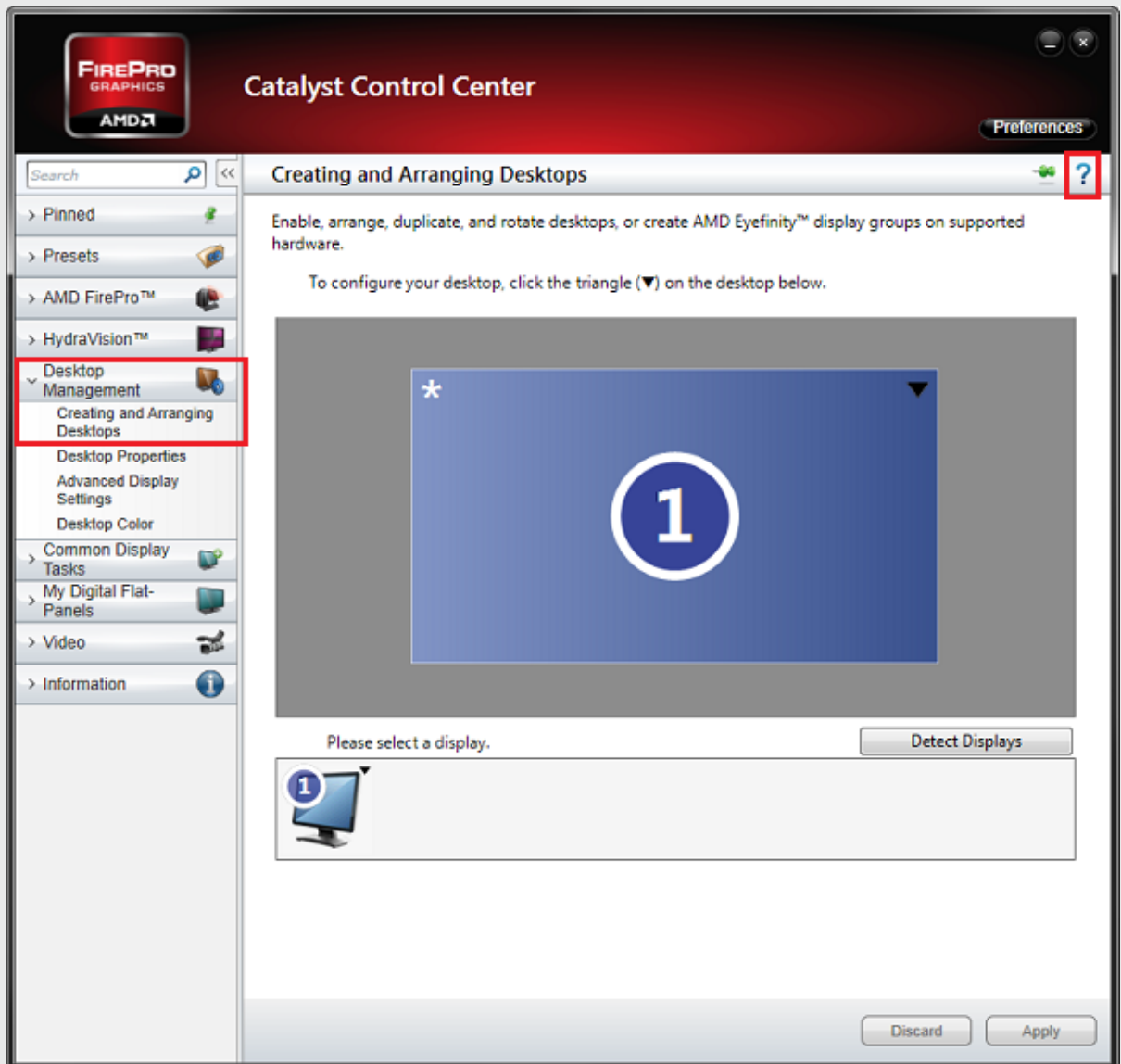

Select *Creating and Arranging Desktops* under *Desktop Management*, and then select the ? icon

This will open the Desktop and Display Management website where you can learn how to enable, arrange, duplicate and rotate desktops.

Also see [Getting the best display on your monitor.](#)

# 12HD Playback Configuration

## What is 12HD playback?

For R11, we've done a great deal of optimisation on every aspect of video playback performance, all the way from disk through GPU drivers and synchronisation. The prefetch estimation system already improves timing solidity; with a few tweaks of the BIOS to ensure the best possible SSD performance, d3 can now play twice as much video as it could before.

In order to get optimum performance and to be able to run up to 12 layers of HD content, the media drives in your machine need to be in the 2 drive bays that support the fast SATA3 data protocol.

## What systems are eligible for 12HD playback?

12HD is only available on 4u v2.5 systems that are running r11 software.

## Is 12HD playback already setup on my machine?

12HD is setup by default on all recently shipped v2.5 machines (post September 2012), however some older machines may have slightly different configurations set up.



Every d3 machine contains four bays, and are shipped with a single 512Gb OCZ Vertex 4 Solid State Drive ( SSD ) located in drive bay 1

On recent machines, out of the four drive bays there are two fast SATA3 drive bays ( bays 1 and 2 ) and two SATA2 drive bays ( bays 3 and 4 ).

To ensure optimal performance always populate bay 1 and 2 first. Your d3 machine ships with a single 512Gb OCZ Vertex 4 Solid State Drive ( SSD ). The SSD will be located in drive bay 1 and is capable of 461.9 MB/s sequential read and 462.9 MB/s sequential write.

Older 4U v2.5 machines may have a different configuration of fast SATA3 drive bays and SATA2 drive bays.

## Setting up 12HD playback

Before starting the process to setup 12HD please download and install [this Windows patch](#) from Microsoft. This patch will change the drive identity within the registry and prevent a BlueScreen error associated with a change of SATA mode change.

Once the patch is installed, ensure there is only one media drive in the machine and it is in drive bay 1 (top left). In our example below we have used an OCZ Vertex 4 drive.

Restart the machine and hold down the 'del' key to enter the BIOS.

You will be presented with the following screen.

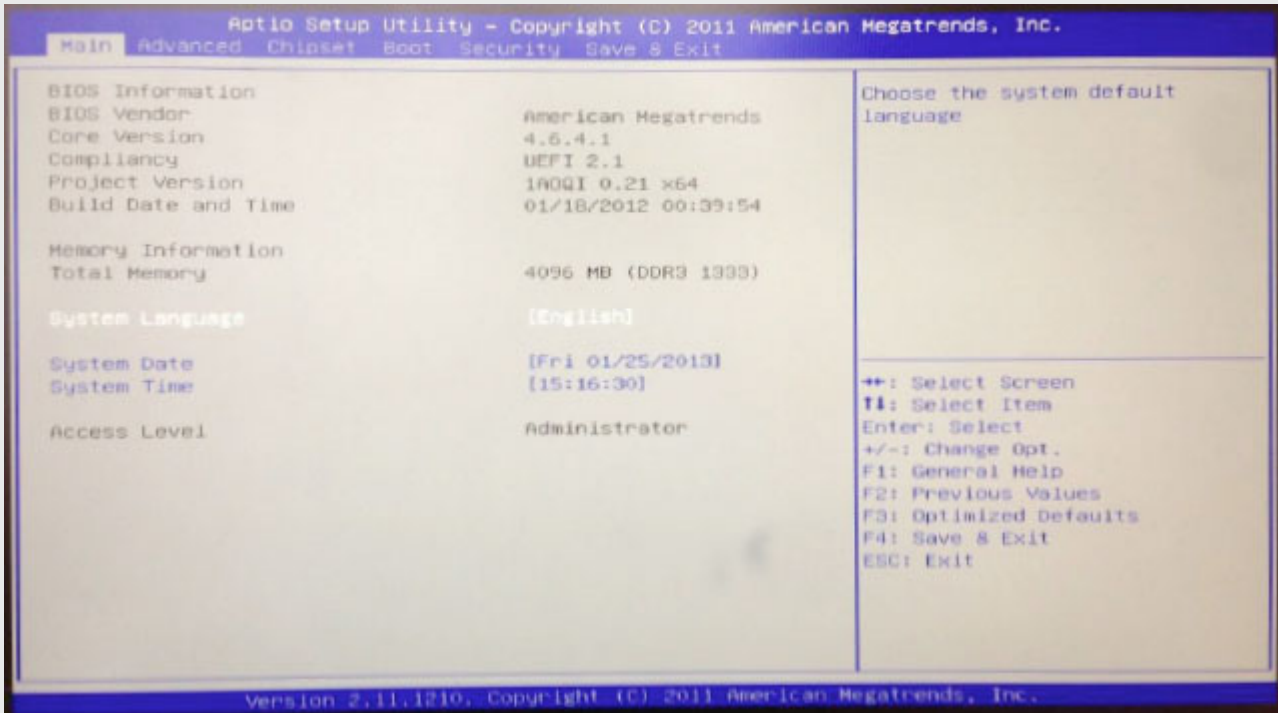

BIOS main screen

In the BIOS menu scroll right one tab to the 'Advanced' tab and scroll down to the SATA configuration menu item. Press Enter.

In SATA configuration open up the SATA menu item and select AHCI mode (unless this has already been selected.)

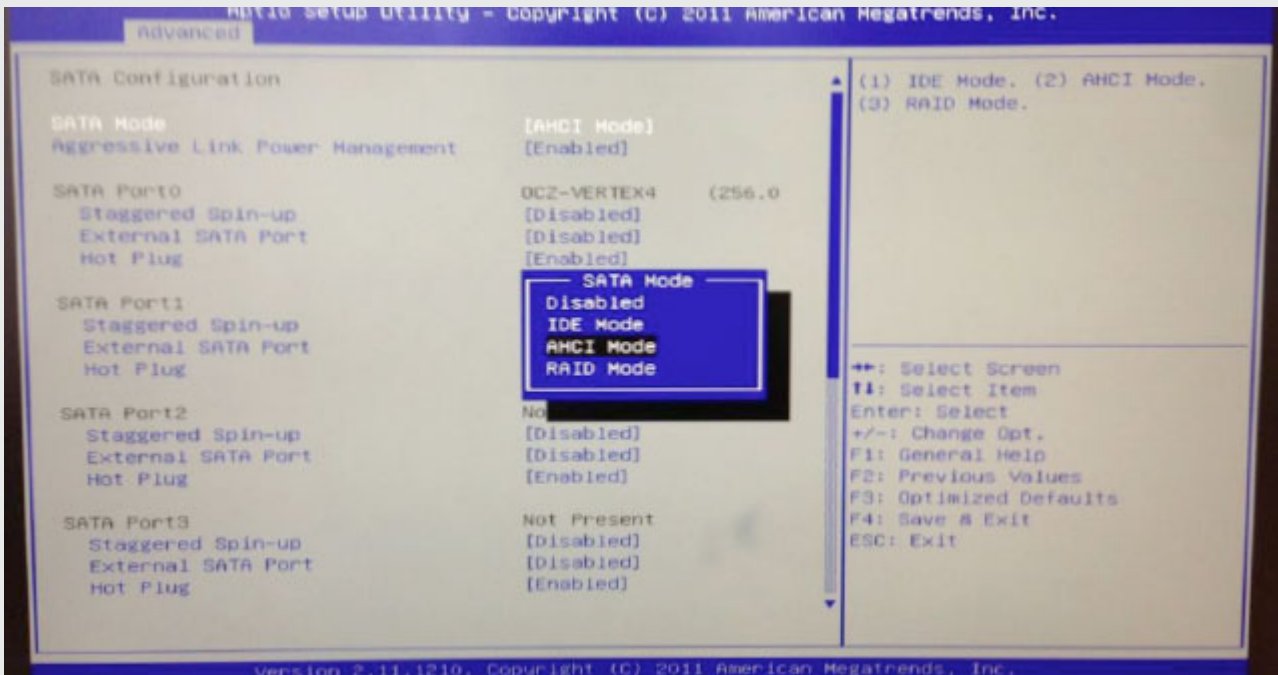

SATA mode menu

The screenshot below shows the OCZ Vertex 4 drive in SATA port 0. The fast SATA3 slots are set as SATA PORT0 and SATA PORT1 in the BIOS.

In this example our OCZ Vertex 4 drive would be running at full SATA3 speed and would run at 12HD performance.

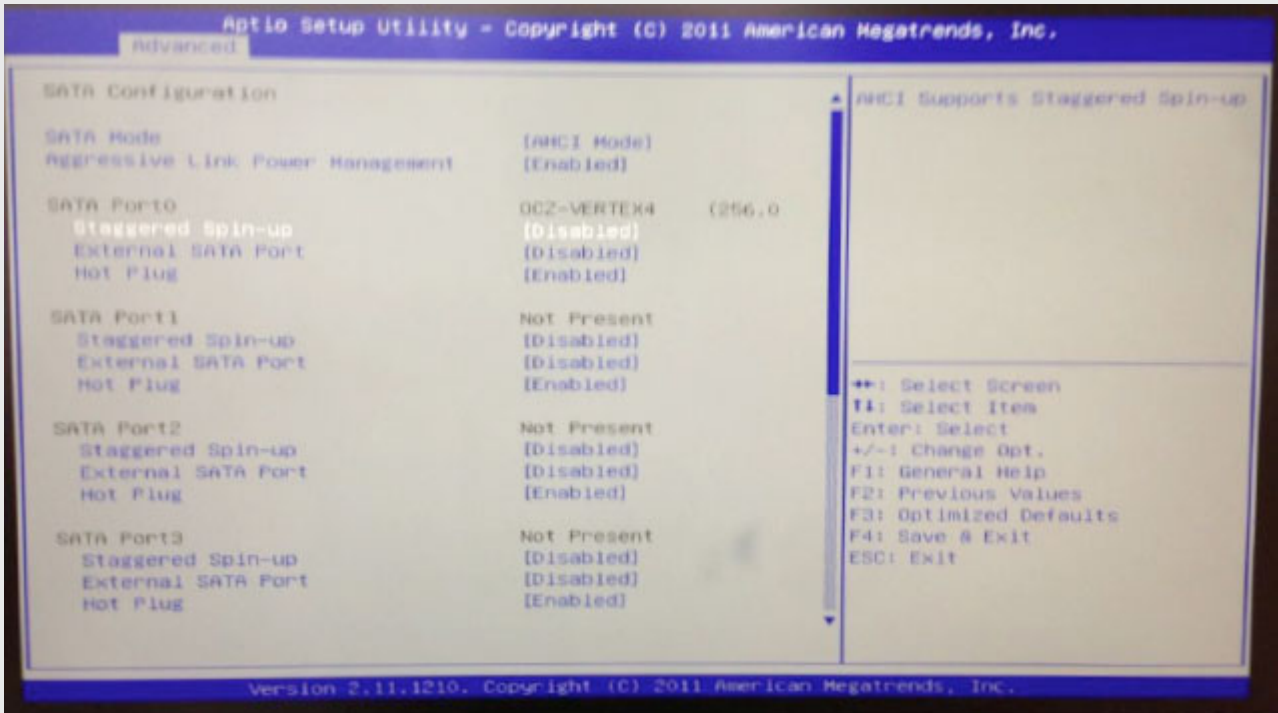

SATA Configuration screen showing a drive in Port 0.

The next step is to establish the location of the other fast SATA3 port. In order to do this, shut the computer down and move the SSD into another drive bay.

Then restart the machine holding the 'del' key to enter the BIOS and repeat the steps above to establish the drive bay that is connected to SATA PORT1.

It is important to shut down the machine before moving the drive between drive bays as this change will not be reflected in the BIOS and you may damage the drive.



**Warning:** Do not change any other BIOS settings or enable or disable any features as you may stop the d3 machine from working correctly or at all.

Once booted into Windows you can check the read/write speed of the drive by using a drive test utility such as [ATTO Bench](#).

A SATA3 drive should be running at between 450 - 500 MB/s

If you require any support or advice regarding 12HD please [contact support](#)

# Viruses and malware

Viruses and other malware are potential problems that should be considered when using any software.

However, most anti-virus software is very intrusive and reduces performance as it actively scans the system in the background. When using disguise hardware for a show, you want as few background applications running as possible to maximize the performance. Therefore, we do not install anti-virus software by default on any 4U or 2U system.

## Recommended virus scanner

For information on the virus scanner we recommend which does not reduce performance please see the software sub-chapter [Viruses and malware](#).

# Audio cards

## What audio card does my machine have?

All of the 4U machines use a RME HDSP 9632 Hammerfall DSP pro audio card, which uses the latest 182 kHz AD- and DA- converters.

## Which connections does the RME card have?

The RME card has four connections:

- Analog In/Out [Via Analogue Breakout Cable supplied]
- Digital In/Out [Via Digital Breakout Cable not included]
- ADAT Out [8 Channels via optical cable not included]
- ADAT In [8 Channels via optical cable not included]

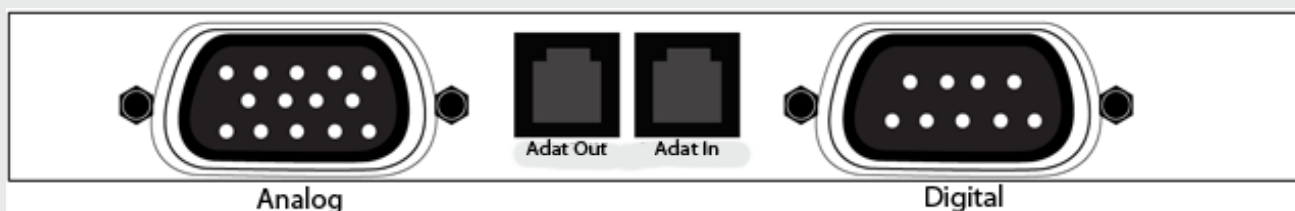

*RME card connections*

To connect the RME card to external devices, we recommend using the supplied analogue breakout cable.

## RME card settings

1. Go to the Windows Start menu
2. Type **Sound** in the search bar and then select **Sound** under the Control Panel category.
3. Right-click the device named Speakers RME HDSP 9632 and select **Set as Default Device** if it is

not already selected.

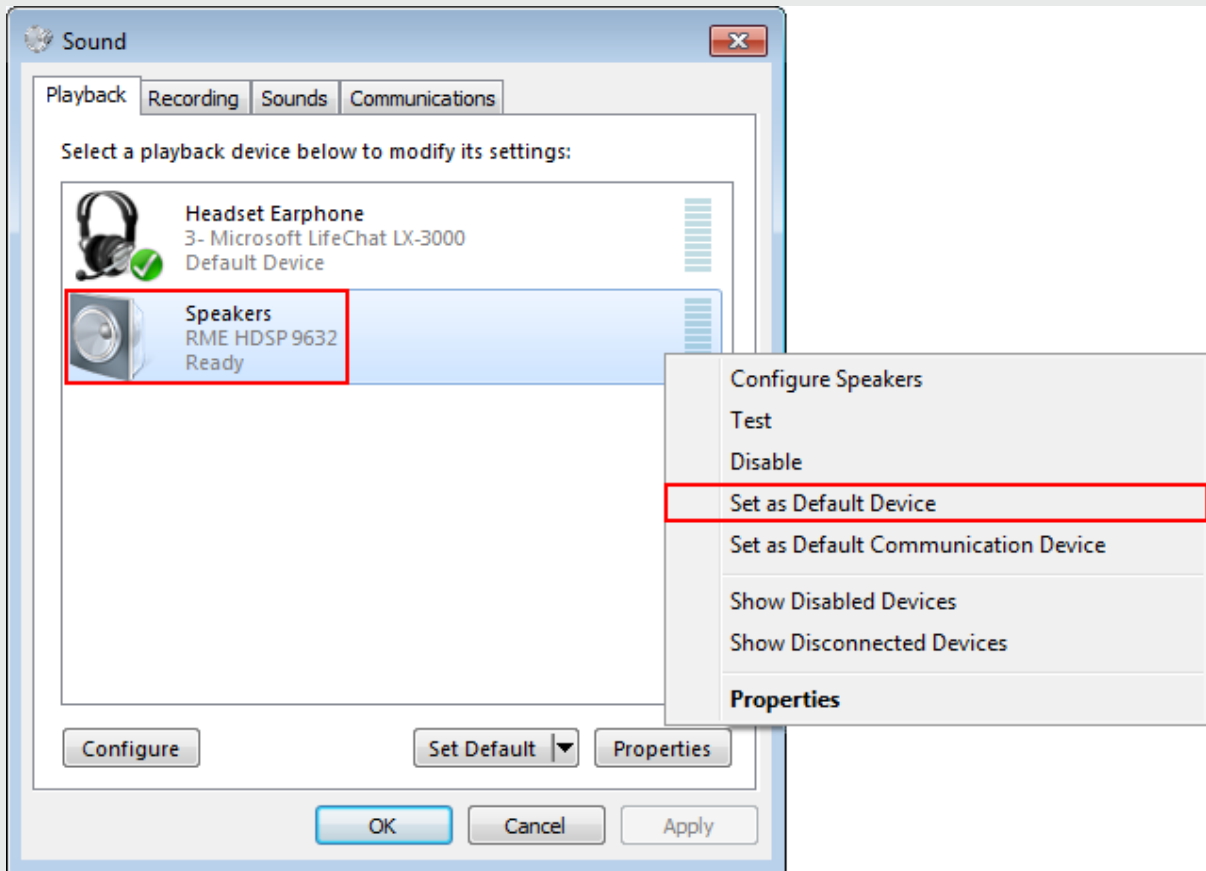

Sound settings for a 4U d3 system, set the RME HDSP 9632 device as the default device

All audio should now be going through the balanced line out from the audio card.

For information on how to use advanced audio card features, including the HDSP mixer application, please consult the manual found [here](#).

Available ports directly on the card are:

- 1x Optical [ADAT](#) / [SPDIF](#) in ( [TOSLink](#) )
- 1x Optical [ADAT](#) / [SPDIF](#) out ( [TOSLink](#) )

## Default HDSP Settings

You can find all the default settings for the HDSP Mixer application [here](#).

To apply this settings file:



1. Right-click the Hammerfall DSP Mixer icon in the taskbar and select Mixer...

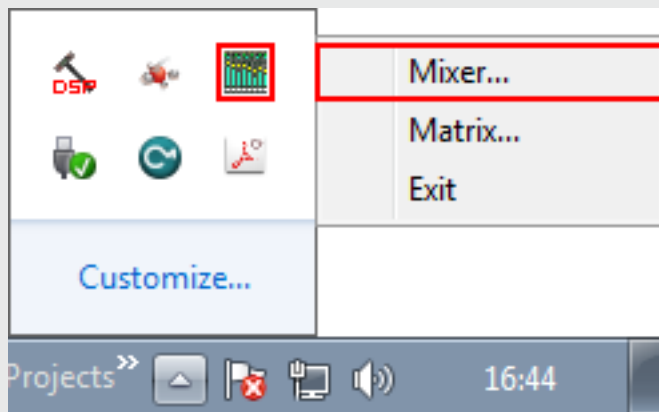

2. Open the HDSP Mixer application by right-clicking the Hammerfall DSP Mixer icon in the task-bar (bottom right-hand corner of your screen) and selecting Matrix
3. Select File > Open and choose the settings file. All settings should now be restored to their original values.

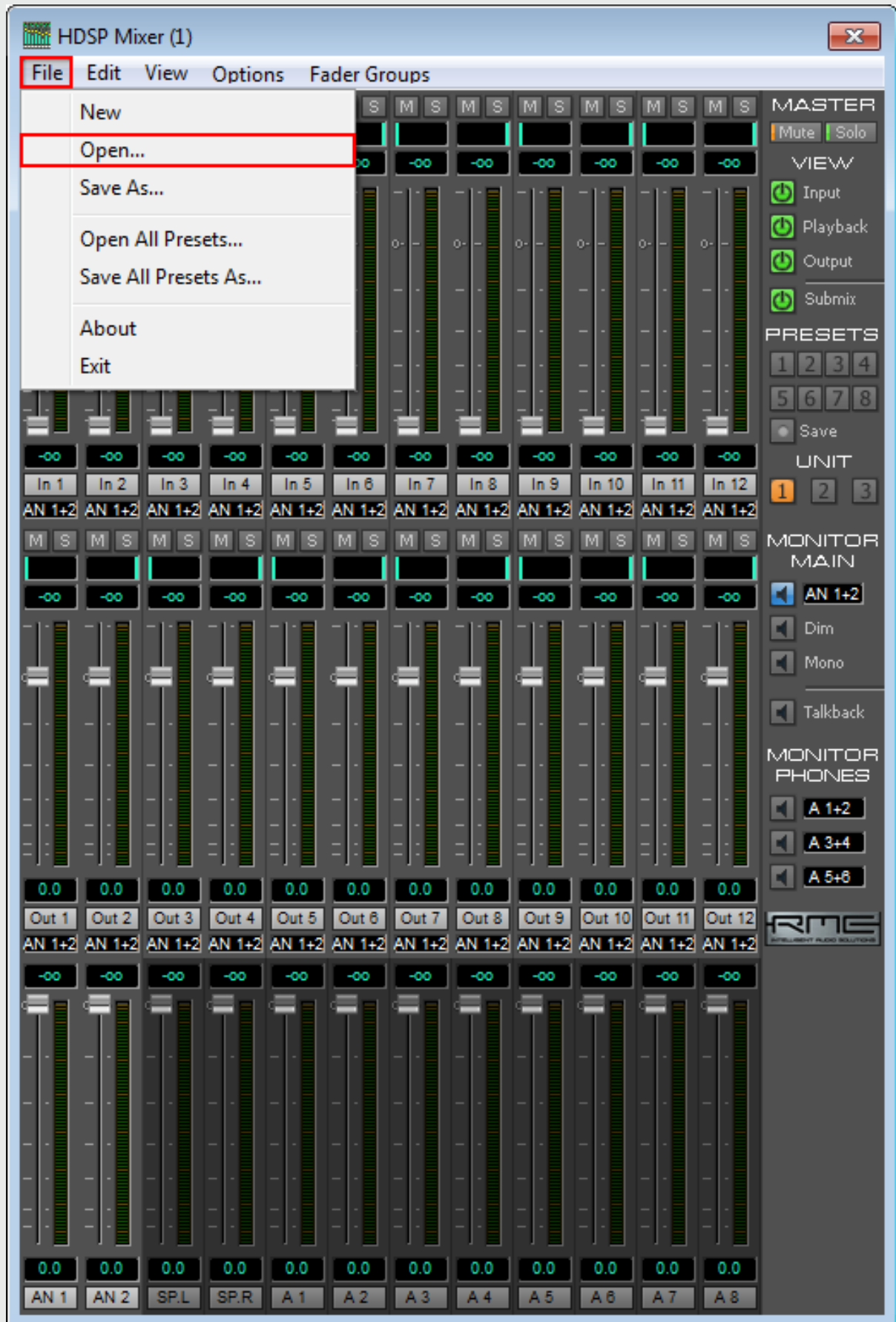

4. Select File > Open from the HDSP Mixer window and then select the Settings file to restore the HDSP Mixer default settings

You will lose all of the previous settings.

# Audio breakout

## Why do I need a breakout cable?

For flexibility each d3 system comes with an **analog breakout cable** which lets you choose which input/output to use.

## What connections does the breakout cable have?

The breakout cable provided with each d3 system is the:

HDSP 9632/HDSPe AIO: Analog breakout cable, balanced (P/N BO9632XLRMKH)

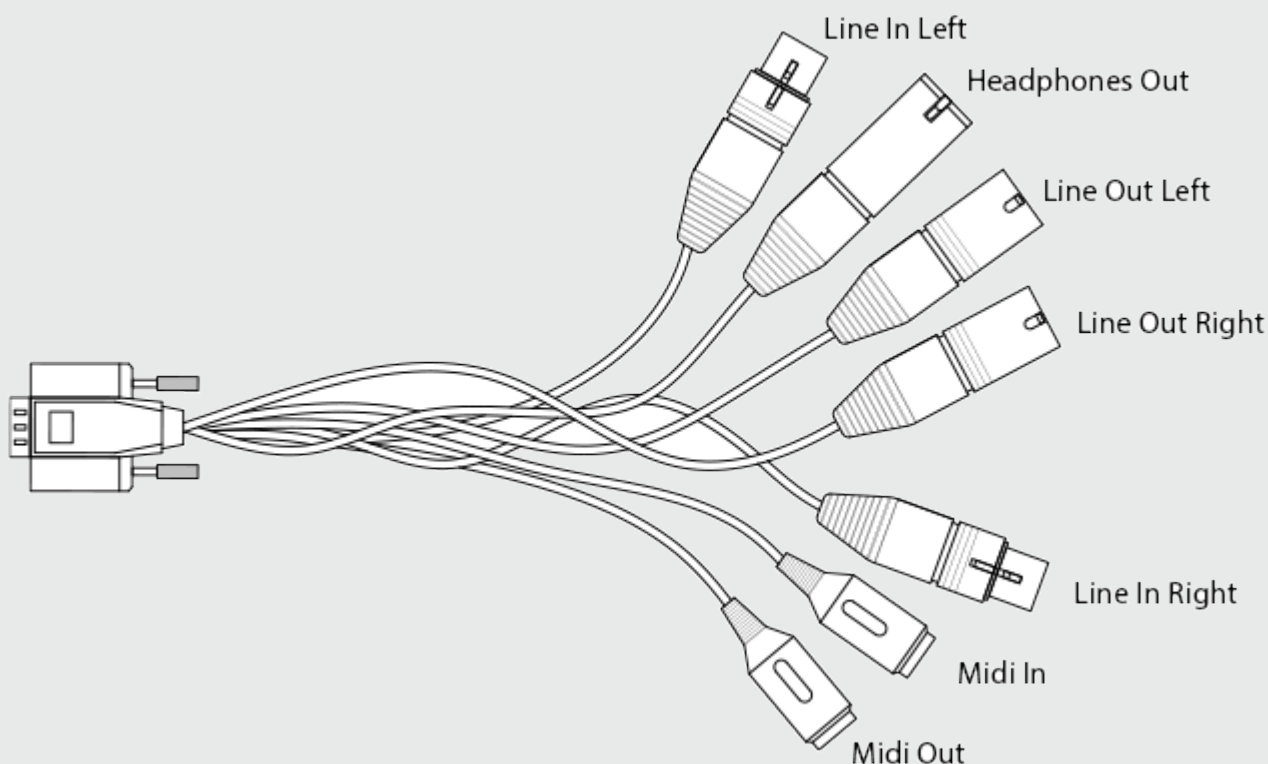

Each d3 system is supplied with a breakout cable for the RME HDSP 9632 audio card.

This breakout cable is supplied for the RME HDSP 9632 audio card and provides the following inputs and outputs:

- 1 x Midi in ( 5 pin [DIN](#) )
- 1 x Midi out ( 5 pin [DIN](#) )
- 1 x Balanced stereo line out ( [TRS](#) )
- 2 x Balanced line out ( [XLR](#) )
- 2 x Balanced line in ( [XLR](#) )

## Are different breakout cables available?

There are several variations of the audio breakout cables available.

Please refer to the [RME website](#) for more information.

## 2x2plus overview



**Warning: do not open or remove the case unless you are instructed to do so by a certified Disguise Engineer**

The machines come pre-installed with the latest software version, enabling you to design, configure and sequence the show on the same machines as you later use for show playback.

For detailed information on the specifications for each machine, as well as the other software and hardware bundles offered by Disguise, please see the products section of our [web site](#).

## 2x2plus machine

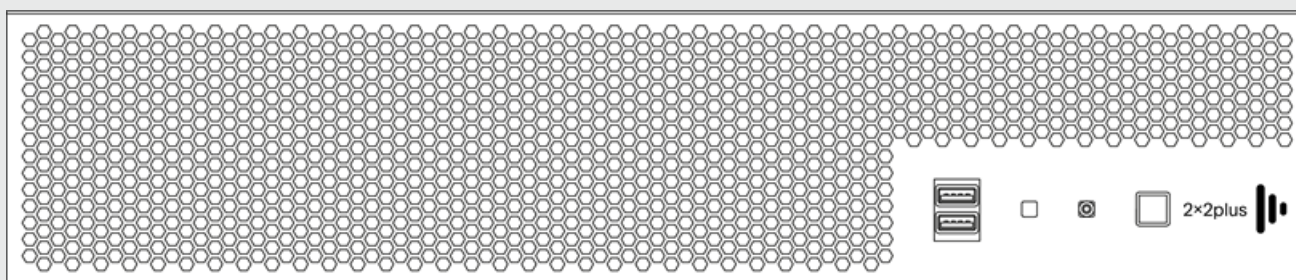

Front view of 2x2plus

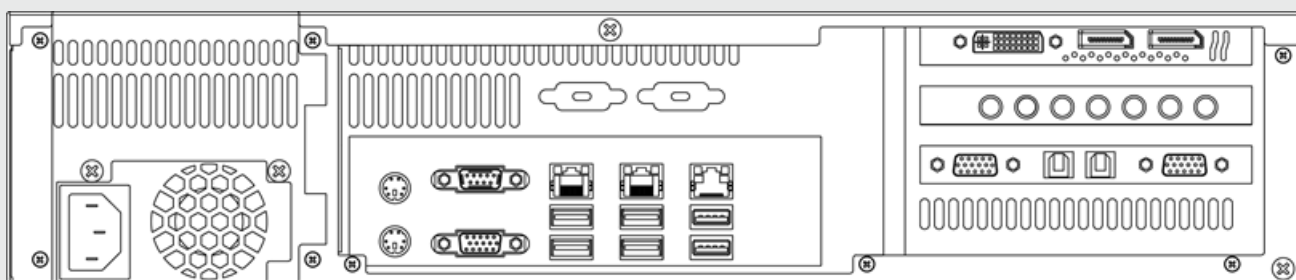

Rear view of 2x2plus

**Please note:** If you experience any problems with hardware please contact the [support team](#)

# Plus range diagrams

## 2x2plus Base unit

The base unit has no video capture card and comes with the on-board audio card (Pro-audio is also available).

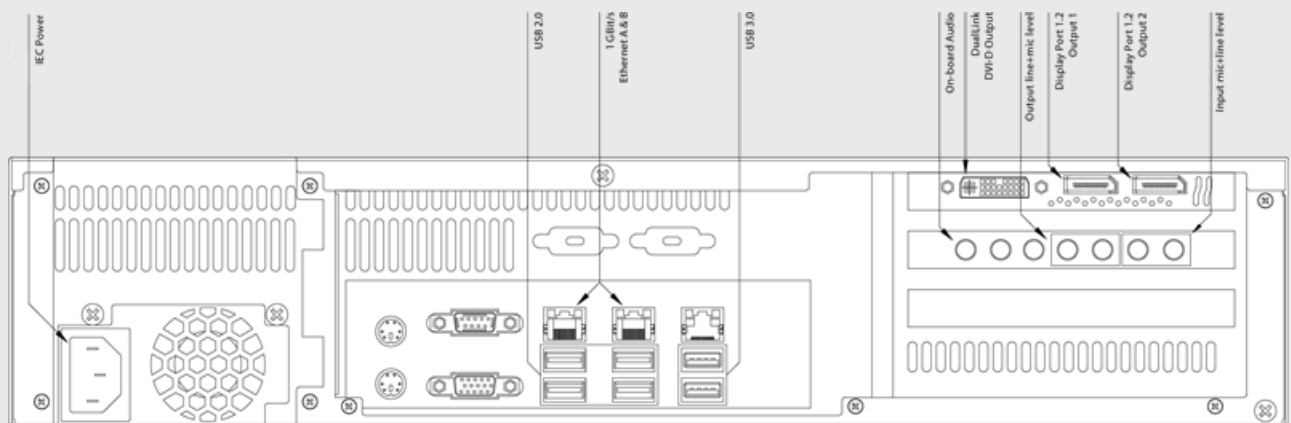

Base unit 2x2plus rear panel diagram

## 2x2plus Configuration A

1x DVI video capture card and shown with Pro-audio card (on-board audio is also available).

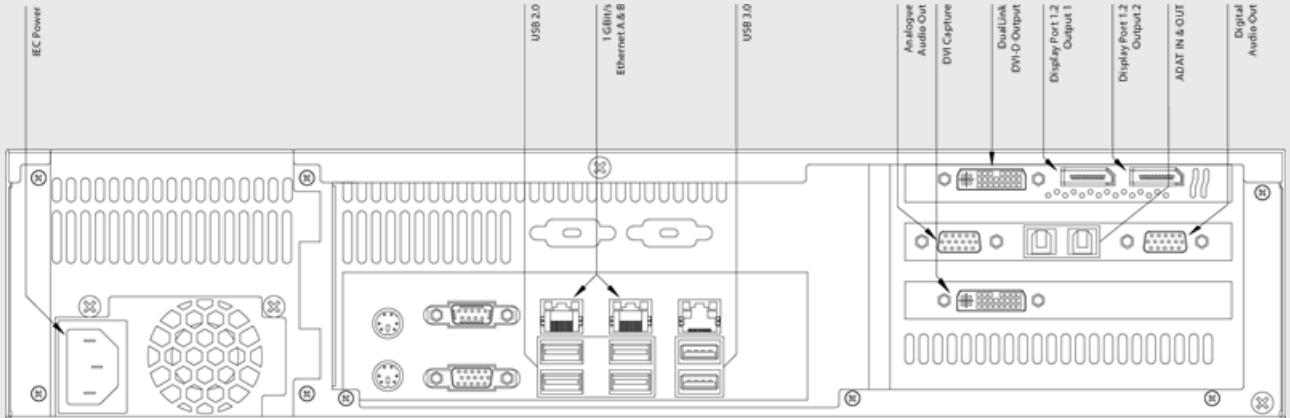

## 2x2plus Configuration B

2 x 3G-SDI video capture card and shown with Pro-audio card (on-board audio is also available).

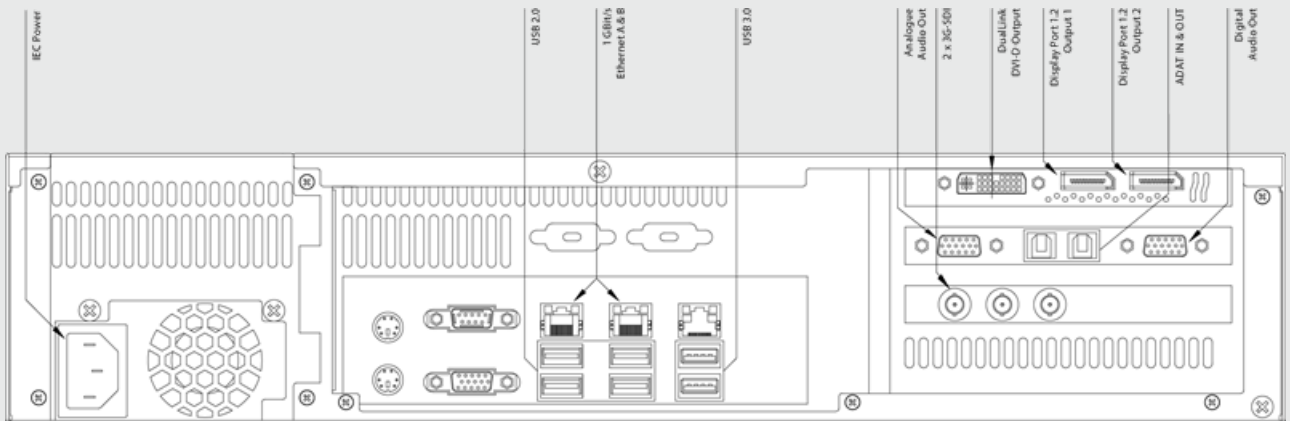



# Powering the system

1. Make sure you have connected a keyboard, mouse and monitor to the primary graphics output.
2. Press the power button on the front of the unit and wait for the system to load into Windows.

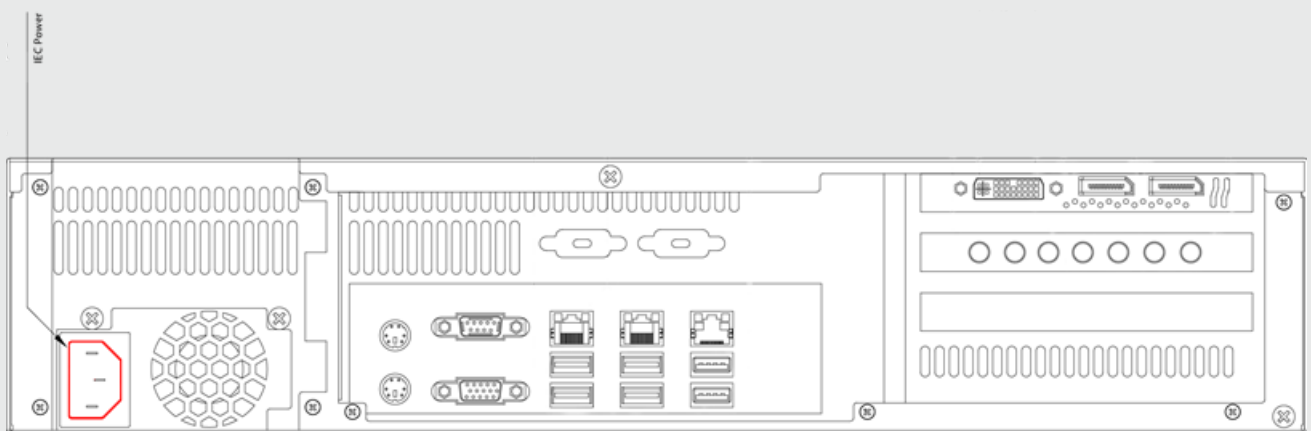

Location of power input on rear of the plus range unit

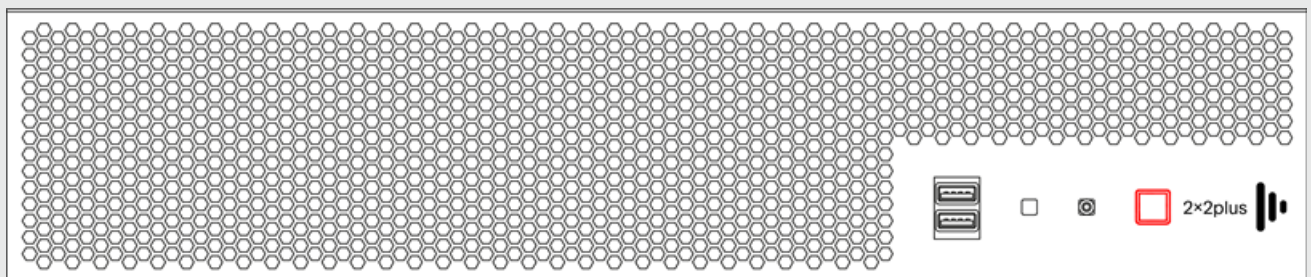

Location of power switch on front of unit

# Filter replacement

You should regularly inspect the air filter on the front of the unit to prevent loss of cooling efficiency.

To access the filter, remove the 3 top fascia screws and the bottom 3 fascia screws. Then simply pull the entire fascia off to get access to the filter.

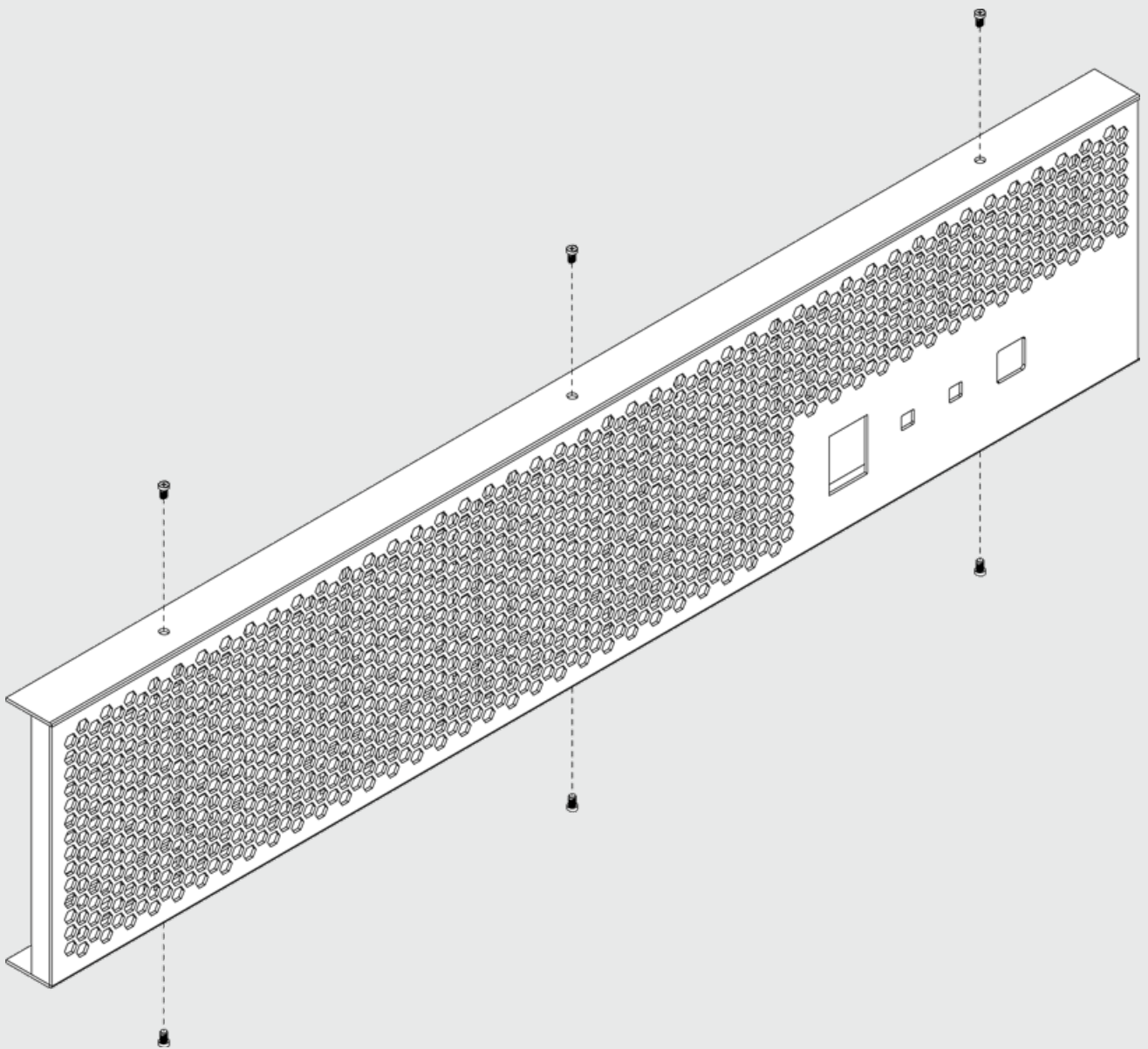

*Air filter housing front*

**Please note:** It is recommended that you service the air filter when the unit is powered off. If the unit is on you will be exposed to the system fans

To remove the perforated metal grid keeping the filter in place, please pull from the middle out.

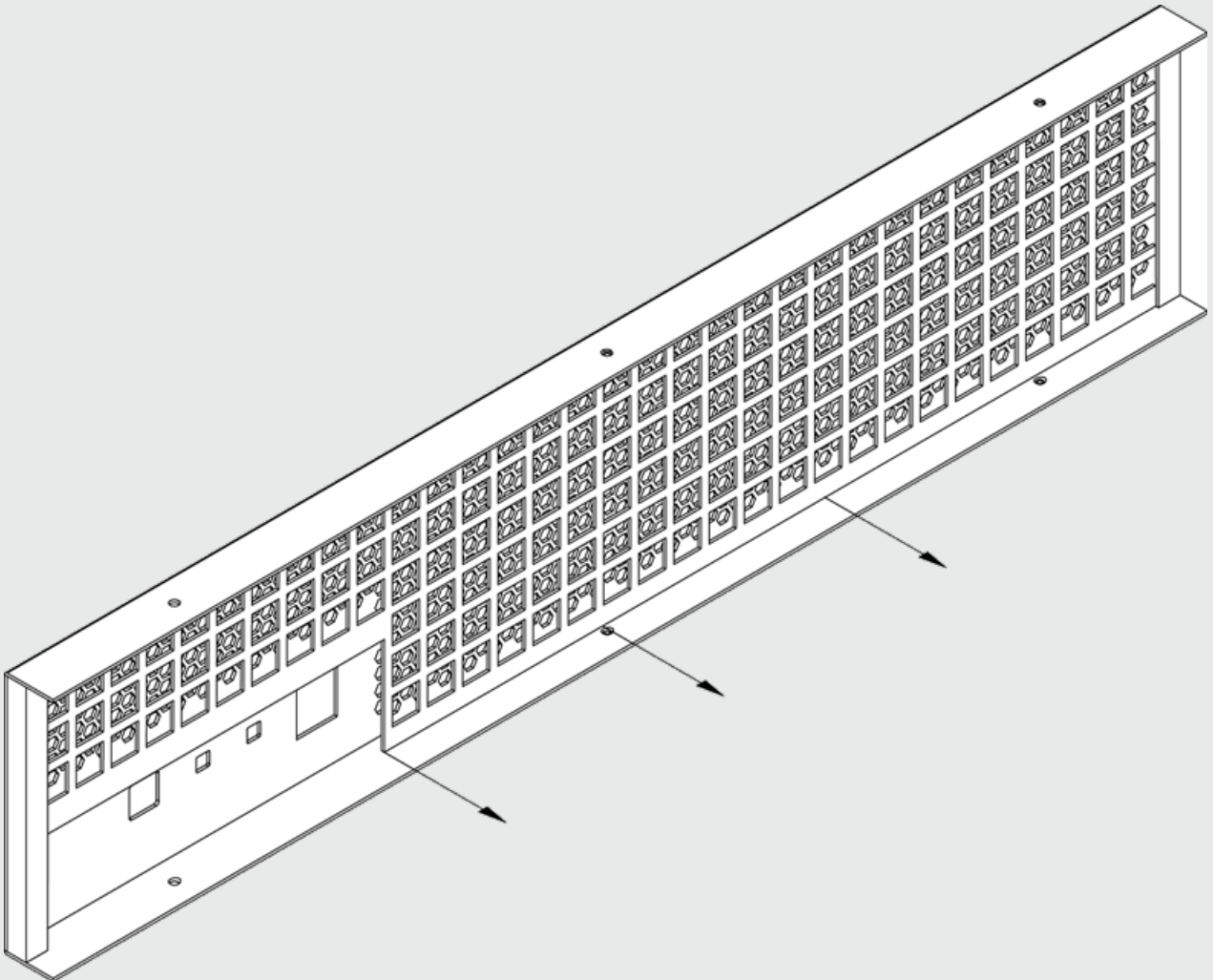

*Air filter housing rear*

Give the filter a clean, replace the filter in the metal frame and reattach the facia to the front of the unit.

# Card Configuration

The Disguise 2x2plus comes in a variety of optional factory fitted configurations. Your machine configuration can only be changed by sending it back to Disguise to be upgraded. The following configurations are available:

- No capture, a choice of on-board audio or Pro audio
- 1 x DVI capture, a choice of on-board audio or Pro audio,
- 2 x 3G-SDI, a choice of on-board or Pro audio

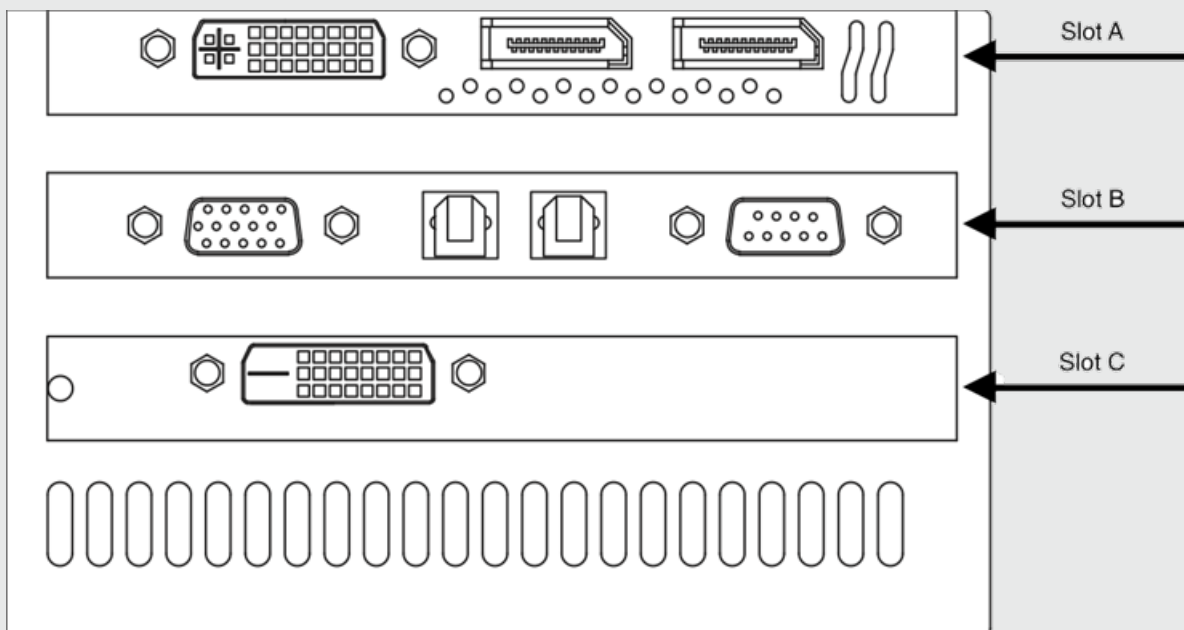

*Rear view card configuration*

# Slot A

Slot A is video output and is non-configurable. The 2x2plus has 1 control / GUI output and 2 dedicated DisplayPort stage outputs.



## Video output card

1. DVI
2. DisplayPort

The control / GUI output is situated on the DVI connector ONLY, enabling you to configure the system, operate Windows and program the software environment. This output CANNOT be used for output to the stage.

Supported resolutions on the DisplayPort outputs and DVI output are up to 2560x1600 @60hz. (When using the correct DisplayPort to DVI adapter).

# Slot B

Slot B is by default On-Board Audio but can be configured to be Pro Audio I/O.

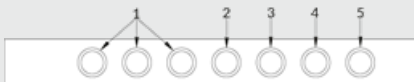

## On-board audio card

1. Not in use
2. Output line level

3. Output mic level
4. Input mic level
5. Input line level

## Pro audio



## Pro audio card

1. Analog audio
2. ADAT in
3. ADAT out
4. Digital audio

## Slot C

Slot C has three options: no capture, DVI capture, or 3G-SDI capture. Capture options are factory fitted.

## DVI capture



## DVI capture card

1. DVI

Supported resolutions are up to 1920x1200 @60hz.

# 3G-SDI capture

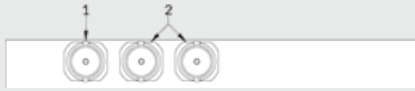

## 3G-SDI capture card

1. Not in use
2. 3G-SDI

Supported resolutions are up to 1920x1080 @60hz.

# DVI Capture



## Technical limitations



**Warning:** Maximum Supported resolution: Resolutions up to 1920x1200 @60hz



**Warning:** Colour Sampling Supported: RGB 8-8-8, YUV 4-2-2

## Configuring presented EDID to source device



1. Open the **Configure Vision** application and click the **Configure** button

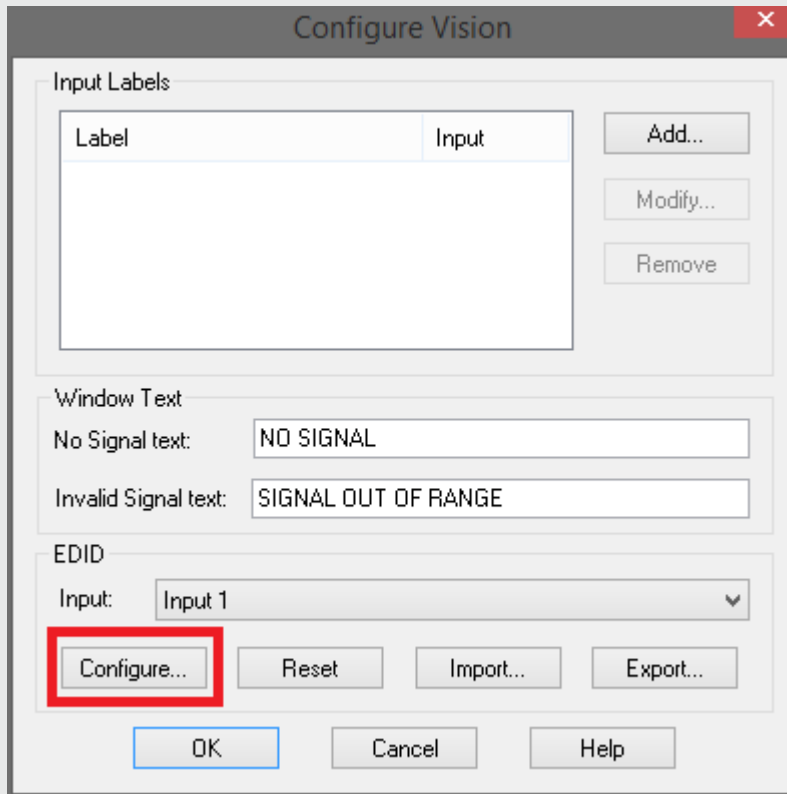

2. Create an EDID to present to the source device, for example a laptop

**Configure Input 1**

Additional Timing Additional Timing

**Timings**

Timing Standard: GTF

**Display Mode**

Horizontal Pixels: 1920 Vertical Lines: 1080

Vertical Refresh (Hz): 60.000 Scan Type: Progressive

Pixel Clock (MHz): 172.798 Format: DVI

**Detailed Timings**

Display as: Video Definition

Horizontal Timings		Vertical Timings	
Sync Width	208	Sync Width	3
Back Porch	328	Back Porch	34
Front Porch	120	Front Porch	1
Polarity	Negative	Polarity	Positive
Total Pixels	2576	Total Lines	1118
Actual Refresh	67.080 KHz	Actual Refresh	60.000 Hz

OK Cancel

# Preview DVI Input outside Disguise software

1. Please open the Vision Window application to show DVI capture outside the software



# Optional SDI Video Capture



## 3G-SDI capture card

1. Not in use
2. 3G-SDI

Supported resolutions are up to 1920x1080 @60hz.

## LED Indicators

LED	Explanation
Magenta, pulse, fast:	3G Level 'B' SDI input.
Magenta, pulse, slow:	3G Level 'A' SDI input.
Blue, pulse, slow:	1.5G SDI input.
Yellow, pulse, slow:	270Mb/s SDI input.
Amber, pulse, slow:	270Mb/s ASI input.
Off:	No valid input signal detected.

## Maximum number of unique inputs

SD-SDI	1.5G SDI	3G-SDI
2	2	2



**Warning:** 4K video capture over 2 x 3G-SDI is not currently supported

## Supported formats

Resolution	Format	Hz
720x486	interlaced	59.94
720x576	interlaced	50.00

Resolution	Format	Hz
1280x720	progressive	23.976, 24, 25, 29.97, 30, 50, 59.94, 60
1920x1080	interlaced	47.96, 48, 50, 59.94, 60
1920x1080	PsF	23.976, 24, 25, 29.97, 30
1920x1080	progressive	23.976, 24, 25, 29.97, 30, 47.96, 48, 50, 59.94, 60
2048X1080	progressive	23.976, 24, 25, 29.97, 30, 47.96, 48, 50, 59.94, 60
2048X1080	interlaced	47.96, 48, 50, 59.94, 60
2048x1556	PsF	14.98, 15, 18.98, 19

**Please note:** The max single input datarate 3G/1080p60hz

# Onboard Audio

The onboard audio card has two channels of audio input and two channels of audio output.

These connections are made over mini-jack (3.5 mm) connections. There are 2 points of connection both for input and output.

One set is for line level audio and one set is for mic level audio

**Please note:** Audio does not appear as a configurable device unless a mini-jack is connected on the back of the system

# Pro Audio

## Digital breakout cable

This digital breakout cable provides the following inputs and outputs:

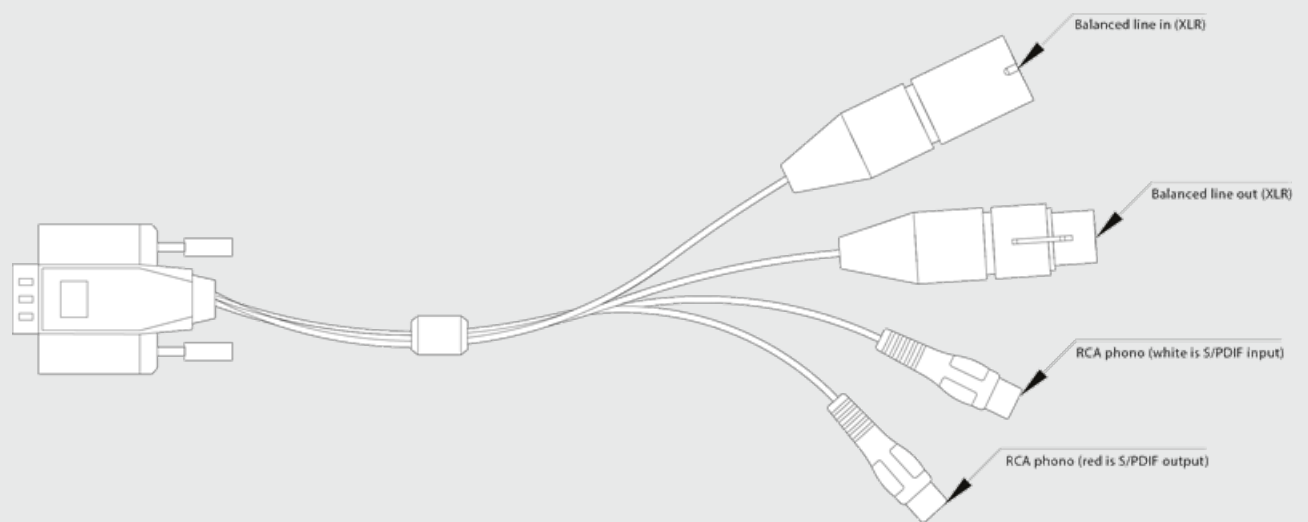

## Analog breakout cables

The Pro audio option comes with analog breakout cables which lets you choose which input/output to use.

# HDSPe AIO: Analog breakout cable, balanced

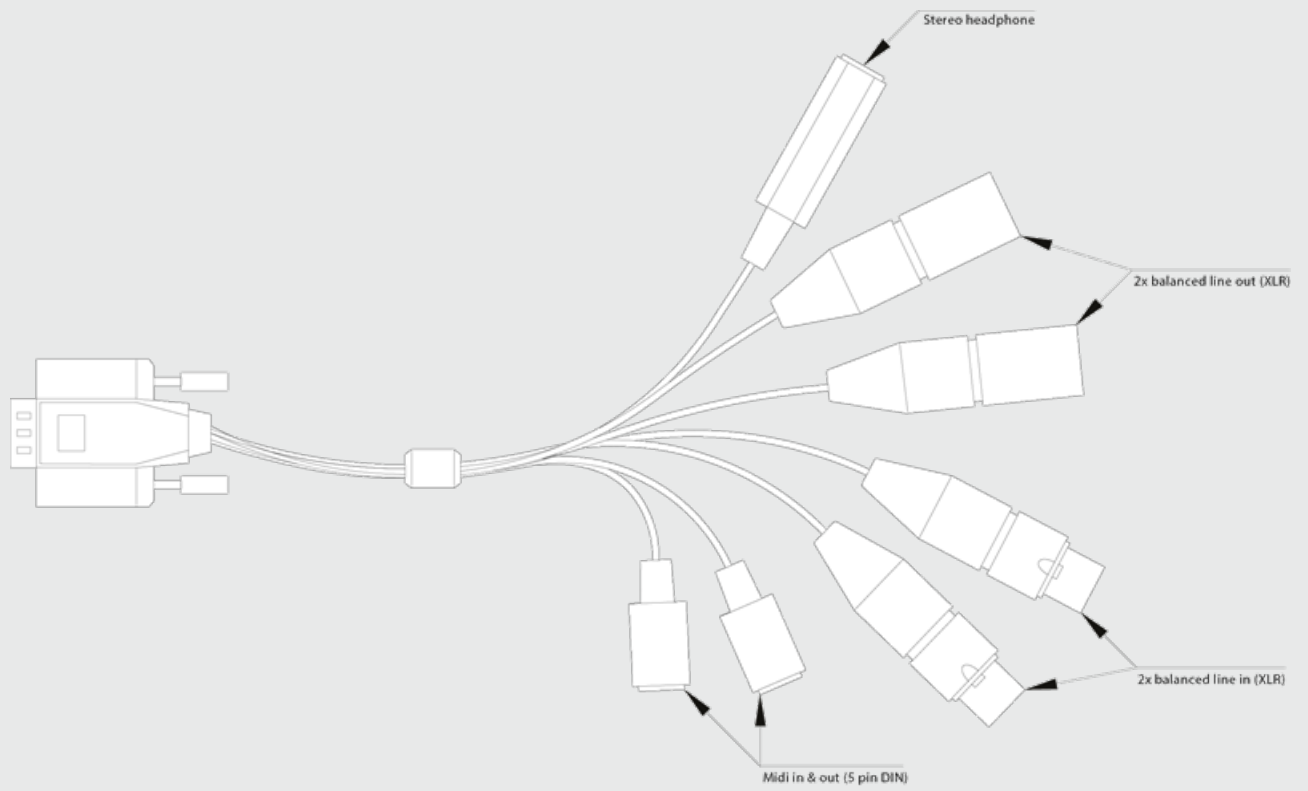



## HDSPe AIO: Analog breakout cable, un-balanced

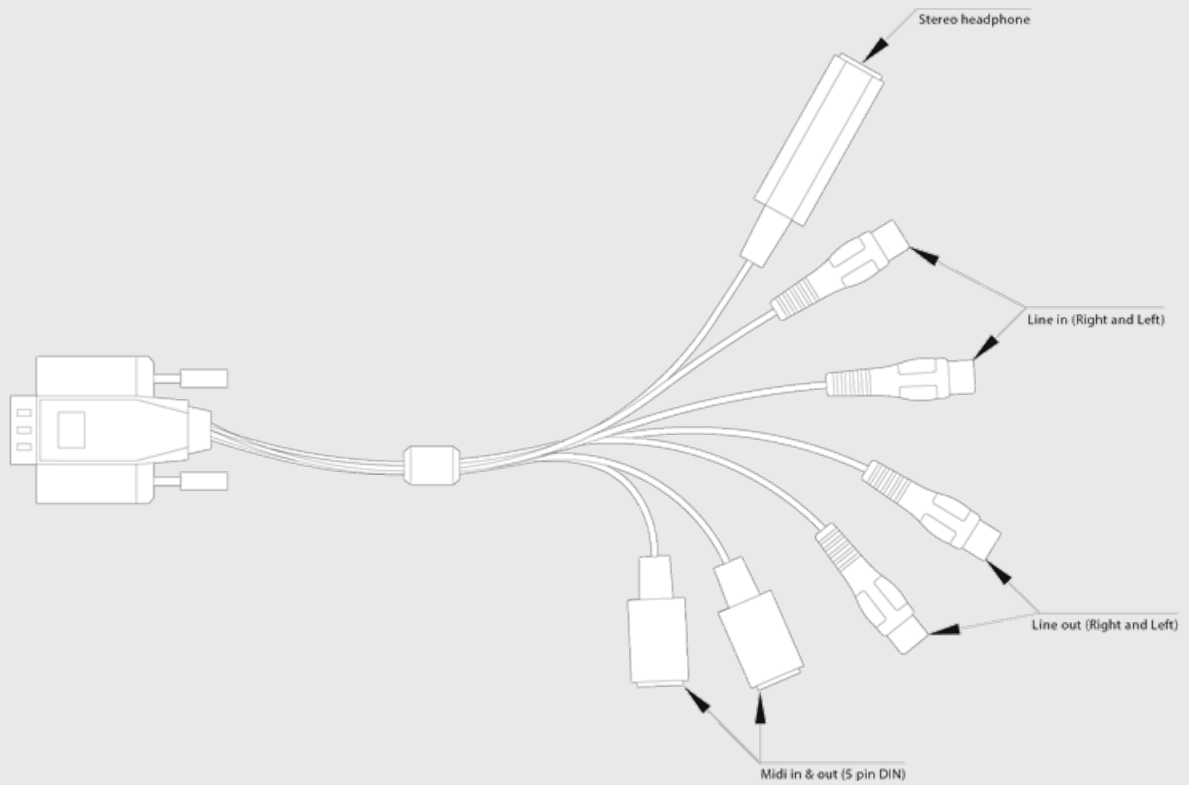

## Are different breakout cables available?

There are several variations of the audio breakout cables available.

Please refer to the [RME website](#) for more information.

# Resetting Pro-audio mixer to default settings

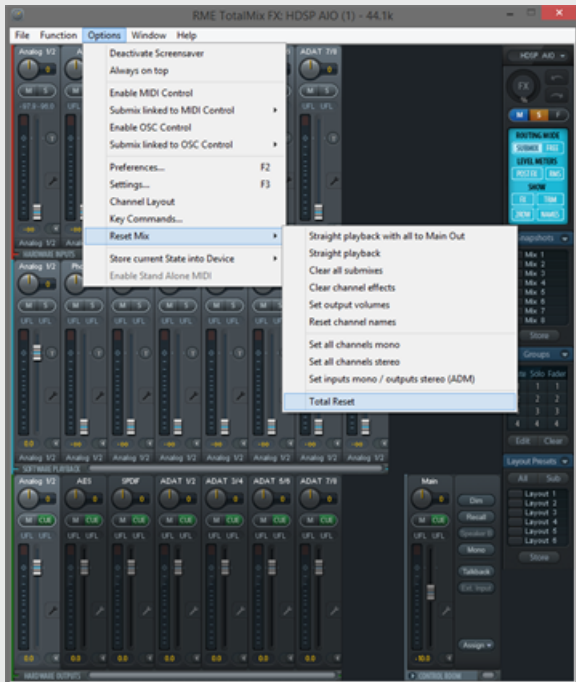

Please see the [audio output patch](#) topic for more information on how to configure your output channels

# Update & restore

Update & restore is the process of doing an update or restore on the system using a bootable USB drive. This process does not affect the media drive.

Please note: If you experience any problems during updating or restoring the system, or any of these instructions are unclear, please contact the [support team](#).



**Warning:** The system needs to be connected to the internet during this procedure

This process can be used to update to a newer OS image, or revert to a previous OS image.

To tell what OS image your system is on please go to the help menu in [d3manager](#) and select **About d3manager**.

## You will need

- A 32Gb USB memory stick
- A version of [Rufus](#) to turn it into a bootable disk. Make sure the volume name of the usb is: "REDISGUISE" as per image
- An internet connection to the machine you are re-imaging
- Download and install a version of [7Zip](#)
- Download and unzip the multi file archive using 7Zip

- OS images can be found [here](#).

**Please note:** You do not need to extract all parts individually. Simply place them in the same directory and then use 7zip to extract the ISO by selecting any part. 7zip will automatically unzip all parts to create the image file.

## Create Bootable USB device

1. Download and unzip the multi file archive using 7Zip (NOTE: you will only need to unzip file 001):

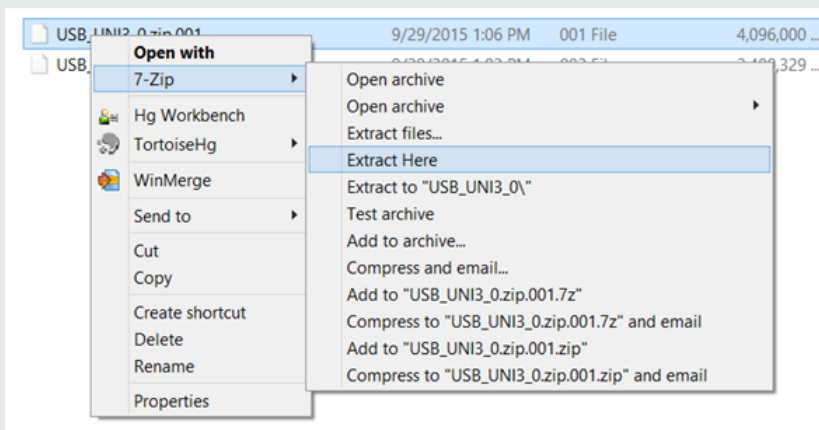

2. Create Bootable USB stick with the unzipped ISO.

The settings should be:

- **Partition scheme** - MBR
- **Target system** - BIOS (or UEFI-CSM)
- **Volume label** - automatically pulled from the ISO file

— **File system** - NTFS

— **Advanced drive properties** - Tick **Use Rufus MBR with BIOS ID** (this will prevent reboot loop by presenting a "Press any key to boot from USB" prompt).



**Warning:** These settings are critically important. The re-image process will fail if they are not set correctly.

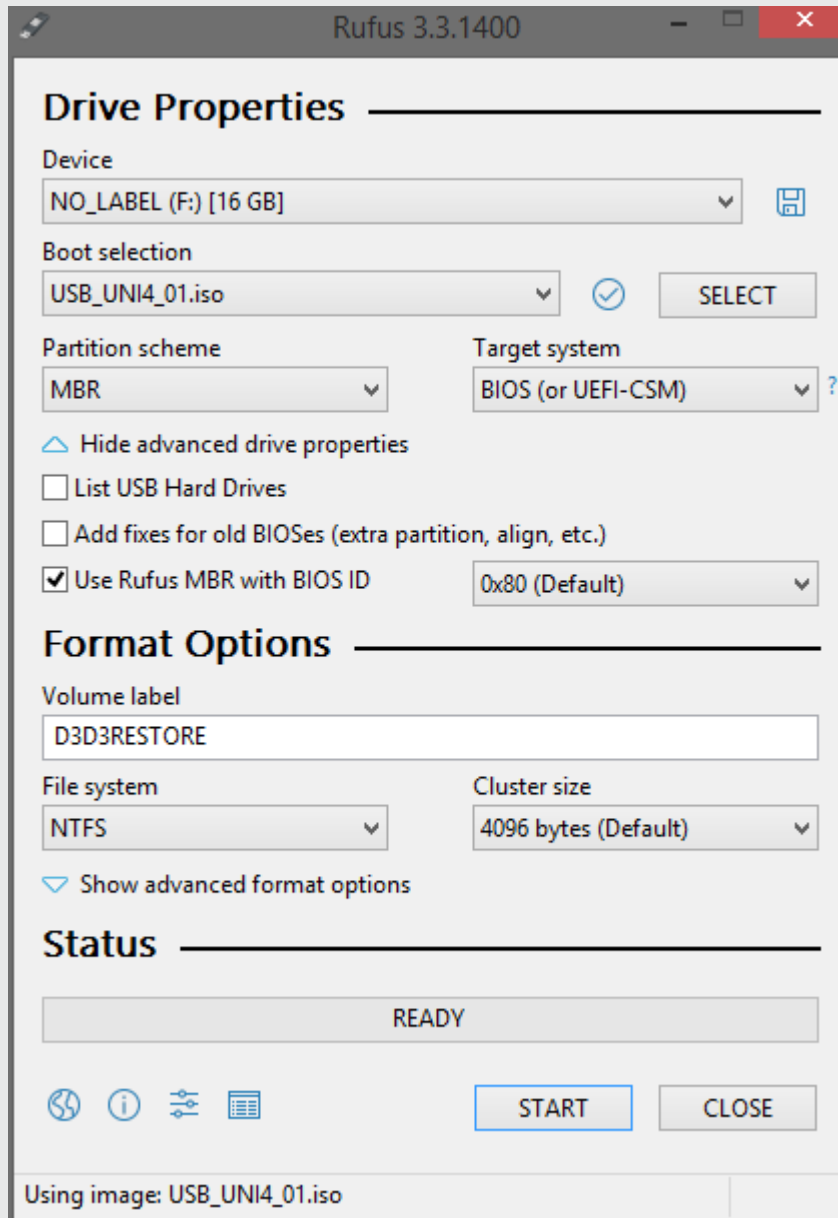

**Please note:** On the latest versions of Rufus you may see this warning. This is expected and does not apply to current disguise hardware. Please click **OK** to continue as normal.



## Booting into the USB

1. Insert the USB key and a keyboard into the system. (USB 3.0 will be the fastest)
2. Invoke the BIOS whilst the system is posting by continuously pressing the **DEL** key
3. Navigate to the **BOOT** tab and select **Hard Drive BBS Priorities**

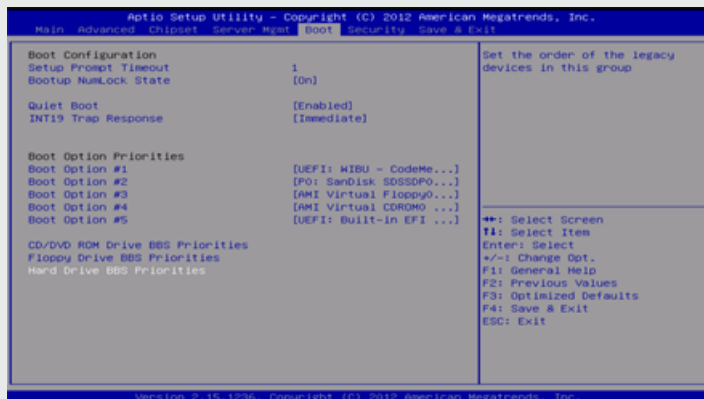

4. Select Boot Option #1. Select your USB key from the menu. Normally it is listed as the name of the Vendor of the USB key (**SanDisk**)
5. Select Boot Option #2. Please ensure this is listed as the OS drive (**INTEL SSDSC2BB080G4**)

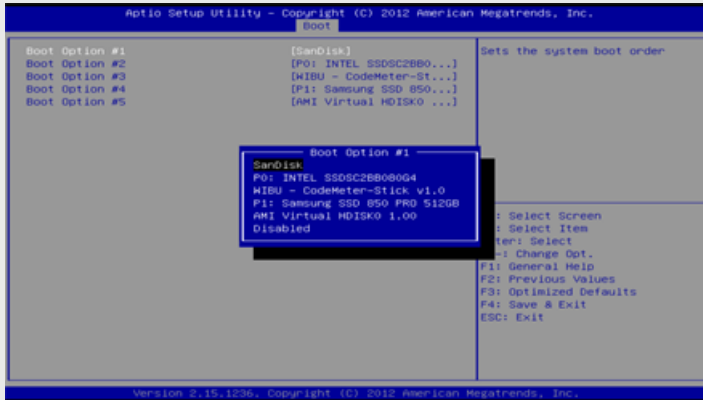

6. Please press **F4** to **Save configuration and exit**. This should reset the computer and prompt you with a **Press any key to boot from USB** window.

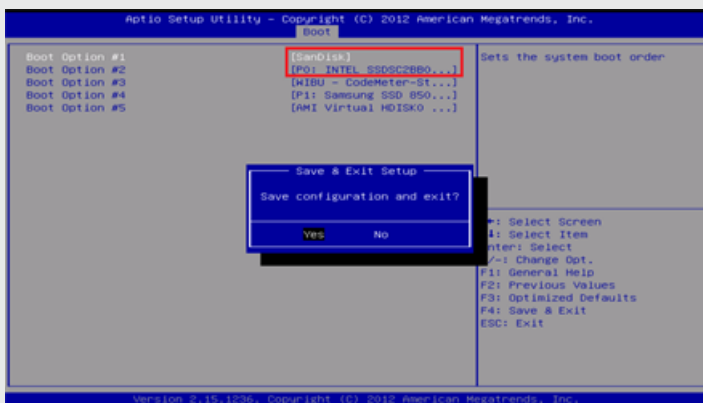

7. Press **enter** when the "**Press any key to boot from USB**" window appears and you should be booting into the USB



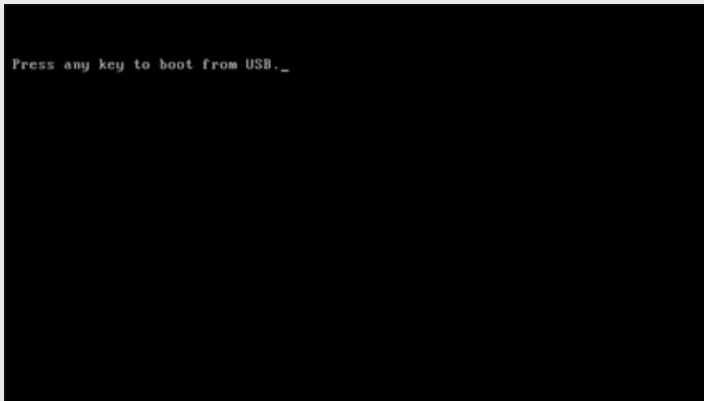

8. After this you will need to press **Enter** once to boot into the usb and the re-imaging process will commence - it should take around 20 minutes or so to complete and two system restarts will be part of the automated process.
9. The system will boot up in a Windows inactivated state. Wait 20-30 seconds or so, so Microsoft's servers can successfully authorize the system. With a mouse connected to any of the USB ports right-click on the start icon on the task bar and select system. This will prompt the system to update its activation state.

**Please note:** performing a system restore from the new disk image will erase any valuable data on your system drive. Please ensure you make a back up of any essential files from your system (C:) drive before initialising this process. The process does NOT destroy any media or projects on your media drive.

## 2x4pro overview



**Warning: Opening hardware may void your warranty. Consult Disguise support before opening the hardware.**



**Warning: do not open or remove the case unless you are instructed to do so by a certified Disguise Engineer**

**Please note: If you experience any problems with hardware please contact the [support team](#)**

The machines come pre-installed with the latest software version, enabling you to design, configure and sequence the show on the same machines as you later use for show playback.

For detailed information on the specifications for each plus and pro machine, as well as the other software and hardware bundles offered by Disguise, please see the products section of our web site.

# 2x4pro diagrams

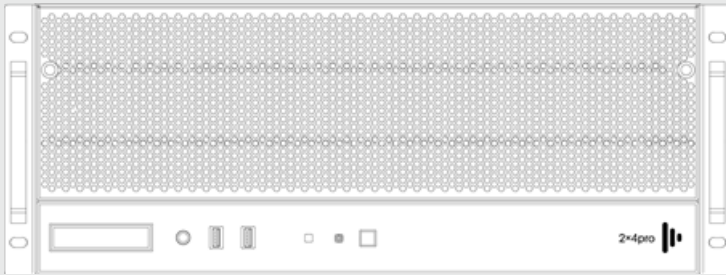

2x4pro front panel

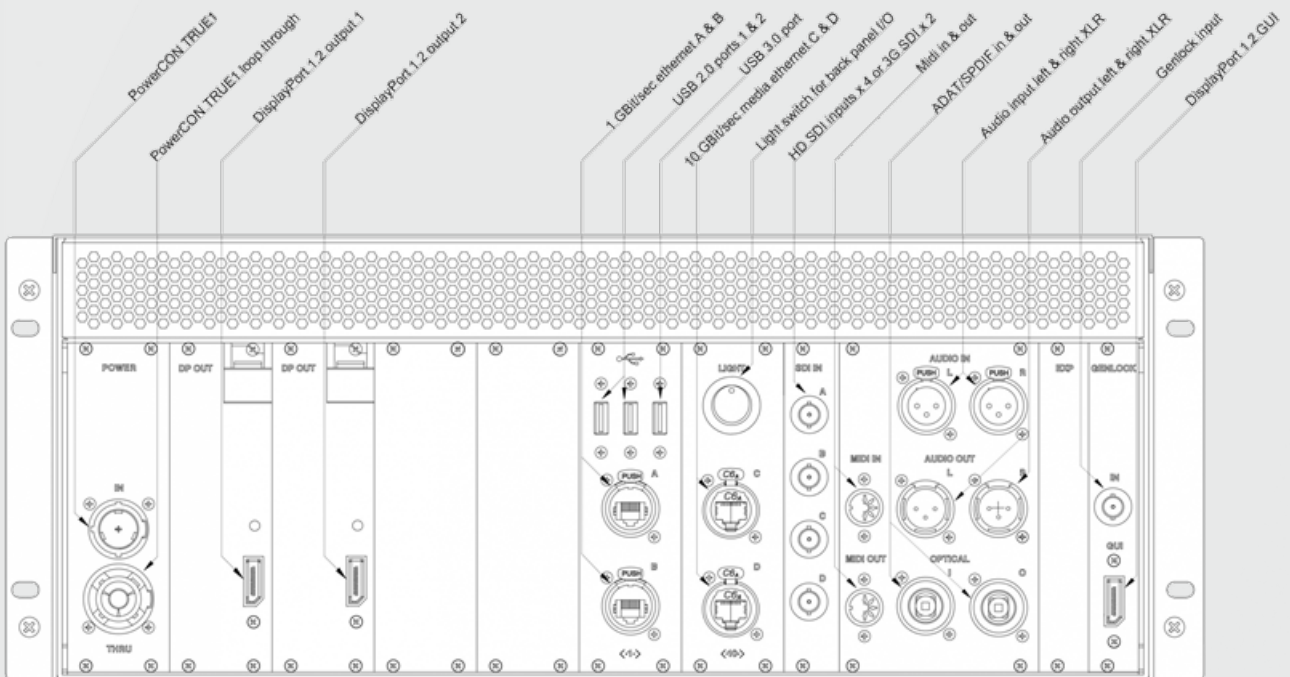

2x4pro rear panel annotated

vx 4+ rear panel annotated

# Powering the 2x4pro

The pro and gx ranges of disguise servers use Neutrik powerCON TRUE1 as the power input. The TRUE1 is:

- Lockable
- Live-Mating (safely)
- Extendable
- Dust and water resistant according to IP65 in mated condition

To power a server, you should use a cable with the following attributes:

- SJT flexible cord, min. 12AWG, min. 300V, min. 60v dm;C, max 4.5 m long
- One end terminated with NEMA 5-15P/BS 1363/CEE 7 plug
- Other end terminated with appliance coupler type Neutrik AG, type NAC3FX

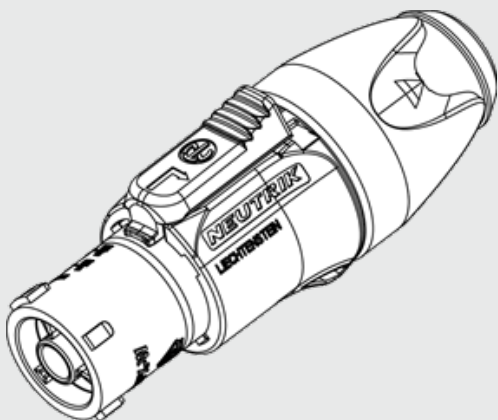

*Neutrik powerCON TRUE1 connector*

# Powering a multi server system

The 2x4pro uses True1 Powercon as its power input and features a loop through to make powering a multi server system more efficient.

The power input to the machine is rated at 12Amps RMS per connection in Europe and USA.

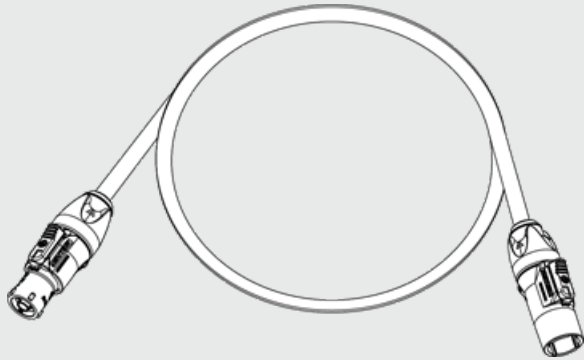

Loop through cables should have the following attributes:

- SJT flexible cord, min. 12AWG, min. 300V, min. 60v dm;C, max 4.5 m long
- One end terminated with appliance coupler type Neutrik AG, type NAC3MX-W
- Other end terminated with appliance coupler type Neutrik AG, type NAC3FX

# Power calculations for a safely powered system

It is important that you calculate how many pro range units you can daisy chain together using the in/loop connections provided. Failure to do so could result in a loss of power to the Disguise system.

Use the formula "Power = Voltage x Current" to calculate how many units you can chain together. For Example:

UK Power: 230V 13Amp rated supply.

For example, max power draw of a 4x4pro = 1400W (check technical specifications for your unit).

Available Power = 230V x 12A

Available Power = 2990W

Available Power / Max Power Draw = Number of Units

2990W / 1400W = 2.1 Units



**Warning:** Be safe! On a UK 13Amp supply @230V you can connect 2 Units safely with 100W of headroom

# Unit rear light - 2x4pro

Disguise servers in the pro and gx ranges come with the addition of an LED light on the back of the unit that illuminates the connections on the rear panel.

The light can be turned on or off using the switch labeled "light" with power in.

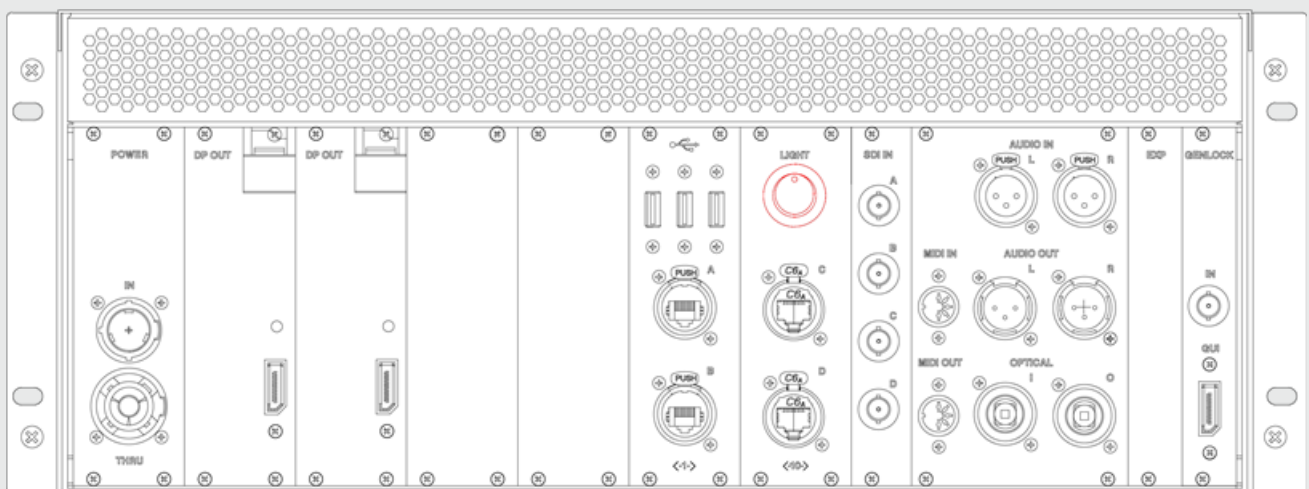

Location of light switch on rear of a 2x4pro

# How to start the unit

1. Connect Power cord to the gx 1gx 2 gx 2c 2x4pro
2. Make sure you have connected a keyboard, mouse and monitor to the primary graphics output.
3. Press the power button on the front of the unit and wait for the system to load into Windows.

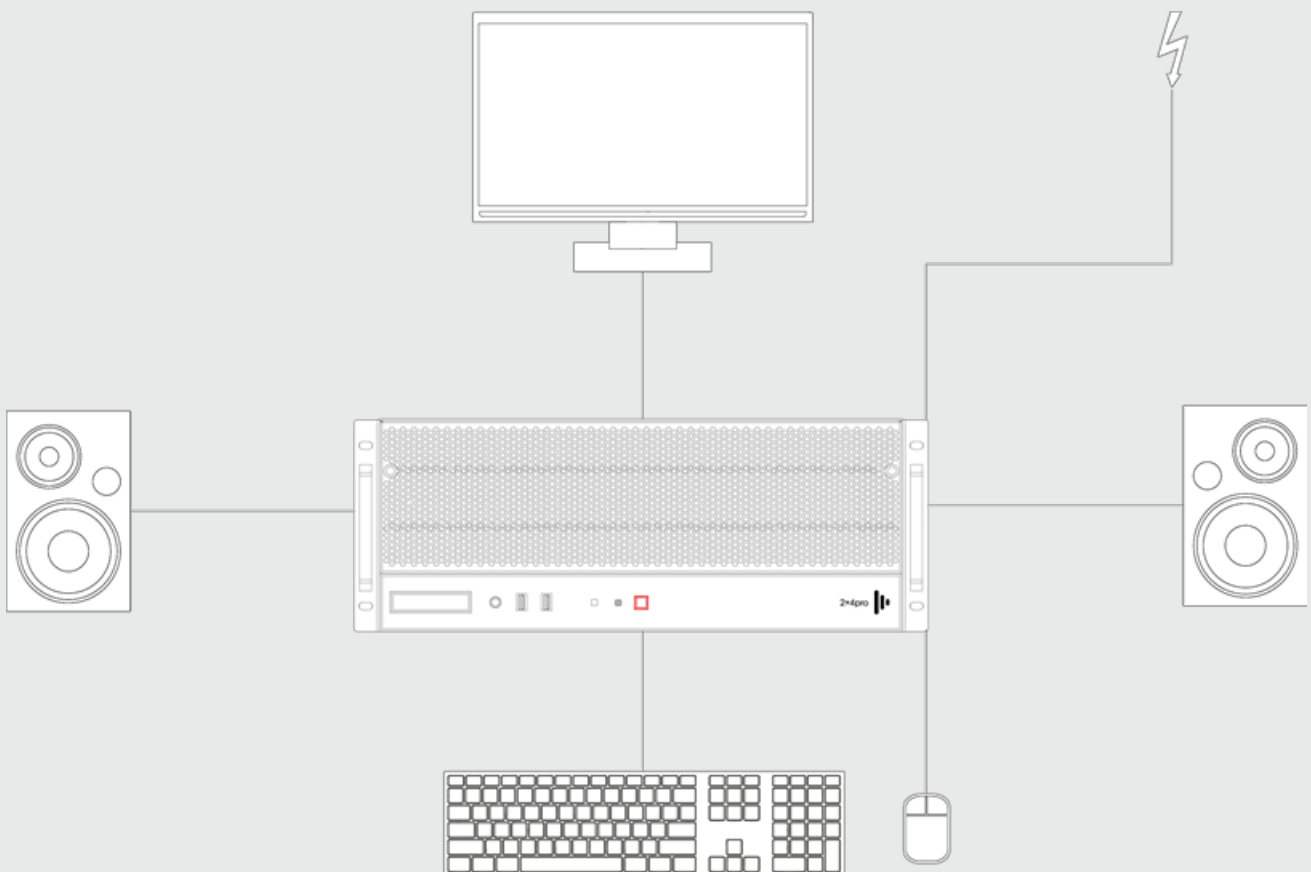



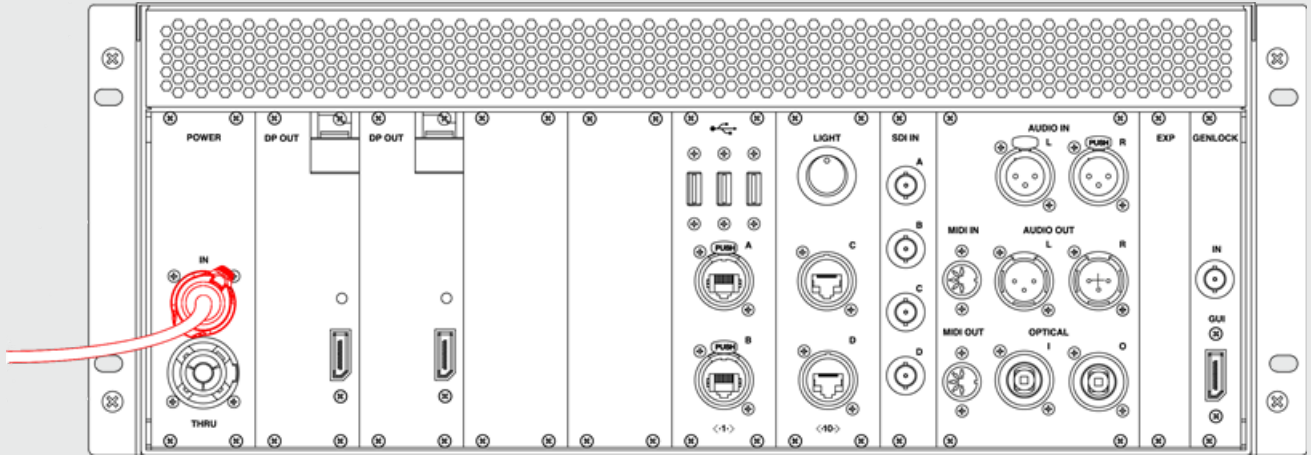

Location of power input on rear of 2x4pro unit

# Update System - 2x4pro

The processes for restoring and reimaging a 2x4pro server

## Overview

Internal system restore is the process of doing a factory restore on the system.

REDISGUISE is the process of doing an update or restore on the system using a bootable USB drive.

Neither of these restore processes affects the media drive of the server.

## Internal Restore

**Please note:** This procedure will only work with OS version 10 and greater.

To locate your OS version please go to **d3manager- Help - About d3manager**.

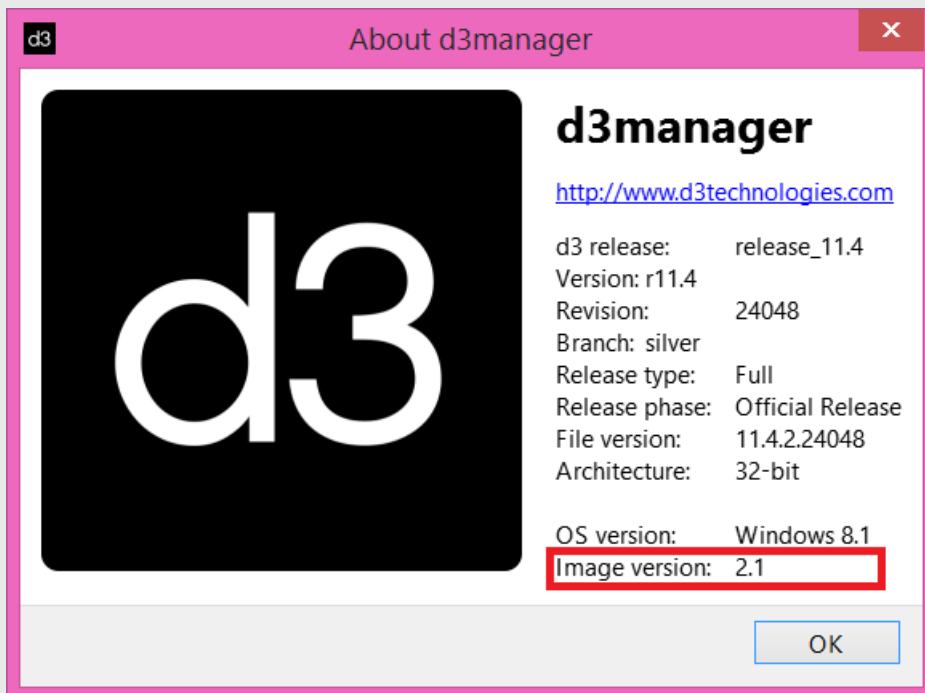



**Warning:** The system needs to be connected to the internet during this procedure. If it is not, or it loses internet connection during the process - windows activation will fail.

## Re-imaging the system

1. Hold down **shift** whilst restarting the system.

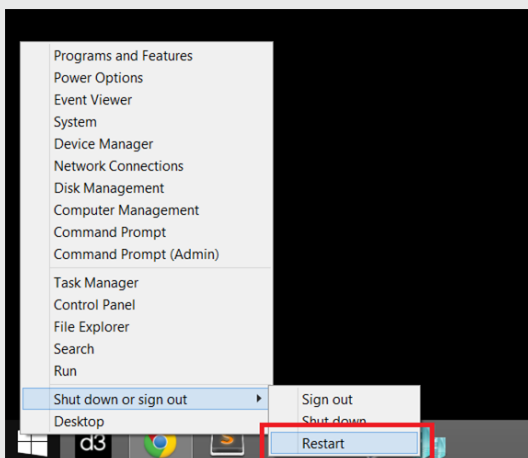

2. Select **Use another operating system**

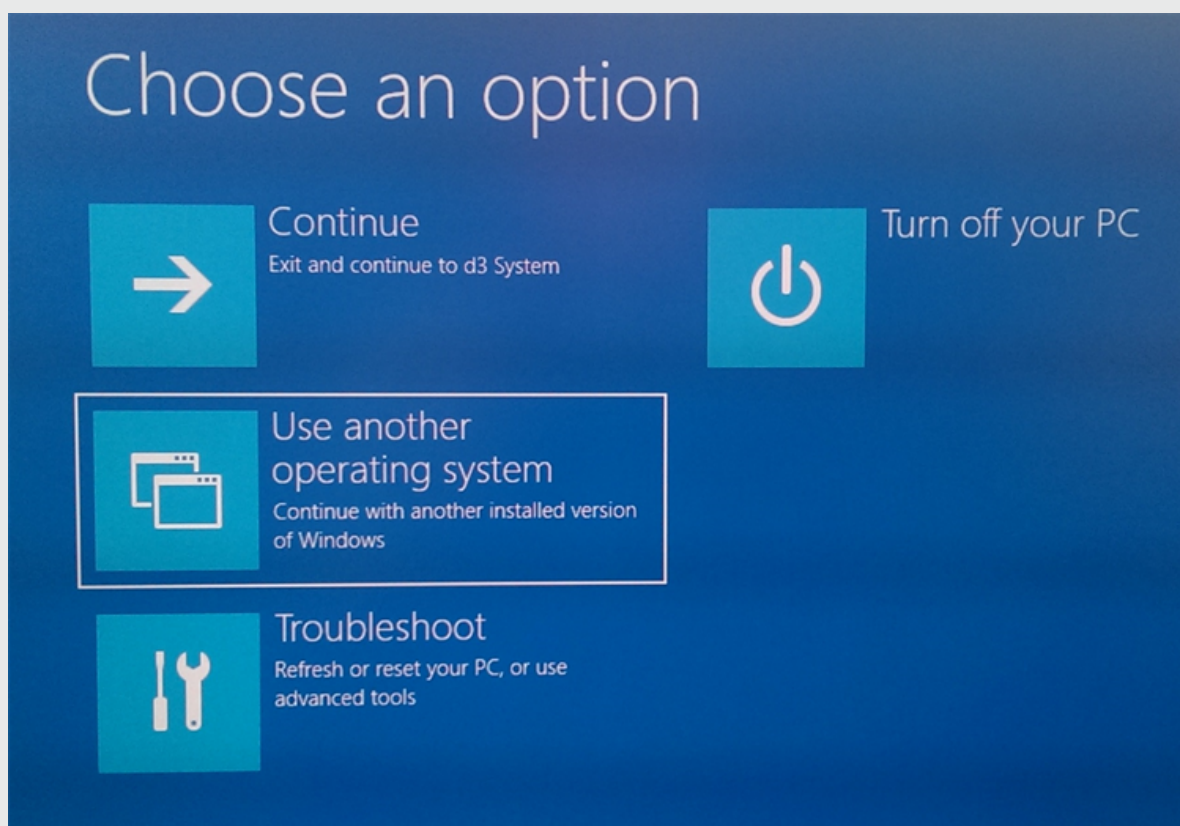

3. Select **Reset OS**.

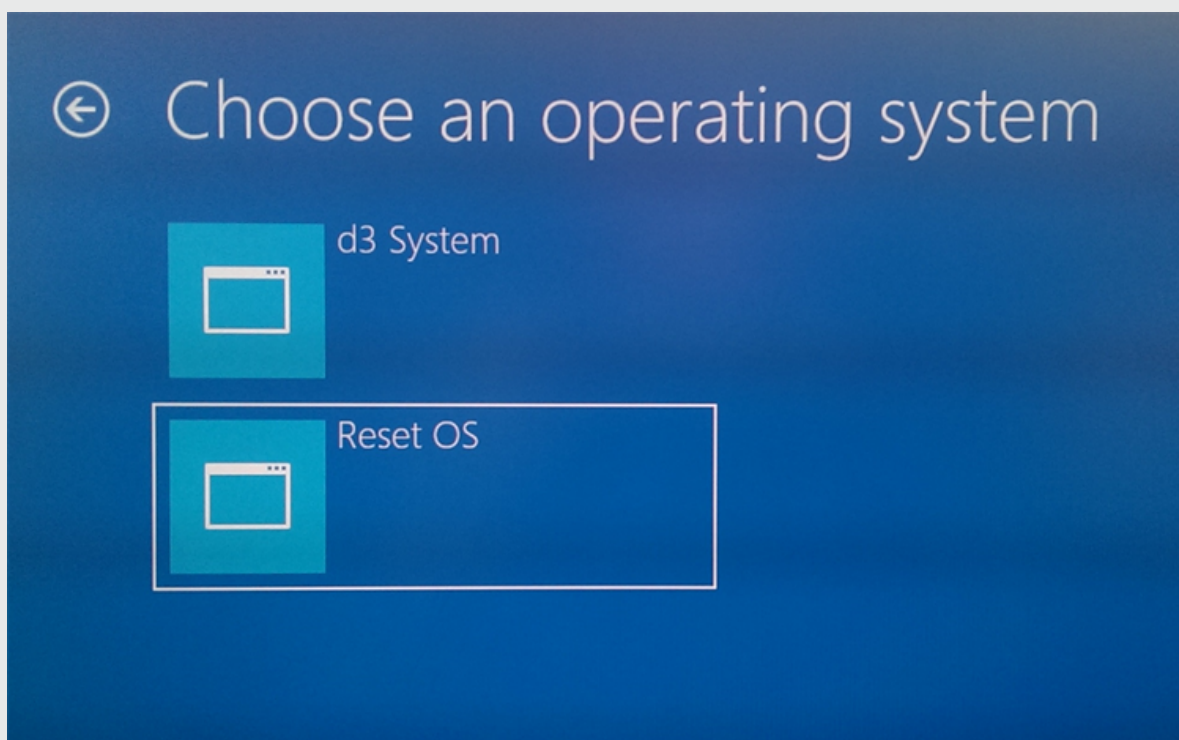

4. The system will reboot into the internal re-imaging system which will reinstall the Operating System and revert settings to factory

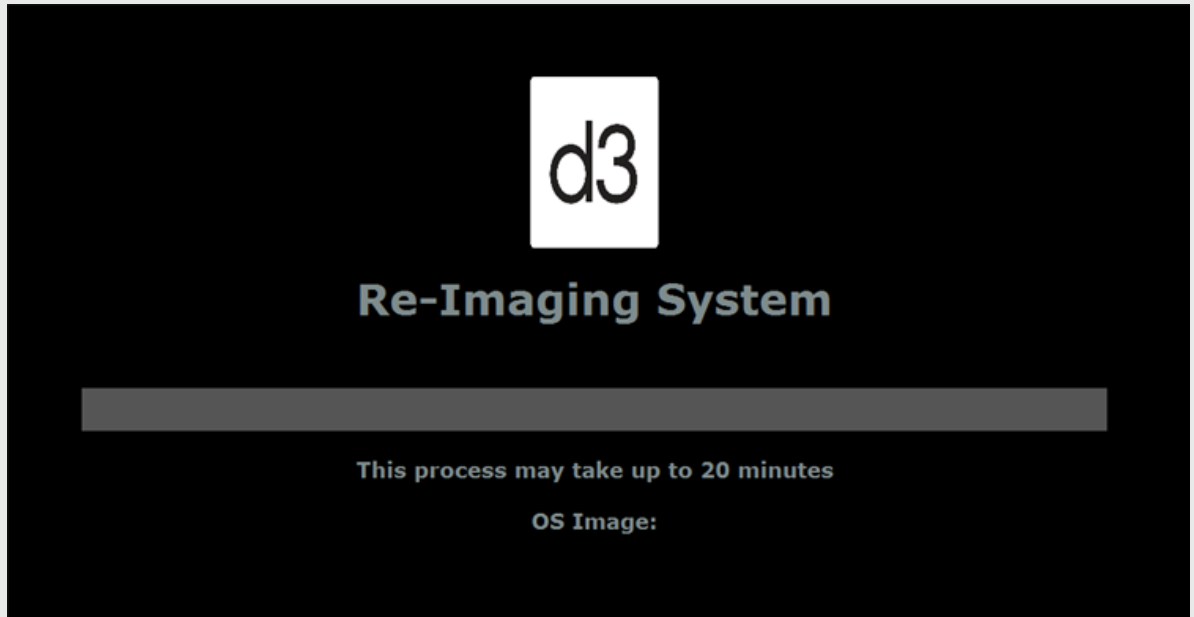

## Activating windows

Windows should activate automatically, as long as the machine was connected to the internet for the duration of the re-imaging process.

If windows does not activate during the re-imaging process, follow these steps.

1. Wait for a few minutes after the re-imaging process has completed to allow the server time to activate Windows.

2. Navigate to the System tab by right clicking on the Windows start menu and selecting **System**

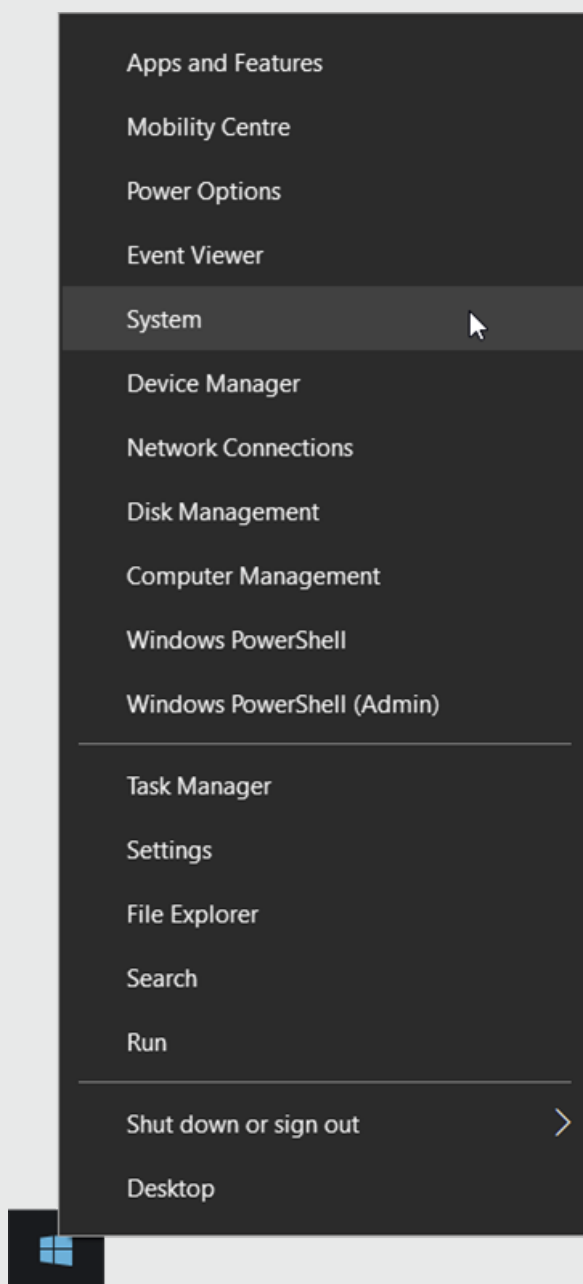

3. In the System window, check to see if you have valid Windows license information visible. If you do not, contact the [disguise support team](#).

# REDISGUISE

**Please note:** If you experience any problems during updating or restoring the system, or any of these instructions are unclear, please contact the [support team](#).



**Warning:** The system needs to be connected to the internet during this procedure

This process can be used to update to a newer OS image, or revert to a previous OS image.

To tell what OS image your system is on please go to the help menu in [d3manager](#) and select **About d3manageranager**.

## You will need

- A 32Gb USB memory stick
- A version of [Rufus](#) to turn it into a bootable disk. Make sure the volume name of the USB is: "REDISGUISE" as per image
- An internet connection to the machine you are re-imaging
- Download and install a version of [7Zip](#)
- Download and unzip the multi file archive using 7Zip
- OS images can be found [here](#).

**Please note:** You do not need to extract all parts individually. Simply place them in the same directory and then use 7zip to extract the ISO by selecting any part. 7zip will automatically unzip all parts to create the image file.



# Create Bootable USB device

1. Download and unzip the multi-file archive using 7Zip (NOTE: you will only need to unzip file 001):

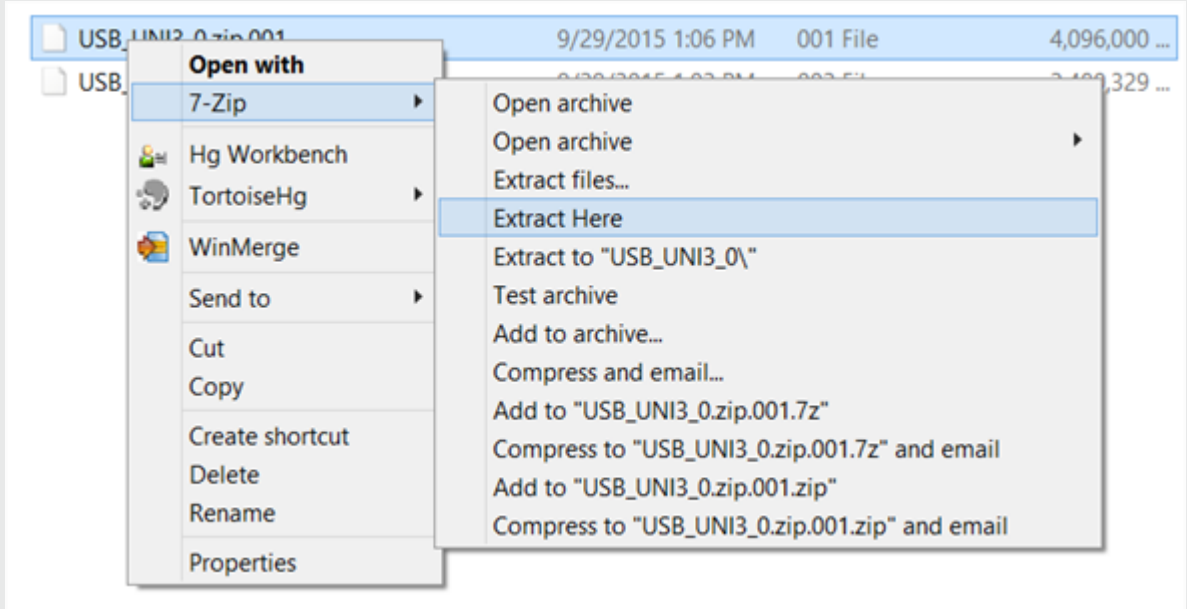

2. Create Bootable USB stick with the unzipped ISO.

The settings should be:

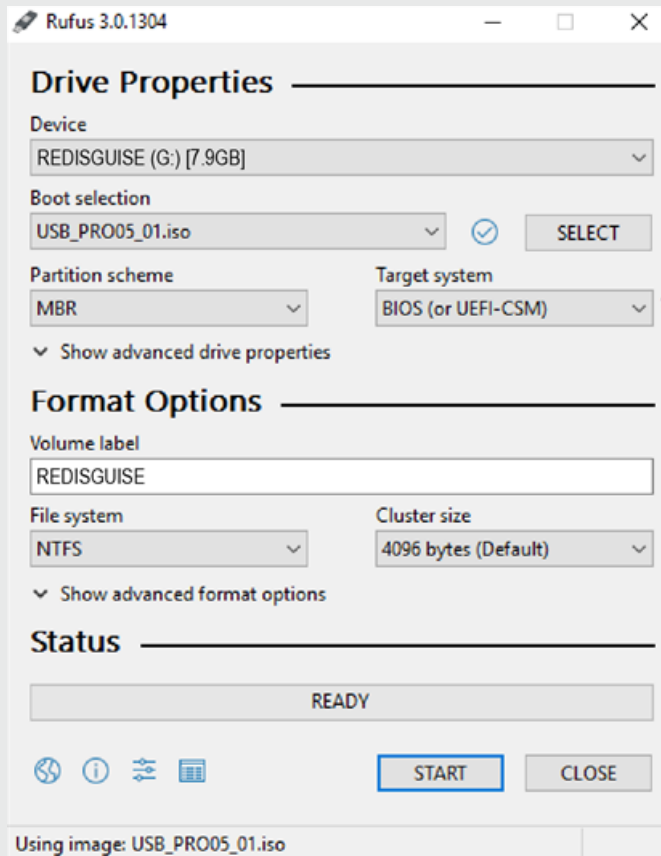

- Partition scheme - MBR
- Target system - BIOS (or UEFI-CSM)
- Volume label - automatically pulled from ISO file
- File system - NTFS



**Warning:** These settings are critically important. The re-image process will fail if they are not set correctly.

**Please note:** On the latest versions of Rufus you may see this warning. This is expected and does not apply to current disguise hardware. Please click **OK** to continue as normal.

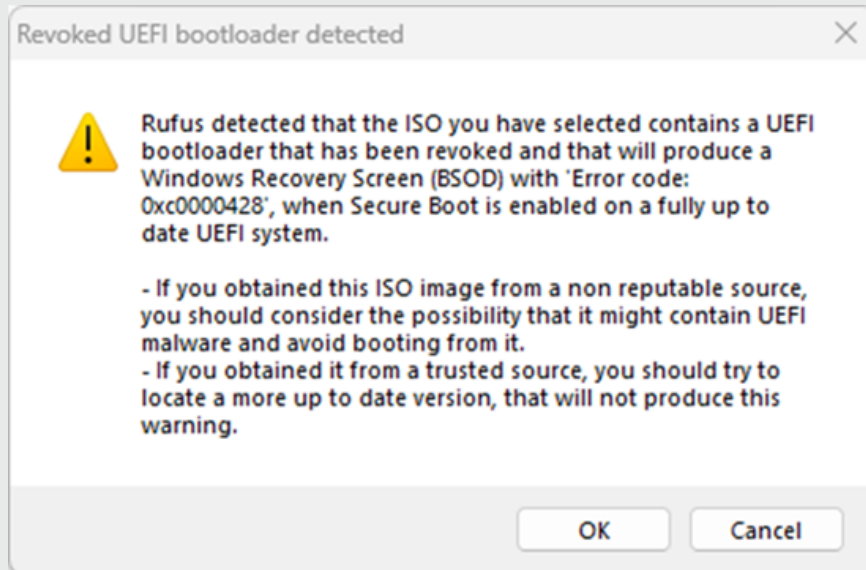

## Booting into the USB



**Warning:** You must use the white USB 2.0 ports on the rear of the system for the re-image to work. You cannot re-image using the USB 3.0 ports.

1. Go into the BIOS by hitting Delete on the logo splash screen during boot.
2. Navigate to the Boot tab using the arrow keys and select Harddrive BBS Properties. Hit Enter to access the properties.
3. Navigate to the Advanced tab and change the Boot option #1 to the USB stick
4. Do not select Save and Exit. Hit escape, and navigate to Save & Exit tab.

5. Select your USB stick from the Boot override menu. Press Enter.
6. Be ready to hit any key to confirm USB boot immediately after.

**Please note:** performing a system restore from the new disk image will erase any valuable data on your system drive. Please ensure you make a back up of any essential files from your system (C:) drive before initialising this process. The process does NOT destroy any media or projects on your media drive.

# Video input

Your pro system is equipped with capture cards. These cards have the ability to capture live video from either SD-SDI or HD-SDI video sources with up to four unique feeds, or two unique 3G-SDI feeds per machine.

## Max Number of Unique Inputs

SD-SDI	HD-SDI	3G-SDI
4	4	2



**Warning:** 4K resolutions is currently only supported over quad split HD-SDI

## Supported formats

720x486i @ 59.94 Hz NTSC

720x576i @ 50.00 Hz PAL

1280x720p @ 23.976Hz, 24Hz, 25Hz, 29.97Hz, 30Hz, 50Hz, 59.94Hz, 60Hz

1920x1080i @ 47.96Hz, 48Hz, 50Hz, 59.94Hz, 60Hz

1920x1080PsF @ 23.976Hz, 24Hz, 25Hz, 29.97Hz, 30Hz

1920x1080p @ 23.976Hz, 24Hz, 25Hz, 29.97Hz, 30Hz, 47.96Hz, 48Hz, 50Hz, 59.94Hz, 60Hz

2048X1080p @ 23.976Hz, 24Hz, 25Hz, 29.97Hz, 30Hz, 47.96Hz, 48Hz, 50Hz, 59.94Hz, 60Hz

2048X1080i @ 47.96Hz, 48Hz, 50Hz, 59.94Hz, 60Hz

2048x1556PsF @ 14.98Hz, 15Hz, 18.98Hz, 19Hz

4K UHD 3840x2160, 4K P/PsF @ 23, 24, 25, 29, 30fps

4K DCI 4096x2160, 4K P/PsF, @23, 24, 25, 29, 30fps

It is possible to have a different format on each input, However the limitations are a maximum of 1x 4k or 2x 1080p60.

If you are using 1x 4k or 2x 1080p it is not possible to use any other video inputs on the unit due to hardware limitations.

## Back-Plate Layout

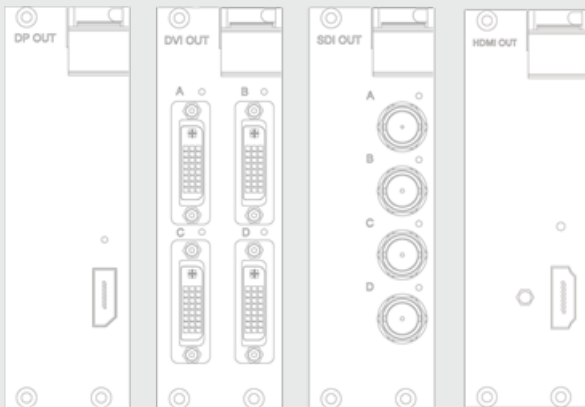

*Diagram of Video Capture BNC connections on rear of unit*

**Please note:** Live Video input inherently introduces frame latency during playback. Please contact [Support](#) for guidance on performance standards.

# Video output

The pro and gx ranges of disguise servers come with a range of possible output configurations. It is possible to use a combination of any of the types of four VFC cards below.



<b>Display Port 1.2</b>	<b>Quad DVI</b>	<b>Quad SDI</b>	<b>HDMI</b>
-------------------------	-----------------	-----------------	-------------

1 Output per card	4 Outputs per card	4 Outputs per card	1 Output per card
Max res: 4096x2160	Single Link DVI: (up to) 1920 x 1200	Max res: 1920 x 1080	Max res: 4096x2160 @60 YCbCr444 8bit 3840x2160 @60 YCbCr422 10bit* 3840x2160 @30 YCbCr444 10bit
LED indicator	LED indicator	LED indicator	LED indicator
Genlocked	All outputs genlocked	All outputs genlocked	Genlocked

# 4K Output

The 2x4pro ships with the standard configuration of Display Port cards.



**Warning: We highly advise using DisplayPort cables specifically validated for: DP 1.2, DP 1.2a or 21.6 Gbps bandwidth**

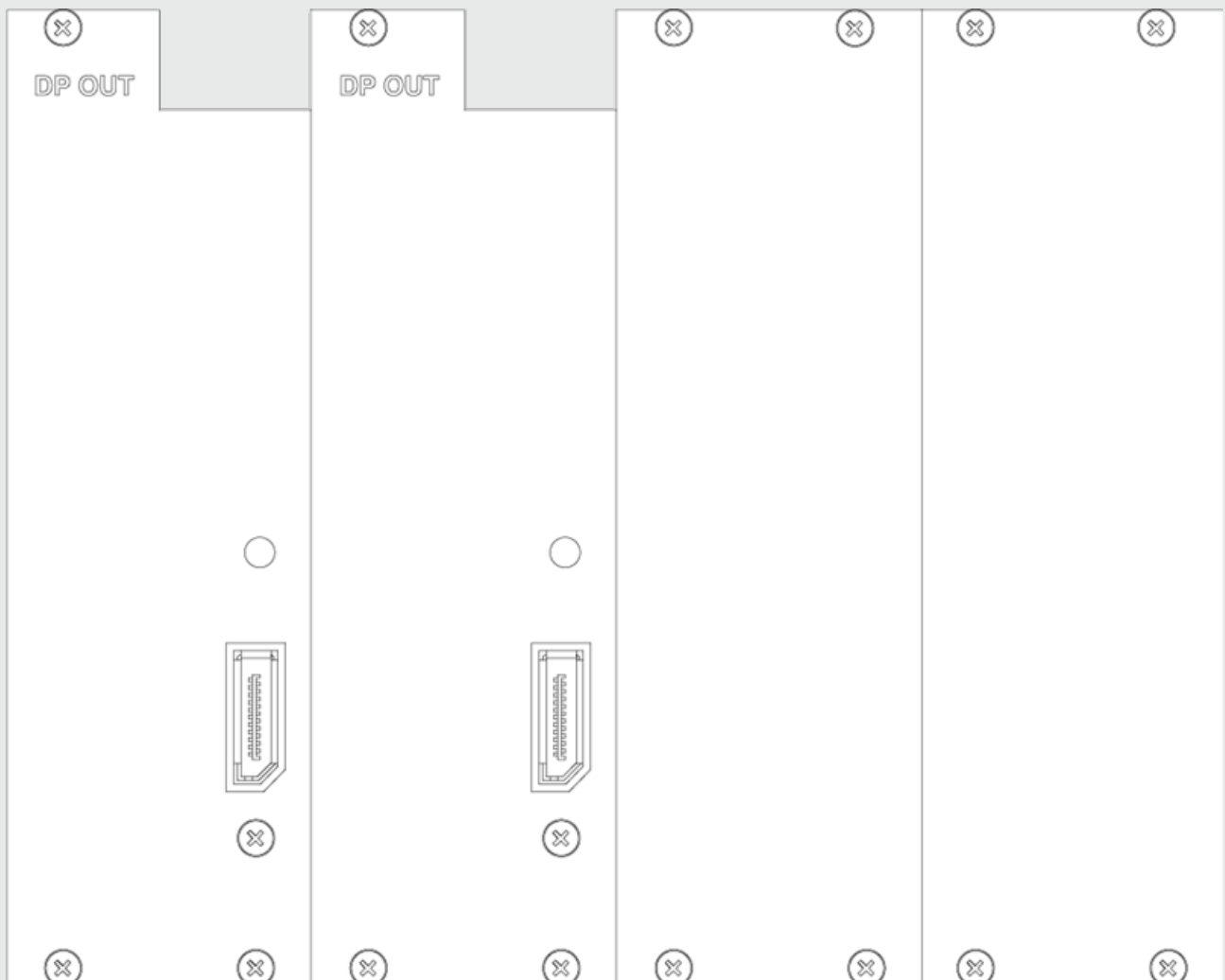

*2 x DisplayPort 1.2 outputs on rear of 2x4pro*

This enables the pro & gx ranges of disguise servers to support resolutions up to 4096x2160 60hz over Single Stream Transport.



# Audio input and output

The pro range is equipped with a broadcast quality pro audio card which uses the latest 192kHz AD and DA converters.

The 2x4pro is equipped with a broadcast quality pro audio card which uses the latest 192kHz AD and DA converters.

## Back panel connections

- XLR Left + Right Input
- XLR Left + Right Output
- ADAT/SPDIF Input
- ADAT/SPDIF Output
- MIDI Input
- MIDI Output

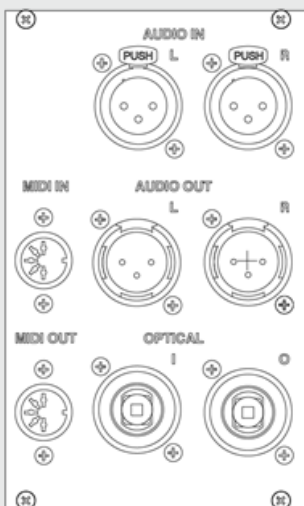

Audio connections on rear of 2x4pro unit.

## Front panel connections

- 1/4inch Stereo Monitoring socket

It is possible to monitor audio output from the unit from the 1/4inch stereo socket with a pair of headphones.

## RME card settings

1. Go to the Windows Start Menu.
2. Right click on the speaker in the task tray next to the clock on the desktop and click on Playback Devices.
3. Scroll Down and Right-click the device named Speakers and select Set as Default device if it is not already selected.

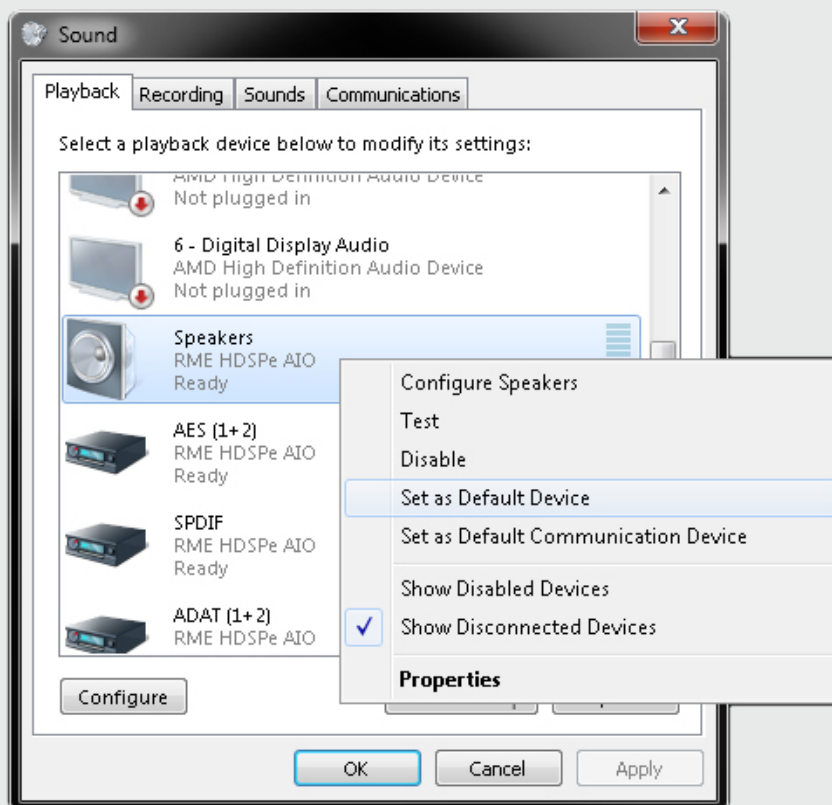

## 4x2pro overview



**Warning: Opening hardware may void your warranty. Consult Disguise support before opening the hardware.**



**Warning: do not open or remove the case unless you are instructed to do so by a certified Disguise Engineer**

**Please note: If you experience any problems with hardware please contact [disguise support](#).**

The machines come pre-installed with the latest software version, enabling you to design, configure and sequence the show on the same machines as you later use for show playback.

For detailed information on the specifications for each plus and pro machine, as well as the other software and hardware bundles offered by Disguise, please see the products section of our web site.

# 4x2pro diagrams

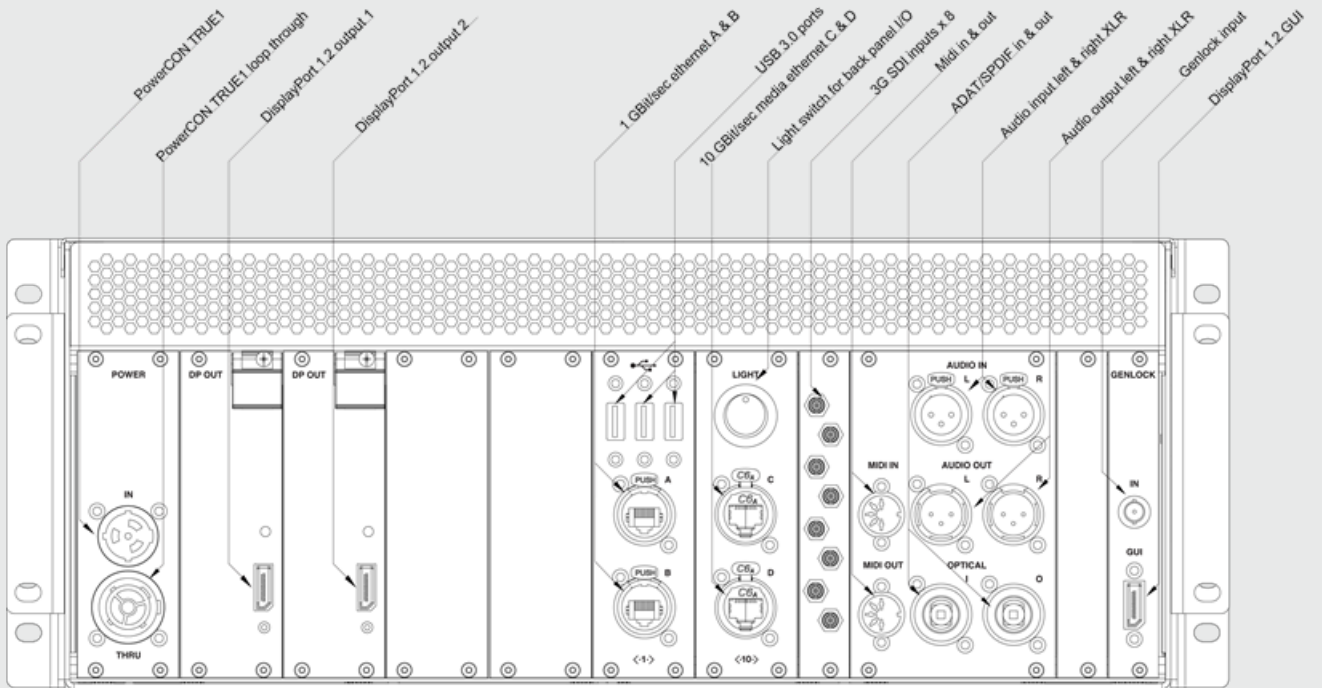

gx 2c rear panel annotated

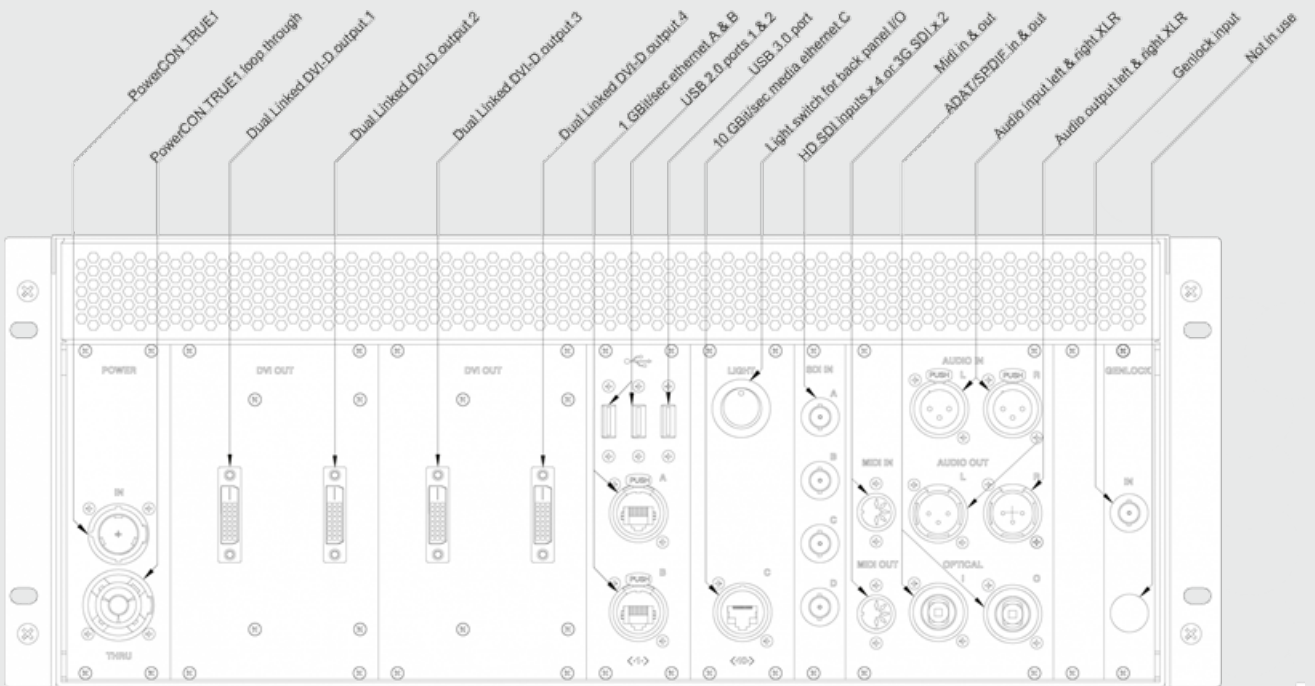

4x2pro rear panel

vx 4+ rear panel annotated

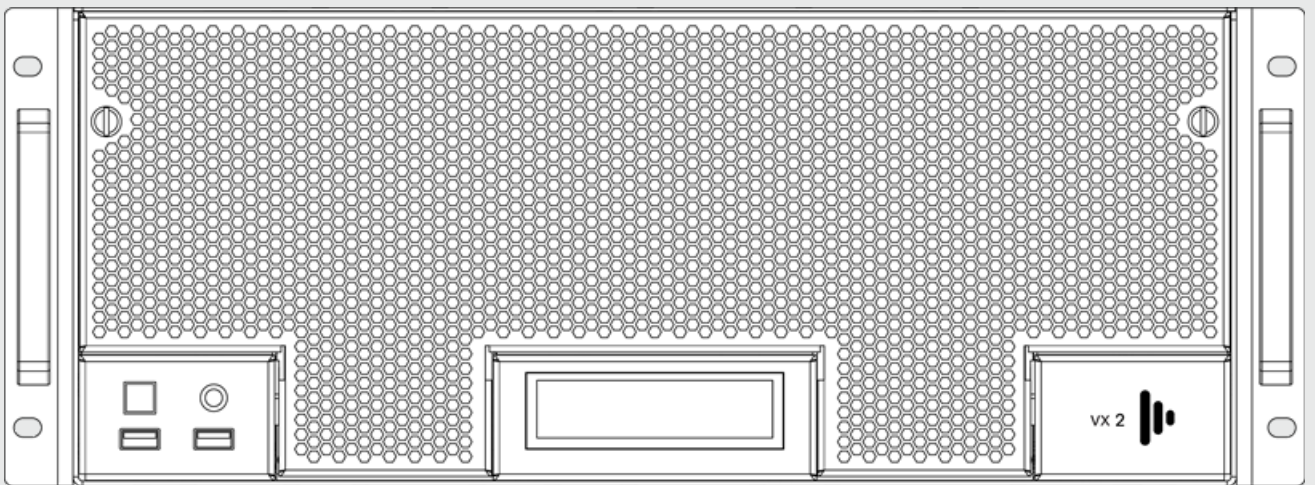

vx 2 front panel





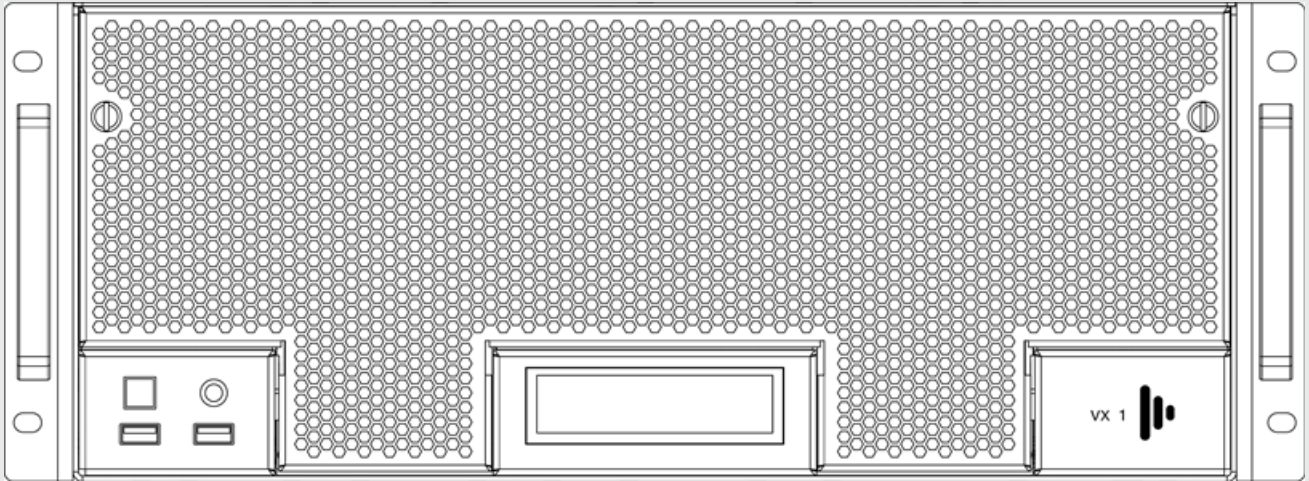

vx 1 front panel

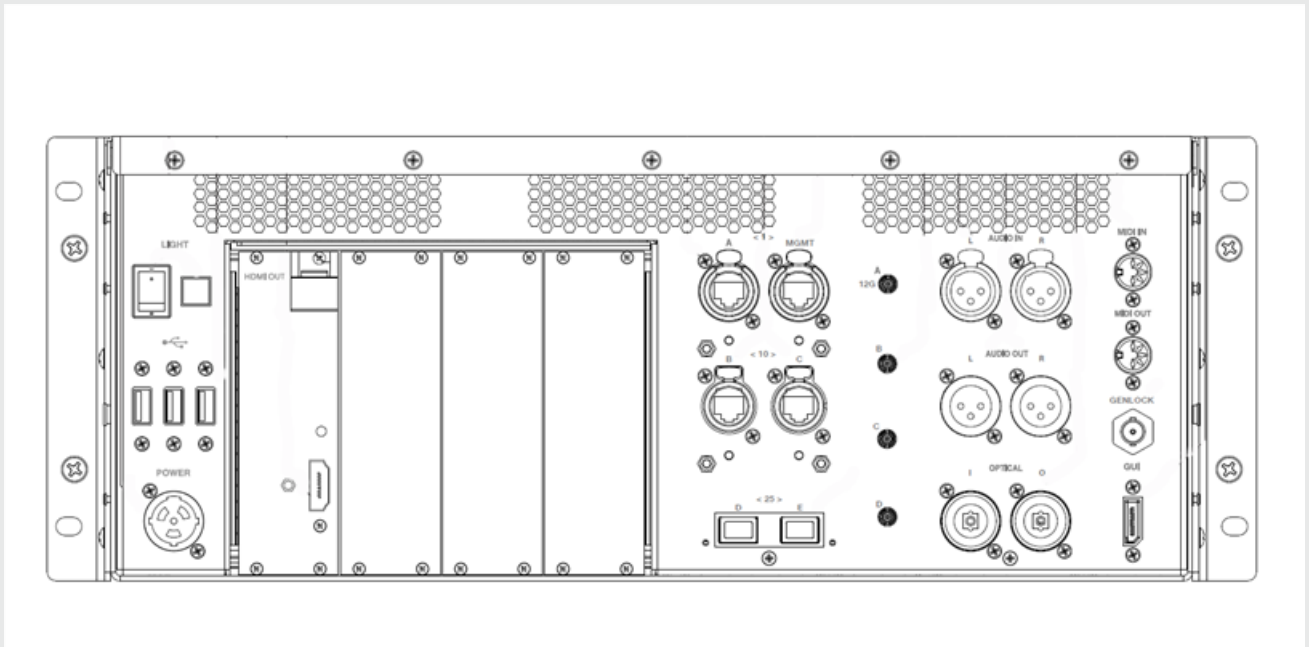

vx 1 rear panel

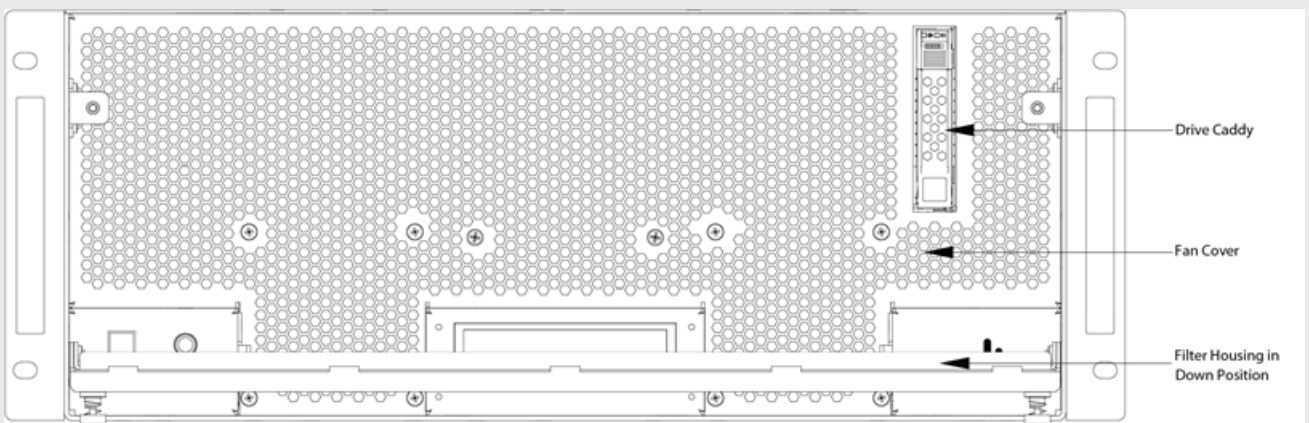

vx 1 front panel grill down

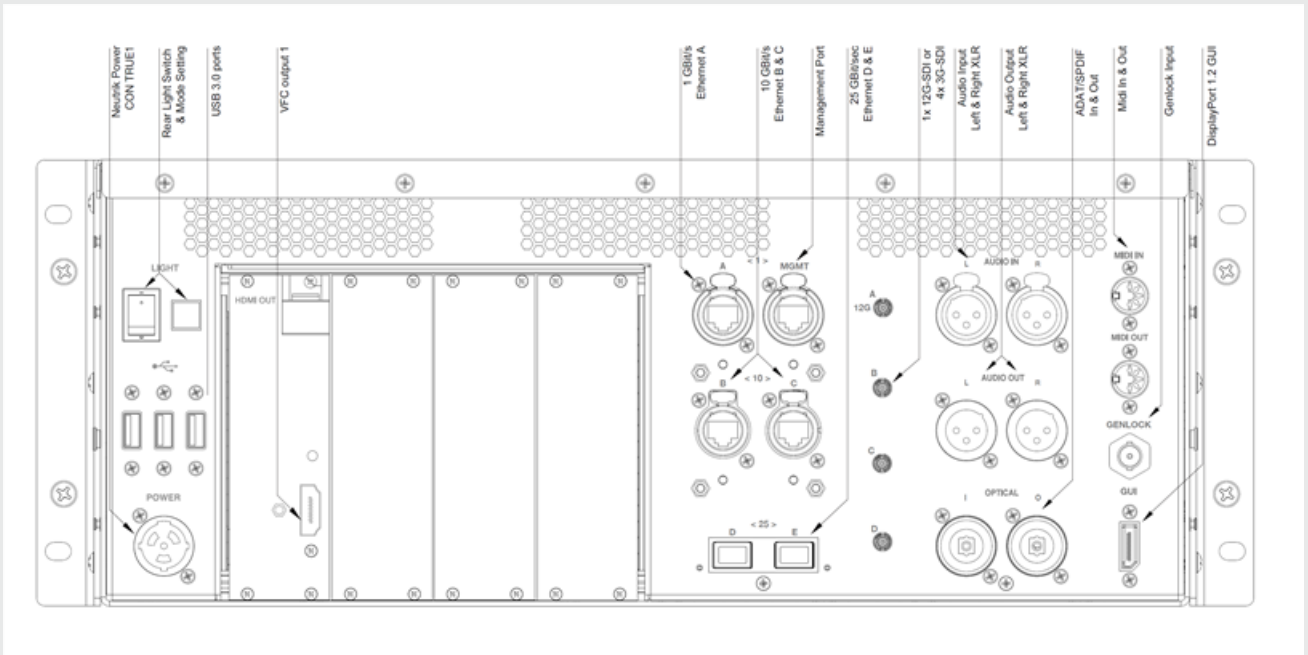

vx 1 rear panel annotated



# Powering the 4x2pro

The pro and gx ranges of disguise servers use Neutrik powerCON TRUE1 as the power input. The TRUE1 is:

- Lockable
- Live-Mating (safely)
- Extendable
- Dust and water resistant according to IP65 in mated condition

To power a server, you should use a cable with the following attributes:

- SJT flexible cord, min. 12AWG, min. 300V, min. 60v dm;C, max 4.5 m long
- One end terminated with NEMA 5-15P/BS 1363/CEE 7 plug
- Other end terminated with appliance coupler type Neutrik AG, type NAC3FX

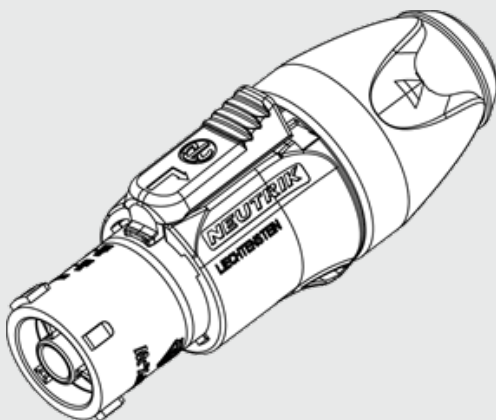

*Neutrik powerCON TRUE1 connector*

# Powering a multi server system

The 4x2pro uses True1 Powercon as its power input and features a loop through to make powering a multi server system more efficient.

The power input to the machine is rated at 12Amps RMS per connection in Europe and USA.

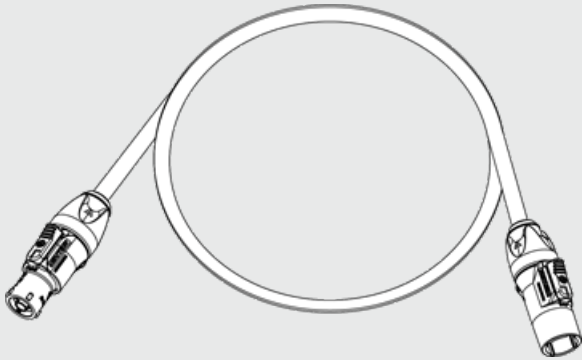

Loop through cables should have the following attributes:

- SJT flexible cord, min. 12AWG, min. 300V, min. 60v dm;C, max 4.5 m long
- One end terminated with appliance coupler type Neutrik AG, type NAC3MX-W
- Other end terminated with appliance coupler type Neutrik AG, type NAC3FX

# Power calculations for a safely powered system

It is important that you calculate how many units you can daisy chain together using the in/loop connections provided. Failure to do so could result in a loss of power to the Disguise system.

Use the formula "Power = Voltage x Current" to calculate how many units you can chain together. For Example:

UK Power: 230V 13Amp rated supply.

For example, max power draw of a 4x4pro = 1400W (check technical specifications for your unit).

Available Power = 230V x 12A

Available Power = 2990W

Available Power / Max Power Draw = Number of Units

2990W / 1400W = 2.1 Units



**Warning:** Be safe! On a UK 13Amp supply @230V you can connect 2 Units safely with 100W of headroom

# How to start the unit

1. Connect Power cord to the gx 1gx 2 gx 2c 4x2pro ,vx 2 ,vx 1rx
2. Make sure you have connected a keyboard, mouse and monitor to the primary graphics output.
3. Press the power button on the front of the unit and wait for the system to load into Windows.

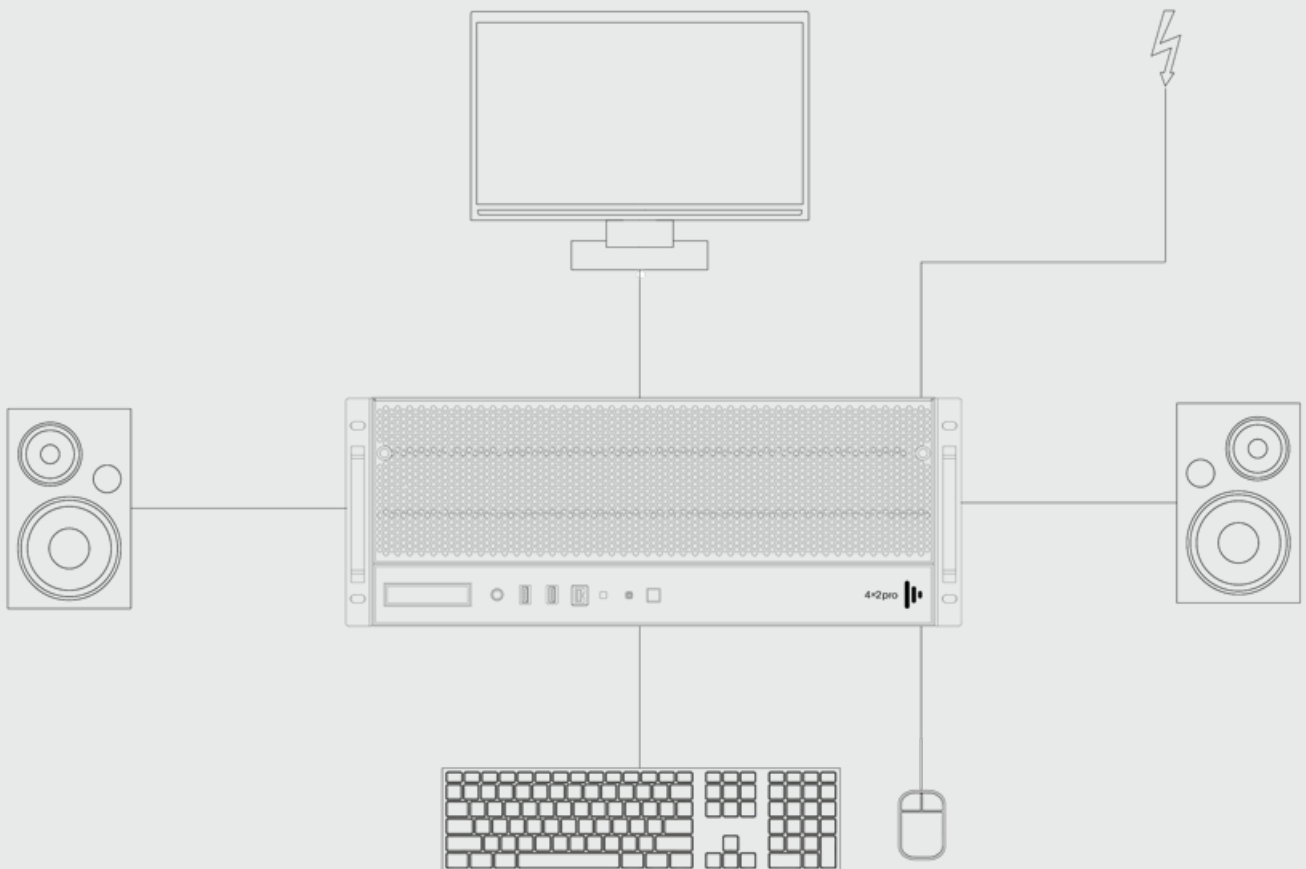

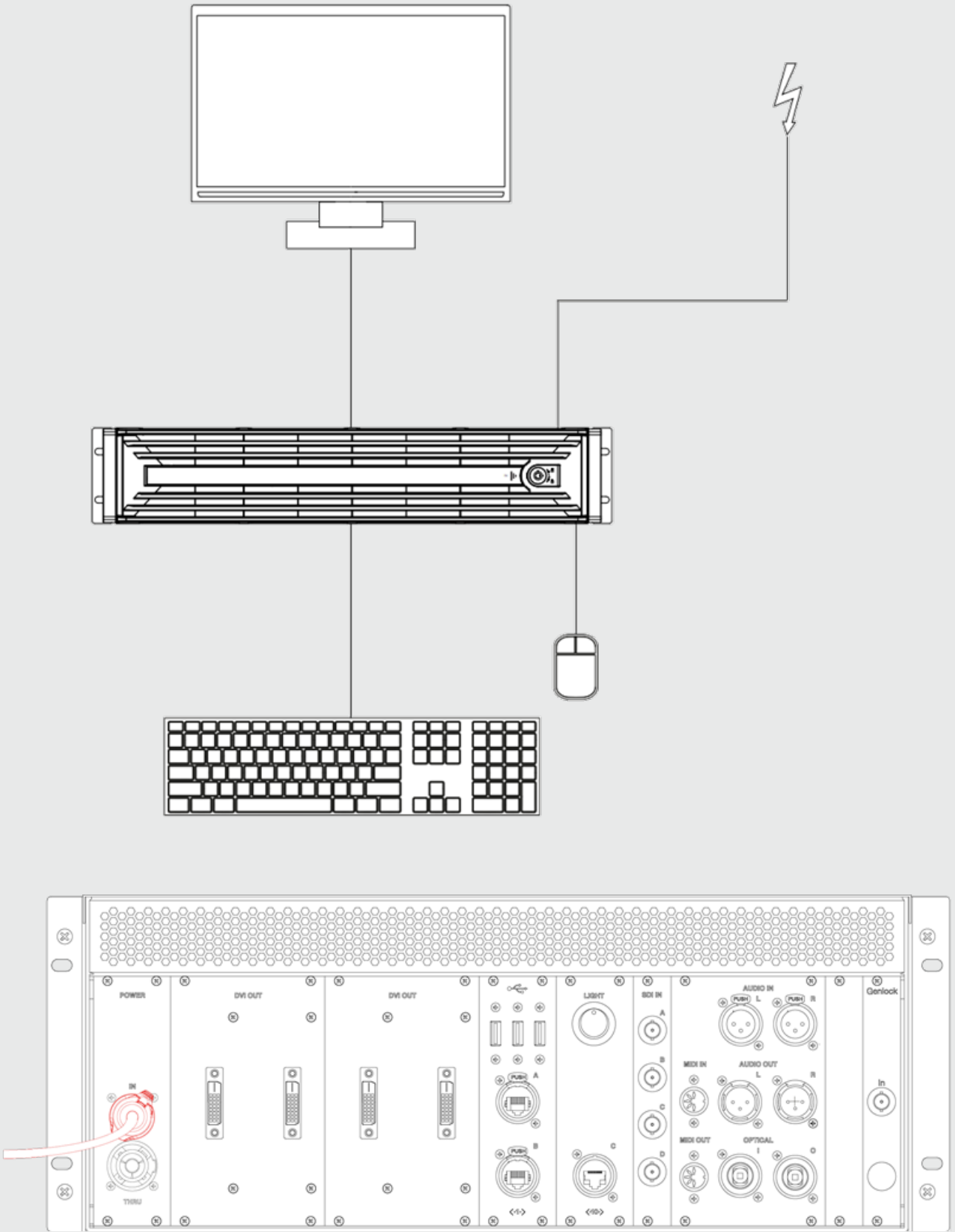

Location of power input on rear of 4x2pro unit

# Unit rear light

Disguise servers in the pro and gx ranges come with the addition of an LED light on the back of the unit that illuminates the connections on the rear panel.

The light can be turned on or off using the switch labeled "light" with power in.

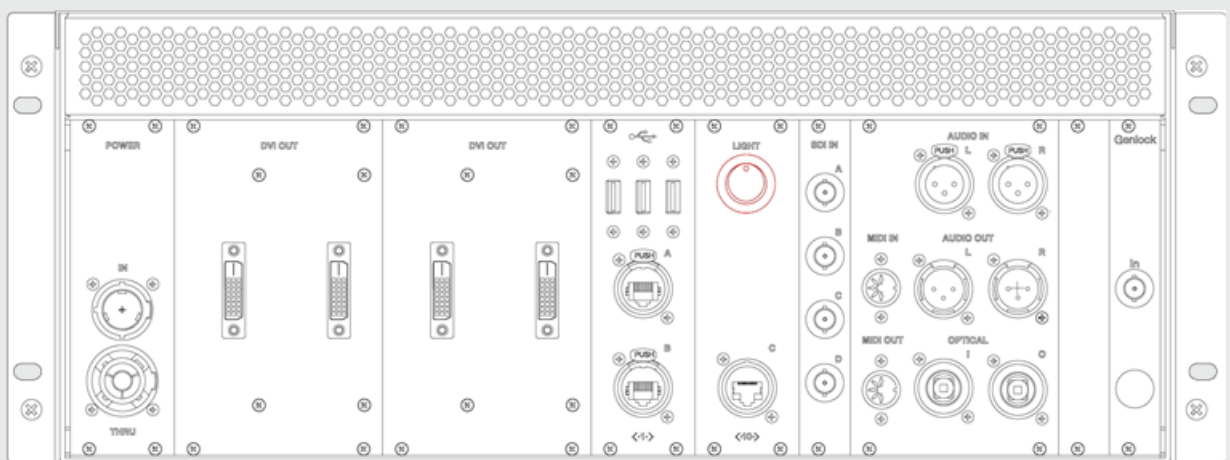

*Location of light switch on rear of a 4x2pro*

# Update System - 4x2pro

The processes for restoring and reimaging a 4x2pro server

## Overview

Internal system restore is the process of doing a factory restore on the system.

REDISGUISE is the process of doing an update or restore on the system using a bootable USB drive.

Neither of these restore processes affects the media drive of the server.

## Internal Restore

**Please note:** This procedure will only work with OS version 10 and greater.

To locate your OS version please go to **d3manager- Help - About d3manager**.

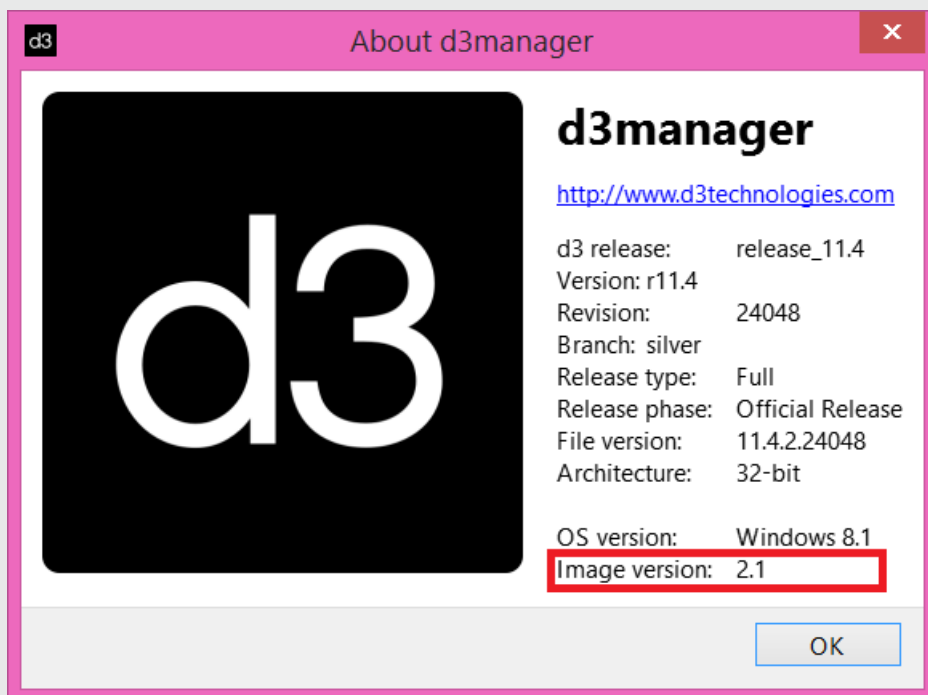



**Warning:** The system needs to be connected to the internet during this procedure. If it is not, or it loses internet connection during the process - windows activation will fail.

## Re-imaging the system

1. Hold down **shift** whilst restarting the system.

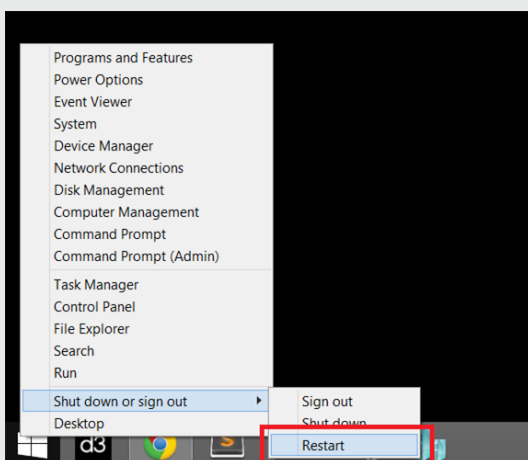
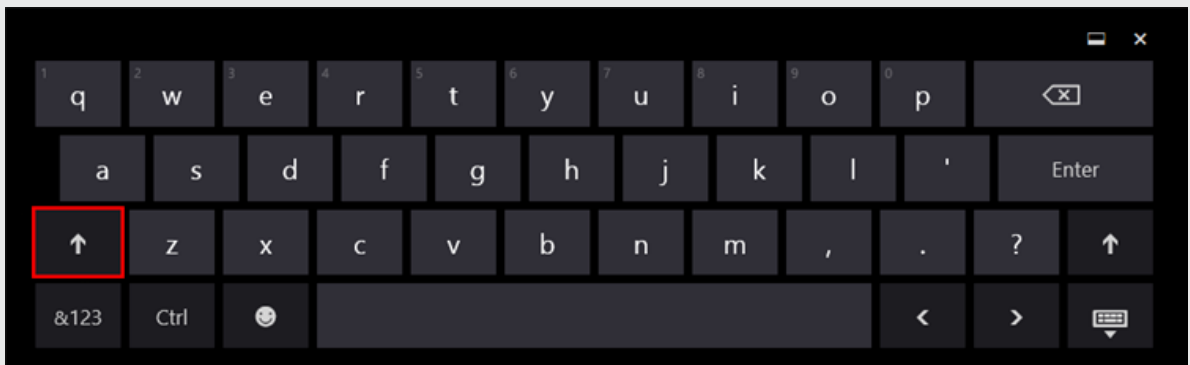



2. Select **Use another operating system**

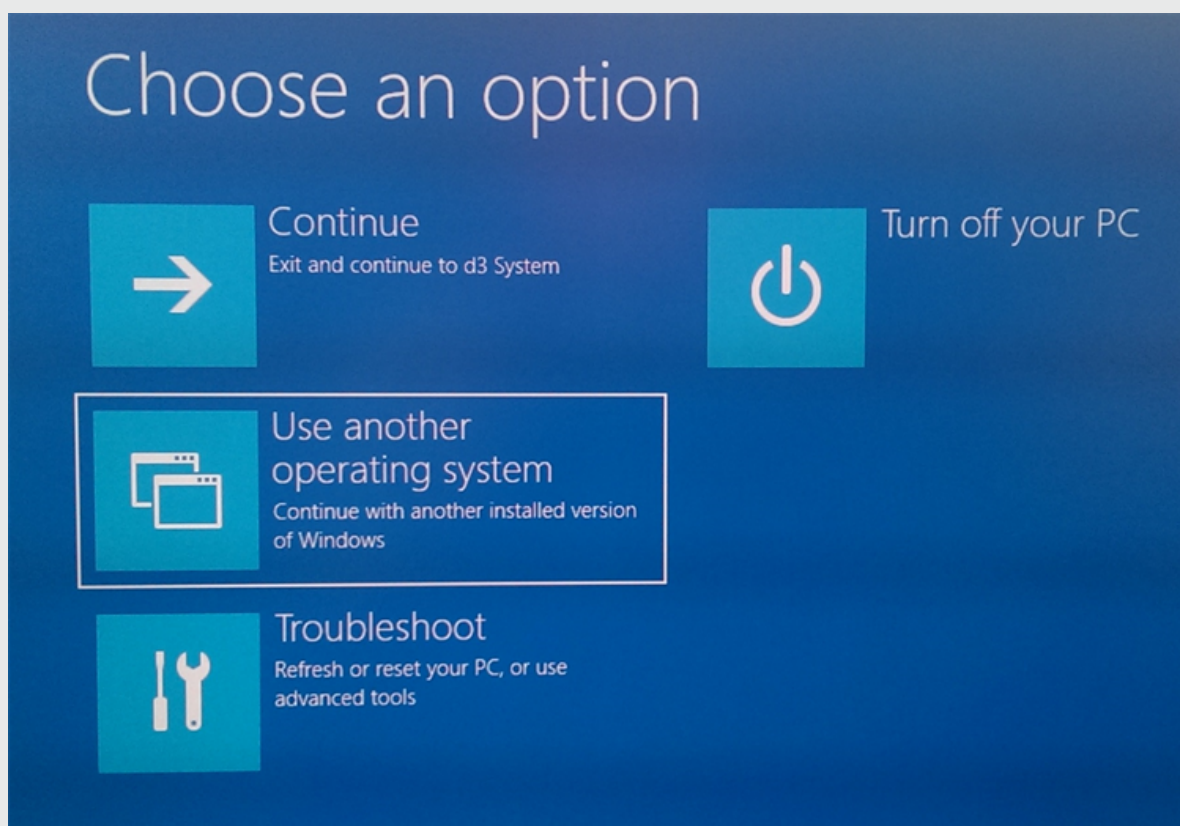

3. Select **Reset OS**.

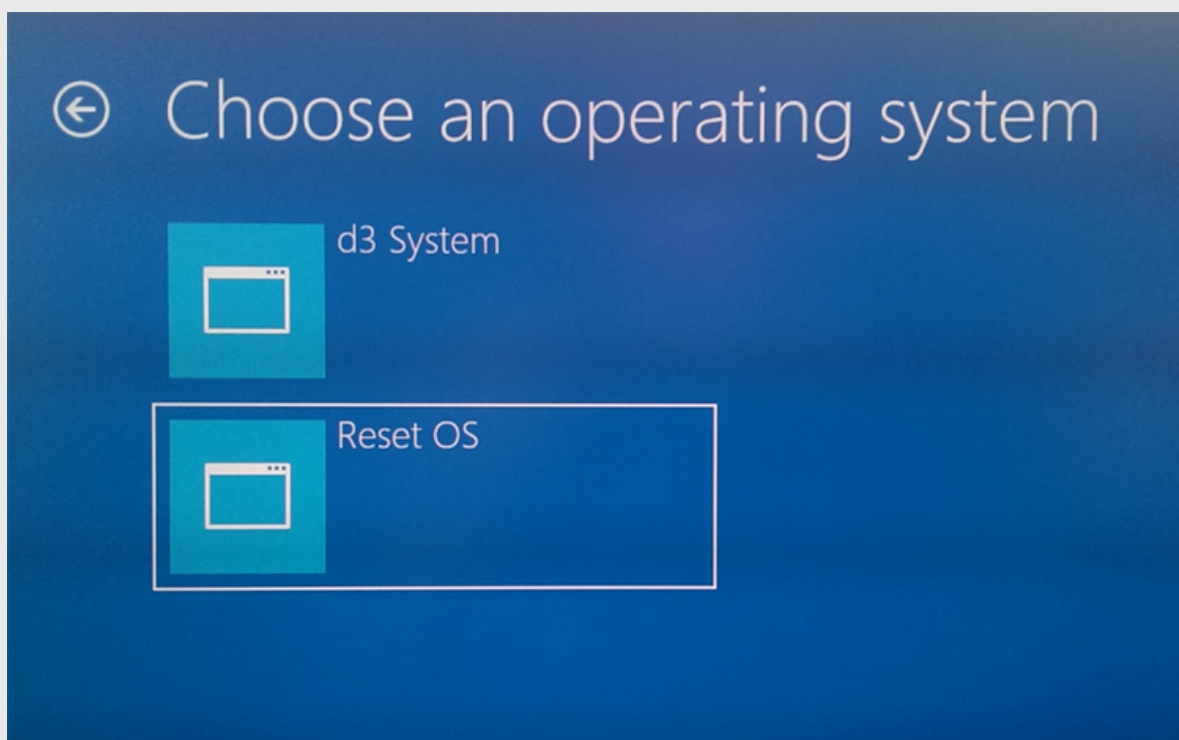

4. The system will reboot into the internal re-imaging system which will reinstall the Operating System and revert settings to factory



## Activating windows

Windows should activate automatically, as long as the machine was connected to the internet for the duration of the re-imaging process.

If windows does not activate during the re-imaging process, follow these steps.

1. Wait for a few minutes after the re-imaging process has completed to allow the server time to activate Windows.

2. Navigate to the System tab by right clicking on the Windows start menu and selecting **System**

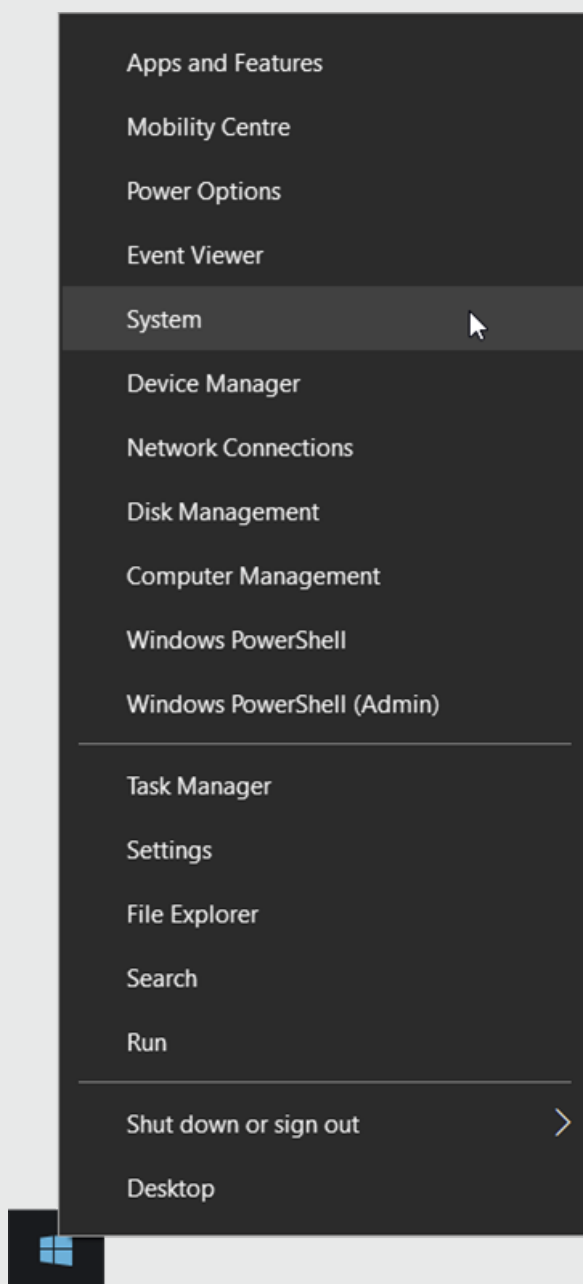

3. In the System window, check to see if you have valid Windows license information visible. If you do not, contact the [disguise support team](#).

# REDISGUISE

**Please note:** If you experience any problems during updating or restoring the system, or any of these instructions are unclear, please contact the [support team](#).



**Warning:** The system needs to be connected to the internet during this procedure

This process can be used to update to a newer OS image, or revert to a previous OS image.

To tell what OS image your system is on please go to the help menu in [d3manager](#) and select **About d3manageranager**.

## You will need

- A 32Gb USB memory stick
- A version of [Rufus](#) to turn it into a bootable disk. Make sure the volume name of the USB is: "REDISGUISE" as per image
- An internet connection to the machine you are re-imaging
- Download and install a version of [7Zip](#)
- Download and unzip the multi file archive using 7Zip
- OS images can be found [here](#).

**Please note:** You do not need to extract all parts individually. Simply place them in the same directory and then use 7zip to extract the ISO by selecting any part. 7zip will automatically unzip all parts to create the image file.

# Create Bootable USB device

1. Download and unzip the multi-file archive using 7Zip (NOTE: you will only need to unzip file 001):

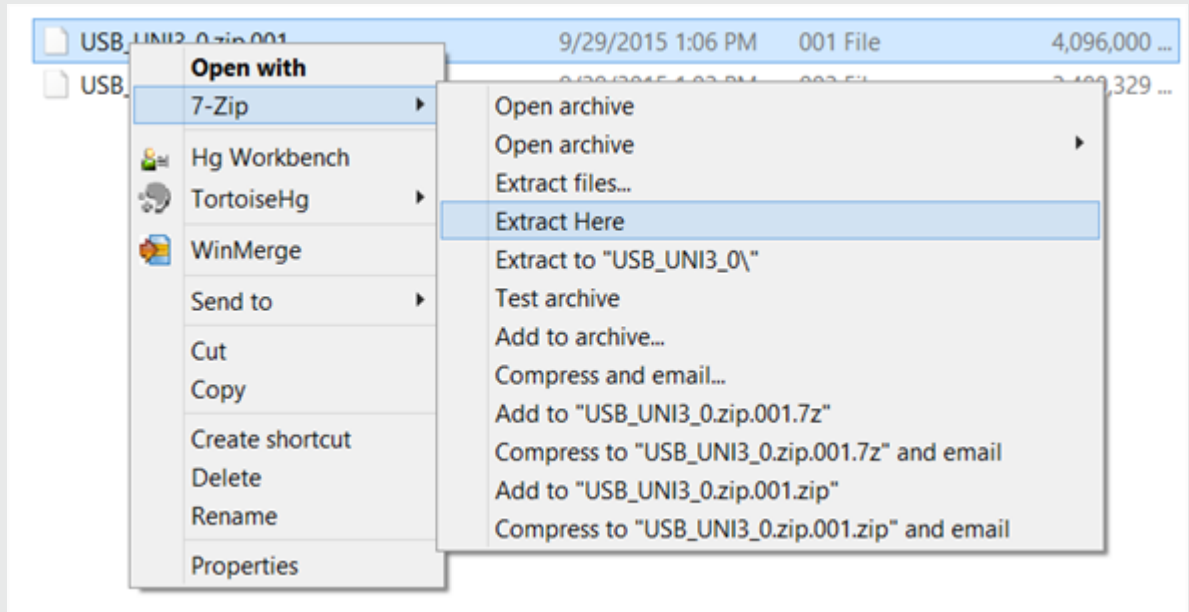

2. Create Bootable USB stick with the unzipped ISO.

The settings should be:

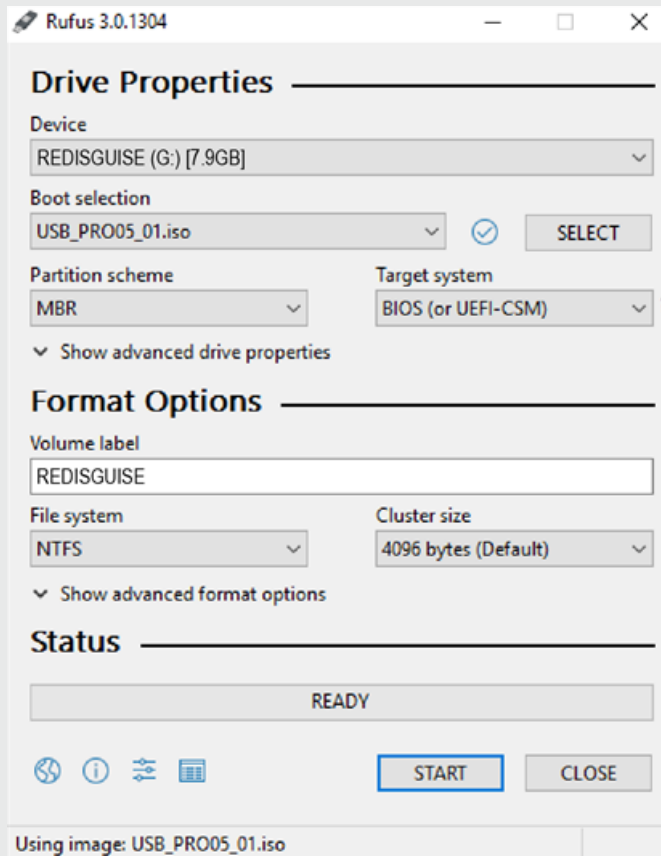

- Partition scheme - MBR
- Target system - BIOS (or UEFI-CSM)
- Volume label - automatically pulled from ISO file
- File system - NTFS



**Warning:** These settings are critically important. The re-image process will fail if they are not set correctly.

**Please note:** On the latest versions of Rufus you may see this warning. This is expected and does not apply to current disguise hardware. Please click **OK** to continue as normal.

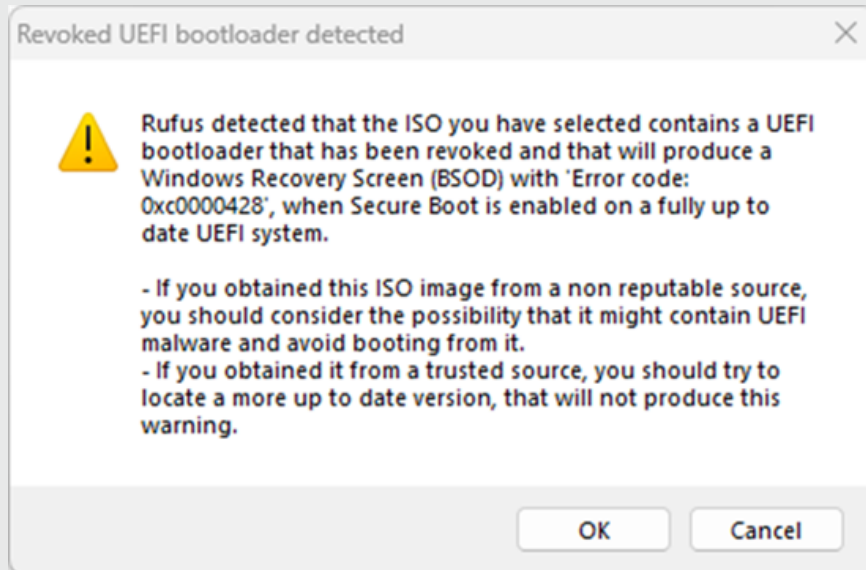

## Booting into the USB



**Warning:** You must use the white USB 2.0 ports on the rear of the system for the re-image to work. You cannot re-image using the USB 3.0 ports.

1. Insert the USB Device into the USB2.0 (white) port on the back of the system.
2. Plug a keyboard into the other USB2.0 (white) port.
3. Invoke boot options whilst your Pro Range system is booting by pressing the **F11** key on the BIOS splash screen.



4. Select your USB key from the menu. Normally it is listed as the name of the Vendor of the USB key. Please be aware of the Press any key to boot from USB message as this will disappear quickly if you are running a version of Rufus prior to v3.
5. After this you will need to press Enter once to boot into the usb and the re-imaging process will commence. This should take around 20 minutes to complete and will include three system restarts which will be part of the automated process.
6. The system will boot up in a Windows in-activated state. Wait 20-30 seconds for Microsoft's servers to successfully authorise the system. With a mouse connected to any of the USB ports right-click on the start icon on the task bar and select system. This will prompt the system to update its activation state.
7. You can download the latest version of the disguise software from [here](#) and you will be good to go!

**Please note:** performing a system restore from the new disk image will erase any valuable data on your system drive. Please ensure you make a back up of any essential files from your system (C:) drive before initialising this process. The process does NOT destroy any media or projects on your media drive.

# Video output

The pro and gx ranges of disguise servers come with a range of possible output configurations. It is possible to use a combination of any of the types of four VFC cards below.

The 4x2pro comes with 4 individual outputs of Dual Link DVI capable of up to 2560x1800 on each output.

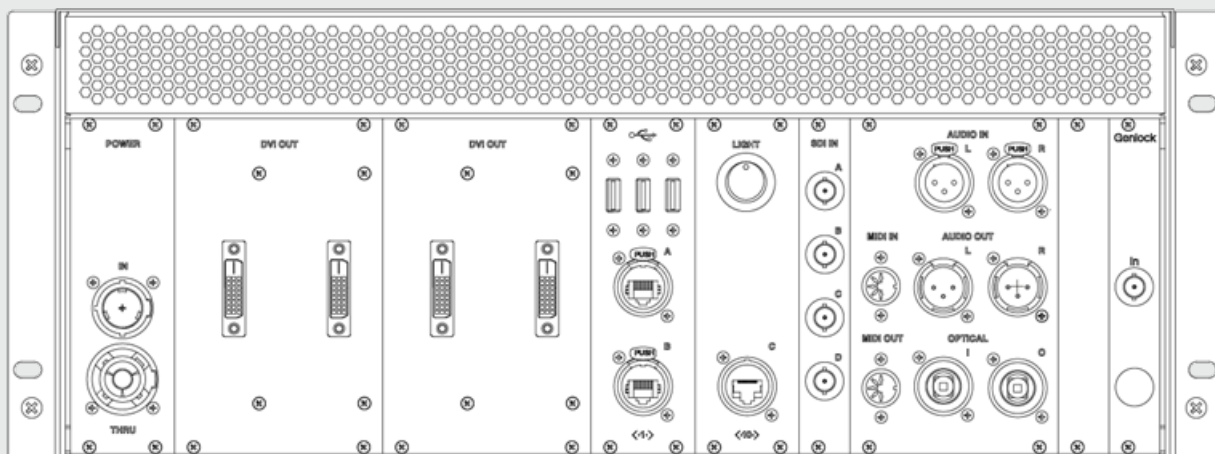

# Video input

Your pro system is equipped with capture cards. These cards have the ability to capture live video from either SD-SDI or HD-SDI video sources with up to four unique feeds, or two unique 3G-SDI feeds per machine.

## Max Number of Unique Inputs

<b>SD-SDI</b>	<b>HD-SDI</b>	<b>3G-SDI</b>
4	4	2



**Warning:** 4K resolutions is currently only supported over quad split HD-SDI

## Supported formats

720x486i @ 59.94 Hz NTSC

720x576i @ 50.00 Hz PAL

1280x720p @ 23.976Hz, 24Hz, 25Hz, 29.97Hz, 30Hz, 50Hz, 59.94Hz, 60Hz

1920x1080i @ 47.96Hz, 48Hz, 50Hz, 59.94Hz, 60Hz

1920x1080PsF @ 23.976Hz, 24Hz, 25Hz, 29.97Hz, 30Hz

1920x1080p @ 23.976Hz, 24Hz, 25Hz, 29.97Hz, 30Hz, 47.96Hz, 48Hz, 50Hz, 59.94Hz, 60Hz

2048X1080p @ 23.976Hz, 24Hz, 25Hz, 29.97Hz, 30Hz, 47.96Hz, 48Hz, 50Hz, 59.94Hz, 60Hz

2048X1080i @ 47.96Hz, 48Hz, 50Hz, 59.94Hz, 60Hz

2048x1556PsF @ 14.98Hz, 15Hz, 18.98Hz, 19Hz

4K UHD 3840x2160, 4K P/PsF @ 23, 24, 25, 29, 30fps

4K DCI 4096x2160, 4K P/PsF, @23, 24, 25, 29, 30fps

It is possible to have a different format on each input, However the limitations are a maximum of 1x 4k or 2x 1080p60.

If you are using 1x 4k or 2x 1080p it is not possible to use any other video inputs on the unit due to hardware limitations.

## Back-Plate Layout



*Diagram of Video Capture BNC connections on rear of unit*

**Please note:** Live Video input inherently introduces frame latency during playback. Please contact [Support](#) for guidance on performance standards.

# Audio input and output

The & gx 2c4x2pro is equipped with a broadcast quality pro audio card which uses the latest 192kHz AD and DA converters.

## Back panel connections

- XLR Left + Right Input
- XLR Left + Right Output
- ADAT/SPDIF Input
- ADAT/SPDIF Output
- MIDI Input
- MIDI Output

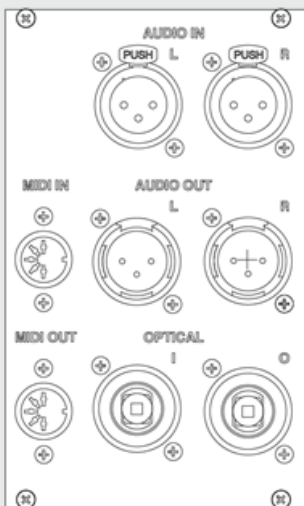

## Front panel connections

- 1/4inch Stereo Monitoring socket

It is possible to monitor audio output from the unit from the 1/4inch stereo socket with a pair of headphones.

## RME card settings

1. Go to the Windows Start Menu.
2. Right click on the speaker in the task tray next to the clock on the desktop and click on Playback Devices.
3. Scroll Down and Right-click the device named Speakers and select Set as Default device if it is not already selected.

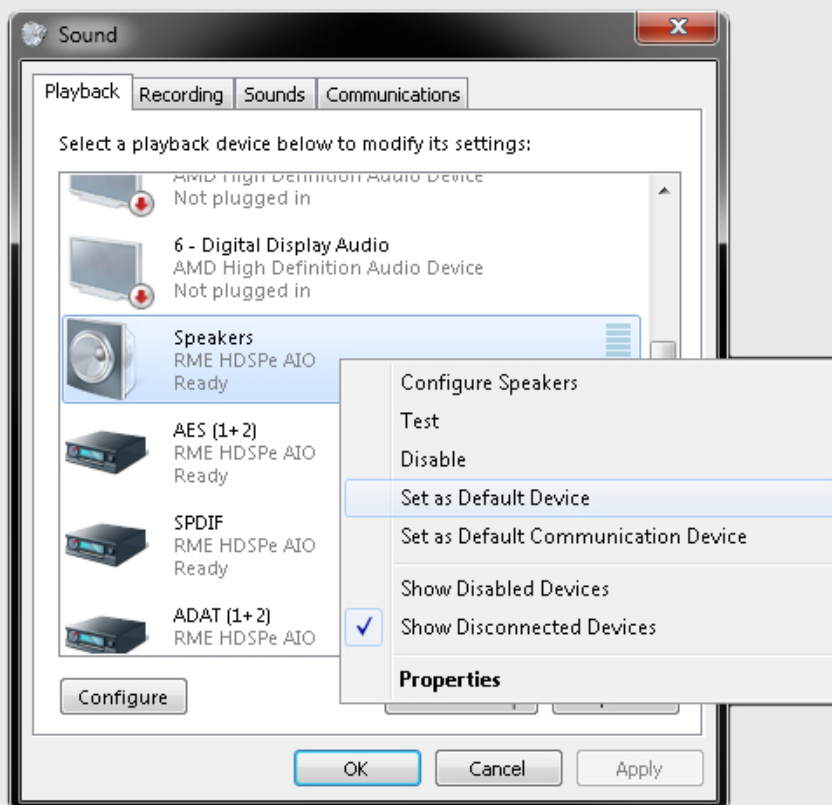

# 4x4pro overview



**Warning: Opening hardware may void your warranty. Consult Disguise support before opening the hardware.**



**Warning: do not open or remove the case unless you are instructed to do so by a certified Disguise Engineer**

**Please note: If you experience any problems with hardware please contact the [support team](#)**

The machines come pre-installed with the latest software version, enabling you to design, configure and sequence the show on the same machines as you later use for show playback.

For detailed information on the specifications for each plus and pro machine, as well as the other software and hardware bundles offered by Disguise, please see the products section of our web site.

## 4x4pro

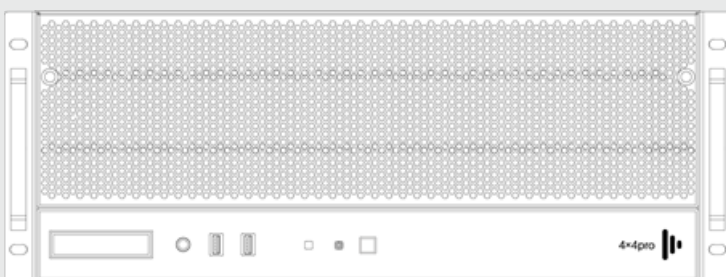

*4x4pro front panel*

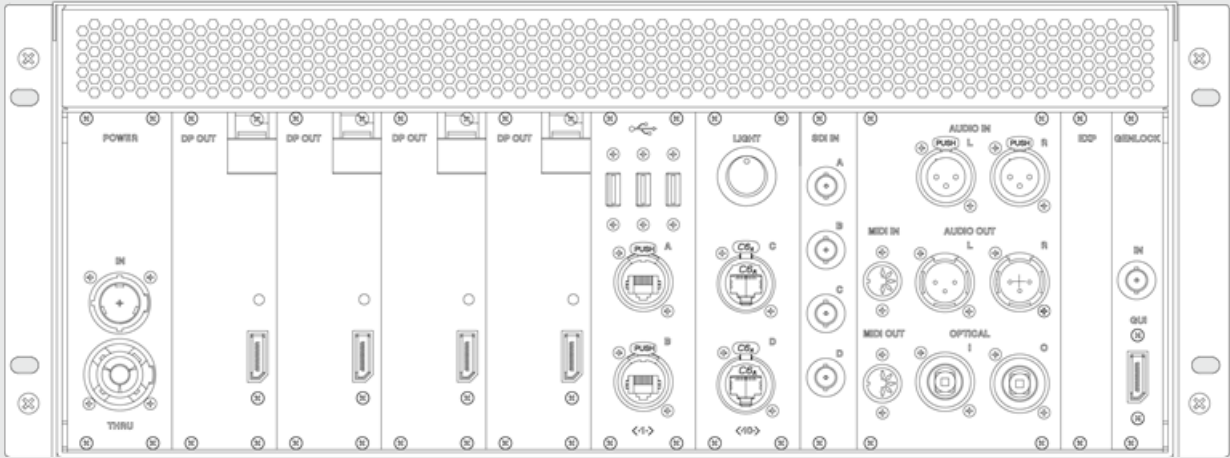

4x4pro rear panel

vx 4+ rear panel annotated



# 4x4pro diagrams

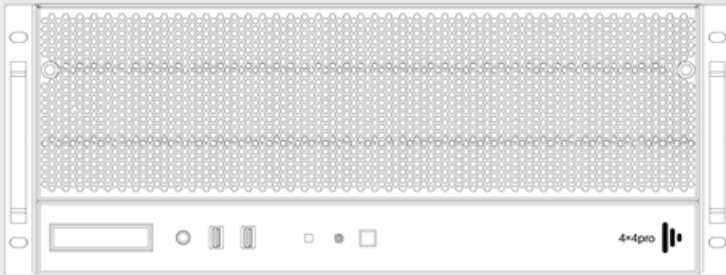

4x4pro front panel

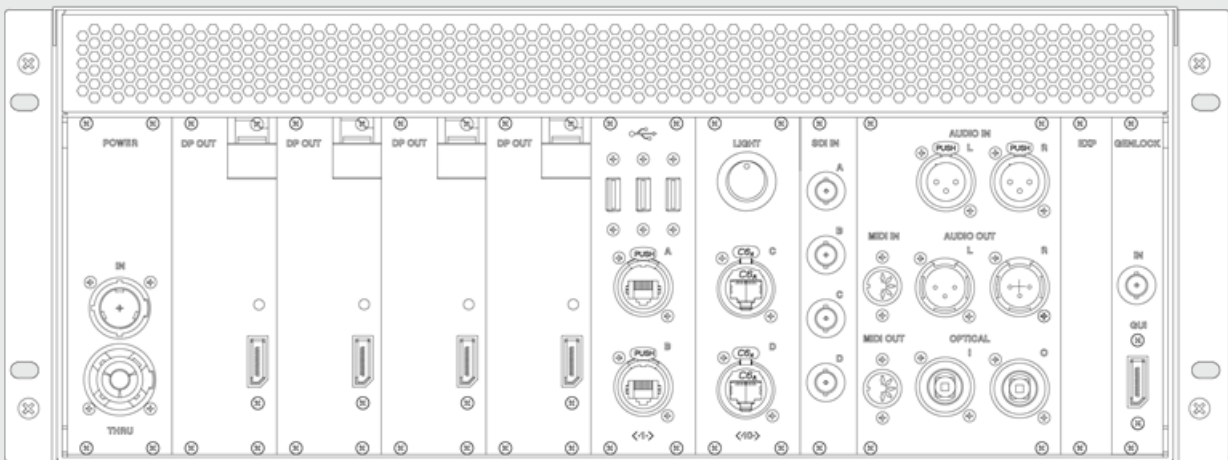

4x4pro rear panel

vx 4+ rear panel annotated

# 4x4pro Performance

## Playback

The following table shows how many layers can simultaneously be played back per codec:

Video Codec	Content Data Rate	Max Layers
HD HAP	27.8 MB/s	43
HD HAPQ	31.3 MB/s	40
HD Animation	107 MB/s	16
HD TIFF Sequence	237 MB/s	8
HD NotchLC	65.31 MB/s	23
UHD HAP	95.4 MB/s	18
UHD HAPQ	143 MB/s	12
UHD Animation	697 MB/s	2
UHD TIFF Sequence	949 MB/s	2
UHD NotchLC	233.91 MB/s	8

### NOTES:

- All content is 30 fps
- Readings are taken from an Actor
- VFC-compatible machines run with pass-through style cards (HDMI or DP)
- 60Hz project
- Genlock on all machines which support it
- One unique video file per layer, all mapped onto one screen
- Absolute maximum level of performance
- One more layer means the system starts to drop frames
- Measured against 15.3.2, build 57746

# Capture Latency

The following table provides data on how many frames of latency the 4x4pro requires from capture to output:

## 4x4pro SDI

Refresh Rate	Normal mode (frames)	Low Latency mode (frames)	Ultra-Low Latency (frames)
60Hz	4-5	4	3
50Hz	4-5	4	3
30Hz	4-5	4	3

## 4x4pro NDI

Refresh Rate	Normal mode (frames)	Low Latency mode (frames)	Ultra-Low Latency (frames)
60Hz	5-6	5	4
50Hz	5-6	5	4
30Hz	5-6	5-6	4

# Powering the 4x4pro

The pro and gx ranges of disguise servers use Neutrik powerCON TRUE1 as the power input. The TRUE1 is:

- Lockable
- Live-Mating (safely)
- Extendable
- Dust and water resistant according to IP65 in mated condition

To power a server, you should use a cable with the following attributes:

- SJT flexible cord, min. 12AWG, min. 300V, min. 60v dm;C, max 4.5 m long
- One end terminated with NEMA 5-15P/BS 1363/CEE 7 plug
- Other end terminated with appliance coupler type Neutrik AG, type NAC3FX

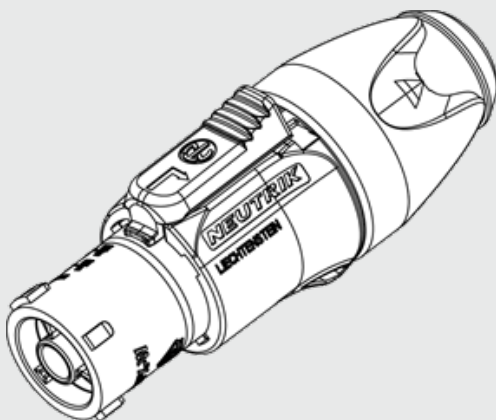

*Neutrik powerCON TRUE1 connector*

# Powering a multi server system

The 4x4pro uses True1 Powercon as its power input and features a loop through to make powering a multi server system more efficient.

The power input to the machine is rated at 12Amps RMS per connection in Europe and USA.

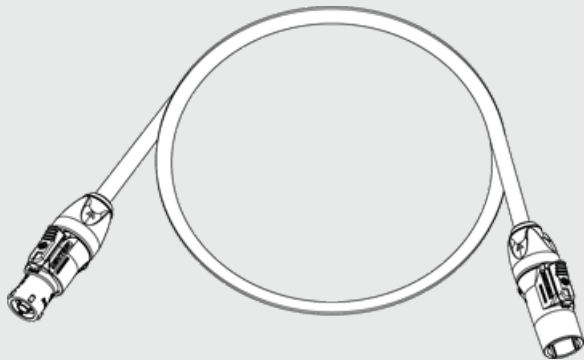

Loop through cables should have the following attributes:

- SJT flexible cord, min. 12AWG, min. 300V, min. 60v dm;C, max 4.5 m long
- One end terminated with appliance coupler type Neutrik AG, type NAC3MX-W
- Other end terminated with appliance coupler type Neutrik AG, type NAC3FX

## Power calculations for a safely powered system

It is important that you calculate how many pro range units you can daisy chain together using the in/loop connections provided. Failure to do so could result in a loss of power to the Disguise system.

Use the formula "Power = Voltage x Current" to calculate how many units you can chain together. For Example:

UK Power: 230V 13Amp rated supply.

For example, max power draw of a 4x4pro = 1400W (check technical specifications for your unit).

Available Power = 230V x 12A

Available Power = 2990W

Available Power / Max Power Draw = Number of Units

2990W / 1400W = 2.1 Units



**Warning:** Be safe! On a UK 13Amp supply @230V you can connect 2 Units safely with 100W of headroom

# How to start the unit

1. Connect Power cord to the gx 1gx 2gx 2c 4x4pro
2. Make sure you have connected a keyboard, mouse and monitor to the primary graphics output.
3. Press the power button on the front of the unit and wait for the system to load into Windows.

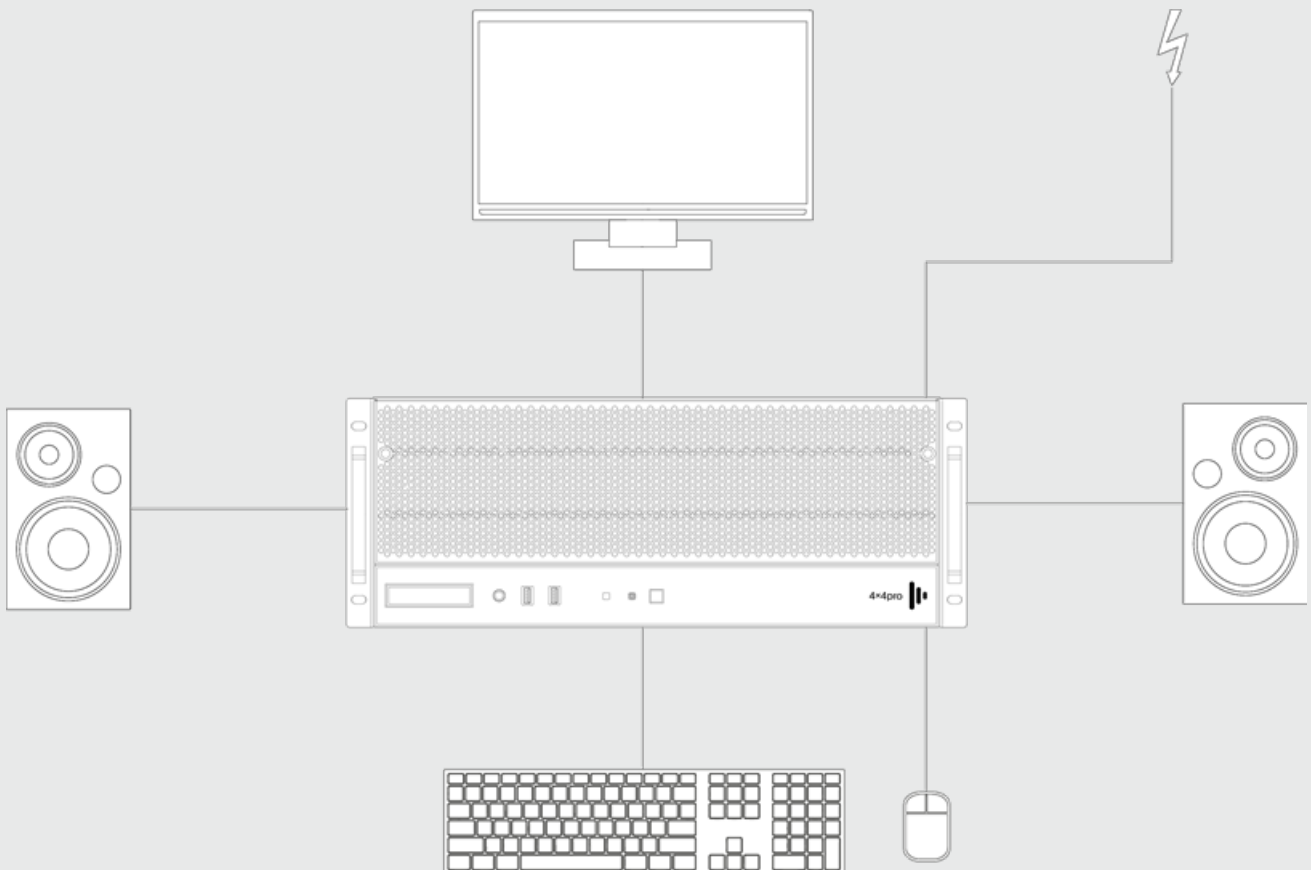

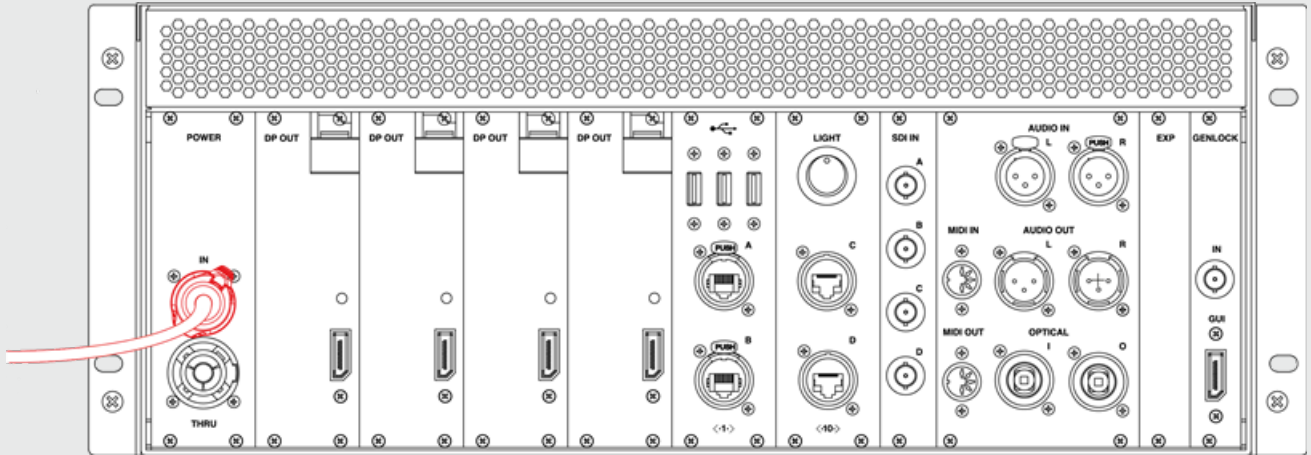

Location of power input on rear of 4x4pro unit



# Unit rear light

Disguise servers in the pro and gx ranges come with the addition of an LED light on the back of the unit that illuminates the connections on the rear panel.

The light can be turned on or off using the switch labeled "light" with power in.

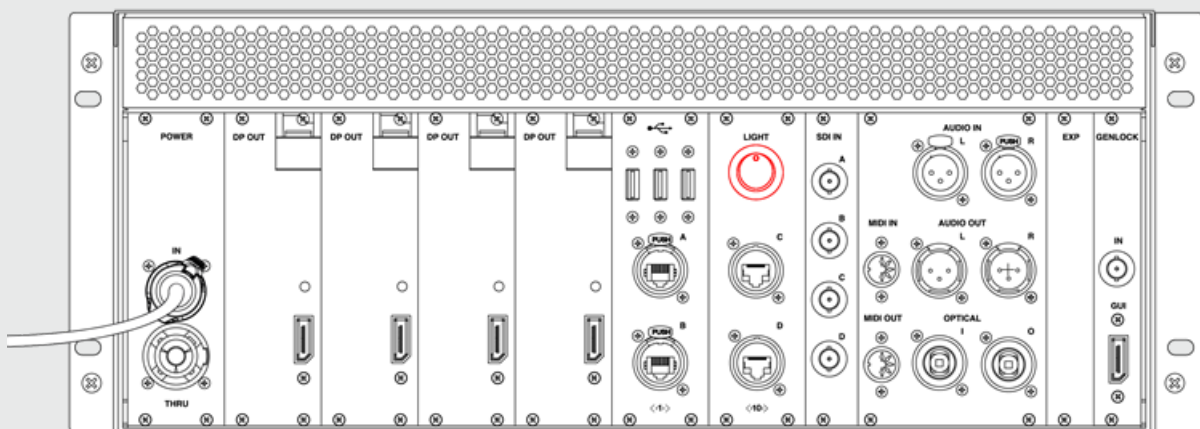

*Location of light switch on rear of a 4x4pro*

# Update System - 4x4pro

The processes for restoring and reimaging a 4x4pro server

## Overview

Internal system restore is the process of doing a factory restore on the system.

REDISGUISE is the process of doing an update or restore on the system using a bootable USB drive.

Neither of these restore processes affects the media drive of the server.

## Internal Restore

**Please note:** This procedure will only work with OS version 10 and greater.

To locate your OS version please go to **d3manager- Help - About d3manager**.

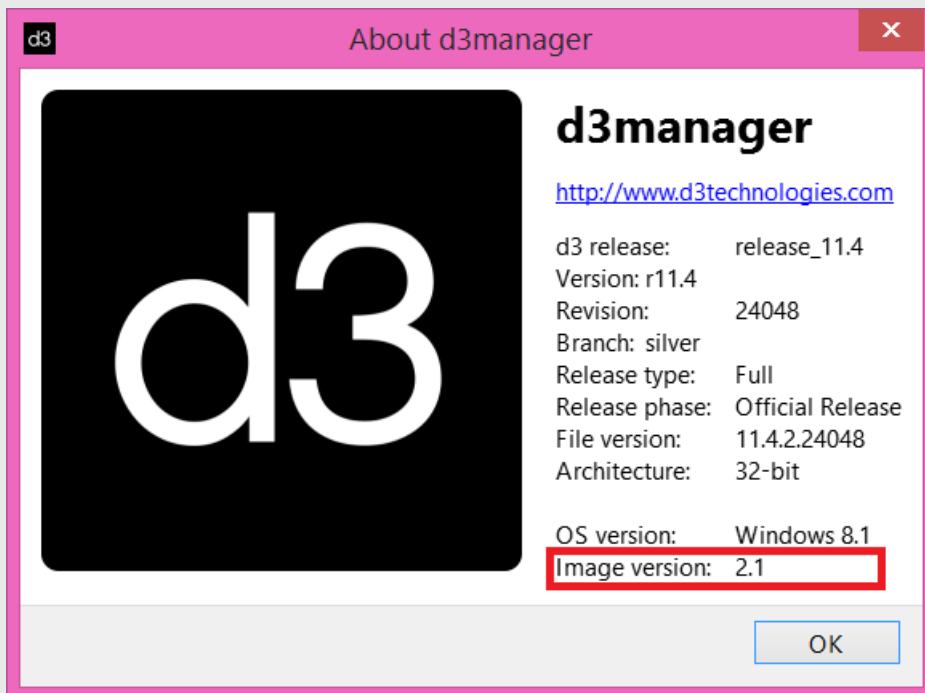



**Warning:** The system needs to be connected to the internet during this procedure. If it is not, or it loses internet connection during the process - windows activation will fail.

## Re-imaging the system

1. Hold down **shift** whilst restarting the system.

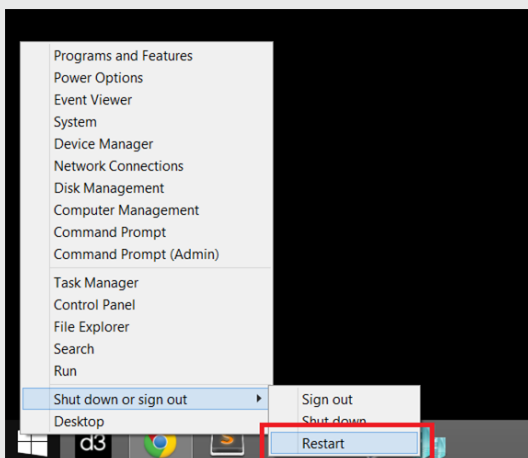

2. Select **Use another operating system**

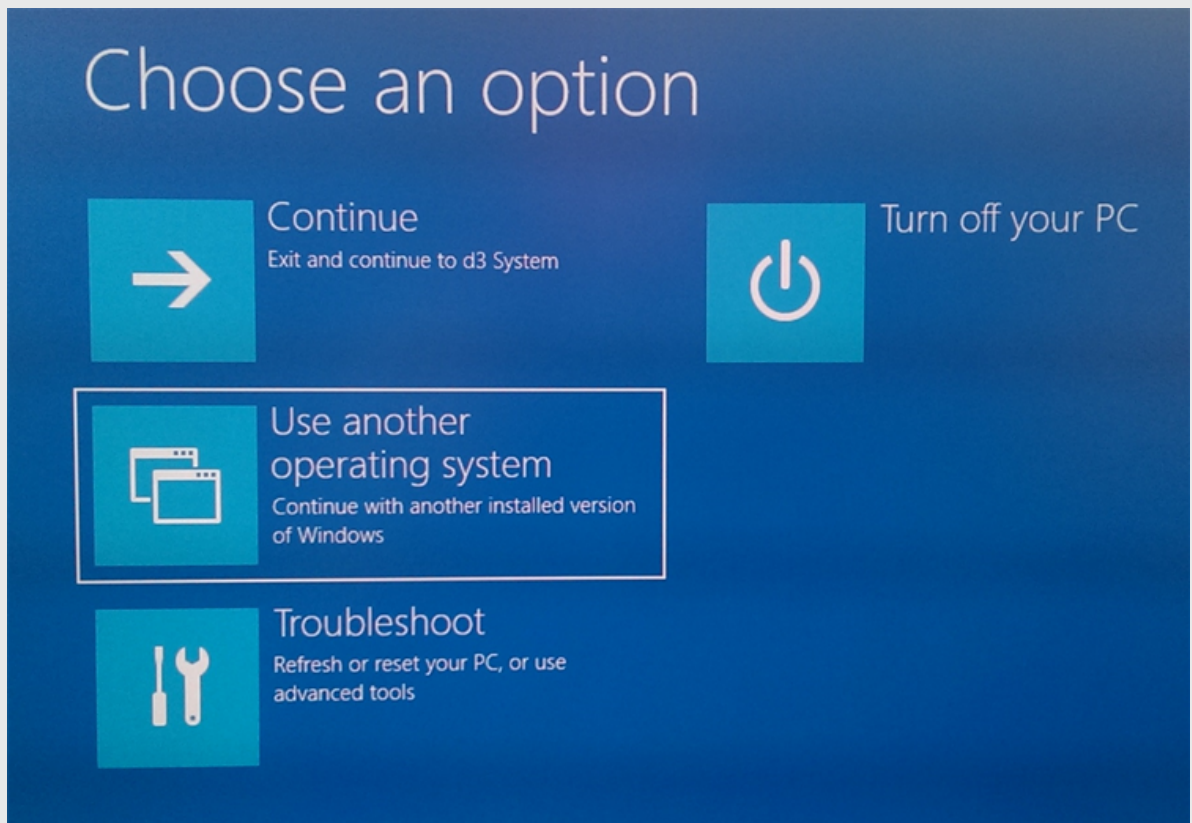

3. Select **Reset OS**.

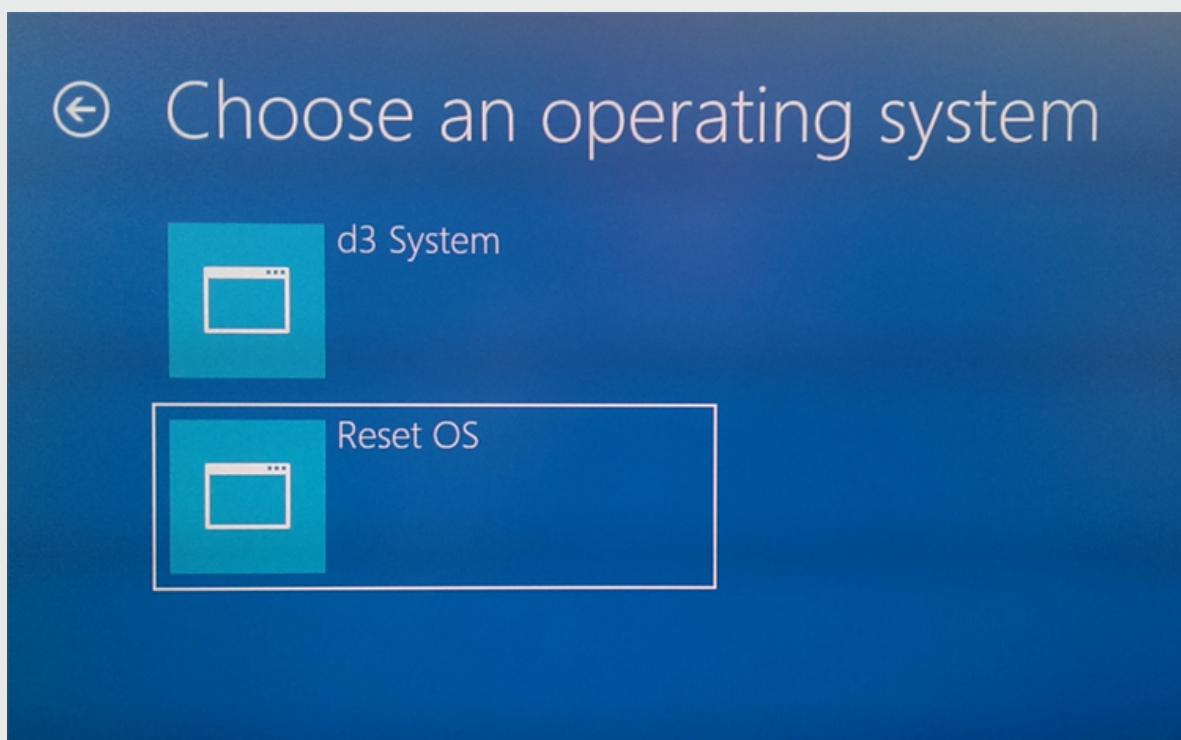

4. The system will reboot into the internal re-imaging system which will reinstall the Operating System and revert settings to factory

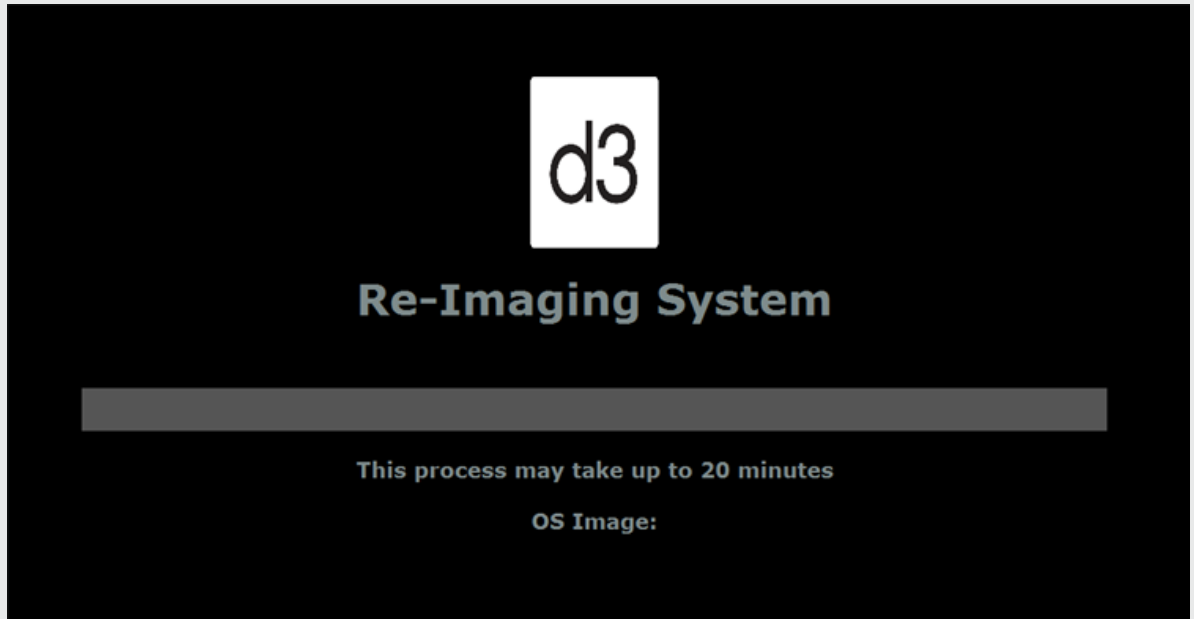

## Activating windows

Windows should activate automatically, as long as the machine was connected to the internet for the duration of the re-imaging process.

If windows does not activate during the re-imaging process, follow these steps.

1. Wait for a few minutes after the re-imaging process has completed to allow the server time to activate Windows.

2. Navigate to the System tab by right clicking on the Windows start menu and selecting **System**

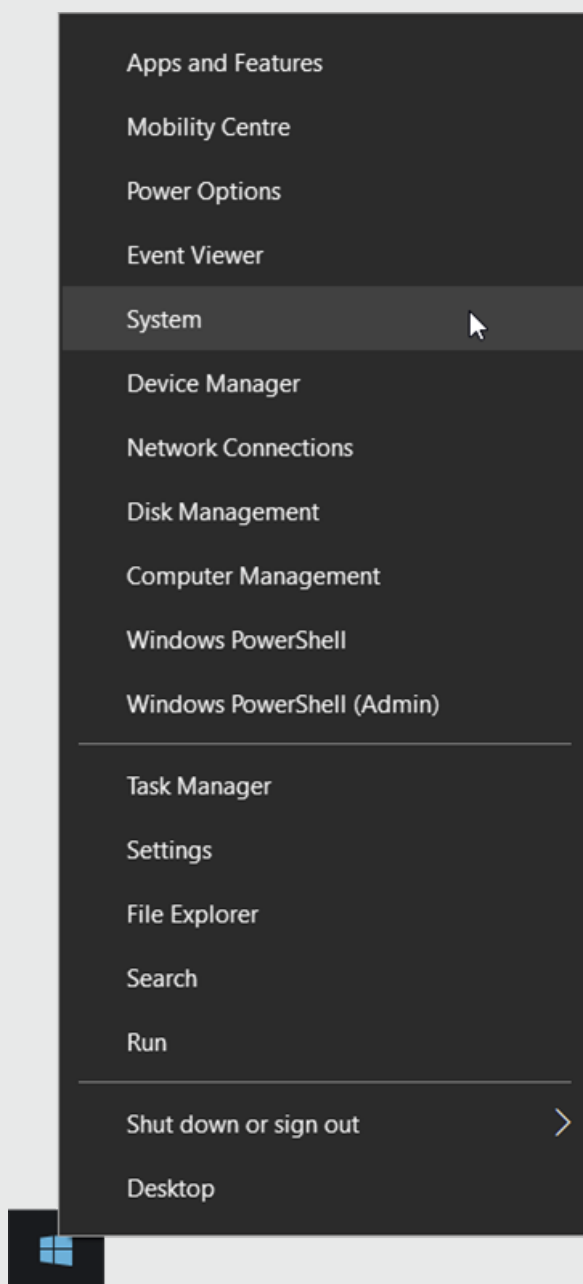

3. In the System window, check to see if you have valid Windows license information visible. If you do not, contact the [disguise support team](#).

# REDISGUISE

**Please note:** If you experience any problems during updating or restoring the system, or any of these instructions are unclear, please contact the [support team](#).



**Warning:** The system needs to be connected to the internet during this procedure

This process can be used to update to a newer OS image, or revert to a previous OS image.

To tell what OS image your system is on please go to the help menu in [d3manager](#) and select **About d3manageranager**.

**Please note:** If you are updating from  $\leq 3.0$  your system will do a cold reboot as it performs firmware level updates to some of the components. Please don't be alarmed, just switch the system back on again using the power button

## You will need

- A 32Gb USB memory stick
- A version of [Rufus](#) to turn it into a bootable disk. Make sure the volume name of the USB is: "REDISGUISE" as per image
- An internet connection to the machine you are re-imaging
- Download and install a version of [7Zip](#)
- Download and unzip the multi file archive using 7Zip
- OS images can be found [here](#).



**Please note:** You do not need to extract all parts individually. Simply place them in the same directory and then use 7zip to extract the ISO by selecting any part. 7zip will automatically unzip all parts to create the image file.

## Create Bootable USB device

1. Download and unzip the multi-file archive using 7Zip (NOTE: you will only need to unzip file 001):

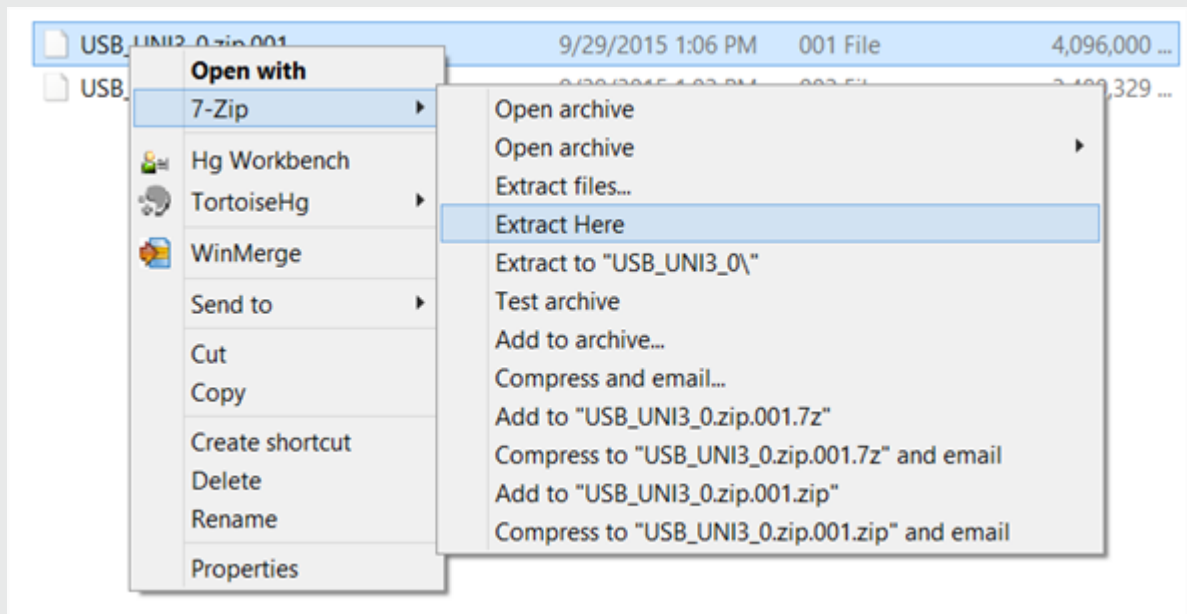

2. Create Bootable USB stick with the unzipped ISO.

The settings should be:

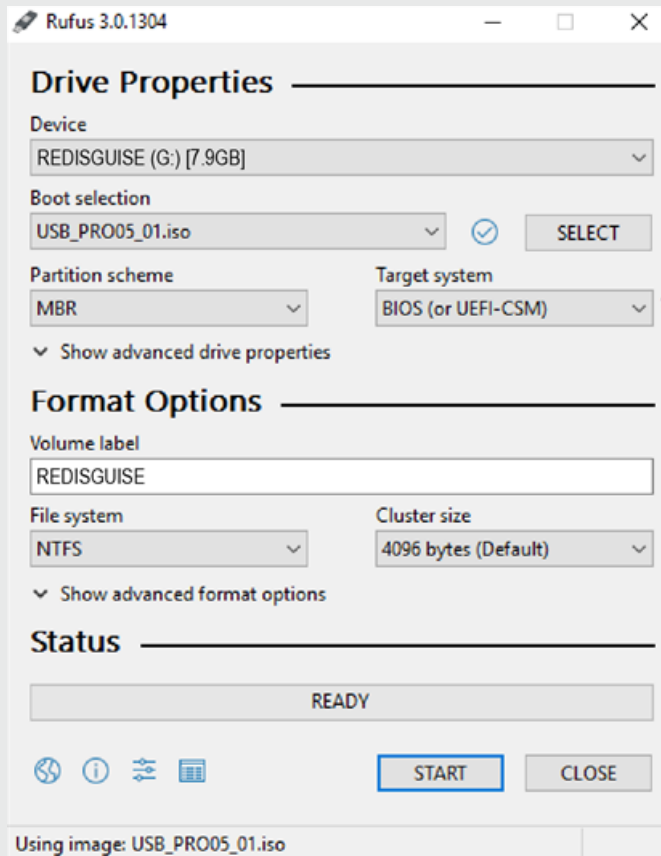

- Partition scheme - MBR
- Target system - BIOS (or UEFI-CSM)
- Volume label - automatically pulled from ISO file
- File system - NTFS



**Warning:** These settings are critically important. The re-image process will fail if they are not set correctly.

**Please note:** On the latest versions of Rufus you may see this warning. This is expected and does not apply to current disguise hardware. Please click **OK** to continue as normal.

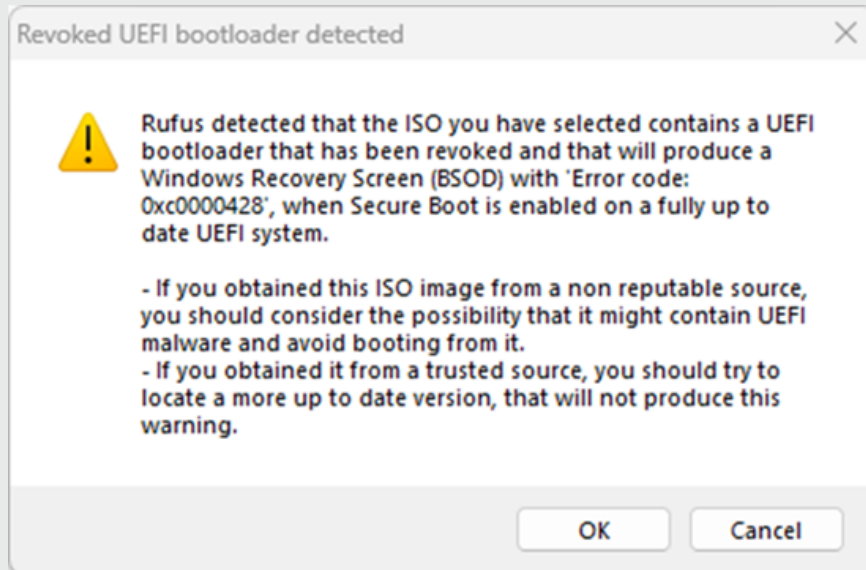

## Booting into the USB

1. Insert the USB Device into the USB2.0 (white) port on the back of the system.
2. Plug a keyboard into the other USB2.0 (white) port.
3. Invoke boot options whilst your Pro Range system is booting by pressing the **F11** key on the BIOS splash screen.
4. Highlight your USB key from the menu and press the **Enter** key. Normally it is listed as the name of the Vendor of the USB key.
5. Please be aware of the "**Press any key to boot from USB**" message as this will disappear quickly if you are running a version of Rufus prior to v3. After this message appears, you will need to press **Enter** once to boot into the USB and the re-imaging process will commence. This should

take around 20 minutes to complete and will include three system restarts which will be part of the automated process.

6. The system will boot up in a Windows in-activated state. Wait 20-30 seconds for Microsoft's servers to successfully authorise the system. With a mouse connected to any of the USB ports right-click on the start icon on the task bar and select system. This will prompt the system to update its activation state.
7. You can download the latest version of the disguise software from [here](#) and you will be good to go!

**Please note:** performing a system restore from the new disk image will erase any valuable data on your system drive. Please ensure you make a back up of any essential files from your system (C:) drive before initialising this process. The process does NOT destroy any media or projects on your media drive.

# Creating a RAID array

1. On the Logical tab, right-click on the highlighted area and select **Create Virtual Drive**.

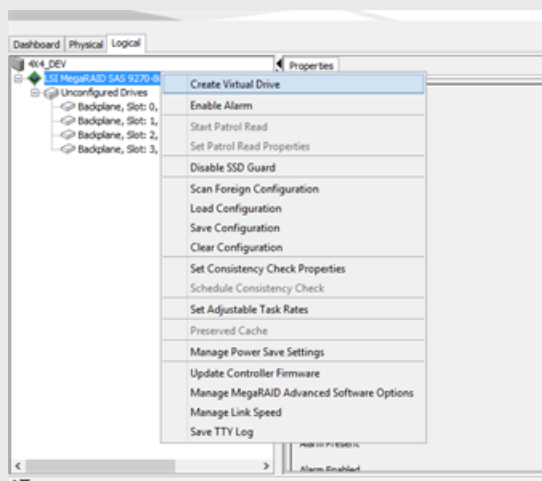

2. Select **Advanced** before moving through the wizard.

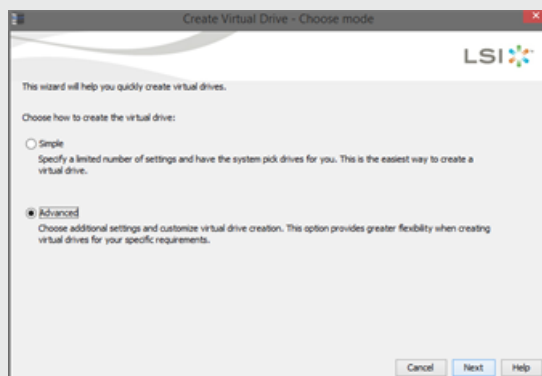

3. Select **Create Drive Group** and add the drives from the left table to the right table to be within the drive group.



4. Ensure all settings match what is within the image and then **Create Virtual Drive**.

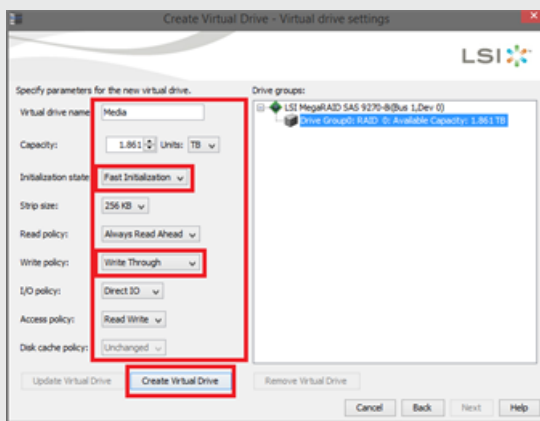

5. Your Virtual Drive should now be completed with the following popup.

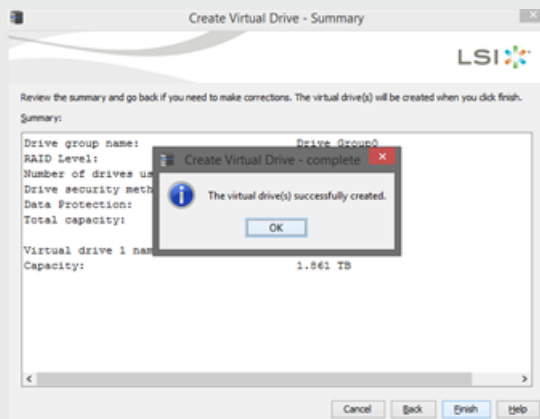

# Hard drive configuration



**Warning:** Do not remove drives when the machine is on as data may be corrupted if this occurs.

**Please note:** If you ever need to replace or exchange your media drive it is recommended that you use a drive with similar read/write speeds. For further information please contact the [support team](#).

## Media drives

The 4x4pro comes with 4x SSD drives.

These drives are removable from the drive bay. It is possible to user-reconfigure the RAID configuration using software in Windows to control the dedicated RAID controller hardware.

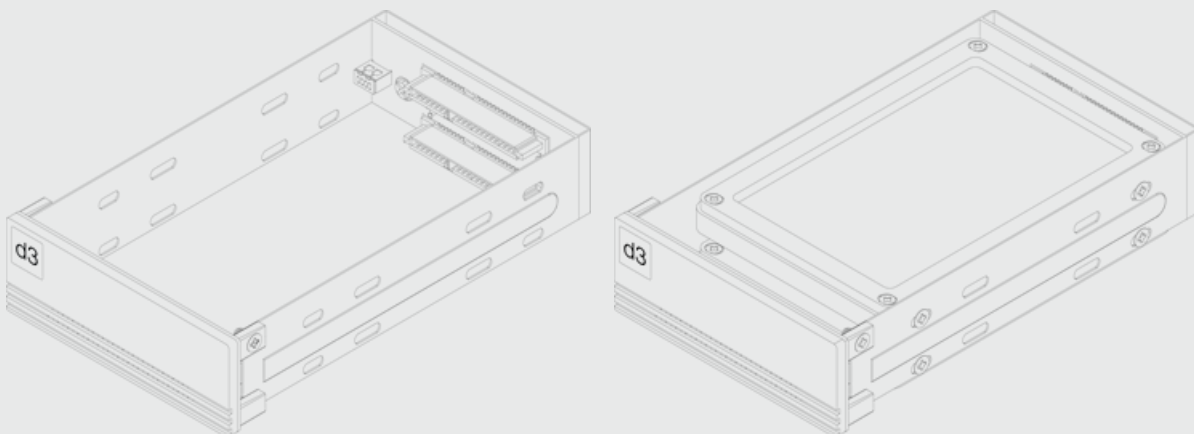

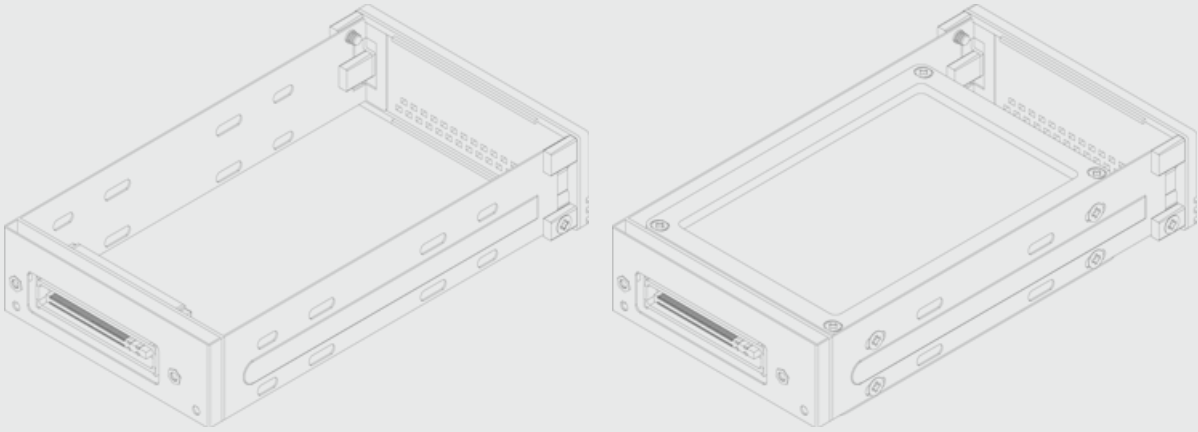

Caddy interior diagrams without SSD drives (left) and with SSD drives (right)

Each caddy contains two SSD drives. Caddys are configured as RAID0.

To reveal the drive bay undo the two thumb screws on the front of the unit. See diagrams below.

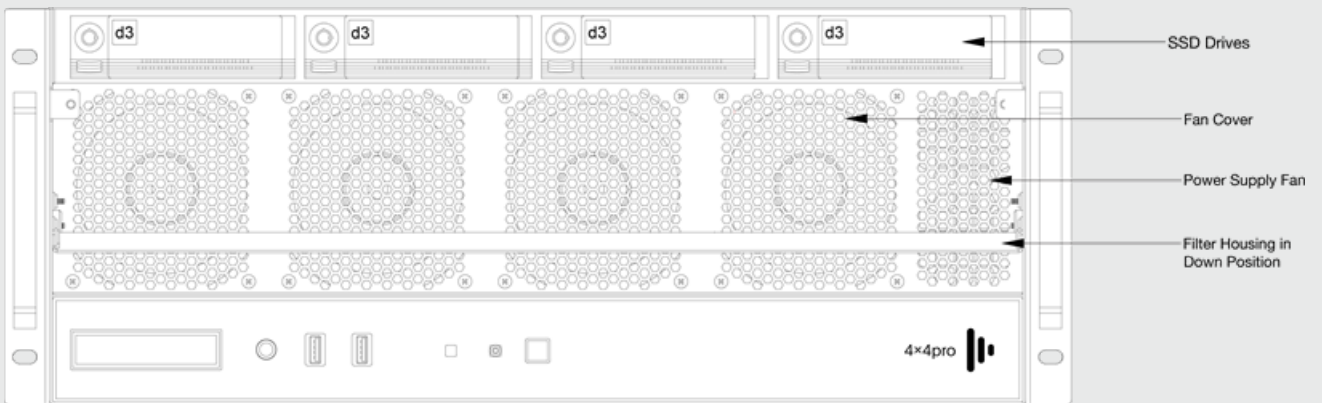
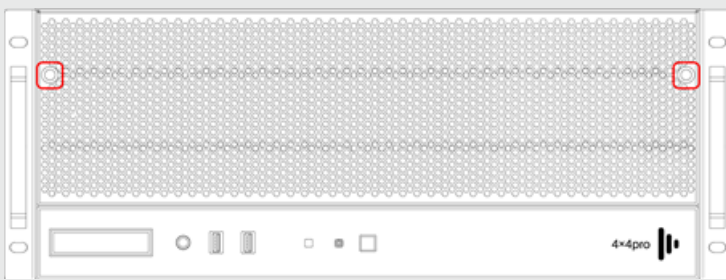

Location of thumbscrews on front of unit (top) and drive bay reveal (bottom)



# Importing RAID from different system

If you transfer configured disks from one system to another you may encounter a configuration similar to what you can see here.

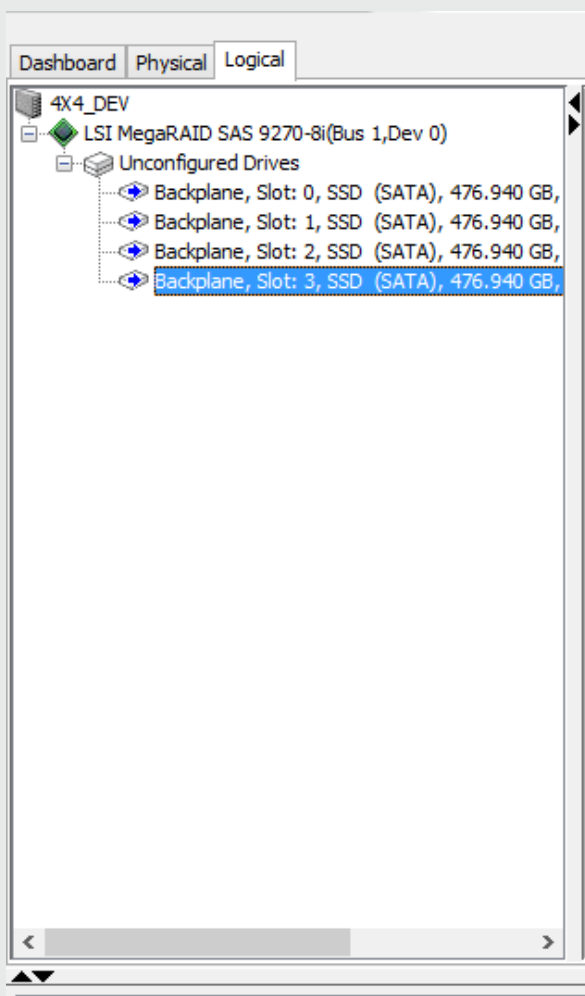

# Importing a RAID

1. Navigate to the **Logical** tab, where you should see your unconfirmed drives.

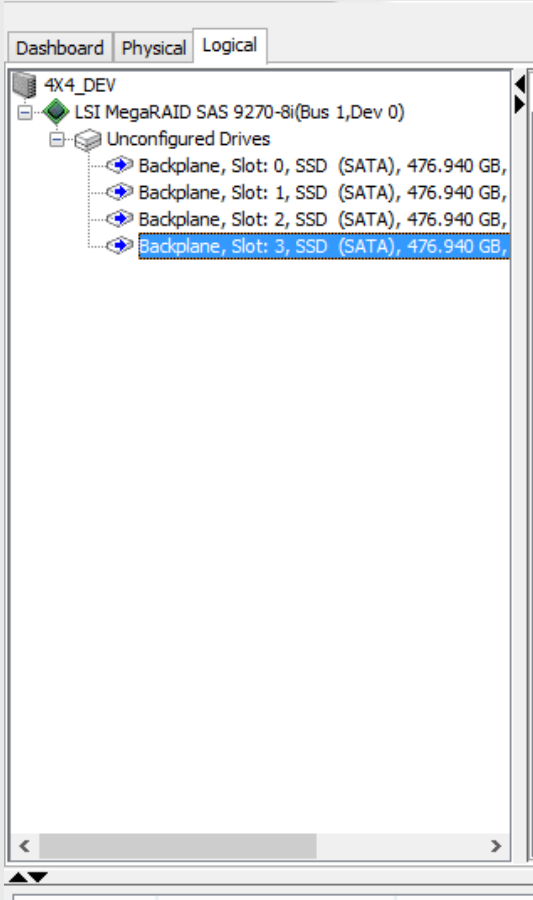

2. Right click on the highlighted Megaraid root and select **Scan Foreign Configuration**.

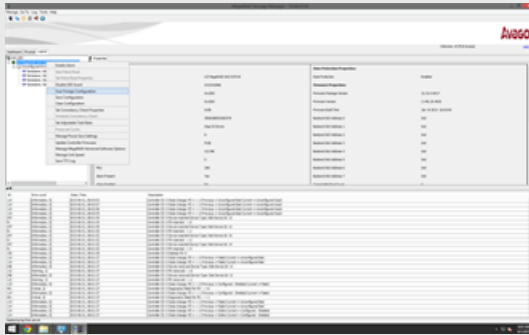

3. Select **Import** from the options presented.



4. Left click on the **Accept** button in the bottom right corner of the dialog.



5. Click **Yes** when prompted by the import dialog.

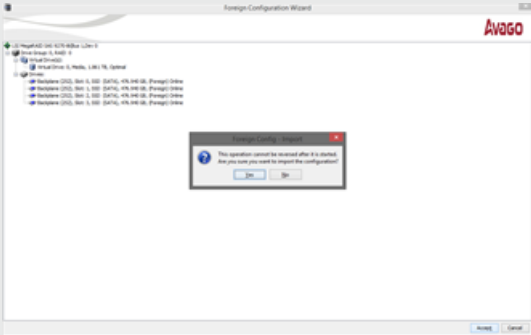

6. Click **OK** to complete the import process.

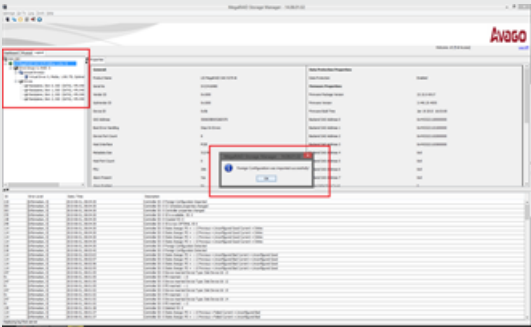

# Raid Controller

Login:

Double click the computer in the LSI MSM discovery menu

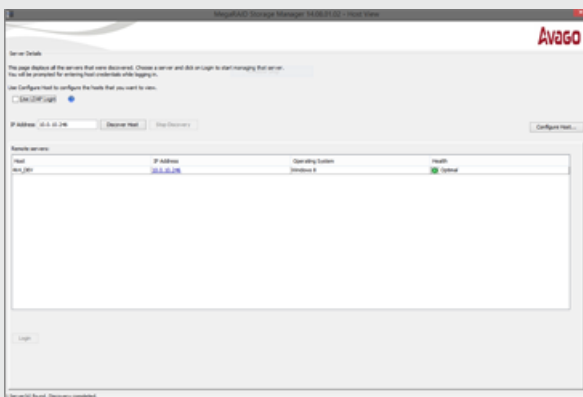

Login with "d3" as username and no password

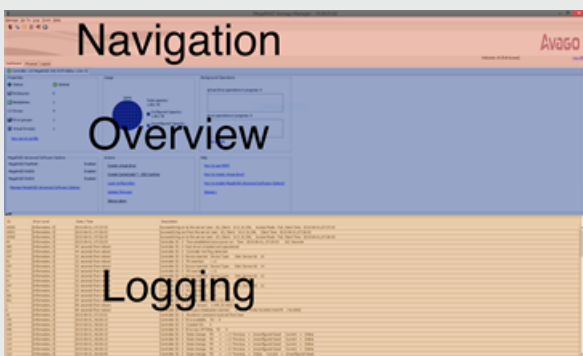
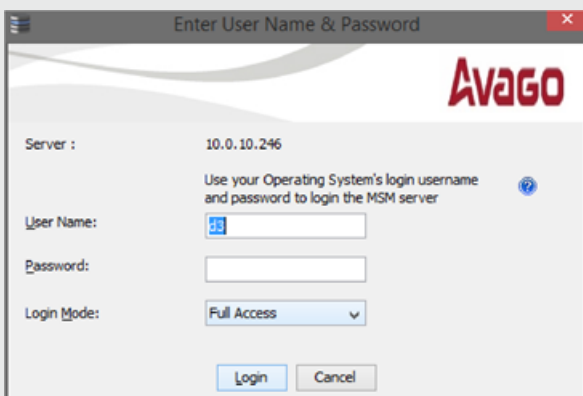

**Please note:** for Advanced RAID controller information, please see [here](#).

# Advanced RAID Controller Information

## MegaRaid LSI Controller



Please Note: Disguise uses Raid0 to provide faster streaming access to content. There is no content backup provided by Raid0.

The MegaRAID Storage Manager software enables you to configure, monitor, and maintain storage configurations on LSI SAS controllers such as those installed in your Disguise system.

The MegaRAID Storage Manager software enables you to easily configure the controllers, drives, and virtual drives on your Disguise server.

The Configuration wizard greatly simplifies the process of creating drive groups and virtual drives. The wizard allows you to easily create new storage configurations and modify configurations.

You must have administrative privileges to use the MegaRAID Storage Manager software in either full-access or in view-only mode.

To start the MegaRAID Storage Manager software double-click on the desktop icon.

This will open the following window:

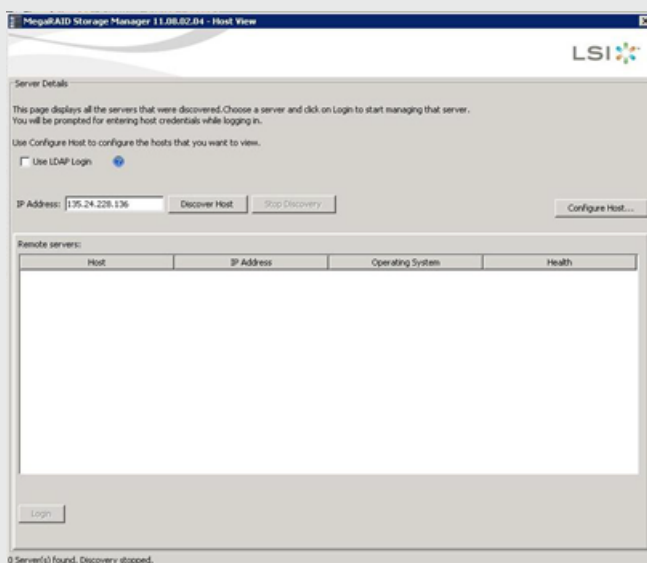

The Host View dialog shows an icon for each server on which the MegaRAID Storage Manager software is installed.

The servers are colour-coded with the following definitions:

- Green: The server is operating properly
- Yellow: The server is running in a partially degraded state (possibly because a drive in a virtual drive has failed)
- Orange: The server is running in a degraded state
- Red: The server storage configuration has failed

Next you will see a login screen:



Enter **d3** as the **User Name** and click **Login**.

This will open MegaRAID storage Manager - Host View window, as follows:

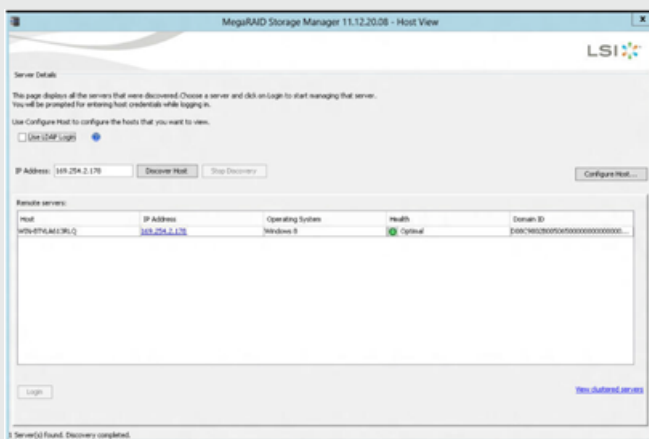

Clicking on **Configure Host** will open the main Dashboard View:



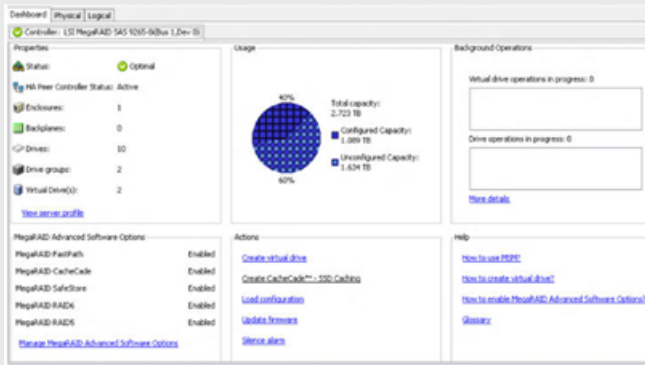

## Physical View

The Physical view shows the hierarchy of physical devices in the system. At the top of the hierarchy is the system itself, followed by the controller and the backplane. The controller label identifies the MegaRAID controller, such as the MegaRAID SAS 9260-8i controller, so that you can easily differentiate between multiple controllers. Each controller has one or more ports. Drives and other devices are attached to the ports. The properties for each item appear in the right panel of the screen.

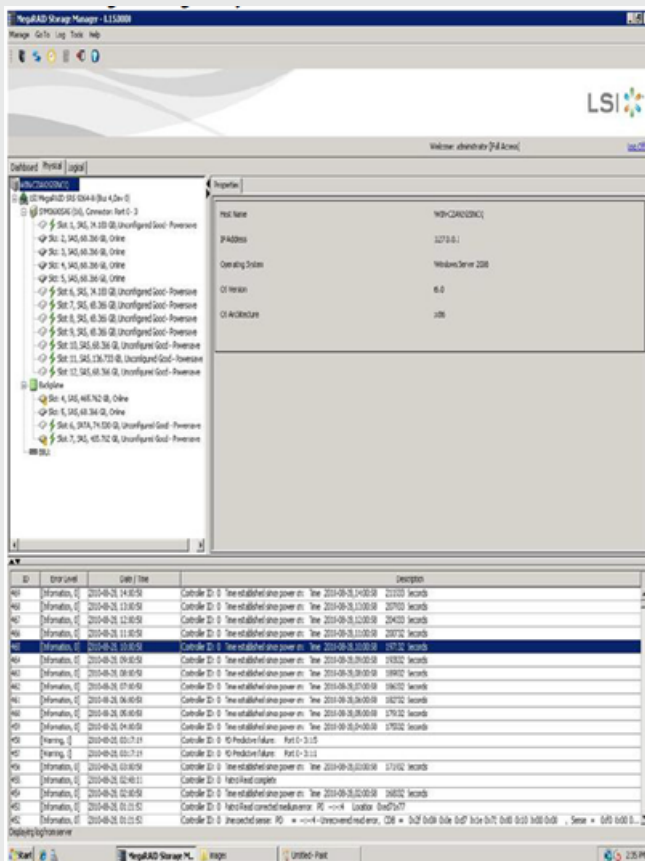

# Logical View

The Logical view shows the hierarchy of controllers, virtual drives, and the drives and drive groups that make up the virtual drives. The properties for these components appear in the right panel

The following figure shows the Logical view

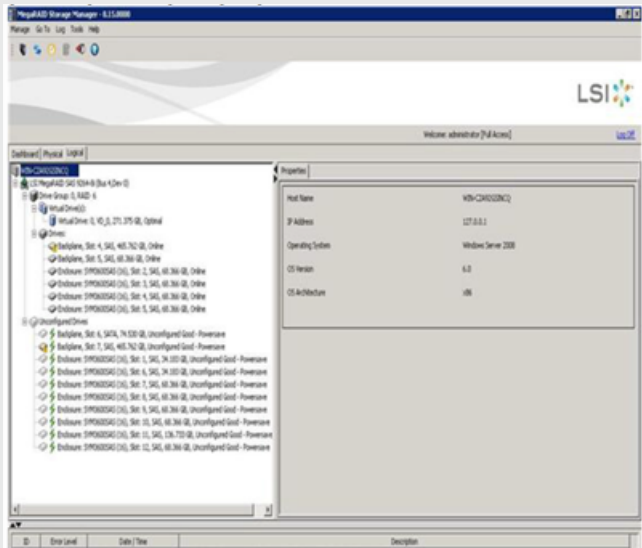

You can view the properties for individual drives from the drop down menus, as follows:

General:		Power Status	Powerware
Usable Capacity	927,500 GB	Revision Level	M006
Raw Capacity	931,513 GB	Media Error Count	0
Logical Sector Size	4 KB	Pred Fail Count	0
Physical Sector Size	4 KB	<b>Enclosure Properties:</b>	
Certified	No	Enclosure ID	252
Product ID	ST91000640SS	Enclosure Model	Backplane
Vendor ID	SEAGATE	Enclosure Location	External
Serial Number	9W0292Y	Connector	Port 4 - 7
Device ID	129	Slot Number	4
Status	Unconfigured Good	<b>Drive Security Properties:</b>	
Drive Speed	6.0 Gbps	Full Disk Encryption capable	No
Negotiated Link Speed	6.0 Gbps	Secured	No
SCSI Device Type	Disk	<b>Data Protection Properties:</b>	
SAS Address 0	0x5000C30001A3D0	Data Protection	Incapable
SAS Address 1	0x0	Shield Counter	0

# Shield State

Physical devices in MegaRAID firmware transit between different states. If firmware detects a problem or a communication loss for a physical drive, it transitions the physical drive to a bad (FAILED/UNCONF BAD) state. To avoid transient failures, an interim state called the Shield state appears before marking the physical drive as bad state. The results of the diagnostic tests determine if the physical drive is good or bad. If any of the diagnostics tests fail, the physical drive will transition to BAD state (FAILED or UNCONF BAD). The three possible Shield states are Unconfigured - Shielded, Configured - Shielded, and Hotspare - Shielded (which is not used in the d3 application).

# Shield State Physical View

Follow these steps to view the Shield state under the Physical view tab:

- Click the Physical tab in the device tree
- The red dot icon (●) indicates a Shield state
- The Physical View shield state is shown in the following fig

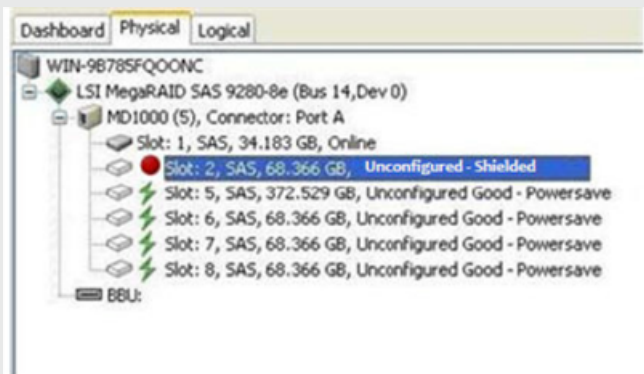

# Logical View Shield State

Follow these steps to view the Shield state under the Logical tab:

- Click the Logical tab in the device tree
- The red dot icon (●) indicates a Shield state
- The Logical view Shield state is shown in the following fig

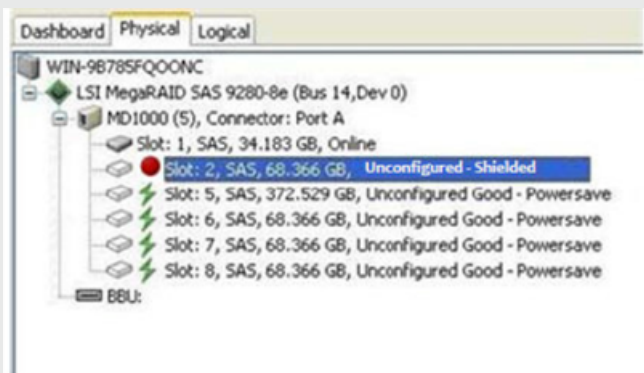

# Viewing the Physical Drive Properties





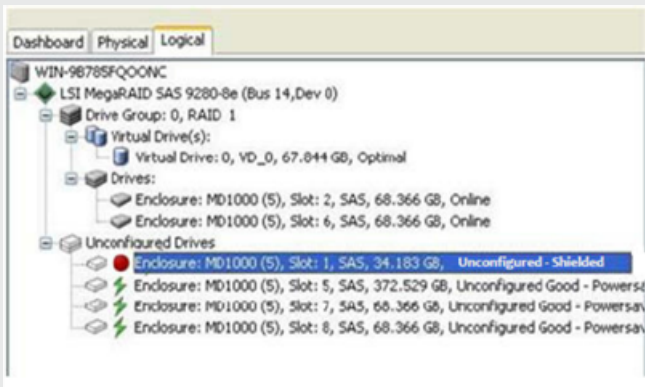





Follow these steps to view the physical properties of the drive in the Shield state:

- Click the Physical tab or Logical tab in the device tree
- The red dot icon (●) indicates a Shield state
- Click the physical drive in Shield state on Physical view or Logical view of the device tree to view the properties
- The device properties are displayed as shown in the following fig



## Device Icons

The following icons in the left panel represent the controllers, drives, and other devices.

	Status
	System
	Controller
	Backplane
	Enclosure
	Port
	Drive group
	Virtual drive
	Online drive
	Power save mode

A red circle to the right of an icon indicates that the device has failed. For example, this icon indicates that a drive has failed:

A yellow circle to the right of an icon indicates that a device is running in a partially degraded state. For example, this icon indicates that a virtual drive is running in a degraded state because a controller has failed. An orange circle to the right of an icon indicates that a device is running in a degraded state.

## Configuration

This section explains how to use MegaRAID Storage Manager software to create and modify storage configurations on LSI SAS controllers.

The LSI SAS controllers should only be configured for RAID 0 for the d3 application to work correctly.

The Configuration wizard allows you to easily create new storage configurations and modify the configurations.



Please note: You cannot create or modify a storage configuration unless you are logged on to the server with administrator privileges.

## Creating a New Configuration

You can use the MegaRAID Storage Manager software to create new storage configurations on systems with LSI SAS controllers. You can create the following types of configurations:

- Simple configuration specifies a limited number of settings and has the system select drives for you. This option is the easiest way to create a virtual drive.
- Advanced configuration lets you choose additional settings and customize virtual drive creation. This option provides greater flexibility when creating virtual drives for your specific requirements.

## Selecting Virtual Drive Settings

This section describes the virtual drive settings that you can select when you use the advanced configuration procedure to create virtual drives. You should change these parameters only if you have a specific reason for doing so.

It is usually best to leave them at their default settings.

- Initialization state: Initialization prepares the storage medium for use. Specify the initialization status
- No Initialization: (the default) The new configuration is not initialized, and the existing data on the drives is not overwritten

- **Fast Initialization:** The firmware quickly writes 0s to the first and last 8-MB regions of the new virtual drive and then completes the initialization in the background. This allows you to start writing data to the virtual drive immediately

**Full Initialization:** A complete initialization is done on the new configuration. You cannot write data to the new virtual drive until the initialization is complete. This process can take a long time if the drives are large.

## Read policy: Specify the read policy for this virtual drive:

- **Always read ahead:** Read ahead capability allows the controller to read sequentially ahead of requested data and to store the additional data in cache memory, anticipating that the data will be needed soon. This process speeds up reads for sequential data, but little improvement occurs when accessing random data.
- **No read ahead:** (the default) Disables the read ahead capability.

## Write policy: Specify the write policy for this virtual drive:

- **Write Through:** In this mode, the controller sends a data transfer completion signal to the host when the drive subsystem has received all of the data in a transaction. This option eliminates the risk of losing cached data in case of a power failure.
- **Always Write Back:** In this mode, the controller sends a data transfer completion signal to the host when the controller cache has received all of the data in a transaction.

## I/O policy: The I/O policy applies to reads on a specific virtual drive. It does not affect the read ahead cache.

- **Cached IO:** In this mode, all reads are buffered in cache memory.
- **Direct IO:** (the default) In this mode, reads are not buffered in cache memory. Data is transferred to the cache and the host concurrently. If the same data block is read again, it comes from cache memory.  
Cached IO provides faster processing, and Direct IO ensures that the cache and the host contain the same data.

## Access policy: Select the type of data access that is allowed for this virtual drive.

- **Read/Write:** (the default) Allow read/write access. This setting is the default value.
- **Read Only:** Allow read-only access.

- Blocked: Do not allow access.
- Disk cache policy: Select a cache setting for this drive:
- Enabled: Enable the disk cache.
- Disabled: (the default) Disable the disk cache.
- Unchanged: Leave the current disk cache policy unchanged.

## Creating a Virtual Drive Using Simple Configuration

Simple configuration is the quickest and easiest way to create a new storage configuration. When you select simple configuration mode, the system creates the best configuration possible using the available drives.



Please note: You cannot create spanned drives using the simple configuration procedure. To create spanned drives, use the advanced configuration.

### Follow these steps to create a new storage configuration in simple configuration mode.

- Perform either of the following steps:
- Right-click the controller node in the device tree in the left frame of the MegaRAID Storage Manager window, and select Create Virtual Drive.  
Or  
Select the controller node, and select Go To > Controller > Create Virtual Drive in the menu bar, as shown in this image.

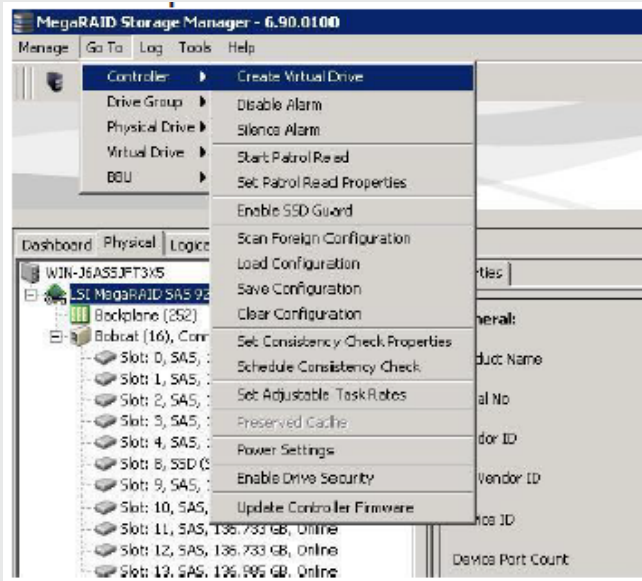

The dialog for the configuration mode (simple or advanced) appears, as shown in the following figure:-

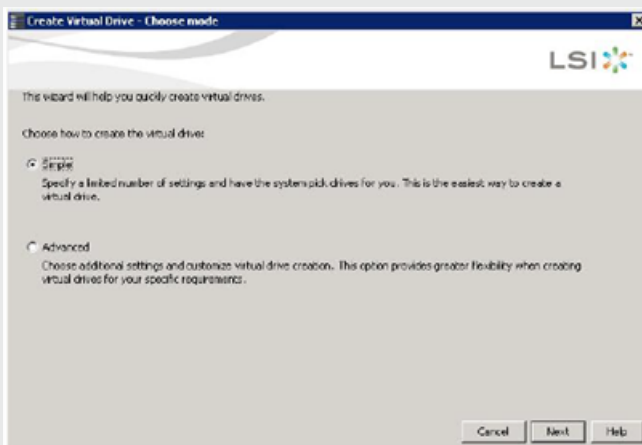

Select the Simple radio button, and click Next.

The Create Virtual Drive - Allocate capacity dialog appears, as shown in the following figure. If unconfigured drives are available, you have the option to use those unconfigured drives. If unconfigured drives are available, the Create Drive Group Settings window appears, and you can go to the next step.



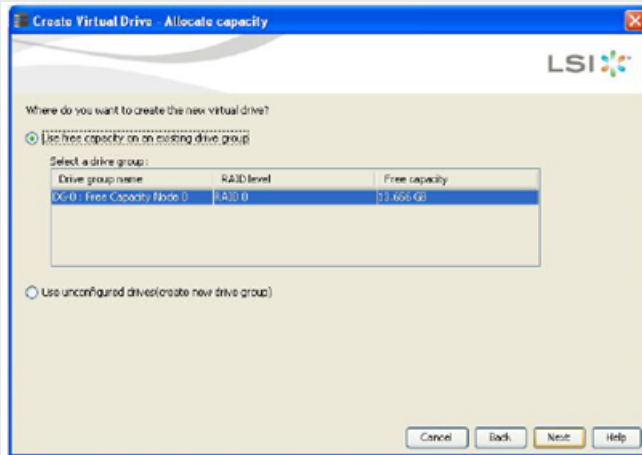



Perform either of the two options:

If a drive group exists, select the Use free capacity on an existing drive group radio button and click Next. Continue with the next step. The Create Virtual Drive window appears, as shown in the following figure.

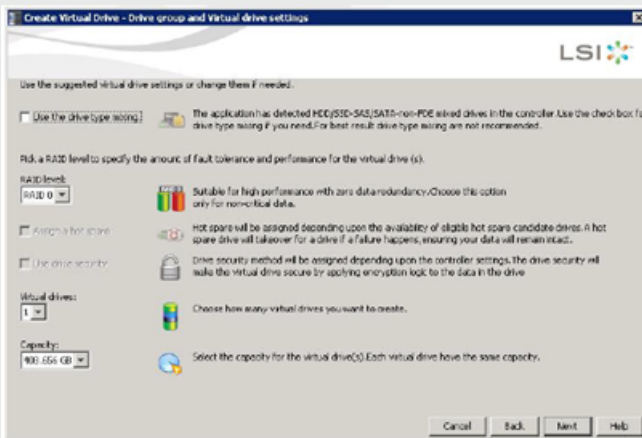
If unconfigured drives are available, select the radio button to use the unconfigured drives, and click Next. Continue with next step. The Summary window appears as shown:-



 Please note: For best results, do not use drive type mixing.

Select RAID 0 for the virtual drive.

When you use simple configuration, the RAID controller supports RAID levels 1, 5, and 6. In addition, it supports independent drives (configured as RAID 0).

 DO NOT select any other raid type than Raid 0.  
DO NOT select the Assign a hot spare check box.  
DO NOT select the Use drive security check box.

Use the drop-down list in the Virtual drives field to choose how many virtual drives you want to create.

Select the capacity of the virtual drives. Each virtual drive has the same capacity.

Click Next.

The Create Virtual Drive - Summary window appears, as shown in the following figure. This window shows the

selections you made for simple configuration:-

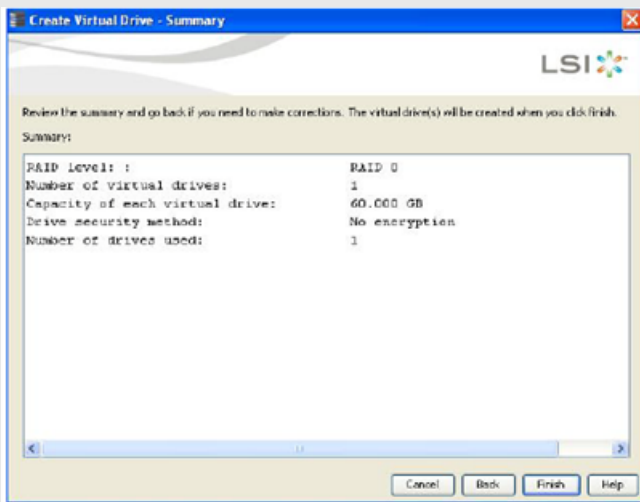

Either click Back to return to the previous window to change any selections, or click Finish to accept and complete the configuration.

The new virtual drive is created after you click Finish. After the configuration is completed, a dialog box notifies you that the virtual drives were created successfully.

## Creating a Virtual Drive Using Advanced Configuration

The advanced configuration procedure provides an easy way to create a new storage configuration. Advanced configuration gives you greater flexibility than simple configuration because you can select the drives and the virtual drive parameters when you create a virtual drive. In addition, you can use the advanced configuration procedure to create spanned drive groups.

Follow these steps to create a new storage configuration in the advanced configuration mode.

This example shows the configuration of a spanned drive group.

Perform either of the following steps to bring up the Configuration wizard:

Right-click the controller node in the device tree in the left frame of the MegaRAID Storage Manager window, and select Create Virtual Drive.

Select the controller node, and select Go To > **Controller** > **Create Virtual Drive** in the menu bar.

The dialog for the choosing the configuration mode (simple or advanced) appears, as shown in the following

figure:-

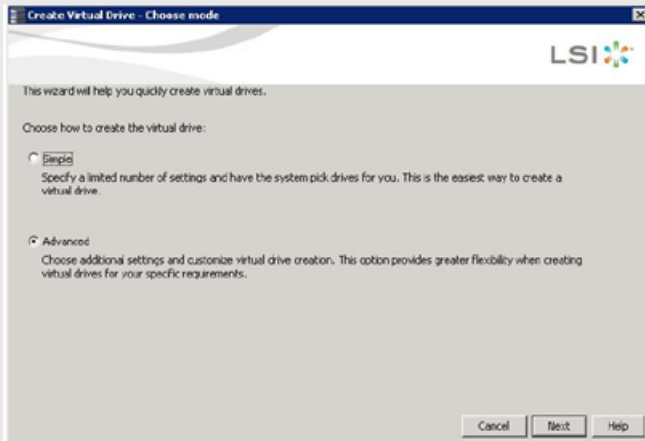

Select the Advanced radio button, and click Next.

The Create Drive Group Settings window appears, as shown in the following figure:-

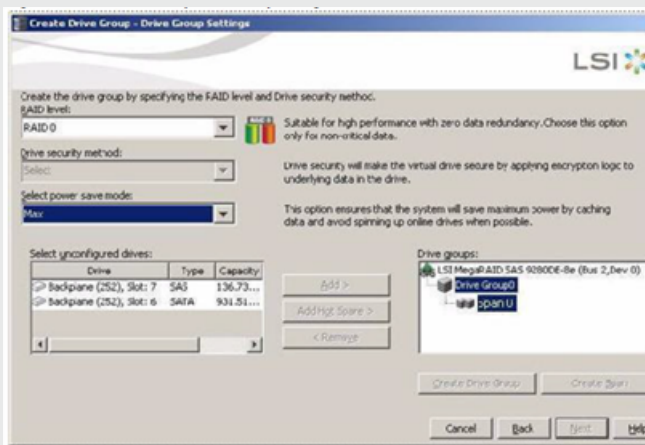

Select the following items on the Create Drive Group - Drive Group Settings window:

Select the RAID level 0.

Independent drives configured as RAID 0 are supported.



DO NOT set a drive security method.

Select unconfigured drives from the list of drives, and click **Add>** to add them to the drive group.

The selected drives appear under Span 0 below Drive Group 0, as shown in the following figure:-

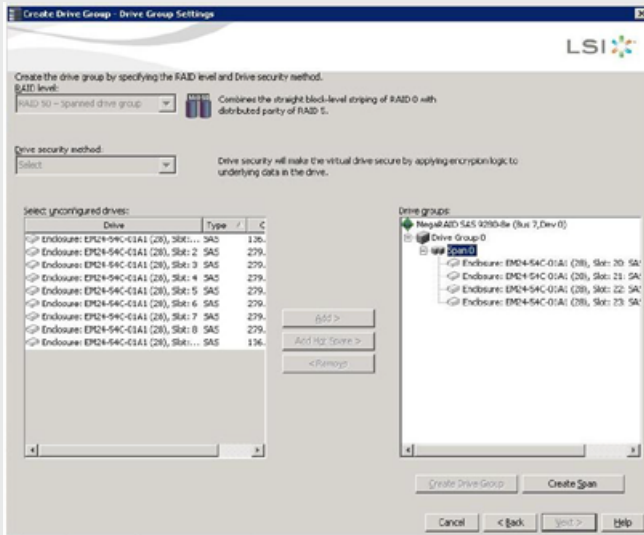

Click Create Span to create a second span in the drive group.  
 Select unconfigured drives from the list of drives, and click Add> to add them to the second drive group.  
 The selected drives appear under Span 1 below Drive Group 0, as shown in the following figure:-

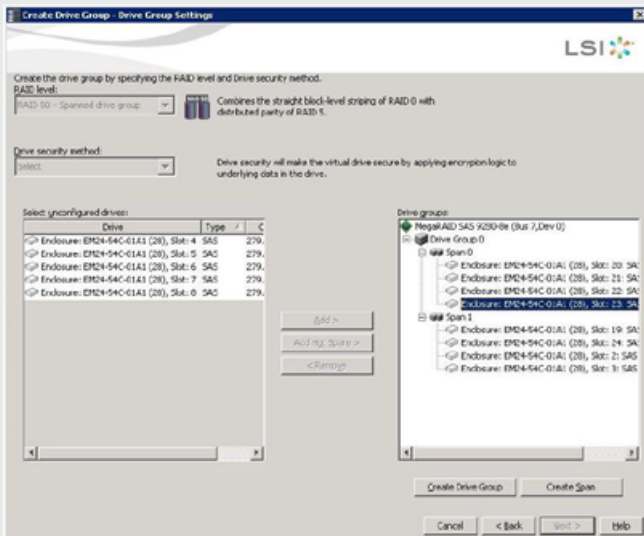

Click Create Drive Group to make a drive group with the spans.  
 Click Next to complete this step.  
 The Create Virtual Drive - Virtual drive settings window appears, as shown in the following figure. The drive group and the default virtual drive settings appear. The options to update the virtual drive or remove the virtual drive are grayed out until you create the virtual drive:

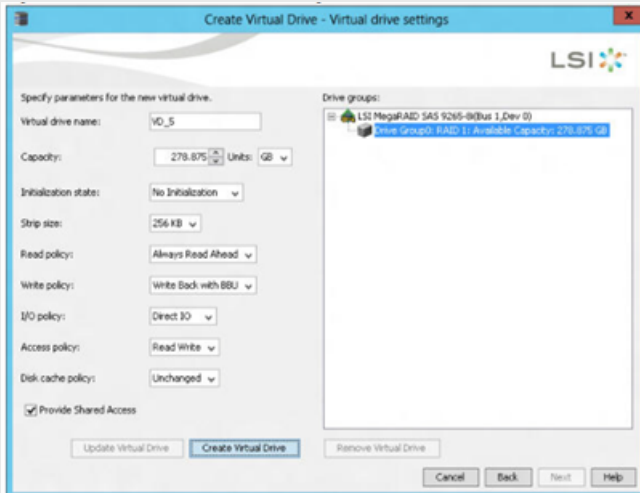

Change any virtual drive settings, if desired.

Click Create Virtual Drive.

The new virtual drive appears under the drive group. The options Update Virtual Drive and Remove Virtual Drive are available. Update Virtual Drive allows you to change the virtual drive settings, and Remove Virtual Drive allows you to delete the virtual drive.

Click Next.

The Create Virtual Drive - Summary window appears, as shown in the following figure. This window shows the selections you made for advanced configuration:-

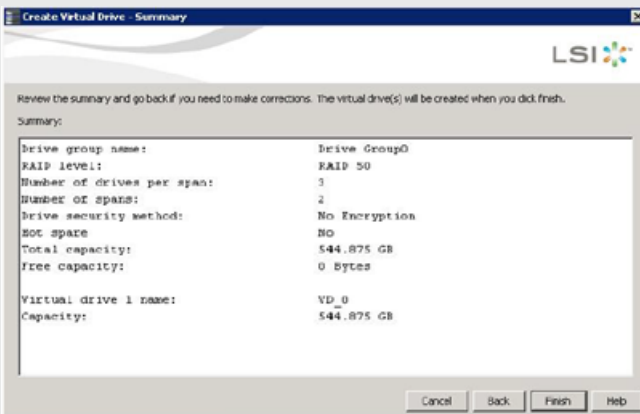

Click Back to return to the previous window to change any selections, or click Finish to accept and complete the configuration.

After you click Finish, the new storage configuration is created and initialized according to the selected options.

After the configuration is completed, a dialog notifies you that the virtual drives were created successfully.

Click OK.

The Enable SSD Caching on New Virtual Drives dialog appears.

The newly created virtual drive is enabled for SSD caching by default. Click OK to confirm SSD caching on the virtual drive. Click No if you want to disable SSD caching on the virtual drive. The All check box is

selected by default. To disable SSD caching on the virtual drives, deselect the All check box. If more drive capacity exists, the dialog asks whether you want to create more virtual drives. If no more drive capacity exists, you are prompted to close the configuration session.

Select either Yes or No to indicate whether you want to create additional virtual drives.

If you select Yes, the system takes you to the Create Virtual Drive - Drive group and Virtual drive settings Dialog. If you select No, the utility asks whether you want to close the wizard. If you selected No in the previous step, select either Yes or No to indicate whether you want to close the wizard. If you select Yes, the Configuration wizard closes. If you select No, the dialog closes, and you remain on the same page.

## Adding a Drive or Drives to a Configuration



**ATTENTION:** Be sure to back up the data on the virtual drive before you add a drive to it.

Follow these steps to add a drive or drives to a configuration with the Modify Drive Group wizard. Click the Logical tab in the left panel of the MegaRAID Storage Manager window. Select a drive group in the left panel of the window. Either select Go To > Drive Group > Modify Drive Group on the menu bar, or right-click the virtual drive icon to access the Modify Drive Group wizard. The Modify Drive Group wizard window appears:-

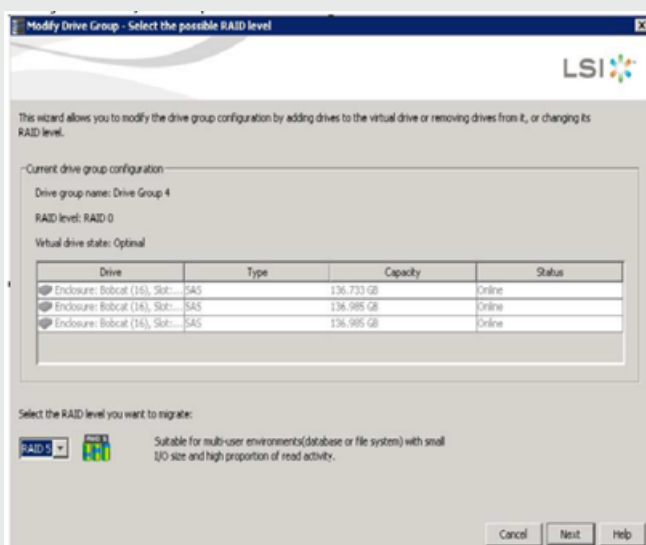

Select RAID 0 as the level to which you want to change ("migrate") the drive group, and click Next. The following window appears. It lists the drives you can add, and it states whether you have to add a minimum number of drives:-

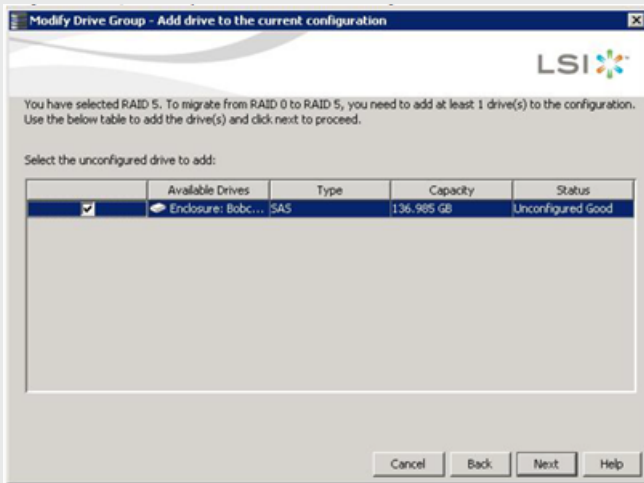

Click the check box next to any unconfigured drives that you want to add, and then click Next.



**NOTE** The drives you add must have the same capacity as or greater capacity than the drives already in the drive group.

The Modify Drive Group - Summary window appears. This window shows the current settings and what the settings will be after the drives are added:-

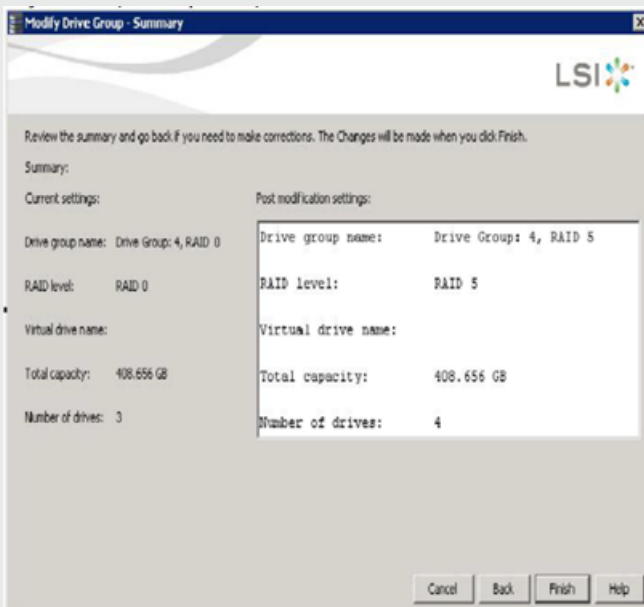

Review the configuration information. You can click Back if you need to change any selections.

Click Finish to accept the changes. A confirmation message appears. The message states that this operation cannot be aborted and asks whether you want to continue.

Click Yes to accept and complete the addition of the drives to the drive group.

# Removing a Drive from a Configuration



**ATTENTION** Be sure to back up the data on the virtual drive before you remove a drive from it. Follow these steps to remove a drive from the configuration.

Click the Logical tab in the left panel of the MegaRAID Storage Manager window.

Click a drive icon in the left panel of the window.

Either select Go To > Physical Drive > Make Drive Offline on the menu bar, or right-click the drive, and select Make Drive Offline from the menu.

A confirmation message appears. The message states that this operation cannot be aborted and asks whether you want to continue.

Click Yes to accept and complete the removal of the drive from the drive group.

# Replacing a Drive



**ATTENTION** Be sure to back up the data on the virtual drive before you replace a drive.

Follow these steps to add a replacement drive and copy the data from the drive that was removed to the replacement drive.

Click the Logical tab in the left panel of the MegaRAID Storage Manager window. Select a drive in the left panel of the window.

Either select Go To > Physical Drive > Replace Physical Drive on the menu bar, or right-click the virtual drive icon to access the Modify Drive Group wizard. The dialog with the replacement drive appears, as shown in the following figure:-

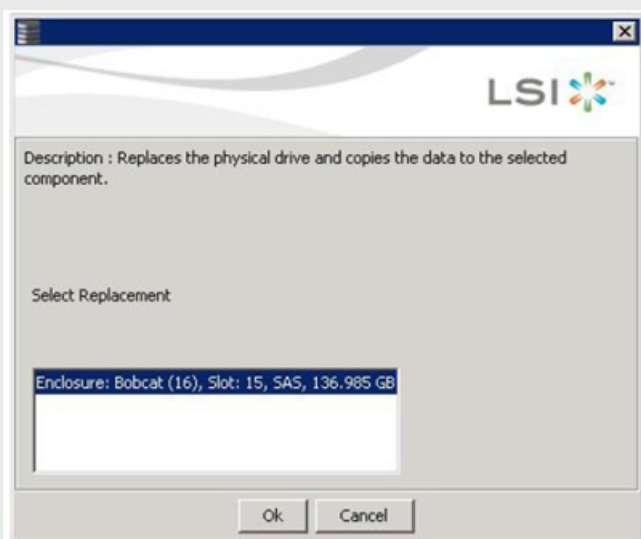



Select a replacement drive.

A confirmation message appears. Click Yes. This step replaces a drive and copies the data to the selected component.

## Maintaining and Managing Storage Configurations

This section explains how to use the MegaRAID Storage Manager software to maintain and manage storage configurations. Log on to the server in Full Access mode to perform the maintenance and management tasks.

### Initializing a Virtual Drive

When you create a new virtual drive with the Configuration Wizard, you can select the Fast Initialization or Full Initialization option to initialize the disk immediately. However, you can select No Initialization if you want to initialize the virtual drive later. To initialize a virtual drive after completing the configuration process, perform these steps: Select the Logical tab in the left panel of the MegaRAID Storage Manager window, and click the icon of the virtual drive that you want to initialize. Select Go To > Virtual Drive > Start Initialization. The Initialize dialog appears. Select the virtual drives to initialize.



**ATTENTION** Initialization erases all data on the virtual drive. Make sure to back up any data you want to keep before you initialize a virtual drive.

Select the Fast Initialization check box if you want to use this option. If you leave the box unselected, the MegaRAID Storage Manager software runs a Full Initialization on the virtual drive. Click Start to begin the initialization. You can monitor the progress of the initialization.

### Running a Group Initialization

Initialization prepares the storage medium for use. You can run initialization on multiple drives at one time. Follow these steps to run a group consistency check. Select Manage > Initialize. The Group Initialization dialog appears:-

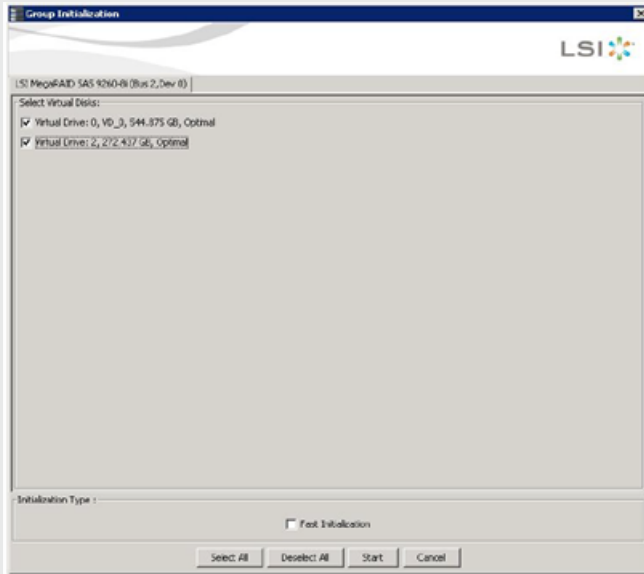

Either check the virtual drives on which to run the initialization, or click **Select All** to select all of the virtual drives. Click **Start**. You can monitor the progress of the group initialization.

## Scanning for New Drives

You can use the **Scan for Foreign Configuration** option to find drives with foreign configurations. A foreign configuration is a RAID configuration that already exists on a replacement set of physical disks that you install in a server. In addition, if one or more drives are removed from a configuration, by a cable pull or drive removal, for example, the configuration on those drives is considered a foreign configuration by the RAID controller. Drives that are foreign are listed on the physical drives list with a special symbol in the MegaRAID Storage Manager software. The utility allows you to import the existing configuration to the RAID controller or clear the configuration so you can create a new configuration using these drives. You can preview the foreign configuration before you decide whether to import it.

The MegaRAID Storage Manager software usually detects newly installed drives and displays icons for them in the MegaRAID Storage Manager window. If for some reason the MegaRAID Storage Manager software does not detect a new drive (or drives), you can use the **Scan for Foreign Configuration** command to find it.

Follow these steps to scan for a foreign configuration: Select a controller icon in the left panel of the MegaRAID Storage Manager window.

Select **Go To > Controller > Scan Foreign Configuration**. If the MegaRAID Storage Manager software detects any new drives, it displays a list of them on the window. If not, it notifies you that no foreign configuration is found. Follow the instructions on the window to complete the drive detection.

## Upgrading Firmware

The MegaRAID Storage Manager software enables you to easily upgrade the controller firmware. To avoid data loss because of dirty cache on the controller, the utility forces the virtual disks into **Write**

Through mode after a firmware upgrade. It is in this mode until the server reboots. In Write Through mode, the controller sends a data transfer completion signal to the host when the disk subsystem has received all of the data in a transaction. This way, in case of a power outage, the controller does not discard the dirty cache.

## Follow these steps to upgrade the firmware:

In the left panel of the MegaRAID Storage Manager window, click the icon of the controller you want to upgrade. In the MegaRAID Storage Manager window, select Go To > Controller > Update Controller Firmware. Click Browse to locate the .rom update file, as shown in the following figure:-

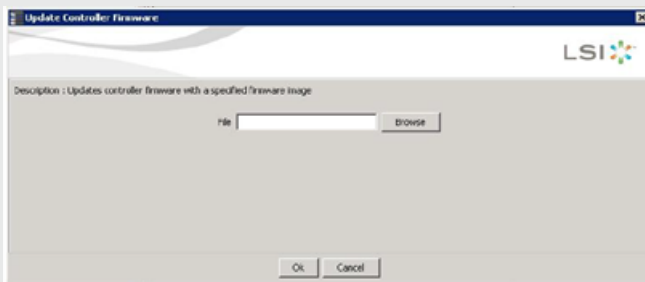

After you locate the file, click Open.

The MegaRAID Storage Manager software displays the version of the existing firmware. When you are prompted to indicate whether you want to upgrade the firmware, click Yes. A progress bar appears along with messages that indicate when an image opens and when an image downloads.

After an image has been downloaded and if Online Firmware Update is supported on the controller, a confirmation message box appears that asks for your confirmation.

If Online Firmware Update is not supported on the controller, the confirmation message box does not appear.

Instead, after an image is downloaded, a message appears that indicates an image is being flashed. The controller is updated

with the new firmware code contained in the .rom file. Reboot the system after the new firmware is flashed. The new firmware does not take effect until reboot. If you click Yes in the confirmation message box, the progress bar continues with a message that indicates that an image is being flashed. After the progress bar disappears, either of the following two messages appear in a message box.

New Firmware Version is flashed successfully. Online Firmware Update is not possible in this case. System reboot is required for the new firmware <version number> to take effect.

New Firmware Version is flashed successfully. Controller Reset will start now.

If the first message appears, reboot your system.

If the second message appears, the MegaRAID Storage Manager main menu window reappears. A Restart Started event appears in the log (at the bottom of the MegaRAID Storage Manager main menu window) and a progress bar appears that states Controller reset is in progress. After the controller reset process is completed, the controller is updated with the new firmware code contained in the .rom file.



Please note: While performing the Online Firmware Update method, there is a small window of time where the IOs are held and the controller is automatically reset. This results in a timeout to your virtualized environments and causes I/O errors. Choose the traditional Firmware update method to avoid the controller reset.

# Unconfigured Bad

Below is an illustration of the symbols used to indicate Unconfigured BAD drives.

Please note: This can be caused by a variety of events, such examples include but are not limited to, SSD malfunction, RAID corruption or hotplugging.

Please note: If this is observed please inspect the log carefully or contact support if you are in doubt.

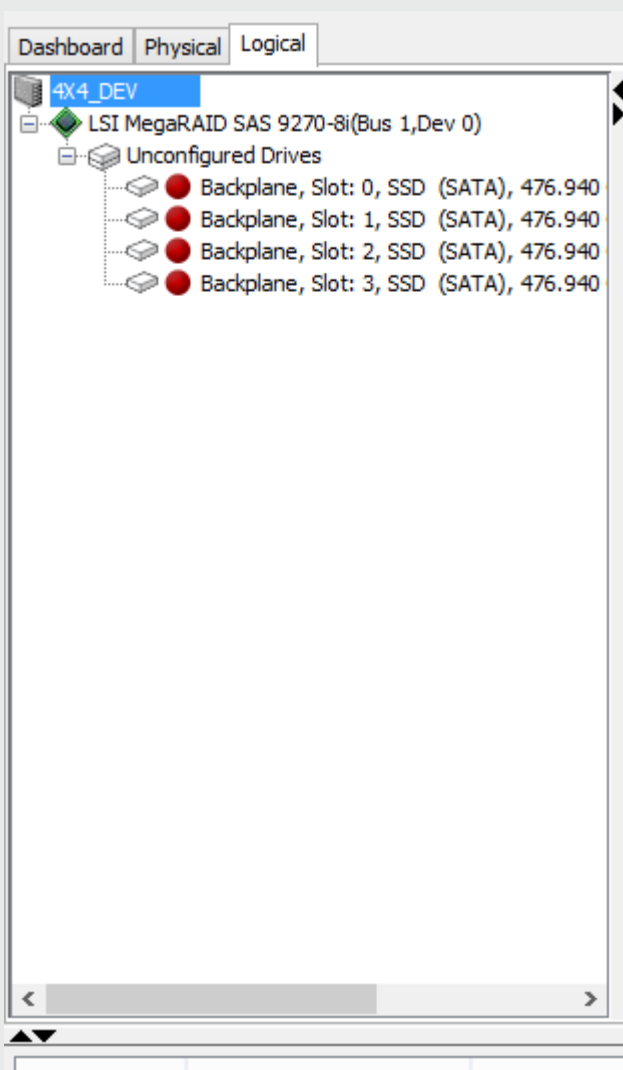

# Restore Unconfigured GOOD state

The screenshot shows the MegaRAID Storage Manager interface. The top navigation bar includes 'Manage', 'Go To', 'Log', 'Tools', and 'Help'. The main area is divided into 'Dashboard', 'Physical', and 'Logical' tabs. The 'Physical' tab is active, showing a tree view of 'Unconfigured Drives' with four entries: 'Backplane, Slot: 0', 'Backplane, Slot: 1', 'Backplane, Slot: 2', and 'Backplane, Slot: 3'. A context menu is open over these drives, with the option 'Change to Unconfigured Good' highlighted. Below the tree view, the 'Properties' pane shows details for a selected drive, including capacity (476.437 GB and 476.940 GB), size (512 B), certified status (No), product ID (TOSHIBAITHV5J1), vendor ID (ATA), serial number (X4BS10BZT9UW), device ID (13), status (Unconfigured Bad), drive type (Solid State Drive (SATA)), drive speed (6.0 Gbps), and negotiated link speed (6.0 Gbps).

At the bottom of the interface is an error log table with the following data:

ID	Error Level	Date / Time	Description
247	[Information, 0]	2015-06-01, 08:01:55	Controller ID: 0 Device inserted Device Type: Disk Device Id: 13
91	[Information, 0]	2015-06-01, 08:01:55	Controller ID: 0 PD inserted: -:-0
247	[Information, 0]	2015-06-01, 08:01:55	Controller ID: 0 Device inserted Device Type: Disk Device Id: 12
91	[Information, 0]	2015-06-01, 08:01:55	Controller ID: 0 PD inserted: -:-1
247	[Information, 0]	2015-06-01, 08:01:52	Controller ID: 0 Device inserted Device Type: Disk Device Id: 15
91	[Information, 0]	2015-06-01, 08:01:52	Controller ID: 0 PD inserted: -:-2
247	[Information, 0]	2015-06-01, 08:01:52	Controller ID: 0 Device inserted Device Type: Disk Device Id: 14
91	[Information, 0]	2015-06-01, 08:01:52	Controller ID: 0 PD inserted: -:-3
139	[Information, 0]	2015-06-01, 08:01:38	Controller ID: 0 Deleted VD: 0
114	[Information, 0]	2015-06-01, 08:01:37	Controller ID: 0 State change: PD = -:-0 Previous = Failed Current = Unconfigured Bad
114	[Information, 0]	2015-06-01, 08:01:37	Controller ID: 0 State change: PD = -:-1 Previous = Failed Current = Unconfigured Bad
248	[Information, 0]	2015-06-01, 08:01:37	Controller ID: 0 Device removed Device Type: Disk Device Id: 13
112	[Warning, 1]	2015-06-01, 08:01:37	Controller ID: 0 PD removed: -:-0
248	[Information, 0]	2015-06-01, 08:01:37	Controller ID: 0 Device removed Device Type: Disk Device Id: 12
112	[Warning, 1]	2015-06-01, 08:01:37	Controller ID: 0 PD removed: -:-1
114	[Information, 0]	2015-06-01, 08:01:37	Controller ID: 0 State change: PD = -:-0 Previous = Configured - Shielded Current = Failed

# Video input

Your pro system is equipped with capture cards. These cards have the ability to capture live video from either SD-SDI or HD-SDI video sources with up to four unique feeds, or two unique 3G-SDI feeds per machine.

## Max Number of Unique Inputs

<b>SD-SDI</b>	<b>HD-SDI</b>	<b>3G-SDI</b>
4	4	2



**Warning:** 4K resolutions is currently only supported over quad split HD-SDI

## Supported formats

720x486i @ 59.94 Hz NTSC

720x576i @ 50.00 Hz PAL

1280x720p @ 23.976Hz, 24Hz, 25Hz, 29.97Hz, 30Hz, 50Hz, 59.94Hz, 60Hz

1920x1080i @ 47.96Hz, 48Hz, 50Hz, 59.94Hz, 60Hz

1920x1080PsF @ 23.976Hz, 24Hz, 25Hz, 29.97Hz, 30Hz

1920x1080p @ 23.976Hz, 24Hz, 25Hz, 29.97Hz, 30Hz, 47.96Hz, 48Hz, 50Hz, 59.94Hz, 60Hz

2048X1080p @ 23.976Hz, 24Hz, 25Hz, 29.97Hz, 30Hz, 47.96Hz, 48Hz, 50Hz, 59.94Hz, 60Hz

2048X1080i @ 47.96Hz, 48Hz, 50Hz, 59.94Hz, 60Hz

2048x1556PsF @ 14.98Hz, 15Hz, 18.98Hz, 19Hz

4K UHD 3840x2160, 4K P/PsF @ 23, 24, 25, 29, 30fps

4K DCI 4096x2160, 4K P/PsF, @23, 24, 25, 29, 30fps

It is possible to have a different format on each input, However the limitations are a maximum of 1x 4k or 2x 1080p60.

If you are using 1x 4k or 2x 1080p it is not possible to use any other video inputs on the unit due to hardware limitations.

## Back-Plate Layout



*Diagram of Video Capture BNC connections on rear of unit*

**Please note:** Live Video input inherently introduces frame latency during playback. Please contact [Support](#) for guidance on performance standards.



# Video output

The pro and gx ranges of disguise servers come with a range of possible output configurations. It is possible to use a combination of any of the types of four VFC cards below.

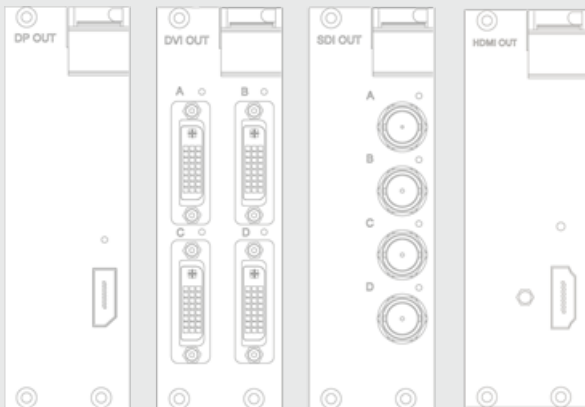

<b>Display Port 1.2</b>	<b>Quad DVI</b>	<b>Quad SDI</b>	<b>HDMI</b>
-------------------------	-----------------	-----------------	-------------

1 Output per card	4 Outputs per card	4 Outputs per card	1 Output per card
Max res: 4096x2160	Single Link DVI: (up to) 1920 x 1200	Max res: 1920 x 1080	Max res: 4096x2160 @60 YCbCr444 8bit 3840x2160 @60 YCbCr422 10bit* 3840x2160 @30 YCbCr444 10bit
LED indicator	LED indicator	LED indicator	LED indicator
Genlocked	All outputs genlocked	All outputs genlocked	Genlocked

# 4K Output



Warning: We highly advise using DisplayPort cables specifically validated for: DP 1.2, DP 1.2a or 21.6 Gbps bandwidth

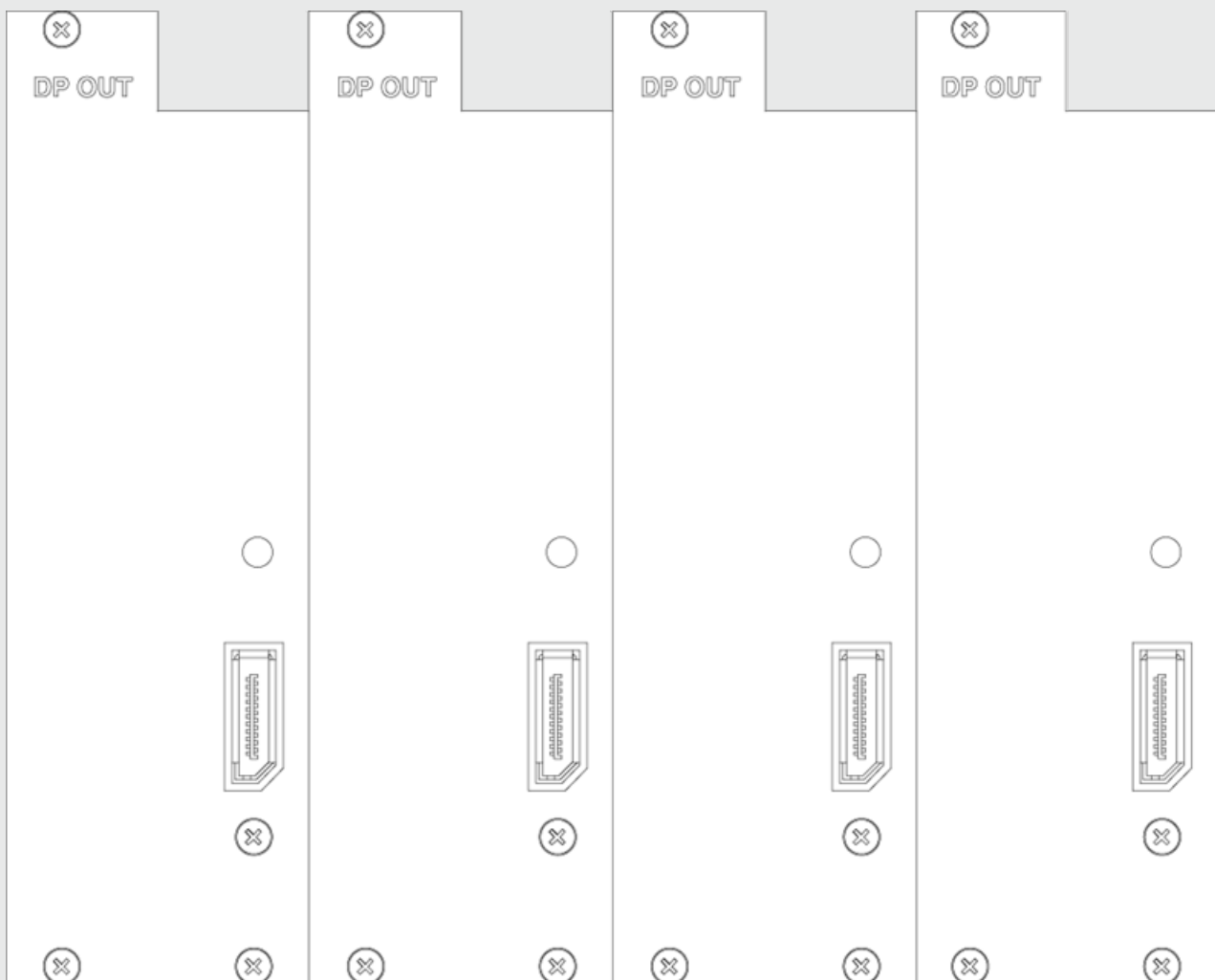

4 x DisplayPort 1.2 outputs on rear of 4x4pro

Please Note: the 4x4pro supports 4K@30. It is not recommended to use DP to HDMI adapters to achieve 4K@60; instead, it is recommended to use the VFC HDMI 2.0 card 4x4pro

This enables the pro & gx ranges of disguise servers to support resolutions up to 4096x2160 60hz over Single Stream Transport.

# Audio input and output

The 4x4pro is equipped with a broadcast quality pro audio card which uses the latest 192kHz AD and DA converters.

## Back panel connections

- XLR Left + Right Input
- XLR Left + Right Output
- ADAT/SPDIF Input
- ADAT/SPDIF Output
- MIDI Input
- MIDI Output

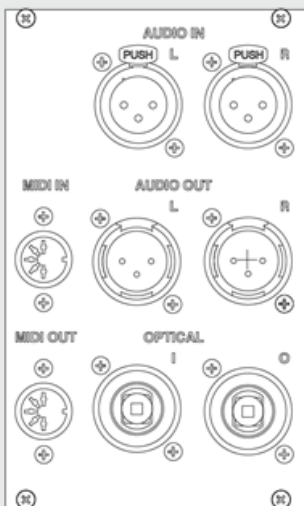

Audio connections on rear of 4x4pro unit.

## Front panel connections

- 1/4inch Stereo Monitoring socket

It is possible to monitor audio output from the unit from the 1/4inch stereo socket with a pair of headphones.

## RME card settings

1. Go to the Windows Start Menu.
2. Right click on the speaker in the task tray next to the clock on the desktop and click on Playback Devices.
3. Scroll Down and Right-click the device named Speakers and select Set as Default device if it is not already selected.

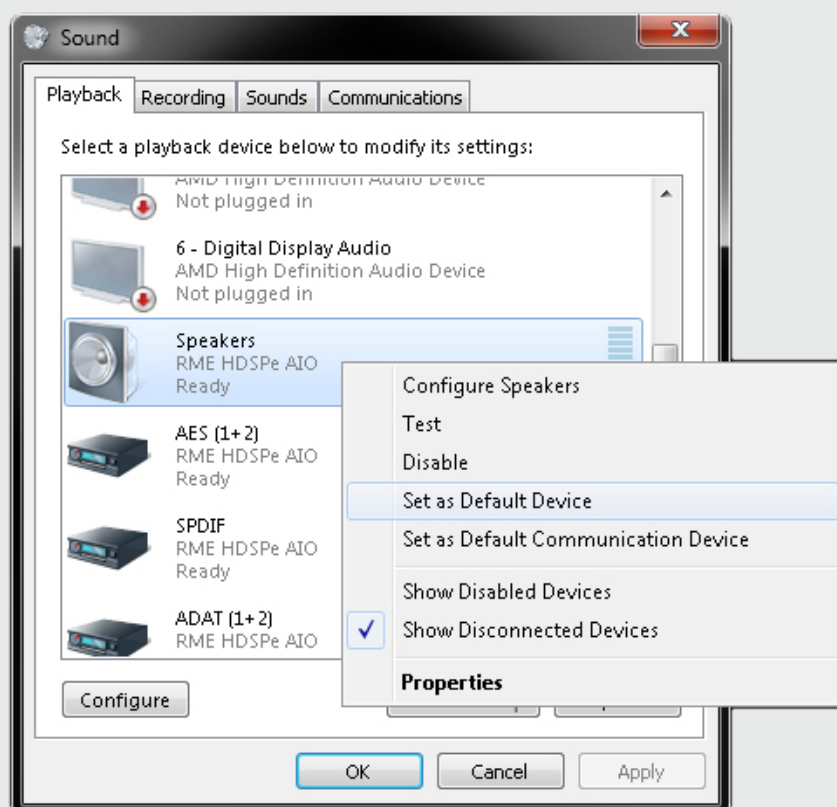

# gx 1 overview

The machine come pre-installed with the latest software version, enabling you to design, configure and sequence the show on the same machines as you later use for show playback.

## gx 1 Machine

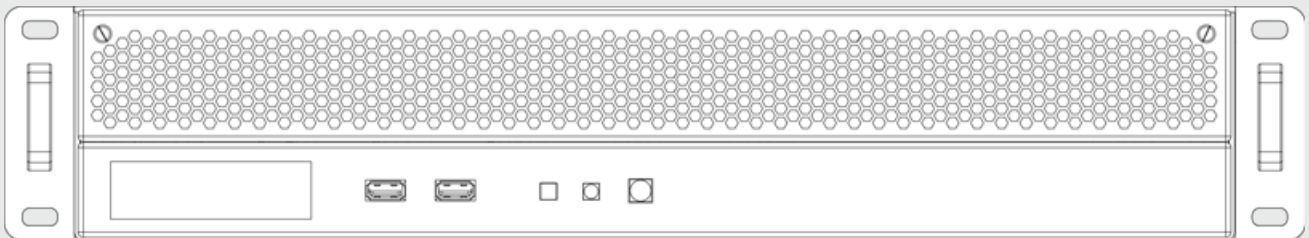

Front view of gx 1

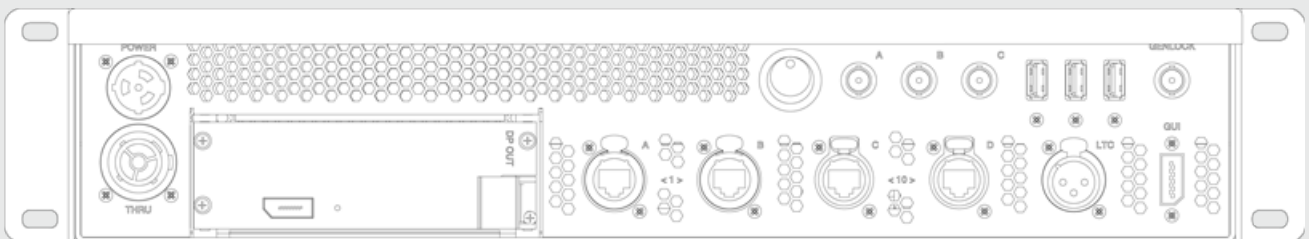

rear view of gx 1

# gx 2c Machine

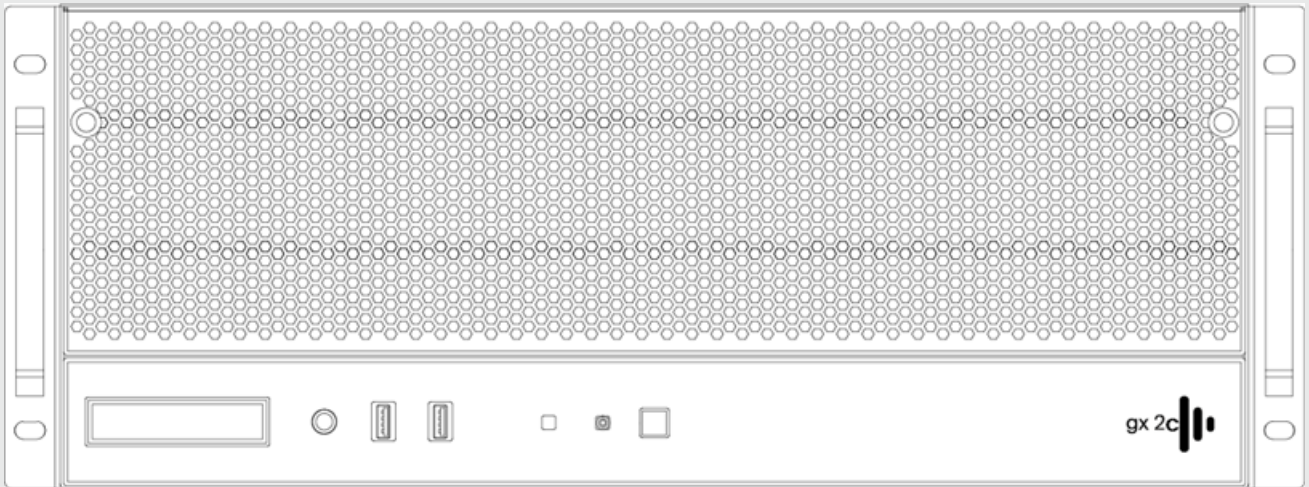

Front view of gx 2c

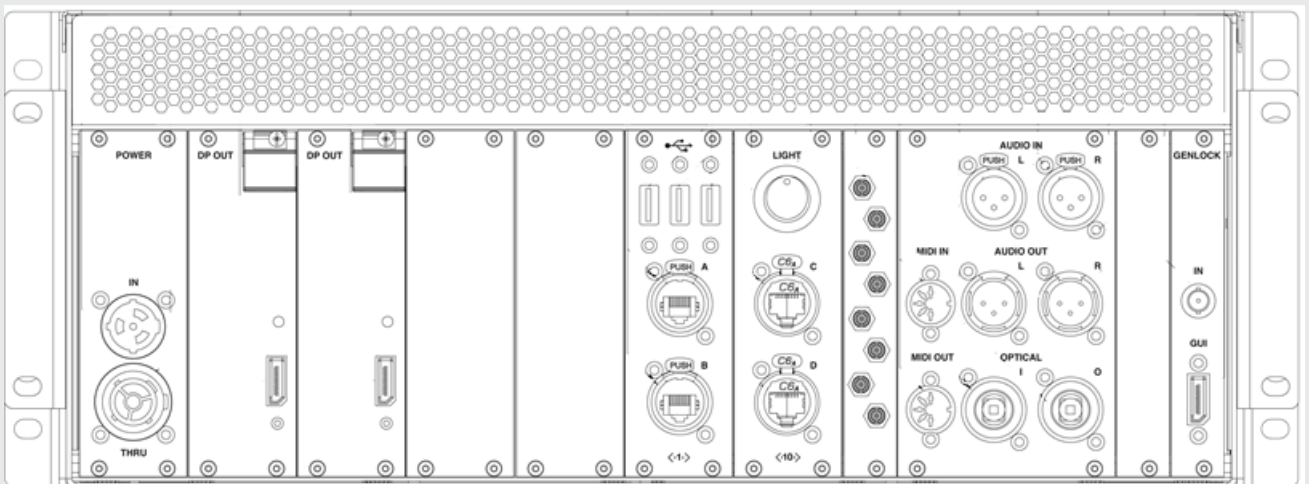

rear view of gx 2c

# gx1 diagrams

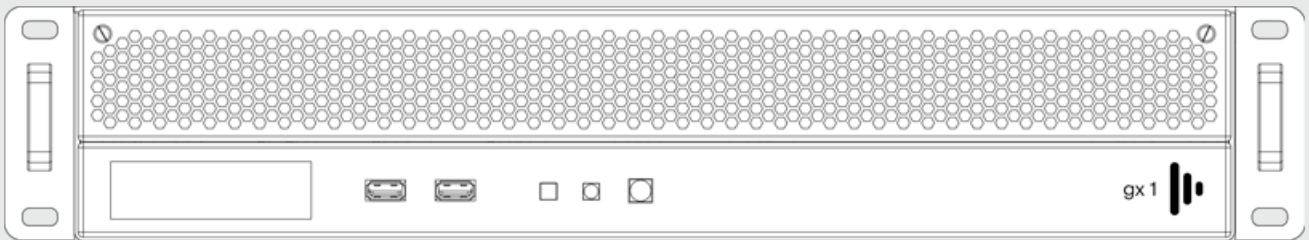

gx 1 front panel annotated

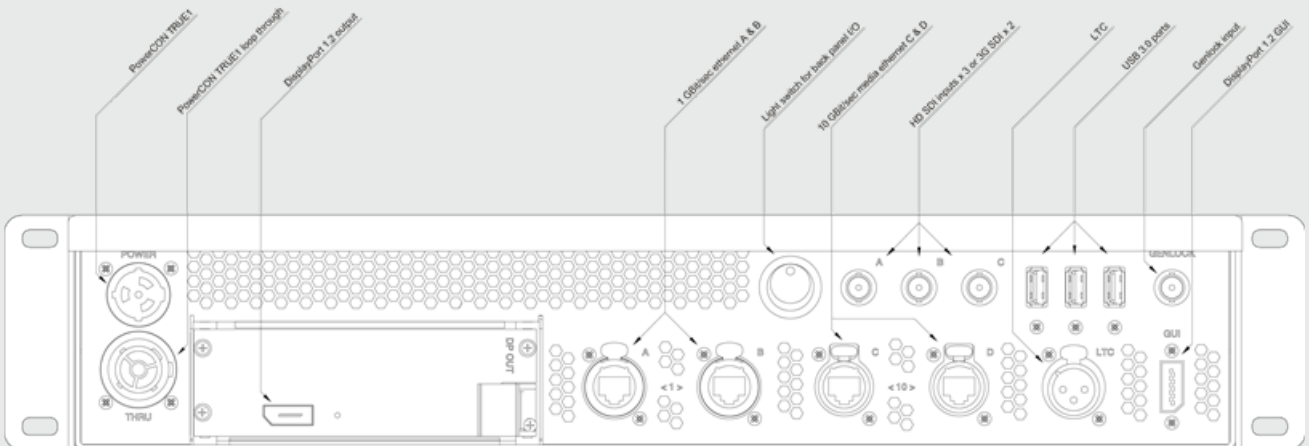

gx 1 rear panel annotated

vx 4+ rear panel annotated

# Powering the gx range

The pro and gx ranges of disguise servers use Neutrik powerCON TRUE1 as the power input. The TRUE1 is:

- Lockable
- Live-Mating (safely)
- Extendable
- Dust and water resistant according to IP65 in mated condition

To power a server, you should use a cable with the following attributes:

- SJT flexible cord, min. 12AWG, min. 300V, min. 60v dm;C, max 4.5 m long
- One end terminated with NEMA 5-15P/BS 1363/CEE 7 plug
- Other end terminated with appliance coupler type Neutrik AG, type NAC3FX

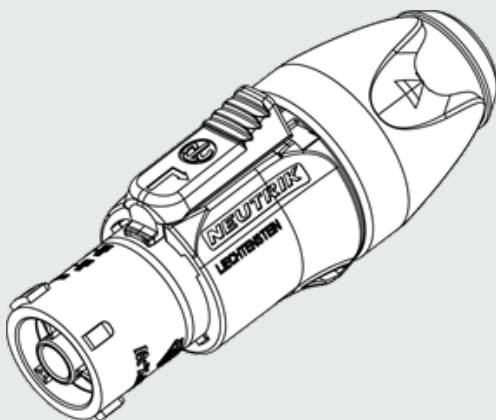

*Neutrik powerCON TRUE1 connector*



# Powering a multi server system

The gx 1 uses True1 Powercon as its power input and features a loop through to make powering a multi server system more efficient.

The power input to the machine is rated at 12Amps RMS per connection in Europe and USA.

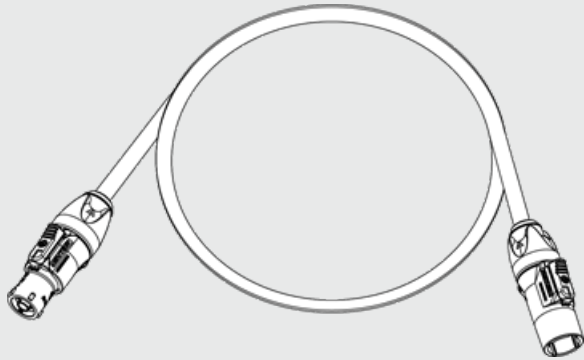

Loop through cables should have the following attributes:

- SJT flexible cord, min. 12AWG, min. 300V, min. 60v dm;C, max 4.5 m long
- One end terminated with appliance coupler type Neutrik AG, type NAC3MX-W
- Other end terminated with appliance coupler type Neutrik AG, type NAC3FX

# Power calculations for a safely powered system

It is important that you calculate how many gx range units you can daisy chain together using the in/loop connections provided. Failure to do so could result in a loss of power to the Disguise system.

Use the formula "Power = Voltage x Current" to calculate how many units you can chain together. For Example:

UK Power: 230V 13Amp rated supply.

For example, max power draw of a 4x4pro = 1400W (check technical specifications for your unit).

Available Power = 230V x 12A

Available Power = 2990W

Available Power / Max Power Draw = Number of Units

2990W / 1400W = 2.1 Units



**Warning:** Be safe! On a UK 13Amp supply @230V you can connect 2 Units safely with 100W of headroom

# How to start the unit

1. Connect Power cord to the gx 1 gx 2 gx 2c
2. Make sure you have connected a keyboard, mouse and monitor to the primary graphics output.
3. Press the power button on the front of the unit and wait for the system to load into Windows.

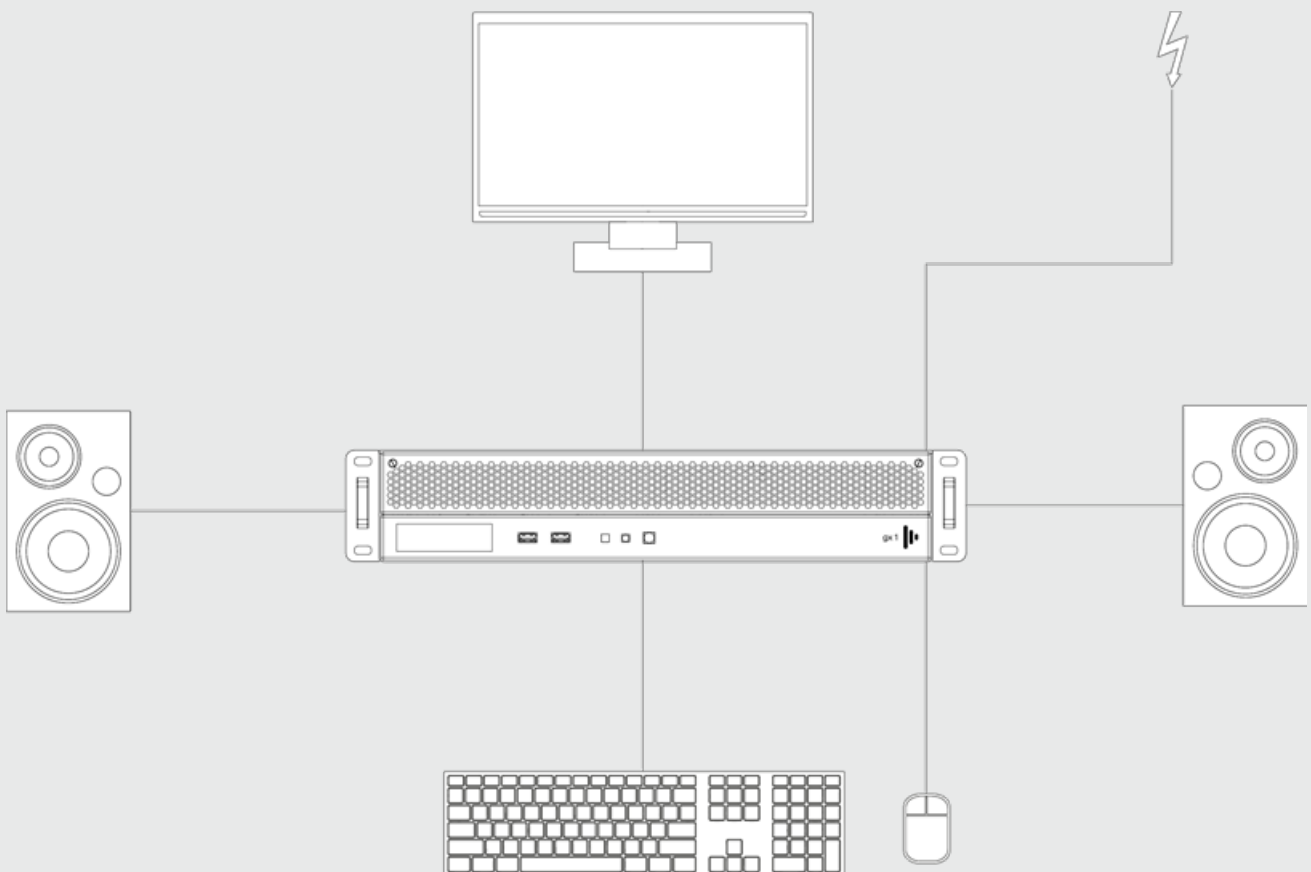

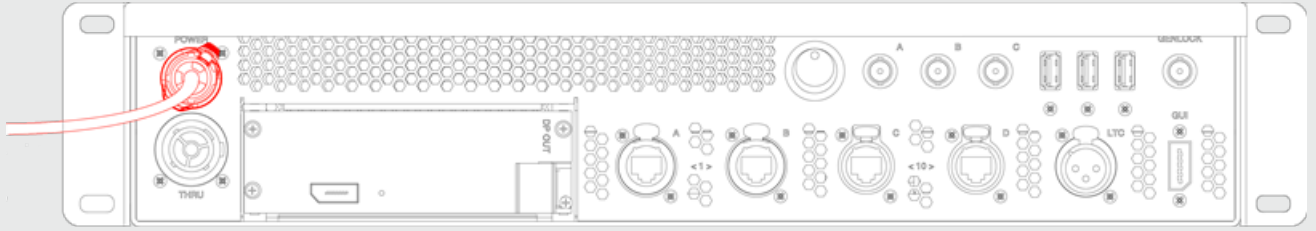

*Location of power input on rear of gx 1 unit*

# Update System - gx 1

The processes for restoring and reimaging a gx 1 server

## Overview

Internal system restore is the process of doing a factory restore on the system.

REDISGUISE is the process of doing an update or restore on the system using a bootable USB drive.

Neither of these restore processes affects the media drive of the server.

## Internal Restore

**Please note:** This procedure will only work with OS version 10 and greater.

To locate your OS version please go to **d3manager- Help - About d3manager**.

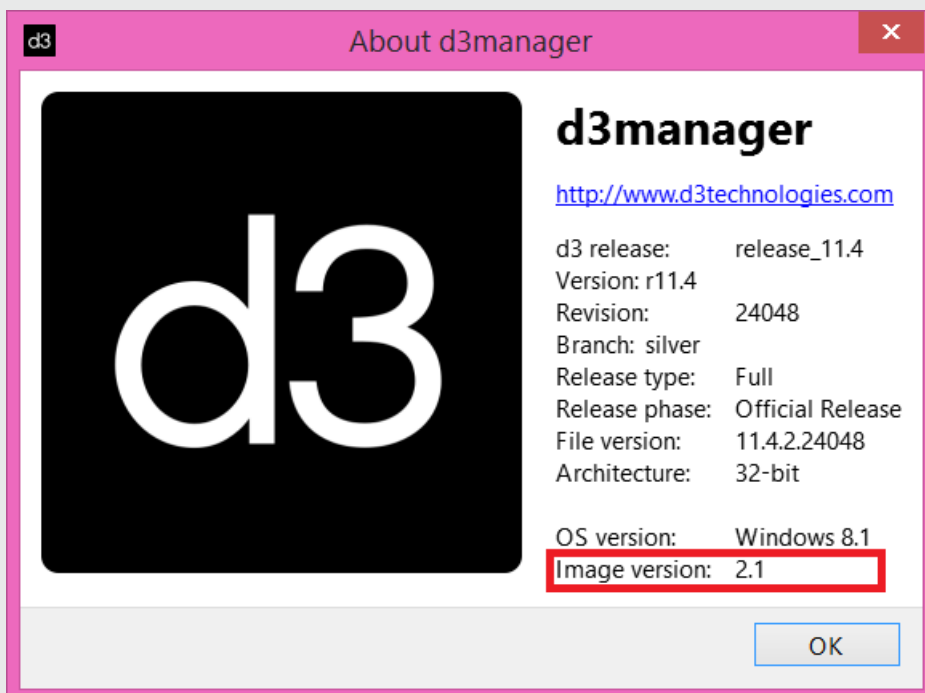



**Warning:** The system needs to be connected to the internet during this procedure. If it is not, or it loses internet connection during the process - windows activation will fail.

## Re-imaging the system

1. Hold down **shift** whilst restarting the system.

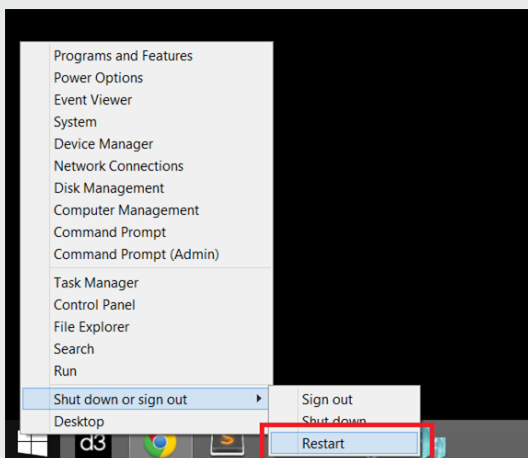
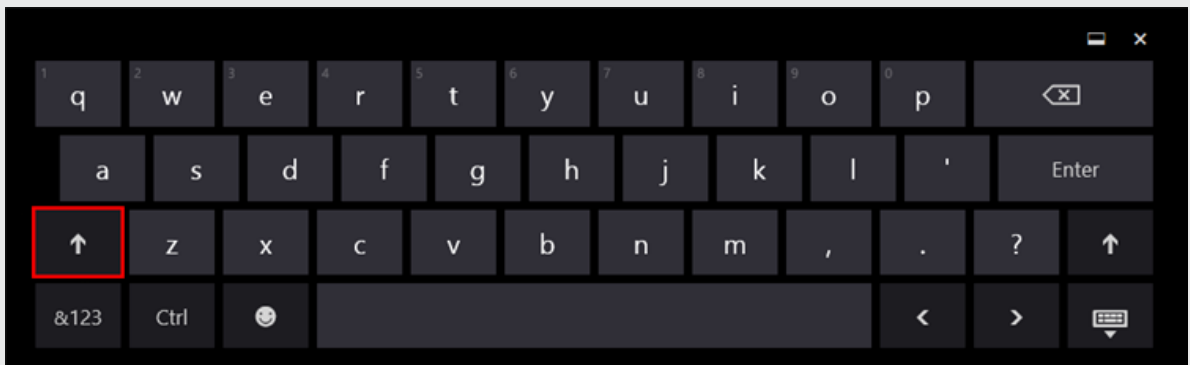

2. Select **Use another operating system**

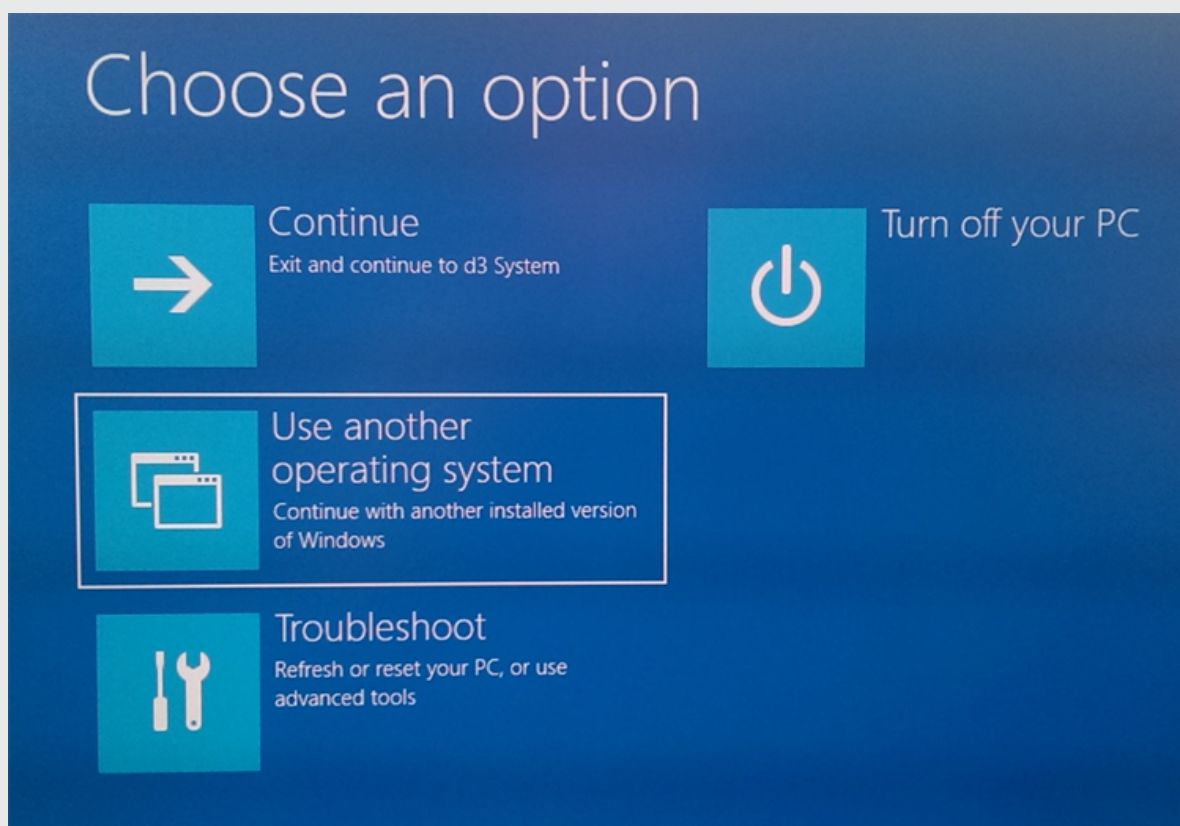

3. Select **Reset OS**.

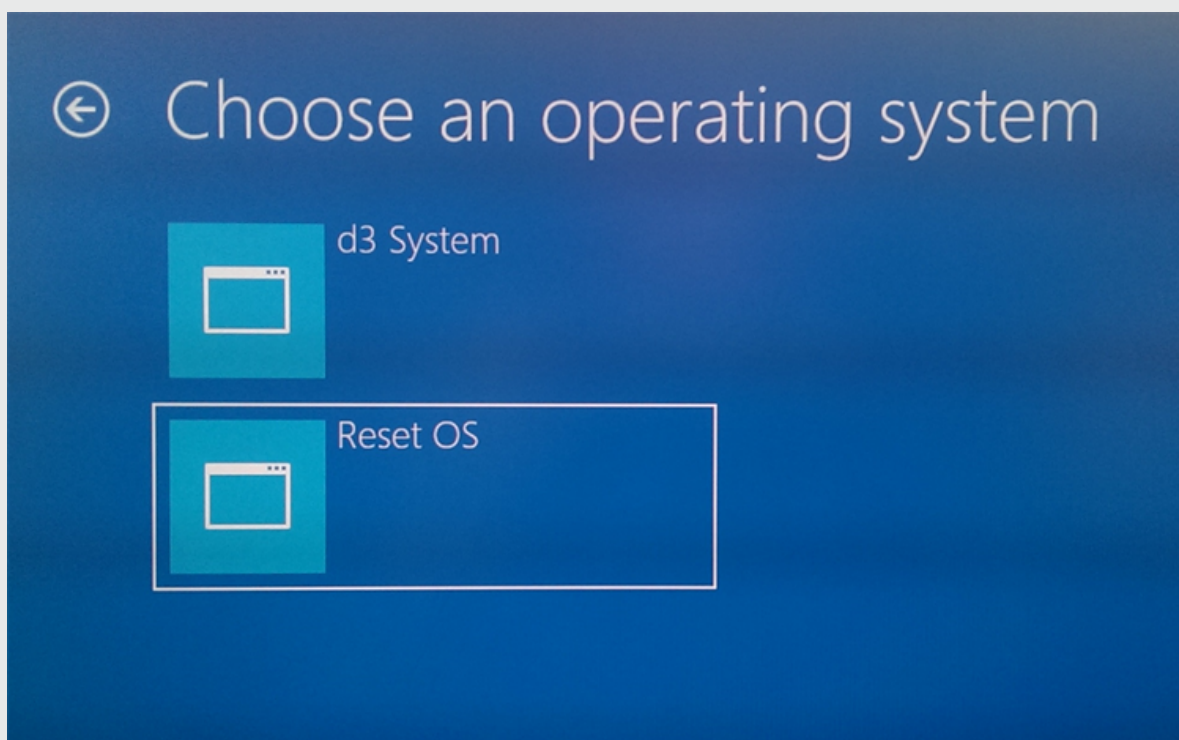

4. The system will reboot into the internal re-imaging system which will reinstall the Operating System and revert settings to factory



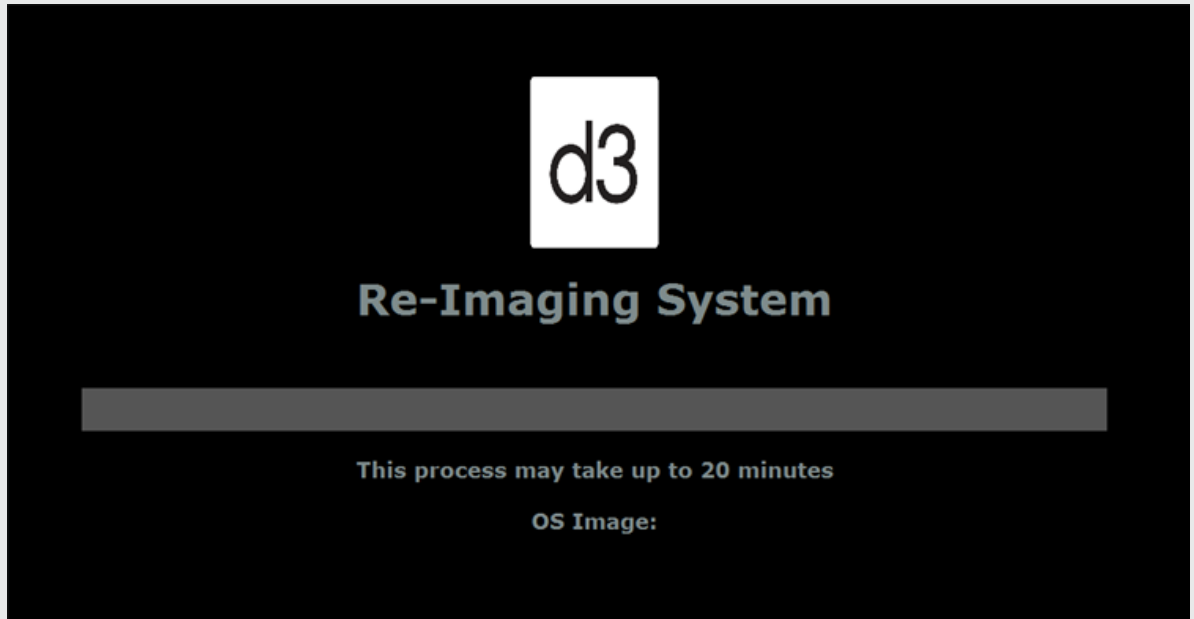

## Activating windows

Windows should activate automatically, as long as the machine was connected to the internet for the duration of the re-imaging process.

If windows does not activate during the re-imaging process, follow these steps.

1. Wait for a few minutes after the re-imaging process has completed to allow the server time to activate Windows.

2. Navigate to the System tab by right clicking on the Windows start menu and selecting **System**

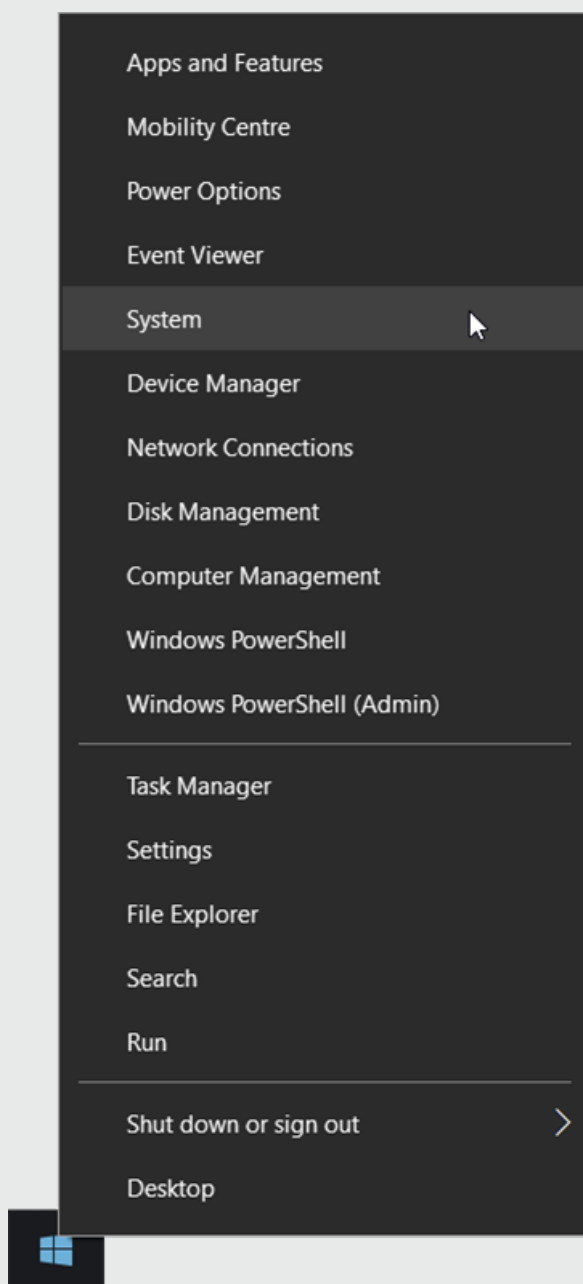

3. In the System window, check to see if you have valid Windows license information visible. If you do not, contact the [disguise support team](#).

# REDISGUISE

**Please note:** If you experience any problems during updating or restoring the system, or any of these instructions are unclear, please contact the [support team](#).



**Warning:** The system needs to be connected to the internet during this procedure

The gx range handles updates by using installers which are firm ware packages that encompass updates from the ground up.

This process can be used to update to a newer OS image, or revert to a previous OS image.

To tell what OS image your system is on please go to the help menu in [d3manager](#) and select **About d3manageranager**.

## You will need

- A 32Gb USB memory stick
- A version of [Rufus](#) to turn it into a bootable disk. Make sure the volume name of the USB is: "REDISGUISE" as per image
- An internet connection to the machine you are re-imaging
- Download and install a version of [7Zip](#)
- Download and unzip the multi file archive using 7Zip
- OS images can be found [here](#).

**Please note:** You do not need to extract all parts individually. Simply place them in the same directory and then use 7zip to extract the ISO by selecting any part. 7zip will automatically unzip all parts to create the image file.

# Create Bootable USB device

1. Download and unzip the multi-file archive using 7Zip (NOTE: you will only need to unzip file 001):

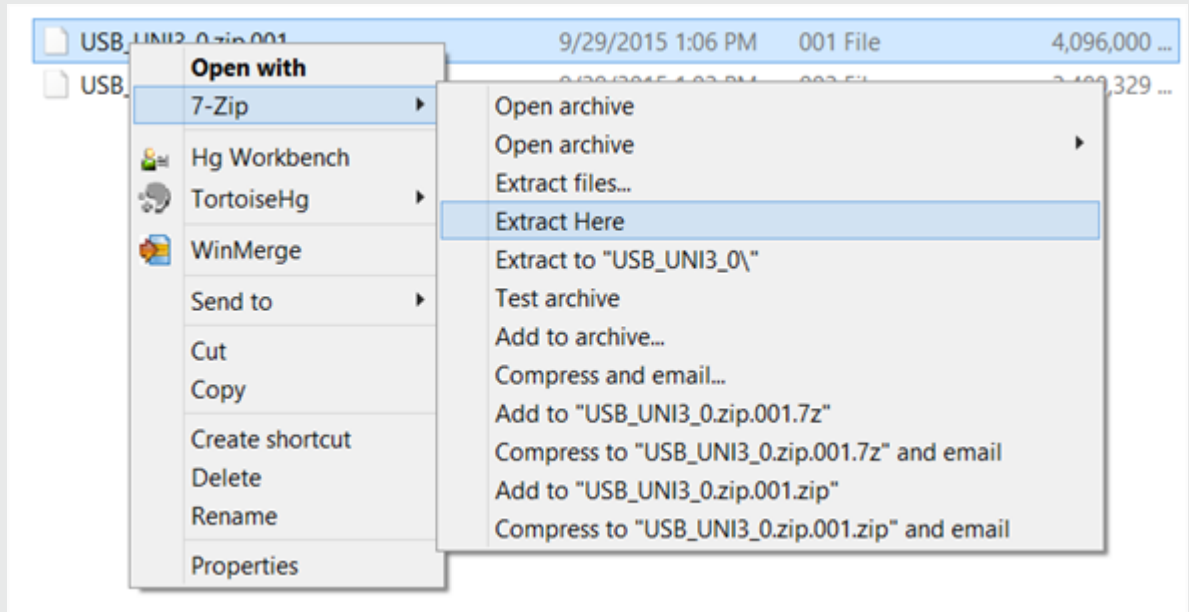

2. Create Bootable USB stick with the unzipped ISO.

The settings should be:

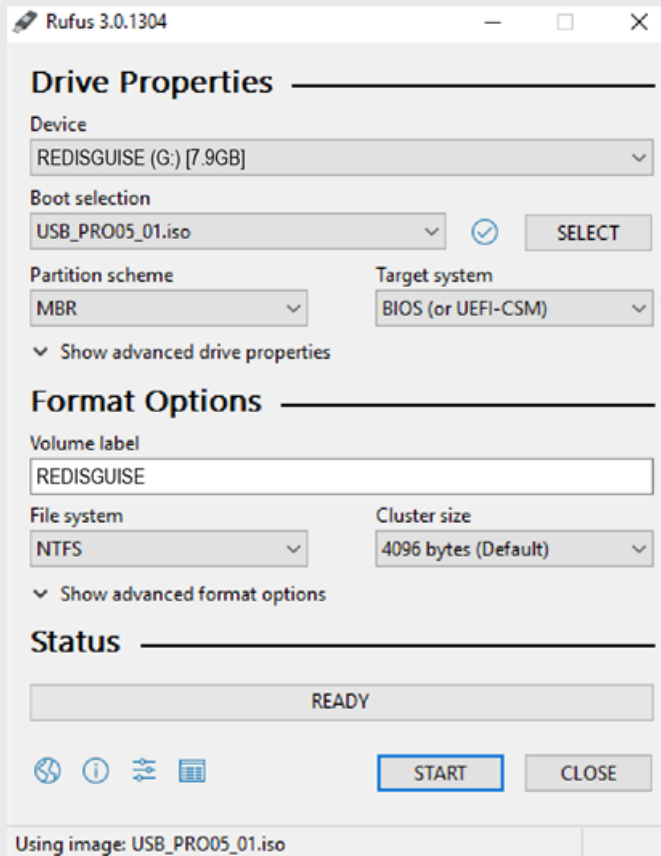

- Partition scheme - MBR
- Target system - BIOS (or UEFI-CSM)
- Volume label - automatically pulled from ISO file
- File system - NTFS



**Warning:** These settings are critically important. The re-image process will fail if they are not set correctly.

**Please note:** On the latest versions of Rufus you may see this warning. This is expected and does not apply to current disguise hardware. Please click **OK** to continue as normal.

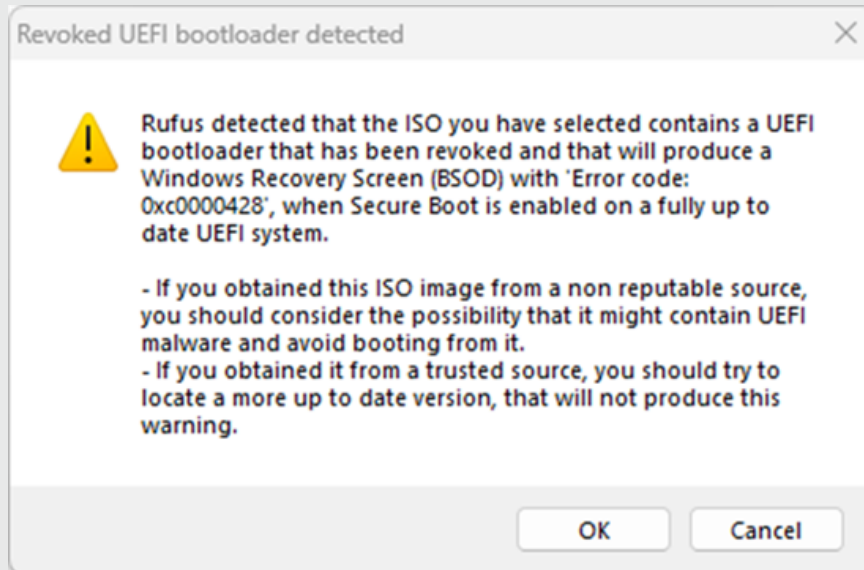

## Booting into the USB

1. Go into the BIOS by hitting Delete on the logo splash screen during boot.
2. Navigate to the **Boot** tab using the arrow keys and select **Harddrive BBS Properties**. Hit **Enter** to access the properties.
3. Navigate to the Advanced tab and change the Boot option #1 to the USB stick
4. Do not select Save and Exit. Hit escape, and navigate to Save & Exit tab.
5. Select your USB stick from the Boot override menu. Press Enter.
6. Be ready to hit any key to confirm USB boot immediately after.

**Please note:** performing a system restore from the new disk image will erase any valuable data on your system drive. Please ensure you make a back up of any essential files from your system (C:) drive before initialising this process. The process does NOT destroy any media or projects on your media drive.

# Unit rear light

Disguise servers in the pro and gx ranges come with the addition of an LED light on the back of the unit that illuminates the connections on the rear panel.

The light can be turned on or off using the switch labeled "light" with power in.

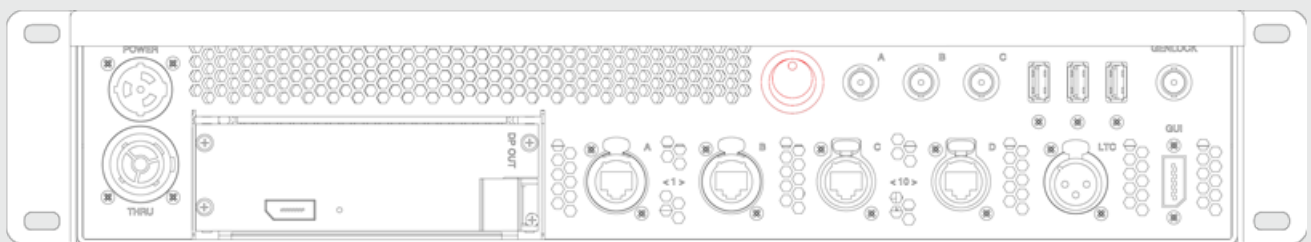

*Location of light switch on rear of a gx 1*



# Video input

Your Disguise system is equipped with capture cards. These cards have the ability to capture live video from either SD-SDI or HD-SDI video sources with up to three unique feeds, or two unique 3G-SDI feeds per machine.

## Max Number of Unique Inputs

	SD-SDI	HD-SDI	3G-SDI
gx 1	3	3	2



**Warning:** 4K resolutions is currently only supported over quad split HD-SDI

## Supported formats

720x486i @ 59.94 Hz NTSC

720x576i @ 50.00 Hz PAL

1280x720p @ 23.976Hz, 24Hz, 25Hz, 29.97Hz, 30Hz, 50Hz, 59.94Hz, 60Hz

1920x1080i @ 47.96Hz, 48Hz, 50Hz, 59.94Hz, 60Hz

1920x1080PsF @ 23.976Hz, 24Hz, 25Hz, 29.97Hz, 30Hz

1920x1080p @ 23.976Hz, 24Hz, 25Hz, 29.97Hz, 30Hz, 47.96Hz, 48Hz, 50Hz, 59.94Hz, 60Hz

2048X1080p @ 23.976Hz, 24Hz, 25Hz, 29.97Hz, 30Hz, 47.96Hz, 48Hz, 50Hz, 59.94Hz, 60Hz

2048X1080i @ 47.96Hz, 48Hz, 50Hz, 59.94Hz, 60Hz

2048x1556PsF @ 14.98Hz, 15Hz, 18.98Hz, 19Hz

4K UHD 3840x2160, 4K P/PsF @ 23, 24, 25, 29, 30fps

4K DCI 4096x2160, 4K P/PsF, @ 23, 24, 25, 29, 30fps

It is possible to have a different format on each input, However the limitations are a maximum of 1x 4k or 2x 1080p60.

If you are using 1x 4k or 2x 1080p it is not possible to use any other video inputs on the unit due to hardware limitations.

## Back-Plate Layout

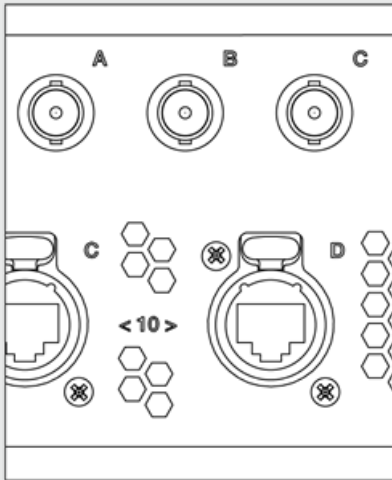
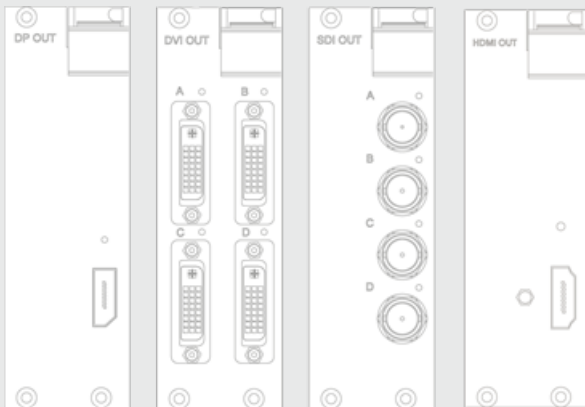

Diagram of Video Capture BNC connections on rear of gx 1

**Please note:** Live Video input inherently introduces frame latency during playback. Please contact [Support](#) for guidance on performance standards.

# Video output

The pro and gx ranges of disguise servers come with a range of possible output configurations. It is possible to use a combination of any of the types of four VFC cards below.



Display Port 1.2	Quad DVI	Quad SDI	HDMI
1 Output per card	4 Outputs per card	4 Outputs per card	1 Output per card
Max res: 4096x2160	Single Link DVI: (up to) 1920 x 1200	Max res: 1920 x 1080	Max res: 4096x2160 @60 YCbCr444 8bit 3840x2160 @60 YCbCr422 10bit* 3840x2160 @30 YCbCr444 10bit
LED indicator	LED indicator	LED indicator	LED indicator
Genlocked	All outputs genlocked	All outputs genlocked	Genlocked

# 4K Output



**Warning: We highly advise using DisplayPort cables specifically validated for: DP 1.2, DP 1.2a or 21.6 Gbps bandwidth**

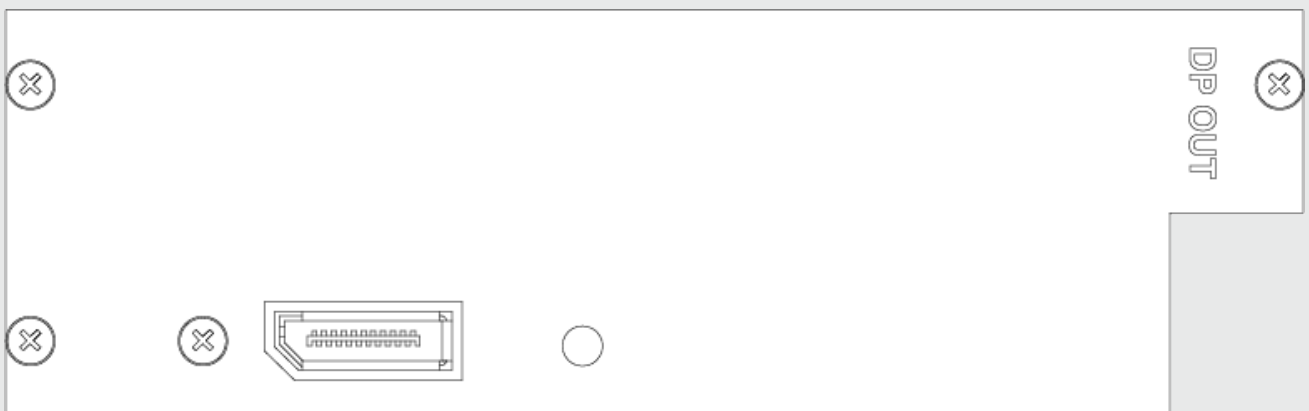

*2 x DisplayPort 1.2 outputs on rear of gx 1*

This enables the pro & gx ranges of disguise servers to support resolutions up to 4096x2160 60hz over Single Stream Transport.

# Audio input and output



Warning: The gx 1 only supports LTC input.

The gx 1 only supports LTC input.

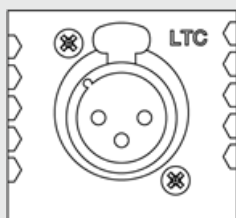

It is possible to monitor audio output from the unit from the 1/4inch stereo socket with a pair of headphones.

# gx 2 Overview

The gx 2 comes pre-installed with the latest software version, enabling you to design, configure and sequence the show on the same machines as you later use for show playback.

## gx 2 Machine

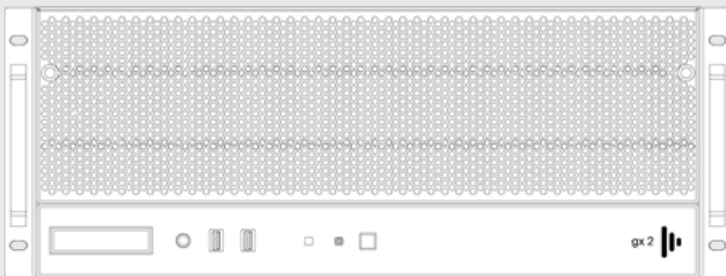

Front view of gx 2

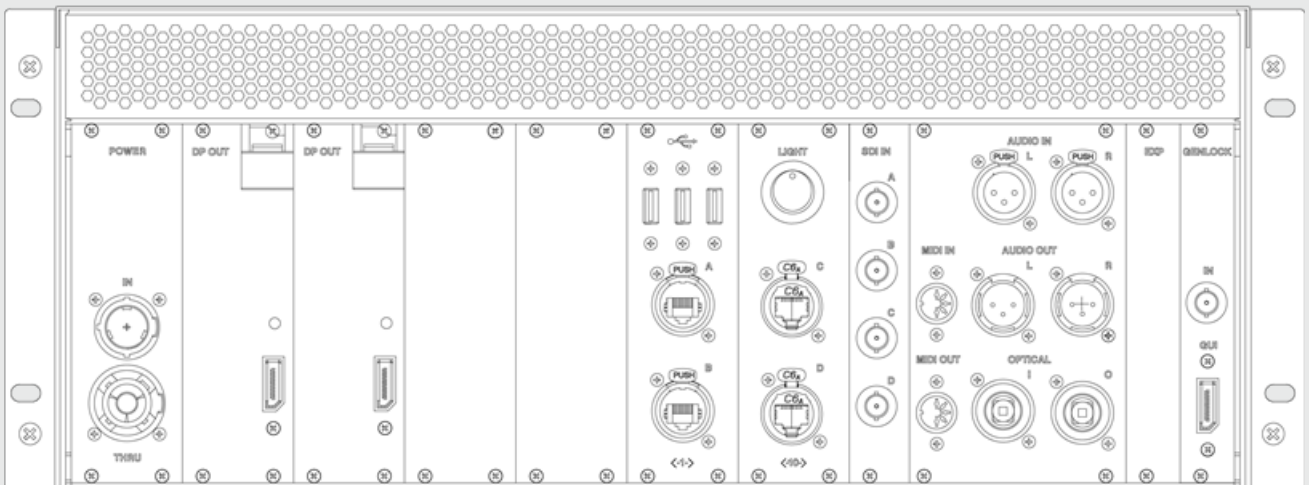

rear view of gx 2

# gx range diagrams

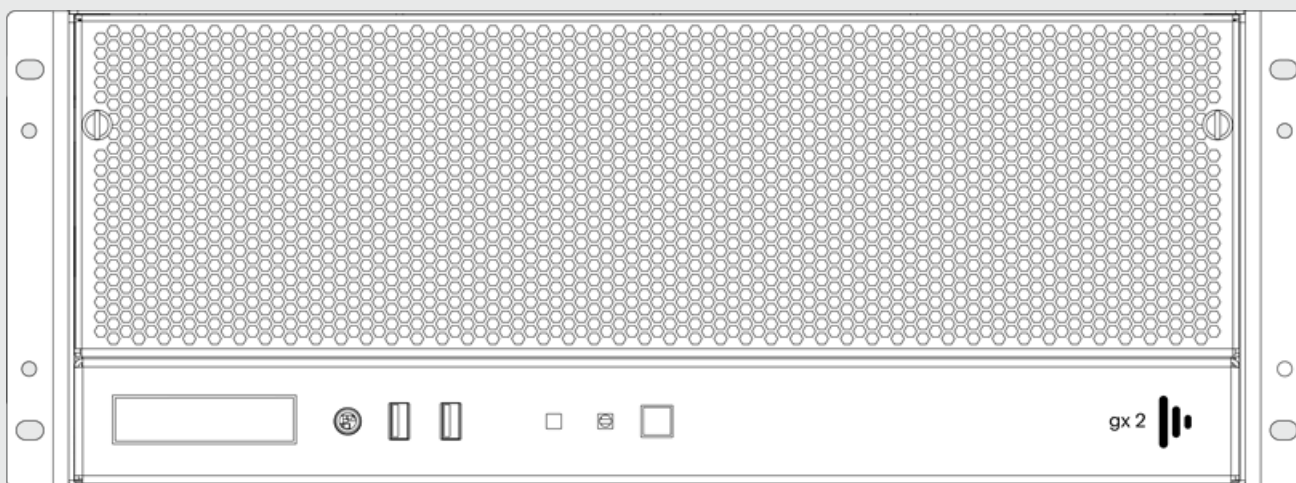

gx 2 front panel

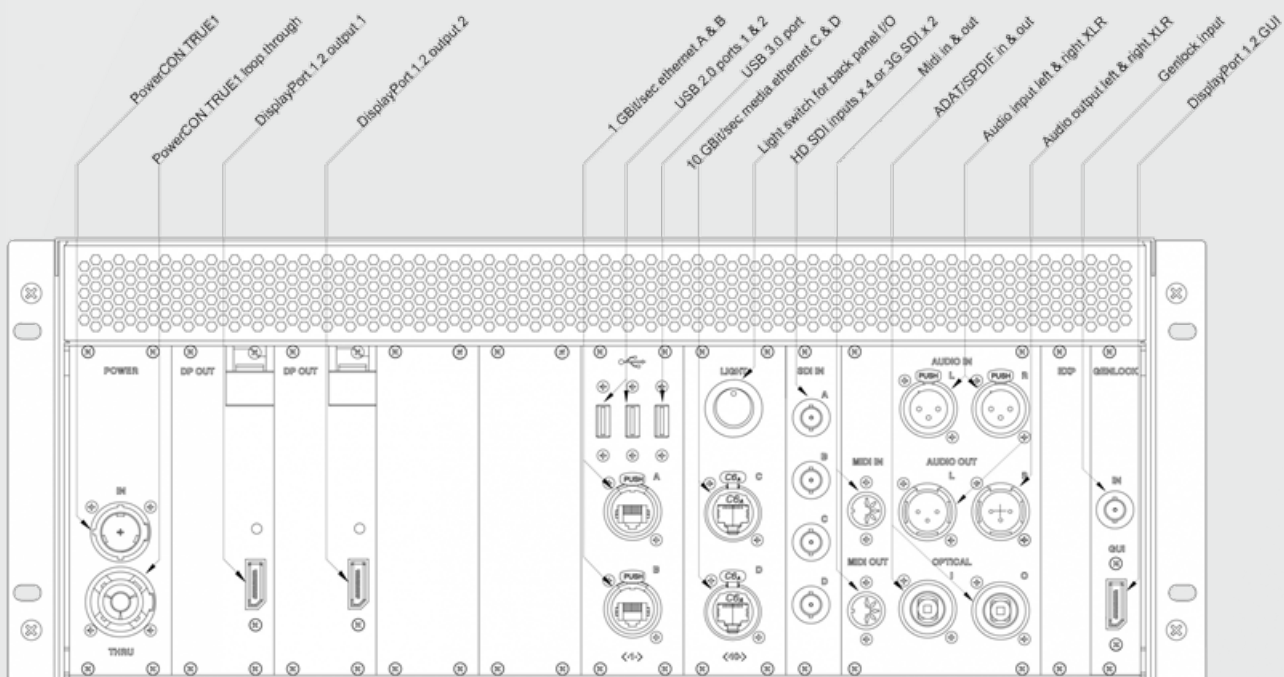

gx 2 rear panel annotated

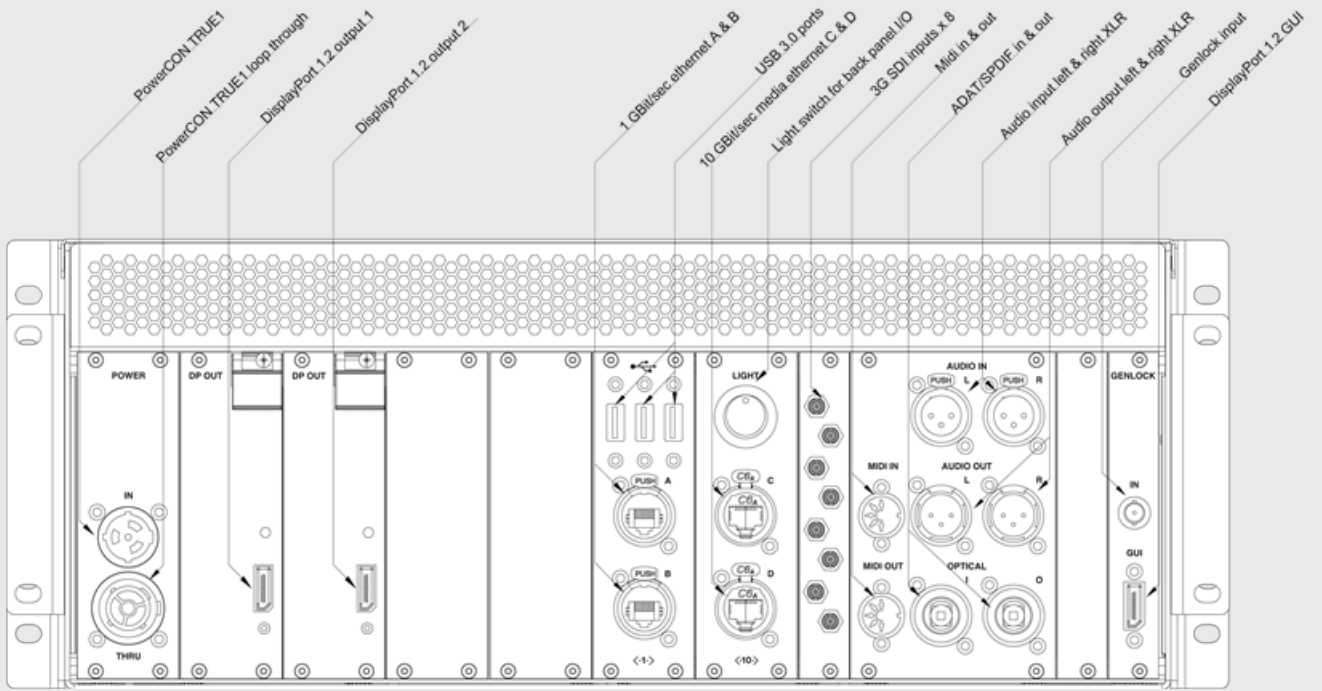

*gx 2c rear panel annotated*

*vx 4+ rear panel annotated*



# gx 2 Performance

## Playback

The following table shows how many layers can simultaneously be played back per codec:

Video Codec	Content Data Rate	Max Layers
HD HAP	27.8 MB/s	36
HD HAPQ	31.3 MB/s	31
HD Animation	107 MB/s	18
HD TIFF Sequence	237 MB/s	10
UHD HAP	95.4 MB/s	20
UHD HAPQ	143 MB/s	13
UHD Animation	697 MB/s	3
UHD TIFF Sequence	949 MB/s	2

### NOTES:

- All content is 30 fps
- Readings are taken from an Actor
- VFC-compatible machines run with pass-through style cards (HDMI or DP)
- 60Hz project
- Genlock on all machines which support it
- One unique video file per layer, all mapped onto one screen
- Absolute maximum level of performance
- One more layer means the system starts to drop frames

# Capture Latency

The following table provides data on how many frames of latency the gx 2 requires from capture to output:

## gx 2 SDI

Refresh Rate	Normal mode (frames)	Low Latency mode (frames)	Ultra-Low Latency (frames)
60Hz	5	4	3
50Hz	5	4	3
30Hz	5	4	3

## gx 2 NDI

Refresh Rate	Normal mode (frames)	Low Latency mode (frames)	Ultra-Low Latency (frames)
60Hz	6	5	4
50Hz	6	5	4
30Hz	6	5	4

# Powering the gx range

The pro and gx ranges of disguise servers use Neutrik powerCON TRUE1 as the power input. The TRUE1 is:

- Lockable
- Live-Mating (safely)
- Extendable
- Dust and water resistant according to IP65 in mated condition

To power a server, you should use a cable with the following attributes:

- SJT flexible cord, min. 12AWG, min. 300V, min. 60v dm;C, max 4.5 m long
- One end terminated with NEMA 5-15P/BS 1363/CEE 7 plug
- Other end terminated with appliance coupler type Neutrik AG, type NAC3FX

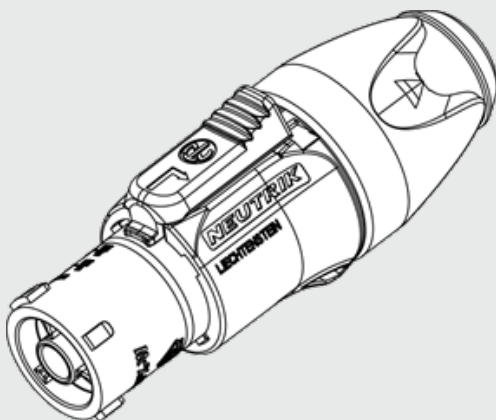

*Neutrik powerCON TRUE1 connector*

# Powering a multi server system

The gx 2 uses True1 Powercon as its power input and features a loop through to make powering a multi server system more efficient.

The power input to the machine is rated at 12Amps RMS per connection in Europe and USA.

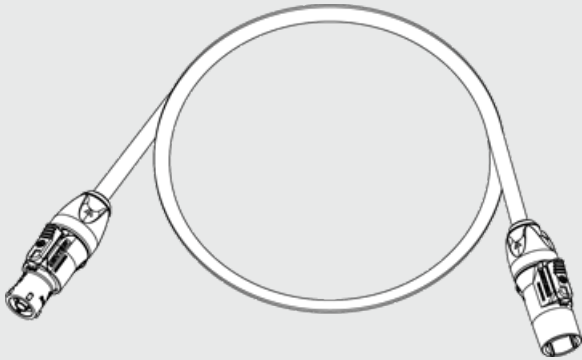

Loop through cables should have the following attributes:

- SJT flexible cord, min. 12AWG, min. 300V, min. 60v dm;C, max 4.5 m long
- One end terminated with appliance coupler type Neutrik AG, type NAC3MX-W
- Other end terminated with appliance coupler type Neutrik AG, type NAC3FX

# Power calculations for a safely powered system

It is important that you calculate how many gx range units you can daisy chain together using the in/loop connections provided. Failure to do so could result in a loss of power to the Disguise system.

Use the formula "Power = Voltage x Current" to calculate how many units you can chain together. For Example:

UK Power: 230V 13Amp rated supply.

For example, max power draw of a 4x4pro = 1400W (check technical specifications for your unit).

Available Power = 230V x 12A

Available Power = 2990W

Available Power / Max Power Draw = Number of Units

2990W / 1400W = 2.1 Units



**Warning:** Be safe! On a UK 13Amp supply @230V you can connect 2 Units safely with 100W of headroom

# How to start the unit

1. Connect Power cord to the gx 1gx 2 gx 2c
2. Make sure you have connected a keyboard, mouse and monitor to the primary graphics output.
3. Press the power button on the front of the unit and wait for the system to load into Windows.

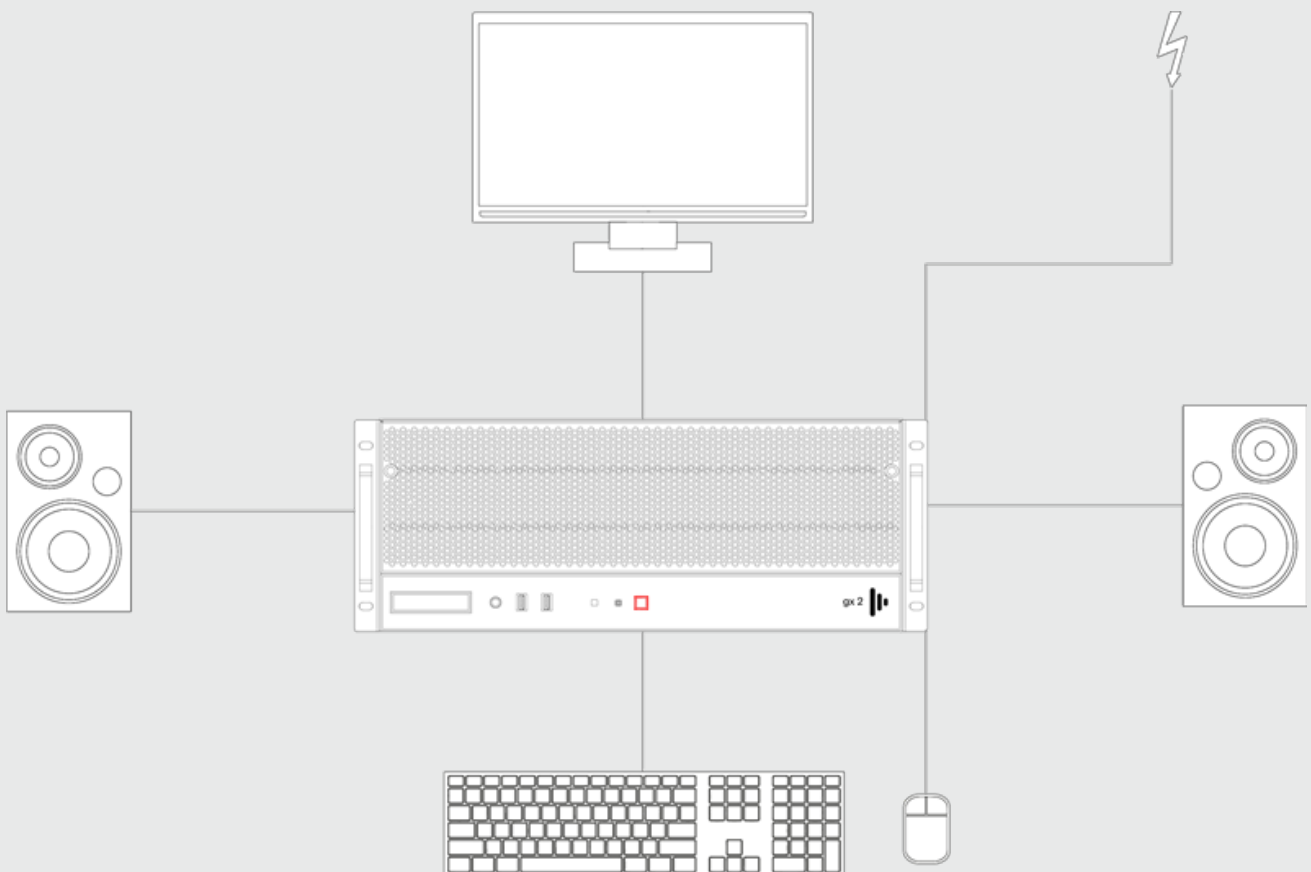

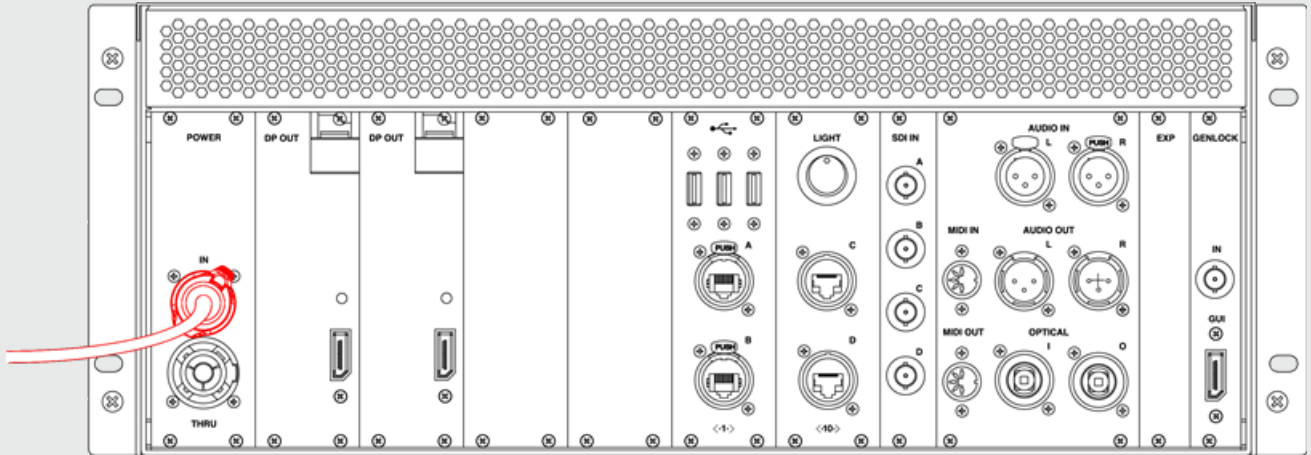

Location of power input on rear of gx 2gx 2c unit

# Update System- gx 2

The processes for restoring and reimaging a gx 2 server

## Overview

Internal system restore is the process of doing a factory restore on the system.

REDISGUISE is the process of doing an update or restore on the system using a bootable USB drive.

Neither of these restore processes affects the media drive of the server.

## Internal Restore

**Please note:** This procedure will only work with OS version 10 and greater.

To locate your OS version please go to **d3manager- Help - About d3manager**.

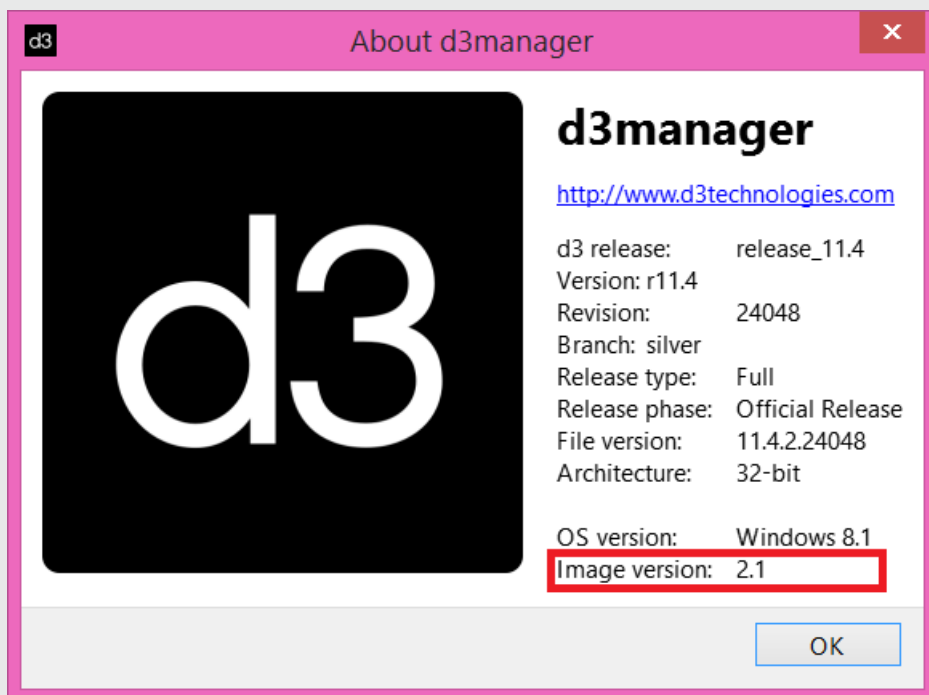





**Warning:** The system needs to be connected to the internet during this procedure. If it is not, or it loses internet connection during the process - windows activation will fail.

## Re-imaging the system

1. Hold down **shift** whilst restarting the system.

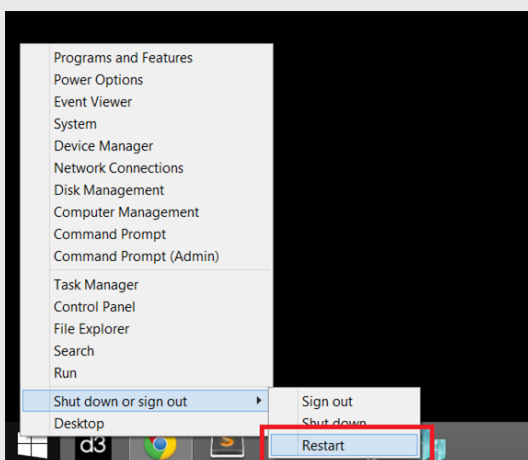
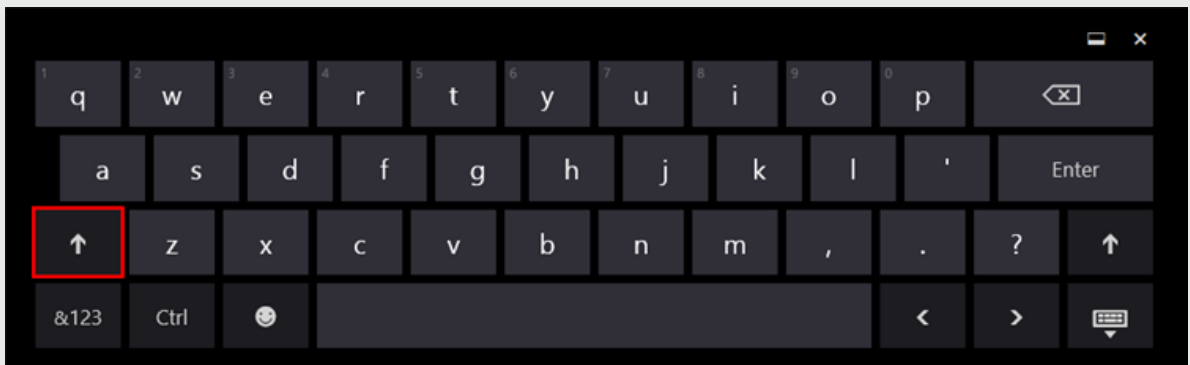

2. Select **Use another operating system**

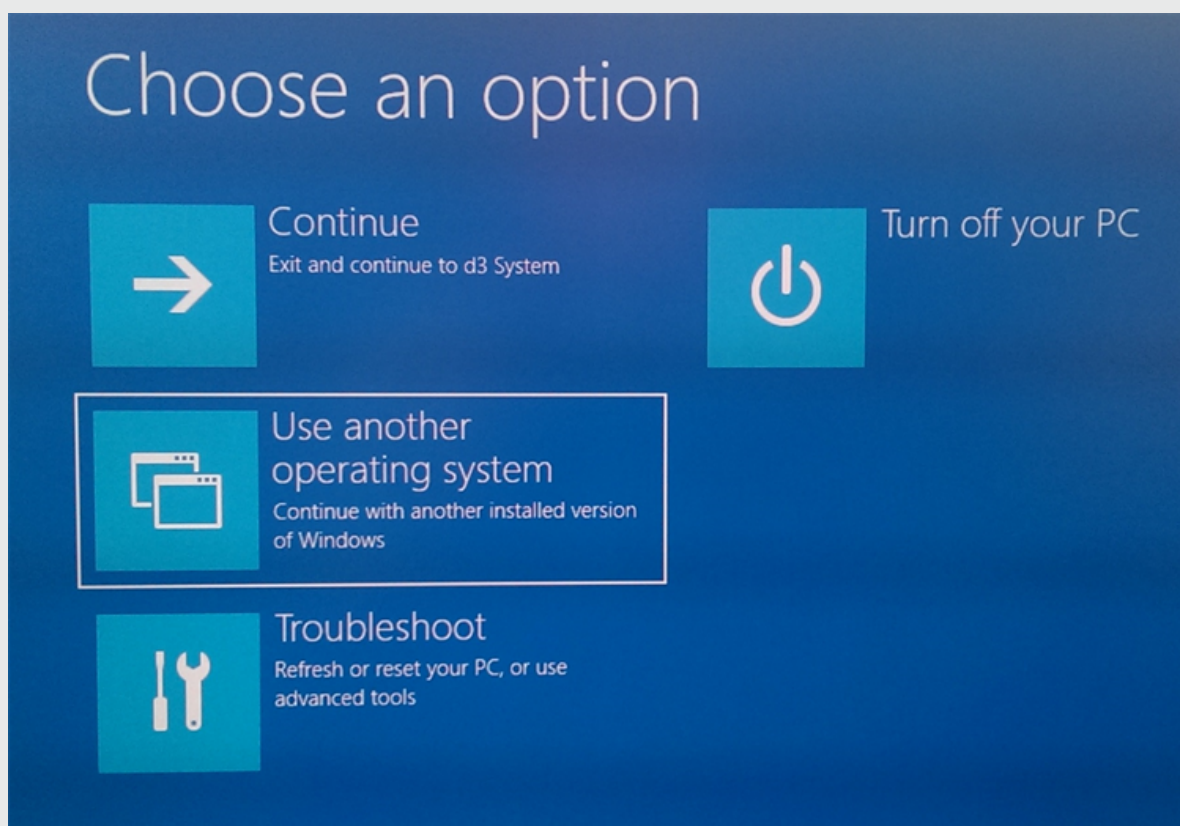

3. Select **Reset OS**.

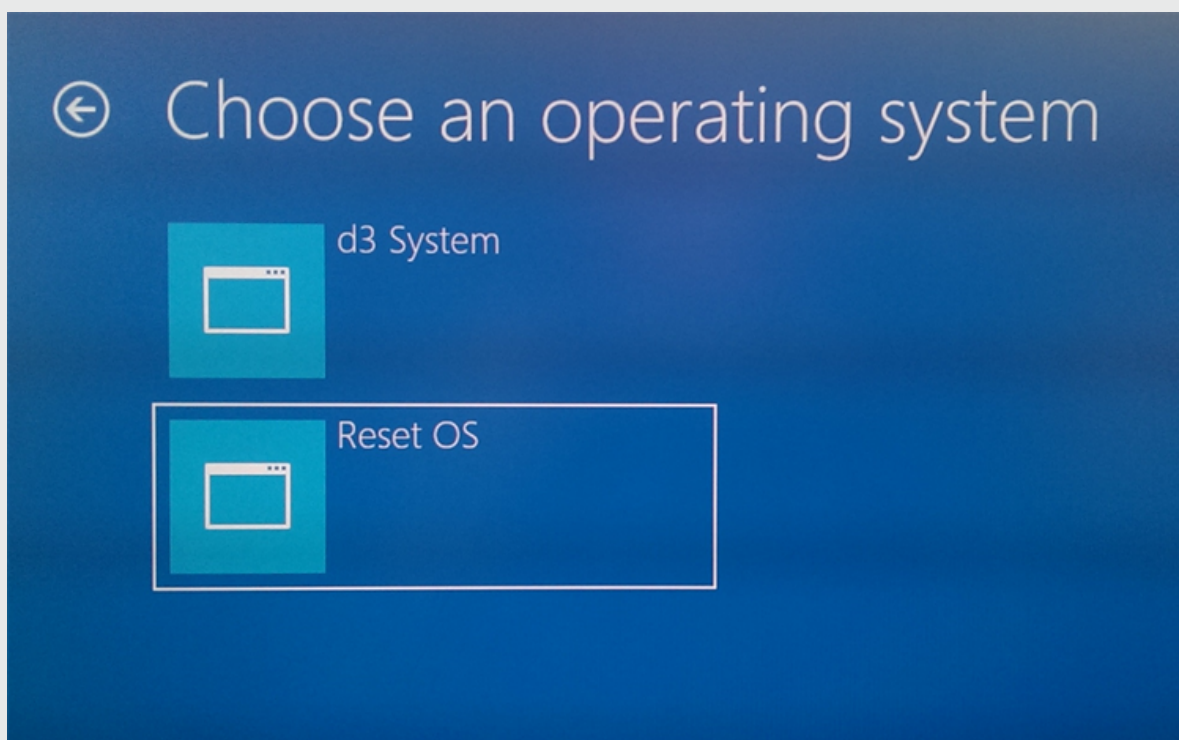

4. The system will reboot into the internal re-imaging system which will reinstall the Operating System and revert settings to factory

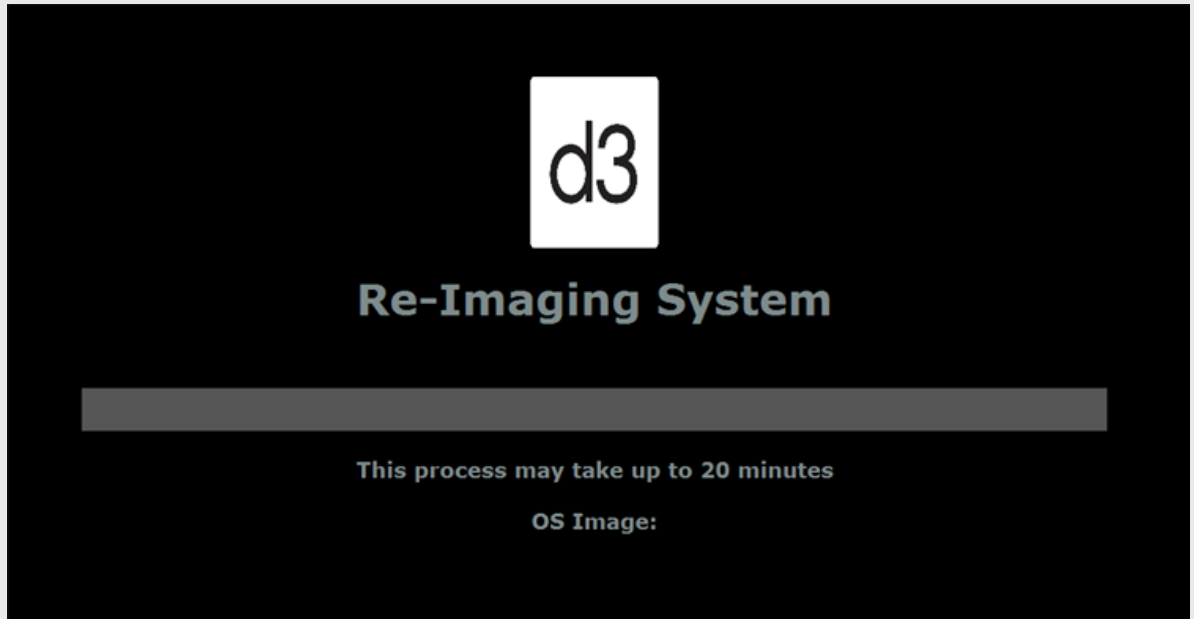

## Activating windows

Windows should activate automatically, as long as the machine was connected to the internet for the duration of the re-imaging process.

If windows does not activate during the re-imaging process, follow these steps.

1. Wait for a few minutes after the re-imaging process has completed to allow the server time to activate Windows.

2. Navigate to the System tab by right clicking on the Windows start menu and selecting **System**

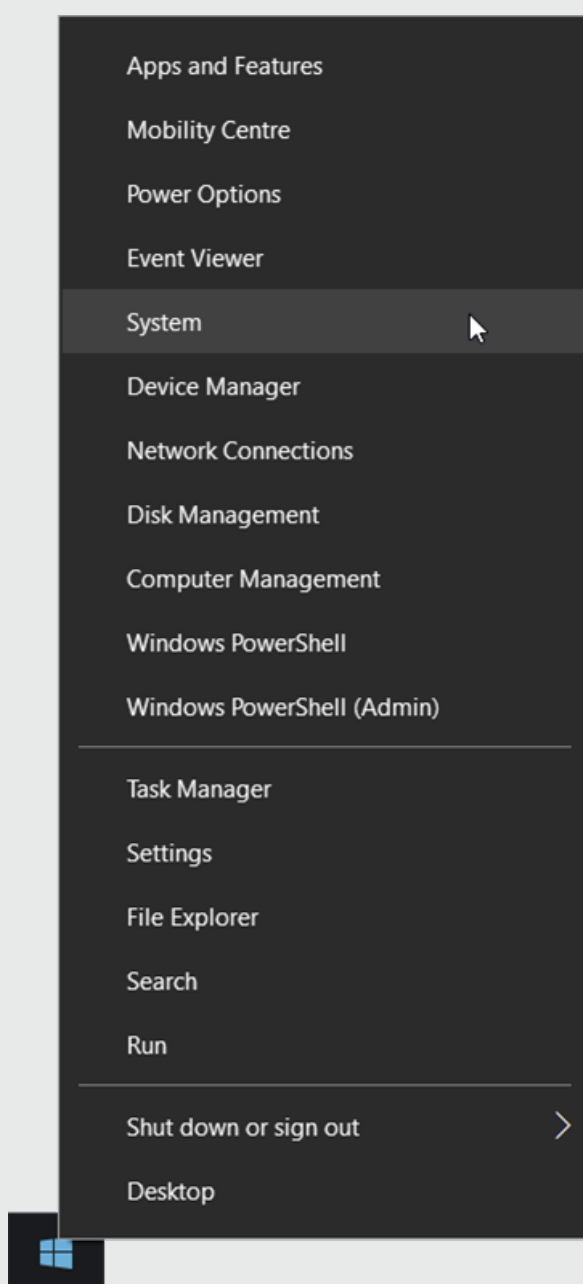

3. In the System window, check to see if you have valid Windows license information visible. If you do not, contact the [disguise support team](#).

# REDISGUISE

**Please note:** If you experience any problems during updating or restoring the system, or any of these instructions are unclear, please contact the [support team](#).



**Warning:** The system needs to be connected to the internet during this procedure

The gx range handles updates by using installers which are firm ware packages that encompass updates from the ground up.

This process can be used to update to a newer OS image, or revert to a previous OS image.

To tell what OS image your system is on please go to the help menu in [d3manager](#) and select **About d3manageranager**.

## You will need

- A 32Gb USB memory stick
- A version of [Rufus](#) to turn it into a bootable disk. Make sure the volume name of the USB is: "REDISGUISE" as per image
- An internet connection to the machine you are re-imaging
- Download and install a version of [7Zip](#)
- Download and unzip the multi file archive using 7Zip
- OS images can be found [here](#).

**Please note:** You do not need to extract all parts individually. Simply place them in the same directory and then use 7zip to extract the ISO by selecting any part. 7zip will automatically unzip all parts to create the image file.

# Create Bootable USB device

1. Download and unzip the multi-file archive using 7Zip (NOTE: you will only need to unzip file 001):

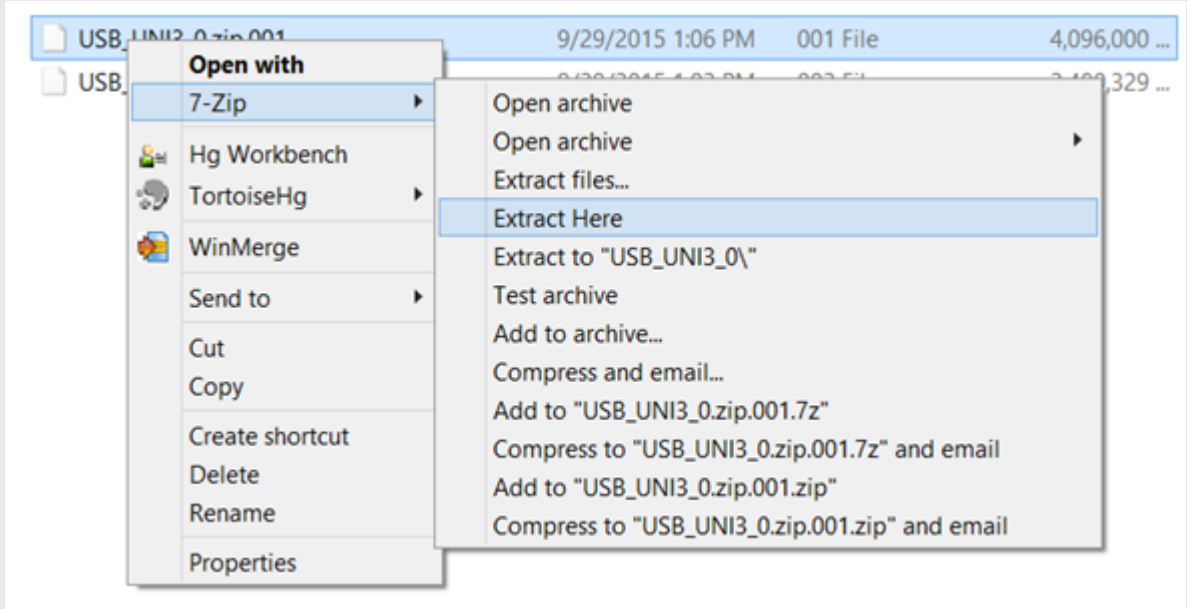

2. Create Bootable USB stick with the unzipped ISO.

The settings should be:

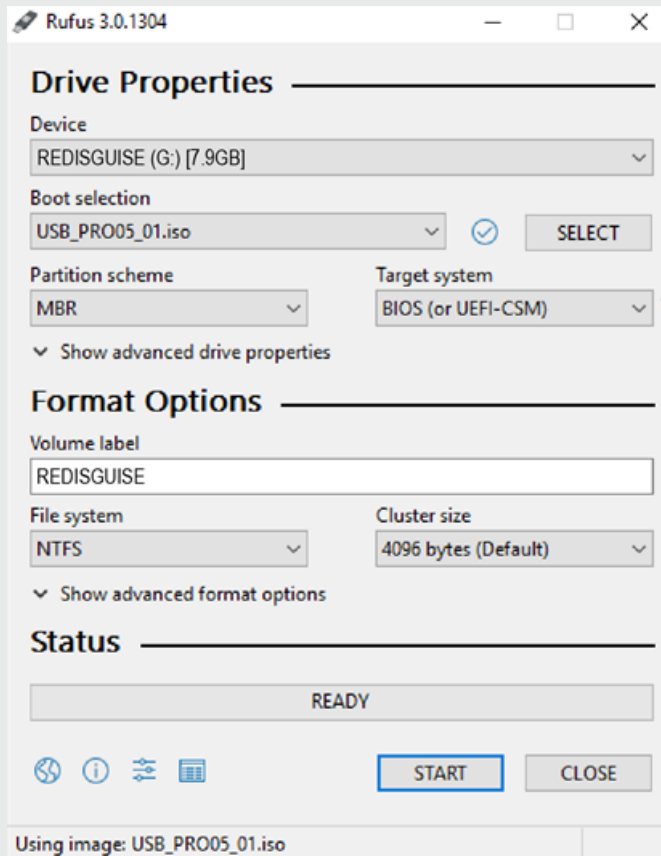

- Partition scheme - MBR
- Target system - BIOS (or UEFI-CSM)
- Volume label - automatically pulled from ISO file
- File system - NTFS



**Warning:** These settings are critically important. The re-image process will fail if they are not set correctly.



**Please note:** On the latest versions of Rufus you may see this warning. This is expected and does not apply to current disguise hardware. Please click **OK** to continue as normal.

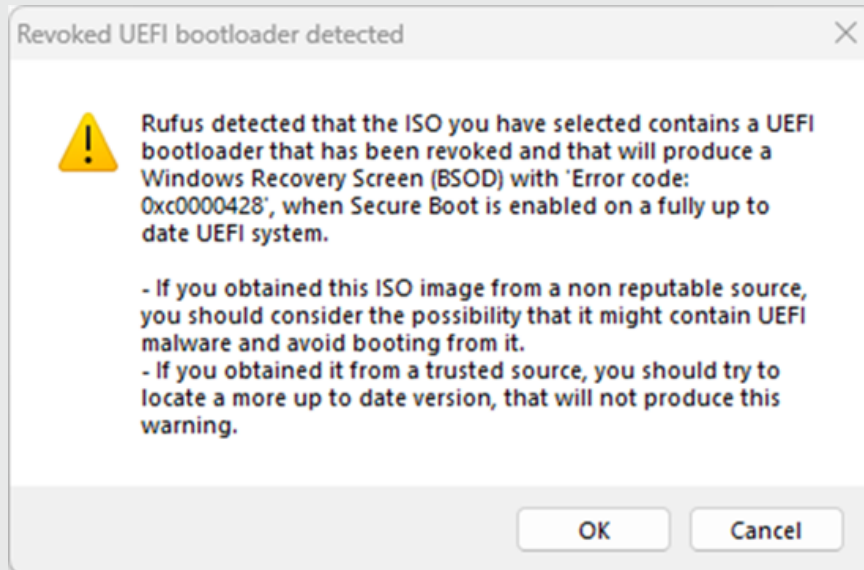

## Booting into the USB

1. Go into the BIOS by hitting Delete on the logo splash screen during boot.
2. Navigate to the **Boot** tab using the arrow keys and select **Harddrive BBS Properties**. Hit **Enter** to access the properties.
3. Navigate to the Advanced tab and change the Boot option #1 to the USB stick.
4. Do not select Save and Exit. Hit escape, and navigate to Save & Exit tab.
5. Select your USB stick from the Boot override menu. Press Enter.
6. Be ready to hit any key to confirm USB boot immediately after.

**Please note:** performing a system restore from the new disk image will erase any valuable data on your system drive. Please ensure you make a back up of any essential files from your system (C:) drive before initialising this process. The process does NOT destroy any media or projects on your media drive.

# Unit rear light

Disguise servers in the pro and gx ranges come with the addition of an LED light on the back of the unit that illuminates the connections on the rear panel.

The light can be turned on or off using the switch labeled "light" with power in.

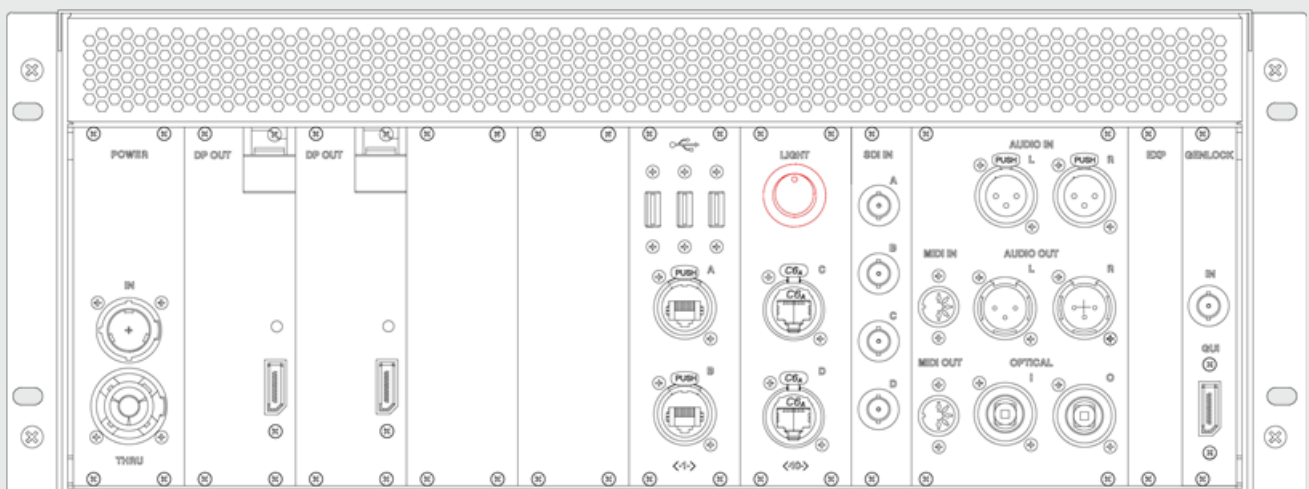

Location of light switch on rear of a gx 2c

# Video input

Your Disguise system is equipped with capture cards. These cards have the ability to capture live video from either SD-SDI or HD-SDI video sources with up to four unique feeds, or two unique 3G-SDI feeds per machine.

## Max Number of Unique Inputs

	SD-SDI	HD-SDI	3G-SDI
gx 2	4	4	2
gx 2c	8	8	8



**Warning:** 4K resolutions is currently only supported over quad split HD-SDI

## Supported formats

720x486i @ 59.94 Hz NTSC

720x576i @ 50.00 Hz PAL

1280x720p @ 23.976Hz, 24Hz, 25Hz, 29.97Hz, 30Hz, 50Hz, 59.94Hz, 60Hz

1920x1080i @ 47.96Hz, 48Hz, 50Hz, 59.94Hz, 60Hz

1920x1080PsF @ 23.976Hz, 24Hz, 25Hz, 29.97Hz, 30Hz

1920x1080p @ 23.976Hz, 24Hz, 25Hz, 29.97Hz, 30Hz, 47.96Hz, 48Hz, 50Hz, 59.94Hz, 60Hz

2048X1080p @ 23.976Hz, 24Hz, 25Hz, 29.97Hz, 30Hz, 47.96Hz, 48Hz, 50Hz, 59.94Hz, 60Hz

2048X1080i @ 47.96Hz, 48Hz, 50Hz, 59.94Hz, 60Hz

2048x1556PsF @ 14.98Hz, 15Hz, 18.98Hz, 19Hz

4K UHD 3840x2160, 4K P/PsF @ 23, 24, 25, 29, 30fps

4K DCI 4096x2160, 4K P/PsF, @23, 24, 25, 29, 30fps

It is possible to have a different format on each input, However the limitations are a maximum of 1x 4k or 2x 1080p60.

If you are using 1x 4k or 2x 1080p it is not possible to use any other video inputs on the unit due to hardware limitations.

# Back-Plate Layout



Diagram of Video Capture BNC connections on rear of gx 2.

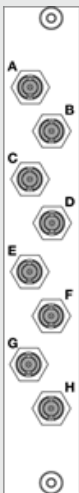
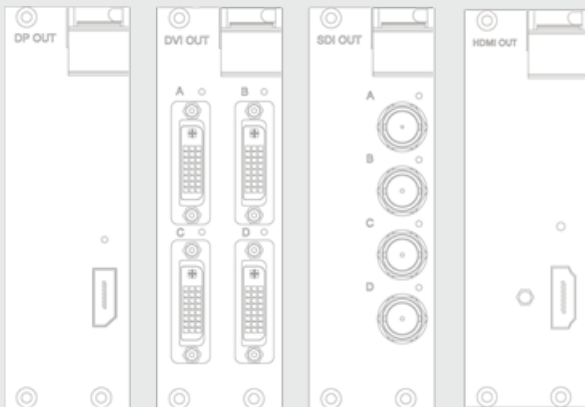

Diagram of Video Capture BNC connections on rear of a gx 2c.

**Please note:** Live Video input inherently introduces frame latency during playback. Please contact [Support](#) for guidance on performance standards.

# Video output

The pro and gx ranges of disguise servers come with a range of possible output configurations. It is possible to use a combination of any of the types of four VFC cards below.



Display Port 1.2	Quad DVI	Quad SDI	HDMI
------------------	----------	----------	------

1 Output per card	4 Outputs per card	4 Outputs per card	1 Output per card
Max res: 4096x2160	Single Link DVI: (up to) 1920 x 1200	Max res: 1920 x 1080	Max res: 4096x2160 @60 YCbCr444 8bit 3840x2160 @60 YCbCr422 10bit* 3840x2160 @30 YCbCr444 10bit
LED indicator	LED indicator	LED indicator	LED indicator
Genlocked	All outputs genlocked	All outputs genlocked	Genlocked

# 4K Output



Warning: We highly advise using DisplayPort cables specifically validated for: DP 1.2, DP 1.2a or 21.6 Gbps bandwidth

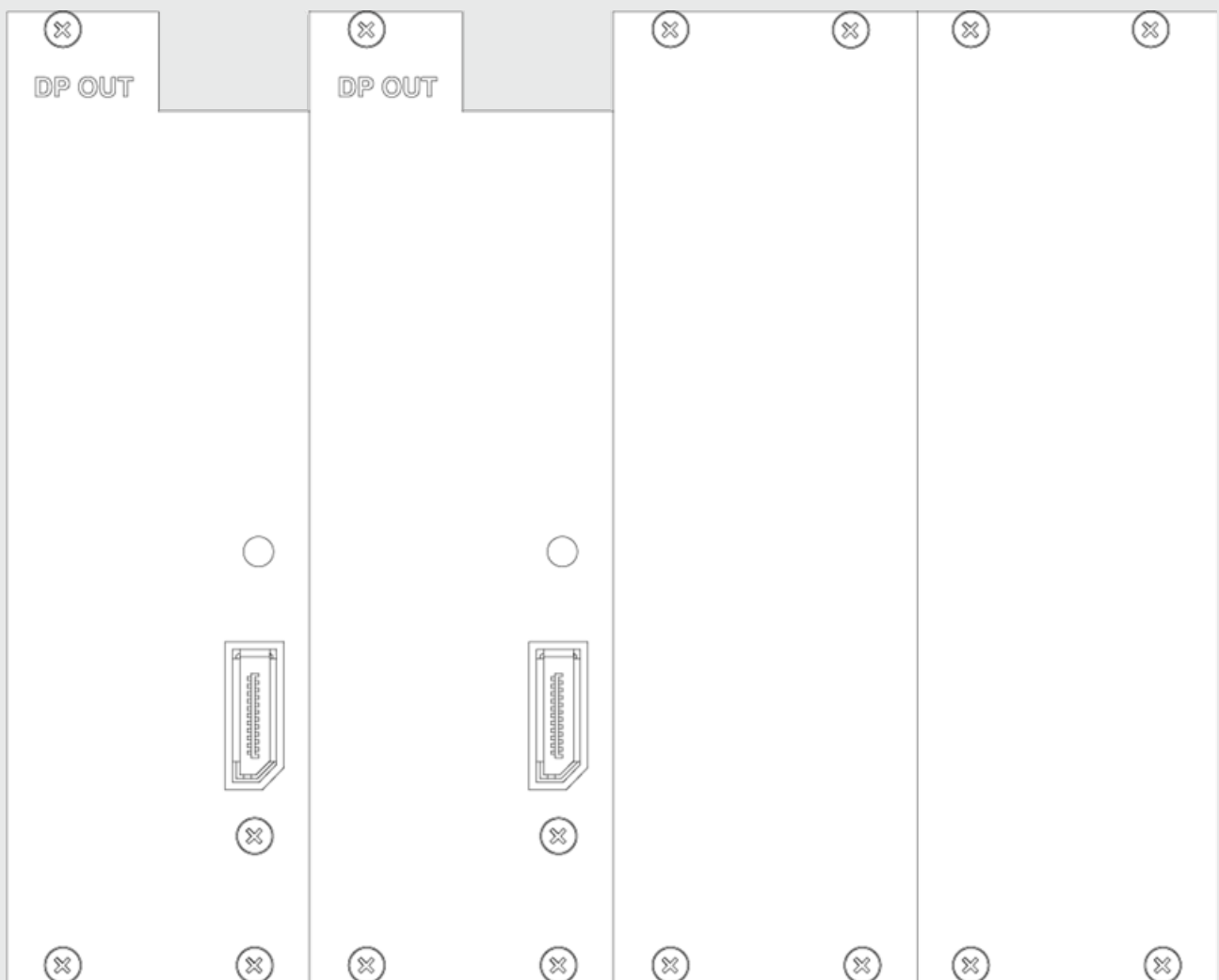

2 x DisplayPort 1.2 outputs on rear of gx 2

This enables the pro & gx ranges of disguise servers to support resolutions up to 4096x2160 60hz over Single Stream Transport.

# Audio input and output

The gx 2 & gx 2c is equipped with a broadcast quality pro audio card which uses the latest 192kHz AD and DA converters.

## Back panel connections

- XLR Left + Right Input
- XLR Left + Right Output
- ADAT/SPDIF Input
- ADAT/SPDIF Output
- MIDI Input
- MIDI Output

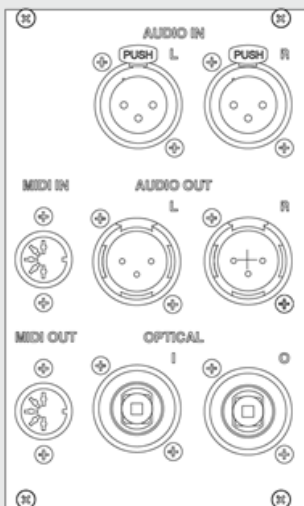

Audio connections on rear of gx 2 unit.

## Front panel connections

- 1/4inch Stereo Monitoring socket



It is possible to monitor audio output from the unit from the 1/4inch stereo socket with a pair of headphones.

## RME card settings

1. Go to the Windows Start Menu.
2. Right click on the speaker in the task tray next to the clock on the desktop and click on Playback Devices.
3. Scroll Down and Right-click the device named Speakers and select Set as Default device if it is not already selected.

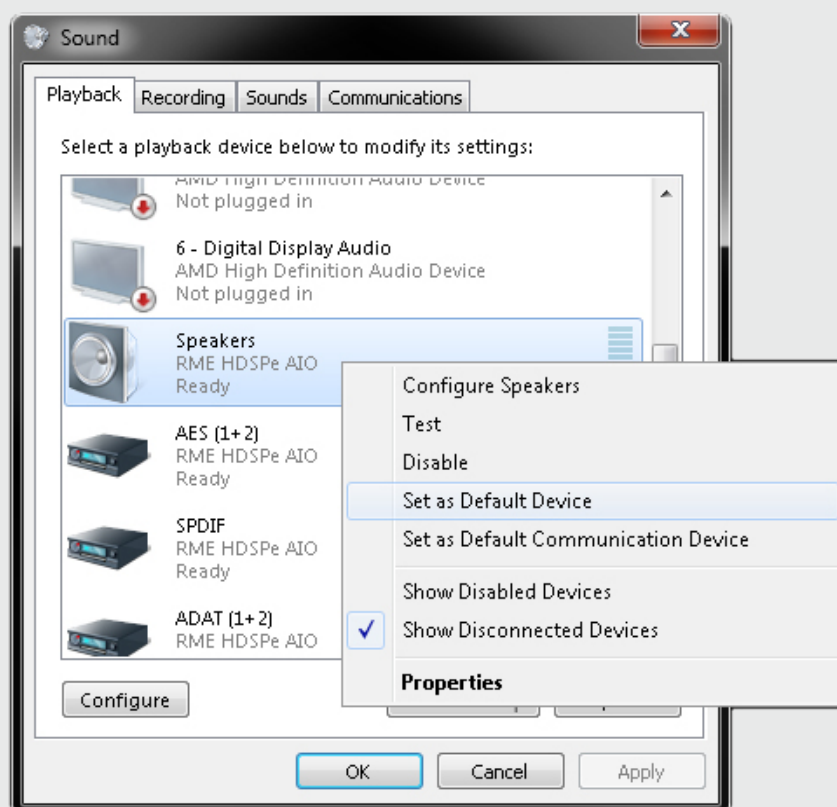

# fabric Overview

Fabric is a preconfigured network switch that was built to connect your vx and rx servers at the highest bandwidth so that each frame is delivered accurately.

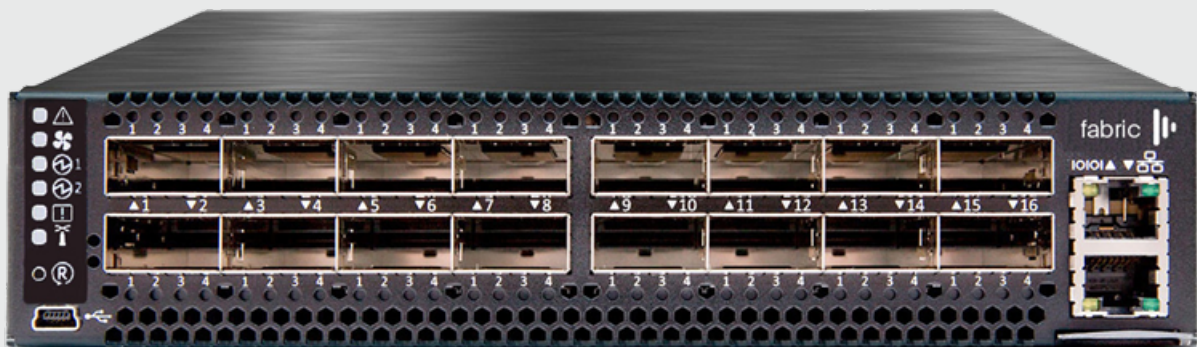

*fabric rear panel*

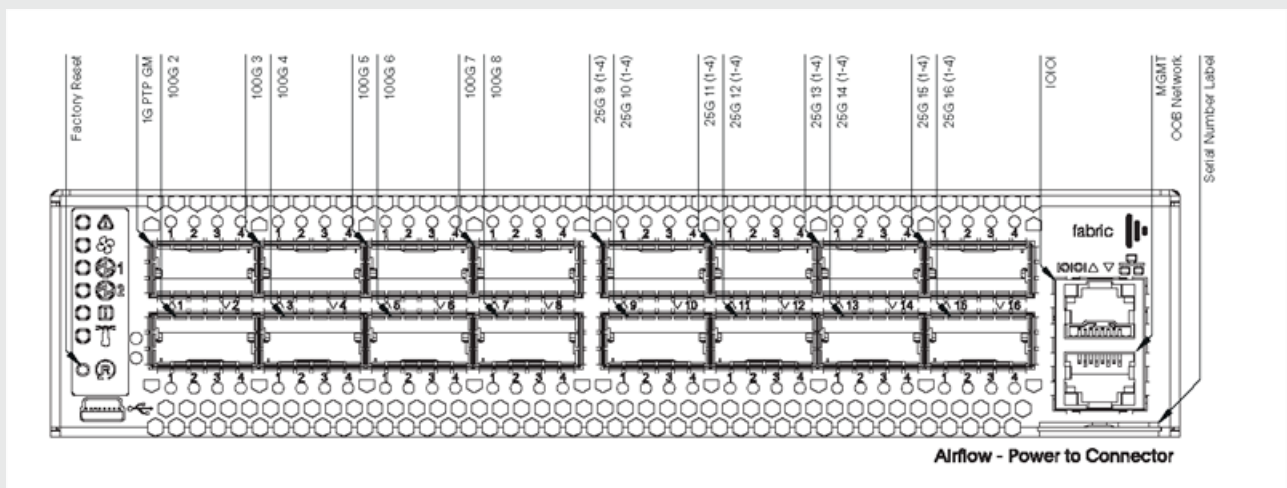

*fabric rear annotated*

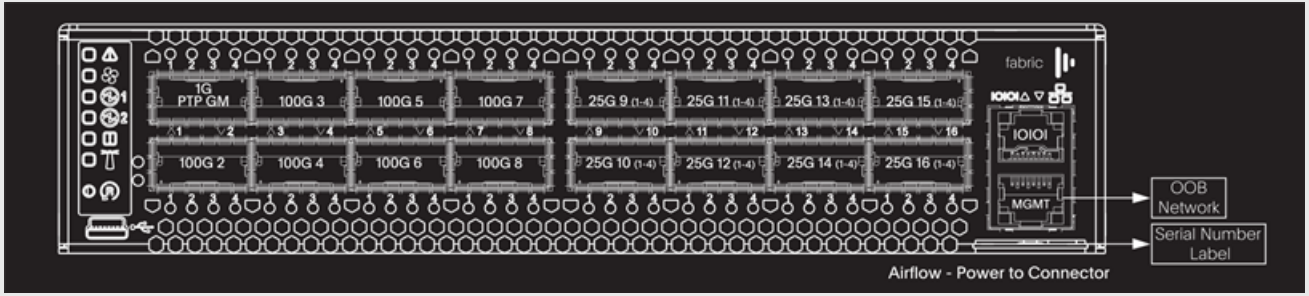

*fabric rear detail*

# fabric Quick Start

fabric is preconfigured to work with all your Disguise products.

Please read the instructions on this quick start guide carefully to understand how to work with your new system.



*fabric rear panel*

fabric is designed to be used to connect one or multiple rx render servers to the vx media servers in your system and syncing with third party render engines seamlessly over RenderStream.

This Fabric QuickStart guide is also available for download [here](#)

## Configuration

# Port 1

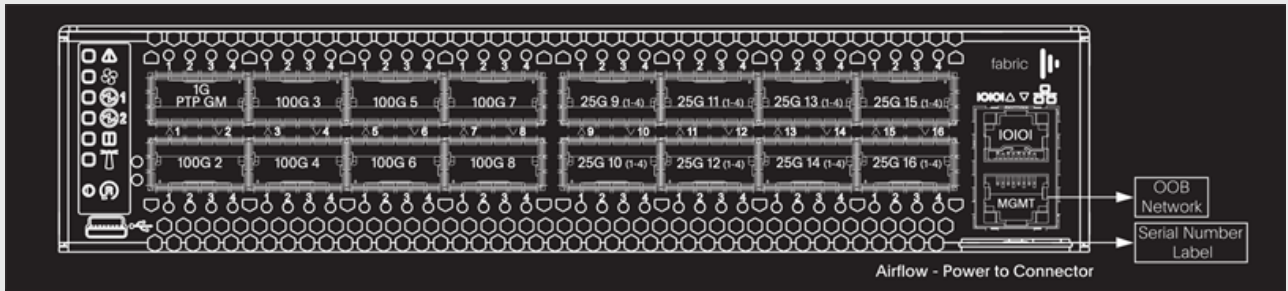

*fabric rear detail*

Port 1 is configured as 1G and can be connected to a PTP Grand Master using a QSFP to SFP adapter.

## Ports 2-8

Ports 2-8 are configured as 100G to connect to your 100G vx series server. Please use QSFP28 cables or optics for connection.

## Ports 9/ 1-16/ 4

Ports 9/ 1-16/ 4 are configured as split 25G ports. This means that each port has 4 x 25G inside it. You can connect using a QSFP28 optic with fibre splitter to a 4 x SFP28.

## Password protected

The switch is password protected. Please contact [disguise support](#) if you need to amend the configuration.

## DHCP

The fabric switch comes preconfigured with a DHCP and DNS server to ease setup over the fabric network. Any device plugged into the network is accessible on the fabric domain. Example: \\rx-559999.fabric.

The DHCP server is configured to allocate IP addresses in the range of 10.250.222.5-10.250.222.250/24.

To access DHCP configuration and logs, please point your browser to **switch.fabric:8080/**

# Power

Follow these steps to properly power up your fabric.

1. Plug in both power cables
2. Wait for the system to boot automatically.
3. Wait for the system status LED to turn green. If the system LED turns red, please contact [disguise support](#).

**Power Rating:** 100-127 VAC 50/60Hz 4.5A or 200-240VAC 50/60Hz 2.9A

# NMOS

The switch comes preconfigured with AMWA NMOS registry that can be accessed on the following address: **switch.fabric:8010/**

# VFC Cards

The powerful proprietary disguise VFC card allows a server to be easily configured for DVI, SDI, HDMI, and/or DP outputs.

## Slot Info

Information on a VFC slot can be accessed from within the Feed window. For more information on configuring VFC slots from the Feed Window, visit [this link](#)

## Specs

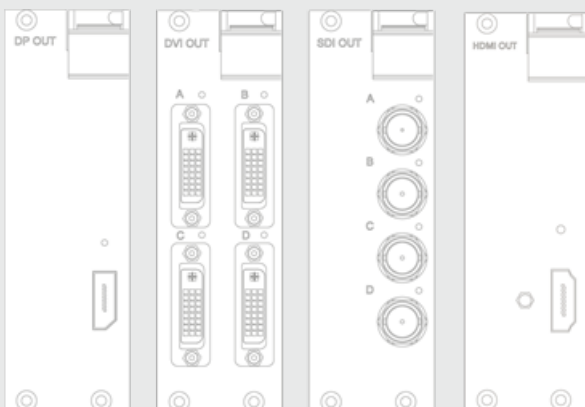

Display Port 1.2	Quad DVI	Quad SDI	HDMI
------------------	----------	----------	------

1 Output per card	4 Outputs per card	4 Outputs per card	1 Output per card
Max res: 4096x2160	Single Link DVI: (up to) 1920 x 1200	Max res: 1920 x 1080	Max res: 4096x2160 @60 YCbCr444 8bit 3840x2160 @60 YCbCr422 10bit* 3840x2160 @30 YCbCr444 10bit
LED indicator	LED indicator	LED indicator	LED indicator
Genlocked	All outputs genlocked	All outputs genlocked	Genlocked

## LED Codes

The colour of the LED on the VFC card indicates the status of the card as follows:

**White:** The VFC card is receiving power but no connection has been made to it. FPGA is booting. LED should power off after going white. If it is stuck on white, the VFC is has not booted correctly and is not in a good state. Requires attention.

**Blue:** The VFC card is receiving power and disguise is establishing a connection. Flashing blue indicates a persistent error and the VFC is constantly trying to re-configure itself. Requires attention.

**Green:** The VFC card is operating normally.

**Orange:** If this does not resolve, this indicates an error, possibly with the FPGA. Requires attention.

**Pink:** In early days of the DP VFC card, a Pink LED indicated an programming issue with the card. This status code has been corrected in a later software release and should no longer need attention.



# IP-VFC Overview

## Introduction to the IP-VFC

The IP-VFC card is the next-generation of the Video Format Conversion (VFC) card. This is a patented technology that enables users to change the video output signal from their disguise media server to a SMPTE 2110 video output.



SMPTE 2110 was introduced in 2015 as the evolution of SDI to IP. RenderStream was launched in 2020 alongside the rx to enable our customers to scale products by distributing render power across multiple nodes and uses part of the ST-2110 specification as a mechanism for transporting data.

A key feature of the VFC format is that it enables the ability to swap inputs without having to do any external conversion, and thus keeping video latency to a minimum.

The demand for SMPTE 2110 video output has grown in the media and entertainment space, and the IP-VFC card is the next stage in disguise's journey to IP workflows.

Unlike regular VFC cards the IP-VFC card has four 25GbE ports to enable 4K video at 60p using YUV 4:4:4 chroma subsampling\*, and a bit depth of 10-bit - all with very low latency.

Small form-factor pluggables (SFPs) feature different connections that can be used to enable a host of different outputs, such as 3G SDI or 12G SDI.

This means that video can be outputted from a disguise media server using 12G-SDI or quad-SDI, depending on which combination of SFPs that are used.

We have also included an OLED screen on the IP-VFC, which can be used to access a quick-display menu.

# IP-VFC Overview

## Introduction to the IP-VFC

The IP-VFC card is the next-generation of the Video Format Conversion (VFC) card. This is a patented technology that enables users to change the video output signal from their disguise media server to a SMPTE 2110 video output.



SMPTE 2110 was introduced in 2015 as the evolution of SDI to IP. RenderStream was launched in 2020 alongside the rx to enable our customers to scale products by distributing render power across multiple nodes and uses part of the ST-2110 specification as a mechanism for transporting data.

A key feature of the VFC format is that it enables the ability to swap inputs without having to do any external conversion, and thus keeping video latency to a minimum.

The demand for SMPTE 2110 video output has grown in the media and entertainment space, and the IP-VFC card is the next stage in disguise's journey to IP workflows.

Unlike regular VFC cards the IP-VFC card has four 25GbE ports to enable 4K video at 60p using YUV 4:4:4 chroma subsampling\*, and a bit depth of 10-bit - all with very low latency.

Small form-factor pluggables (SFPs) feature different connections that can be used to enable a host of different outputs, such as 3G SDI or 12G SDI.

This means that video can be outputted from a disguise media server using 12G-SDI or quad-SDI, depending on which combination of SFPs that are used.

We have also included an OLED screen on the IP-VFC, which can be used to access a quick-display menu.

# IP-VFC ST 2110

## What is ST 2110?

In its most basic form, whereas SDI transmits a mixed feed of video, audio, and ancillary unidirectionally, ST 2110 breaks apart each elementary stream of audio, video and ancillary.

This removes the need to transmit and demix the other components not required for that portion of processing, eliminating the need for any additional signaling or cabling and makes redundancy much easier - particularly in large installations.

ST 2110 uses COTS technology within its infrastructure. This enables users to take advantage of the economies of scale of the IT industry, and be able to support any technological advancements made within its infrastructure easier than with baseband SDI.

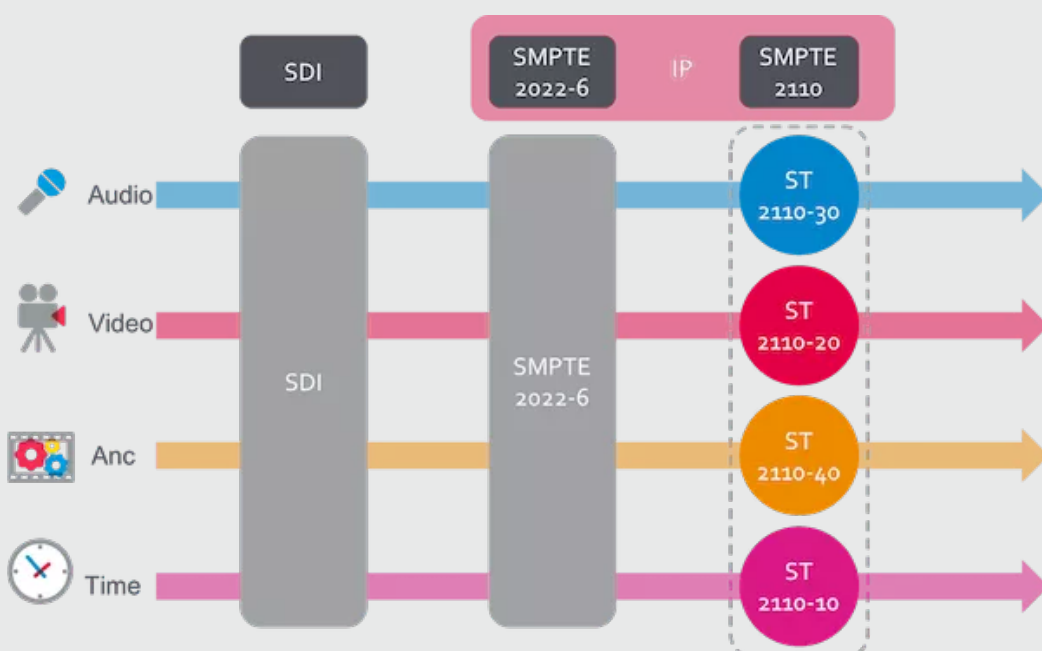

Source: <https://netinsight.net/what-is-smpte-2110-and-nmos-all-about-2>

# IP-VFC - Ports

## Ports

The IP-VFC card operates in two modes - ST 2110 and SDI:

Port	Mode
1	ST 2110 video
2	Redundant ST 2110 video
3	SDI video
4	SDI video

The IP-VFC can be set up in a way in Disguise whereby users could switch between two modes - ST 2110 and SDI.

ST 2110 mode supports up to a 25Gb video stream from Port 1 using SFPs. A redundant signal using Port 2 can be enabled in the event that the signal from Port 1 goes down, using SMPTE 2022-7 for packet-level redundancy.

Ports 3 and 4 are used for SDI video signals using SFPs. Either a SINGLE output can be completed using a 12G SDI SFP, or a QUAD output using quad-SDI SFPs on Ports 3 and 4.

# IP-VFC - PTP

## What is PTP?

The Precision Time Protocol (PTP) is a protocol used to synchronize clocks throughout a computer network. On a local area network, it achieves clock accuracy in the sub-microsecond range, making it suitable for measurement and control systems.

ST 2110 is bidirectional, meaning that separate signal paths no longer need to be constructed to distribute sync signals. Instead, each elementary stream (video, audio and ancillary) can be broken apart. This is useful for a disguise system, since we are only requiring the output of video.

Each elementary stream of video, audio and ancillary is then timestamped using PTP. This enables high levels of frame synchronisation as a common timecode base can be shared to each stream to the nanosecond.

This is important when implementing an IP-based video infrastructure because switchers, routers and other network infrastructure all increase latency within a system.

Genlock is enabled from the IP-VFC using PTP. This means that if users wanted to output a video signal from the 25Gb port or SFP and wanted it locked to PTP, this could be enabled without the need for genlock.

The IP-VFC card uses the SMPTE 2059-2 profile for PTP, which is used with devices configured to operate using ST 2110 for video and audio. The PTP operating modes that the IP-VFC card supports are multicast and mixed.



# IP-VFC - NMOS

## What is NMOS?

Networked Media Open Specifications (NMOS) provide an open and simple to use control-plane solution that enables interoperability and management of IP connected audio and video devices.

NMOS enables an open, interoperable IP video system to replace SDI in Broadcast and ProAV applications everywhere.

NMOS provides a simple, vendor-neutral way to connect SMPTE ST 2110 senders and receivers, as ST 2110 does not inherently do this.

Underpinning ST 2110 is NMOS (Networked Media Open Standard), which is a group of specifications that allows for orchestration of media flows on an IP network. NMOS makes ST 2110 based infrastructure manageable and simpler to operate.

The IP-VFC card supports NMOS AMWA IS-04 Discovery & Registration and ANWA IS-05 Connection Management. This allows users to see any other NMOS-enabled devices on the network.

# IP-VFC - Split Mode

## Split Mode

**Split Mode** indicates how the video is outputted. The IP-VFC can be set up so that users can switch between two modes - ST 2110 and SDI.

**Small form-factor pluggables (SFPs)** feature different connections that can be used to enable a host of different outputs, such as 3G SDI or 12G SDI.

- **SINGLE Mode** means a single video output is enabled, and would be used if using a 25Gb or 12G SDI SFP for example

ST 2110 mode supports up to a 25Gb video stream from Port 1 using SFPs. A redundant signal using Port 2 can be enabled in the event that the signal from Port 1 goes down, using SMPTE 2022-7 for packet-level redundancy.

- **QUAD Mode** splits the image into four quadrants, and would be used if using dual SDI SFPs for Quad-SDI output for example

Ports 3 and 4 are used for SDI video signals using SFPs. Either a SINGLE output can be completed using a 12G SDI SFP, or a QUAD output using quad-SDI SFPs on Ports 3 and 4.

# IP-VFC - Interoperability

## Interoperability

The IP-VFC card has been designed to work in disguise hardware using backplane version 2 (BPv2) only.

Machines with backplane version 1 (BPv1) will not be able to use IP-VFC card slots

Machines with BPv2 will not function with legacy DP1.2 VFC cards, but will continue to work with all other VFC cards (HDMI 2.0, QDVI, QSDI, DP1.4)

PRODUCT	WILL IT WORK WITH IP-VFC?	HOW MANY OUTPUT SLOTS CAN I INSTALL WITH IP-VFC?
4x4pro	No	
4x2pro	No	
gx 1	No	
gx 2	No	
gx 2c	No	

PRODUCT	WILL IT WORK WITH IP-VFC?	HOW MANY OUTPUT SLOTS CAN I INSTALL WITH IP-VFC?
gx 3	Yes	Up to 3 slots
vx 1	Yes - after and including 16174	Up to 1 slot
vx 2	Yes - after and including 26274	Up to 2 slots
vx 4	Yes - after and including 44510	Up to 4 slots
vx 4+	Yes	Up to 4 slots

# IP-VFC - Backplane upgrade

## Upgrading your backplane to support IP-VFC

In order to determine the current backplane version, right-click on the VFC card in the Designer feed editor. The software will show the backplane version number.

It is also available in the “Help” dropdown on D3 Manager.

For any vx media servers that are running backplane version 1 and would like to install IP-VFC cards, we can offer the following upgrade kit:

PRODUCT	SKU
<b>Backplane version 2</b>	d-X41007
<b>Service centre (8 hours total)</b>	d-706000

# IP-VFC

## Specifications SDI

## Specifications SDI

All video standards outlined here have been tested in SDI modes across:

- Bit depth - 10-bit (all modes)
- Chroma subsampling
  - YUV 4:2:2 (all modes)
- Colour space
  - REC 709,
  - REC 2020
  - (all modes except HD Video at 1280 x 720  
which supports REC 709 only)

SDI modes are now supported in Designer software version r24.0.1. We are working towards supporting video standards at 48Hz in a future release.

### **4K DCI (4096 x 2160)**

4K DCI 23.98p, 4K DCI 24p, 4K DCI 25p, 4K DCI 29.97p, 4K DCI 30p, 4K DCI 50p, 4K DCI 59.94p, 4K DCI 60p (SINGLE)

### **UHD (3840 x 2160)**

2160p23.98, 2160p24, 2160p25, 2160p29.97, 2160p30, 2160p50, 2160p59.94, 2160p60 (SINGLE)

**2K DCI (2048 x 1080)**

2K DCI 23.98p, 2K DCI 24p, 2K DCI 25p, 2K DCI 29.97p, 2K DCI 30p, 2K DCI 50p, 2K DCI 59.94p, 2K DCI 60p (SINGLE, QUAD\*)

**Full HD (1920 x 1080)**

1080p23.98, 1080p24, 1080p25, 1080p29.97, 1080p30, 1080p50, 1080i50, 1080p59.94, 1080i59.94, 1080p60 (SINGLE, QUAD\*)

**HD (1280 x 720)\***

720p23.98, 720p24, 720p25, 720p29.97, 720p30, 720p50, 720p59.94, 720p60 (SINGLE, QUAD\*)

\*all 720p and QUAD formats will be supported in a later release.

# IP-VFC

## Specifications ST 2110

## Specifications ST 2110

All video standards outlined here have been tested in ST 2110 modes across:

- Bit depth - 10-bit (all modes)
- Chroma subsampling
  - YUV 4:4:4,
  - YUV 4:2:2,
  - RGB 4:2:2 (all modes)
- Colour space
  - REC 709,
  - REC 2020 (all modes except HD Video at 1280 x 720 which supports REC 709 only)

These modes will be available at launch.

We are working towards supporting video standards at 48Hz in a future release.

### 4K DCI (4096 x 2160)

- 4K DCI 23.98p,
- 4K DCI 24p,
- 4K DCI 25p,
- 4K DCI 29.97p,



- 4K DCI 30p,
- 4K DCI 50p,
- 4K DCI 59.94p,
- 4K DCI 60p (SINGLE)

#### **UHD (3840 x 2160)**

- 2160p23.98,
- 2160p24,
- 2160p25,
- 2160p29.97,
- 2160p30,
- 2160p50,
- 2160p59.94,
- 2160p60 (SINGLE)

#### **2K DCI (2048 x 1080)**

- 2K DCI 23.98p,
- 2K DCI 24p,
- 2K DCI 25p,
- 2K DCI 29.97p,
- 2K DCI 30p,
- 2K DCI 50p,
- 2K DCI 59.94p,
- 2K DCI 60p (SINGLE, QUAD)

## Full HD (1920 x 1080)

- 1080p23.98,
- 1080p24,
- 1080p25,
- 1080p29.97,
- 1080p30,
- 1080p50,
- 1080i50,
- 1080p59.94,
- 1080i59.94,
- 1080p60 (SINGLE, QUAD)

## HD (1280 x 720)

- 720p23.98,
- 720p24,
- 720p25,
- 720p29.97,
- 720p30,
- 720p50,
- 720p59.94,
- 720p60 (SINGLE, QUAD)

# IP-VFC - System configuration

## System Configuration

We have tested the IP-VFC card using the following configuration. We recommend Fabric as a plug and play solution for IP-VFC. Any other network switch will require configuration and knowledge.

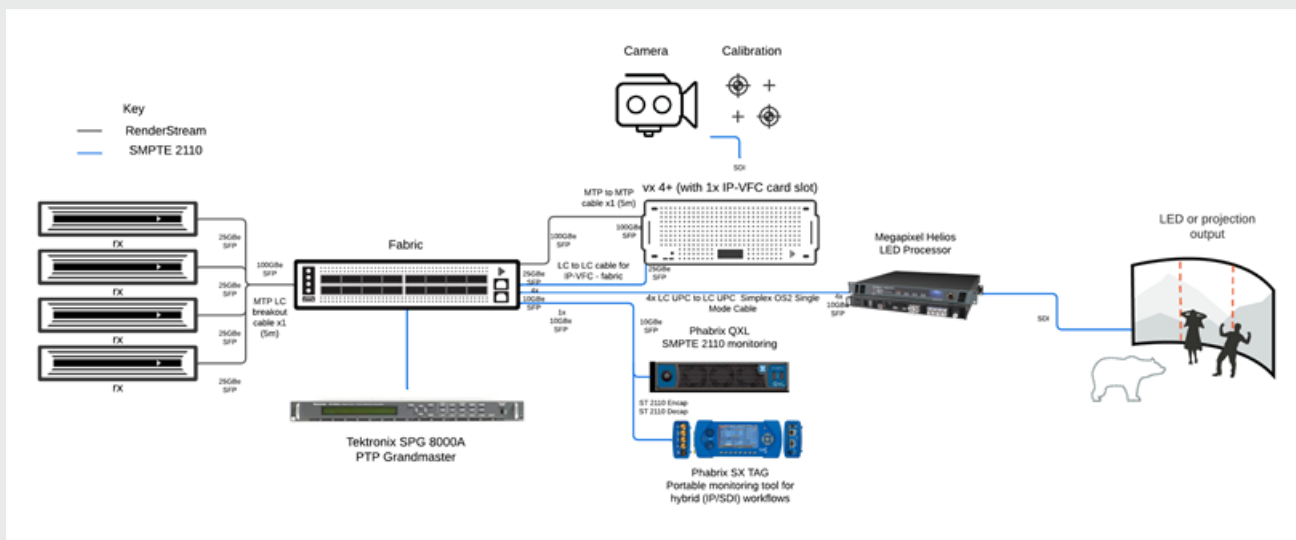

It is important to note that the 8x10Gb SFPs used to connect the IP-VFC to the Megapixel Helios are supplied by Megapixel only. The model numbers are MVR PCB-0028 SFP and MVR PCB-0008 SFP. We used 4 of each model. The Megapixel Helios must also be updated to v22.11. We also purchased 4x LC UPC to LC UPC Simplex OS2 Single Mode cables to connect between each model of SFP.

## 25Gb SFP support

## 25Gb SFP support

We have tested a couple of transmitter SFP28 options for ST 2110 outputs as listed in the table.

It is important to note that we are only supporting 25GbE SFP28s. There is currently no support for 10Gb SFP28s.

Model Number	Output Support
Mellanox MMA2P00-AS	25GbE output
FS SFP28-25GSR-85	25GbE output

# IP-VFC SDI SFP support

## SDI SFP support

We have worked on supporting a number of transmitter SFPs for SDI output as listed in the table.

We are currently not supporting any SFPs with inputs on them. These are known as transceiver SFPs.

We are also selling the Embrionix EB12BN1T-MxR and EB12HD2T-MNR-2 as optional extras.

Model Number	Output Support
Embrionix EB12BN1T-MxR/MNR	Single 12G SDI output SINGLE mode - 1x SDI output
Embrionix EB12HD2T-MNR-2	Dual 12G SDI output SINGLE mode - 1x SDI output QUAD mode - 2x SDI outputs for quad split
Embrionix EB30HD2T-LNR	Dual 3G SDI output SINGLE mode - 1x SDI output
Riedel MN-Z-SFP-2T-SDI-12G	Dual 12G SDI output for SDI mode

Please contact Sales for more information.

# IP-VFC Implementation

## Implementation

IP-VFC card looks like the below figure where the upper two ports are ST 2110 and the lower two are SDI outputs.

Users can have 4 SFPs at the same time, but will only be able to output either SDI or IP, never at the same time

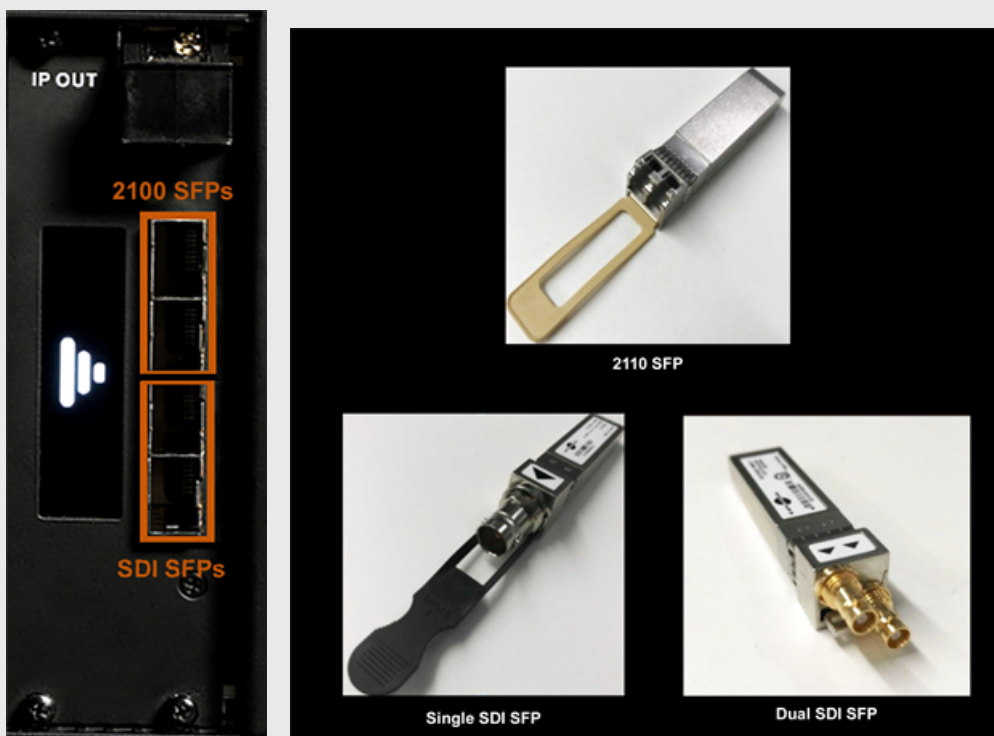

### Slots:

- There 4XSFP slots on a IP-VFC card.
- It supports 25G and 10G SFPs, Two IP at the top, two SDI at the bottom

- We can output either SDI or IP, never both at the same time
- For ST2110 to work the 1st eth SFP should always be present.
- Users have no control over the second SFP. d3 detects it and use it for redundant layout.
- Once inserted the first channel on the Dual SDI SFP is the lower BNC.

D3 Feed view:

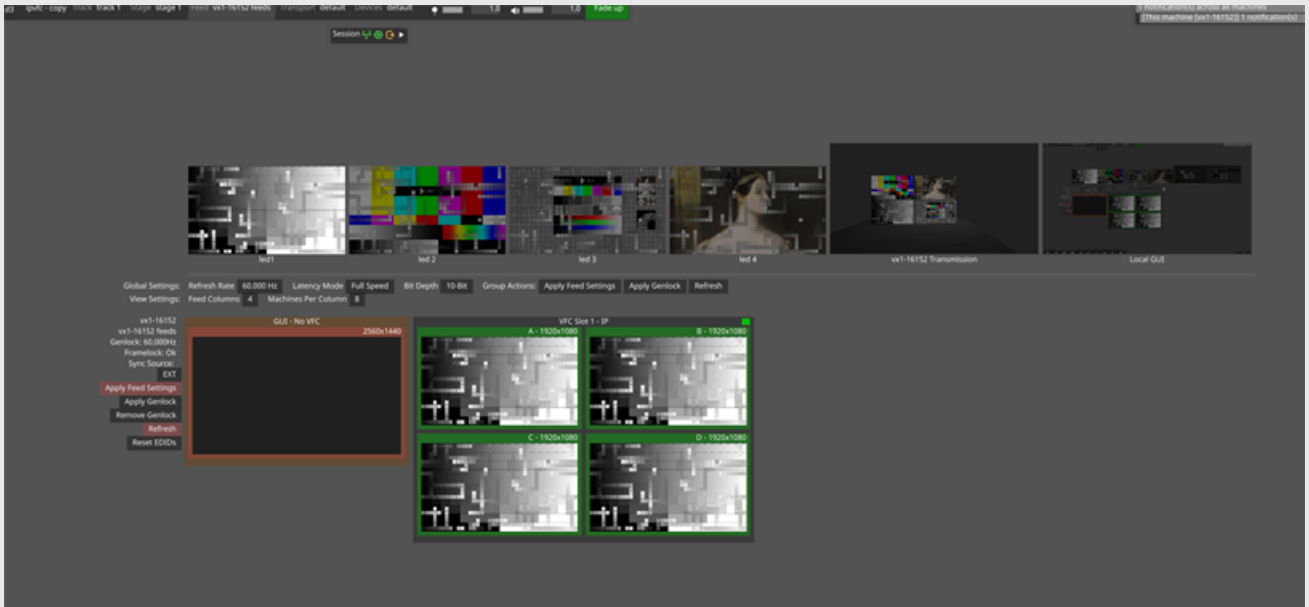

Default Quad mode view

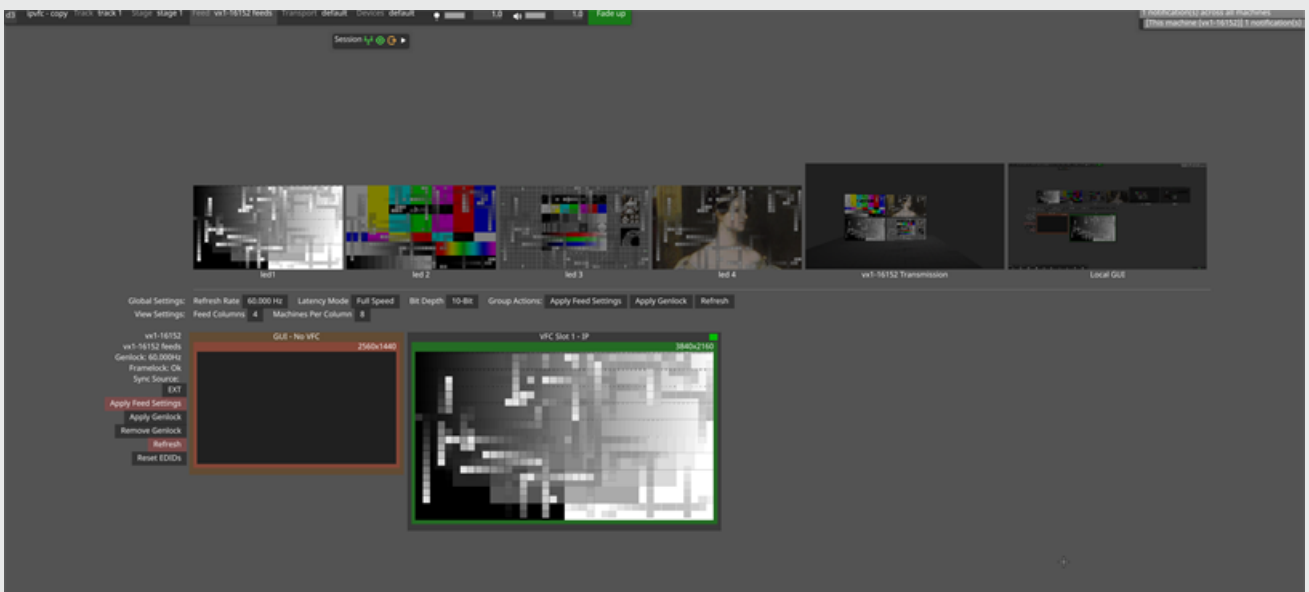

Mirror mode view

- The default view on feed window is always quad-split view.
- It supports 8 / 10 / 12 bit colour depth
- 12 bit only applicable when d3 supports it, not for testing at the moment.
- **Apply feed settings** is the same as always.
- If user have single IP-VFC card, feed settings will get apply only clicking on the **Apply feed settings** from the left grid.

### Feed settings widget overview:

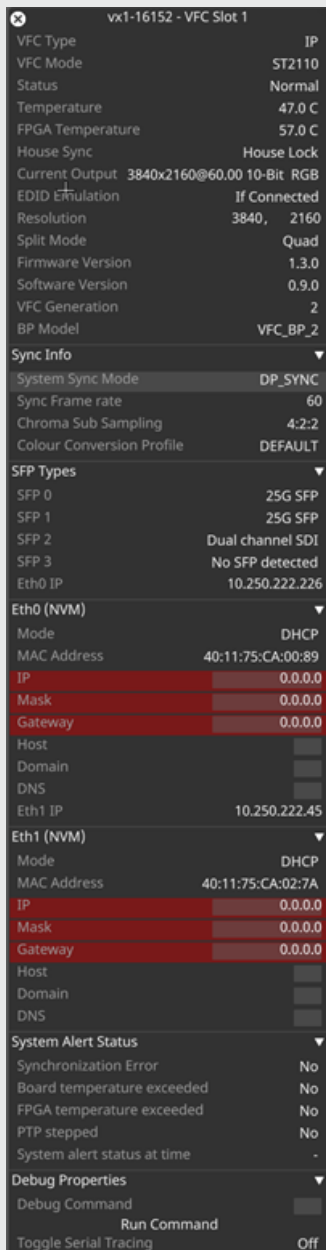

VFC card slot widget



## Settings:

VFC Type	IP
VFC Mode	ST2110
Status	Normal
Temperature	47.0 C
FPGA Temperature	58.0 C
House Sync	House Lock
Current Output	3840x2160@60.00 10-Bit RGB
EDID Emulation	If Connected
Resolution	3840, 2160
Split Mode	Quad
Firmware Version	1.3.0
Software Version	0.9.0
VFC Generation	2
BP Model	VFC_BP_2

### — VFC Mode:

- » Native - Not a mode to use - if you see this something is probably wrong
- » ST2110 - Using the adapter in “networking” mode
- » SDI - Using the adapter in “video” mode

— **Status:** The actual status of the card. This is where problems with configuration are highlighted

— **Temperature:** The overall temperature of the card. If temps go towards 80c then card at risk of suddenly turning off, if this happens please note exact test setup and report to HW team.

— **FPGA Temperature:** FPGA stands for field-programmable gate array. Essentially, an FPGA is a hardware circuit that a user can program to carry out one or more logical operations. This is the temperature of that Chip

— **House Sync:** The status of the Genlock

— **Current Output:** The current resolution the raster of the card is set off

— **EDID Emulation:** The status of the EDID Emulation for the card

— **Resolution:** Here we can set the desired resolution for the card

— **Split Mode:** The way the card is set-up, can be Mirror (one single raster) or Quad (Quad Split like the DVI/SDI cards)

— **Firmware Version:** The firmware version of the card

— **Software Version:** The software version of the card

— **VFC Generation:** The generation of the card

— **Backplane Model:** The backplane model of the card.

## Sync info:

### 1. DP\_Sync Details:

Sync Info ▾	
System Sync Mode	DP_SYNC
Sync Frame rate	60
Chroma Sub Sampling	4:2:2
Colour Conversion Profile	DEFAULT

— *System Sync Mode:*

- » **PTP\_LOCKED** - The card is genlocked with the Grand Master Sync signal (Precision Time Protocol) and needs a PTP generator.
- » **EXT\_SYNC** - Is a special mode where the External Sync phase info is passed to the IP VFC via BP2. IP-VFC can detect how far out (or aligned) are the external sync and the output vsync of the DP signal.
  - » Essentially only useful for interlaced playout so that IP-VFC can know whether to output odd field frame or even field frame
- » **DP\_SYNC** - The card is locked to an external sync source like the usual BB or Tri-Level

— **Sync Frame Rate:** The frame rate the card is synced off

— **Chroma Sub Sampling:** Colour information settings for the card

- » RGB
- » 4:4:4
- » 4:2:2

— **Colour Conversion Profile:** The colour space the card will output with

- » BT.601
- » BT.709

» BT.2020

» Default

## 2. PTP Sync Details:

### \*SLOT WIDGET DETAILS

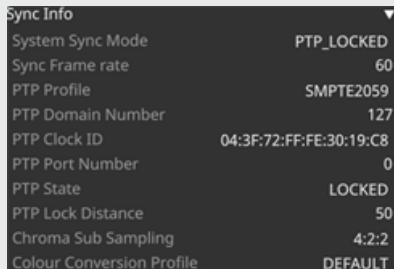

Sync Info	
System Sync Mode	PTP_LOCKED
Sync Frame rate	60
PTP Profile	SMPTE2059
PTP Domain Number	127
PTP Clock ID	04:3F:72:FF:FE:30:19:C8
PTP Port Number	0
PTP State	LOCKED
PTP Lock Distance	50
Chroma Sub Sampling	4:2:2
Colour Conversion Profile	DEFAULT

**PTP Profile:** The profile of the PTP in use to genlock the card (this is given by the source) by default SMPTE2059, other profiles would be special requests.

**PTP Domain Number:** The Domain number in use by that PTP instance. It's a unique number, so if using multiple PTP there will be multiple instance each with their unique Domain. IPVFC settings needs to match the setting on the PTP grandmaster.

**PTP Clock ID:** The clock identity of the device. It is a 64-bit global identifier (EUI-64) as defined by the IEEE 1588 standard.

**PTP Port Number:** The number of the port in use by the PTP (319 or 320 depending by the messages).

**PTP State:** The status of the PTP, - "STOPPED" The PTP daemon has not yet started or was stopped for some other reason. - "FREERUN" Not locked to a PTP master and no master selected. - "UNLOCKED" Not locked to a PTP master but a master was selected. - "LOCKING" A PTP master was selected and trying to lock. - "LOCKED\_ns" Locked to a PTP master and perceived locking distance is within nanoseconds, where can be 500, 200, 100 or 50.

**PTP Lock Distance:** How 'far' away the grandmaster is to the IPVFC. If this value is very big IPVFC will struggle to lock to PTP, could be a problem with the network switch or if the network is large (lots of switches)

\*Feed view left-PTP Sync info

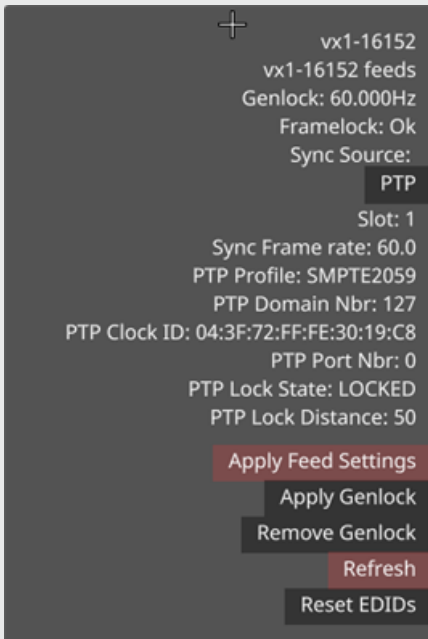

- It's accessible also from the left-hand side of the the GUI Head in the feed view.
- If on the side view the user has selected PTP as sync source, then during Apply Feed Settings, d3 will find the first IP VFC which is PTP\_LOCKED and use this IP VFC as source of genlock for the GPU.
- If the user has selected EXT, and if there is any number of IP VFCs which have EXT\_SYNC selected then , any external sync signal will be routed to those IP-VFCs.

**NOTE:**

Multiple IP VFC cards can be locked to different PTP - through their unique domain. This is sort of true but has limited application, most setups will have one PTP grandmaster and perhaps a backup which will take over if the main fails

**SFP Types:**

SFP Types ▼	
SFP 0	25G SFP
SFP 1	25G SFP
SFP 2	Dual channel SDI
SFP 3	No SFP detected
Eth0 IP	10.250.222.226

- SFP Types is the type of the adapter (SFP) that is inserted in the 4 available slots on the card. This will modify the way the signal is outputted.
  1. **SFP 0:** The first slot available from the top - Only for 2110 adapters
  2. **SFP 1:** Same as above, the second - Only for 2110 adapters
  3. **SFP 2:** the third slot - Only for SDI adapters
  4. **SFP 3:** the fourth slot - Only for SDI adapters
- The SFP can be 25G SFP - the network output, a fibre channel adapter or a dual channel SDI - the video adapter with a (HD-BNC) SDI connector on the adapter
- The slots are hot-swappable (not the VFC card itself).

**Eth0 (NVM):**

Eth0 (NVM) ▼	
Mode	DHCP
MAC Address	40:11:75:CA:00:89
IP	0.0.0.0
Mask	0.0.0.0
Gateway	0.0.0.0
Host	<input type="text"/>
Domain	<input type="text"/>
DNS	<input type="text"/>
Eth1 IP	10.250.222.45
Eth1 (NVM) ▼	
Mode	DHCP
MAC Address	40:11:75:CA:02:7A
IP	0.0.0.0
Mask	0.0.0.0
Gateway	0.0.0.0
Host	<input type="text"/>
Domain	<input type="text"/>
DNS	<input type="text"/>

- NVM stands for Non-Volatile Memory (the opposite of the RAM)
- The card keeps the IP address that was previously set - and you need to specify all the IP for every adapter once you start the system.

**Debug Properties**

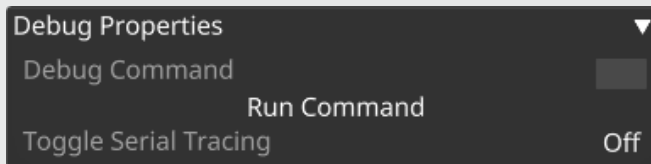

- **Debug command:** These options are for interacting directly with the IPVFC API. DEBUG command is the command from the Host IPVFC interfacing document.
- **Toggle Serial Tracing:** Toggle Serial tracing means that each API call to the IPVFC is logged in d3service.

## Head overview

<p><b>vx1-16152 - VFC Slot 1 Port A</b></p> <p>Head Name <input type="text"/></p> <p>Port State <input type="text"/></p> <p>Port status <b>Eth1 multicast details are different</b></p> <p>Stream Enabled <input checked="" type="checkbox"/> Yes</p> <p>Display Mode <input type="text"/> Custom</p> <p>Custom Resolution <input type="text"/> 1920, <input type="text"/> 1080</p> <p>Frame Replay <input type="checkbox"/> Off</p> <p>TPG <input type="checkbox"/> Off</p> <p><b>Feed Properties</b> ▼</p> <p>Background Colour <input type="text"/></p> <p>Lineup Background <input type="text"/> None</p> <p>Latency <input type="text"/> 0</p> <p><b>Eth0 Multicast Info</b> ▼</p> <p>IP <input type="text"/> 239.0.30.1</p> <p>Port <input type="text"/> 50020</p> <p>RTP Payload Type ID <input type="text"/> 96</p> <p><b>Eth1 Multicast Info</b> ▼</p> <p>IP <input type="text"/> 239.0.30.2</p> <p>Port <input type="text"/> 50020</p> <p>RTP Payload Type ID <input type="text"/> 96</p> <p><b>Debug Properties</b> ▼</p>	<p><b>vx1-16152 - VFC Slot 1 Port B</b></p> <p>Head Name <input type="text"/></p> <p>Port State <input type="text"/></p> <p>Port status <b>Eth1 multicast details are different</b></p> <p>Stream Enabled <input checked="" type="checkbox"/> Yes</p> <p>Display Mode <input type="text"/> Custom</p> <p>Custom Resolution <input type="text"/> 1920, <input type="text"/> 1080</p> <p>Frame Replay <input type="checkbox"/> Off</p> <p>TPG <input type="checkbox"/> Off</p> <p><b>Feed Properties</b> ▼</p> <p>Background Colour <input type="text"/></p> <p>Lineup Background <input type="text"/> None</p> <p>Latency <input type="text"/> 0</p> <p><b>Eth0 Multicast Info</b> ▼</p> <p>IP <input type="text"/> 239.1.30.1</p> <p>Port <input type="text"/> 50020</p> <p>RTP Payload Type ID <input type="text"/> 96</p> <p><b>Eth1 Multicast Info</b> ▼</p> <p>IP <input type="text"/> 239.1.30.2</p> <p>Port <input type="text"/> 50020</p> <p>RTP Payload Type ID <input type="text"/> 96</p> <p><b>Debug Properties</b> ▼</p>
<p><b>vx1-16152 - VFC Slot 1 Port C</b></p> <p>Head Name <input type="text"/></p> <p>Port State <input type="text"/></p> <p>Port status <b>Eth0 multicast details are different</b></p> <p>Stream Enabled <input checked="" type="checkbox"/> Yes</p> <p>Display Mode <input type="text"/> Custom</p> <p>Custom Resolution <input type="text"/> 1920, <input type="text"/> 1080</p> <p>Frame Replay <input type="checkbox"/> Off</p> <p>TPG <input type="checkbox"/> Off</p> <p><b>Feed Properties</b> ▼</p> <p>Background Colour <input type="text"/></p> <p>Lineup Background <input type="text"/> None</p> <p>Latency <input type="text"/> 0</p> <p><b>Eth0 Multicast Info</b> ▼</p> <p>IP <input type="text"/> 239.2.30.1</p> <p>Port <input type="text"/> 50020</p> <p>RTP Payload Type ID <input type="text"/> 96</p> <p><b>Eth1 Multicast Info</b> ▼</p> <p>IP <input type="text"/> 239.2.30.2</p> <p>Port <input type="text"/> 50020</p> <p>RTP Payload Type ID <input type="text"/> 96</p> <p><b>Debug Properties</b> ▼</p>	<p><b>vx1-16152 - VFC Slot 1 Port D</b></p> <p>Head Name <input type="text"/></p> <p>Port State <input type="text"/></p> <p>Port status <b>Eth0 multicast details are different</b></p> <p>Stream Enabled <input checked="" type="checkbox"/> Yes</p> <p>Display Mode <input type="text"/> Custom</p> <p>Custom Resolution <input type="text"/> 1920, <input type="text"/> 1080</p> <p>Frame Replay <input type="checkbox"/> Off</p> <p>TPG <input type="checkbox"/> Off</p> <p><b>Feed Properties</b> ▼</p> <p>Background Colour <input type="text"/></p> <p>Lineup Background <input type="text"/> None</p> <p>Latency <input type="text"/> 0</p> <p><b>Eth0 Multicast Info</b> ▼</p> <p>IP <input type="text"/> 239.3.30.1</p> <p>Port <input type="text"/> 50020</p> <p>RTP Payload Type ID <input type="text"/> 96</p> <p><b>Eth1 Multicast Info</b> ▼</p> <p>IP <input type="text"/> 239.3.30.2</p> <p>Port <input type="text"/> 50020</p> <p>RTP Payload Type ID <input type="text"/> 96</p> <p><b>Debug Properties</b> ▼</p>

Multi head overview

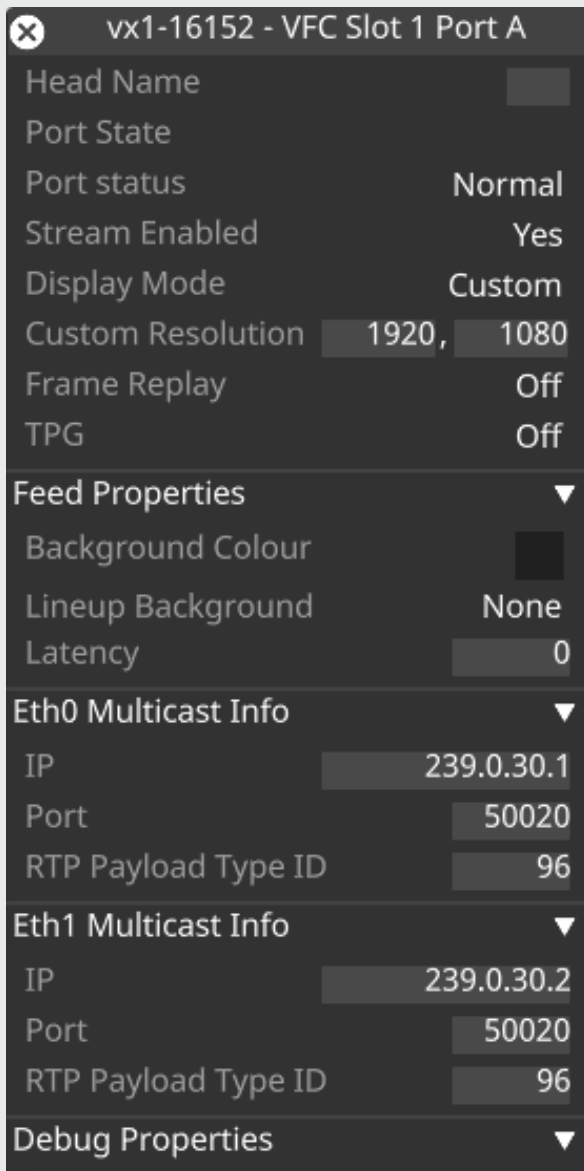

### Single head overview

- **Head Name:** The name of the head (Can be assigned freely)
- **Port State:** The state of the port
- **Port status:** The status of the port (indicate if something doesn't match with the rest of the project)
- **Stream Enabled:** When NO indicate that there is something wrong with the output
- **Display Mode:** Right click to see settings such as interlaced output
- **Custom Resolution:** The resolution of the head
- **Frame Replay:** If set to ON, it keeps the last frame received and present that to the output



- **TPG: Test Pattern Generator:** Generates a Test Pattern internally in the FPGA
- **Feed Properties:** Same as other VFCs
- **Eth0 Multicast Info:** Multicast address, must be set differently for each feed in range 224.0.0.0 to 239.255.255.255. Always needs to be set for each stream/head
  - » Network info of where the content will be send to from eth0 adapter
  - » IP: The multicast address where to send the stream (239.x.x.x)
  - » Port: The port where to send the stream (Default: 50020)
  - » RTP Payload Type ID: The Real Time Protocol ID of the type of content is gonna be sent (96 default is Dynamic Assigned by the sender or the application that use it)
- **Eth1 Multicast Info:** Network info of where the content will be send to from eth0 adapter
  - » IP: The multicast address where to send the stream (239.x.x.x)
  - » Port: The port where to send the stream (Default: 50020)
  - » RTP Payload Type ID: The Real Time Protocol ID of the type of content is gonna be sent (96 default is Dynamic Assigned by the sender or the application that use it)

# IP-VFC Workflow

## IP-VFC Workflow

The IP-VFC workflow demonstrated on a vx 4 and Helios LED processor.



1. Open the Designer project.
2. Configure the IPVFC settings.
3. Click **Apply the Feed Settings**.
4. Enter the network IP address.
5. Copy the addresses of the four outputs.

6. Save the addresses in a .txt file.
7. Configure the four outputs on the Helios LED processor.
8. Paste the output addresses into the URL in the .txt file.
9. Add the four output URL addresses to the slots.
10. Select a test clip for each output.
11. Confirm that the clips appear correctly on the LED volume.

# IP-VFC Update

## Check IP-VFC Firmware

1. Download the IP-VFC firmware updater download tool and latest firm ware from [here](#).
2. Right-click the *IPVFCUpdaterGUI* powershell script and click **Run with powershell**.
3. Click the Kill **d3Service, d3Buddy** button.

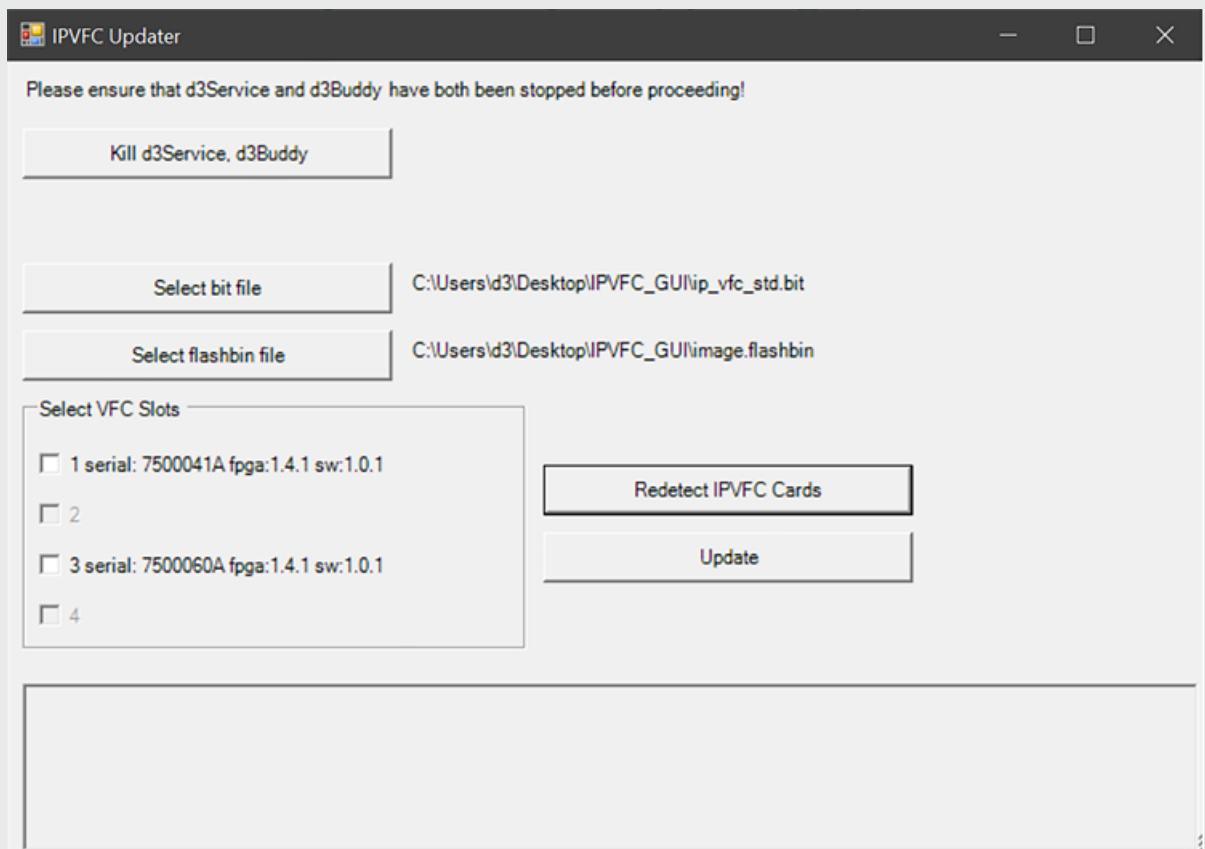

4. Click **Redetect IPVFC Cards**.
5. Detected IP-VFC cards then appear in the VFC Slots list detailing the serial number as well as the versions of software that the card is running.
6. If no cards appear in the list but there are cards plugged into the system, wait for at least two minutes and click **Redetect IPVFC Cards** to populate the list.

## Update IP-VFC Firmware

1. Perform all of the steps in the **Check IP-VFC Firmware** in the above section.
2. Click the **Select bit file** button and select the **.bit** file from the version you want to install.
3. Click the **Select flashbin file** button and select the **.flashbin** file from the version you want to install.
4. Check all the boxes next to the cards that you would like to update.
5. Click the **Update** button.
6. Separate powershell windows will then appear with the progress of each cards update.
7. After approximately 7 minutes the cards will have finished updating and will automatically reboot.
8. Click **Redetect IPVFC Cards** and check that all the cards that were updated now display in the list with the correct version (Note: the reboot process takes approximately 2 minutes).
9. If there were any problems with an update, the logs from each card are stored in the same folder as the updater.

# IP-VFC FAQs

## **How reliable are the SFPs that have been tested with IP-VFC?**

As part of our QA processes, the SFPs outlined in the list of supported SFPs have been used alongside the IP-VFC in the same testing environments, often over several days at a time with no issue. Long range SFPs draw more power and so are likely to run hotter during operation.

## **How can I update the firmware of the IP-VFC?**

We have put together documentation on how to update the firmware of the IP-VFC. This is available [here](#).

What's the behaviour of Port 2 on the IP-VFC when running redundancy in ST 2110 mode, and will it impact the GPU load on the server by running a redundant video stream?

There is no difference in GPU load. The redundant video stream is completed internally to the IP-VFC

When using ST 2110 mode in multicast, can you use the boundary clock on the on the fabric for timing instead of a PTP grandmaster?

Fabric by default will act as a boundary clock so that will most often be the case.

Can you use a fabric in the same configuration for RenderStream on one port/VLAN and ST 2110 on another?

We will look to test this.

Why can't the IP-VFC support 2160p60 at RGB 4:4:4 10-bit in SDI mode?

The IP-VFC is limited in SDI mode by 12G SDI, which means that it has a bandwidth of 12 Gbit/s. We offer YUV 4:2:2 support up to 4K DCI 60p in 10-bit which reaches around 11.2 Gbit/s. We are therefore restricted by bandwidth constraints and would have to consider lower framerates (i.e. 24p) on a case-by-case basis.

# VFC Cards

The powerful proprietary disguise VFC card allows a server to be easily configured for DVI, SDI, HDMI, and/or DP outputs.

## Slot Info

Information on a VFC slot can be accessed from within the Feed window. For more information on configuring VFC slots from the Feed Window, visit [this link](#)

## Specs

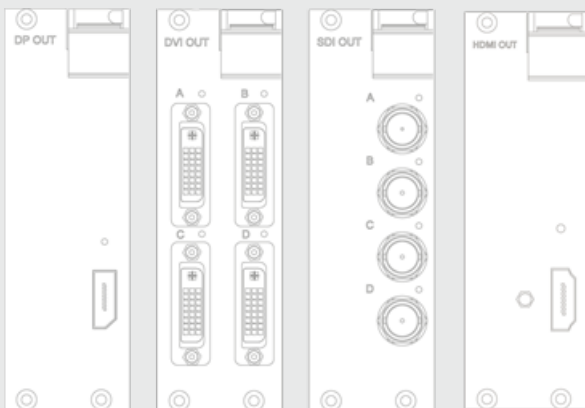

Display Port 1.2	Quad DVI	Quad SDI	HDMI
1 Output per card	4 Outputs per card	4 Outputs per card	1 Output per card
Max res: 4096x2160	Single Link DVI: (up to) 1920 x 1200	Max res: 1920 x 1080	Max res: 4096x2160 @60 YCbCr444 8bit 3840x2160 @60 YCbCr422 10bit* 3840x2160 @30 YCbCr444 10bit
LED indicator	LED indicator	LED indicator	LED indicator
Genlocked	All outputs genlocked	All outputs genlocked	Genlocked



## LED Codes

The colour of the LED on the VFC card indicates the status of the card as follows:

**White:** The VFC card is receiving power but no connection has been made to it. FPGA is booting. LED should power off after going white. If it is stuck on white, the VFC is has not booted correctly and is not in a good state. Requires attention.

**Blue:** The VFC card is receiving power and disguise is establishing a connection. Flashing blue indicates a persistent error and the VFC is constantly trying to re-configure itself. Requires attention.

**Green:** The VFC card is operating normally.

**Orange:** If this does not resolve, this indicates an error, possibly with the FPGA. Requires attention.

**Pink:** In early days of the DP VFC card, a Pink LED indicated an programming issue with the card. This status code has been corrected in a later software release and should no longer need attention.

# Update VFC Card Firmware

Update Quad-SDI / Quad DVI VFC firmware.

## Update Quad-SDI / Quad-DVI VFC firmware

### How to determine the current firmware version

1. Populate a VFC compatible disguise machine with the Quad-SDI or Quad-DVI VFC cards you want to check.
2. Run **vfcfirmwareupdater.exe** located at **C:\Program Files\d3 Production Suite\build\msvc**.
3. Check **Firmware Version**.

### How to determine the current firmware version

1. Populate any VFC compatible disguise machine with either the Quad-SDI or Quad-DVI VFC cards required to be updated.
2. Download the VFC firmware update Quad-SDI and/or Quad-DVI VFC cards from the 'Resources' tab located on [disguise.download](#).
3. Run **vfcfirmwareupdater.exe** located at **C:\Program Files\d3 Production Suite\build\msvc** or from the 'Resources' tab located on [disguise.download](#).

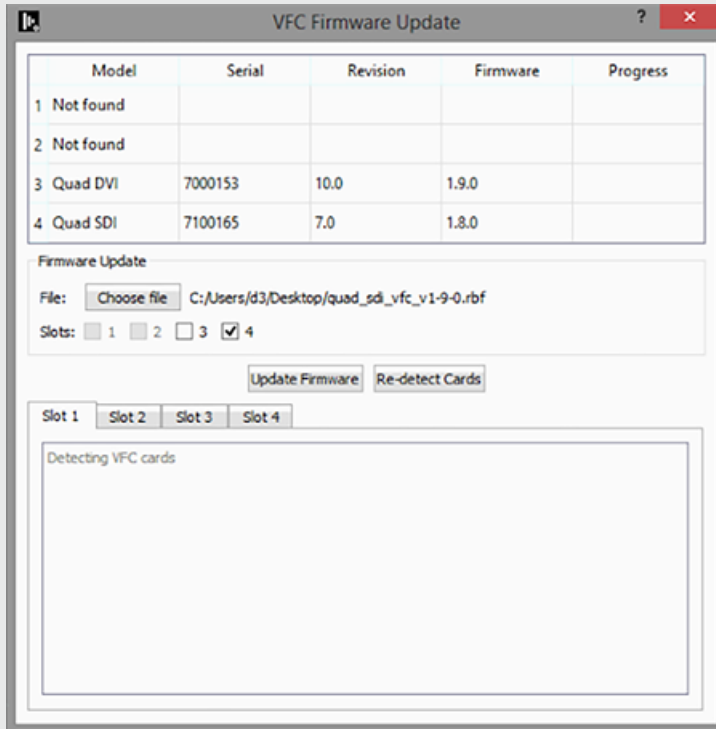

4. Click Choose file and load the downloaded VFC firmware update. If updating the Quad-SDI VFC card for example, the filename should be quad\_sdi\_vfc\_v1-9-0.rbf .
5. Slots will be automatically selected.  
Ensure only Quad-SDI or Quad-DVI type cards have the correct firmware update applied to them.

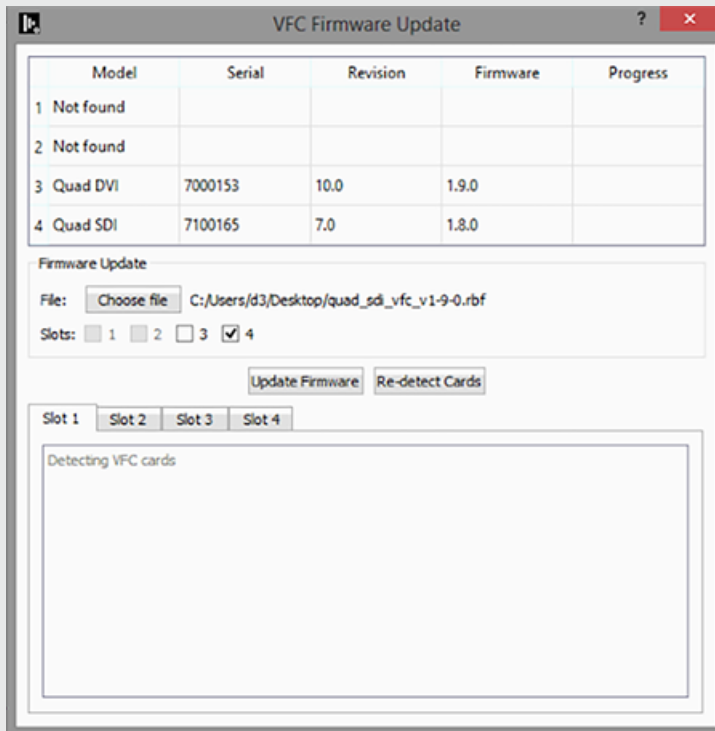

- Click Update Firmware, the update will start and will take between 10-25 minutes.

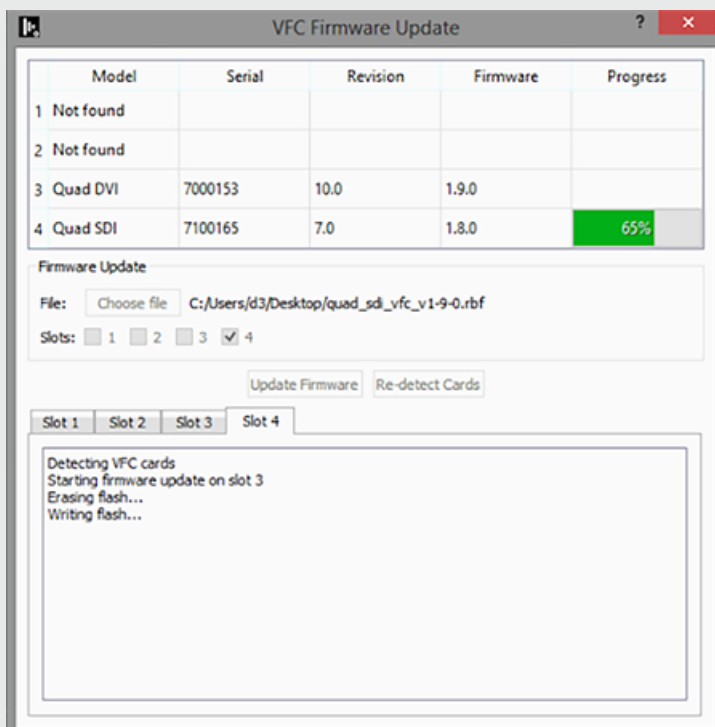

- On completion, the Firmware version field will not update until all cards have finished updating and have been re-initialised and detected.

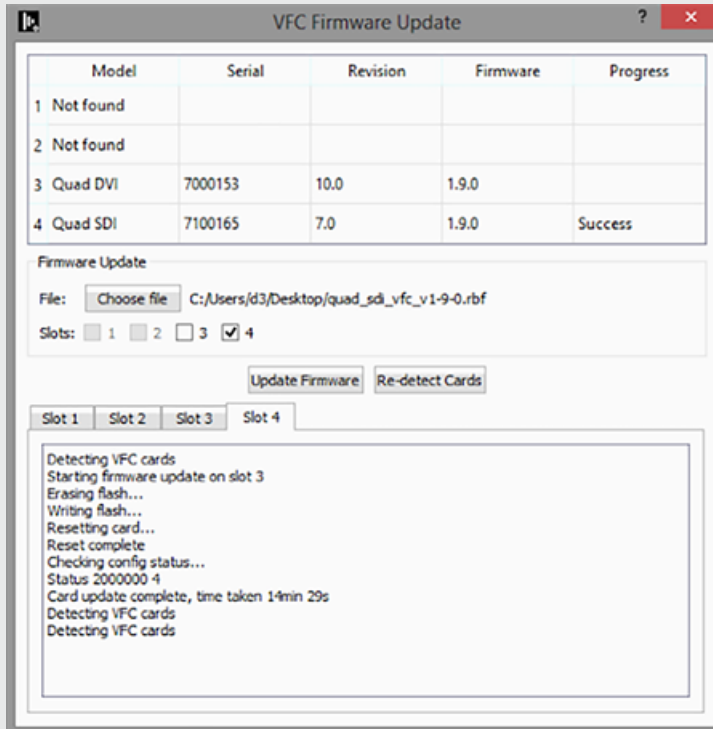

8. Finally, reboot the system.

# VFC card Replacement

**Please note:** Take steps to ensure you are free of static electricity before starting the procedure and ground yourself appropriately. We recommend the use of an anti-static wrist strap as well as an anti-static mat if one is available. It is easiest to change the cards starting on the right hand side, and it is advised to do so regardless of the amount of cards you need to change.

Users can change VFC cards as they require. You can replace one or multiple cards. The following steps are a guide to help users change VFC cards. Please read carefully to ensure best practice. If the system does not work after following these instructions, do not force the VFC cards but contact the [support@disguise.one](mailto:support@disguise.one)

## Replacing a VFC card

1. Disconnect the system from all sources of power: remove the power cord from input and output, before changing the VFC cards.
2. Step 2: Using a Phillips #1 screwdriver loosen the 4x retaining screws on the VFC card you want to replace. The screws are indicated with a red line in the image below.

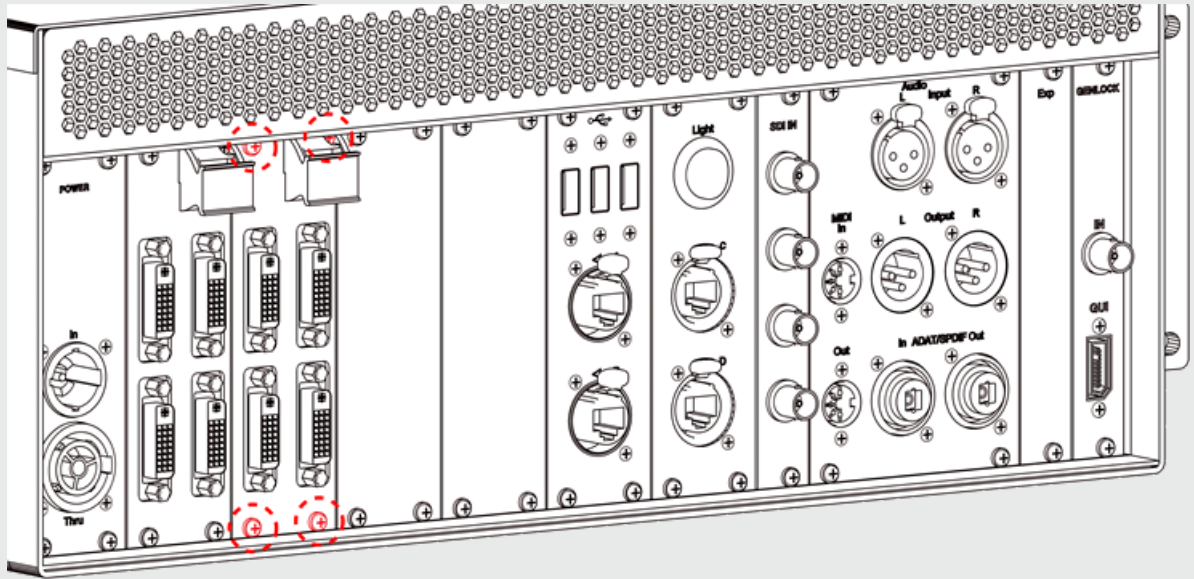

Red lines indicate screw location. Example shows Quad DVI VFC cards.

3. Lift the latch on the top right corner of the card and gently remove the card from the rear of the unit by pulling gently as shown in the images below.
4. The VFC cards are fragile, be sure to pull straight not flexing the card and if under any resistance do not use excessive force. Avoid touching the exposed electronics.

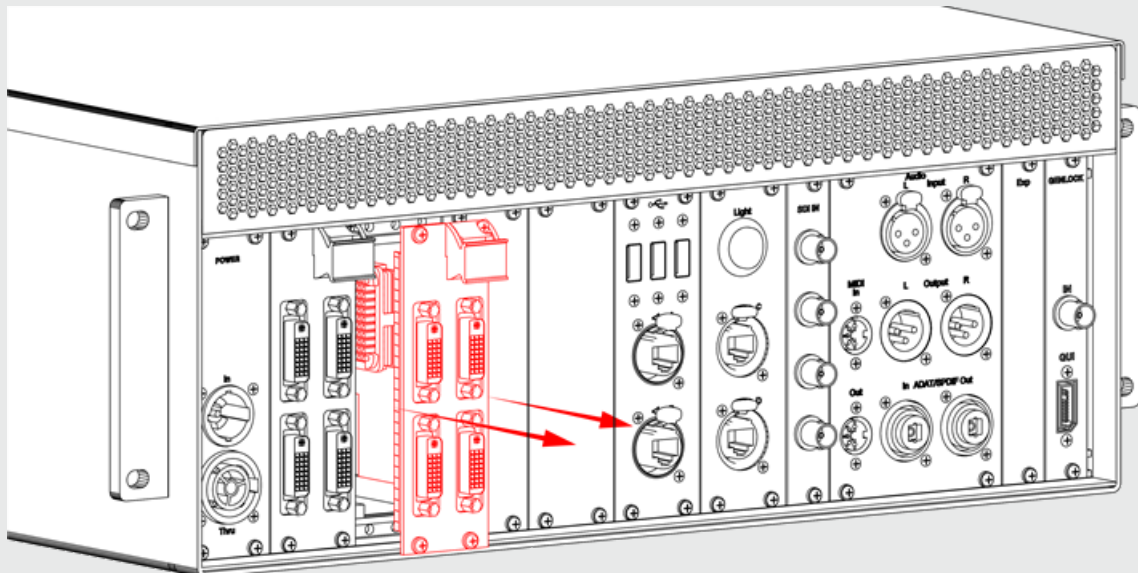
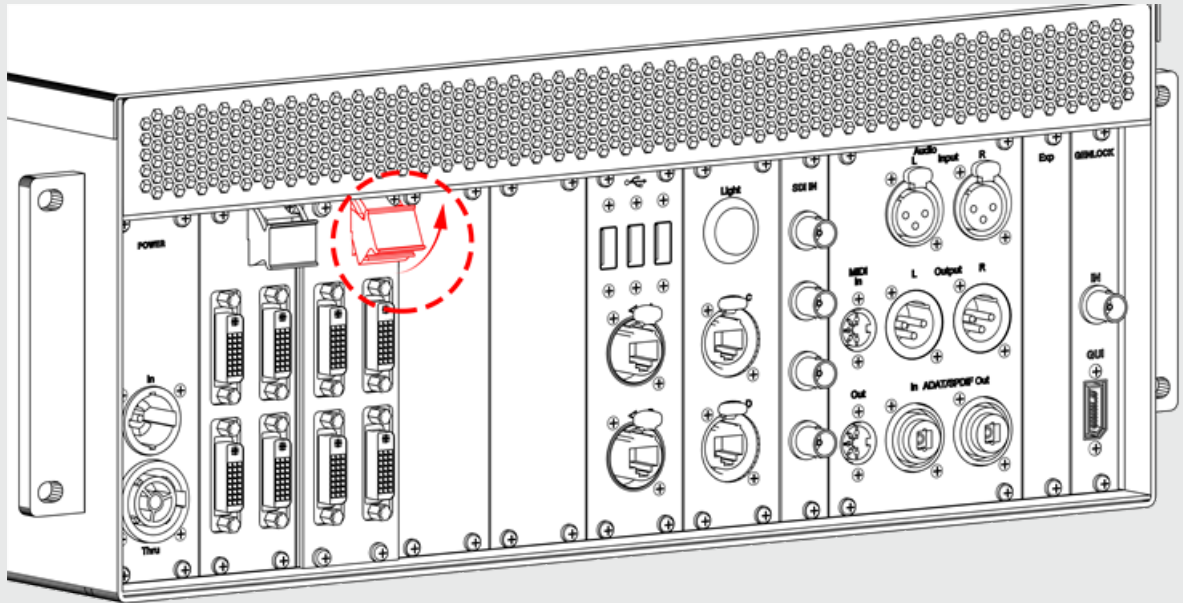

5. Gently place the removed card into the anti static box provided with your purchase.



- Gently insert the new VFC card into the vacant slot, being careful to line the card up with the guides both at the top and the bottom of the system, as indicated for the bottom with red lines in the image below.

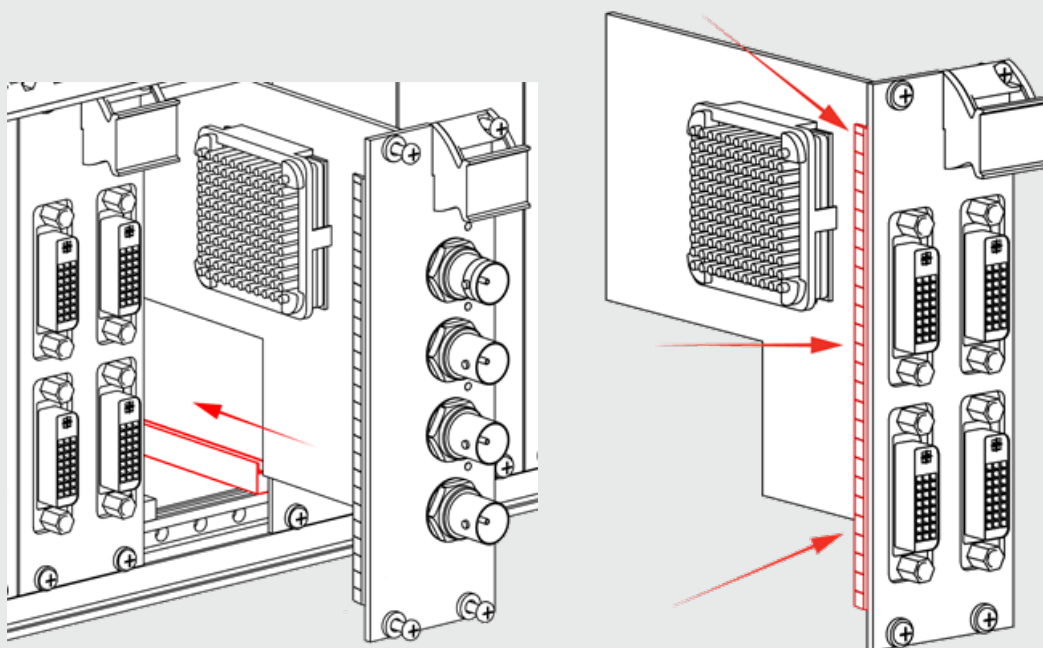

**Please note:** Note that when replacing a VFC card in a gx 1, ensure that the latch is on the right when inserting a card as shown in the image below. The plastic guides are located near the base of the server and help align the card with the connector

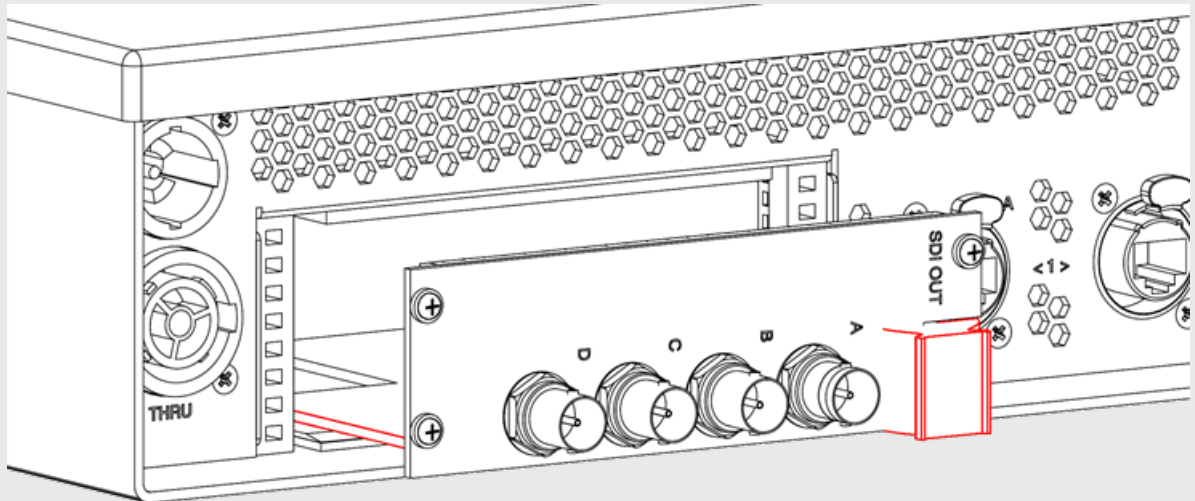

7. The top and bottom of the card needs to slide into the guides. Be sure that the grounding spring maintains its position to avoid jamming when re-inserting.
8. Once inserted into the guides, make sure the card is fully flush with the rear of the server by gently and firmly pressing in the centre of the VFC card, as indicated in the image below.

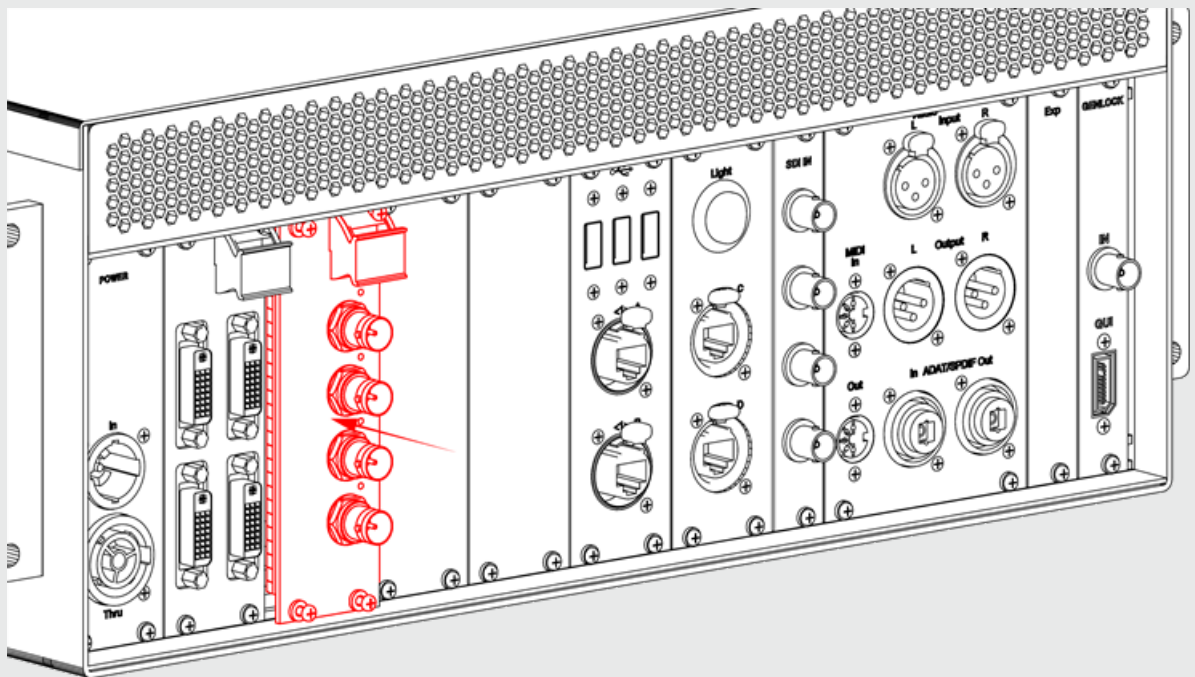

9. Fasten the four retaining screws before repeating all of the steps for the next card. To reduce the risk of damaging the threads, do not apply excessive torque to the screws.

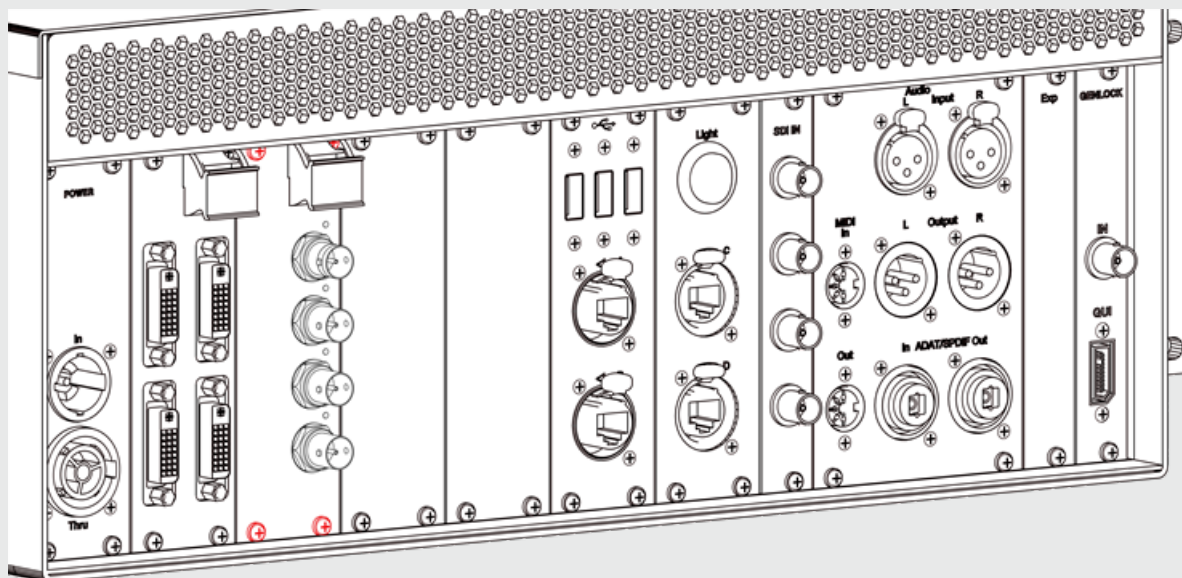

# EDID overview

Extended Display Identification Data, or "EDID", is the metadata between display and GPU.

## What is an EDID?

An EDID communicates metadata about manufacturer specifications and data for a display to a video source such as a graphics card. EDID allows for the display to relay its capabilities, such as its native resolution, to the attached source, and then allow the source to generate the necessary video characteristics to match the needs of the display.

For more information on the standard for the EDID format, please visit [Video Electronics Standards Association \(VESA\)](#).

## EDID Emulation within Disguise software

EDID emulation within Disguise software is configured via the VFC card properties editor in the Feed Output window:

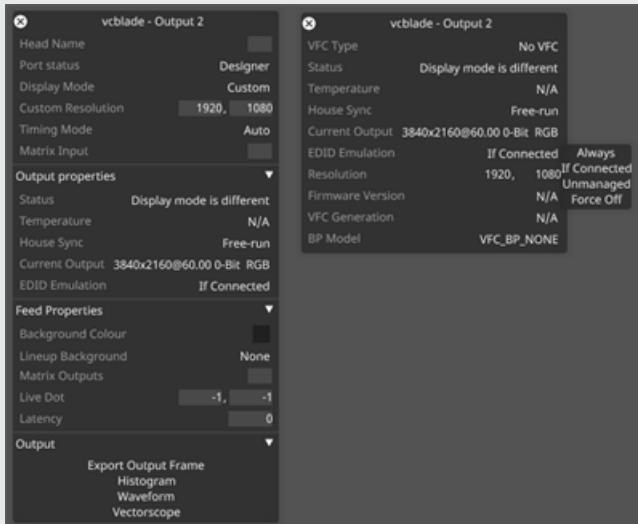

EDID Emulation modes:

- **Always** - forces EDID emulation even without connected device
- **If Connected** - Emulate EDID only when a display is connected to the output
- **Unmanaged** - DO not modify current EDID emulation
- **Force Off** -Do not emulate EDID, remove existing if set

For information on configuring EDIDs at the Windows level, please visit the [Managing EDIDs](#) page

## Resetting EDIDs

EDIDs on all outputs of all connected VFC cards. EDIDs can be reset to a neutral state easily using the keyboard shortcut FFS (Four Finger Salute) as follows:

- Hold CTRL + ALT + SHIFT + F12
- Disguise will display several status messages on the screen during the reset process; please

wait until reset process has completed before continuing

**Please note:** You can only genlock outputs that have identical EDID

# Managing EDIDs

## Emulating EDIDs within Windows

1. Navigate to the "View system topology" tab

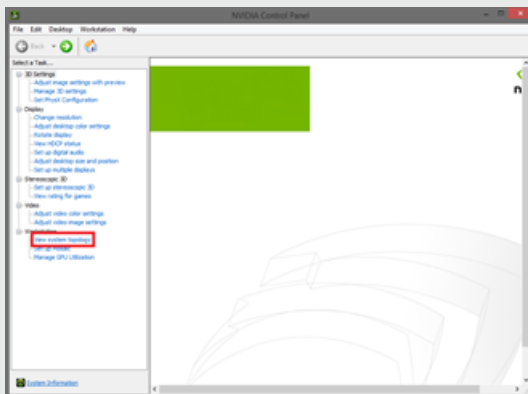

- Click the EDID button next to a card connection (DVI or DisplayPort)

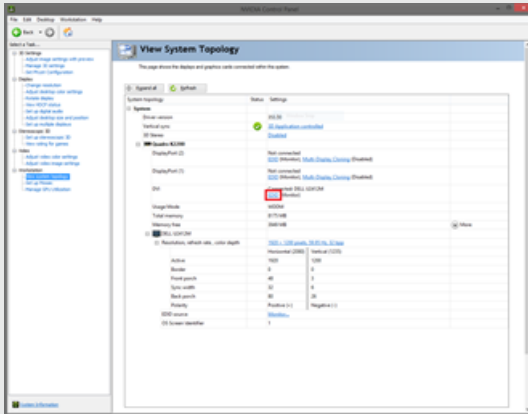

- Navigate to the "Load" tab inside the Manage EDID window
- Browse to your preferred EDID and select which display connections you want to emulate the EDID on.

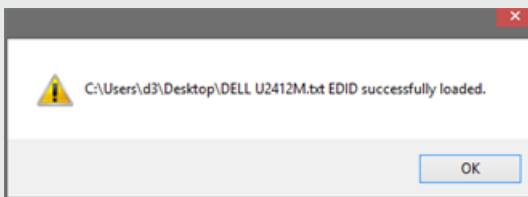
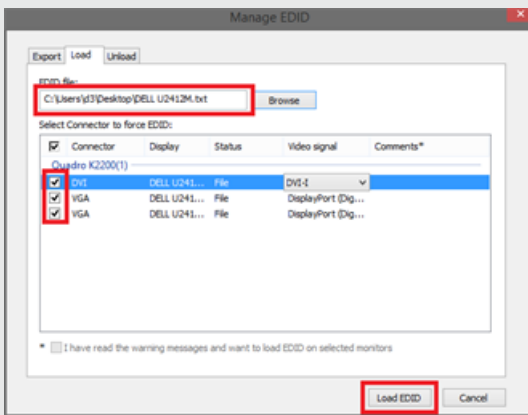



5. After the EDID is successfully applied you will see this  small icon which indicates that the display connection has an emulated EDID associated with it.

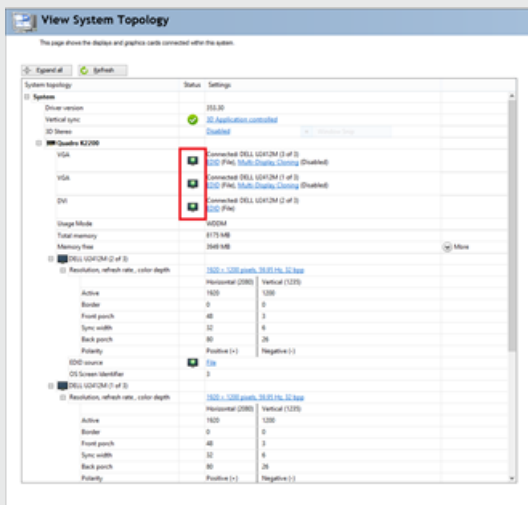

## Exporting EDIDs

1. Navigate to the "View system topology" tab

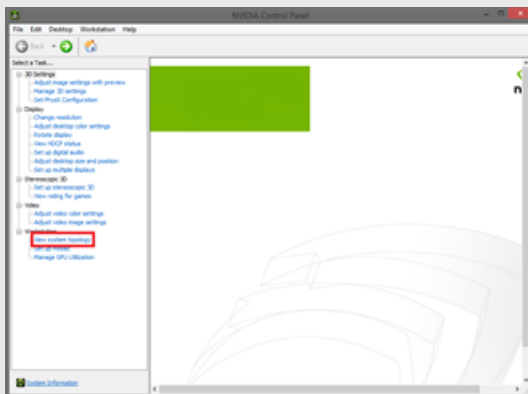

2. Click the EDID button next to a card connection (DVI or DisplayPort)

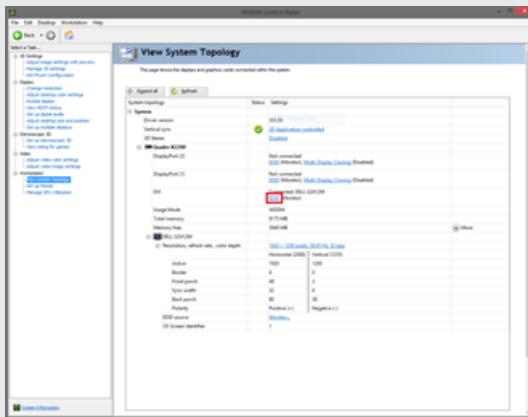

3. Export your preferred EDID to the desktop or documents folder

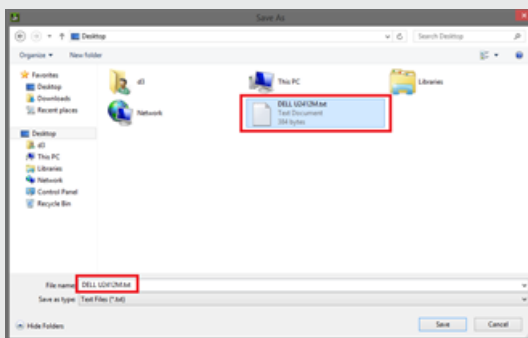
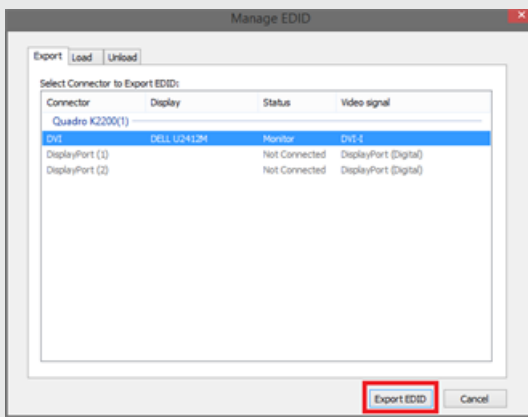

# Resetting EDIDs

EDIDs on all outputs of all connected VFC cards can be reset to a neutral state easily using the keyboard shortcut FFS (Four Finger Salute) as follows:

- Hold CTRL + ALT + SHIFT + F12
- disguise will display several status messages on the screen during the reset process; please wait until reset process has completed before continuing

**Please note:** You can only genlock outputs that have identical EDID

# DisplayPort FAQs

## Adapters

DisplayPort [DP] adapters are used to convert DP to DVI for use with equipment supporting the DVI interface.



**Warning:** As they provide the least flexibility we avoid the use of Passive DisplayPort adapters in any situation.

## Types of adapters

There are three main types of DP adapters:

- Passive single-link
- Active single-link
- Active dual-link

**We recommend using Active adapters for most applications.** Active adapters are shown in the image here and support a maximum 1920x1200 output resolution.



Using Active DisplayPort adapters will allow you to output resolutions up to 1920 x 1200 pixels per DisplayPort output.

## Identifying DisplayPort adapters

DisplayPort adapters can be identified by the following:



Active adapters will always have the word Active on them (left), passive adapters will not have the word Active on them (middle), DisplayPort to dual link *DVI* adapters will always have a *USB* connector (right)

**Please note:** For more information please see [here](#)

## Outputting more than 1920x1200

Yes, in order to output a dual link DVI signal (max 2560 x 1600), extra power is required. If you want to output up to 2560 x 1600 pixels you will need to use Active Dual Link adapters [not included]. Active Dual Link adapters will always have an external USB cable as they require extra power.

Therefore the following rules apply:

- For 2 or less outputs of DVI single link, passive adapters can be used.
- For 3 or more outputs of DVI single link, active adapters must be used.

- For any amount of outputs of DVI dual link, active DisplayPort to dual link adapters must be used.

## Recommended adapters

The following adapters have been used and tested with d3 systems.

### Active DisplayPort to single-link

- [StarTech DisplayPort to DVI Active Adapter](#)
- [Weison Active DP to single-link DVI Adapter](#)

### Active DisplayPort to dual-link

- [StarTech DisplayPort to DVI Dual-link Active Adapter](#)
- [Accell DisplayPort to DVI-D Dual-link Adapter](#)

## DisplayPort Cables

- The maximum supported DisplayPort cable length is 2m (6ft).
- The DP cable needs to be triple shielded.
- Symptoms of an unsupported cable:
  - » Flickering or black screen: Cable is too long or the differential pairs have too great resistance to transport the bandwidth required
  - » Noise on the signal: Shielding is not adequate for the environment
- Good quality cable can be purchased from **Molex, Accell, BizLink**

# Filter Maintenance

You should regularly inspect the air filter on the front of the unit to prevent loss of cooling efficiency.

## Overview



**Warning:** It is recommended that you service the air filter when the unit is powered off. If the unit is on you will be exposed to the system fans and this may result in injury.

## Pro range

### 2x4pro

To remove the air filter material, first remove the screws marked in the diagrams below.



*Air filter housing and thumb screws on front of 2x4pro unit*



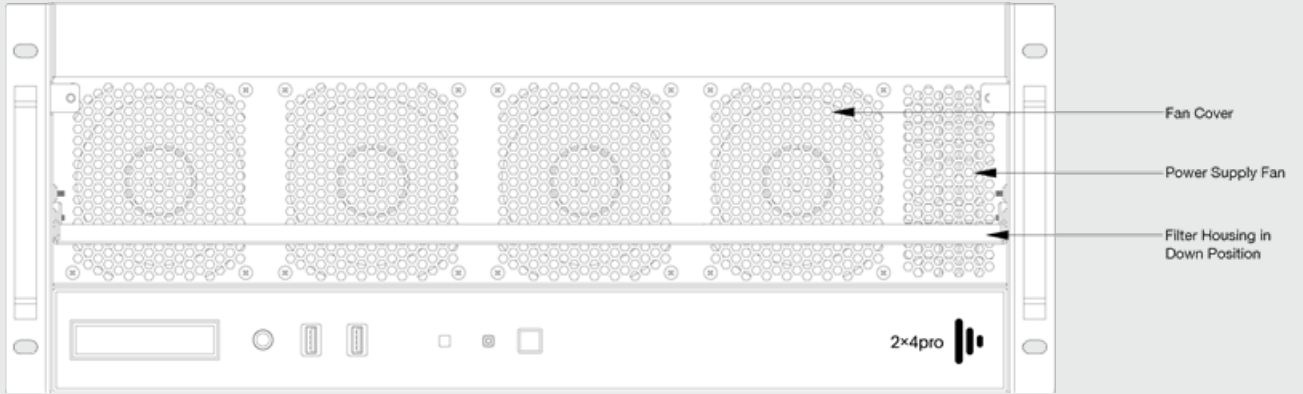

Plan view of air filter housing on the 2x4pro once opened

Next, clean the filter, then replace the filter in the metal frame and reattach the frame to the front of the unit.



2x4pro

## 4x4pro

To remove the air filter material, first remove the screws marked in the diagrams below.

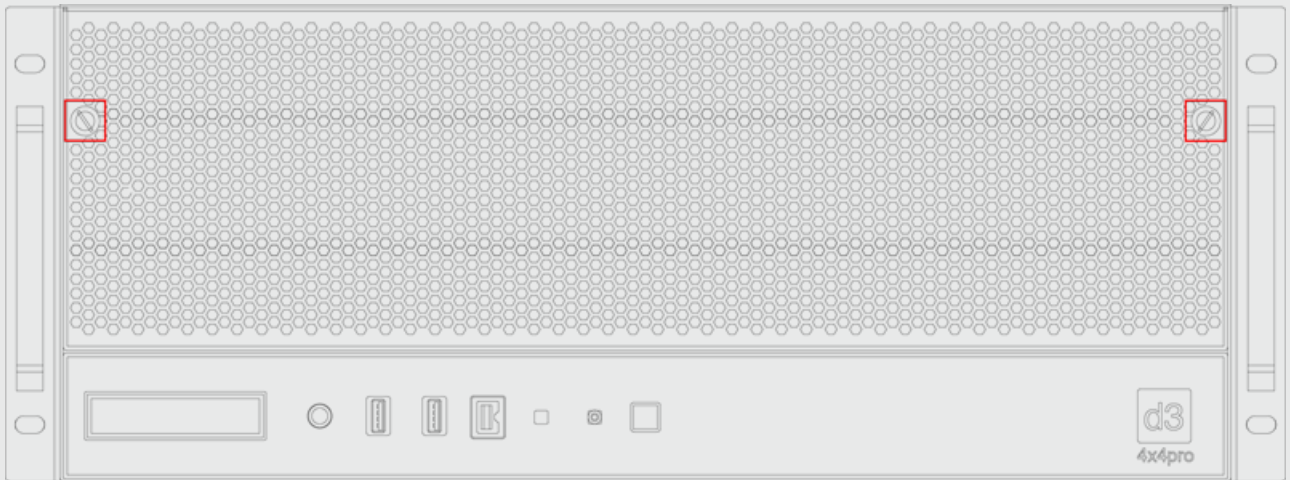

*Air filter housing and thumb screws on front of 4x4pro unit*

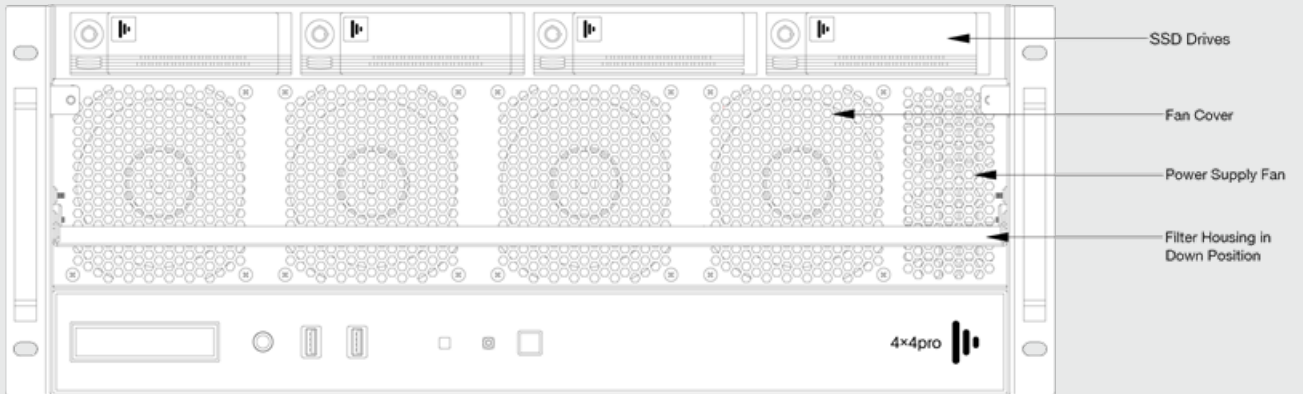

*Plan view of air filter housing on the 4x4pro once opened*

Next, clean the filter, then replace the filter in the metal frame and reattach the frame to the front of the unit.



4x4pro

## VX 4

To remove the air filter material, first remove the screws marked in the diagrams below.

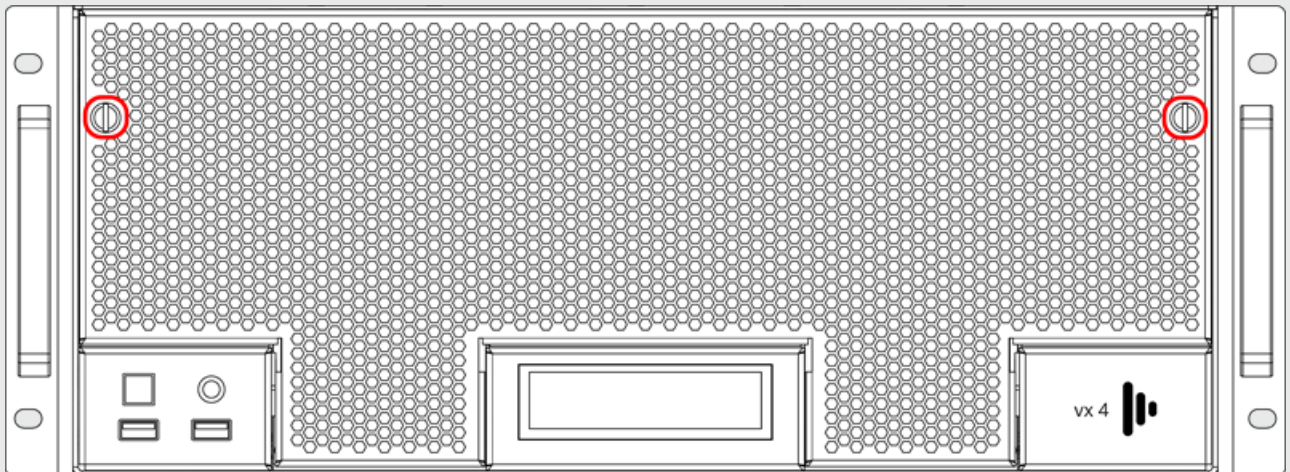

*Air filter housing and thumb screws on front of vx 4 unit*

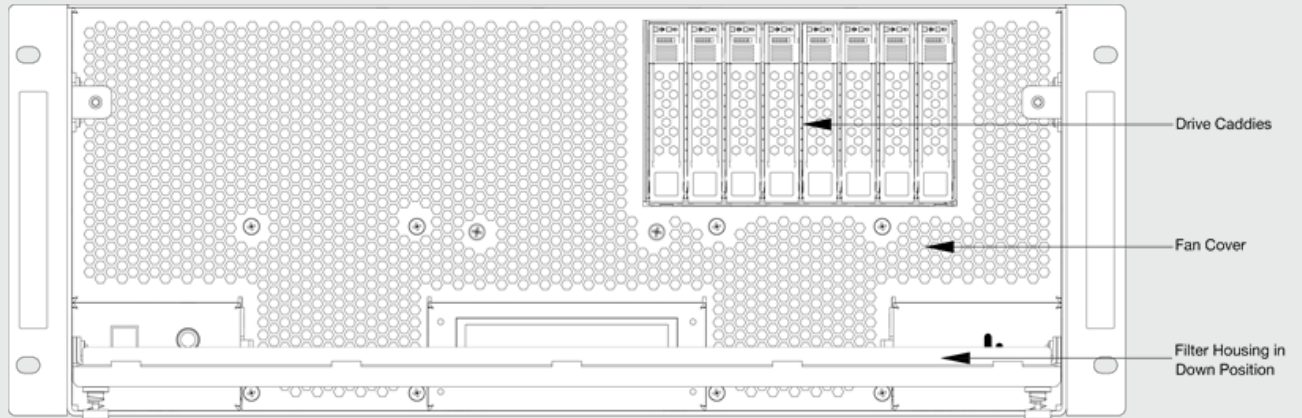

Plan view of air filter housing on the vx 4 once opened

Next, clean the filter, then replace the filter in the metal frame and reattach the frame to the front of the unit.

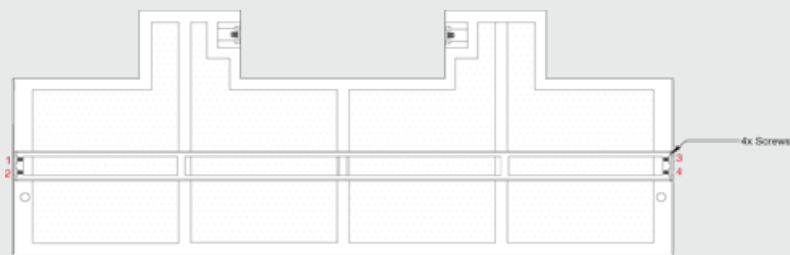

vx 4

## gx range

### gx 1

To remove the air filter material, first remove the screws marked in the diagrams below.

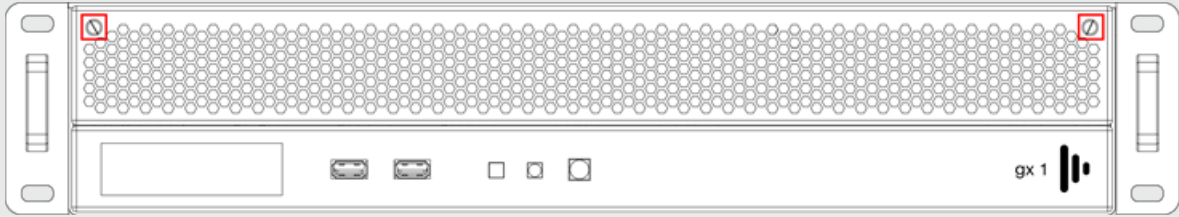

*Air filter housing and thumb screws on front of gx 1 unit*

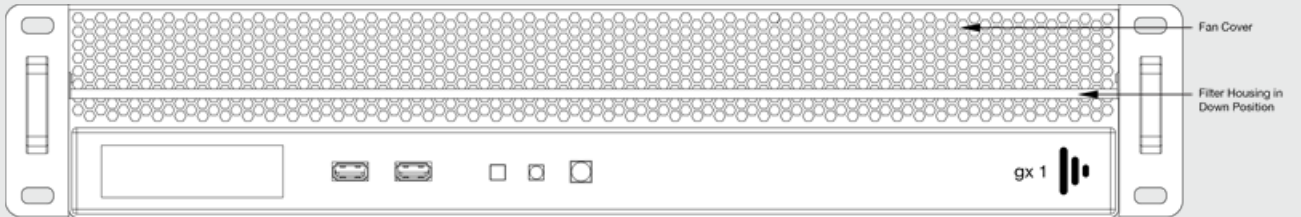

*Plan view of air filter housing on the gx 1 once opened*

Next, clean the filter, then replace the filter in the metal frame and reattach the frame to the front of the unit.



*gx 1*

## gx 2 & gx 2c

To remove the air filter material, first remove the screws marked in the diagrams below.

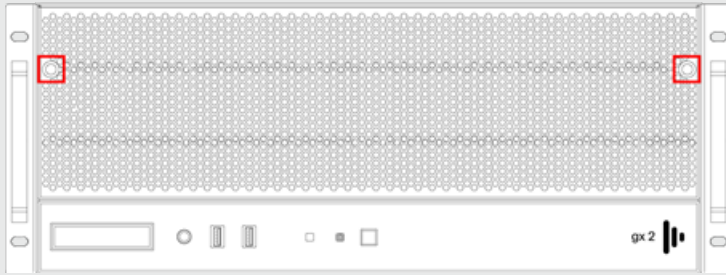

Air filter housing and thumb screws on front of gx 2 & gx 2c unit

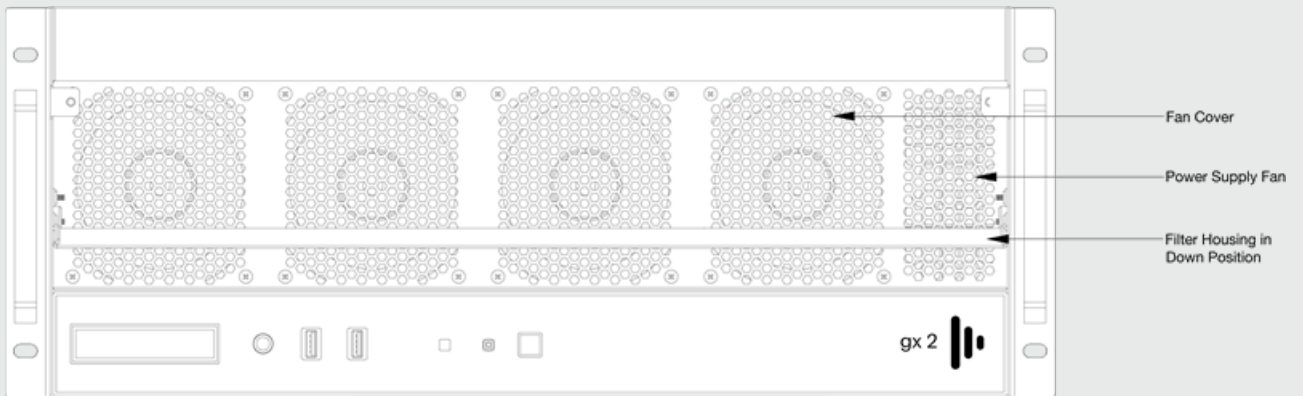

Plan view of air filter housing on the gx 2 and gx 2c once opened

Next, clean the filter, then replace the filter in the metal frame and reattach the frame to the front of the unit.

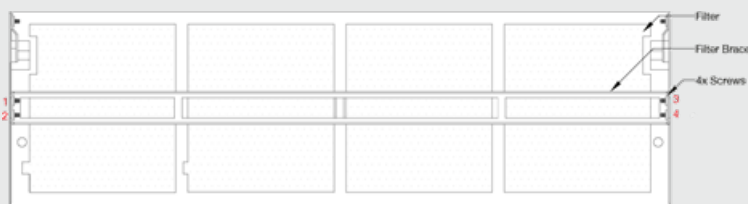

gx 2 & gx 2c

## Plus range

To remove the air filter material, first remove the screws marked in the diagrams below.



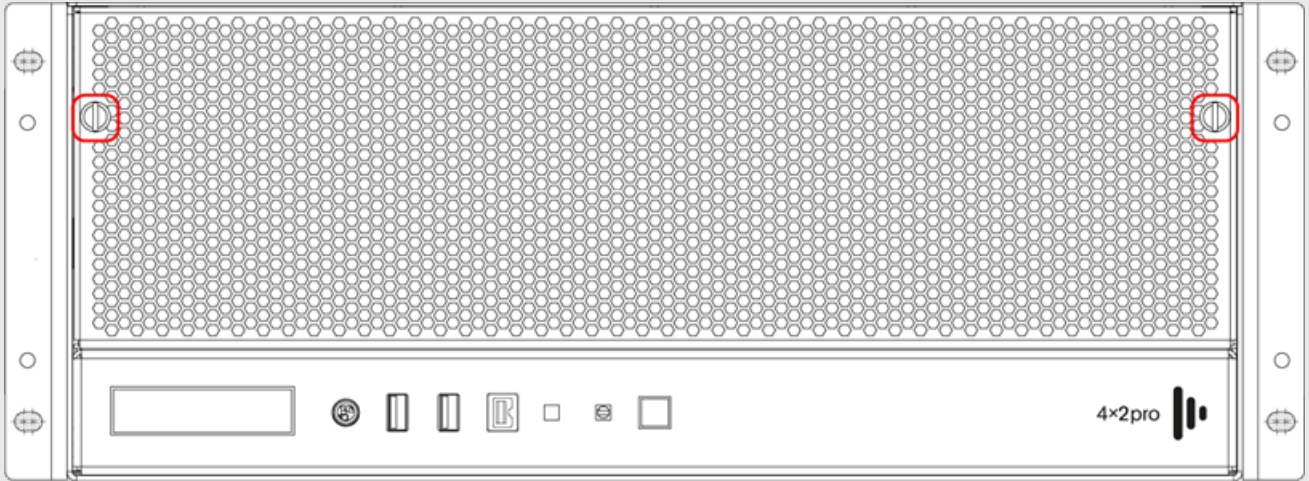

Air filter housing and thumb screws on front of 4x2pro unit

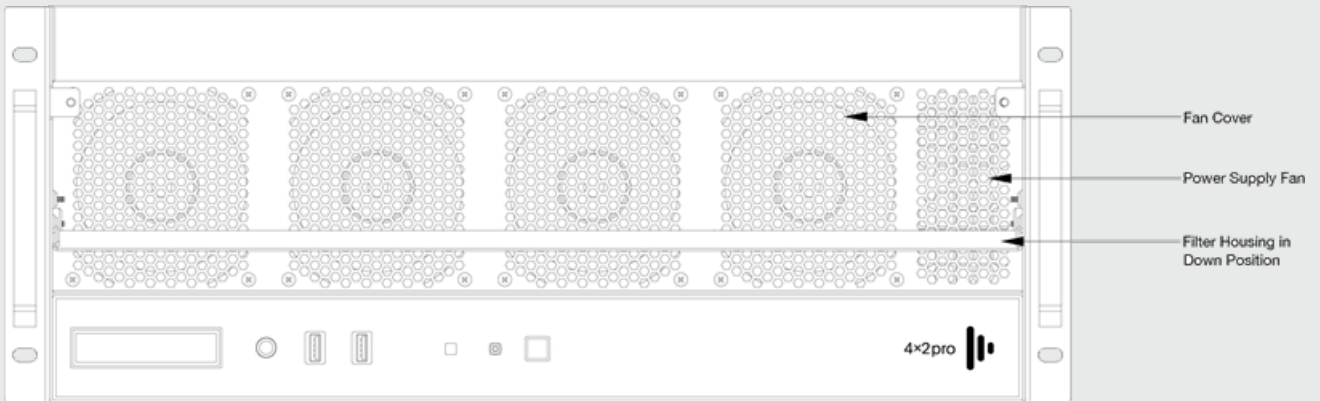

Plan view of air filter housing on the 4x2pro once opened

Next, clean the filter, then replace the filter in the metal frame and reattach the frame to the front of the unit.



4x2pro

# Filter Maintenance

You should regularly inspect the air filter on the front of the unit to prevent loss of cooling efficiency.

## Overview



**Warning:** It is recommended that you service the air filter when the unit is powered off. If the unit is on you will be exposed to the system fans and this may result in injury.

## Pro range

### 2x4pro

To remove the air filter material, first remove the screws marked in the diagrams below.

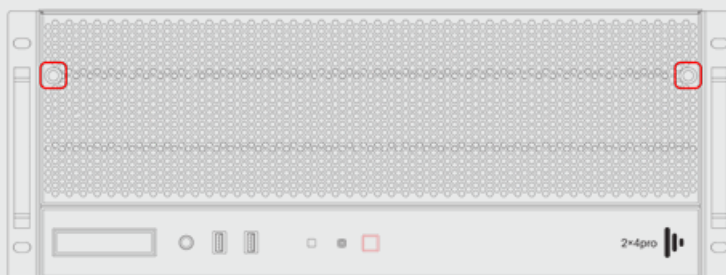

*Air filter housing and thumb screws on front of 2x4pro unit*



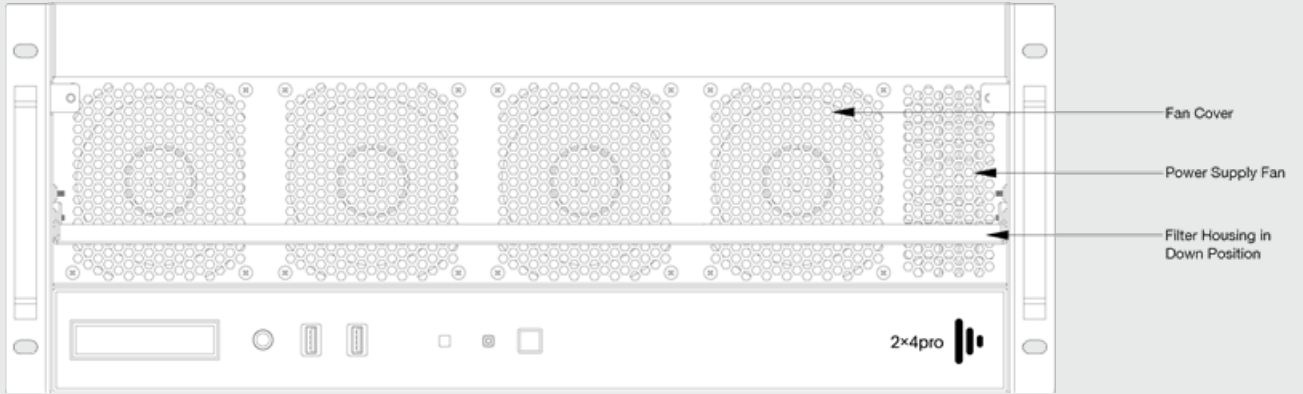

Plan view of air filter housing on the 2x4pro once opened

Next, clean the filter, then replace the filter in the metal frame and reattach the frame to the front of the unit.



2x4pro

## 4x4pro

To remove the air filter material, first remove the screws marked in the diagrams below.

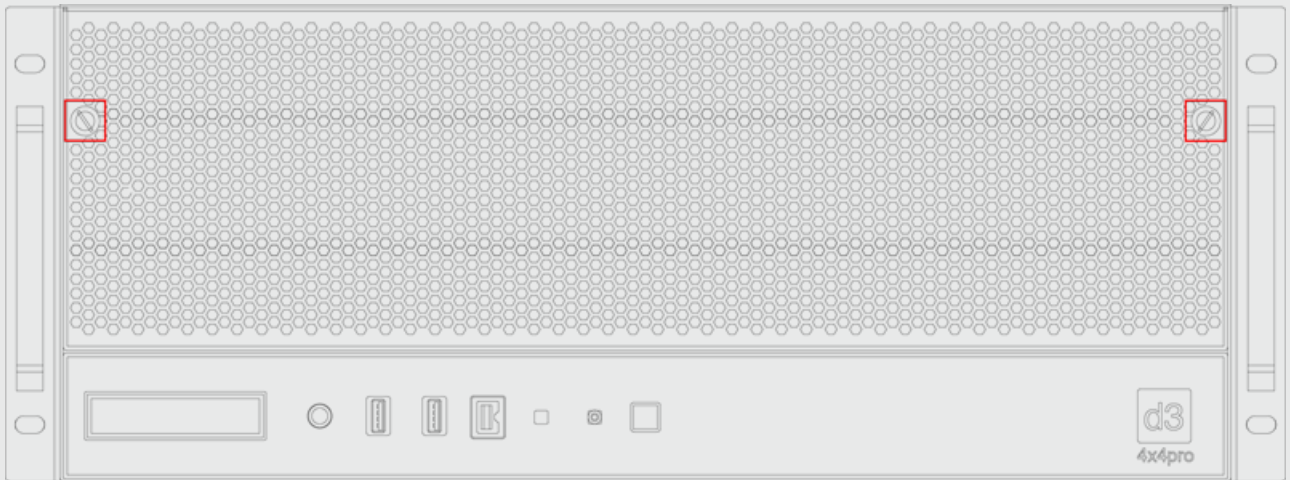

*Air filter housing and thumb screws on front of 4x4pro unit*

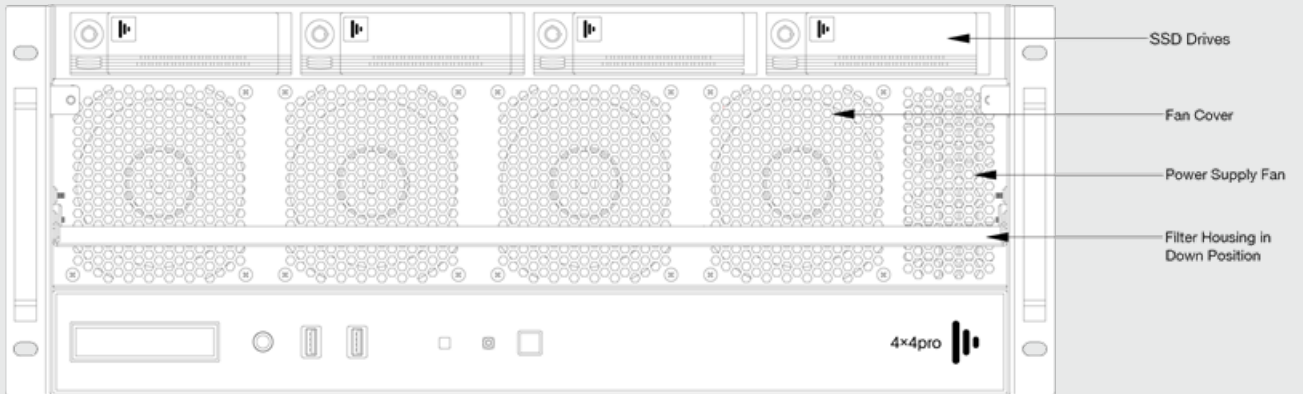

*Plan view of air filter housing on the 4x4pro once opened*

Next, clean the filter, then replace the filter in the metal frame and reattach the frame to the front of the unit.



4x4pro

## VX 4

To remove the air filter material, first remove the screws marked in the diagrams below.

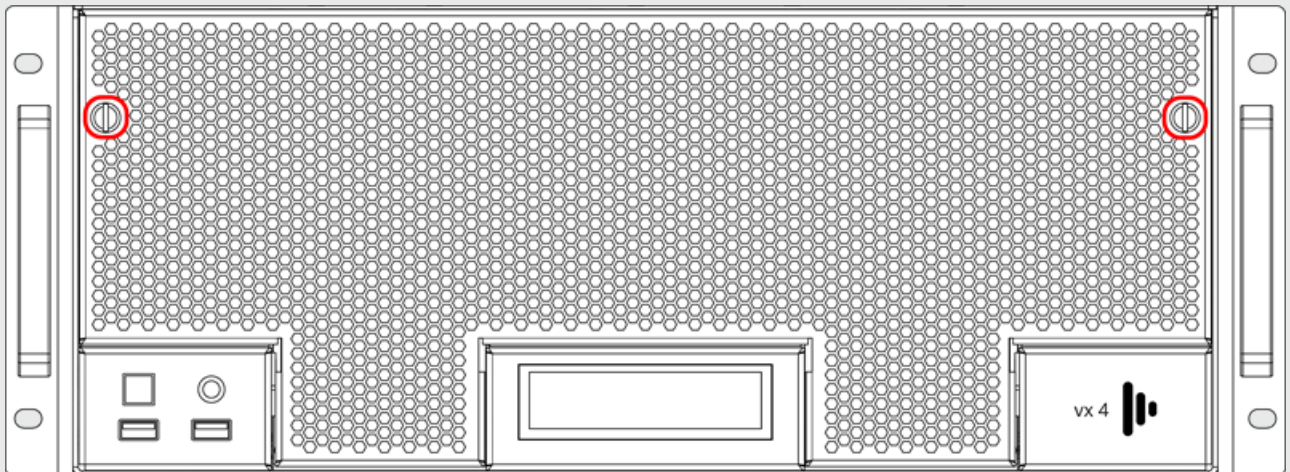

*Air filter housing and thumb screws on front of vx 4 unit*

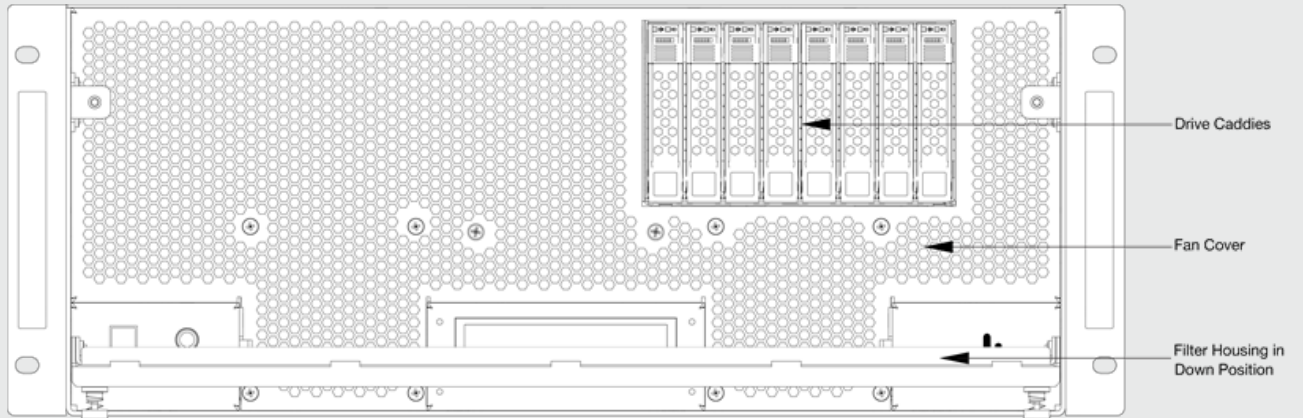

Plan view of air filter housing on the vx 4 once opened

Next, clean the filter, then replace the filter in the metal frame and reattach the frame to the front of the unit.

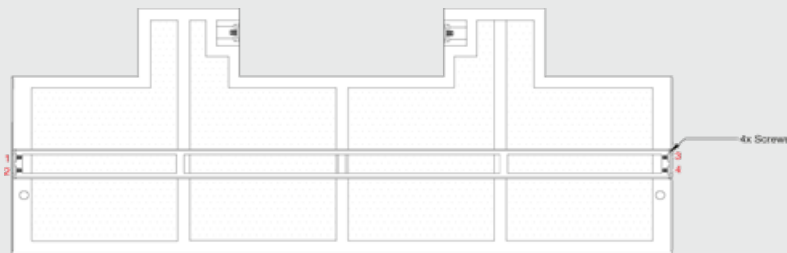

vx 4

## gx range

### gx 1

To remove the air filter material, first remove the screws marked in the diagrams below.

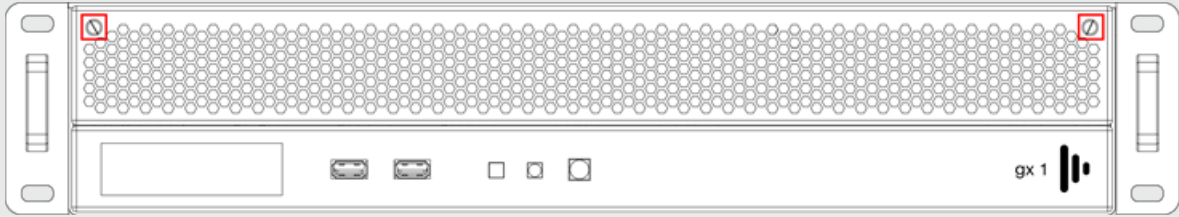

*Air filter housing and thumb screws on front of gx 1 unit*

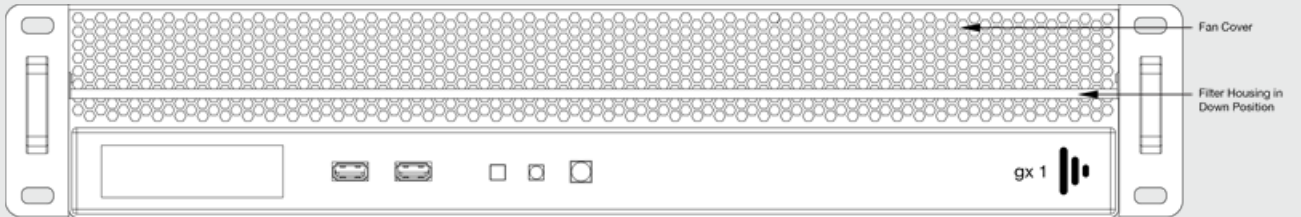

*Plan view of air filter housing on the gx 1 once opened*

Next, clean the filter, then replace the filter in the metal frame and reattach the frame to the front of the unit.



*gx 1*

## gx 2 & gx 2c

To remove the air filter material, first remove the screws marked in the diagrams below.

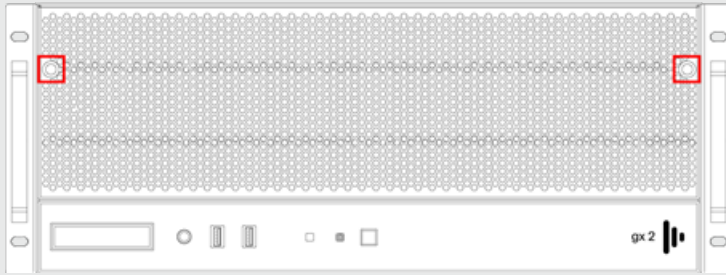

Air filter housing and thumb screws on front of gx 2 & gx 2c unit

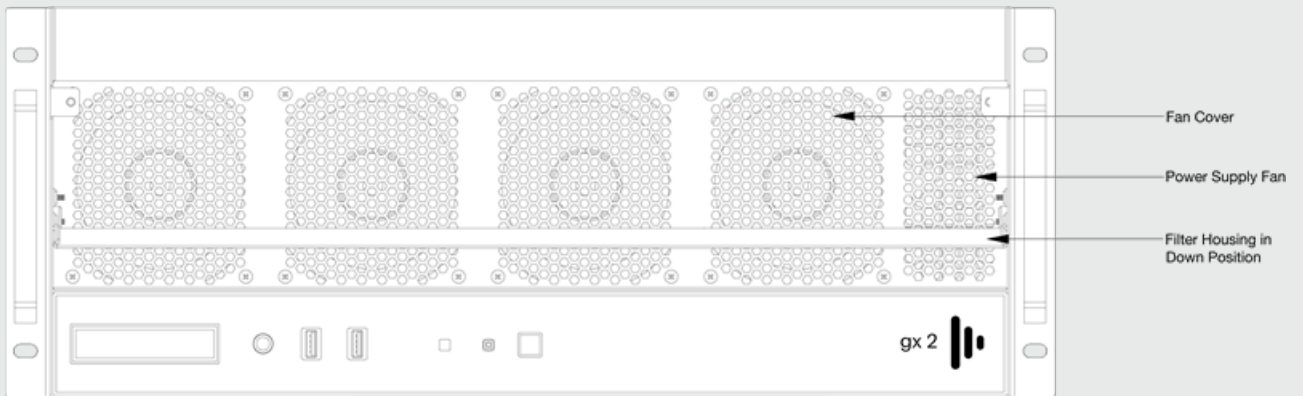

Plan view of air filter housing on the gx 2 and gx 2c once opened

Next, clean the filter, then replace the filter in the metal frame and reattach the frame to the front of the unit.

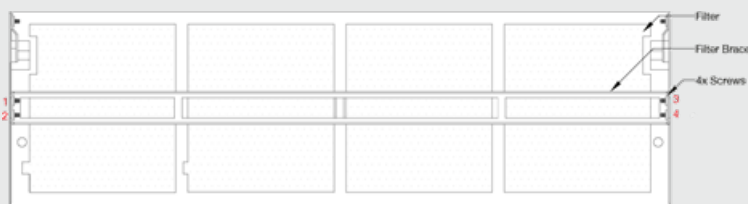

gx 2 & gx 2c

## Plus range

To remove the air filter material, first remove the screws marked in the diagrams below.



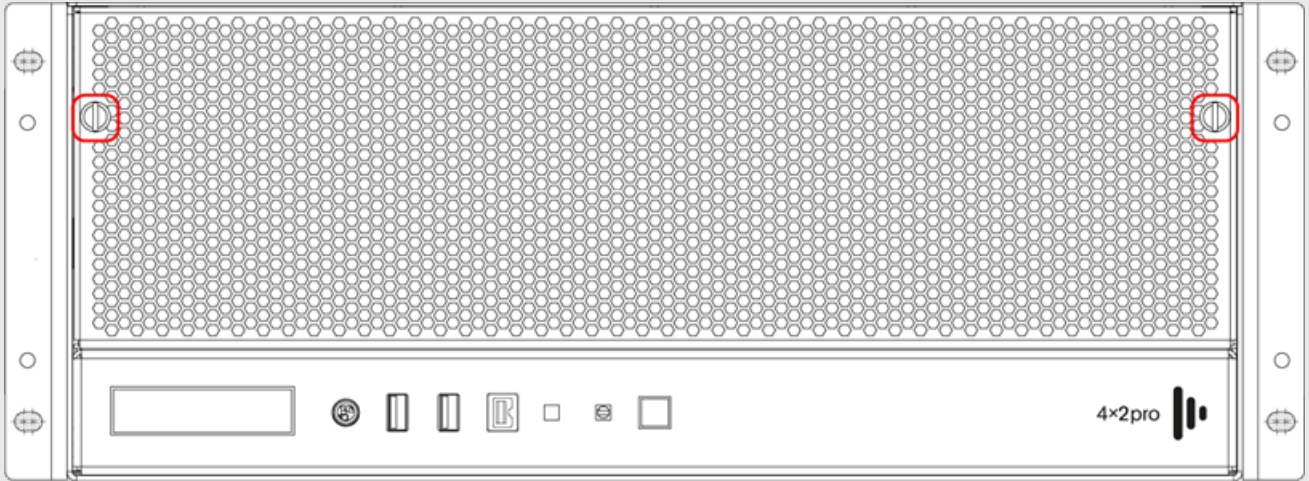

Air filter housing and thumb screws on front of 4x2pro unit

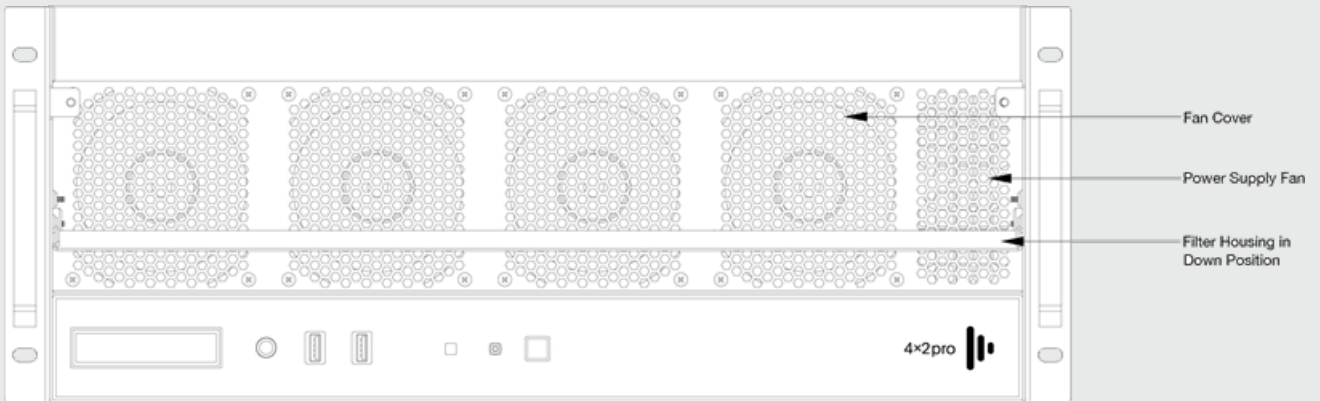

Plan view of air filter housing on the 4x2pro once opened

Next, clean the filter, then replace the filter in the metal frame and reattach the frame to the front of the unit.



4x2pro

# Machine Performance

In order to keep at framerate it's a balancing act between GPU time and CPU.

## Every frame follows a simple pattern:

CPU updates everything and sets up the rendering for that frame, then at the end it calls 'present'. 'Present' then blocks any further CPU action until the GPU outputs the frame to the screens.

The following graphs are useful to address performance concerns:

### FPS

It's good for a simple overview

### GPU

Shows the time spent in the frame: the dotted red line is what you want to be underneath, This is your ms budget per frame to hit every genlock pulse.

### CPU

Shows some info on where the CPU is spending most of its time.

### Graph data

- working time is the actual time the CPU spent doing things
- present wait time shows how much time the CPU sat there waiting for the GPU to finish it's job
- present wait time does not include the working time, so after the working time the CPU still waits that amount of time for the GPU to finish



- you will always block on present because the GPU won't output until a genlock pulse is received (or a vsync pulse if you are locked to the server's own timing)
- If in free run the GPU can just output whenever present is called; present will still block until all outputs have finished) so the balancing act is making sure the CPU finishes in under the ms budget, and making sure the GPU finishes in time for the genlock pulse

### Troubleshooting Framedrops

- if your working time is under-budget but your present time pushes you over budget, your GPU is causing the framedrops
- if your working time is over-budget then your CPU is causing framedrops
- with **Notch** there is both CPU work and GPU work so you have to consider both

### Profiler

- for a breakdown of CPU timings you can press CTRL + ALT + P to see the Profiler which shows functions and how much time (in ms) is spent there
- D3::frame is the root
- you can find NotchModule calls to see how much cpu time is spent on notch calls; this helps you figure out if you are going over your frame budget because of what you've got in disguise or what you've got in notch

If you are actually waiting for the GPU to finish then it's more difficult to get a breakdown; it's best to mute the layer and see if it is purely the cause of GPU time being so high in that section.

Once you know the cause you can now address things appropriately

- If **Notch** is spending too much of your CPU time then this is down to parameters
- if it's GPU then it's down to rendering techniques

# Machine Monitoring Graphs

There are several machine monitoring graphs within Disguise software.

To open the Monitoring Manager, left click on the FPS in the lower right corner of the track.

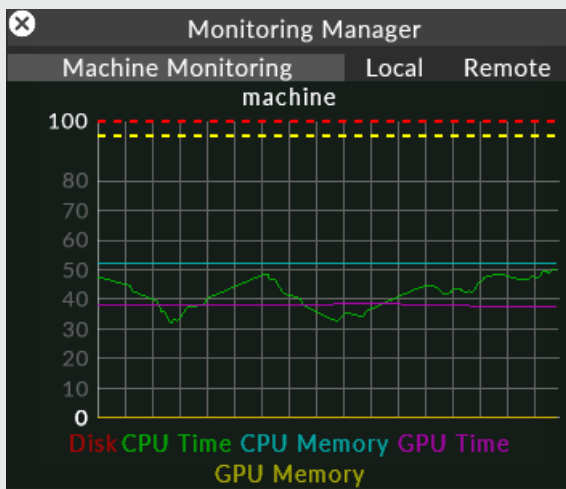

Once the Monitoring Manager window is open, left click on Local to see the list of monitoring graphs:

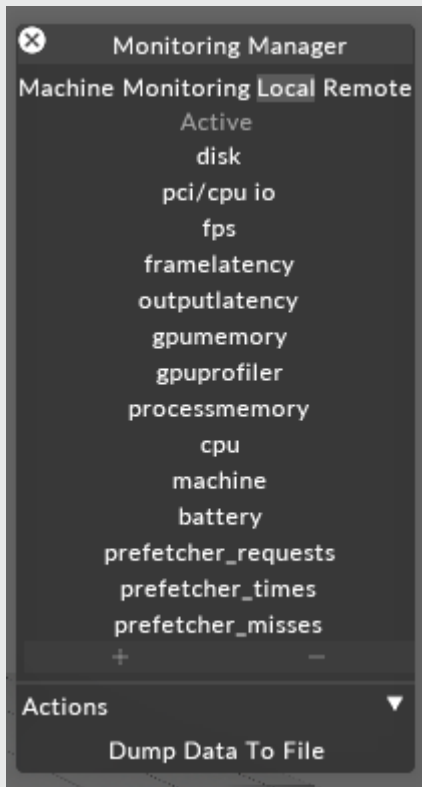

## Output Latency Graph

### What is it?

This graph shows the queue length for each output. The queue length is dictated by whether the project is running at normal latency, low latency or ultra low latency.

This graph can be used to see dropped frames. If the queue length drops down by one, then a frame has been shipped before the next frame has joined the queue. Because frames are queued, this will not be seen on the output as a dropped frame. Running in ultra low latency where frames are shipped as soon as they have rendered, means that if the next frame is ready when a frame ships, you will see a frame drop.

If running at normal latency, but the graph line drops to zero, then frames are not ready fast enough which could manifest as framedrop.

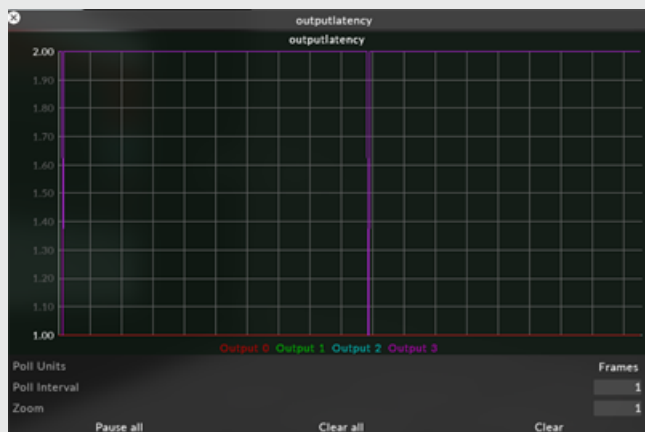

## GPU Profiler

### What is it?

This is a cumulative graph that shows the amount of time spent in different tasks, e.g how much time spent in the GUI, how much time downloading DMX.

The sequence of events when playing back a video is:

Frames are loaded from video files -> decoded into RAM -> uploaded to the GPU -> rendered on the GPU.

### Frame

The amount of time taken to render the frame on the GPU. This includes other rendering work, not just that related to video playback. When Frame finishes, the frame is ready to be presented.

### Deliver Frames

The amount of time a frame takes to upload to the GPU in the sequence of events described above.

### Compositor

The composite time spent on all the track elements together.

### GUI

The amount of time spent rendering the GUI.

### Render Everything

The cumulation of all the components that make up Compositor and GUI time.

### DMX

The time spent downloading DMX

## How do I use it?

When looking at the graph you can see how much time is spent in each part of the process. If any lines are going above the dotted lines then the server is dropping frames. The dotted lines indicate the maximum amount of time that can be spent at either 50fps or 60fps.

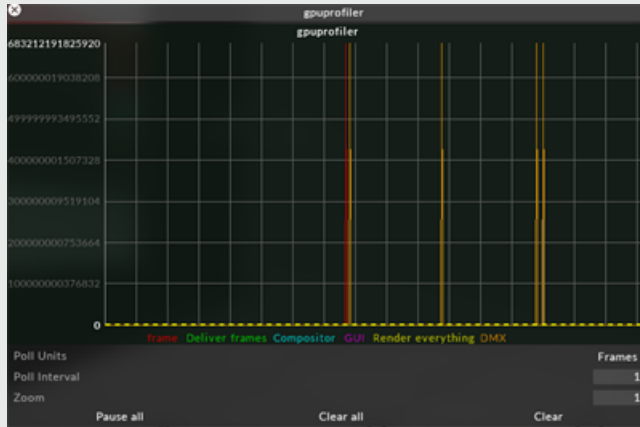

# Frame Latency

## What is it?

Graphs in milliseconds (ms) the journey of a frame from the time it is rendered through to being presented for output, relative to the present time which is 0.

### Ready

The time that the frame was ready (rendered) at. Whenever a frame is rendered, it is 'ready'. 'Ready' shows how many milliseconds in advance the frame was ready before it was actually presented. This value will vary based on the load on disguise.

### Queued

Time the frame was added to the present queue. The present queue is disguise notifying windows that this is an upcoming frame. This will most likely be identical to 'ready' as the frame is added to the queue as soon as it is rendered. The time may be higher if the queue is full, so the frame can't be immediately added to the queue.

## Estimated Present

From when it was added to the queue, the time at which it is estimated that the frame will be presented given the length of the queue.

## Present

The time at which the frame was actually presented, which is always 0. All other graphed values are relative to this.

## How do I use it?

If disguise is running slow, frames will not be ready in time and will be too close to 0, or after 0. This means it is dropping frames. You will also see that if running in low or ultra low latency mode, there is less time from 'ready' to 'present', and in half speed mode the frame is ready twice as early as in full speed mode.

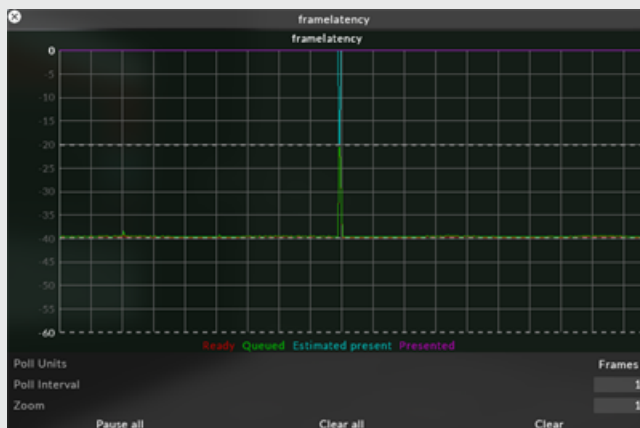

# FPS

## What is it?

Graphs the frames per second (FPS) per head

## How do I use it?

Use this graph to see if you are dropping frames on any output head

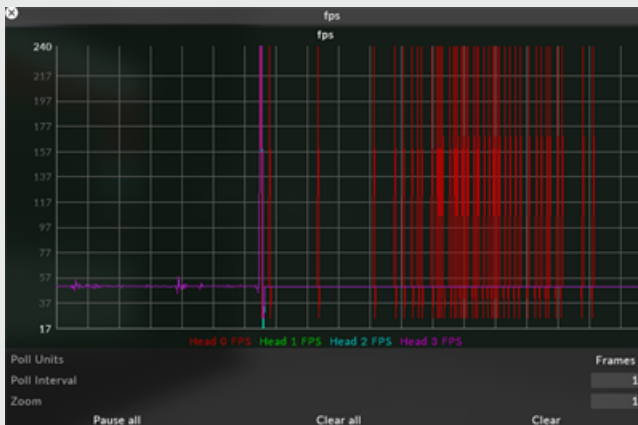

# Process Memory

## What is it?

Memory Used (MB)

How much memory disguise is using.



## Delta (KB)

The difference between how much memory in use from one frame to the next.

## How do I use it?

You can see values changing as you add and remove resources, e.g. many of the normal actions of setting up and programming a showfile.

This graph usually should not have to be used, but it can be used if experiencing crashes to make sure they are not memory related. If there is a memory leak, the delta will continuously spike in an upwards trend.

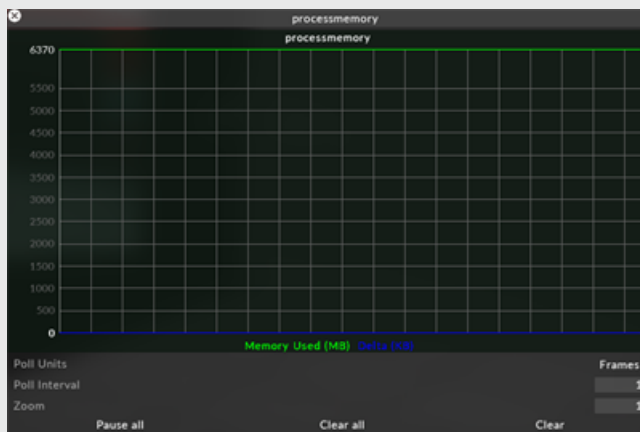

# Plot Calibration Error Graphs

## What is it?

The plot calibration error graph allows you to look for correlations between camera positions and calibration errors in each axis. It was designed with mechanical / encoder based tracking systems in mind, which are susceptible to movements that are not accounted for by the tracking system data, e.g a droop at the end of a long crane arm.

While this tool does not tell you how to fix any errors, it can show you where to look for a problem.

## Navigation

**Please note:** The Plot Calibration Errors graphs is located within the Spatial Calibration-Debugging menu

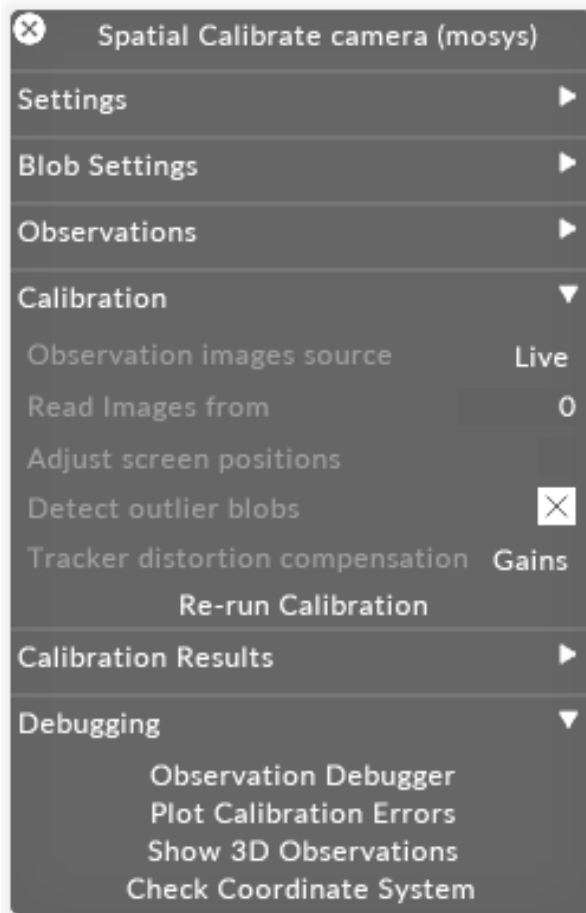

- 'Plot calibration error' graphs each observation in the list as a single plot. The observation number is displayed next to the plot.
- The controls in the top left allow you to choose to display positions and rotations on either x or y axes.
- The graphs auto-scale, so pay attention to the measurements on each axis.

- The Y axis for each plot is the error in the axis (difference between the solved position in disguise and the position from the tracking position)
- The X axis is the position value

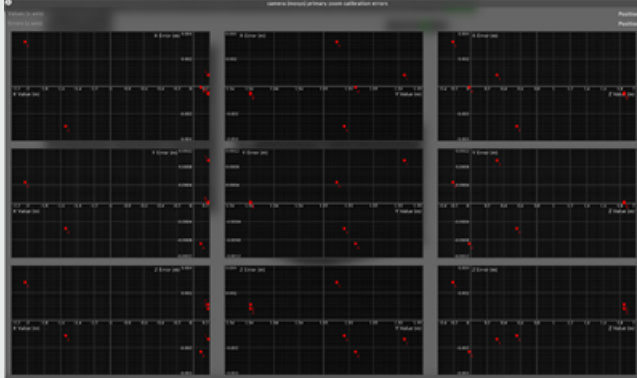

## How do I use it?

- Trends in the graphs, e.g. a straight line between plots, shows that there may be some causality between the movement and the error.
- Use the magnitude of the error and the magnitude of the movement to discern whether trends are just noise, or whether there is a true trend in axes affecting one another.
- More observations provide more data with which to spot trends. It will not be possible to reliably spot a trend with only a couple observations.
- Not every observation you've taken will necessarily show a change in position on every axis, so the data can look a bit random. This is fine and normal.

# PCI/CPU IO

## What is it?

### Read

Graphs the data the CPU is reading from PCI devices.

### Write

Graphs the data the CPU is writing to PCI devices.

### Other

The number of bytes transferred during operations other than read and write.

## How do I use it?

It is very unlikely that this graph will be needed in normal operation. Could be used if a fault with a PCI device or the motherboard is suspected.

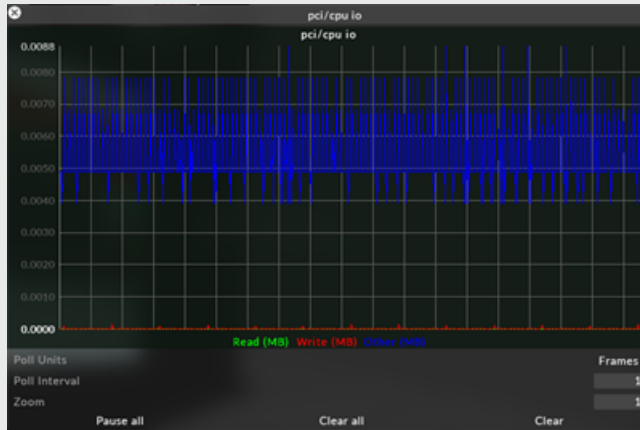

## Disk

### What is it?

Shows the read and write disk speed in MB/s.

### How do I use it?

Could be used to see if you were bottlenecked somewhere e.g. read speed would go up and then plateau.

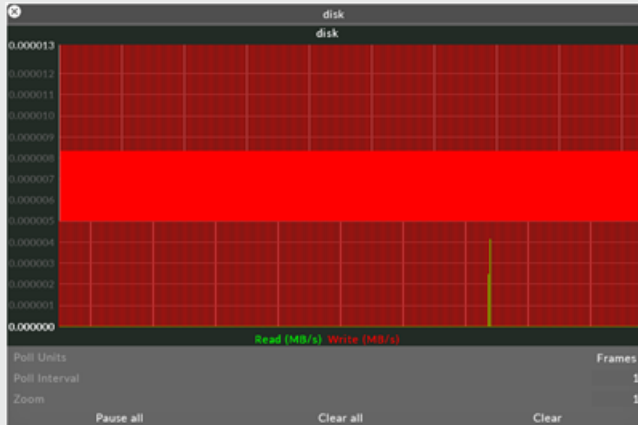

## CPU

### What is it?

The CPU graph is cumulative.

#### Working Time (ms)

The amount of time spent on the CPU

#### Present Wait Time (ms)

The amount of time waiting to present. When running a project in normal latency this should be flat, but when running in ultra low latency this series will be 'spikey' as there's no queue.

#### Total Time (ms)

Total time is the cumulation of working time and present wait time, and should always sit beneath the ms required at your FPS.

## How do I use it?

In a normal setup, total time should be flat because disguise takes the full CPU cycle to present a frame. At the end of every update loop, something is given to the GPU to present. If that loop is finished early, then there has to be a wait before there is a slot available in the queue.

If the CPU working time is high and the present time is low, then this is because the queue is empty. If frames are dropped in this scenario, then it is because of CPU load.

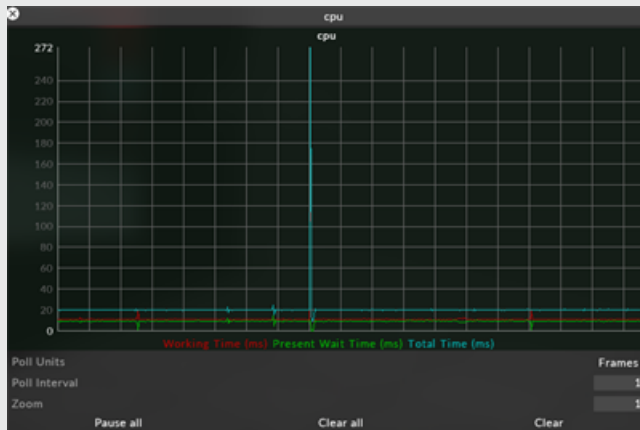

## GPU Memory

### What is it?

This graph shows the amount of memory that the GPU is currently using.

The GPU is responsible for dealing with its own memory allocation, but disguise tries to be as efficient as possible with the GPU memory it requires.



All textures that are rendering onscreen in the GUI are bitmaps that are uploaded to the GPU. This includes all GUI elements, as well as any media that is playing back.

disguise tries to reduce the amount of GPU memory in use by evicting textures when they are no longer needed. If textures are not used for a while, they are evicted. Conversely, some textures e.g LUTS are expensive to upload to the GPU, but once they are uploaded they are fast to use. For this reason, disguise tells the GPU to keep these textures alive.

## How do I use it?

Not commonly needed, but if a bug e.g. a memory leak, is suspected, a constantly increasing GPU Memory value is useful information for reporting the suspected bug. GPU Memory will increase as textures are uploaded, and decrease as they are evicted.

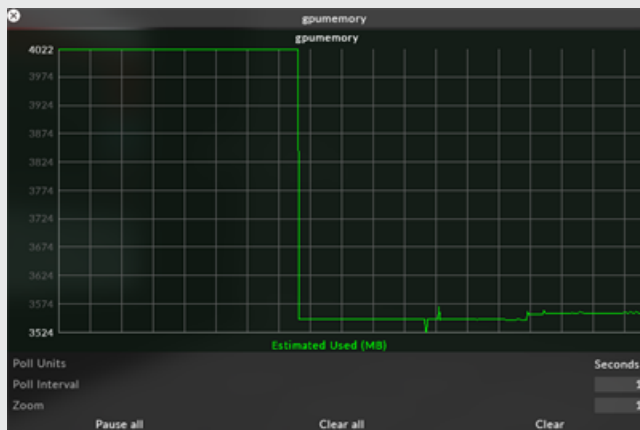

## Timer

### What is it?

actualFrameTime is the clock of the next upcoming present, and the delta is the amount of time passed between each frame time.

## How do I use it?

This value should remain constant, at a value dictated by the fps of the system.

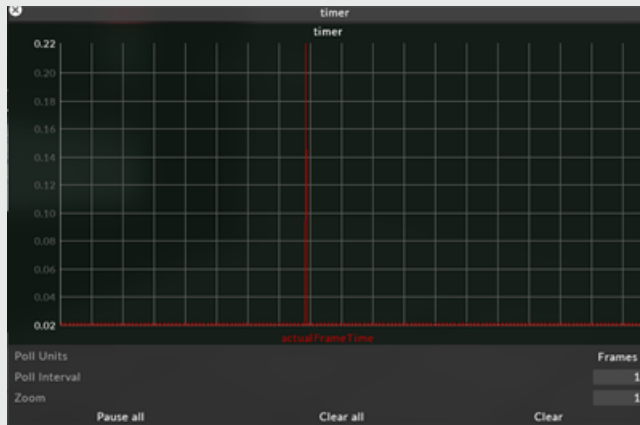

# Machine Performance

In order to keep at framerate it's a balancing act between GPU time and CPU.

## Every frame follows a simple pattern:

CPU updates everything and sets up the rendering for that frame, then at the end it calls 'present'. 'Present' then blocks any further CPU action until the GPU outputs the frame to the screens.

The following graphs are useful to address performance concerns:

### FPS

It's good for a simple overview

### GPU

Shows the time spent in the frame: the dotted red line is what you want to be underneath, This is your ms budget per frame to hit every genlock pulse.

### CPU

Shows some info on where the CPU is spending most of its time.

### Graph data

- working time is the actual time the CPU spent doing things
- present wait time shows how much time the CPU sat there waiting for the GPU to finish it's job
- present wait time does not include the working time, so after the working time the CPU still waits that amount of time for the GPU to finish
- you will always block on present because the GPU won't output until a genlock pulse is received (or a vsync pulse if you are locked to the server's own timing)

- If in free run the GPU can just output whenever present is called; present will still block until all outputs have finished) so the balancing act is making sure the CPU finishes in under the ms budget, and making sure the GPU finishes in time for the genlock pulse

### Troubleshooting Framedrops

- if your working time is under-budget but your present time pushes you over budget, your GPU is causing the framedrops
- if your working time is over-budget then your CPU is causing framedrops
- with **Notch** there is both CPU work and GPU work so you have to consider both

### Profiler

- for a breakdown of CPU timings you can press CTRL + ALT + P to see the Profiler which shows functions and how much time (in ms) is spent there
- D3::frame is the root
- you can find NotchModule calls to see how much cpu time is spent on notch calls; this helps you figure out if you are going over your frame budget because of what you've got in disguise or what you've got in notch

If you are actually waiting for the GPU to finish then it's more difficult to get a breakdown; it's best to mute the layer and see if it is purely the cause of GPU time being so high in that section.

Once you know the cause you can now address things appropriately

- If **Notch** is spending too much of your CPU time then this is down to parameters
- if it's GPU then it's down to rendering techniques

# Workflows Overview

The powerful and flexible set of tools within Disguise software are utilised to create some of the most spectacular shows in a wide range of projects including VP, Broadcast, Fixed Installation, and Live events.



# VP Workflow Overview

The disguise virtual production workflow enables production teams to capture the creative magic of working together as they would with physical sets, while minimising the amount of time and resource needs of conventional post-production VFX.

## Virtual Production Toolkit

Using state-of-the-art technology that enables real-time visuals to be shown live for actors and crew to respond to, virtual production opens up a world of opportunity. The toolset is already pushing the boundaries for filmmakers, with more exciting uses rapidly emerging.

## Pre-Production



**VFX & Computer Graphics**  
Colour consistency across all departments

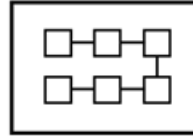

**Previz & Shot Planning**  
Previsualise real-time content in disguise and validate ideas

## The disguise Production Workflow

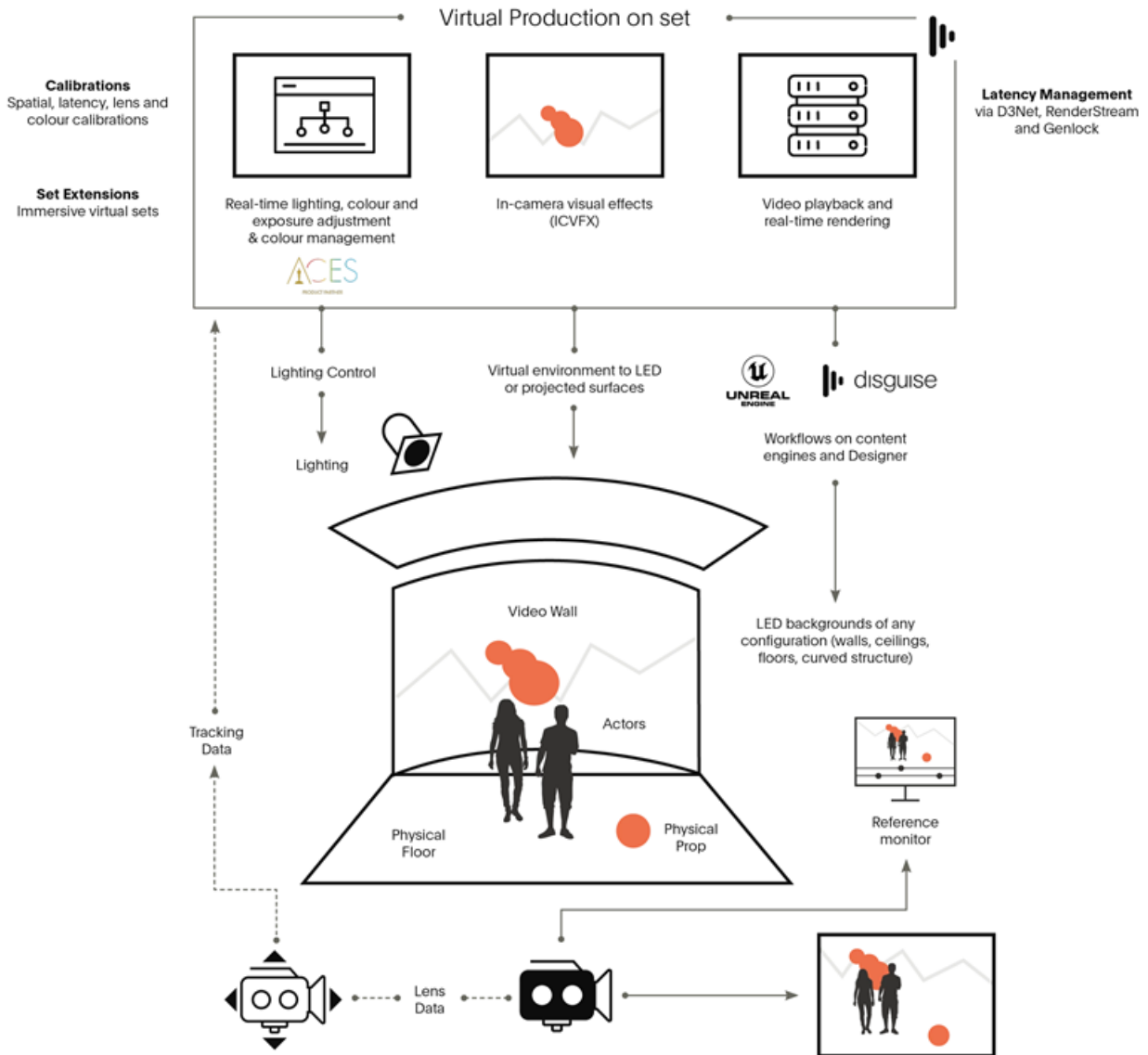

# 2.5D Workflows

With Disguise's 2.5D workflow tools, you can achieve the parallax effect of real-time 3D content with the simplicity of video plates.

## Overview

### What is a 2.5D workflow?

2.5D workflows bridge the gap between traditional 2D video plates and full 3D generative scenes. By building up a scene with layers of images or video plates, with the possibility to add depth or shaping to the plates, users can quickly create a realistic looking scene with parallax. 2.5D assets can be saved as .2p5d files and shared across projects, or created using external integrations such as Cuebric to harness the power of generative AI.

### See How It Works

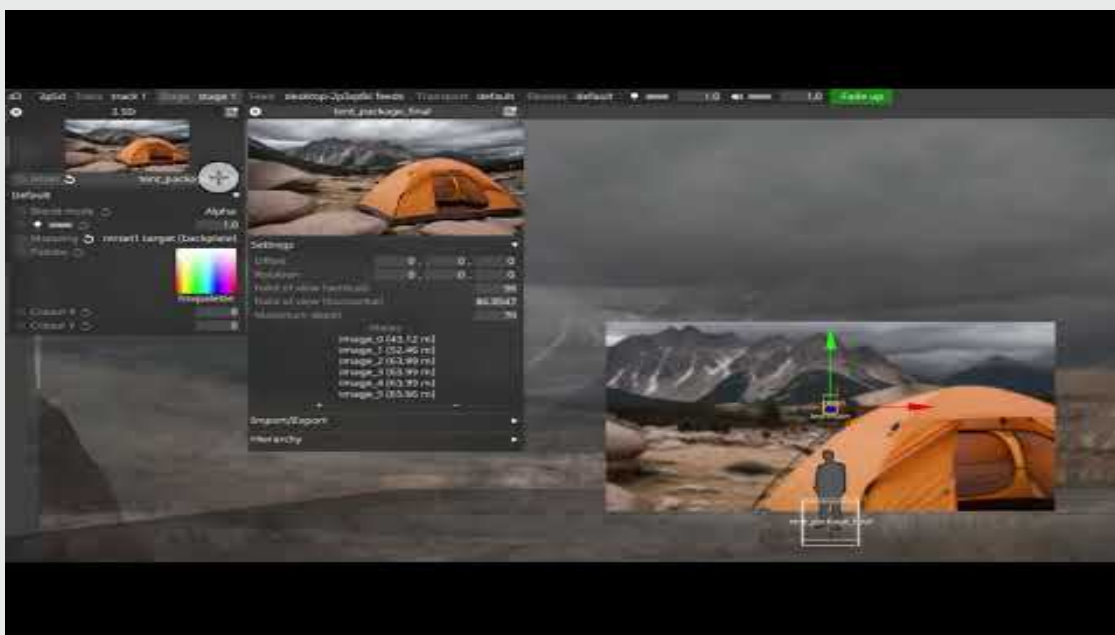



# Workflow

This section details the following how-to guides:

- Set up a 2.5D asset from an existing .2p5D file
- Create a new 2.5D asset from scratch
- Modify 2.5D asset properties
- Modify 2.5D plate properties
- Advanced workflows

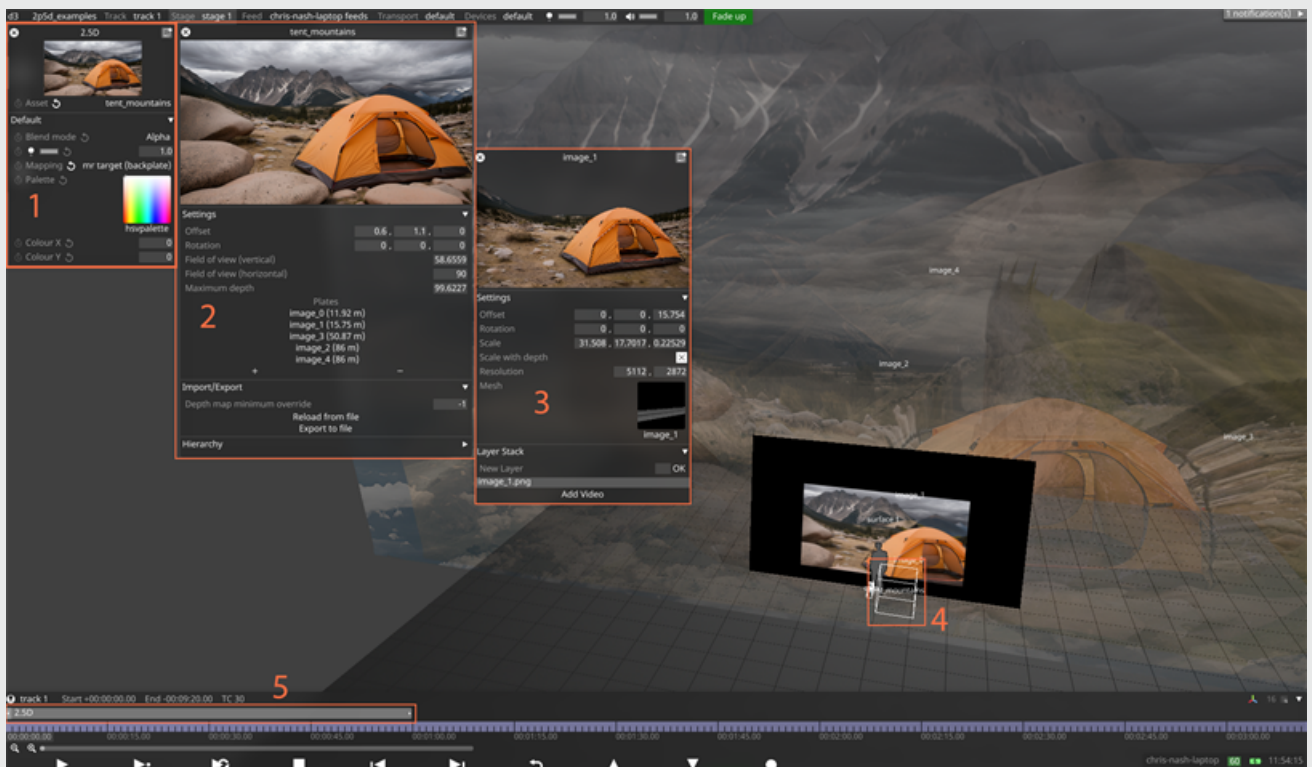

## Key

1. 2.5D Layer editor
2. 2.5D Asset editor
3. 2.5D Plate editor
4. 2.5D Asset origin
5. 2.5D Layer

## Set up a 2.5D asset from an existing .2p5D file

1. Copy the **.2p5d** file to **objects/2p5DFile** in the project folder.
2. Add a 2.5D layer to the timeline.
3. In the **2.5D** layer editor, click on the **Asset** field. The copied 2p5d file should appear in the list of assets in the **2.5DAsset** selector.
4. Click on the asset to select it. It will then load and be visible in the stage.
5. In the 2.5D layer editor **Mapping** property, select the desired 3D mapping e.g. MR set backplate.
6. To reload the asset from file and overwrite any local changes, click **Import/Export > Reload from file** in the property editor of the 2.5D asset.

## Create a new 2.5D asset from scratch

1. Add a 2.5D layer to the timeline.
2. In the 2.5D layer editor, click on the asset field and create a new 2.5D asset.
3. Add a new 2.5D plate to the **plates** field in the 2.5D asset.
4. Under **Layer Stack** in the plate editor, click **Add Video** to add a video or image to the plate.
5. Continue adding plates and modifying their properties until the desired scene composition is achieved.
6. Select the desired 3D mapping in the 2.5D layer, e.g. MR set backplate.
7. To export the asset for use in other projects, click **Export to file** under Import/Export in the 2.5D asset editor. The exported .2p5d file will appear under objects/2p5DFile in the project folder.

## Modify 2.5D asset properties

- The 2.5D asset is an Object which can have its offset and rotation set by changing the values in the editor, or moving the 2.5D Asset origin (white box) in the visualiser. Doing so will move all the plates and change the origin point of the 2.5D scene. It is recommended that the origin is set roughly in the middle of the range of movement of the camera, to achieve the most realistic

looking parallax.

- The **Field of view** and **Maximum depth** fields can be adjusted to scale the total area encompassed by the 2.5D scene. This can be used to ensure that the edges of the plates are not seen when moving the camera within its expected range.
- Plates can be added to or removed from the asset using the **+/-** buttons in the **Plates** field of the asset editor. Plates are ordered by depth, and reordering the plates in the list will update the plates' depth to reflect their new positions.
- The **Import/Export** settings can be used to load or save .2p5d files. When loading files which contain depth maps, the **Depth map minimum override** setting can be used to change the minimum distance from the origin, represented by full white in the depth map.

## Modify 2.5D plate properties

- The plate depth can be changed by modifying the z offset value, or by dragging the plate in the visualiser. If the option **Scale with depth** is ticked, the scale and x/y offsets will automatically be adjusted with depth so that the plate looks the same when viewed from the asset origin. If **Scale with depth** is not ticked, the scale and x/y offsets will not change, so the plate will appear smaller as it moves further away.
- By default, new plates will be scaled to match the total field of view of the asset. However, the scale values can be adjusted in the 2.5D plate editor to change the scale. Similarly, the x and y offsets can be adjusted to move the plate position.
- The plate's mesh can be changed to add depth to a layer and make the parallax effect more realistic. Some .2p5d files will contain depth maps, which will be converted to meshes when importing. To remove the depth from the plate, the standard rectangle mesh can be selected instead.
- The plate **Layer Stack** is used to set up the layers appearing on the plate. To quickly add an image or video to the plate, use the **Add Video** button. Otherwise, layers can be created as normal and stacked to create effects such as blur or colour adjust. Note that these layers can't be keyframed, see **Advanced Workflows** for methods to keyframe layers on plates.

## Advanced workflows

The 2.5D layer and assets are designed to provide a user-friendly way to quickly create 2.5D scenes which are portable between projects. The standard workflow should allow for the majority of use-cases, however more advanced workflows can also be achieved by combining 2.5D assets with other tools in Designer.

- Generally images, videos and effects should be added to plates using the plate **Layer Stack**. However, this does not allow for keyframing within these layers. To keyframe content on plates, layers should be added to the timeline as normal. Content can be mapped to 2.5D plates from the timeline similarly to any other display.
- 2.5D assets and plates are both Objects, so it is possible to animate them from the timeline, or parent assets to other objects which are controlled using tracking data
- The **Stage render layer** which was used for 2.5D workflows prior to r26.3 still functions as it did previously, so it is still possible to use the original workflow if desired.

## Original workflow (available prior to r26.3)

1. Using the stage menu, add an LED surface and a camera to your project.
2. Create 3 projection surfaces and position them behind the LED screen incrementally with a gap of several metres between each.
3. Label each surface in the composition stack to reflect it's location. e.g. "foreground", "midground", and "background".
4. Make the following changes:
  - a. Set foreground and midground surfaces to **Transparent**
  - b. Set the blend mode for the foreground and midground to **Alpha**.
  - c. Change the render layer of each surface to **Backplate (MR)**.
5. Using the stage menu, create an **MRset**.
6. Assign the LED screen to the MRset and change the Camera property to **Camera override**.
7. Add a **StageRender** layer to the timeline above the other content layers and map it to the backplate.
8. Move the camera within the MRset to activate it.
9. The perspective projection will appear on the LED screen and tracks the movement of the camera.

## Further Reading

- [MRset](#)
- [Cuebric Integration](#)

# Cuebric Integration

AI content generation tool.

## Overview

### What is a Cuebric?

Cuebric is an AI-powered creative production studio that provides filmmakers and other content creators with powerful and easy-to-use tools to generate and edit photorealistic, fully segmented, textured, virtual environments in seconds.

### 2.5D versus 3D content on volume stages

For virtual production to work, the content on the volume stage needs to be dimensionalized. For the scene to be credible, the background must also move left with the actor when the actor moves left. The Unreal Engine is used on set by CGI environment designers to render the assets they've already made in real-time. These backgrounds are three-dimensional, just like in a game. Creating realistic, three-dimensional Hollywood-quality backgrounds typically requires an army of CGI artists to work for months.

If 3D is the option that can be fully controlled, then the volume stages also let you film in what is called "two and a half dimensions," which offer less control over movement. Simply put, a 2.5D image is a two-dimensional image with a parallax effect. Cuebric was made so that these 2-D landscapes could be built on set in real-time. It is a quick, cost-effective alternative to labor-intensive 3-D environments and works well with them.

## See How it Works

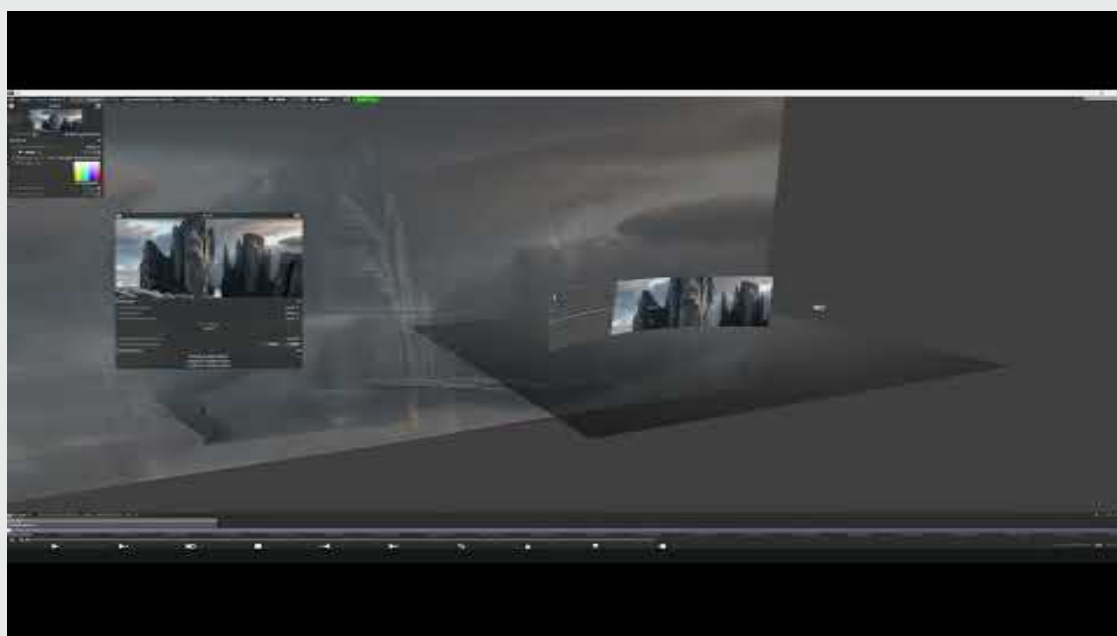
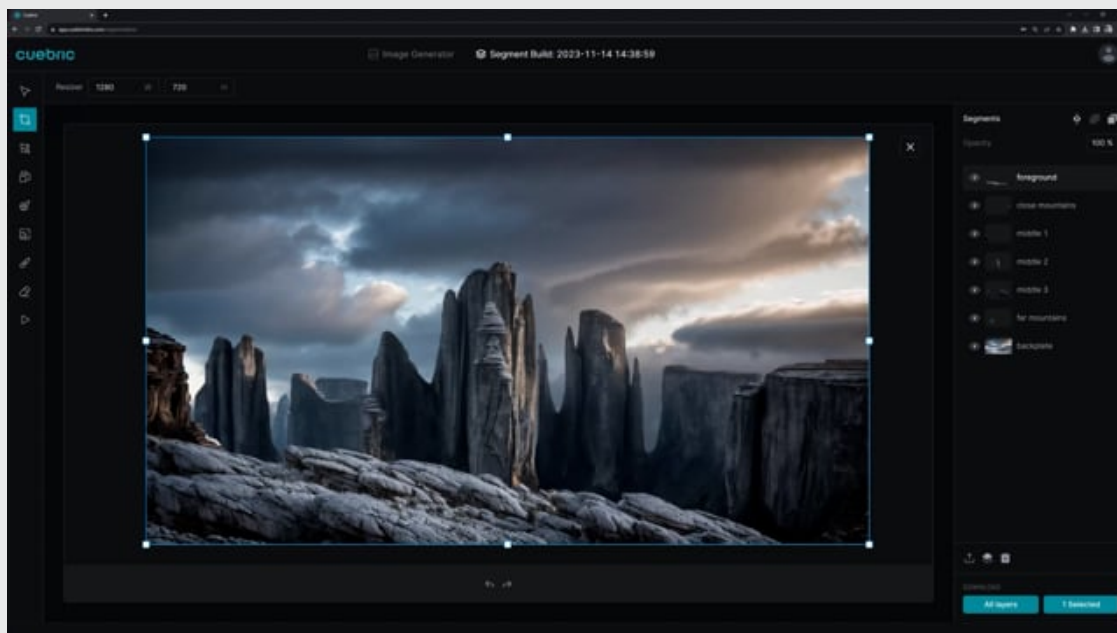

## How does Cuebric work?

Cuebric's Plug & Play 3D solution allows you to rapidly turn your 2D assets into near-3D. Create, segment and dimensionalize scenes in Cuebric, and then seamlessly export them with a single click to Disguise, where your scene's layers are automatically mapped to an LED environment, with the correct Z-depth, ready to shoot.

Cuebric includes a range of editing tools for creators to use in real-time to manifest their immediate idea or vision on a volume stage. Create, segment, and dimensionalize 2.5D scenes without noise or distortion.

Cuebric's AI Depth Package enables creators to Export AI Depth Map and Export Depth Information allowing users to rapidly layer these files as plates in Designer.

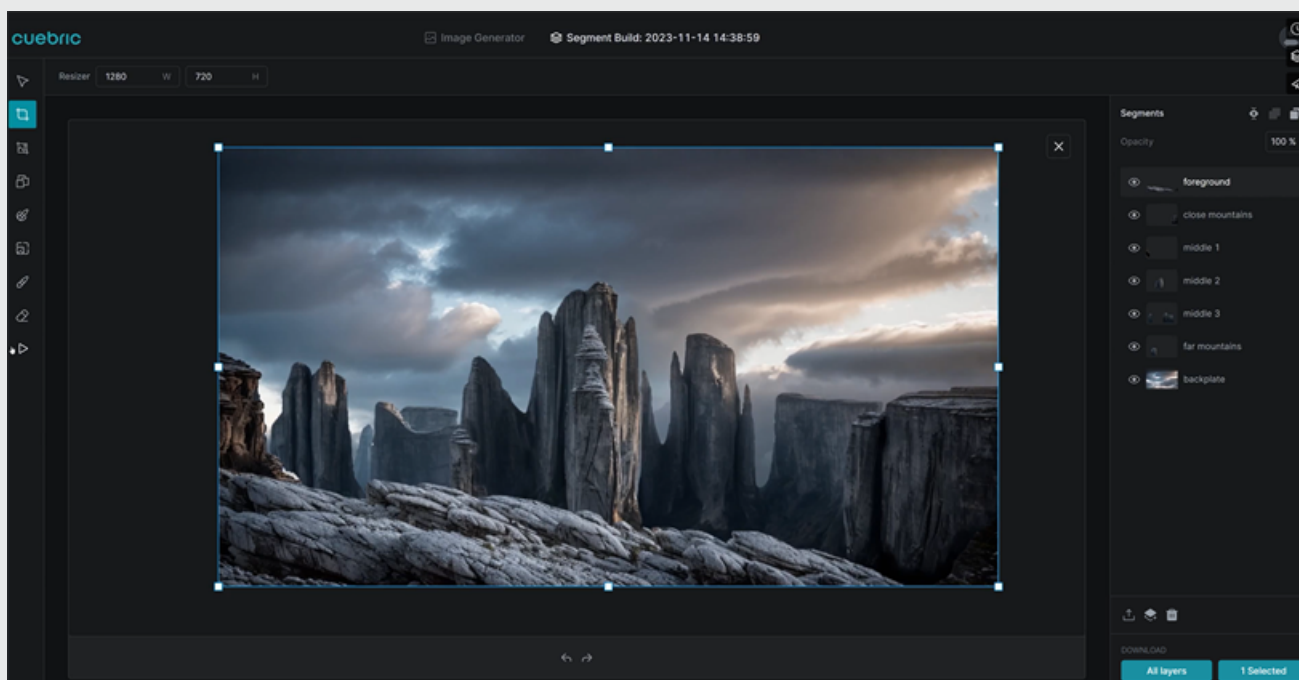

## How can I use Cuebric with Disguise?

1. Sign up for Cuebric [here](#).
2. Create a new project.
3. Create a prompt and generate the image.
4. Adjust the image using Cuebric's tools.
5. Use the segment tool to automatically or manually segment the image.
6. Export the scene has a depth package ready to import in Designer.
7. To set up a 2.5D asset from the Cuebric in Designer, follow the steps on this [page](#).

## Further reading

[Sign up for Cuebric](#)



Cuebric website

# Mesh mapping

Mesh Mapping enables you to easily set up a screen projection that automatically adjusts to the extent of the surface you're targeting.

## Overview

As of r21.4, experience more creative flexibility when mapping 3D content onto your volume.

This type of Mapping is aware of the surfaces that it's mapping toward even when dealing with UV mapped surfaces, screens, and things within your space.

## See how It Works



## Workflow

Mesh mappings are in the same locations as other types of managers, from within a layer's Mapping field. For instance, in this video, the Mesh Mapping has been created from within the RenderStream Layer's Channel Mapping field.

Typical content mapped to surfaces via RenderStream is perspective projected and then cropped off by the geometry within our stage, which is inefficient. Mesh Mapping allows us to create a perspective render from an eye point that you define so that only the pixels that are relevant to that particular mesh are streamed across RenderStream.

When using a mesh mapping, the content being delivered from the render engine will be rendered from the perspective of the eyepoint that you determine in the mesh mapping before it's delivered to the target surface within Disguise software. This is very efficient from a bandwidth perspective as RenderStream only sends the exact pixels that the screen needs.

Increasing the pool size also allows the mesh to be subdivided into multiple perspectives that will line up to create a single contiguous scene.

Mesh mappings also support rendering to surfaces greater than 180 degrees. When the cluster assigner's channel mapping targets the Mesh mapping, Disguise software will determine that it needs more render instances based on available bandwidth and resolutions within the individual fragments, subdividing until it reaches the appropriate amount of fragments to match the screen resolution.

Resolution Scale is another feature available when using a mesh mapping. It allows you to reduce the scale of your content in order to decrease the number of fragments that your mesh mapping needs to provide full coverage around the volume.

To use a mesh mapping within a Cluster Workload for an in-frustum and out-frustum setup:

- Setup a single channel within your Cluster Workload that is targeting **MR set (backplate)**
- Create another channel that targets a mesh mapping. For a pool size of 2, this will generate 2 streams for the mesh when RenderStream is started.
- Be sure to use the same scene origin object in both so that they have the same reference point.
- Start the RenderStream workload. You will see 3 total streams across the RenderStream network as it receives the renders for both in-frustum and out-frustum.

**Please note:** It is recommended to avoid putting the mesh and the eyepoint in the same spot to avoid a frustum with an infinite FOV. If you want to reproduce the view on the origin 0,0,0, you may either place the mesh offset a bit within the disguise stage or offset the eyepoint and use scene origin to 're-align' the offset.

# Shot Recorder

The shot recording system allows users to record and export parameters from within Disguise software, ready for use in post-production workflows.

## What is the Shot Recording System?

The shot recording system is designed as a generic system to allow users to record any fields or properties displayed in the GUI. Users can build up their own collections of parameters they want to record. In addition, the system has a quick and easy workflow for recording commonly-used sets of parameters, such as camera tracking.

Unlike device recordings, which are played back within Disguise software, the data recorded by the ShotRecorder Device can be used by external applications.

## See How it Works



## Components of the Shot Recorder

The main components of the ShotRecorder Device are:

- The ParameterCollection containing the parameters to be recorded.
- A TimecodeTransport used to assign timestamps to the recorded parameters.
- Recording and export settings.

## Parameter Collection

ParameterCollection is a resource that allows users to create several different collections and switch between them when deciding which parameters to record. It contains an array of ParameterSources, each of which is one 'parameter', e.g. field/property to record.

ParameterCollections can also contain a list of nested ParameterCollections, allowing users to build up collections in a modular way and add them all to one outer collection which is used for recording.

Some ParameterCollections are auto-created with sets of parameters which are commonly required. For example, each Camera auto-creates a 'tracking' collection containing all the parameters commonly required for recreating camera tracking data. Similarly, each SpatialMap also creates a similar tracking ParameterCollection - the main difference is that this accounts for offsets of the world zero point in the spatial map. It also references the currently active camera if using an MR set.

ParameterSources contain a list of field ParameterSources for compound types (e.g. Vec contains x, y, and z, Resource can contain its fields). For compound types, the value of the ParameterSource is found by populating the values of its fields. By contrast, the values for basic types are populated using the expression system, which can return floats or strings. Any limitations of the expression system, or particular fields which cannot be accessed by expressions, will also be limitations of the shot recording system.

## Setting up the shot recording system

1. Create a ShotRecorder Device in the current Device Manager. This device will become the master of the shot recording system.
2. Name the Slate for the current shot.

3. Create a new ParameterCollection in the 'Parameters' field and add the desired parameters. ParameterCollections are a collection of different parameters that we are interested in recording and getting the data out of i.e. camera tracking, MR set etc.
4. Add the desired Timecode provide to the 'Timecode' field
5. The 'Take Snapshot' and 'Take Screenshot' options can be selected to take a project snapshot and/or screenshot at the end of each take

## To add parameters to a ParameterCollection for recording:

1. Open the ParameterCollection editor
2. Alt+drag from the Sources '+' button to any field in the UI to add it as a parameter source
3. Several ParameterCollections are automatically created for convenience, such as camera tracking collections. These, or other user-created ParameterCollections, can be added to the ParameterCollections list in the editor to allow the parameters to be organised into smaller separate collections.
4. Click the arrow on the right hand side of a parameter to expand it and view its fields. Resource parameters do not have their fields added by default, but they can be added by clicking the plus button on the right hand side of the parameter.
5. Timecode can be set up inside the shot recorder in order to reference timecode in the recordings using TimeCodeTransport

## To make a recording:

1. To start a recording, click the button displaying 'Disengaged' to engage the recorder and start recording.
2. Click the same button again to stop the recording. The take number will automatically increment, or it can be changed manually.
3. Alternatively, use the API commands documented at <http://localhost/docs/v1/index.html> to start and stop recordings externally
4. Slates will be listed under the 'Recordings' separator. Right click on a slate to see the takes for that slate.

## To export recordings:

1. Select the desired formats under the 'Export' tab
2. Either click 'Export all recordings', or export recordings individually under the 'Recordings' tab
3. Select 'Auto-export' to automatically export in the selected formats when each take is finished
4. Click 'Export comparison table' to export a CSV table comparing the first value of each parameter for each recording
5. You can also enable to take a snapshot or a screenshot of each recording if desired

## Recordings can currently be exported in the following formats:

- **JSON:** A compact JSON representation which contains the changed parameter values for each timestamp, similar to the .shot file
- **CSV (Compact):** A compact CSV representation which contains only the changed parameter values for each timestamp
- **CSV (Dense):** A dense CSV representation which contains all values for each parameter at each timestamp
- **FBX:** An FBX file containing meshes and pose information (position, rotation, scale etc.) of all recorded objects, where available. Any additional properties not represented within the FBX specification are recorded as custom properties.

A new sub-folder will be created in the project called 'output'. Within there we have 'shots' and in there will be the slate. In the slate, there will be the .shot recording in addition to the recording in the chosen format

## Limitations

- The shot recording system only writes data out of Disguise software. There is no capability to read recordings back into Disguise directly to replay the data. This is what device recordings should be used for.
- The shot recording system and the device recording systems do not interact with each other. They can still both be used at the same time.

— There is not currently an easy way to get all the recorded camera tracking data into Unreal Engine to re-render shots. Epic have outlined a workflow [here](#) to import and export FBX files which allows camera positions, rotations and FoV to be imported.



# xR Workflow Overview

This workflow guide is intended to give users an end to end example of how to get up & running with the Disguise xR workflow.

The Disguise xR workflow consists of the following key topics:

1. [xR project setup](#)
2. [Video receive delay](#)
3. [Taking observations](#)
4. [Spatial Calibration](#)
5. [Spatial Tracker delay](#)
6. [Colour Calibration](#)
7. [Managing set extension](#)
8. [Virtual Cameras](#)
9. [Camera switching](#)
10. [Cluster Rendering](#)

# Camera switching

While there can only be one target camera in an MR set at any given time, an MR Set can contain multiple cameras that can be switched between using an Indirection Controller.

## Overview

The target camera of an MR set determines the video input being routed to the MR set. However, multiple cameras can be added into an MR set.

Camera switching in xR requires all delays in the system to be compensated for perfectly, so that all parts of the output switch view in the same frame. This requires introducing a delay between the user requesting a switch, and the switch being visible in the output.

**Please note:** Delays must be perfect to then get in sync switching

## Controller Type

Inside disguise Controller we have 6 Indirection Controller Types:

- DMXIndirectionController
- ListIndirectionController
- MachineListIndirectionController
- ManualIndirectionController
- SequencedIndirectionController
- OSCIndirectionController
- UDPIndirectionController

These allow multiple protocols to be used to switch the active camera inside disguise, as well as non-external trigger based.

## Workflow

### DMXIndirectionController

This allows for Cameras to be selected in a Bank and Slot mechanism.

1. Ensure you have set up disguise to receive DMX.
2. Create and assign a DMXIndirectionController to the MR Set.
3. In the Sockpuppet bank editor, a Camera bank list is now made available.
4. Populate banks and slots with Cameras you wish to select.
5. Enter the Universe and channel you wish to select the Camera bank with into the controller.  
The slot is the next channel immediately after the bank, so you must specify 2 channels in your DMX sender.
6. From the DMX sending device, send the appropriate 2 channel identifier to the universe and channel you selected.

### ListIndirectionController

This allows for Cameras to be selected on a 0 Based index

1. Create a ListIndirectionController
2. Add the Cameras as Resource
3. The order of the Cameras as the Index Number.
4. Scroll through the Index to then choose the active camera

# MachineListIndirectionController

This allows for certain machines to only output the perspective of specified cameras. A use case for this is when splitting up Front and Back plate rendering over multiple machines.

1. Create a ManualIndirectionController
2. Select a Camera

# SequencedIndirectionController

This is controlled by keyframes in an IndirectionControl layer. The indirection control module allows indirections to be sequenced on the timeline. One Indirection control module controls one indirection.

To sequence an indirection:

1. Add a SequencedIndirectionController in the controller field of the indirection.
2. Add an IndirectionControl layer to the timeline.
3. Select the controller in the Indirection control module.
4. Add keyframed Resources to the resource property as required.

# OscIndirectionController

This allows you to force a camera to be active over OSC.

1. Create an OSCIndirectionController
2. Create an OSC Device
3. Add the OSC device to the Controller.
4. Remove the \$ sign from the OSC address field.

5. The string to recall the Camera to be active is the camera's name inside disguise. Currently the OSC indirection controller requires you to use the full path of the object you are selecting such as:

path: /d3/indirection/osc

value: objects/camera/cam1.apx

**Please note:**

Confirm that the labels for camera objects and the OSC indirections match and are named using the same format.

## UDPIndirectionController

This allows you to force a camera to be active over UDP.

1. Create UDPIndirectionController
2. Add the number of Resources needed. This will be the number of cameras in the scene.
3. Add a Key to trigger that active camera, and add a resource which would be the Virtual Camera.
4. Add the receive port number from the UDP sender.
5. Send the command to disguise and see the Current Target change. Turn on Verbose Logging to check incoming strings in the console (alt+c).

# Colour calibration

The disguise Colour Calibration function is a tool for aligning how colour is represented across the system.

## Overview

The goal of xR is to create a complete environment that includes real elements and virtual elements.

The disguise colour calibration is a tool for aligning how colour is represented across the system. If the colour between the physical LED panels and the virtual set extension do not match, the illusion of a single, visually-cohesive environment will be broken.

This process is aimed at reconciling the differences across all screens: it will create and apply a LUT file of the LED screens to match with the Set Extension colour. Different products across LED manufacturers will vary slightly in their representation of assigned colours - the disguise colour calibration allows them to come together seamlessly by determining the minute color differences of each LED surface, even between varying LED manufacturers.

## Workflow

**Please note:** For information on white balancing cameras, LED product and lighting ahead of the calibration, please visit the xR Hub of the [disguise community portal](#).

1. Complete spatial and delay calibration in full.
2. Bring all lighting, LED and cameras to optimal settings and clear the stage of any physical items
3. Fill the camera frame with LED pixels.
4. Open the MR set.
5. Enter the Colour calibration menu.
6. Ensure the correct MR set to be calibrated have populated in the Settings tab.
7. Expand the Pre-Calibration tab.

The Video receive delay should be autopopulated from the Delay calibration. The camera will be automatically taken from the active camera of the MR set. For multicam setups, include all cameras to be calibrated.

8. Hit capture.
9. Step up incrementally in the Frames per test field until the colours in the preview read and saturated true representations of each colour. This ensures that all steps of each colour range are correctly captured by the camera.
10. Expand the Calibration tab.
11. Hit 'Run' to start the calibration. Ensure the camera does not move and lighting levels do not change.

Once complete, a mapping will be created for each combination of camera/LED screen/LUT file as determined by the elements included in the MR set object.

12. Expand the Calibrated LUTS tab to toggle on and off each LUT if needed.
13. Increase the value of the Screen Fill Factor if lighting from each LED is spilling onto the edges of the floor and affecting the calibration result. When the value is set to 1, the colour output will fill 100% of the screen.

**Please note:** Each physical camera will require its own colour calibration, the LUTs are switched automatically by the indirection controller when it switches cameras.

**Please note:** If the capture operation mode is set to "Write", thumbnails of each colour calibration step will be written to the debug captures folder within your project. This can be useful for sending to the support team to reproduce any issues you may encounter.

**Please note:** For further colour adjustment to the set extension, a Colour Adjust layer can be created and assigned a CamPlate Mapping set to backplate with all cameras used for the MR transmission added as the mapping objects.

# Properties

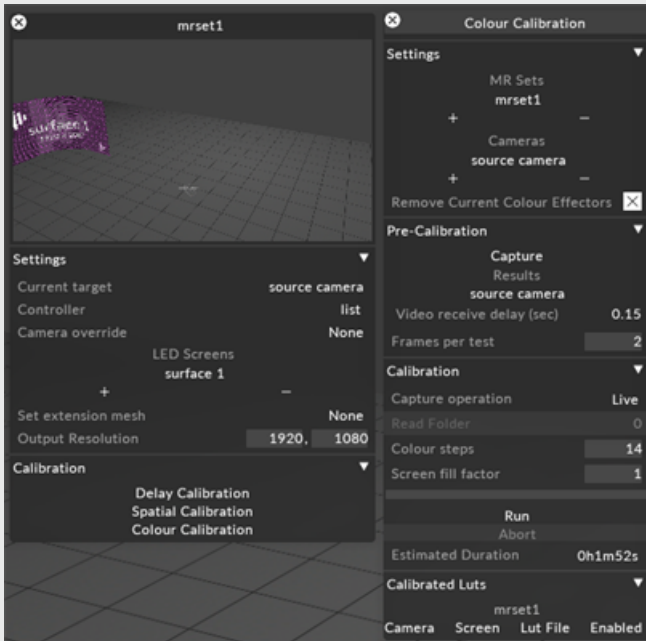

## Settings

MR sets: The MR set to be calibrated. One should be selected.

Cameras: The cameras to be calibrated. All to be calibrated should be selected.

Remove Current Colour Effectors: Will remove all applied LUTs and software colour adjustments from camera objects.

## Pre-Calibration

Capture: Clicking will capture the set number of frames on output.

Video Receive Delay (sec): The delay value of the incoming video frame that is determined in the Delay calibration process.

Frames per test: The user defined number of frames to be captured for each displayed colour value.

## Calibration

Capture operation: Determines if the captured images during testing are archived to the **debug** folder of the Windows project file structure, or captured and assessed Live.

Colour steps: The range of values each colour will be captured at. The larger the number, the more tonal values of each colour assessed. Thus, the longer the calibration. A known good value is 14 but for testing, a low value can be used for a faster calibration result. For newly constructed stages it is recommended to experiment with multiple step values.



Screen fill factor: The area of the screen that is displaying colour. A value of 1 is 100% fill.

Calibrated LUTs: This tab will show all created LUT files for each camera/screen pair and can be toggled on and off using the Enabled button.

# Observations

## Overview

An observation is a set of images of the stage captured by the camera of white dots on a black background (called structured light.) The number of dots and their size/spacing is determined by the user.

Observations are used as data points within the spatial calibrator, which is the predefined algorithm disguise will use to align the tracked camera with the stage and set up the lens characteristics.

Observations are split between **primary** and **secondary**. Primary observations let disguise determine the position of the camera and the position of the screens which make up the MR Set. We also determine the lens characteristics in that primary configuration.

Secondary observations contribute to disguise's understanding of variable zoom and focus settings on the camera lens.

Adding observations is a cumulative process, and each "primary" observation will equally affect the overall calibration results. This can mean that one bad observation will spoil the lot, but that is something we want to hear about to fix it. It is critical to review each observation after it has been taken to determine if it will improve or worsen the overall primary calibration.

## Workflow

1. Check camera tracking data
2. Set your first camera position
3. Select the target camera you wish to calibrate
4. Select spatial calibration
5. Use live blob preview
6. Set your first zoom position

7. Focus the camera
8. Lock zoom & focus values (optional)
9. Set adjust screen position to on or off in the calibration widget
10. Add your first observation
11. Troubleshoot any issues with the observation
12. Delete observations (if necessary)
13. Reset observations (if necessary)
14. Add more observations from new positions
15. Repeat process for secondary observations
16. Test zoom interpolations

## Example

# Check camera tracking data

1. Check that the camera tracking system can see its location dots, and that it is outputting good data.
2. Check that zoom and focus encoder information is reaching disguise. Wiggle the encoders on the camera and see the change in the automation monitor.
3. Check that you are receiving the correct movement in each axis: move the camera along the x y and z axes and pan, tilt and roll (where possible) making sure that the movement of the virtual camera in Disguise software matches the real world movement.

# Set your first camera position

1. Choose where you want to take your first observation from on the floor. Pick a position and lock the camera off.

Try to remove as much negative space from the frame and fill the monitor with as much of the LED as possible.

2. Select The Target Camera You Want To Calibrate
3. Select Spatial Calibration in the MR set.
4. Use the Live Blob Preview tool to visually ensure the blobs are on the stage.
5. Set your first zoom position by zooming the camera out to the first level of zoom you need.
6. Focus the camera.
7. Set whether the calibration should set both the camera and LED screen positions (on by default), or just camera position (off by default). This can be done in the calibration editor.

For stages that comprise of multiple screens, the screen at the top of the list in the mr set will be the main screen, and will remain unchanged while the other screens and cameras move around it. If you monitor the MR Set on your monitor, you should see the virtual line up layer pop into place and align with the test pattern the LED is outputting.

You may see the edges of the screen looking distorted, this is due to lens distortion. You can add overscan in the camera widget to see 100 % of the virtual line up layer alignment with the test pattern.

8. Click **Add Observation**.

Disguise software will display a blob pattern on stage and capture the blobs as they appear. When the observation is finished, it will appear in the observation list.

# Add more observations from the first position

As you add more observations they will appear in the observation list; disguise automatically calibrates all the observation in a list.

- For A/B testing the effect an observation has on a calibration you can mute or delete observations from the observation list.
- After taking your first observation then take additional observation from that same location pointing the camera at different places on the set.
- Try panning left, right and tracking up, down to cover all the pixels you will use in your show.

# Add more observations from new positions

- Now move your camera to other positions and start at 0 level of zoom and 0 focus, try to cover all the pixels from other angles.
- Monitor your MR Set Output notice when the virtual line up layer appears out of place, take observations at these points.

# Secondary observations

- With our primary observation calibrated, we now want to repeat the above steps at the next zoom and focus level you require for your show.
- Disguise will calculate the interpolation between zoom and focus levels automatically.
- Repeat these step for as many zoom and focus level you require.
- Check after each observation that the zoom and focus values match those of other observations taken at the same zoom / focus level. If they do not, edit the zoom / focus value to match.

**Please note:** A common issue is lens encoder jitter. This means that while optically nothing has changed in the lens, the encoders may have 'jittered' very slightly, giving a marginally different value. This different encoder value will result in another pose, despite the lens not having changed zoom or focus. This can adversely affect camera registration.

## Testing zoom interpolations

To test if Disguise software is interpolating between different zoom positions, zoom in and out on the camera and watch the MR Set. If Disguise software is interpolating correctly, the virtual line up layer should zoom in with the camera and stick to the test pattern on the stage

## Troubleshooting an observation

Understanding why an observation is bad can be achieved with the observation debugger.

The Current Observation parameter allows you to cycle through the captured observations. Different colour squares are overlaid on the blobs which help Disguise software differentiate which screen the blob was seen on.

You can rectify what blobs Disguise software is able to see by increasing or decreasing the dot size and grid spacing parameters in your spatial calibration settings.

Users can change the **Tracker Distortion Compensation** to **Matrix**. This will attempt to resolve the calibration using another method.

## Deleting an observation

Deleting an observation will remove it from the observation list.

To delete an observation:

1. Left click the trash icon next to the observation to delete it.

# Resetting all observations

It is possible to reset all observations, rather than deleting them one by one. **Reset all Observations** will completely reset the spatial calibration of the camera. Confirmation is required when clicking this button.

## Properties

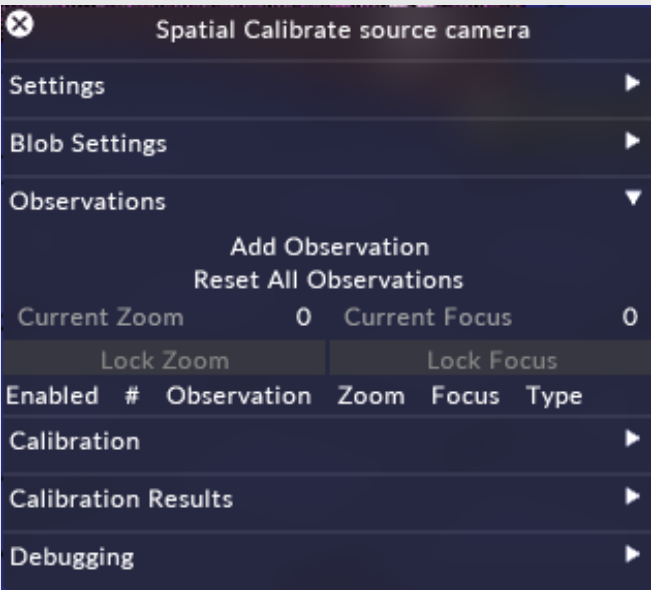

For additional tips for taking observations, please visit the xR hub on the [disguise community](#)

# Set extension

## Overview

A set extension is a virtual extension of the digital content being displayed on the LED screens in the MR set. It is used to fill the in-camera space surrounding the LED screens.

## Workflow

1. Configure set extension mask
2. Configure set extension addition
3. Configure set extension feather
4. Configure set extension mesh

## Example

### Set extension mask

For using objects in the visualiser to mask to areas of the set extension, perform the following steps:



1. [Add an LED screen](#) to the stage
2. Set this LED screen render target to **Set extension mask**
3. Define the screen's mesh to whatever masking shape you want
4. Add this screen to the [MR set](#)

This screen will mask the set extension, leaving only live video and AR effects

## Set extension addition

This functionality allows objects on the stage to mask out live content and show set extension in their place.

1. [Add an LED screen](#) to the stage
2. Set this LED screen render target to **Set extension addition**
3. Set this screen's mesh to whatever masking shape you want
4. Add the LED screen to the [MR set](#)

This screen will mask the live content, set extension is displayed instead

## Set extension feather

To adjust the feather of your set extension, navigate to the target camera and adjust the Set Extension Feather in the settings.

## Set extension mesh

Set extension meshes were added to prevent tearing between the set extension and the LED screens when the camera moves. Content is reprojected based on the position of the camera so as to maintain the correct perspective as the camera travels.

Previously, the reprojection was done using a 2D plane at a reprojection distance that was a best fit for the varying reprojection distances required. Set extension mesh is used to virtually extend the geometry of the LED screens, so that content can be reprojected to the correct planes at the correct distances. Set extension meshes should be extrusions from the outer edges of the screens only.

1. Create the set extension mesh object.
2. Copy it into meshes folder of your project folder.
3. Open your MR set editor.
4. Set the **Set extension mesh** to be the relevant mesh.

## Properties

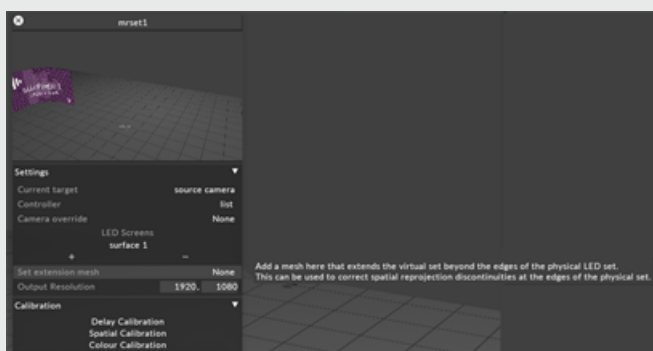

# xR Spatial Calibration

## Overview

This topic covers the basic steps of aligning the physical and virtual worlds within the disguise software, the defining attribute in the xR workflow.

A well calibrated xR stage will reveal no seams or visual artifacts that break the seamless blend between the real and virtual environments, and with adequate preparation, can be fully calibrated in less than a few hours.

Prior to beginning spatial calibration, ensure that:

1. A camera tracking system is set up and receiving reliable data
2. The xR project has been configured with an MR set, accurate OBJ models of the LED screens, and tracked cameras with video inputs assigned.
3. The cameras, LED processors, and all servers are receiving the same genlock signal.
4. The feed outputs have been configured and confirmed working.
5. The Delay Calibration has been completed.

**Please note:** For information on calibration tips & tricks, please visit the xR Hub of the Disguise community portal.

## Concepts

A **Calibration** is a set of data that is contained inside of an individual camera object. The calibration process uses tracking data as a base against structured light patterns to determine the reality in relation to the raw tracking data.

An **observation** is a set of images of the stage captured by the camera of white dots on a black background (called structured light.) The number of dots and their size/spacing is determined by the user.

- **Observations** are used as data points for the predefined algorithm disguise will use to align the tracked camera with the stage and set up the lens characteristics.

There are two types of observations used in the process: **Primary and Secondary (P and S)**.

- **Primary observations** are the positional or spatial observations used to align the real world and virtual cameras. A minimum five Primary observations is required for the solving method to compute, so aim for five good observations when you begin your calibration process. Primary or secondary status is defined by the most common zoom and focus values in the pool of observations.
- **Secondary observations** comprise the zoom and focus data that creates the lens intrinsics file. Each new zoom and focus position will create a new **Lens Pose**.

There is no need to assign a zero point in the disguise software. Minimal offsets and transforms should be applied to align the tracking data and disguise origin point prior to starting the Primary calibration.

Start by taking primary observations at a single locked zoom and focus level. This Primary Calibration will calibrate the offsets between the tracking system and disguise's coordinate system.

- After each observation, the alignment should look good from the current camera position. If the alignment begins to fail, review all observations and remove suboptimal ones.
- The Secondary calibration calibrates the zoom and focus data. This will align the virtual content and the real life camera zoom and focal changes.

A **Lens Pose** is the result of the data captured in the observation process. They are different checkpoints that disguise will intelligently interpolate between. The number of lens poses you will end up with will be dependent on the range of your camera's lens.

- A new lens pose is created for every new combination of zoom and focus values. The most common zoom/focus combination will be the Primary lens pose, attributed to the Primary calibration.

**Please note:** For information on calibration tips & tricks, please visit the xR Hub of the [Disguise community portal](#).

## Workflow

Prior to beginning spatial calibration, ensure that:

- The xR project has been configured with an MR set, accurate OBJ models of the LED screens, and tracking system if being used.
- The cameras, LED processors, and all servers are receiving the same genlock signal.
- The outputs have been configured and confirmed working.
- The Delay Calibration has been completed.

### Virtual Set Preview Setup

1. Create a test pattern layer
2. Assign a Direct mapping to this layer containing all screens that are used within the MR set being calibrated
3. Configure feed output to send content to the LED screen
4. Create a virtual line up layer
5. Assign a Spatial mapping set to Frontplate for this layer.  

This will show the representation of the virtual set and will move/deform during the calibration process.
6. Expand the MR set.
7. Use CTRL+Left Click on the header of the MR set editor to pin the window to the GUI. The preview will show the current active camera view, the AR Virtual Lineup overlay, and the test pattern mapped to the LED screen outputs.
8. For calibration of a range of focus levels, take multiple observations at each zoom level for each of the focus levels. Make sure the zoom is locked for each set of focus observations.

### Primary Calibration

The Primary calibration is the set of observations that define the virtual world's positional and rotational offsets to accurately match the real world, as interpreted by the camera lens.

The Primary observations are defined by the most consistent pair of zoom/focus values within the data set.

1. Open the spatial calibration editor by left clicking spatial calibration from the MR set.
2. Ensure the correct MR set is selected and the camera being calibrated is the current target.

3. Verify the camera tracking system is outputting the correct data and there is no scaling applied from the tracking source.
4. Set the base/most consistent shot for the project. This is called the "hero" shot.
5. Adjust zoom and focus values to their most consistently used levels in show.
6. In the calibration editor, left click Lock Zoom and Lock Focus to fix the current zoom and focus values.
7. All primary observations will be grouped based on the most consistent zoom/focus combination in the list.
8. Use the Live Blob preview to set blob size and spacing proportional to your camera lens and LED resolution.
9. Begin taking primary observations. This will calibrate the offsets between the tracking system and coordinate system within Disguise. Primary observations will be notated in the list with a P indicator.
10. Take a minimum 5 good observations from different camera angles/positions that will be used in show.
11. Utilize the tools under the Debugging tab to determine if an added observation is good or bad.

**Please note:** For more in depth information on how to take quality primary observations, please refer to our advanced guide on the [Disguise community portal](#).

### Secondary Calibration

The Secondary Calibration is a set of checkpoints along the zoom and focus ranges of the camera lens. Each checkpoint is an individual Lens pose comprised of a specific zoom and focus value. Disguise will interpolate between the defined lens poses as the lens zoom and focus values are changed in show.

1. Return to the "hero" or most base camera position.
2. Unlock Focus.
3. Adjust the focus value so it is a new value.
4. Capture a Secondary observation. Secondary observations will be categorized with an S indicator.
5. Repeat steps 3 and 4. Each new observation with a new focus value will create a new Lens pose.

6. Unlock Zoom.
7. Zoom in at a predefined interval, for example 10% in.
8. Lock Zoom.
9. Capture several different observations of varying focus values.
10. Repeat steps 7-9 until 100% zoom has been achieved.
11. Zoom the camera in and out and adjust the focus as needed. View the MR transmission output to see if there are obvious points where the virtual zoom and focus of the stage elements do not match the real world. At those values, add more zoom and focus observations as needed.

**Please note:** For more in depth information on how to take quality primary observations, please refer to our advanced guide on the [Disguise community portal](#).

## Properties

### Settings

The MR set to be calibrated, which will contain:

- All LED surfaces that will display virtual content.
- The indirection controller containing the current camera that is being calibrated.

### Blob Settings

- Adjust the settings of individual observations.
- Adjustments to the size in pixels include:
  - » each blob that will be displayed for that observation.
  - » how many pixels apart they will be.
- The option to exclude specific screens from individual observations.

For example, many stages are calibrated with the floor excluded from the calibration due to the steep viewing angle.

**Please note:** The size and spacing of the dots generally depends on the size of the volume and the lens of the camera, so it often differs between positions based on the camera's distance from the stage. There is no consistent range of values that works for all stages, so it is critical to find time to experiment with large and small dots to compare the results on your system.

## Observations

A list of all observations saved within the camera object's calibration.

The data includes:

- The tracked zoom, focus, positional and rotational data of the camera at the time of the observation capture, as sent by the tracking source assigned to the camera object.
- The categorization of Primary or Secondary.
- A status indicator of if the observation is enabled or currently active within the calibration.
- The list number of each individual observation.

## Calibration

Adjusts global settings regarding the calibration.

Includes:

- Observations image source: Live, Write, and Read.
- Live (default): Images captured in the observation process are stored within the observation object itself and cannot be recovered if the observation is deleted.
- Write: Backs up all captures in the observation process to a newly created folder within the Windows project folder, called /debug.
- Read: Will read captured images to recreate a calibration offline.

## Calibration Results

Provides a list of all lens poses created by differing sets of primary and secondary observations.

## Debugging

- Observation Debugger
- Plot Calibration Errors



- Show 3D Observations

### Tracker Distortion Compensation

This property allows for the potential correction of non-physical errors in the tracking system.

The available settings are:

- **None:** Only accounts for the physical offsets (tracker -> focal point and tracker origin -> Disguise origin) between the tracking system and Disguise. In theory in a perfect setup this should be all you need
- **Single gain:** Allows for a single scaling factor between the tracker and Disguise measurements
- **Gains:** Allows for different scaling factors in X/Y/Z axes
- **Gains and Skews:** Also adds skews, roughly equivalent to the tracker axes not being perpendicular
- **Matrix:** Before this setting was added to the UI, the tracker distortion compensation method was Matrix, which was hard coded in. A byproduct of Matrix is it also allows for more distortions.

## Debugging

There are many contributing factors that may result in a poor spatial calibration. Below is a recommended workflow for troubleshooting the possible causes.

### Primary Calibration

1. Carry out initial checks:
  - Press the 'Re-run calibration' button to ensure the set is in a fully calibrated state. This is especially important when re-opening or updating the project file.
  - Check the primary/secondary observations are labelled as expected. It's possible that a zoom or focus value has changed and caused them to be misinterpreted as the incorrect kind.
  - Check the desired observations are enabled in the list editor.
2. Check whether the 'solved' results look good in the observation debugger. If not, this indicates a problem during the blob detection stage. Possible causes could be:

- Blobs have been detected in the wrong places, e.g. due to reflections. Check in the observation debugger or viewer for any detected blobs that look wrong.
- The camera moved during the observation.
- The stage model is not accurate, or the UVs are incorrect (e.g. pointing the wrong way so the screen is flipped).
- The lens distorts content in a way not captured by our model. For example, anamorphic lenses are not currently supported.
- Feed output mappings are incorrect

**Please note:** Please see our [Disguise community portal](#) for our guide on tips for taking Observations.

3. Check whether the 'tracked' results look good in the observation debugger. If not, this indicates a problem with the tracking system registration. Possible causes could be:
  - The tracking system is not engaged and receiving reliable data
  - The tracking system has physically moved, or something in the setup has changed between observations
  - The tracking system coordinate system is wrong, e.g. flipped axes or incorrect rotation order. Some of the debugging tools may help diagnose this.
  - The tracking system is encoder-based, and physical components are mis-measured or bending.
  - Try changing the solving method of the calibration.
  - If none of the above help, a normal diag with the bad observations in should be enough to look into the issue.
4. If the observation debugger looks good, but Virtual Lineup layer/content looks bad, this indicates that something in tracking or registration is not being applied properly. Possible causes could be:
  - The calibration is not up to date. Press the 'Re-run calibration' button to be sure.
  - The tracking system has physically moved, or something in the setup has changed.

- The camera has moved into a position where it is not well calibrated. Try taking another observation in this position.
  - The zoom/focus has changed.
5. If none of these issues are found, go through the following steps to create a project diagnostic:
- Take an observation which shows this issue (for example, it looks fine in the observation debugger but the Virtual Lineup Layer is not aligned)
  - Leave the camera in the same position that the observation was taken
  - Take a short device recording of the tracking data for the camera
  - Take a screenshot of the camera feed, with the test pattern on the screens but without the Virtual Lineup Layer overlay
  - If possible, take a screenshot of the camera feed with the blob pattern preview displayed on the screens
  - Export a diagnostic of the project, and along with screenshots of the MR set preview, send to [support@disguise.one](mailto:support@disguise.one)

**Please note:** For information on calibration tips & tricks, please visit the xR Hub of the [Disguise community portal](#).

# Spatial Tracker Delay

## Overview

The “Spatial Tracker Delay” field refers to the time difference between Disguise receiving an image from the camera and receiving the associated tracking data from the tracking system for a given frame.

## Workflow

1. Open the MRset properties editor

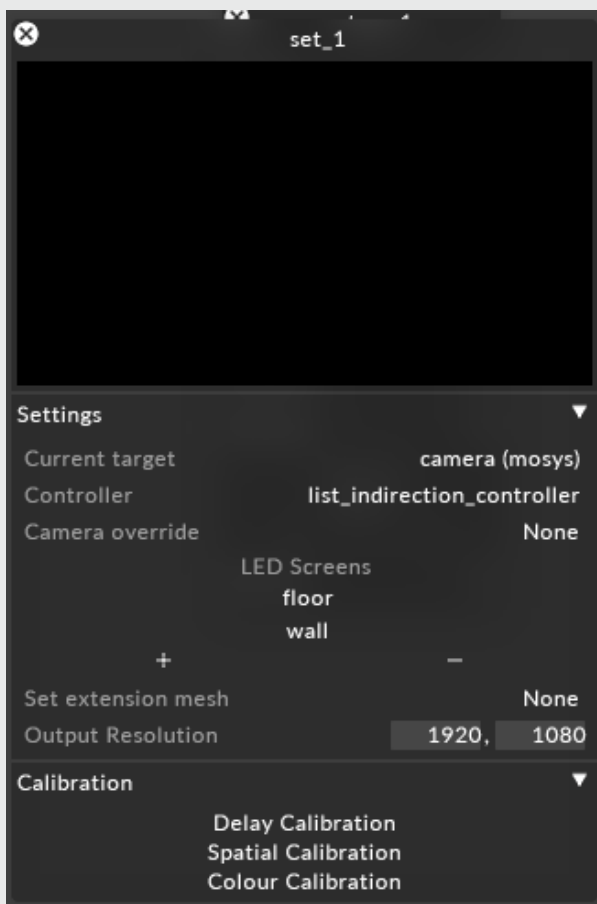

2. Navigate to **Calibration** and left click on **Delay Calibration**
3. Open **Tracker Delay > Settings**

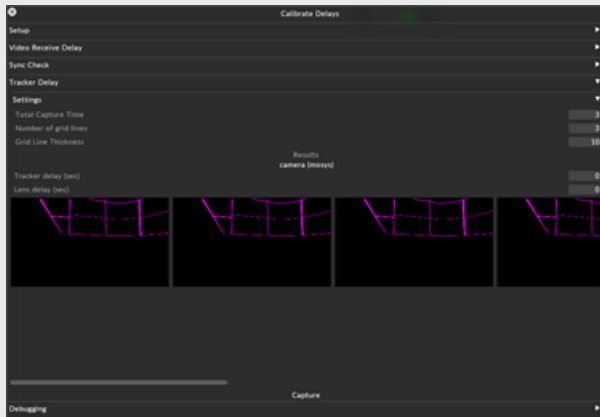

4. Left click on **Capture** while moving the camera along a single axis to capture the camera movement
5. Select the image in which the grids are most closely aligned
6. Adjust the Tracker Delay field as needed to align the remaining grids (this is a subjective decision based on your visual preference)

## Properties

- Total Capture Time: Total time in seconds captured during the tracker delay calibration capture
- Number of Grid Lines: The number of gridlines displayed on the backplate during the tracker delay calibration capture
- Grid Line Thickness: Thickness of lines displayed on backplate during the tracker delay calibration capture
- Tracker delay (sec): Amount of time between receiving a video frame and receiving the corresponding tracking data:
  - If negative, tracker data arrives before the video frame
  - If positive, tracker data arrives after the video frame
- Lens delay (sec) Seconds in between spatial tracking data arriving and lens data arriving.
  - If negative, lens data arrives before the spatial frame
  - If positive, lens data arrives after the spatial frame

**Please note:** Calibrating the Spatial Tracker Delay typically requires a second person to operate the camera while the calibration process is running. For this reason, Lens delay can be useful when performing the Spatial Tracker delay calibration process alone as it allows you to delay the start of the Spatial Tracker Delay calibration capture.

# xR Stage Alignment Overview

## Overview

This topic covers the basic steps of how to align your stage and run calibrations for the xR workflow.

## Workflow

1. Test pattern layer setup
  - a. Add test pattern layer using Direct mapping to LED surface  
Configure feed output to send content to LED screen
2. Virtual lineup layer
  - a. Add a virtual line up layer mapped to the MR set via a spatial mapping set to front plate.
3. Calculate your video delay
  - a. Determine the video receive delay value using the delay calibration editor in the MR set.
  - b. Add MR set and cameras to the delay calibration editor.
  - c. Click **Capture** and once completed select the single white frame from the delay calibration editor, if this does not happen, check the system is correctly Genlocked.
  - d. Test the screens are in sync using the Check sync tool in the delay calibration editor.
4. Configure observations.
  - a. Open the spatial calibration editor by left clicking **spatial calibration** from the MR set.
  - b. Ensure the correct MR set is selected and the camera you're calibrating is the current target.

- c. Verify the camera tracking system is outputting the correct data as you test camera movements.
  - d. Set a real world camera position by moving the physical camera on the stage.
  - e. Ensure the screens you wish to calibrate are included in the observation.
  - f. Use the Live Blob preview to set blob size and spacing proportional to your camera lens and LED resolution.
  - g. Set your base zoom position.
  - h. Focus the camera then lock zoom & focus if desired.
  - i. Add observations. Repeat for multiple angles & positions.
5. Calculate tracking delay
- a. Open **delay calibration editor**
  - b. Expand the tracker delay tab.
  - c. Open the tracking delay tool and click **settings**.
  - d. Left click **Capture** to initiate a capture. This captures a set of frames whilst the camera is moving.
  - e. Move the physical camera along one axis.
  - f. The captured frames are displayed with the captured grid lines and the virtual overlay.
  - g. Adjust delay tracker by selecting the numeric value until the virtual overlay and real content align.

6. Colour calibration

**Please note:** Perform standard colour calibration and balancing setup routines for all LED screens, cameras and lighting as required prior to running the colour calibration process in Disguise software.

- a. Open the MR set.
- b. Expand the calibration tab.



- c. Left click Colour Calibration to open the Colour Calibration editor.
- d. Add cameras to the calibration. It is possible to calibrate a single camera, or multiple cameras together.
- e. Left click **Capture**, in the pre-calibration tab.
- f. Increase frames per test until pure colours are represented in the preview.
- g. In the calibration tab, select the number of colour steps to capture.
- h. Left click run.

# Video receive delay

## Overview

Calibrating delays is an important part of the xR workflow. Failure to complete this configuration correctly will result in the set extension and LED screen output not being in sync.

There are two user calibrated delays in every system that must be determined.

The first is the amount of time between the disguise hardware rendering a frame and receiving the corresponding video frame. This is called the Video Receive Delay.

The second is the time between when the tracking system calculates a camera's position and when it is received and processed by the disguise software. This is called the Tracker Delay.

MR is a game of latency - all components of the system are moving independently, and the preservation of a unified image requires compensating for distortions after an image is taken. These delay values allow disguise to catch up to the camera sensors and tracking sources.

## Workflow

Setting the Video Receive Delay will allow the camera to capture the blobs that are outputting to the screen correctly. If the delay is too high or low, the correct frame will not be captured, which could mean that the structured light pattern is not recognised.

To set the video receive delay:

1. Open the MR set editor.
2. Navigate to the calibration tab
3. Add MR set to the calibrate delay tool
  1. Click Delay Calibration

2. The calibrate delay function is pre-populated with the current camera target, but you can add or remove different combinations of cameras.
4. Click Capture
5. The disguise software will output one frame of white to all outputs assigned to the MR set.
6. Look at the captures:

If the white frame is splitting across two frames, you may need to adjust the phase offset of the LED processors.

If the white frame is fully present in multiple frames, adjust the shutter angle of the camera. This will close the camera shutter faster resulting in only one frame of white to be captured.
7. When a single white frame has been captured, left click the white frame; the delay value will autopopulate in the editor.
8. Test your screens are in sync:

At this point you should check that your screens are in sync with each other; you can use the Sync Check tool found in the calibrate delay widget to accomplish this.
9. Expand the Sync Check tab to ensure that the set extension and LED screens flash at the same frame.
10. Begin Strobe and view on the xR transmission output if the set extension and LED screens seem in or out of sync.

## Properties

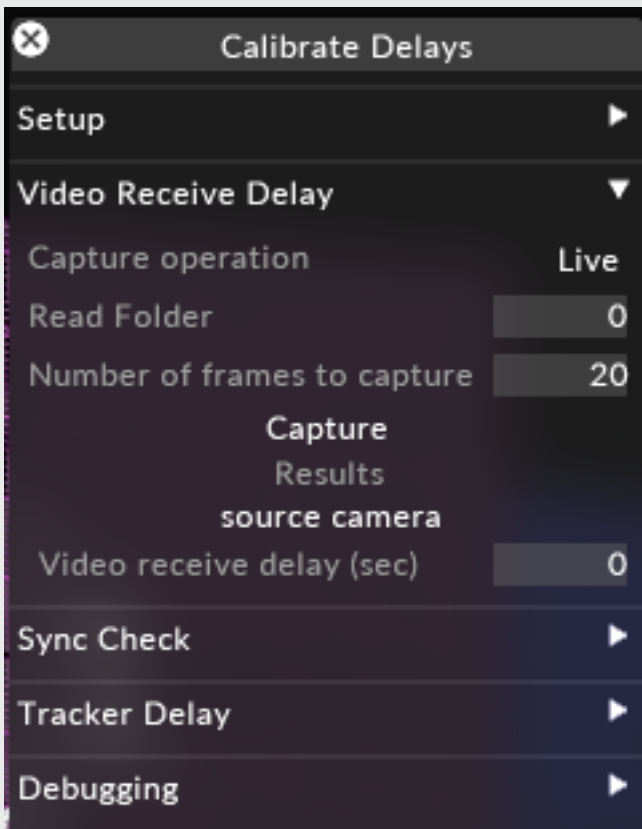

### — Capture Operation

Determines if the captured images during testing are archived to the **debug** folder of the Windows project file structure, or captured and assessed Live.

### — Number of frames to capture

The user defined number of frames to be captured for the capture to be registered.

### — Capture

Clicking will capture the set number of frames on output. Video Receive Delay (sec): The delay value of the incoming video frame that will be autopopulated by clicking on the correct white frame.

### — Sync Check

The tool used to ensure the Video Receive delay value is correct.

# Virtual Zoom

## Overview

Virtual cameras can be used as part of MRset or green screen workflows to allow shots to be captured from positions outside of the range of the physical cameras. By reprojecting the filmed action and virtual content to a new viewpoint, wide shots can be captured for small stages with limited space.

A virtual camera can also be used to traverse a large virtual scene, such as a cityscape. It is possible to start by moving through the streets rendering the virtual scene, and end by transitioning into the view of the real camera on an xR stage, capturing the people on the stage within your virtual scene.

## Requirements for Setup

Virtual cameras are designed to be interchangeable with real cameras as far as possible for a MRset/green screen setup. They should be interacted with in similar ways to a real camera.

- Virtual cameras appear as an object in the stage, similar to a real camera
- They can be linked to a 'parent camera' which is the real camera providing the filmed content from the stage
- When no parent camera is selected, the virtual camera should render virtual content only
- Content can be mapped to the front and back plates of a virtual camera
- Virtual cameras can be used in MR sets in the same way as a real camera
- Users can control the position of a virtual camera in the same ways that are possible for a real camera
- Virtual camera positions can be defined in Global coordinates, or Relative to the parent camera
- Virtual camera positions can be keyframed using `AnimateCameraControl` and `AnimateCameraPreset` layers

## Technical Description

Virtual cameras work by doing a planar reprojection of the filmed content from the real camera to the virtual camera's view:

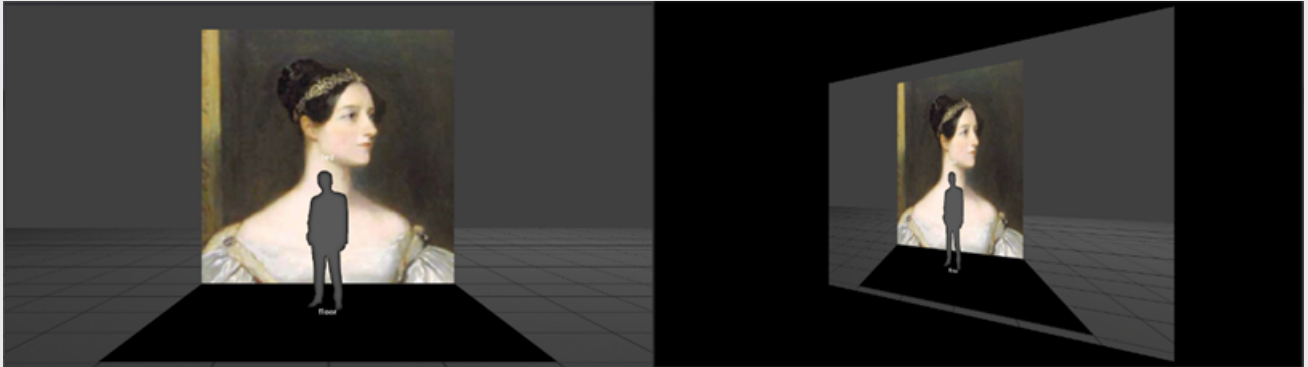

We render the virtual scene from the virtual camera's viewpoint, add set extension to the outsides of the reprojected plane, and account for the reprojection in the content we send to the screens. This gives us the virtual camera viewpoint:

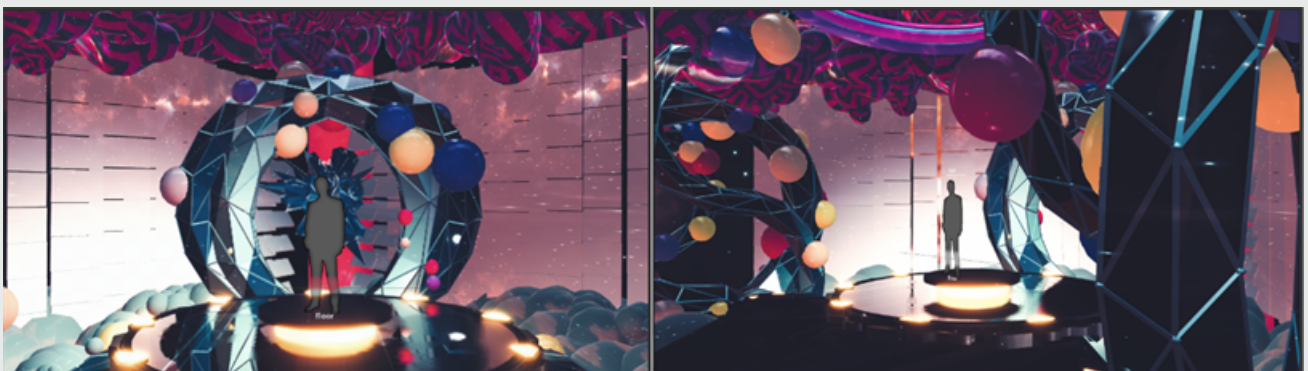
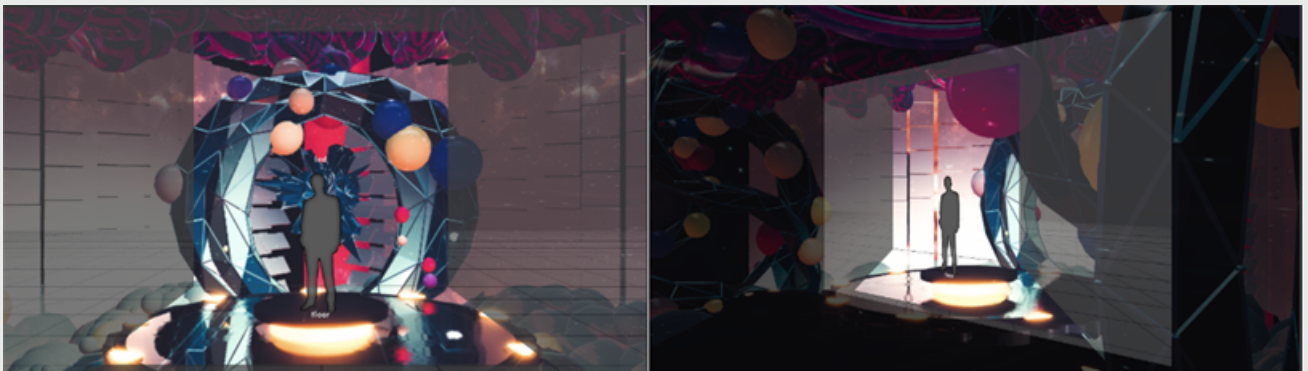

# Reprojection

Note that reprojection is done slightly differently to a real camera. For a real camera, the set extension is reprojected onto the set extension mesh to match the filmed content, to avoid any discontinuities at the boundaries. For a virtual camera, the filmed content is reprojected using a planar reprojection to match the fixed set extension, to ensure the set extension remains stable when the real camera moves. This means that there may be more obvious discontinuities between filmed content and set extension when using a virtual camera and moving its parent camera than when moving a real camera. This effect will be more obvious the more close up the virtual camera's view is, so it is recommended not to move the parent camera quickly when using a virtual camera which is only offset by small amount from its parent.

## Workflow

### To set up a virtual camera

1. Create a new Camera (VirtualCamera) in the Cameras list in the stage
2. Set the 'Parent camera' property to the desired real camera
3. Add a 'Live action position marker' located at the average position of live content on the stage (e.g. people). This will ensure that the live content appears with the correct perspective relative to the virtual content when the virtual camera moves.
4. 'Max zoom in factor' can be set to restrict how much the filmed content can be zoomed into before purely virtual content is displayed. This prevents excessive pixellation when moving the virtual camera towards the live action.
5. Set the lens settings under Physical->Lens. These can be defined locally in the virtual camera, set to follow the zoom of the parent camera (with an optional scaling applied), or set to follow all the intrinsics of the parent camera (with an optional zoom scale).

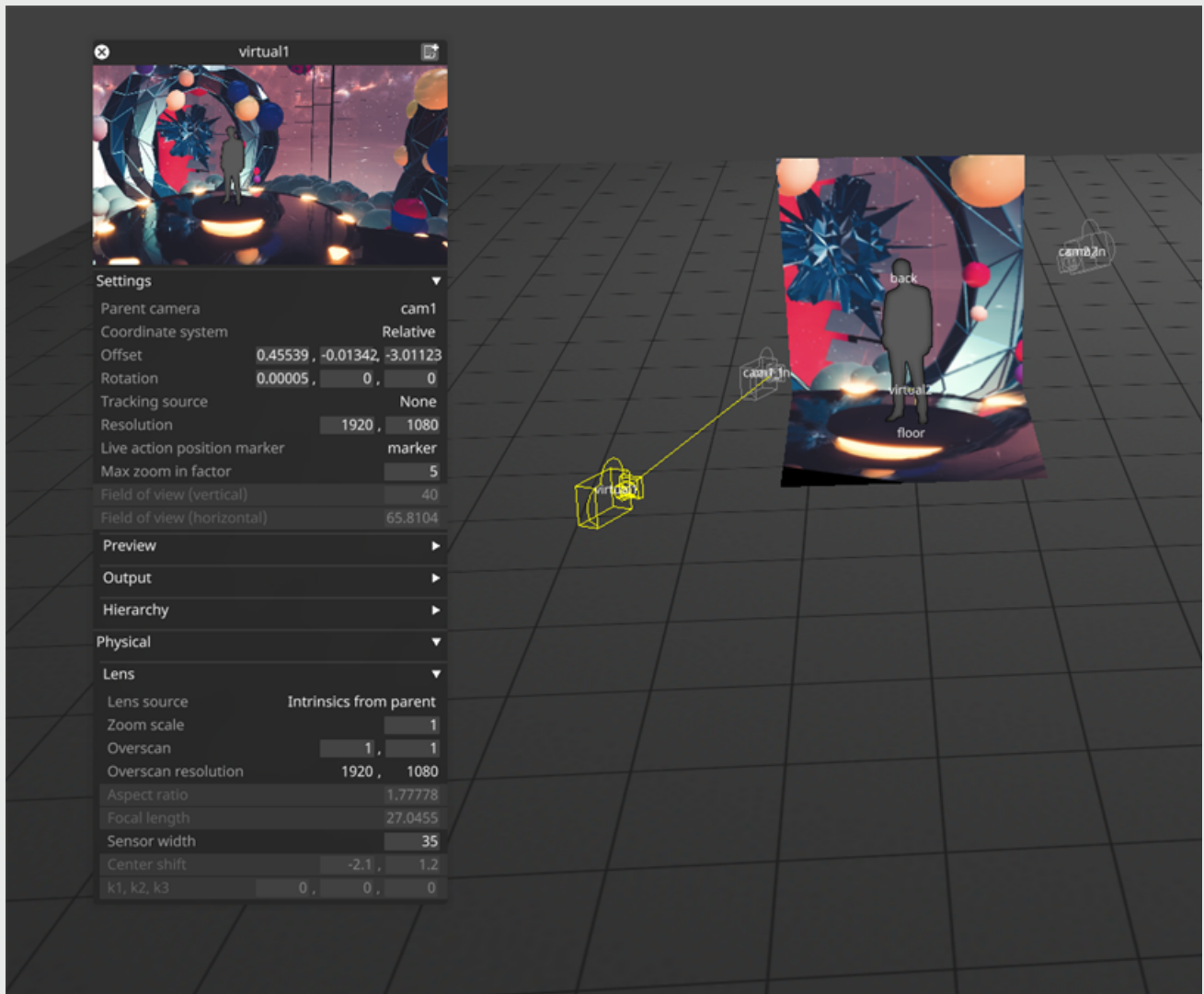

## To control a virtual camera:

There are various ways for controlling the position of the virtual camera. You can either:

- Use the 3D object manipulators to move the VirtualCamera object around in the stage
- Edit the values in the VirtualCamera editor. Note that values can be defined in a Global coordinate system, or Relative to the parent camera.
- Use a tracking source: A tracking source can be used to control the pose and lens intrinsics for a virtual camera in the same way as a real camera.
- Keyframe camera animations using AnimateCameraPreset or AnimateCameraControl

## To keyframe virtual camera animations:

Virtual camera animations can be keyframed similarly to standard cameras using the AnimateCameraControl or AnimateCameraPreset layers.



**AnimateCameraControl:**

1. Add an AnimateCameraControl layer
2. Set the camera to the VirtualCamera you wish to animate
3. Set the coordinate system to Global or Relative as desired
4. Keyframe virtual camera properties. In addition to the standard properties for a normal camera, zoom scale can also be keyframed

**AnimateCameraPreset:**

1. Add an AnimateCameraPreset layer
2. Set the camera to the VirtualCamera you wish to animate
3. Add new VirtualCameraPositions to the Position property
4. Set the coordinate system to Global or Relative as desired
5. In addition to the standard properties for a normal camera, the virtual camera's zoom can be set. Toggle the 'Animate zoom scale' option to choose whether to animate zoom scale or global field of view
6. Keyframe several VirtualCameraPositions to animate the camera between these positions. Positions in Global and Relative coordinates can be mixed, and the camera will move between the coordinate systems.

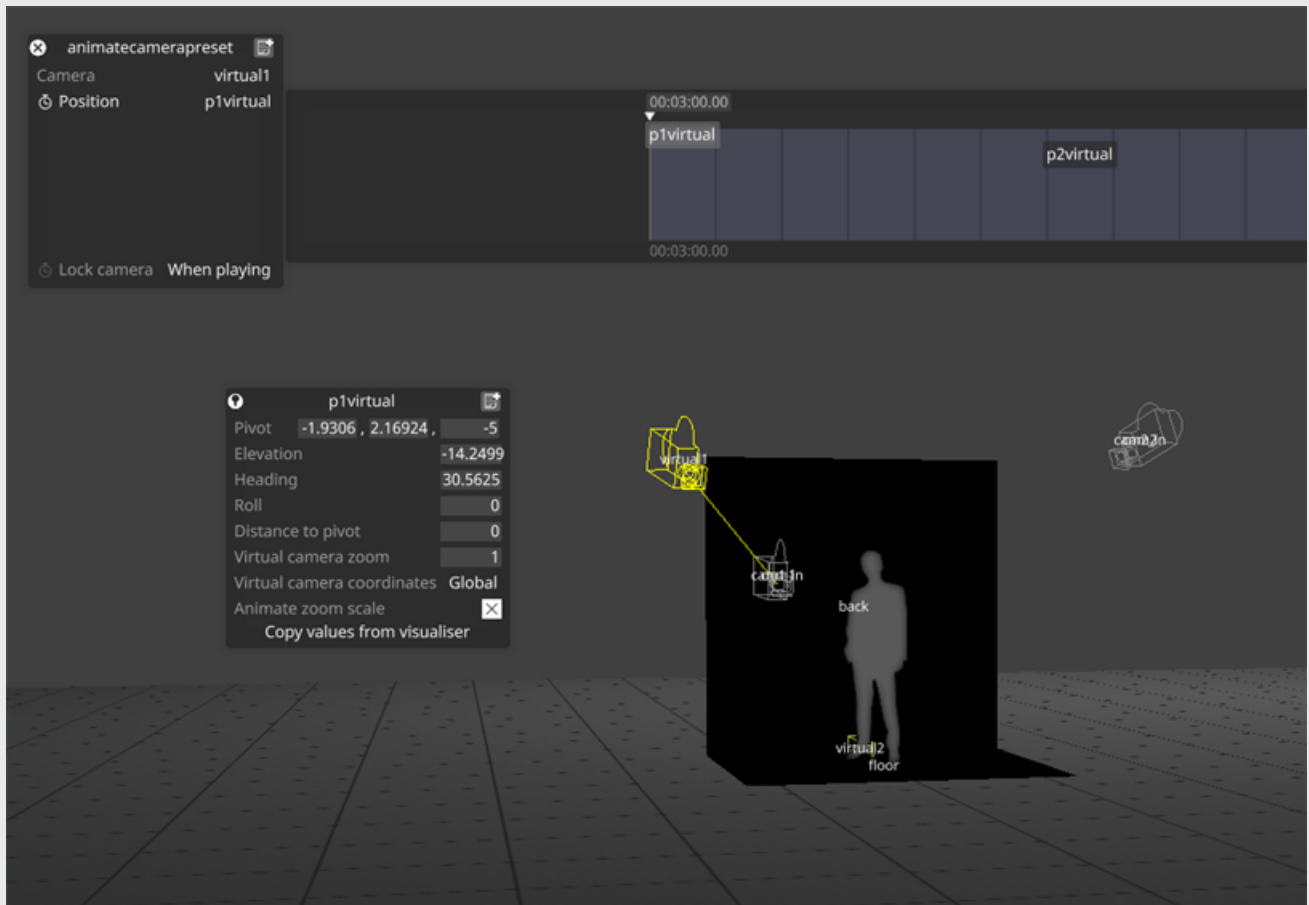

## Limitations

- If the virtual camera is significantly off-axis from the real camera, the live objects (e.g. people) will become skewed. The projection can be thought of as looking at a 2D cardboard cutout from a different angle.
- All live action must be completely within the frame captured by the real camera. If not, it will be cut off during the reprojection.
- If the lens is heavily distorted, there may be distortion artifacts. A radial mask can be set in the editor to remove these effects, which are most pronounced at the edges of the image.
- If you attempt to move the virtual camera forwards towards the live action, the picture will become progressively more pixellated. This is because you are zooming in on the captured image at fixed resolution. This can be mitigated by setting the 'Max zoom in factor'.
- If the virtual camera moves behind the live action, it will render virtual content only.

— If the parent camera moves quickly, there may be some noticeable discontinuity between filmed content and the set extension. This may be more noticeable if the virtual camera is near to the parent camera. For fast camera moves it is recommended to use a real camera rather than a virtual camera.

### **Legacy Workflow**

Virtual camera animations could previously be keyframed using additional options in the `AnimateCameraControl` or `AnimateCameraPreset` layers. The new workflow supercedes this method, however for backwards compatibility the old workflow can be enabled by setting the option switch `enableLegacyVirtualCameraWorkflow`.

# xR Project Setup

This topic will explain the basic principles of setting up a project for use with the xR workflow

## Overview

This topic will explain the basic principles of setting up a project for use with the xR workflow.

## Workflow

1. Create a new disguise project if required.
2. Configure your Director/ Actor setup if required.
3. Create an accurate representation of your LED setup in the stage.
4. Configure your cameras.
5. Configure Genlock
6. Ensure project refresh rate and output refresh rates match.
7. Ensure feed output resolutions are configured
8. Perform a spatial calibration as required.
9. Configure RenderStream content if required.

# xR stage setup

## Overview

This topic covers setting up your virtual stage and cameras in Disguise software for xR calibration of an LED stage.

## Workflow

1. Add LED screens to the stage. For the xR workflow, LIDAR scanned and UV unwrapped OBJ meshes are best.
2. Add virtual cameras to the stage.
3. Connect the video output of the physical stage camera to a video input on the disguise server
4. Check and configure physical camera settings, including white balance, framerate, and genlock status.
5. Patch the video input(s) to the virtual cameras in the stage in the Video Input Patch Editor.
6. Run preview in the video input patch editor to ensure the camera feed is being received at the correct signal.
7. Check & configure camera tracking system.
8. Create a position receiver to link to the camera tracking system.
9. Add tracking drivers dependent on your camera tracking system to the position receiver.
10. Engage the camera tracking drivers.
11. Assign the driver in Disguise software to a virtual camera.
12. Monitor the incoming data from the camera tracking system to ensure it is being received in time.

13. Create an MR set
14. Optionally, add a set extension mesh.
15. Add LED screens to the MR set.
16. Add camera to the MR set if required.
17. If using multiple cameras, configure and test the indirection controller.

# RenderStream

RenderStream is the proprietary disguise protocol for controlling third party render engines from Disguise software.

## Overview

RenderStream allows for the sequencing and sharing of content from a third party render engine to Disguise software, much like how Notch works onboard a gx, albeit running on the rx, our proprietary external render node.

This topic is intended to outline the basic steps involved in configuring RenderStream for use with Unreal Engine, Unity, and Notch. Once the configuration steps explained here are complete, sequencing of the third party render engine can be accomplished via the RenderStream Layer within Disguise software..

## Uncompressed vs. Compressed

RenderStream Uncompressed requires the use of a 25G Mellanox network interface to stream uncompressed, 10bit video data. To test RenderStream Uncompressed appropriately, access to multiple machines and the networking equipment specified is required. Testing RenderStream Uncompressed also requires both a RenderStream Send License and a RenderStream Uncompressed License.

RenderStream Compressed provides consistent content quality with advanced H.265 compression. You can now choose high frequency compression, and ensure that even the finest details of your content are shown via our superior, reliable networking.

# Plugins

In order to communicate with disguise, both Unreal Engine and Unity require the installation of a plugin on the render node. Visit the [disguise Github](#) for the latest plugins.

## Cluster Rendering



**Warning:** For cluster rendering it's recommended to use render nodes from the same disguise product range, e.g. all rx series machines. Mixing of machines from different product ranges is not recommended and is unsupported. It is acceptable to mix rx and rxII types however.

Here are just some of the benefits of using Cluster Rendering:

1. Cluster Rendering allows you to span your render engine content over more than one Disguise server by scaling out real-time content up to an unlimited capacity.
2. Each machine will let you render a fragment of your final content frame to increase the render power and get your content onto your displays at your desired quality.
3. Use Cluster Rendering to render real-time content of the highest quality, detail and framerate without worrying about GPU power.

Cluster Rendering is configured within Disguise software using the [RenderStream Layer](#).



# RenderStream

## Introduction

RenderStream 1.30 brings a host of new features including:

### TouchDesigner Integration

RenderStream 1.30 plugin allows you to bring a real-time 3D scene developed in TouchDesigner into Designer and build it into your final project.

### RenderStream Validation Framework

You can now check an Unreal project for various settings that could potentially impact the RenderStream integration. A check is run every time the scheme is updated, and if any issues appear, a warning will be triggered to the Message Log.

### Vulkan API support

The r22 release also supports the Vulkan cross-platform API. Applications built with Vulkan can now be used as both compressed and uncompressed RenderStream assets.

# RenderStream Resources

RenderStream versions, downloads and release notes.

RenderStream is a protocol for controlling third party render engines from the disguise software.

We recommend that in all instances you use the latest plugin versions which can be found on GitHub.

## Unreal Engine

**GitHub** <https://github.com/disguise-one/RenderStream-UE>

For release notes and full information see GitHub.

## Versions

Unreal Engine 5.3

Plugin	Compatibility
RS UE 5.3 plugin r2.0	Compatible with r25 & higher.

Unreal Engine 5.2

Plugin	Compatibility
RS UE 5.2 plugin r2.0	Compatible with r25 & higher.
RS UE 5.2 plugin r1.30	Compatible with r22 & higher.

Unreal Engine 5.1

---

Plugin	Compatibility
RS UE 5.1 plugin r1.30	Compatible with r22 & higher.

#### Unreal Engine 5

Plugin	Compatibility
RS UE 5 plugin r1.30	Compatible with r22 & higher.
RS UE 5 plugin r1.29	Compatible with r21

#### Unreal Engine 4.27

Plugin	Compatibility
RS UE 4.27 plugin r1.30	Compatible with r22 & higher.
RS UE 4.27 plugin r1.29	Compatible with r21
RS UE 4.27 plugin r1.28	Compatible with r20
RS UE 4.27 plugin r1.27	Compatible with r19

#### Unreal Engine 4.26

Plugin	Compatibility

RS UE 4.26 plugin r1.28	Compatible with r20
RS UE 4.26 plugin r1.27	Compatible with r19
RS UE 4.26 plugin r1.25	Compatible with r18

### Unreal Engine RenderStream Sample projects

Sample projects include:

- RenderStream plugin
- back plate camera (cam\_backPlate)
- front plate camera (cam\_frontPlate)
- an auto-generated .JSON file

Each camera has a **RenderStream Channel Definition component** attached ready to connect to a **RenderStream layer**.

Each project has a rotating disguise logo blueprint added to the scene. A float variable parameter called "logoRotationSpeed" has been exposed to control the rotation speed of the logo via the level blueprint. This demonstrates how an exposed variable is setup in the level blueprint. This exposed parameter is set to editable and so can be controlled directly from the **RenderStream layer** editor.

### Designer r25 and above [RS2.0]

Sample Project	Link
RS UE 5.3	<a href="#">max_UE5_3_rs2-0_24-01-24.zip</a>

- RS2.0 v0 plugin	
RS UE <b>5.2</b>	<a href="#"><u>max_UE5_2_rs2-0_24-01-24.zip</u></a>
- RS2.0 v0 plugin	
RS UE <b>5.1.1</b>	<a href="#"><u>max_UE5_1_Clean_240401.zip</u></a>
- RS2.0 v0 plugin	
RS UE <b>5.0.3</b>	<a href="#"><u>max_UE5_0_rs2-0_24-01-24.zip</u></a>
- RS2.0 v0 plugin	
RS UE <b>4.27</b>	<a href="#"><u>max_UE4_27_Clean_240401.zip</u></a>
- RS2.0 v0 plugin	

**Designer r22 and above [RS1.30]**

<b>Sample Project</b>	<b>Link</b>
- RS1.30 v0 plugin	
RS UE <b>5.2</b>	<a href="#"><u>max_UE5_2_rs1-30_24-01-24.zip</u></a>
- RS1.30 v0 plugin	
RS UE <b>5.1.1</b>	<a href="#"><u>max_UE5_1_rs1-30_24-01-24.zip</u></a>
- RS1.30 v0 plugin	
RS UE <b>5.0.3</b>	<a href="#"><u>max_UE5_0_rs1-30_24-01-24.zip</u></a>

- RS1.30 v0 plugin	
RS UE <b>4.27</b>	<a href="#"><u>max_UE4_27_rs1-30_24-01-24.zip</u></a>
- RS1.30 v0 plugin	

**Designer r21 and below**

Sample Project	Link
RS UE <b>5.0</b>	<a href="#"><u>max_UE5_0_rs1-29_r21_24-01-24.zip</u></a>
- RS1.29 v9 plugin	
RS UE <b>4.27</b>	<a href="#"><u>max_UE4_27_rs1-29_21_24-01-24.zip</u></a>
- RS1.29 v6 plugin	

## Unity

GitHub <https://github.com/disguise-one/RenderStream-Unity>

For release notes and full information see GitHub.

For more information see the [RenderStream and Unity Help page](#)

## Notch

The Notch plugin is bundled with disguise software.

For the Demo Notch Builder Project visit [download.disguise.one/#resources](#)

For more information on RenderStream and Notch integration, visit [RenderStream and Notch](#)

# TouchDesigner

For more information on RenderStream and TouchDesigner integration, visit [RenderStream and TouchDesigner](#)

## RenderStream Integration SDK

The RenderStream Integration SDK is available to those wishing to develop their own integrations.

The GitHub repository is for API definitions, documentation and examples. For more information see the [GitHub RenderStream Integration page](#).

# RenderStream Layer

The RenderStream Layer is used to control third party render engines running externally to Disguise software.

## Overview

The RenderStream Layer is used to sequence remote instances of Notch, Unity, and Unreal Engine.

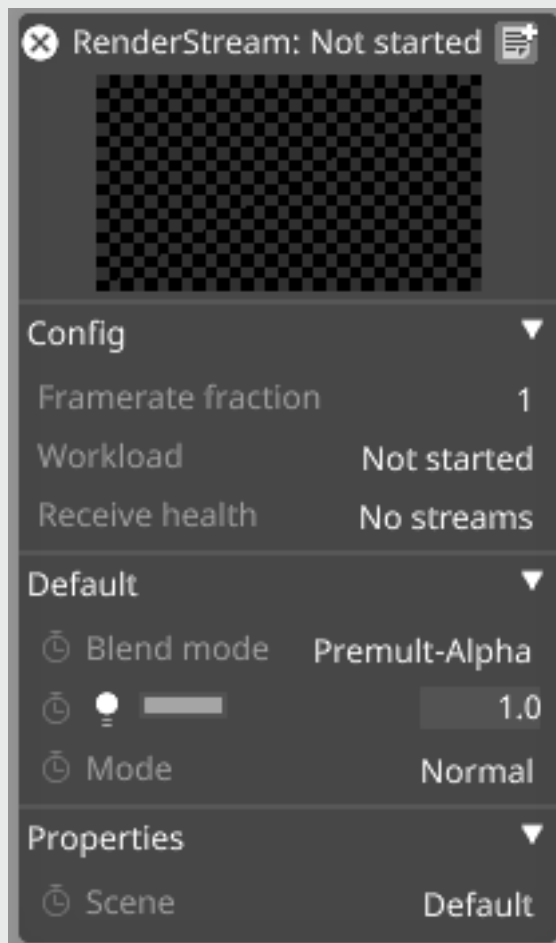

## Layer Properties

There are four main sections within the RenderStream Layer:



- **Media Thumbnail**
- **Config**
- **Default**
- **Properties**

## Media Thumbnail

This area will display an image of the active stream being received. Note that in a multi-channel environment, this will only show the Camera in UE that has the RS component attached to it.



## Config

This section of the RenderStream Layer is where you will configure properties such as **Asset** and **Cluster Pool**, as well as monitor workload and engine health in real time.

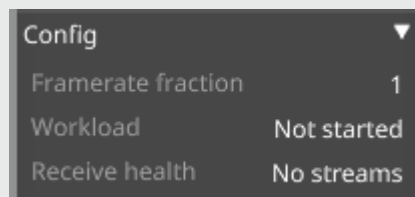

## Framerate Fraction

The framerate of each stream is determined by the global refresh rate set within d3. The Framerate Fraction setting indicates the fraction of the framerate this layer renders at.

The options are 1, 1/2, and 1/3.

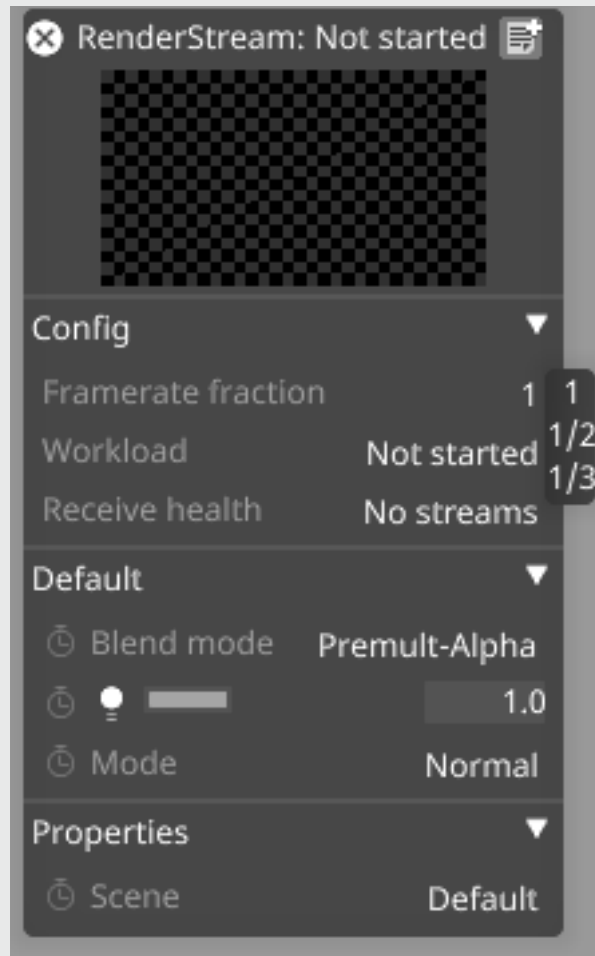

## Cluster Workload

The Cluster Workload window contains the elements required for configuring a RenderStream Cluster.

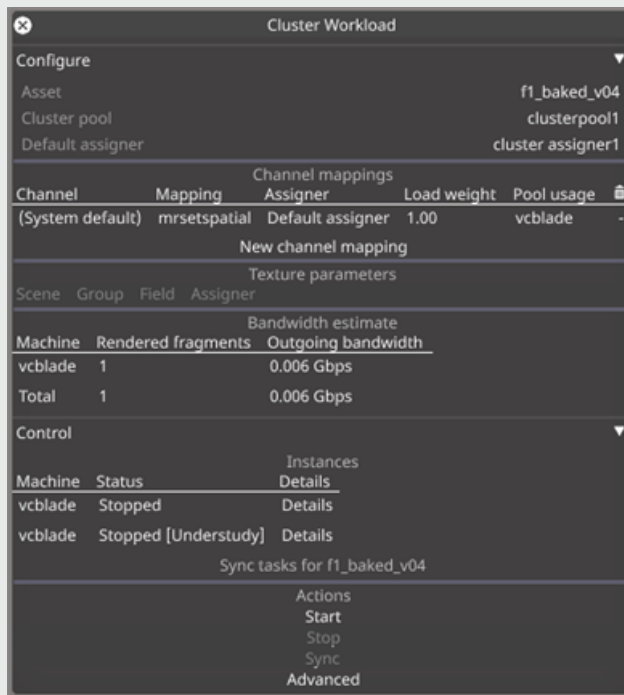

It contains the following sections:

— Configure

- » The Configure section contains these elements of a RenderStream Cluster:
  - » Asset
  - » Cluster Pool
  - » Cluster Assigner
  - » Channel Mapping
  - » Bandwidth Estimate

— Control

# Asset

This is the Render Engine project or Notch block that will be controlled by the layer. In order for the asset to be visible here, it must be present in the RenderStream projects folder.

Right click on the asset name to open the **Asset** properties editor:

**Asset** Properties include:

- **Asset Discovery Name:** (name of UE folder/project)
- **Target Engine:** name of the Render Engine
- **Engine Settings**
- **Colour shift:** apply color correction to entire asset
- **Content Source Machine:** The render node that is running the render engine project. This is the machine that the project will be synced from.
- **Available:** Status indicator displaying if the Asset is available. Not a tick box.
- **Channels:** displays active channels defined by the CameraActors in your UE project

# Cluster Pool

The **Cluster Pool** will automatically detect all available machines on the same network. Once detected, you can assign as many machines to the **Cluster Pool** as needed and inspect each machine in the pool to see network status, IP address, current Streams and available Assets.

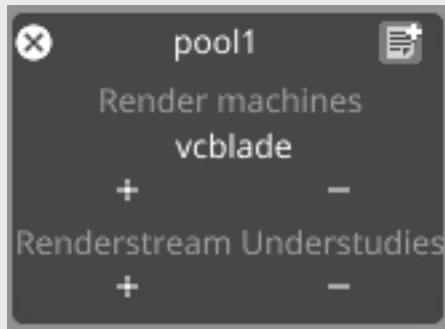

**Cluster Pool** Properties include:

- **Render Machines:** The list of render nodes that the content will be distributed across
- **RenderStream Understudies:** backup nodes in case of failover

**Please note:** Pools should be named as to purpose or the node group assigned. For example, "Cluster" is not as descriptive to its purpose as "Main\_Wall\_Nodes"

## Cluster Pool Machine Properties

Right click on the name of a machine in the **Cluster Pool** to edit additional properties related to that machine:

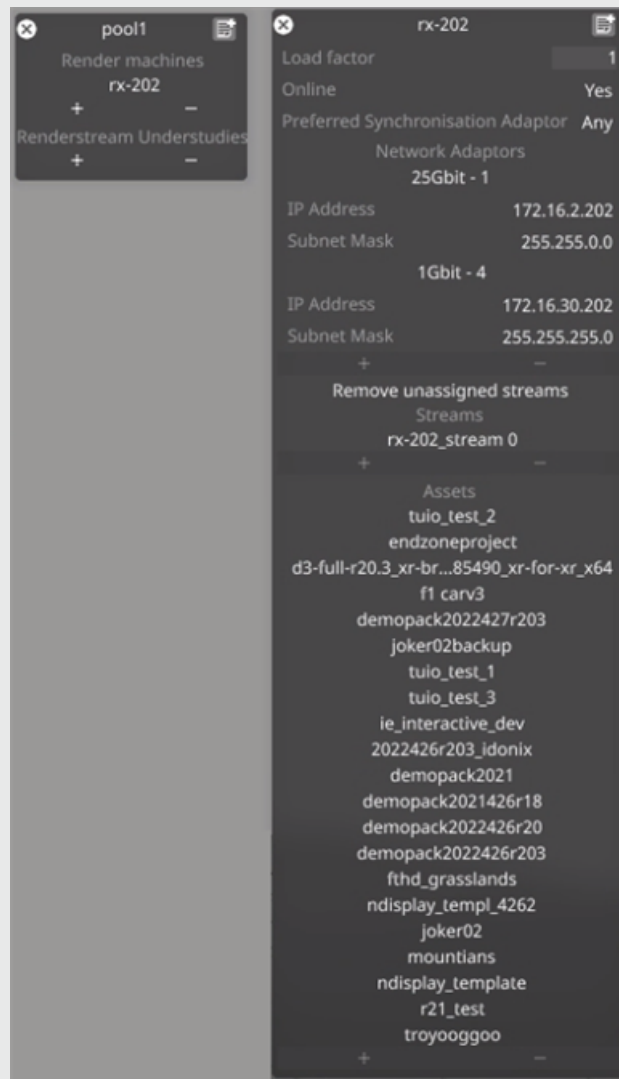

**Machine** properties include:

- **Load Factor:** Relative load weight this machine can handle. Weight is relative to other nodes in pool. The workload can be spread evenly across the cluster by the user using a load factor.

This allows you to take into account each machine's spec and assign loads accordingly.

- **Online status**

- **Preferred Synchronisation Adapter:** This setting allows you to pick a subnet to use for sync. You should pick something fast - preferably capable of 100Gbps or more.

Only used to control cluster communication and content syncing; it has no impact on how the streams are communicated to disguise.

- **Network Adapters and settings:**

Non-editable list of network adapters available on the node.

To configure the system for Cluster Rendering, all machines within a Cluster Pool must be on the same subnet;

If a machine is reporting an unexpected IP address (e.g. loopback address), make sure to select the specific network adapter within the 'Network' tab of d3manager.

- **Streams:** non-editable list of RS output from the node.

- **Assets:** non-editable list of assets resident on the node.

## Cluster Assigner

The **Cluster Assigner** is where we control the settings for the distribution of the content across all the machines in the **Cluster Pool**.

Cluster Assigners are used to create definitions as to how channels are delivered from the nodes. You can create as many Cluster Assigners as needed.

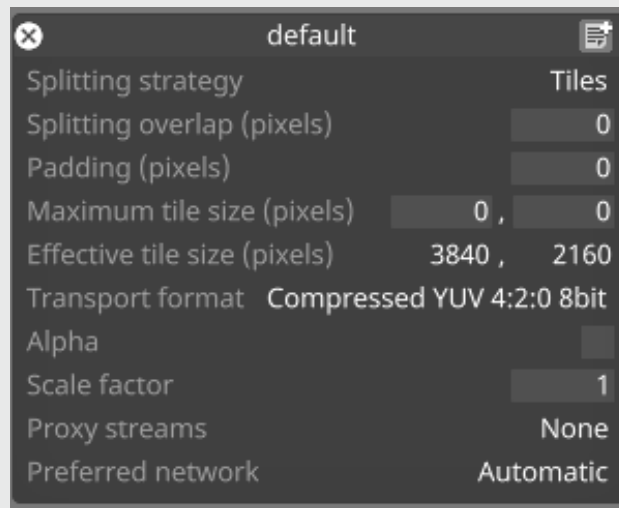

**Cluster Assigner** Properties include:

### Splitting Strategies

- » These are used to generate the sub-regions needed for distributing content across a set of render nodes.
- » There are 3 types of splitting strategies:
- » **Tiles** - lets Disguise software split up the content as it sees fit to the mapped channels. Note: this splitting strategy DOES NOT work with Mesh Policy.
- » **Full frame** - Sends the entire stream to the mapped channel.
- » **Manual** - splits each Viewport according to user specified instructions. When using the 'Manual' splitting strategy, the options for specifying how to split frames can be found within the Advanced workload settings.



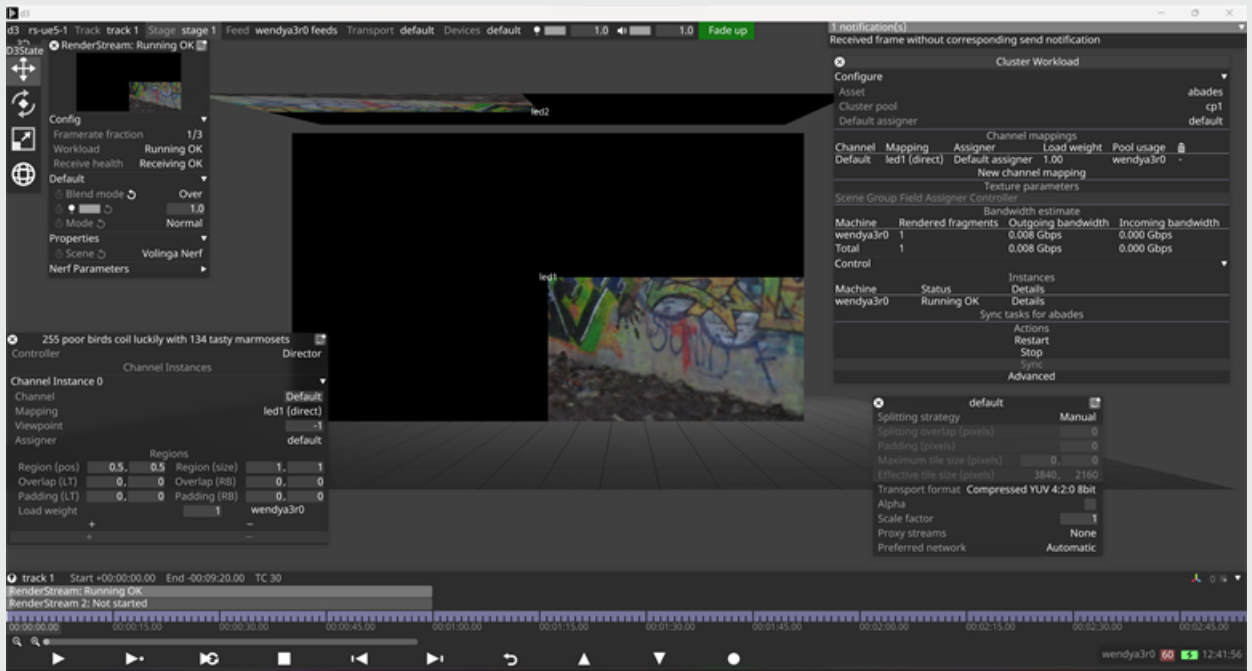

In Advanced workflow settings, note that region pos. has a range between 0 and 1. The screenshot shows both regions (pos) set to 0.5. Other property values in this editor also range from 0 to 1.

- **Splitting Overlap:** The Splitting Overlap option can be used to define a blend region at each split that hides imperfections at the seams
- **Padding (Pixels):** The Padding option enlarges the rendered area at each split, but does not stream the padded area, cutting off edge artifacts
- **Load Weight:** 'Load Weight' allows you to set a priority for the Cluster Assigner. The higher the weight of the assigner, the more machines will be assigned to render the content and thus more splits will be made.

- **Transport format:** The options to pick between 'Compressed' and 'Uncompressed', 'RGB 4:4:4', 'YUV 4:2:2', and 'YUV 4:2:0', and 8-bit, 10-bit and 12-bit transport bit-depths are available.
- **Alpha:** The option to enable or disable the Alpha channel on the content is available.
- **Scale factor:** Scale factor for the resolution.
- **Proxy Streams:** A compressed stream at a lower quality or resolution used for providing a preview on machines where receiving the full-quality stream is undesirable or impossible.
- **Preferred network:** Select the adapter to use for video transport on any channel the assigner is associated with.

Once the cluster has been configured, the stream's playback is managed via the Cluster Workload controls.

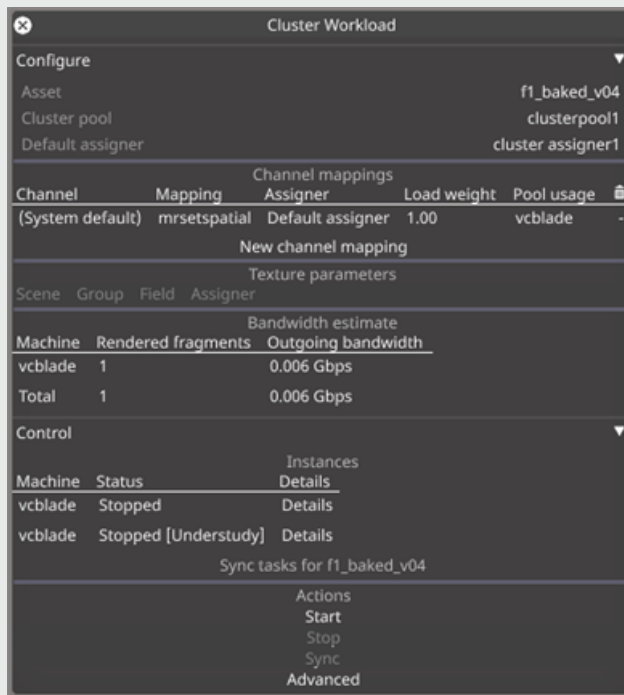

The options for managing the workload are:

- **Instances:** there can be only one workload instance running at a time in the same cluster pool. When started, the Instances table will be populated with the machines that have been sent the start signal
  - **Start:** sends signal to all machines in the pool to launch the Asset according to config settings
  - **Stop:** Sends signal to cease outputting a stream and quit the process sending it.
- The workload log can be opened by left clicking on the status within the Instances table
- **Sync:** begins the process of content sync. Content is synced from the source machine to all other machines available within the cluster pool; copies only the necessary directories and files needed.

— **Advanced:** right click to open the workload's advanced options:

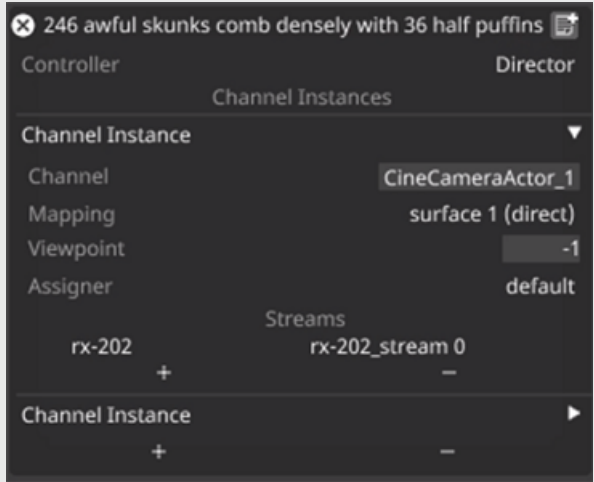

**Please note:** Any changes to the Assigner require a restart of the workload

## Receive Health

Status of entire cluster receiving streams, dynamically reported while stream is running.

Right-click on Receive health to open machine specific window:

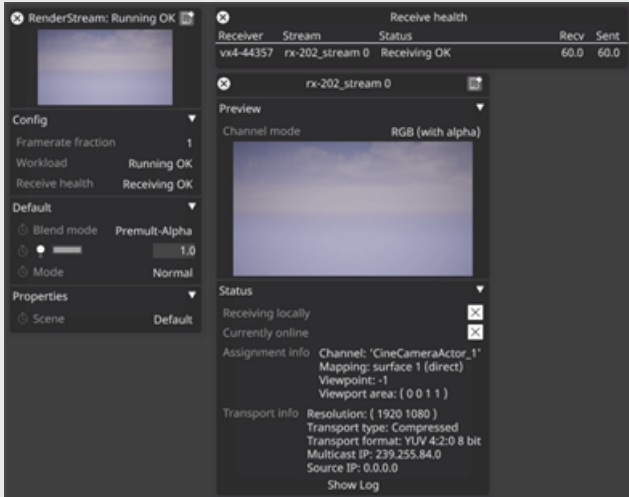

## Default

In the Default section of the RenderStream Layer, there are four common layer properties:

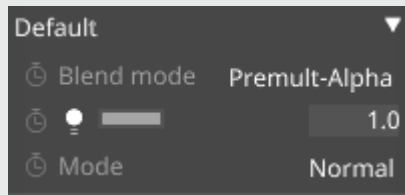

- Blend Mode: Premult-Alpha is needed for content that contains alpha data
- Brightness: Layer intensity
- Mode: This is used to determine the timeline's playback behavior as the layer is playing

## Properties Section

The last section of the RenderStream layer is asset specific and will display all exposed parameters from the asset as well as their keyframe editors

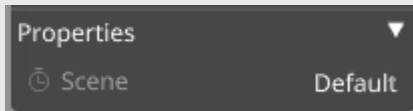

## Workflow

- Set up your RenderStream environment including installation of the Render Engine and required [plugin](#)
- Use the RenderStream Layer to control the third party render engine.
  - » For Notch, visit this [link](#)
  - » For Unity, visit this [link](#)
  - » For Unreal Engine, visit this [link](#)

**Please note:** The preferred sync adapter should not be left set to 'any', it should be set to the network of the highest bandwidth that is available to all machines in the workload, plus the disguise machines. This network will then be the one that is used to do the project sync and for all workload comms.

# Inner-Outer Frustum Workflow

Not only can content be mapped to the within the camera's frustum, another stream of content can simultaneously be mapped to the outside of the camera's frustum.

## Inner - Outer Frustum workflow

This workflow allows natural lighting and colour from content streaming via RenderStream to illuminate talent or objects within the performance area while the camera tracks through the space.



Use these steps to set up this workflow:

1. Create an MR set; add the LED surface(s);
2. Create a new camera in the Stage menu, move it back from the default position, and assign as the Current target in the MR set
3. Create a RenderStream Layer
4. Right click on Workload

5. Add an asset to the Cluster Workload and select the desired stream from the autopopulated Asset list.
6. Confirm that the RenderStream Layer is assigned to the Backplate for the MR set
7. Select the desired scene level.  
At this point content mapped to the inner frustum will be visible on the LED screen.
8. Open another instance of the Unreal Engine project in order to create a second stream
9. In Disguise software add another camera to the stage. Rename this camera "outer frustum camera" or similar label.
10. Position this camera in approximately the same location as the first camera and change the field of view to a larger value such as 120 so that the entire LED can be seen within the camera's thumbnail.
11. Create a second MR set that references the second camera, and select the same LED screen as the target.
12. Duplicate the RenderStream Layer
13. Create a new Cluster Workload
14. Add an asset and choose the second instance of RenderStream in the asset list.
15. Change the mapping to the second MR set
16. Set the camera plate of the second MR set to Backplate  
At this point you will have content mapped to the LED screen outside of the camera's frustum
17. In order to add some feathering to the edge of the inner frustum stream, you may wish to add a slight amount of overscan such as 1.2 to the first camera in its property window to make it slightly wider;
18. Then, add a soft edge mask to the MR set mapping on the first RenderStream Layer as well. Open the RenderStream Layer editor and right click on the MR set (spatial) mapping. Once open, you can create a new soft edge mask for this layer. To read more about creating masks, visit [this link](#).



# RenderStream Failover

Active backups are crucial for live events. With the RenderStream Failover functionality, you can set up rules and switch inputs to allow your servers to switch to an Understudy if a stream isn't working.

## Workflow

Follow these steps to configure RenderStream for failover:

1. Create a RenderStream Layer and follow the steps on the [RenderStream Layer](#) page to configure a Cluster Workload.
2. Start the workload; all render machines and Understudy will launch their instances of the project
3. Use the d3net Network Session widget to monitor and control the render machines and Understudy; switch to the Understudy within the Network Session widget if needed using 'Mark as Failed' on the stream that has failed and Disguise will automatically switch to the Understudy.

# Vicon Emulator

## Vicon Emulator

The following information will help you configure the Vicon Virtual System with Disguise systems. The Vicon Virtual System will allow you to emulate connections to a live Vicon system.

## Prerequisites

- Download and install [the Shōgun software](#).
- Download and install [the Vicon Virtual System](#).
- Download the [Camera\\_Tracking\\_Vero\\_V22.zip](#) camera calibration sample data package.

## Request a license

The Vicon Shōgun Live software requires a license, which can be requested by opening the program and following the instructions for the licensing popup.

## Set up the Vicon Virtual System with Disguise

1. Open the **Vicon Shōgun Live** application.
2. Open **Virtual System** and open **Camera Data File** and select one of the **.x2d** files in the **Camera\_Tracking\_Vero\_v22** sample data and click **Stream**.

3. In Shōgun, you will see the cameras populate the **Vicon Cameras** list.

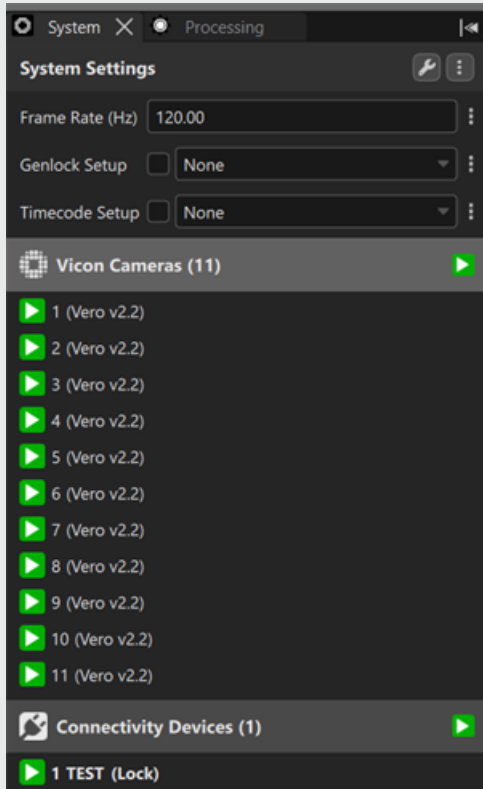

4. In the **Camera Calibration** panel, open the folder and select **Vero\_V22\_calibration.xcp** file in the

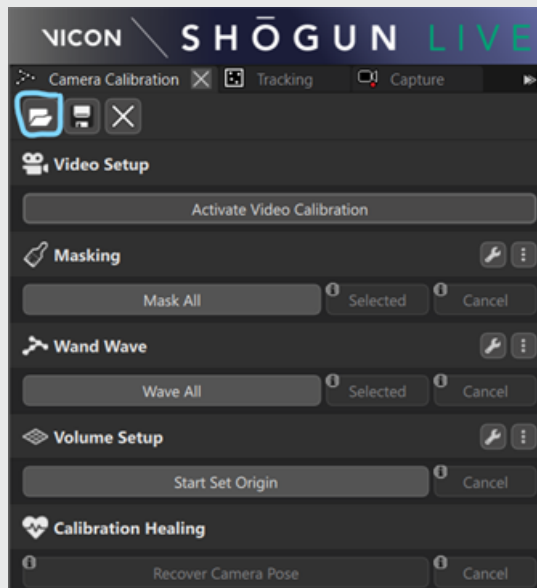

sample data package.

5. In the Tracking panel, click Import Subject (highlighted in blue) and select VCam\_Vero\_V22.vsk from the sample data.

- Click **Advanced Parameters** (highlighted in yellow) and enable Track with **ObjectTracker** (highlighted in pink) in the **Props > Properties** panel.

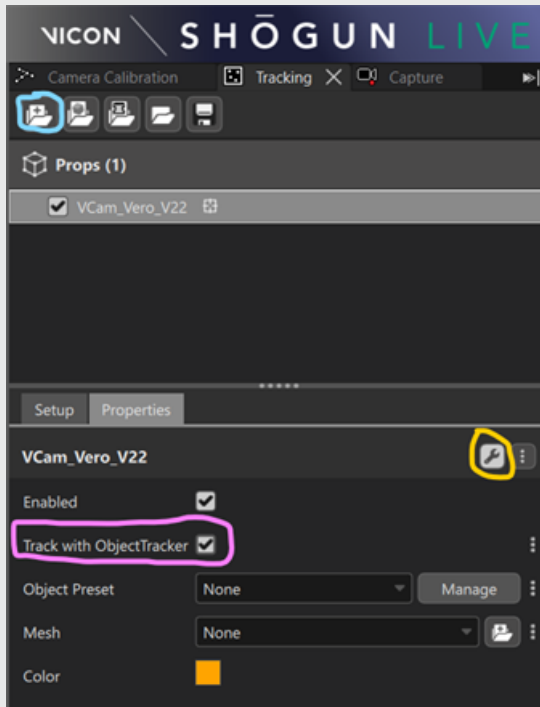

- In d3manager, navigate to **Machine Settings > Advanced Machines Settings**.
- Click and then insert the cursor in the **Name** field of a new line and add the command **enableVicon**. All machines will need this configuring to enable the datastream.

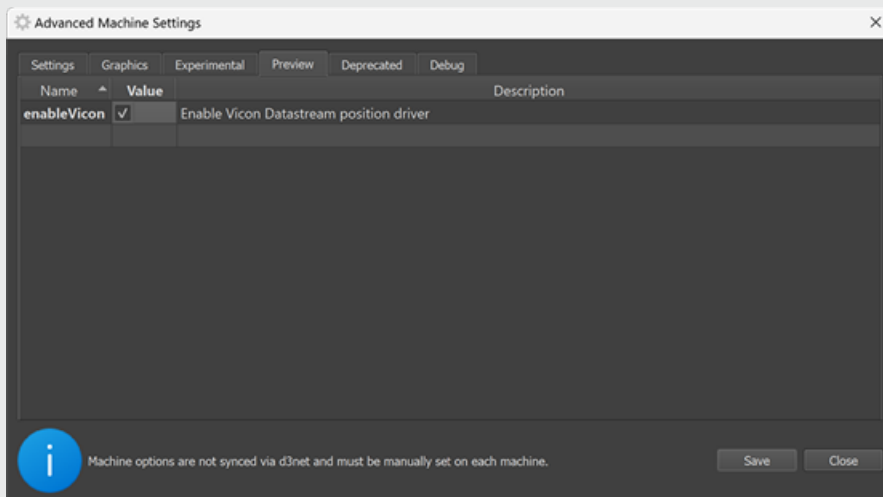

- Click the checkbox to enable it and then click **Save**.
- In a Designer project, create a **Device > Position Receiver**.
- Add a **ViconDataStreamDriver**. The default IP of 127.0.0.1 is suitable for local setups.

12. Engage the device.
13. Create a camera or a prop and set the Tracking Source to **Vicon**.

## Further reading

[Creating PositionReceivers and adding Tracking Sources.](#)

# Vicon Emulator

## Vicon Emulator

The following information will help you configure the Vicon Virtual System with Disguise systems. The Vicon Virtual System will allow you to emulate connections to a live Vicon system.

## Prerequisites

- Download and install [the Shōgun software](#).
- Download and install [the Vicon Virtual System](#).
- Download the [Camera\\_Tracking\\_Vero\\_V22.zip](#) camera calibration sample data package.

## Request a license

The Vicon Shōgun Live software requires a license, which can be requested by opening the program and following the instructions for the licensing popup.

## Set up the Vicon Virtual System with Disguise

1. Open the **Vicon Shōgun Live** application.
2. Open **Virtual System** and open **Camera Data File** and select one of the **.x2d** files in the **Camera\_Tracking\_Vero\_v22** sample data and click **Stream**.

3. In Shōgun, you will see the cameras populate the **Vicon Cameras** list.

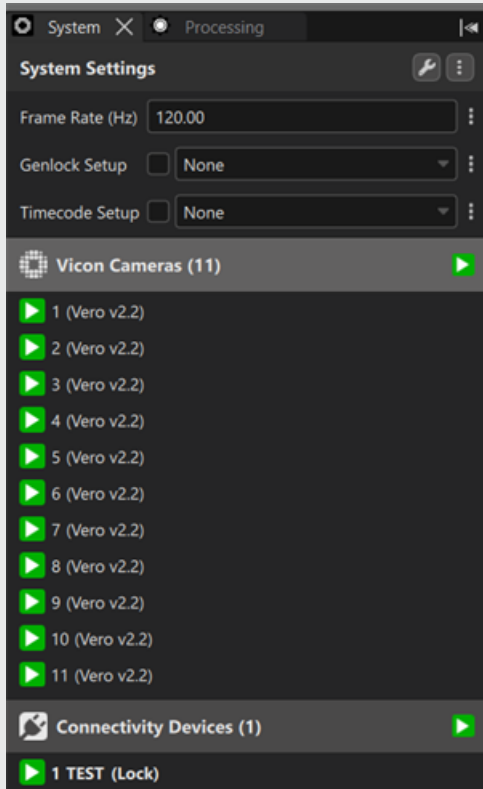

4. In the **Camera Calibration** panel, open the folder and select **Vero\_V22\_calibration.xcp** file in the



sample data package.

5. In the Tracking panel, click Import Subject (highlighted in blue) and select VCam\_Vero\_V22.vsk from the sample data.

- Click **Advanced Parameters** (highlighted in yellow) and enable Track with **ObjectTracker** (highlighted in pink) in the **Props > Properties** panel.

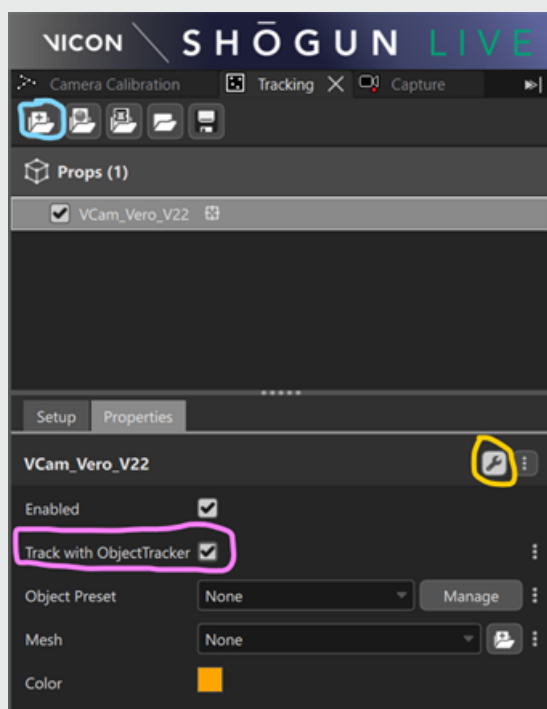

- In d3manager, navigate to **Machine Settings > Advanced Machines Settings**.
- Click and then insert the cursor in the **Name** field of a new line and add the command **enableVicon**. All machines will need this configuring to enable the datastream.

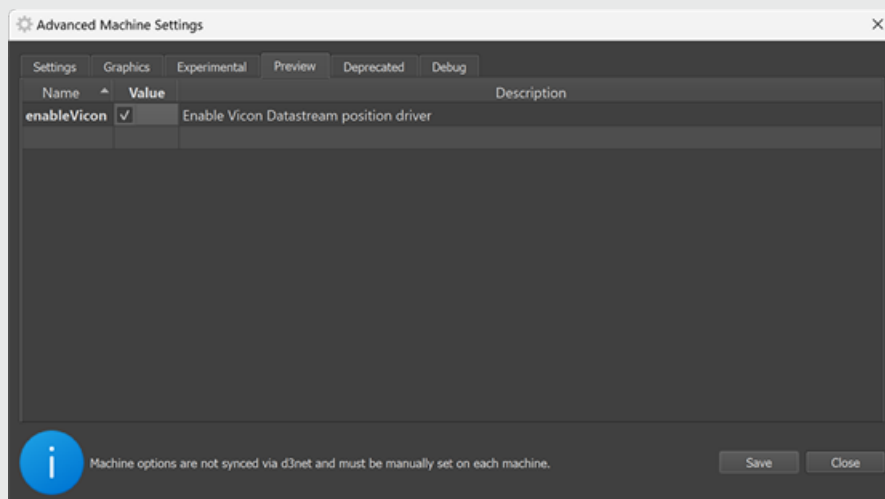

- Click the checkbox to enable it and then click **Save**.
- In a Designer project, create a **Device > Position Receiver**.
- Add a **ViconDataStreamDriver**. The default IP of 127.0.0.1 is suitable for local setups.



12. Engage the device.
13. Create a camera or a prop and set the Tracking Source to **Vicon**.

## Further reading

[Creating PositionReceivers and adding Tracking Sources.](#)

# RenderStream and Notch

RenderStream is the proprietary Disguise protocol for controlling third party render engines from Disguise software. This topic covers the steps specific to configuring the RenderStream workflow with Notch.



**Warning:** For cluster rendering it's recommended to use render nodes from the same disguise product range, e.g. all rx series machines. Mixing of machines from different product ranges is untested and unsupported.

**Notch** is the third party render engine available from [Notch.one](#). Notch can be configured to run either internally via a Notch layer or externally via RenderStream. This topic will cover the RenderStream-Notch workflow. For more information on using a Notch layer, visit this [link](#).

## Notch Host

Notch\_Host is a secondary application that is included as part of the main Disguise installation process. The purpose of this application is to load Notch blocks externally Disguise software and create RenderStream output streams which can be accessed by all machines across the same network.

**Please note:** Ensure the correct version of Disguise software is installed on all machines in network, including render nodes.

# Basic Setup

- Place Notch blocks in: **C:\Users\USERNAME\Documents\Renderstream Projects** or **D:\Renderstream Projects** if using an rx hardware system.
- The Asset discovery system searches all sub-directories so you can place all Notch blocks in an aptly named "Notch" folder.

## Setup RenderStream Layer

1. Launch Disguise software and create a new RenderStream layer.
2. For camera base mappings:
  - a. Add a new camera to the stage
  - b. Create a new Camera Plate/Spatial mapping
  - c. Add the camera to the mapping
3. Right-click the 'Workload' field to open the Cluster Workload widget.
4. Expand the 'Configure' separator.
5. Select 'Asset' and choose your Notch block.
6. Right-click the Asset to open its editor:
  - a. Set 'Source Machine' to the machine with the asset (used for syncing content).
7. Select 'Cluster pool' and create a new cluster.

Within the **Cluster Pool**:

1. Add the desired machines.
2. Right-click on the “default” ClusterAssigner within the ‘Default assigner’ field to open the ClusterAssigner widget.

Within the **Cluster Assigner**:

1. Select the distribution strategy and video transport options (changes to transport settings require the workload to be restarted).

Within each Channel Mappings table:

1. Select ‘New channel mapping’ and assign your desired mapping.
2. Repeat for all desired channel-mapping combinations.
3. Expand the ‘Control’ separator.
4. If the machines in the Cluster Pool do not have the content or the project has changed, press Sync.
5. If the machines in the cluster pool do not have the content or the project has changed, press **Sync**
6. Ensure all ‘Sync tasks’ are marked “completed”.
7. Press **Start**.
8. Wait for Workload status to switch to **Running** and confirm that all streams are received.

**Please note:** Notch blocks can only be split if they contain an exposed camera. If you attempt to split a block that does not have an exposed camera across multiple render nodes, the content will simply be duplicated.

# RenderStream and Unity

RenderStream is the proprietary disguise protocol for controlling third party render engines from Disguise software. This topic covers the steps to configure Unity with RenderStream.



**Warning:** For cluster rendering it's recommended to use render nodes from the same Disguise product range, e.g. all rx series machines. Mixing of machines from different product ranges is untested and unsupported.

**Unity** is a third-party game engine that can be used to create 3D scenes. Unity projects can be adapted such that they create RenderStream output streams using disguise's Unity plugin. This plugin supports both camera and non-camera based mappings.

A professional license is required when working in Unity. Please visit the [Unity website](#) for more information on purchasing licenses and training on the Unity software.

## Plugins

- In order to communicate with Disguise software, Unity requires the installation of a plugin on the render node.
- The RenderStream pre-packaged plugins for Unity are available in the [disguise github](#).
- For the most up to date Unity plugin, you can compile the plugin from the source code [here](#)
- Place the plugin into this folder : Unity: PROJECT\_ROOT/Assets/DisguiseUnityRenderStream.

When adding a plugin to a Unity project, it is important that it is placed in the correct location and that the folder containing the plugin files is named correctly otherwise unexpected errors may occur.

## Unity project setup

1. Launch Unity, navigate to Projects and select **New**.
2. Select a project template (e.g. 3D)
3. Name the project, set the location to: “C:\Users\USERNAME\Documents\Renderstream Projects” or “D:\Renderstream Projects” if using a system with a media drive (e.g. RX) and select ‘Create’.
4. Open the project folder and place the plugin inside the ‘Assets’ folder.
5. Select **File** followed by **Build Settings**:
  - a. Set **Architecture** to **Intel 64-bit**.

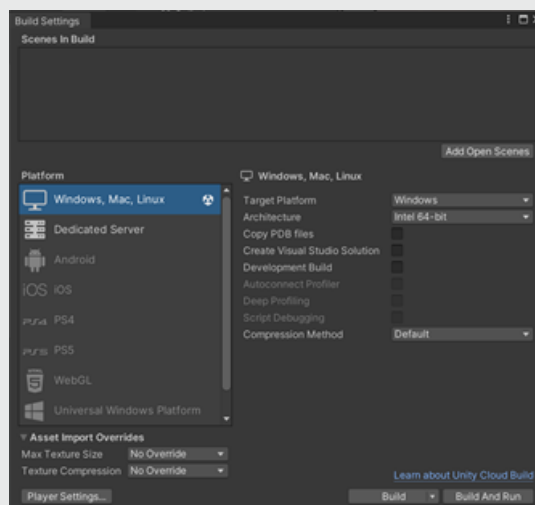

6. Navigate to **Player Settings...** and **Configuration**:

- a. Set Api Compatibility Level to **.NET Framework**

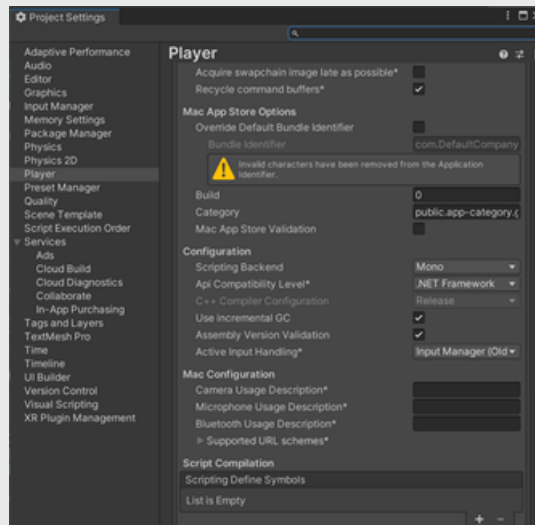

7. Optionally, set game object Channel visibility:
8.
  - a. **Edit** then navigate to **Project Settings...**
  - b. **Tags and Layers** and **Layers**.
  - c. Give any empty **User Layer** a name.
  - d. Select any object from the scene
  - e. Set **Layer** to your newly defined Layer from the Inspector panel.
  - f. Select your Camera(s)
  - g. Select whether or not you want the Camera(s) to see the objects in your newly defined Layer by opening the **Culling Mask** dropdown from the Inspector panel.
9. Build the Unity project.

10. Save and close Unity.

**Please note:** Ensure the correct version of the disguise software is installed on all machines in network, including render nodes.

## RenderStream Layer configuration

1. Create a new RenderStream Layer.
2. Select **Asset** and choose your Unity executable.
3. Right-click the Asset to open its editor:
  - a. Set **Source Machine** to the machine with the asset (used for syncing content).
4. Select **Cluster pool** and create a new cluster.
5. Within the Cluster Pool, add the desired machines.
6. Select **Cluster assigner** and create a new **Cluster Assigner**.
7. Within the **Cluster Assigner**:
  - a. Select the Asset.
  - b. Select **Create Channels**.
  - c. Within each Channel's Cluster Assigner and/or the default Cluster Assigner:
    - i. Select the distribution strategy and video transport options (changes to transport settings require the workload to be restarted).
9. Expand the **Default** separator and right-click **MultiChannelMap** to open its editor:



- a. Select **Create Channels**.
  - b. Assign one or more Mapping (regular Disguise mapping) to each Channel (e.g. frontplate). Each unique Channel-Mapping combination creates a new workload.
10. Right-click **Workload** to open its editor:
- a. If the machines in the cluster pool do not have the content or the project has changed, press **Sync**.
  - b. Ensure all **Sync Tasks** are marked completed.
  - c. Press **Start**.
  - d. Wait for Workload status to switch to **Running**.



**Warning:** When launching a Unity executable for the first time, a Windows Firewall popup will appear. If the executable is not allowed through the firewall, Disguise software will not be able to receive the RemoteStream.



**Warning:** Unity assets can only be split across multiple nodes when using 3D Mappings (i.e. Camera Plate or Spatial). Attempting to split using a 2D Mapping will not work; all nodes will render the entire frame.

## Exposed parameters

The Unity plugin allows you to expose certain options for each component of an object available within the scene. These options will be presented as parameters within the RenderStream Layer in Disguise software. Modifying the value of a parameter in turn changes the value of the corresponding option in Unity thus altering the options of the selected object within the scene.

1. Exposing a parameter in Unity:
  - a. Select an object from within the scene (e.g. any light source).
  - b. Select 'Add Component' at the bottom of the Inspector panel.
  - c. Add the 'Remote Parameters' component.
  - d. Drag and drop the component you wish to expose (e.g. Light) into the 'Exposed Object' field.
  - e. Expand the 'Fields' separator.
  - f. Select all options you wish to expose (e.g. Colour and Intensity).
2. Build the Unity project.
3. Save and close Unity.
4. Open the RenderStream layer in Disguise software and start the workload.
5. Modify parameter value(s).

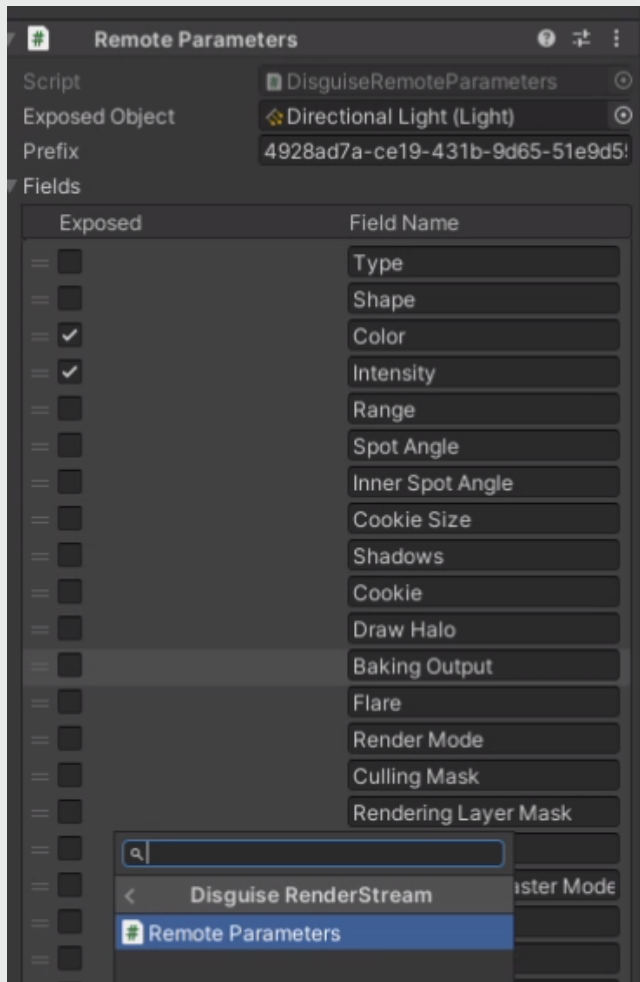

## Remote Texture Parameters

The Unity plugins offers support for sharing textures remotely through the use of exposed parameters. This allows a two-way flow of video content between Disguise software and the Unity engine.

1. [Optional] Add a Plane (or any other 3D game object) to the scene.
2. Create a new Render Texture: Select 'Assets' in the Project panel. Right-click inside and select Create → Render Texture.

3. Drag and drop the new Render Texture onto your Plane (or 3D game object of your choice) in the scene. Confirm that the new Render Texture has been added as a 'Material' component to your game object. Confirm that the new Render Texture has been set as a material element in the 'Mesh Renderer' component of your game object.
4. Expose the Render Texture as a remote parameter: Add a 'Remote Parameters' component to the Plane (or 3D game object of your choice). Drag and drop the new Render Texture (Material) component into 'Exposed Object'. Open the 'Fields' separator and ensure that "Main Texture" is enabled (no need to enable any other fields).
5. Build the Unity project.
6. Save and close Unity.
7. Open the RenderStream Layerin Disguise software and start the workload.
8. Create a new layer (e.g. Video) and assign media (e.g. Ada).
9. Move the new layer underneath the RenderStream Layer with Ctrl+Alt+down arrow.
10. Alt+drag to arrow the newly created layer into the RenderStream Layer.
11. Confirm arrowed input appears in the RenderStream content.

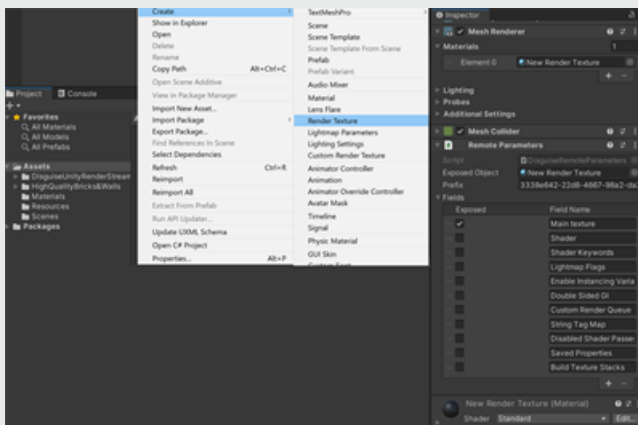

Screenshot showing how to create a Render Texture and expose it on an object.

## Remote Parameters-3D Object Transforms

You can also expose a Unity GameObject's transform parameters; this will allow you to control the object's movements in two ways which is defined by the field you expose. When exposing a GameObject's Transform, you will have the options to expose the following fields:

**Transform:** This allows you to control the full 3D transform (translation, rotation, scale) of the GameObject using a null object in the disguise software. This workflow is known as **3D Object Transform**. The null object acts as a 'proxy', allowing you to move objects in 3D via the on-screen transform handles, or by linking it to a dynamic transform data source, e.g. a tracking device.

**Local Rotation, Local Position, Local Scale:** If you expose the local options these will give you the ability to keyframe the rotation, positions and scale in the disguise software allow for quick and easy manipulation of a Unity object on the Disguise timeline.

Note: if you expose all of the fields, the Local Rotation, Local Position and Local Scale will override the Transform in Disguise software. This will result in the null object not controlling the Unity GameObject.

## Remote Parameters-Text Parameters

The Exposed Parameter workflow can also be used to expose live text parameters using a "3D text" actor in the Unity engine. You can use the Remote Parameters workflows to expose the text input field in the disguise software allowing you to edit the text in real time.

## Scenes

Scenes in Unity can be composed of any number of game objects which are unique to that scene (by default). The Unity plugin offers two forms of multi-scene support:

**Manual** - this option restricts Disguise software's control of scenes and instead merges all Channels and remote parameters into a single scene.

**Selection** - this option allows scenes to be controlled from inside Disguise software; Channels are merged into a single list (duplicates removed) and remote parameters are per-scene.

1. Create a new scene:
  - a. Open the Kebab menu for your current scene in the Hierarchy panel.
  - b. Select **Add New Scene**.
  - c. Optionally, populate scene with your desired game objects and exposed parameters.
2. Select **Resources** then **DisguiseRenderStreamSettings** from the Project panel.
3. Set **Scene Control** option accordingly.
4. Build the Unity project.
5. Save and close Unity.
6. Open the RenderStream Layer in Disguise software and Start the workload.
7. Modify the **Scene** parameter as part of your normal sequencing.

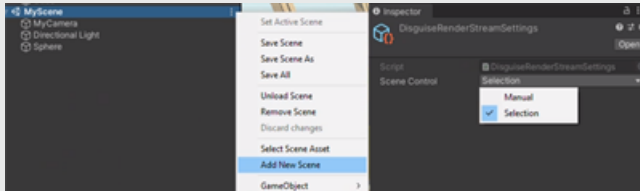

## Time control

The Unity plugin offers Timecode support. This means that if any game object has a 'Playable Director' component and is animated using timeline functionality, it will be reflected in Disguise software timeline.

1. Adding time control to an object in Unity:
  - a. Select **Window** followed by **Sequencing** followed by **Timeline**.
  - b. Optionally, move the Timeline Window from the main panel to the bottom panel (i.e. drag and drop Timeline Window next to Console Window).
  - c. Select an object from within the scene (e.g. any user placed prop).
  - d. Click the **Create** button within the Timeline Window.
  - e. Save the new Timeline.
  - f. Hit the Record button on the newly created Animator for the chosen object within the Timeline.
  - g. Add an initial keyframe by right-clicking on any animatable property of the object (e.g. Position) and select **Add Key**.
  - h. Move the Playhead along the Timeline.
  - i. Modify your chosen property either by using the 3D controls within the Scene or by updating the value directly from within the Inspector panel (a keyframe will be added automatically when a value is changed).
  - j. Hit the Record button again to stop recording.
  - k. Return the Playhead to the beginning of the Timeline and play the sequence to confirm your animation is correct.
  - l. With the object still selected, select **Add Component** at the bottom of the Inspector panel.
  - m. Add the **Time Control** component.
2. Build the Unity project.

3. Save and close Unity.
4. Open the RenderStream Layer in Disguise software and Start the workload.
5. Play your timeline within Disguise software.



## Useful Unity information

- There is no need to attach the Disguise RenderStream script to the cameras in Unity. Cameras will auto-configure on asset launch.
- When using the 'Manual' scene selection option in Unity, game objects from all built scenes will not appear in the "Default" scene. In order to merge scenes and/or dynamically load/unload them, a custom script must be used.
- The "Default" scene will be the first indexed scene from within the 'Scenes In Build' table in Unity's build options.
- The exposed parameters from all scenes will still show within Disguise software, even if game objects from all built scenes are not merged into the "Default" scene.
- When using the 'Selection' option in Unity, game objects and exposed parameters are unique to each scene. There is no shared object scene similar to the "Persistent" level in Unreal Engine.
- When launching a Unity executable for the first time, a Windows Firewall popup will appear. If the executable is not allowed through the firewall, Disguise software will not be able to receive the RemoteStream



- Game objects included as part of a Unity template may not be able to be controlled via Timecode. This is a Unity issue rather than one with the disguise script.
- If attempting to use the Unity High Definition Render Pipeline (HDRP):
  - » Both the 'Windows 10 SDK' and 'Game Development with C++' modules must be installed as part of your Visual Studio installation.
  - » The 'Scripting Backend' must be set to "Mono" when building the executable.
- Since Unity Assets are built executables, Disguise will not recognise the 'Engine' of them; they will simply be reported as "Custom". Disguise will not be able to report the Unity plugin version used within built executables. If an incompatible Disguise-Unity plugin combination is used, no explicit notification will be shown.

# RenderStream & TouchDesigner

RenderStream is the proprietary Disguise protocol for controlling third party render engines from Disguise software. This topic covers the steps specific to configuring the RenderStream workflow with TouchDesigner.

## Overview

Beginning with r22, Disguise added support for a new major real-time engine. disguise's proprietary RenderStream infrastructure, enabling bi-directional data transfer between disguise and third-party render engines, now supports the integration of TouchDesigner. This integration, made possible thanks to RenderStream's new support for Vulkan API, will allow users to bring a real-time 3D scene developed in TouchDesigner into the disguise software and build it into their final project.

TouchDesigner is a visual development platform that can be used to create interactive media systems, architectural projections, and live music visuals, all in real-time. For more information on TouchDesigner, please visit the [derivative.ca website](https://derivative.ca)

## See How It Works



## TouchDesigner Integration

- Requires TouchDesigner build 2022.28040 or later
- Requires TouchDesigner Pro license
- Requires Disguise r22 or later

3 nodes have been added to TouchDesigner for the RenderStream integration. They are:

- **RenderStream In CHOP**

This node is the primary operator to control and configure a connection with RenderStream. Along with being the sync-point for when a frame starts rendering, it also brings in all of the control channels, and also takes a DAT with schema information to create controllable parameters within Disguise.

[https://derivative.ca/UserGuide/RenderStream\\_In\\_CHOP](https://derivative.ca/UserGuide/RenderStream_In_CHOP)

- **RenderStream In TOP**

This node is used to receive image data sent over RenderStream

[https://derivative.ca/UserGuide/RenderStream\\_In\\_TOP](https://derivative.ca/UserGuide/RenderStream_In_TOP)

### RenderStream Out TOP

This node is used to send image data out to RenderStream.

[https://derivative.ca/UserGuide/RenderStream\\_Out\\_TOP](https://derivative.ca/UserGuide/RenderStream_Out_TOP)

In addition to the above, the TouchDesigner integration requires the use of **Permitted Custom Engines**, which is a text file that contains 'toe' added as the content within and then placed into the root of the RenderStream Projects folder.

This text file allows Disguise to launch other engines as well by adding their custom file extensions if needed.

# RenderStream and Unreal Engine

RenderStream is the proprietary disguise protocol for controlling third party render engines from Disguise software. This set of topics covers the steps needed for configuring Unreal Engine for use with RenderStream.

This list includes the essential set of topics to help guide you through the RenderStream-UE workflow.

- [UE Project Setup](#)
- [RenderStream Layer Setup](#)
- [Scene Optimization](#)
- [Scene Levels](#)
- [Exposed Parameters](#)
- [Remote Texture Sharing](#)
- [3D Object Transforms](#)
- [Remote Text Parameters](#)
- [Level Sequencing](#)
- [Multi-user Editing](#)

# RenderStream and Unreal Engine

RenderStream is the proprietary disguise protocol for controlling third party render engines from Disguise software. This set of topics covers the steps needed for configuring Unreal Engine for use with RenderStream.

This list includes the essential set of topics to help guide you through the RenderStream-UE workflow.

- [UE Project Setup](#)
- [RenderStream Layer Setup](#)
- [Scene Optimization](#)
- [Scene Levels](#)
- [Exposed Parameters](#)
- [Remote Texture Sharing](#)
- [3D Object Transforms](#)
- [Remote Text Parameters](#)
- [Level Sequencing](#)
- [Multi-user Editing](#)

# UE Project Setup

This topic covers the steps needed for configuring an Unreal Engine scene for use with RenderStream.

Unreal Engine (UE) is a third-party game engine that can be used to create 3D scenes. Unreal Engine projects can be adapted such that they create RenderStream output streams using disguise's UE plugin. This plugin contains several components that enable both camera based mappings with tracking as well as non-camera based (2D) mappings (e.g. direct).

## Plugins

- In order to communicate with disguise, Unreal Engine requires the installation of a plugin on the render node.
- The RenderStream pre-packaged plugins for Unreal Engine are available in the [disguise github](#).
- For the most up to date plugin, you can compile the plugin from source code [here](#)
- Place the plugin in this UE location on the render node: PROJECT\_ROOT/Plugins/RenderStream-UE.
- When adding a plugin to a UE/project, it is important that it is placed in the correct location and that the folder containing the plugin files is named correctly otherwise you may encounter unexpected errors.

**Please note:** Ensure the correct version of Disguise software is installed on all machines in network, including render nodes.

# Setup Unreal Engine Project

1. Launch Unreal Engine.
2. Create a new 'Game' project with default settings and ensure it is saved in:  
**C:\Users\USERNAME\Documents\RenderStream Projects** or **D:\RenderStream Projects** if using rx hardware.
3. Open the project folder and create a new folder called **Plugins**.
4. Place the plugin in the Plugins folder.
5. Restart Unreal Engine.
6. Search for **Camera** in the **Place Actors** panel.
7. Drag and drop a new Camera into the scene.
8. Optionally, position the Camera Actor accordingly.
9. Click the Add Component button from the Camera Actor's Details panel and add a **RenderStream Channel Definition**.
  - a. The name of the Channel in Disguise software will be the name of the camera actor, so name the camera accordingly.
  - b. The setting **Default Visibility** defines whether the camera will see most actors in the scene.
10. [Optional] Click the 'Show Advanced' dropdown arrow underneath Default Visibility and set the advanced render flags accord to your needs.
11. [Optional] Force the visibility of select Actors within the Camera's Channel Definition (useful for splitting content between the front and backplates):



- a. [r18.0] Add the “Render Stream Channel Visibility” component to your selected Actor/s from the Details panel. Then, set the visibility of the Actor per-channel definition created in the previous steps.
- b. [r18.1+] The "RenderStream Channel Visibility" component was removed, so to change the visibility of a component, add your selected Actor/s to the visibility sets by clicking the '+' button on the set and then selecting the Actor/s from the dropdown of the newly added element.

If you wish to add multiple Actors to a visibility set at the same time, lock the current selection into the Details panel, select the Actors you wish to add either from within the scene or the Inspector panel, right-click the visibility set you wish to add the Actors to, and select “Add from Selection”.

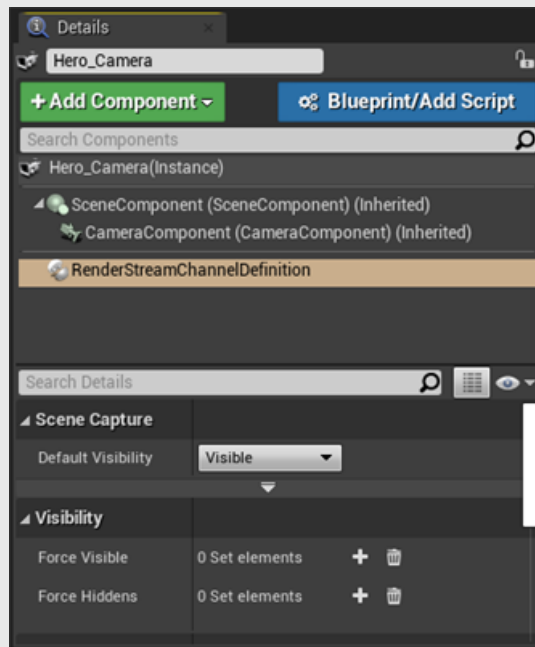

12. [Optional] To make Unreal Engine run at full speed when out of focus go to Edit → Editor Preferences and untick “Use Less CPU when in Background” (search "cpu").
13. Save the project.

14. Close Unreal Engine.

## Useful Unreal Engine information

Unreal Engine has several methods for saving a project. When making changes to a project for use with RenderStream, it is best to close the project before attempting to start a workload. This will prompt you to save all changes to your project. If your Unreal Engine project is not saved correctly, you may experience unexpected behaviour.

## Status Monitoring

A helpful feature of the RenderStream plugin is the ability to show the status of the plugin in a widget. Here is how to setup the blueprint in the Unreal Engine project and add a status widget to the display:

1. Add a 'Create Widget' block
2. Change class to RenderStream Status Widget
3. Connect to an '**Add to Viewport**' block by dragging off the return value of the status widget

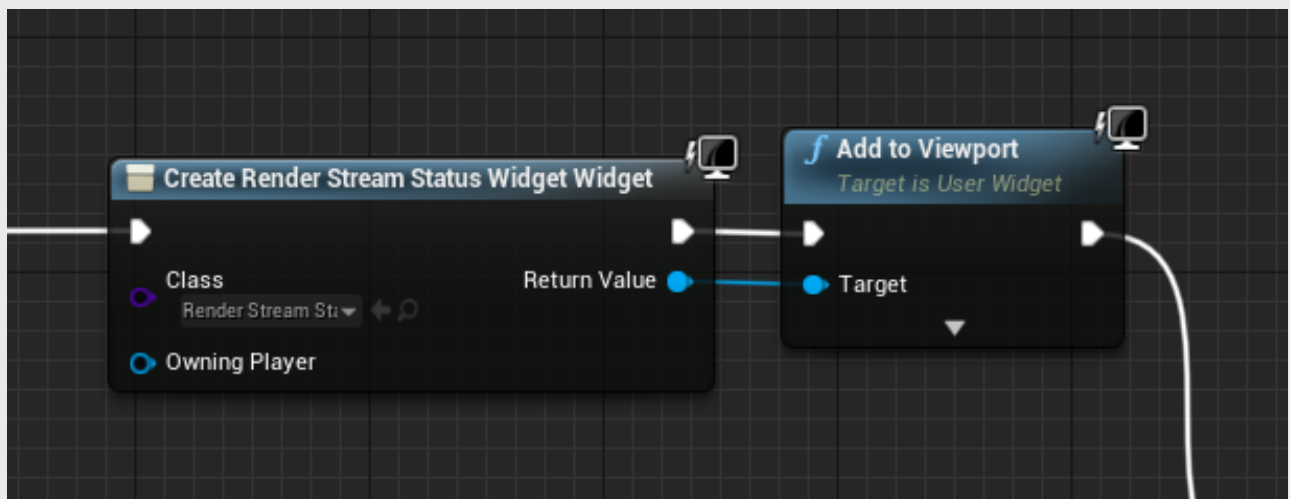

# 3D object transforms

This topic covers the steps needed for configuring 3D object transforms within an Unreal Engine project for use with RenderStream.

This feature allows you to control the full range of 3D object transforms (translation, rotation and scale) of an object in Unreal Engine from Disguise software using a null object.

If you wish to expose the Transform (i.e. position, rotation and scale) of an Actor, you must ensure that the Actor's Mobility is set to 'Movable' from within the Details panel. If this is not done, Disguise software will only be able to control the Actor's scale. Follow these steps to configure the 3D object transforms of an object within an Unreal Engine scene:

## Unreal Engine Level Blueprint setup

1. To control the transforms of an Actor (eg. Cine Camera Actor, Static Mesh Actor) from within Disguise software, start by dragging the Actor into the Level Blueprint.

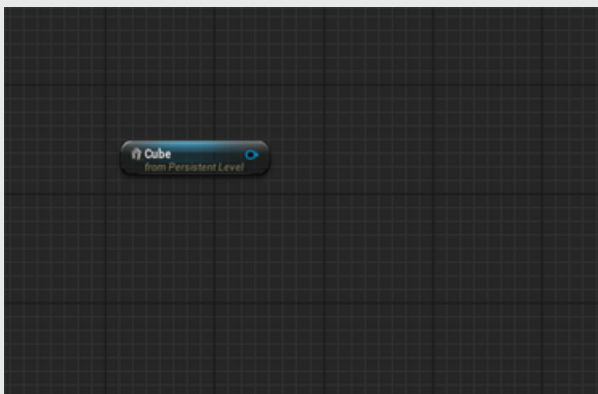

2. Drag the blue pin from the a new node in the Event Graph. When prompted to search for a new action, search for "SetActor Transform".

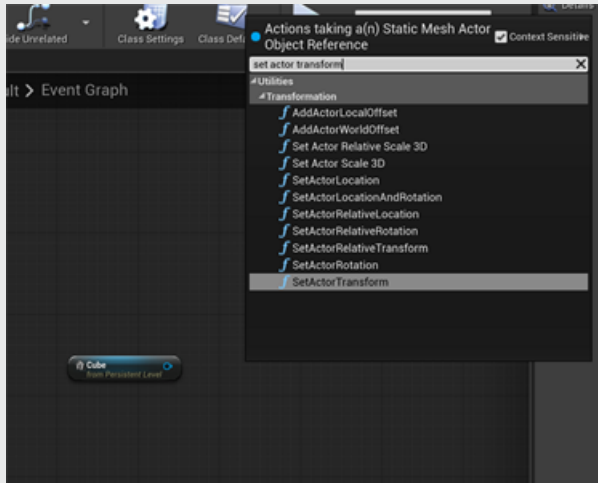

- Right click on the “New Transform” and select the option to “Promote to Variable”.

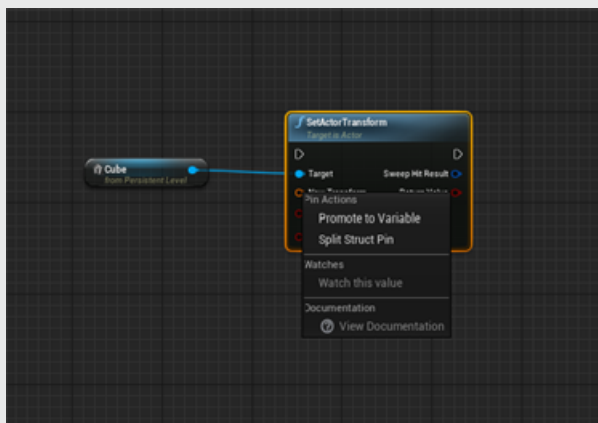

- The next step is to link this to the “Event Tick”.

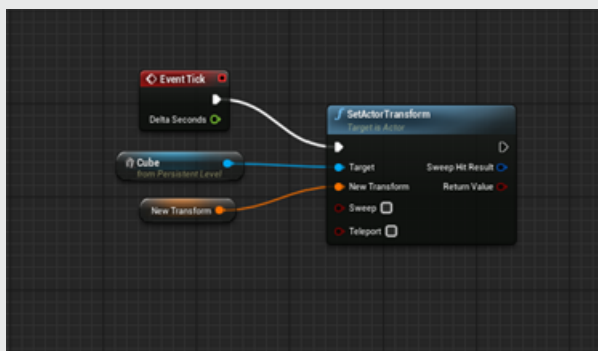

- Now Compile the Blueprint. This will give you the ability to set the default transforms of that object. Be sure to set “New Transform” to **Instance Editable**

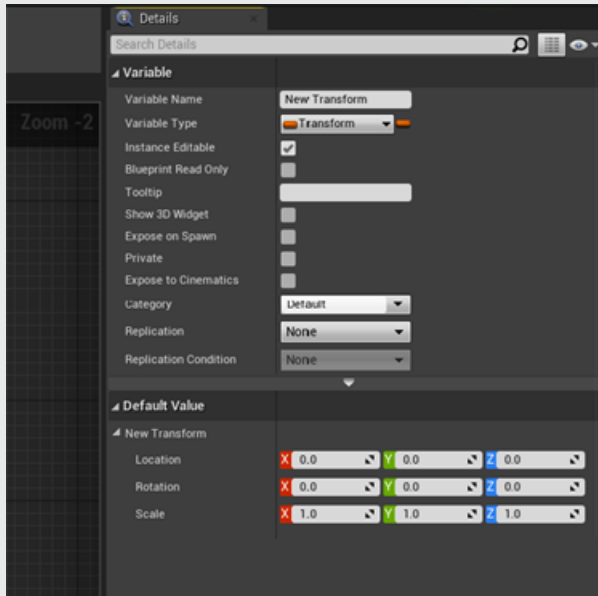

- The last step is to make the object "Movable". In the default scene all the objects will be set to static; this can be changed in the Object details panel.

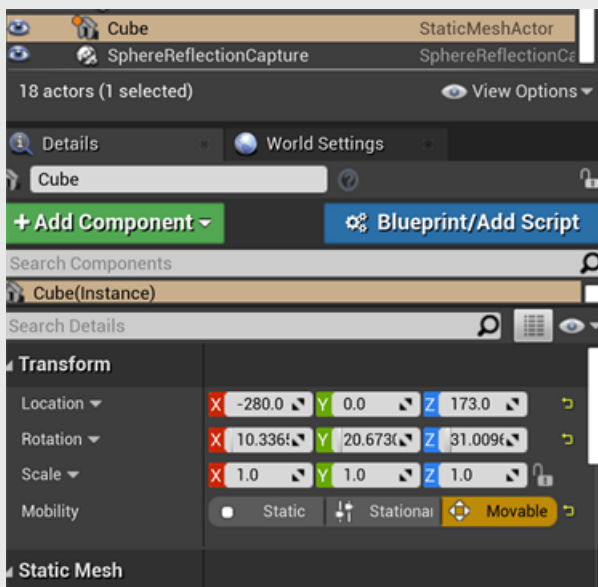

- Save and close the Unreal Engine project
- You can now control the Actor from within Disguise software by selecting a prop to link its transforms to from within the RenderStream Layer Properties tab.

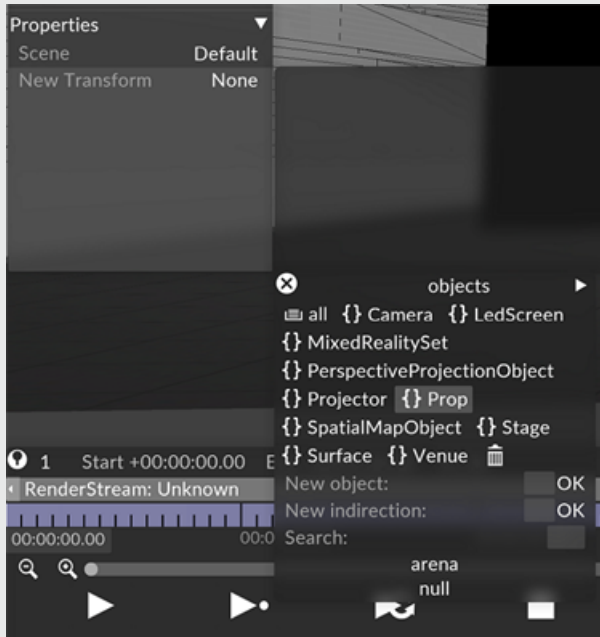

**Please note:** “Event Tick” allows only one output, if controlling more than one parameter from disguise, you will use a “Sequence” node to split the “Event Tick”. Add a Sequence Node by right clicking and searching for “Sequence” .

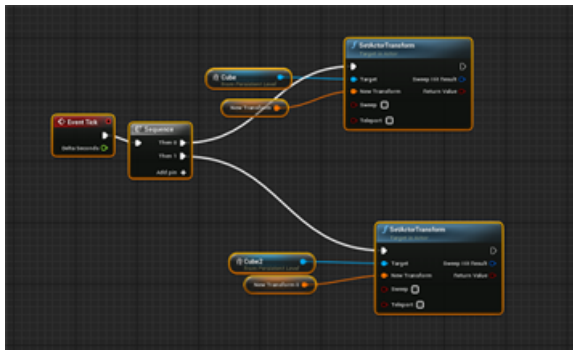

# Exposed Parameters

This topic covers the steps required for exposing parameters within an Unreal Engine scene for control via RenderStream.

The Unreal Engine plugin allows you to expose variables within the UE scene that can be used to control the parameters of the actors within the environment. These variables will be presented as parameters within the RenderStream Layer in Disguise software. Modifying the value of a parameter in turn changes the value of the corresponding variable within UE thus altering the parameter/s of the selected actor within the scene.

## Steps for Exposing Parameters within a UE Scene

1. Creating and configuring a variable within the level Blueprint:
  - a. Click **Blueprint** in the Toolbar and select **Open Level Blueprint**.
  - b. Click the **Add** button next to Variables within the My Blueprint panel.
  - c. Name the variable according to the desired property (e.g. Fog Visibility).
  - d. Select the variable.
  - e. Set the **Variable Type** in the Details panel according to the desired property (e.g. visibility == boolean).
  - f. Enable **Instance Editable**.
  - g. Optionally, set **Category** to the name of the menu you wish the parameter to appear under in the RenderStream layer.
  - h. Optionally, configure ranges for the value.
  - i. Compile.
  - j. Set your desired **Default Value** for the variable in the Details panel.
2. Assigning an action to the variable:

- a. Right-click and create an **Event Tick** action.
  - b. Return to the scene.
  - c. Select an Actor from the World Outliner panel (e.g. Atmospheric Fog).
  - d. Drag and drop the Actor into the Blueprint's Event Graph.
  - e. Drag out from the blue pin (Static Mesh Actor Object Reference) on the Actor component and create any new Rendering Component Action (e.g. Set Visibility).
  - f. Drag out from the white pin (Exec) on the Event Tick action and connect it to the white pin (Exec) on the left-side of the Rendering Component Action.
  - g. Drag out from the **New Component\_Name** pin (e.g. New Visibility) on the Rendering Component Action and create a **Get Variable\_Name** action.
  - h. Compile and Save.
3. Save and close Unreal Engine.
  4. Open the RenderStream layer in Disguise software and **Start the workload**.
  5. Modify parameter value/s as part of your normal sequencing.



**Warning:** Remote Parameters attached to Event Tick are expensive and resource hungry and should only be used for frame synchronous keyframing of parameters. For general purpose manipulation of the scene, like adjusting lighting or placing objects - Unreal has workflows using the Remote Control API, or their Multi Editor products - which are far lower cost to the scene. This will help with performance optimisation on scenes..



# Level Sequences

RenderStream is the proprietary disguise protocol for controlling third party render engines from Disguise software. This topic covers the steps needed for configuring Unreal Engine for use with RenderStream.

The Unreal Engine plugin allows a Level Sequence built within an Unreal Scene to be triggered via a RenderStream Layer. This means that if any actor is animated within the UE scene using timeline functionality, it can be controlled from within Disguise software from the timeline.

## Level Sequences & Time Control

To create and configure a Level Sequence:

1. Open your UE project.
2.
  - a. Optionally, add a new Actor you wish to animate to your scene.
  - b. Click **Cinematics** in the Toolbar and select **Add Level Sequence**.
  - c. Name the new Level Sequence and Save.
  - d. In the Sequencer: click the Track dropdown and set the **Actor To Sequencer** and select the Actor you wish to animate.
  - e. Add your initial keyframe for any or all Transform properties by clicking the small **+** button (“Add a new keyframe at the current time”).
  - f. Move the Playhead along the Timeline.
  - g. Modify your chosen property either by using the 3D controls within the scene or by updating the value directly from within the Details panel.
  - h. Add another keyframe in the same manner.
  - i. Return the Playhead to the beginning of the Timeline and play the sequence to confirm your animation is correct.
  - j. Open the **Sequence Display Rate** dropdown (fps counter) and set the display rate to that of your Disguise project.

- k. Set the **Clock Source** to **Timecode**.
- l. Save the Level Sequence.

Configure the Level Sequence:

3.
  - a. Select the Level Sequence in the World Outliner panel.
  - b. Navigate to the Playback tab in the Details panel.
  - c. Enable 'Auto Play' and configure other options according to your preferences.
  - d. Save Current.

Configure project settings:

4.
  - a. Navigate to **Edit** and **Project Settings...**
  - b. Navigate to **Engine** and **General Settings** in the left panel.
  - c. Set **Timecode Provider** underneath the **Timecode** separator to **RenderStreamTimecodeProvider**.
5. Rebuild lighting if required (Unreal Engine may display errors at this point but it will recover).
6. Save and close Unreal Engine.
7. Open the RenderStream Layer in Disguise software and Start the workload.
8. Play your timeline within Disguise software.

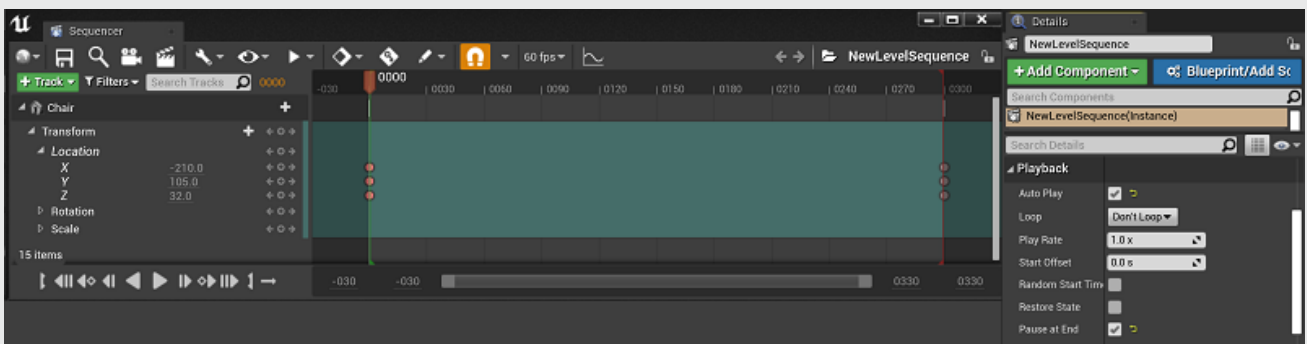

# Remote Texture Sharing

Textures can be shared between Disguise software and Unreal Engine.

The Unreal Engine plugin offers support for the sharing of textures remotely through the use of exposed parameters. This allows a two-way flow of video content between Disguise software and the Unreal Engine.

## Remote Texture Sharing

Follow these steps to configure:

1. [Optional] Add a Plane (or any other 3D object) to the scene.
2. Create a new Render Target and Material:
  - Right-click inside the Content Browser and select Materials & Textures → Render Target.
  - Drag and drop the new Render Target onto your Plane (or 3D object of your choice).
  - Confirm that a new Material has been created for the Render Target.
  - Confirm that the new Material has been set as a material element in the 'Materials' component of your object.
3. Expose the Render Texture as a remote parameter:
  - Click 'Blueprint' in the Toolbar and select 'Open Level Blueprint'.
  - Click the 'Add' button next to Variables within the My Blueprint panel.
  - Name the variable according to the desired property (e.g. Render Texture).
  - Select the variable.
  - Set the 'Variable Type' in the Details panel to Texture Render Target 2D.
  - Enable 'Instance Editable'.

- [Optional] Set 'Category' to the name of the menu you wish the parameter to appear under in the RenderStream Layer.
  - Compile.
4. Set 'Default Value' to the Render Target.
  5. Save and close Unreal Engine.
  6. Open the RenderStream Layer in Disguise software and Start the workload.
  7. Create a new layer (e.g. Video) and assign media (e.g. Ada).
  8. Move the new layer underneath the RenderStream Layer with Ctrl+Alt+down arrow.
  9. Alt+drag to arrow the newly created layer into the RenderStream Layer.
  10. Confirm arrowed input appears in the RenderStream content.

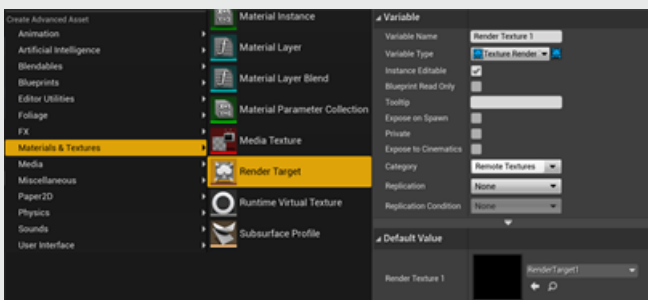

Screenshot showing how to create a Render Target and expose a corresponding variable.

# Remote Text Parameters

This topic covers the steps needed for configuring text within Unreal Engine for use with RenderStream.

## Text Parameters

This feature allows you to render text in the Unreal Engine scene that can be changed live in Disguise software.

Follow these steps to configure:

1. Start by adding a "Text Render" actor. this will give you the ability to generate text in the scene.
2. Notes: It can be helpful to change the colour of the text so that it stands out from the scene.
3. Open the level Blueprint and then drag "Text Render Actor" into the Blueprint.
4. Drag from the blue pin of the "Text Render Actor", this will then prompt you to choose a new action.
5. Search for "Set Text".
6. Once added you will now find a Set Text action; right click on Value and select the option to "Promote to variable".
7. Select the newly created Value node, this will open the details panel where you can edit aspects of the variable.
8. Check the box for "Instance Editable".
9. Add an EventTick to the Event Graph, and link this to the input of the Set Text action.
10. Now Compile the Blueprint, this will now give you an option to set the default values in the Text Variable.
11. Save and Compile the Blueprint
12. This will now give you the ability to edit the text from Disguise software.

# Scene Levels and Maps

This topic covers how levels and maps can be configured within an Unreal Engine scene for control via RenderStream

The Unreal Engine plugin allows you to generate scenes from either Levels or Maps within a project. This functions similarly to how the 'Effects' parameter in Notch blocks work.

## Scene selector

Levels/Maps in Unreal Engine (UE) can be composed of any number of actors. There are three options for deciding how scenes will be generated from your Unreal Engine project:

**None** - this offers no scene control and simply merges all Levels of your default Map into a single persistent level.

**Streaming Levels** - this option generates scenes from all Levels/Sub-levels within your default Map. The Actors within a Level other than the persistent level are unique to that level. The Actors within the persistent level are shared across all levels. Parameters exposed in levels other than the persistent level will only be available when the corresponding scene is chosen in the RenderStream layer. Parameters exposed in the persistent level will be available across all scenes in the RenderStream Layer.

**Maps** - this option generates scenes from all Maps within your project. The behaviour of Actors and exposed parameters with this option selected, is similar to that described for 'Streaming Levels'.

To use this functionality:

1. Select **Edit** and navigate to **Project Settings...**
2.
  - a. Navigate to **Plugins/ disguise RenderStream** in the left panel.
  - b. Set **Scene Selector** accordingly.
3. Create a sub-level:
4.
  - a. Return to the scene.
  - b. Select any Actor from the World Outliner panel (e.g. Chair).
  - c. Select **Window** followed by **Levels** from the scene window.
  - d. Click the **Levels** dropdown and select **Create New with Selected Actors**.
  - e. Name the level and save.
  - f. Rebuild lighting if required (Unreal Engine may display errors at this point but it will recover).
5. Save and close Unreal Engine.
6. Open the RenderStream Layer in Disguise software and **Start the workload**.
7. Modify the **Scene** parameter.

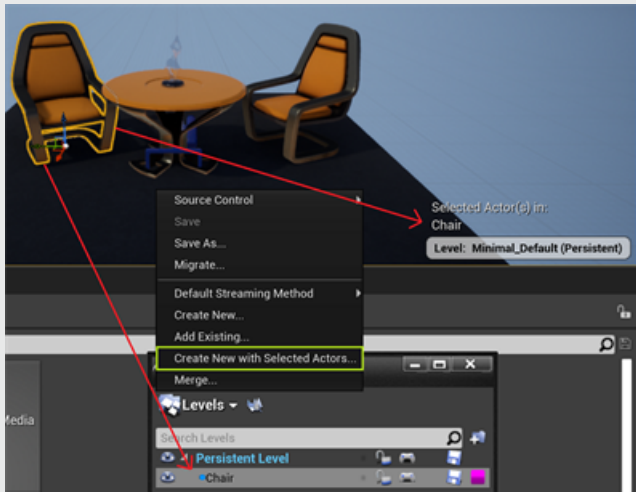

## Notes:

- When using the **Maps** Scene Selector option, all maps within your Unreal Engine project must be loaded in the Editor at least so that they are cached. If they are not loaded at least once, they will not appear within the scene selection.
- When using the **Maps** Scene Selector option, sublevels are handled differently compared to when the **Streaming Levels** option is selected.
  - » **Maps** will only display the Actors present within a sublevel and not include those in any parent levels.
  - » **Streaming Levels** will display the Actors present within a sublevel as well as those included in any parent levels.
- When using the **None** Scene Selector option, the scene Unreal will present when a workload is started will always be the **Game Default Map** set within the project settings (unless otherwise specified using the Custom Options field).

# Level Loading Best Practices

## Level Streaming Mode



The Level Streaming Mode can be found in the **Project Settings - Plugins - Disguise RenderStream** .  
There are three options to choose from:

### — **Level Streaming**

- » The current Level Streaming system is designed for lightweight levels. It gives the user the ability to switch seamlessly between Unreal Engine levels. When correctly optimized.
- » Level streaming should be used when switching time is essential, most often on live shows featuring transitions and multiple scenes.

### — **Maps**

- » The Maps system is designed for heavier Unreal Engine Level structures, and should be utilised if switching between levels seamlessly isn't required
- » Maps mode uses the Unreal Engine Map switching functionality. Allowing multiple "Persistent" Level hierarchies to be loaded directly from Disguise.
  - » Persistent Level
    - » Main Level One
      - » Sublevel A
      - » Sublevel B
      - » Sublevel C
    - » Main Level Two
      - » Sublevel D
      - » Sublevel E
      - » Sublevel F

- » Outside of Disguise Persistent Level Hierarchy
  - » Often this is employed in Film and Episodic shoots, allowing the operator to switch between levels without restarting the Cluster. But without the need for speed

## None

- » This loads functionality based on the Default Editor Map. Any level switching, loading, and visibility has to be programmed inside the Persistent Level. Disguise RenderStream has no direct effect on the loading and visibility of Levels in this mode.
- » This is the recommended mode for custom loading and unloading functionality, often associated with game setups.

# Multi-User Editing

This topic covers the steps needed for configuring Multi-User editing within an Unreal Engine project.

With some modifications to the project settings, the Unreal Engine plugin offers live multi-user editing. If a Multi-User Server is configured and running, any additional machine on the same network as the render nodes will be able to run the project in Edit mode and make live changes. Any changes to the project made while there is an active workload will be reflected in real-time.

## Multi-user editing

Configuring multi-user editing in the Unreal Engine project:

1. Go to **Edit** and navigate to **Plugins**, enable **Multi-User Editing** plugin.
2. Go to **Edit** and navigate to **Project Settings...**
3. Navigate to **Plugins** and **Multi-User Editing**.
4.
  - a. Ensure **Enable Multi-User Toolbar Button**, **Auto Connect** and **Retry Auto Connect on Error** are enabled.
  - b. Set the **Default Server URL** to the name of the machine that will be running the Multi-User Server (e.g. "NDISPLAY-4").
  - c. Set **Default Session Name** to something unique (e.g. "MUS").
5. Save and close Unreal Engine.
6. Distribute modified project to all nodes (this can be done through Disguise software).
7. Launch the Multi-User Server on the machine specified as the **Default Server URL** (either launched standalone UnrealMultiUserServer.exe or through the Unreal Editor).
8. Make sure the server is visible on the network the nodes are connected to.
9. Open the RenderStream Layer in Disguise software and **Start the workload**.
10. Connect to the Multi-User Server using an editor and make modifications.

**Please note:**

The project's Preferred Sync Adapter must be set to a network accessible by all required machines.

For more information on configuring Multi-User Editing, including network and UDP messaging settings in Unreal, please refer to the [Unreal-Engine-Remote-Multi-User-Editing-Guide](#)

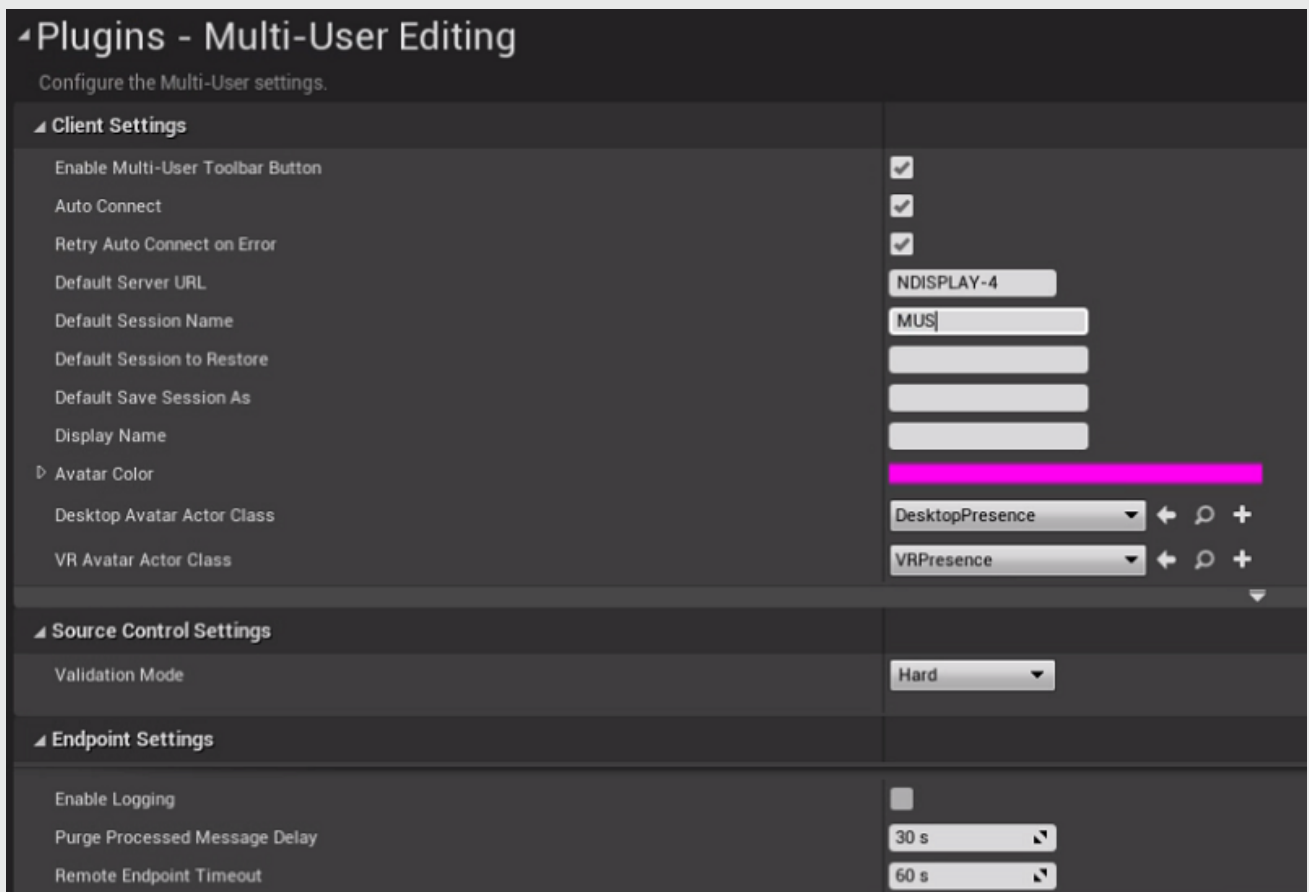

# Shared DDC setup

This topic covers the steps needed for configuring a shared Derived Data Cache - a "DDC" - to improve the startup speed of an Unreal Engine project shared across a RenderStream network.

The DDC is where shaders for Unreal Engine projects are compiled and stored. You may have noticed when opening a new project on a standalone workstation or on a Disguise render node that shaders need to compile for quite some time, even if the project is very simple.

One of the benefits of working with identical, standardized hardware like the Disguise rx range of render nodes is that the DDC can be compiled on one machine and then shared across a network to other nodes in the RenderStream cluster, eliminating the need to individually compile shaders on each render node.

## Setup Overview

1. Create a DDC folder and share it to the network
2. Mount the DDC folder as a drive from each render node
3. Change local and shared DDC paths on the Windows level in Windows Environment Variables
4. In the Unreal Engine project settings (UE Editor), configure all render nodes to look for the shared DDC folder.

**Please note:** It is helpful to have some knowledge of Windows 10 networking in order to achieve this.

# Example

For our example, we will be using the following configuration:

- vx 2 Director (vx-101)
- vx 2 Actor (vx-102)
- rx II (rx-204)
- rx II (rx-205)
- rx II (rx-206)

**Please note:** Your network configuration will vary depending on your system.

1. Create a DDC folder.

You can create the DDC folder wherever you want, but in our example, we will be using the D drive of our vx 2 Director (vx-101). We have chosen the D drive because this drive will not be affected by the server reimaging process, and we want to keep our storage on the render nodes open for RenderStream project files.

2. Share this folder to the network by right clicking it and selecting Properties > Sharing > Share.

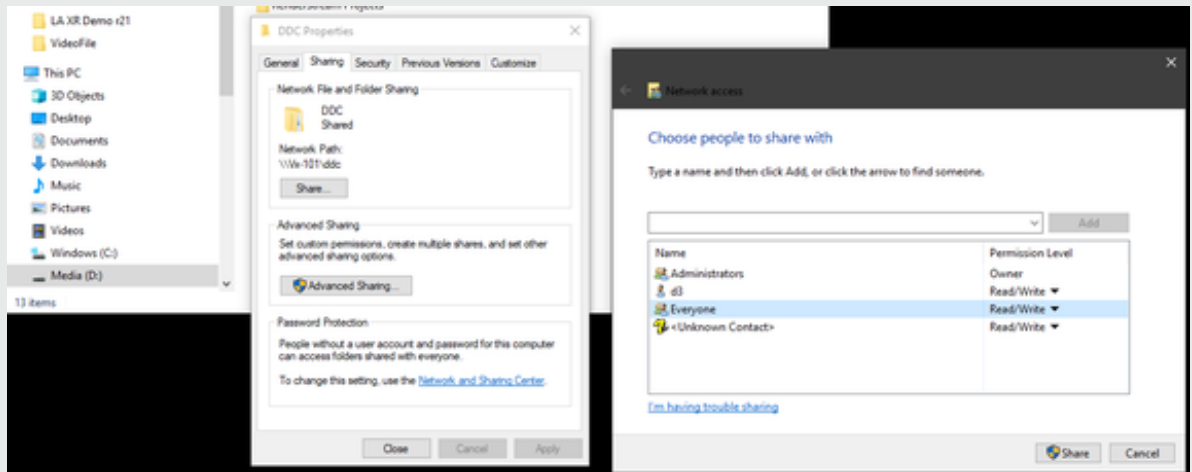

**Please note:** Inside the Share menu, your options may vary. For our example, we are sharing to “Everyone”. However, the IT infrastructure in your facility may affect this. If you try various sharing options and still are not able to see your DDC folder on other machines, you may need to consult with your IT Department.

3. Select your share group and make sure the Permissions say Read / Write, then click the Share button. Your DDC folder should now be shared to the network.

The next step is to mount the DDC folder as a drive from each render node. For a Shared DDC, it is necessary to mount the folder as a drive with a letter assignment from each render node. We will start with our first render node, rx-204.

1. From the first rx machine, open the File Explorer and scroll down to the Network tab on the side bar. The vx-101 machine will be visible from here. If not, it may be necessary to search for it in the top bar by manually typing:

**\\machinename\nameofddcfolder**

In this example, that looks like:

\\vx-101\ddc

**Please note:** If the DDC folder cannot be found, or if it can be found but not accessed, go back to Step 1 and try sharing the DDC folder with different permissions. You cannot proceed to the next steps without being able to access this folder from your render nodes.

2. Right click on the DDC folder and select Map network drive. From the “Drive” list, select any available letter. For our example, we will select R: for RenderStream.

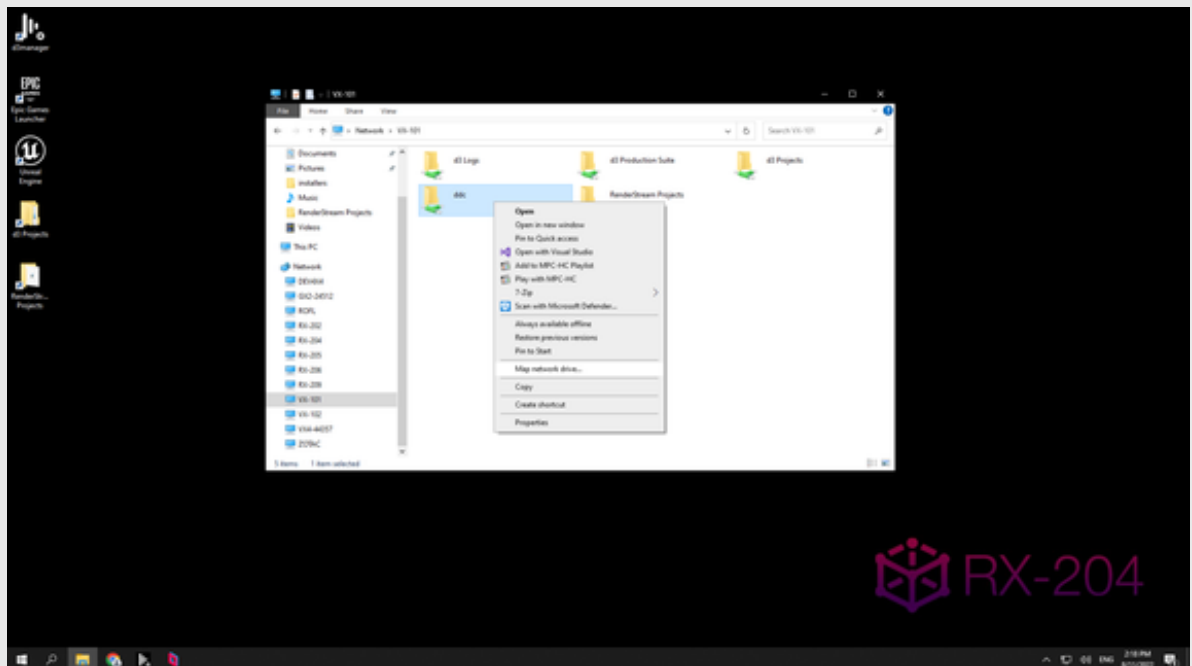



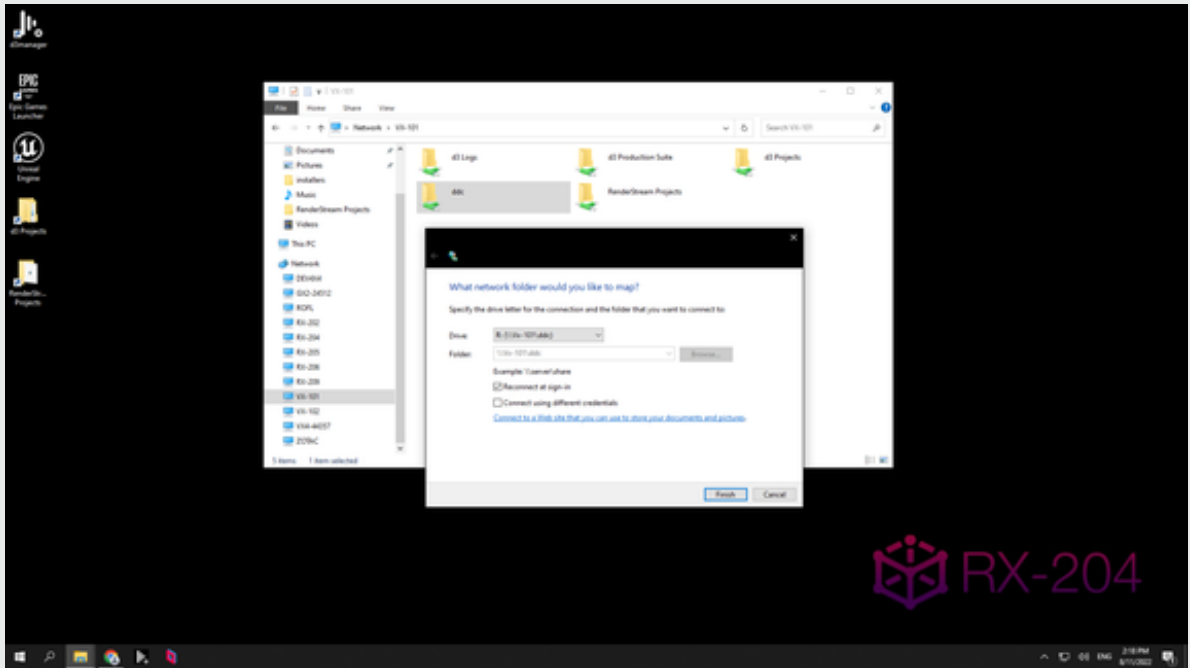

Following these steps, the DDC folder should now be mapped as drive R: to rx-201. Repeat these steps for all other render nodes.

**Please note:** For organizational purposes, we recommend mapping each render node to the same drive letter.

The next step is to change DDC paths on the Windows level in Environment Variables from each render node. Follow these steps:

1. From your first rx machine, click on the Windows key in the bottom left corner of the screen. Select **System > About** and navigate to **Advanced system settings**. A pop-up window titled System Properties will appear. Click on **Environment Variables**.



2. In the Variable name line, enter **UE-SharedDataCachePath**
3. In the Variable value line, enter the location of the shared DDC folder. You can do this by manually typing it in or using the Browse Directory or Browse File buttons to navigate to correct place on the network.

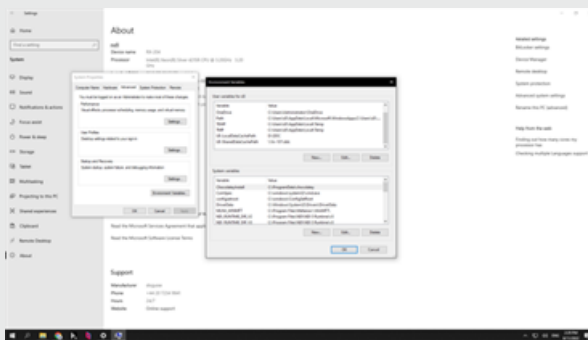

If you would like to change where local DDC is stored, you may do that here as well. For example, if Unreal Engine is installed to your C drive, but you are running out of space for cache there, you can change the local cache storage to the D drive:

In the **Variable name** line, enter **UE-LocalDataCachePath**

In the **Variable value** line, enter **D:\DDC**

4. Repeat these steps for all other render nodes.

The next step is to configure all render nodes to look for the shared DDC folder from inside the Unreal Engine Project Settings (UE Editor). Follow these steps:

**Please note:** This step is the same for Unreal Engine 4 and Unreal Engine 5.

1. Open any project in Unreal Engine. Navigate to the top menu bar and select Edit > Editor Preferences. In the top search bar, type DDC or use the left menu bar to navigate to General > Global > Derived Data Cache.
2. Under Global Network DDC Path (UE 4) or Global Shared DDC Path (UE5), type R: (or a different drive letter if you mapped your DDC folder differently), then hit Enter on the keyboard to force Unreal Engine to take the change. Unreal will prompt you to restart the software. Select Restart Now.

**Please note:** Global Network DDC Path / Global Shared DDC Path will affect all projects on the computer. If you wish to individually control where DDC is shared for each project, use the other project-specific options.

3. Repeat this individually on each render node. Editor Preferences are not able to sync across nodes using third-party sync software.

# Testing DDC

On the render node of your choice, open the Unreal Engine project you would like to launch. Confirm that all shaders compile completely, then Save and close.

From the RenderStream Layer in Disguise software, launch the same project file. If the DDC folder has been shared and configured correctly, then shaders should not need to compile on the other render nodes. Your project should start and launch.

To learn more about using Derived Data Cache, read Epic's official documentation [here](#).

# Scene Optimization

This topic covers best practices when configuring scenes within an Unreal Engine project for use with RenderStream.

Here are several useful tips and best practices for optimizing your Unreal Engine scenes for use with RenderStream.

## Alpha

Tips for using Alpha with Unreal Engine assets

- Alpha content should be set to **Premultiplied Alpha** in Disguise.
- PostProcessingMaterials do not support alpha from Unreal Engine.
- Set post processing and effects quality to high/cinematic/epic.
- Atmospheric fog will need to be disabled in channels rendering front plate alpha.
- When a monitor is connected to a render node, ensure that there is 100% scaling to the native resolution. A second monitor can be used as the review screen if the GUI must be scaled.
- Ensure there are no sky domes or full frame effects in the frontplate channels.
- r.SceneColorFormat must be set to 4.
- Turning on/off alpha or modifying the transport configuration in any other manner for Unreal assets will cause a shader recompilation and may take a considerable amount of time before the content is visible within Disguise software.

- Try hiding post processing methods one by one within the RenderStream Layer as a troubleshooting test if you are not getting alpha through.



**Warning:** Turning on alpha or modifying the transport configuration in any other manner for Unreal assets will cause a shader recompilation and may take a considerable amount of time before the content is visible within Disguise software. This process will be reflected within the Workload status widget.

## Limitations

Limitations of using certain Unreal Engine effects with RenderStream.

There are a number of default options in Unreal Engine that are not suitable for use with any splitting strategy in a Cluster pool. In some cases this is because the whole image is required to be present in order to work; this can sometimes be mitigated with padding and overlap, but this must be evaluated on a case by case basis. In other cases it is because additional buffering is required.

The RenderStream Channel Definition component settings contain flags allowing many of these to be enabled / disabled on a per-channel basis.

Below is a non-exhaustive list of such effects:

- Depth of Field
- Bloom
- Vignette
- Lens Flare
- Temporal Anti Aliasing (TAA)
- Screen Space Global Illumination (SSG)
- Screen Space Ambient Occlusion (SSAO)

- Screen Space Reflections (SSR)
- Raytracing (denoiser)
- Chromatic Aberrations
- Eye Adaption
- Motion Blur



**Warning:** Many features within Unreal Engine will not work with nDisplay, specifically nodes that require determinism. Consult the Unreal Engine Help guide for more information.

## Post Process Volume

By default, Unreal Engine automatically sets the exposure of a map's **PostProcessVolume**. This can cause the exposure of split frames to be different, revealing a noticeable seam between frames. To correct this here are some suggested settings:

- Expand the Lens property of **PostProcessVolume**.
- Expand Exposure
- Change the Metering mode to **Manual**
- Adjust the Exposure Compensation
- Exposure Compensation can either be a user defined float value appropriate to the scene, or a Float Curve can be applied.
- Be aware there are exposure settings within camera and cinemachine objects; ensure they are set to manual exposure as well.



**Warning:** This currently does not notify the user that changes made to the PostProcessVolume may have caused the project to become out of sync across the machines within the Cluster Pool. Therefore, any changes to it must be saved and the project re-synchronised to all machines.



# AR workflow

## Overview

AR content from a generative content engine, such as Notch, can be placed in the 3D scene overlaying existing video content or a live video input using this workflow.

## AR Workflow

1. Create an MR set
2. Create a virtual camera(s)
3. Create an LED screen on the stage, check that the Render Layer (located in the Output tab of the layer) is set to 'On Stage'
4. In the MR Set properties editor, add the LED surface to the MR set, create an indirection controller, and select the virtual camera(s) as the resource.
5. Create a Notch Layer and select the desired Notch block that you want to use as an AR object
6. Create a Spatial mapping for the Notch layer and add the virtual camera(s) as a screen
7. Set the Camera plate of the Spatial mapping to Backplate

At this point, you will see the AR object in the Camera transmission preview and the MR Set

# preview windows

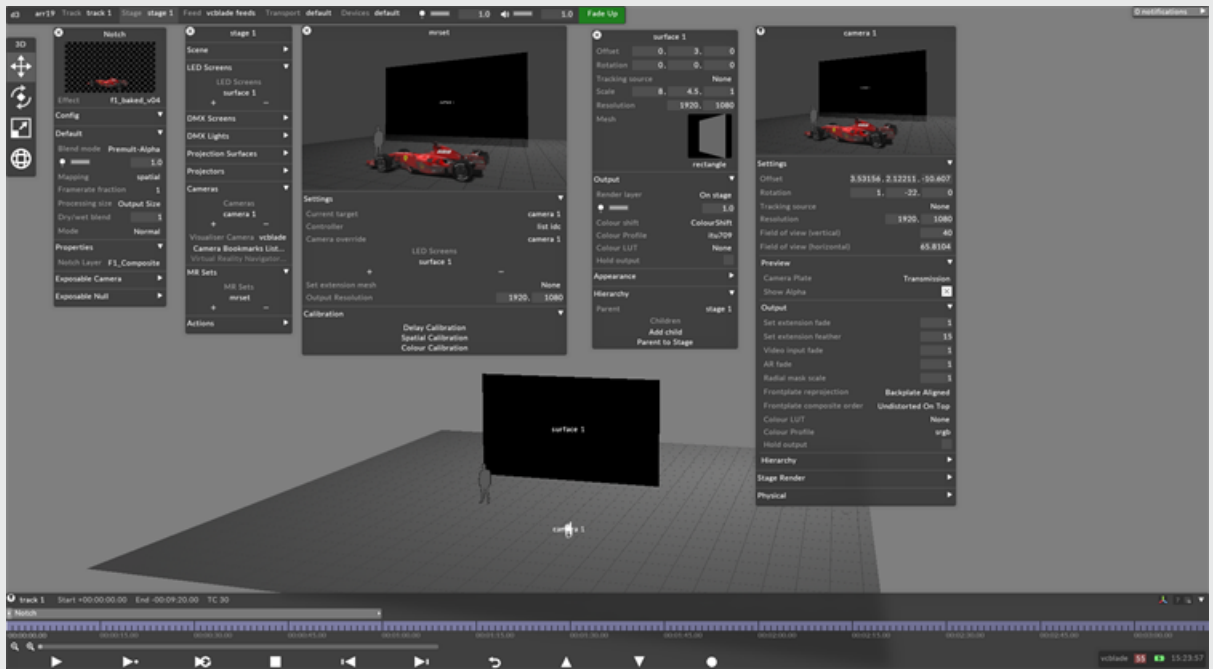

# 3D fundamentals overview

This sub-chapter will teach you the fundamental knowledge necessary to prepare 3D models for Disguise software.



*The London Ralph Lauren Flagship Store in Disguise software.*

# Understanding .obj files

An .obj file is a format containing data for an object's vertices, polygons and texture coordinates.

The image below shows a Disguise project containing common .obj files which can be separated into two categories: **Screens** and **Props**. A Screen is an object representing a **video display**, for example a projection dome, and requires a **UV map** to display video content. A Prop is an object representing a **scenographic element**, for example a theatre venue, and does not always require a UV map. To read more about where to place media, see the [Placing media files for a project](#) page. To read more about UV mapping, see the [What is UV mapping](#) page.

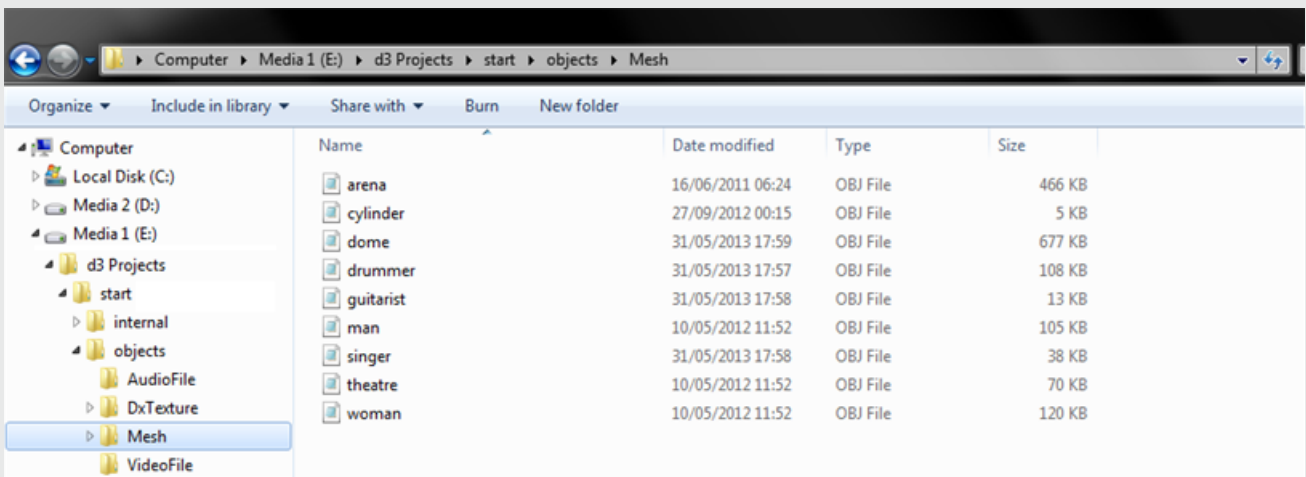

Common .obj files contained in the Disguise Start project.

## Helpful Resources

- [Wavefront OBJ File Format Summary](#)

# Exporting 3D models

Disguise software supports the .obj format for 3D meshes. This topic covers the .obj export settings unique to Blender, 3ds Max, Maya, and Cinema 4D, which should be followed to ensure the object is exported to the disguise software correctly.

## 3D Models Overview

Custom 3D models can be loaded into your project and utilized for previsualisation. These models be used as either display surfaces or as props. The supported format for a 3D model is .obj.

Custom 3D objects can either have a baked in **UV unwrap**, or not. Objects with a **UV unwrap** can be used as screen objects to display content, while non-unwrapped ones can only be used as Prop objects used for the visualiser.

Outlined in these tabs are the needed export settings for a custom OBJ to be used in disguise.

**Please note:** Other types of 3D objects known as Alembic files can also be imported into Disguise software; these types of objects included animation that can be triggered from within Disguise software. For more information on these types of files, please visit this link: [Alembic files](#).

## Blender

### Blender Export Settings

1. Select the object to be exported from the 3D application. Note that the selection can not contain any scene elements such as lights or cameras.
2. Select the 3D application's export utility.
3. Select the .obj format from the list of available formats.

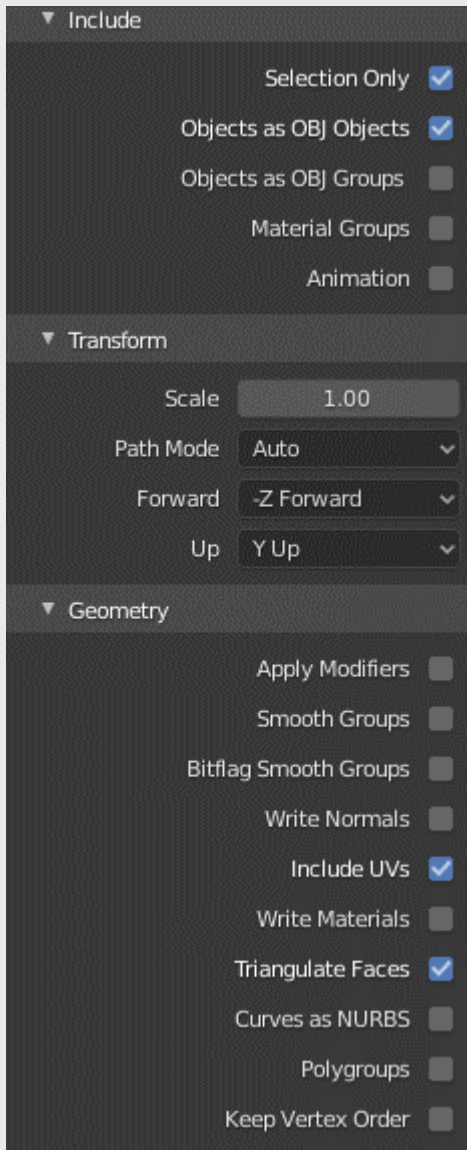

*Export settings for Blender*

## Maya

### Maya Export Settings

1. Select the object to be exported from the 3D application. Note that the selection can not contain any scene elements such as lights or cameras.
2. Select the 3D application's export utility.
3. Select the .obj format from the list of available formats.

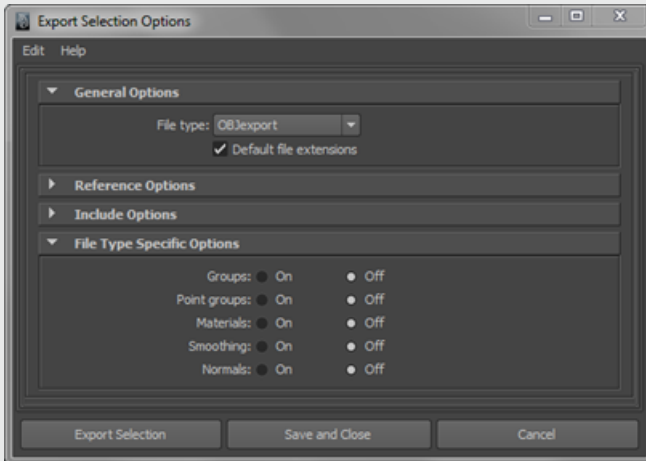

Export settings for Maya

## 3ds Max

### 3ds Export Settings

1. Select the object to be exported from the 3D application. Note that the selection can not contain any scene elements such as lights or cameras.
2. Select the 3D application's export utility.
3. Select the .obj format from the list of available formats.

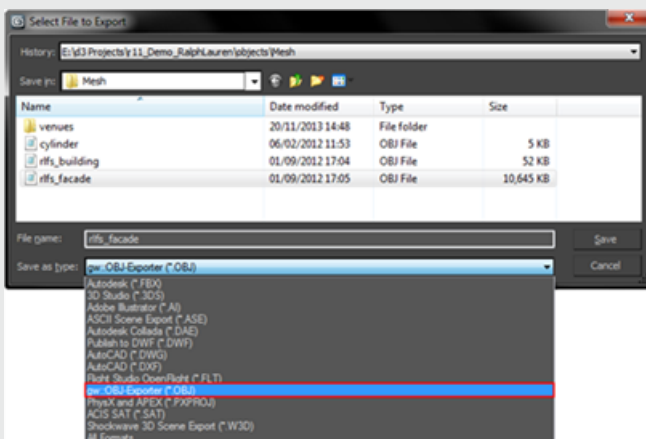

— Deselect **shapes, lines, hidden objects, normals, smoothing groups, material, and material libraries**. Disguise does not support these.

- If the object is to become a screen or a textured prop, select **texture coordinates**, which will export the object's UV map.
- Select **flip yz-axis** to ensure the object is orientated correctly in Disguise software.

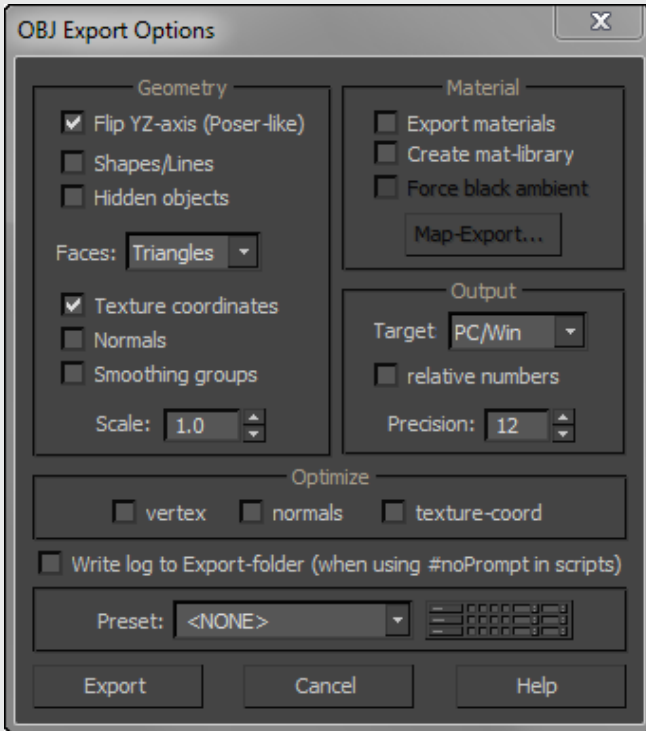

*Export settings for 3ds Max*

Save the **.obj** file in the Disguise Project folder in the following directory: **Projects > Project Name > objects > Mesh**.

To read more about where to place media, see the [Placing media files for a project](#) page.



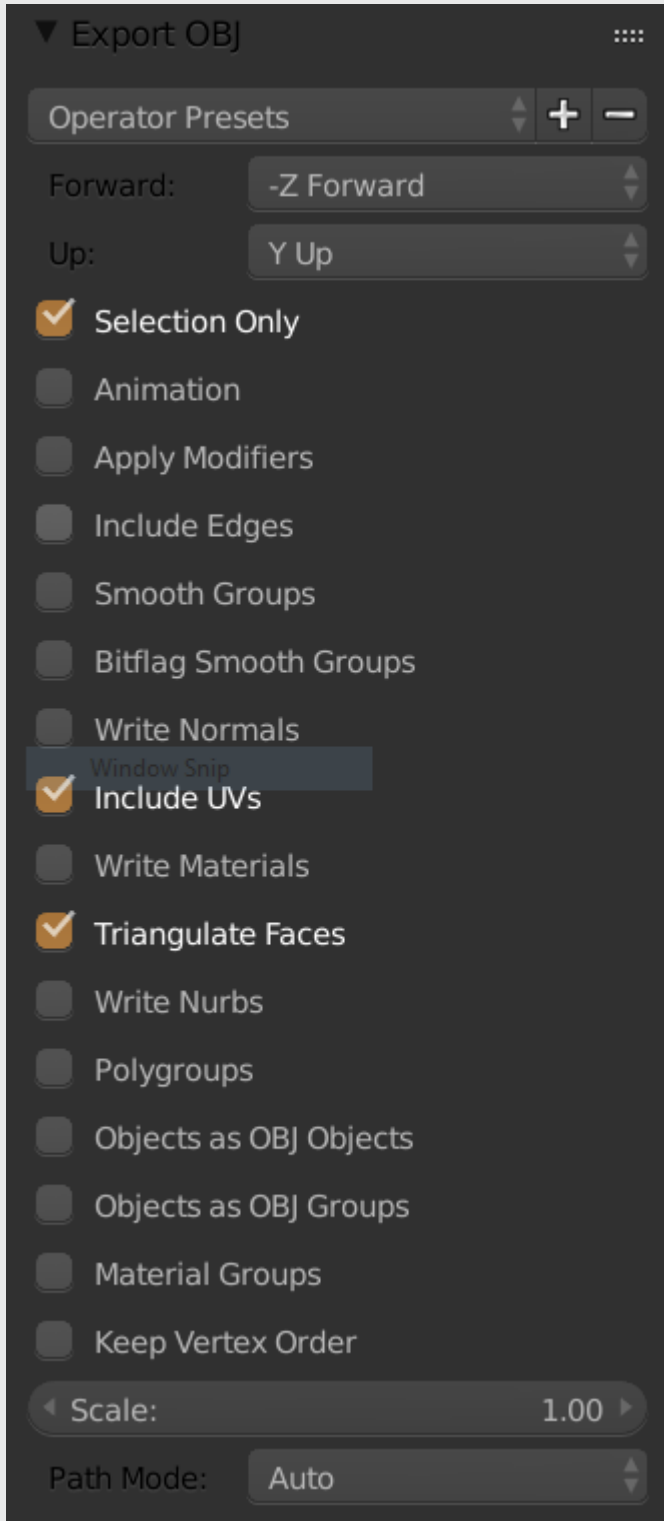

*A list of .obj files exported from 3ds Max to a Disguise Project folder.*

**Please note:** We recommend triangulating faces before exporting models for use in Disguise software.

# Cinema 4D

## C4D Export Settings

1. Check the project settings are set to scale in **meters** (C4D defaults to cm).
2. Select the object to be exported from the 3D application. Note that the selection can not contain any scene elements such as lights or cameras.
3. Select the 3D application's export utility.
4. Select the .obj format from the list of available formats.

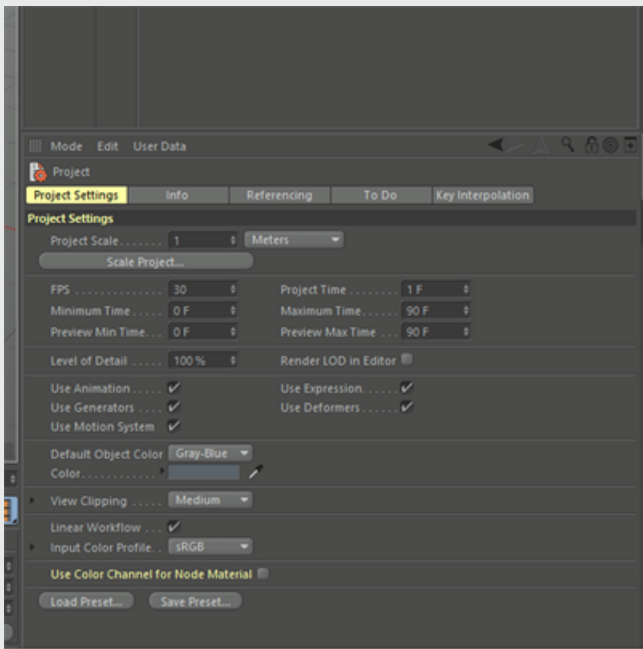

Export settings for C4D

# Optimising 3D models

When preparing objects for Disguise software there are a number of processes to consider.

- Objects should be **divided** into Screens and Props.
- Screens should only include the surfaces necessary to **display** video content and may require remodelling by detaching or deleting unnecessary polygons.
- Detached objects can be used in Disguise software as props, which are helpful for **simulating** a show in the Stage visualiser to present to the client.
- Objects should not exceed 150,000-200,000 vertices and may require remodelling by **welding** unnecessary vertices.

## Dividing 3D models into screens and props

In a 3D application an object can be **detached** into multiple sub-objects. This is necessary when dividing a 3D model into screens and props for Disguise software. Screens are video displays such as LED panels, projection surfaces and DMX fixtures, and props are scenographic elements such as audience seating, stage floors and truss pieces.

## Screens

A new Disguise project contains the following **.obj** files to be used as screens:

- **rectangle.obj**
- **cylinder.obj**
- **concave.obj**
- **dome.obj**

**Please note:** the **rectangle.obj**, **concave.obj** and **puffersphere.obj** file is generated in the software and is not visible in the mesh library.

Complex screens, for example a building or a car, require 3D modelling and UV mapping tools available in 3D applications. For further information see the [LED screen examples](#) and the [Projection screen examples](#).

## Props

Parts of an object which are not required to display video content can be used in Disguise software as props. The image below shows the Ralph Lauren London Flagship Store **divided** into two sub-objects: a screen to display video content and a prop to simulate the building's top and bottom. In Disguise software a prop can be customised to simulate the object more realistically including the ability to map paint textures to it. For further information see the [Editing Props](#) page.

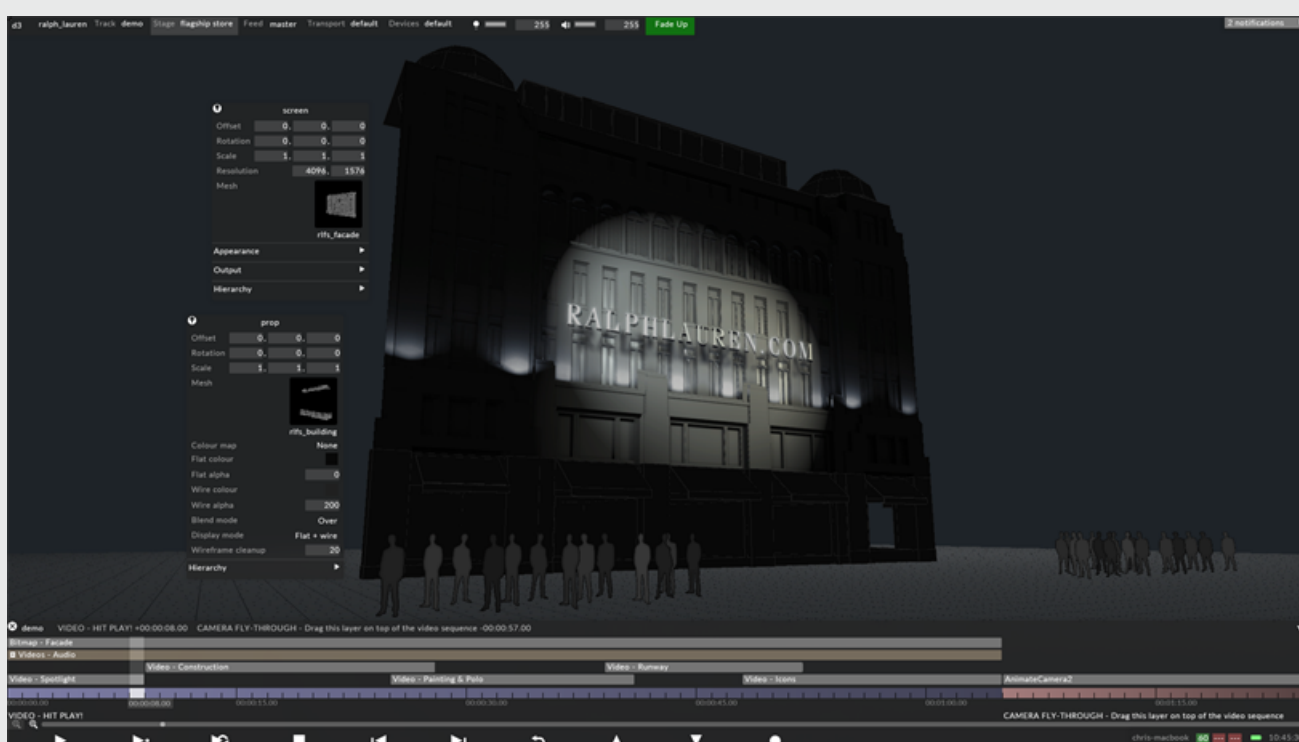

The Ralph Lauren Flagship Store divided into a screen and a prop in Disguise.

## Deleting overlapping faces

Delete all **overlapping** faces from the object. It is important to understand when video content is mapped to the screen in Disguise software, any surfaces with overlapping faces will display overlapping content. To test this, map a [Radar](#) layer to the screen.

## Reducing the number of vertices

In Disguise software, the Stage should not exceed 150,000-200,000 vertices. It is recommended to reduce the total number of vertices by **welding** them together, which should be done in a 3D application. Be careful not to delete too many vertices because this may lower playback **quality**, but on the other hand too many vertices may lower playback **performance**. A balance between quality and performance is necessary.

**Please note:** during a live show it is recommended to remove props from the Stage in order to optimise playback performance. For further information see the [Creating and removing props](#) page.

## Helpful resources

### 3ds Max

— [Support and learning](#)

### Maya

— [Support and learning](#)

# Orientation

When preparing objects for Disguise software they should be orientated accurately.

- In the 3D application rotate the object in a **south-north** direction. Doing so will help ensure the object is clearly viewed from the camera's home position in Disguise software, which can be enabled by selecting the **F12** button.

To read more about camera controls, see the [Navigating Stage](#) sub-chapter.

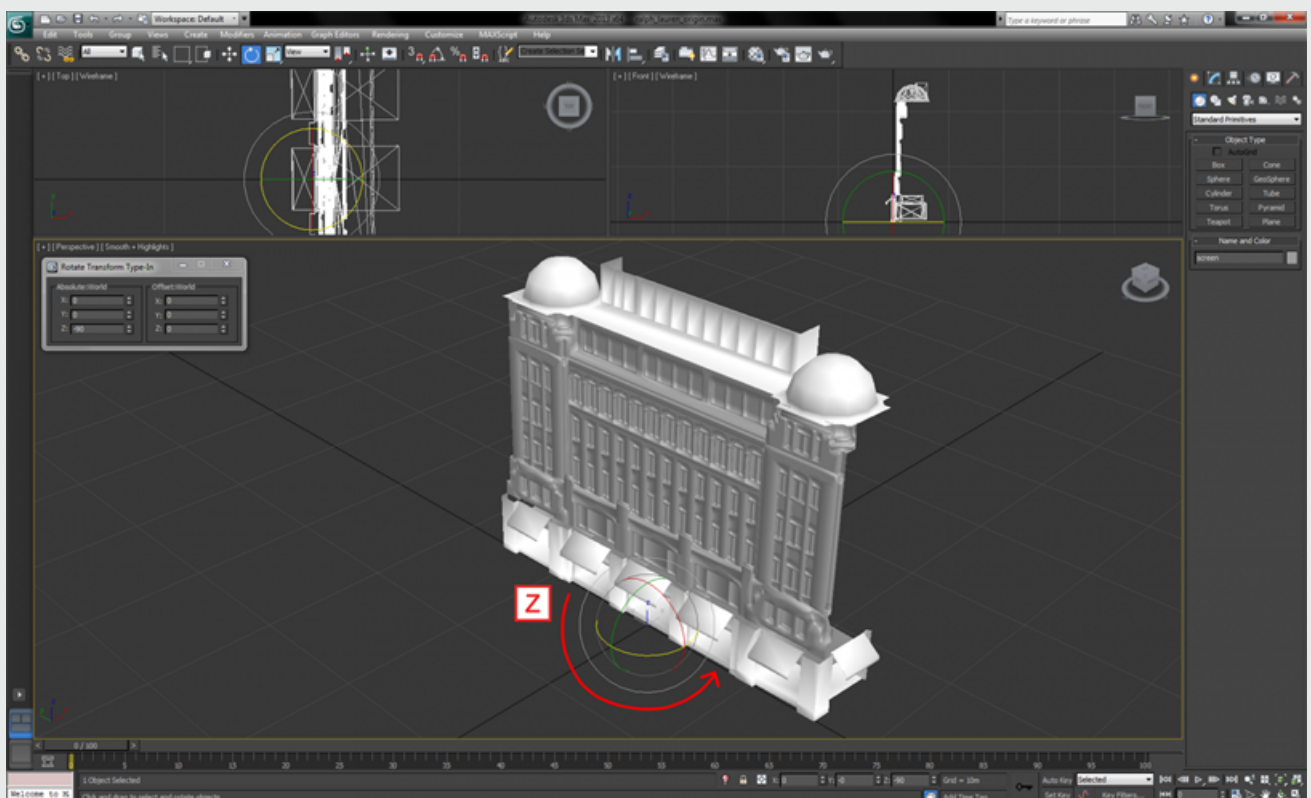

*The Ralph Lauren London Flagship Store orientated incorrectly in 3ds Max, set in a west-east direction.*

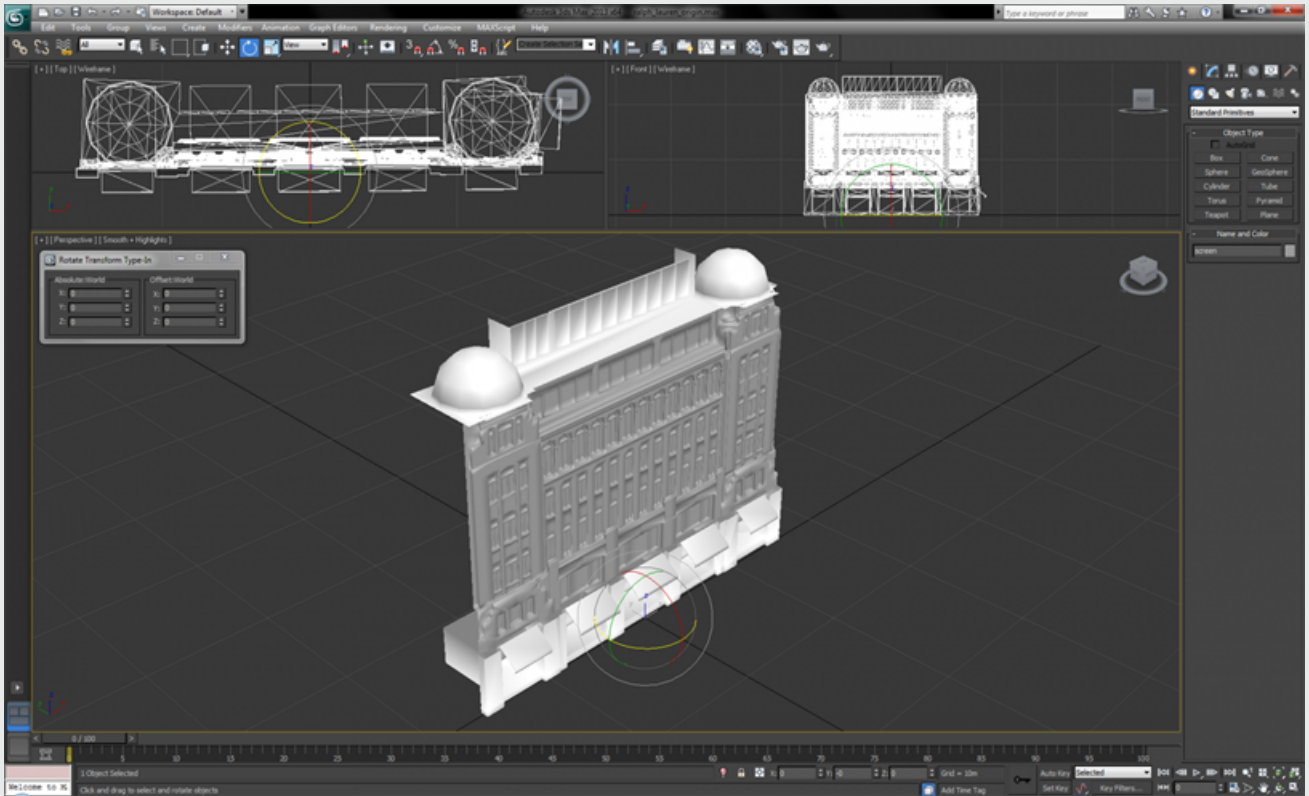

*The Ralph Lauren London Flagship Store orientated correctly in 3ds Max, set in a south-north direction.*

## Helpful Resources

### 3ds Max

- [Support and learning](#)

### Maya

- [Support and learning](#)

# Position

When preparing objects for Disguise software they should be positioned accurately.

- In the 3D application align the object to the scene's **origin**. The origin is **0,0,0** in 3D space corresponding to the **x,y,z** axes.
- It is highly recommended to align the object's base to the origin on the **vertical** axis. Doing so will help ensure the object's vertical position can be easily referenced in Disguise software, which is particularly helpful during projector calibration.

## Pivot points

The **.obj** file format does not save pivot points. Therefore, before exporting objects to Disguise software it is important to understand if and how the object should rotate.

- If the object should rotate around the origin, then in the 3D application **offset** the object from the origin before exporting it to Disguise software.
- If the object should rotate around a pivot point, then in the 3D application **align** the object's pivot point to the origin before exporting it to Disguise software. In the software, the object can be offset to any position and it will always rotate around this pivot point.

For further information see the [Exporting 3D models](#) page.



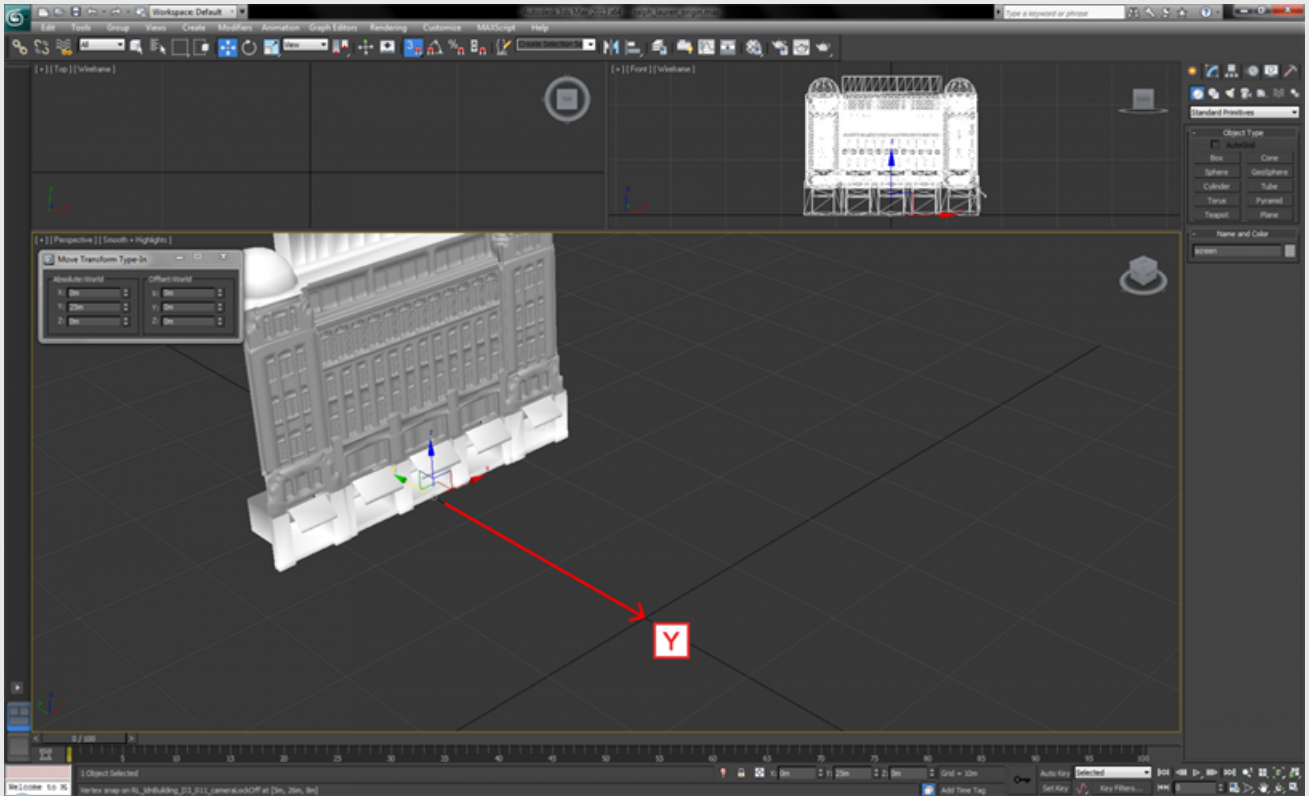

The Ralph Lauren London Flagship Store offset from the origin in 3ds Max.

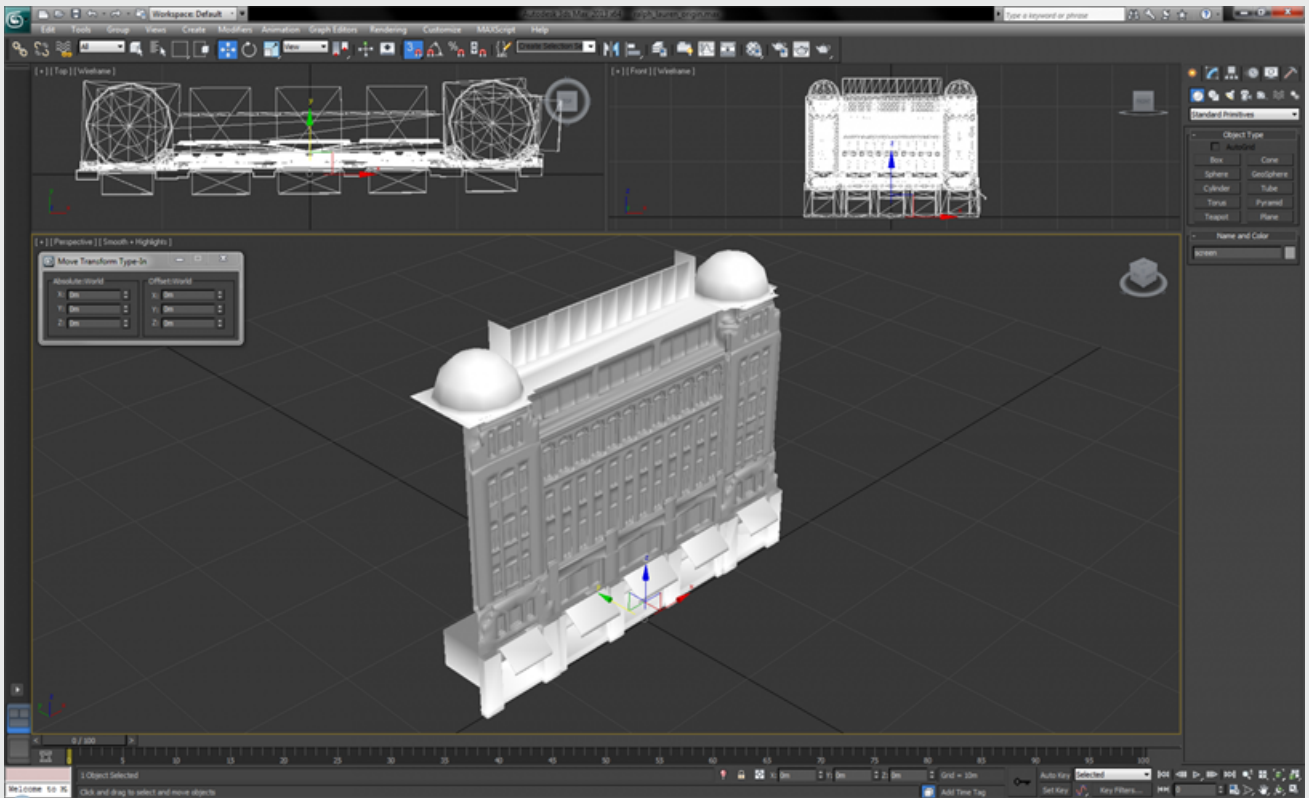

The Ralph Lauren London Flagship Store aligned to the origin in 3ds Max.

# Helpful Resources

## 3ds Max

- [Support and learning](#)

## Maya

- [Support and learning](#)

# Scale

When preparing objects for Disguise software they should be scaled accurately.

- In the 3D application set the system unit to **metres**, because Disguise software automatically rescales objects to metres. Doing so will help ensure the object is correctly scaled. If working in feet and inches, you should rescale the object to metres **before** exporting it to Disguise software.
- If the object in Disguise software is too large or too small it can be rescaled using the Screen editor.

**Please note:** Maya only exports objects to **centimetres** and therefore in Disguise software they are rescaled 100:1. To avoid this, before exporting the object to Disguise, rescale it 1:100.

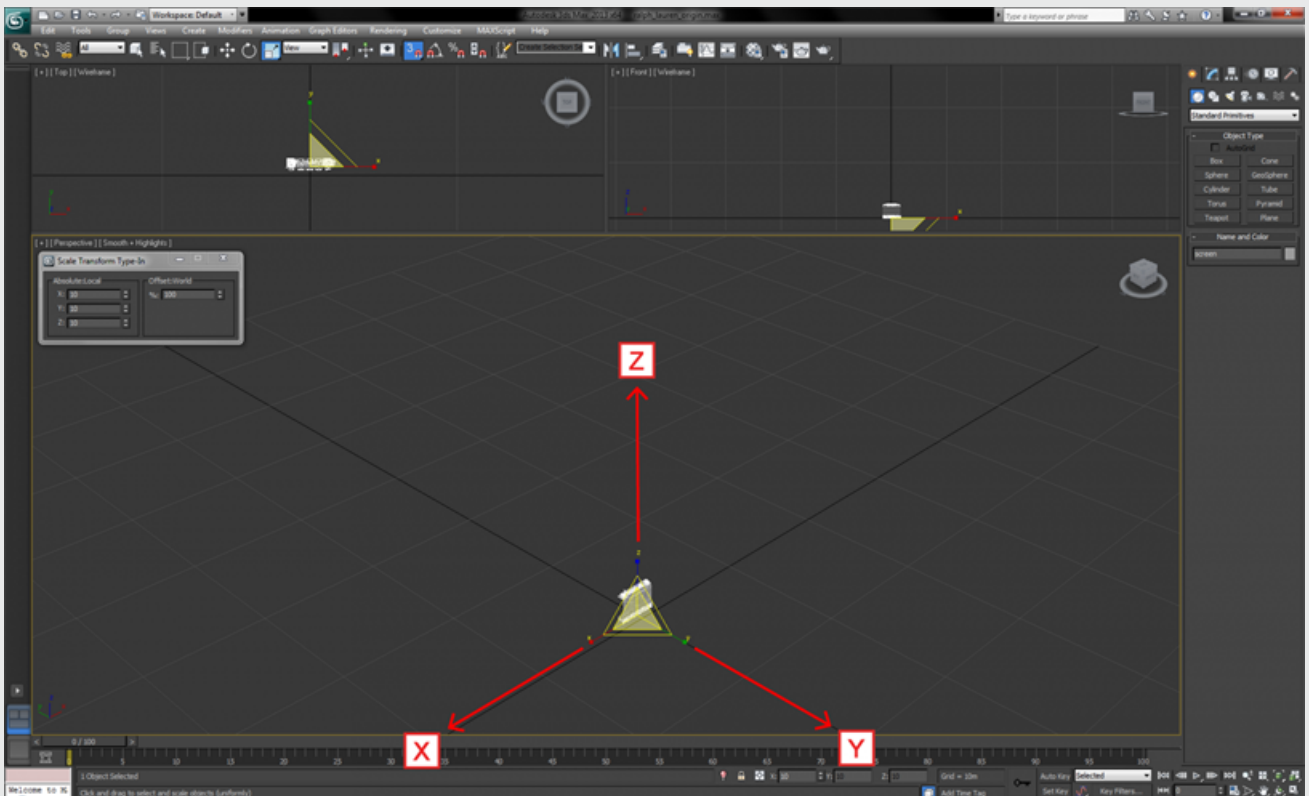

*The Ralph Lauren London Flagship Store scaled incorrectly in 3ds Max, set to 1:10 scale.*

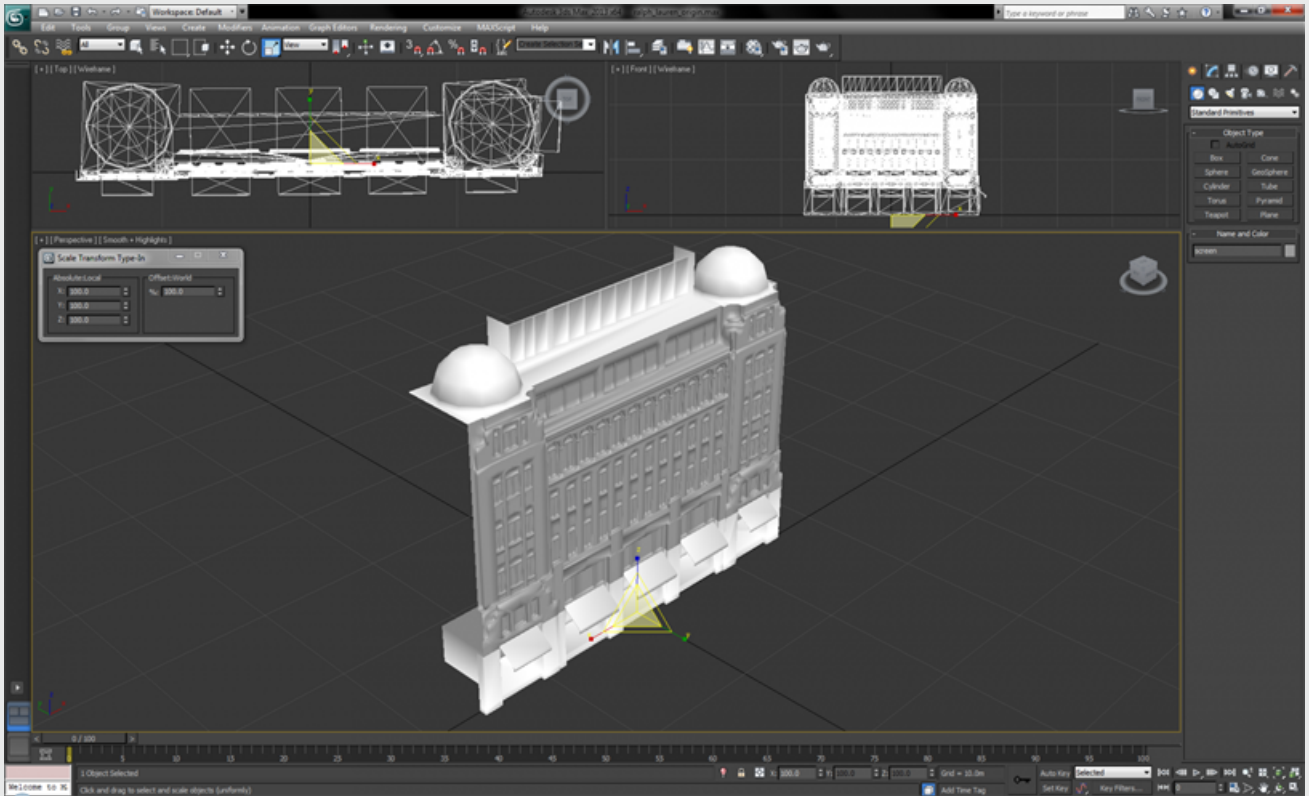

*The Ralph Lauren London Flagship Store scaled correctly in 3ds Max, set to 1:1 scale.*

## Helpful Resources

### 3ds Max

- [Support and learning](#)

### Maya

- [Support and learning](#)

# UV mapping overview

This sub-chapter will teach you the specific principles necessary to UV map 3D models for Disguise software.

Topics include:

- [What is UV mapping?](#)
- [How does Disguise sample UV maps?](#)
- [The UV map as the hardware output](#)
- [The UV map as the content template](#)
- [Editing UV maps](#)
- [Exporting UV maps](#)

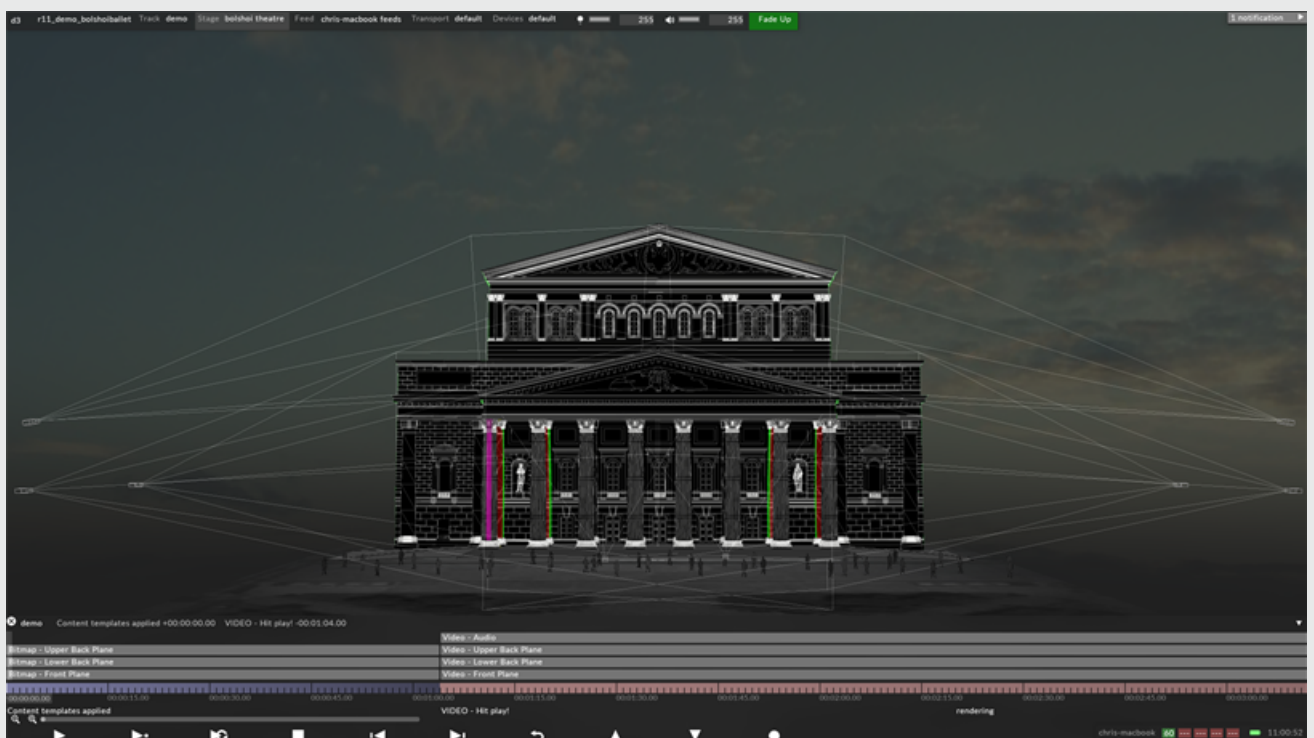

# What is UV mapping?

UV mapping is the process of generating a 2D representation of a 3D object.

This 2D representation is constructed from UV coordinates, which are commonly known as texture coordinates. U represents the horizontal axis and V represents the vertical axis. Each UV coordinate has a corresponding point in 3D space called a vertice. Together vertices form edges, edges form faces, faces form polygons, and polygons form surfaces. The image below shows how a cube in 3D space can be unwrapped into a texture in 2D space to generate a UV map.

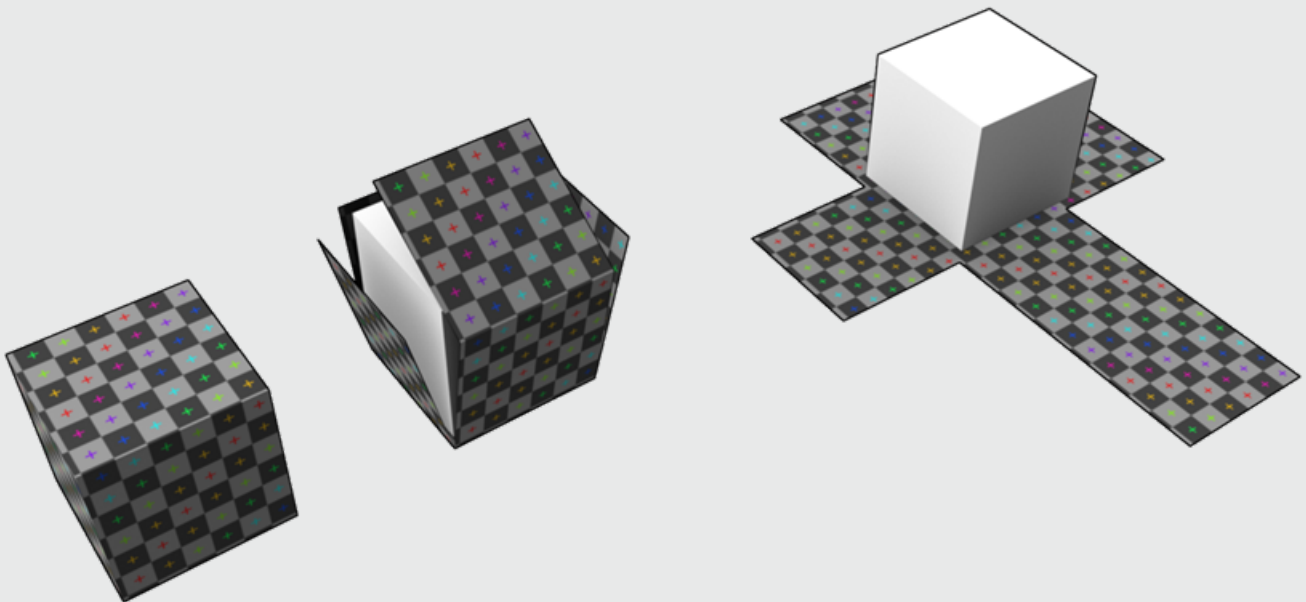

A 3D cube being unwrapped into a 2D representation to generate a UV map.

A UV map can be generated automatically by a 3D application, for example [3ds Max](#), [Maya](#), [Cinema 4D](#) and [Blender](#), but normally the UV map requires editing manually. To read more about editing UV maps see the [Editing UV maps](#) page.

## Example UV map

The image below shows a plane constructed from four vertices with four corresponding texture coordinates. The top-left vertice corresponds to the top-left texture coordinate and the bottom-right vertice corresponds to the bottom-right texture coordinate. For further information see the [LED screen examples](#) and the [Projection screen examples](#).

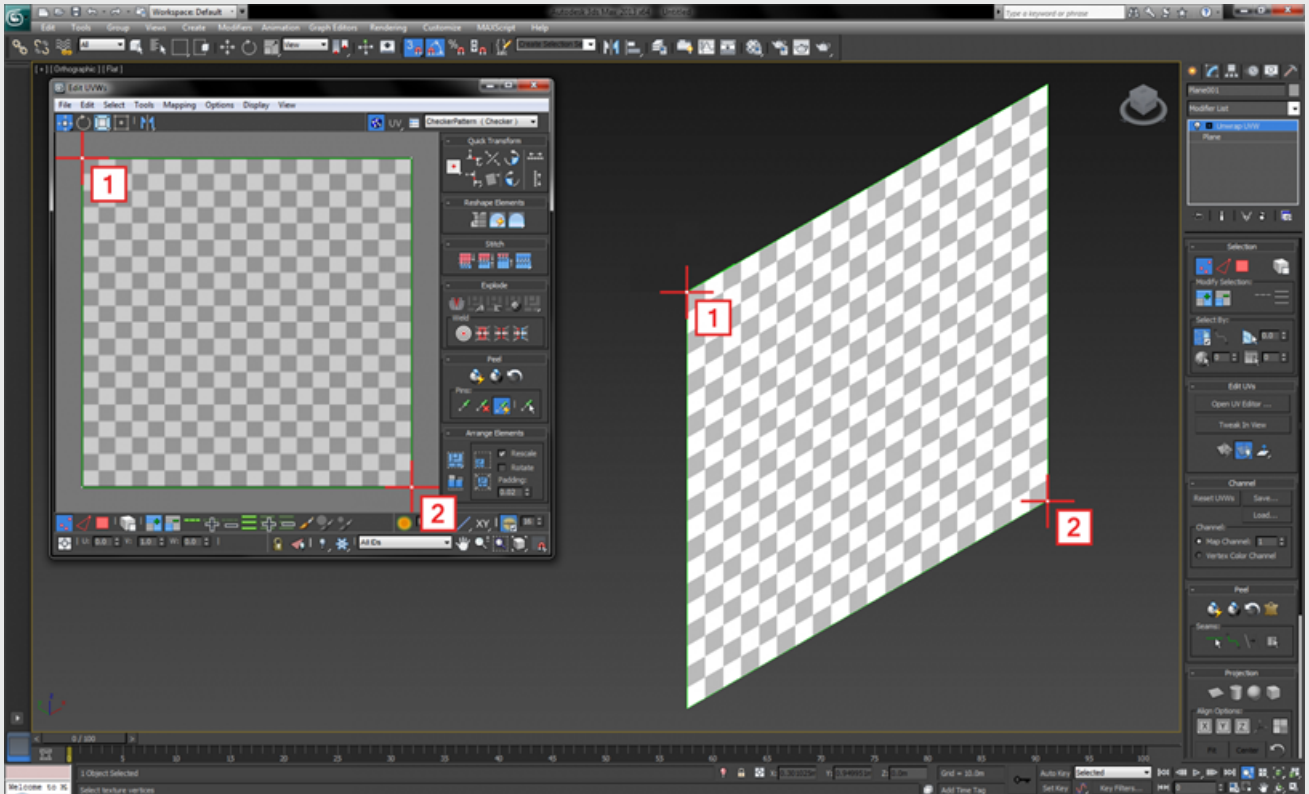

A plane modelled and UV mapped in 3ds Max. The plane's top-left vertice corresponds to the top-left texture coordinate (1), and the bottom-right vertice corresponds to the bottom-right texture coordinate (2).

## Helpful Resources

### 3ds Max

- [Support and learning](#)

### Maya

- [Support and learning](#)

# How does d3 sample UV maps?

In Disguise software, all meshes used for displays such as LED screens or Projection surfaces require a UV map to function. This is important because if a display does not contain a UV map it will display black and cannot be used for any mapping or output.

A UV map tells Disguise how to translate back and forth between the 2D source content and the mesh's 3D polygons for visualisation and to enable Disguise's 3D content mapping & projection mapping capabilities.

A UV map does not specify the aspect ratio or resolution of the mesh. UVs are defined in what is called 'normalised coordinates', which means they must have values between 0 and 1 on both the U and V axes, and there should not be any gaps left at the edges of the UV 'box'.

This normalised property of UV maps enables you to select the appropriate resolution and aspect ratio based on artistic and technical requirements from within the d3 visualiser. The aspect ratio of the display is usually defined by the position and size of the 3D geometry of the mesh, while the resolution is determined based on the LED product or projector type and positioning within d3, depending on the display technology used. Aspect ratio is determined by the ratio between the horizontal and vertical dimensions of the display resolution.

For example, if Disguise software is started with a standard 'rectangle' mesh on a display, the mesh has 4 vertices in each corner with normalised UV coordinates at (0,0), (0,1), (1,0), and (1,1). The display is set to 1920x1080 resolution. The software will sample source content 1920 times across each of the 1080 lines stretching across the mesh polygons. If d3 wishes to know the 3D location of the second pixel on the second line, the UV coordinate (0.0005, 0.0009), or (1/1920, 1/1080) is found, and d3 calculates the corresponding 3D location.



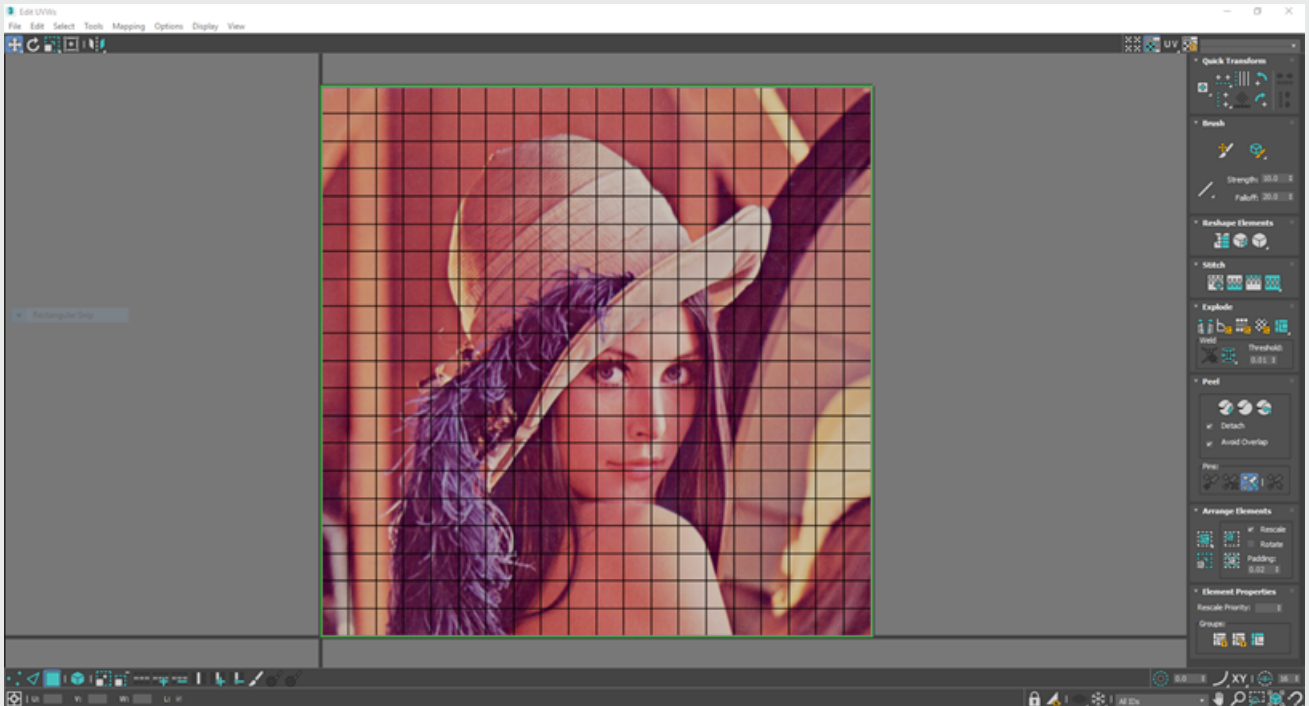

Screen in Disguise sampling the UV map shown in 3ds Max. The screen's top left pixel is sampling the UV map's top left quad.

## Normalising UV maps

Normalising is the process of scaling the UV map to fill UV space entirely from a range of 0-1 in both the U and V axes. When Disguise samples the UV map it will capture the entire UV space. Therefore, it is important to normalise the UV map correctly while setting the resolution of the screen in Disguise correctly, because together these will determine how video content is mapped to the screen.

The normalised UV map is capable of generating uniform pixels across the 3D model if the resolution of the screen is set correctly in Disguise software. To do so, the resolution must be set to a non-square aspect, and this is possible because Disguise can read textures with different horizontal and vertical resolutions. However, a non-normalised UV map is capable of generating uniform pixels too, although in this case the resolution should be set to a square aspect in Disguise, for example 1024x1024 pixels. However, here the disadvantage is the UV map is sampling less UV space, resulting in more virtual pixels that will not be visible in Disguise. To read more about setting screen resolutions see the [Screen properties](#) page.

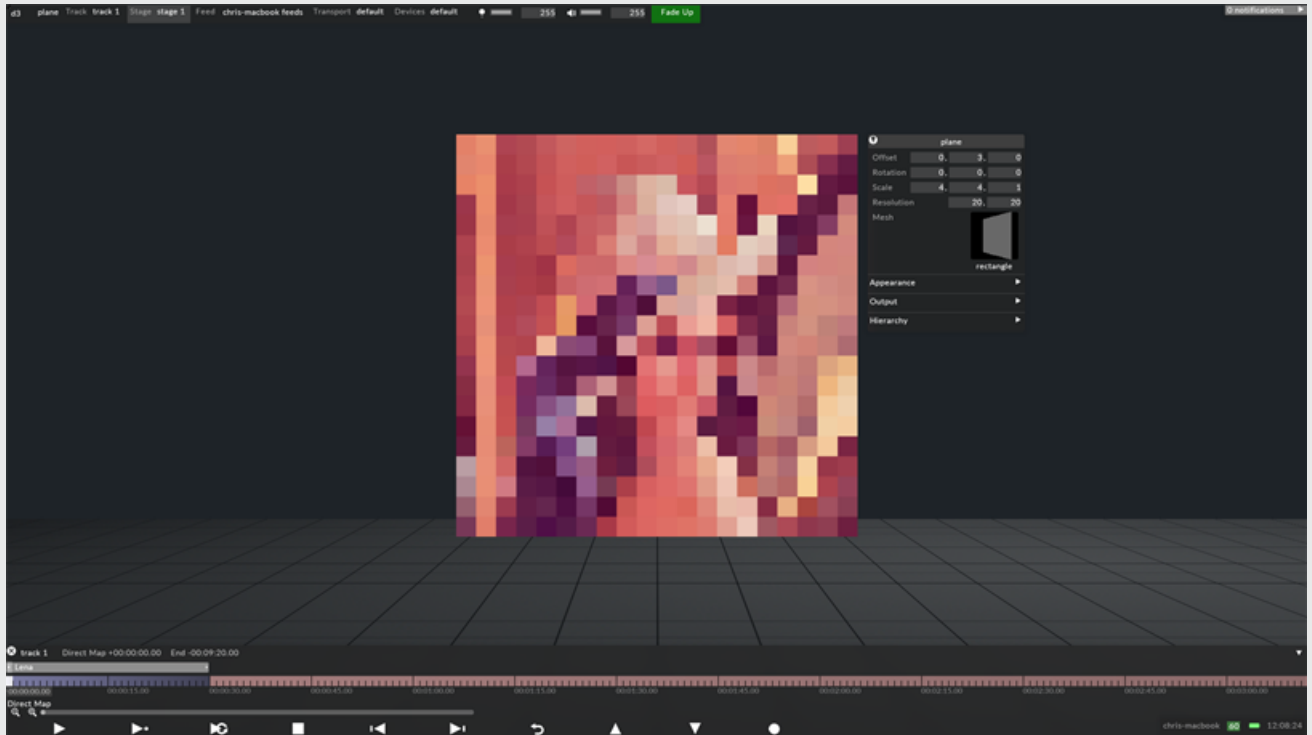

*The UV map has been normalised allowing for all pixels set in Disguise's screen editor to be assigned on the screen.*

## Helpful Resources

- [Normalize UV's \(Maya\)](#)
- [PolyUnwrapper \(3ds Max plugin\)](#)

# Editing UV maps

Usually after you've generated an appropriate UV map you may still need to edit the UV coordinates manually. Regardless if you have to do that or not you should always inspect the UV layout before exporting the object. 3d Max, Maya and Cinema4D offers powerful tools and plugins to do so.

The most commonly used operations for editing UV coordinates are:

- Re-scale UV coordinates horizontally or vertically, or both.
- Move UV vertices and/or faces.
- Rotate UV coordinates.
- Mirror UV coordinates.
- Snap UV coordinates to each other.
- Relax UV coordinates.
- Normalize UV coordinates.

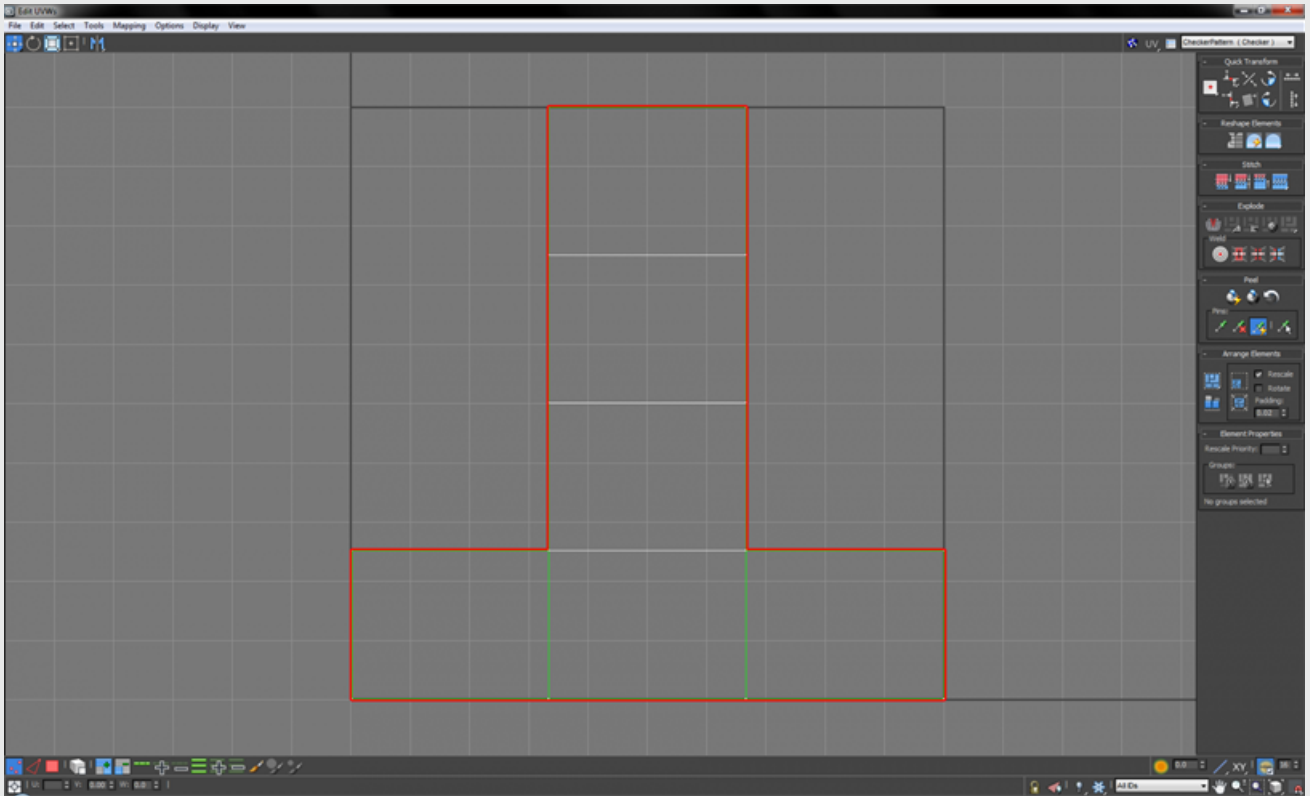

UV editor of 3ds Max

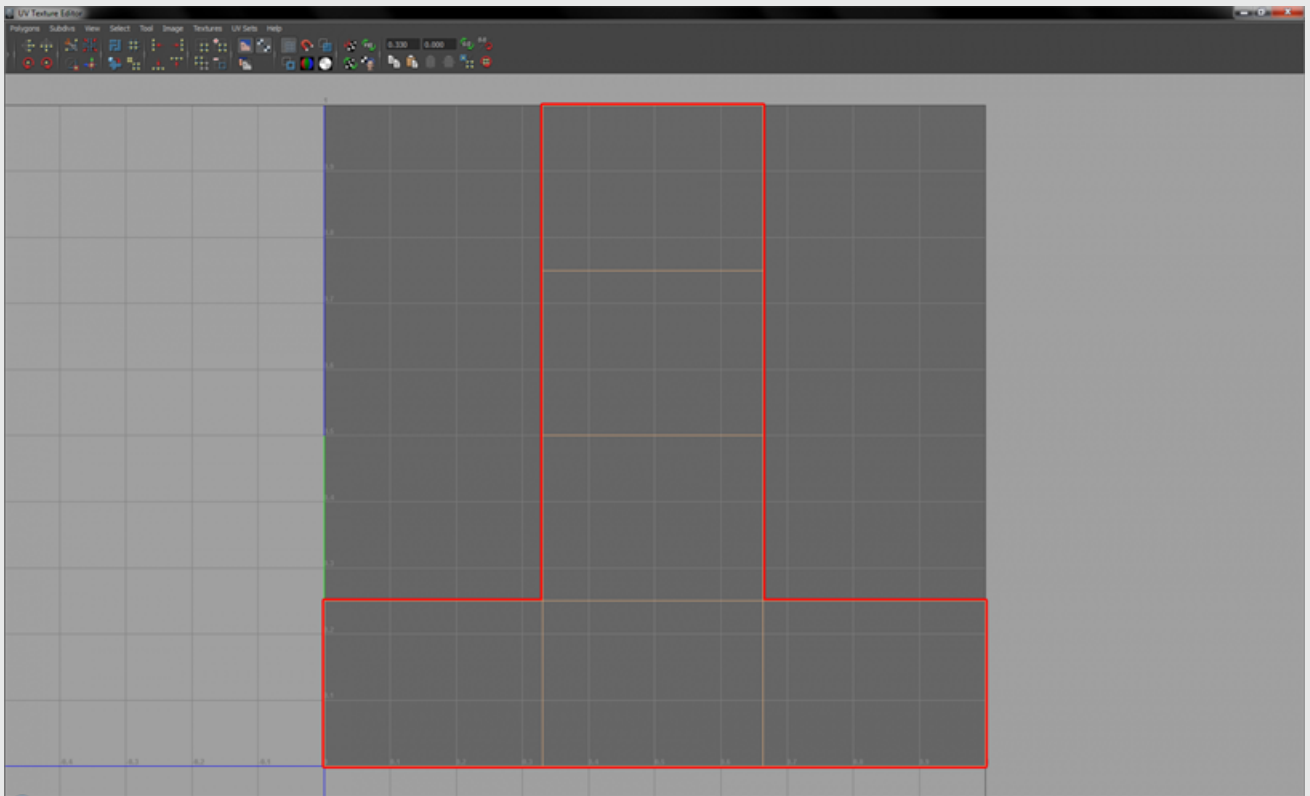

UV editor of Maya

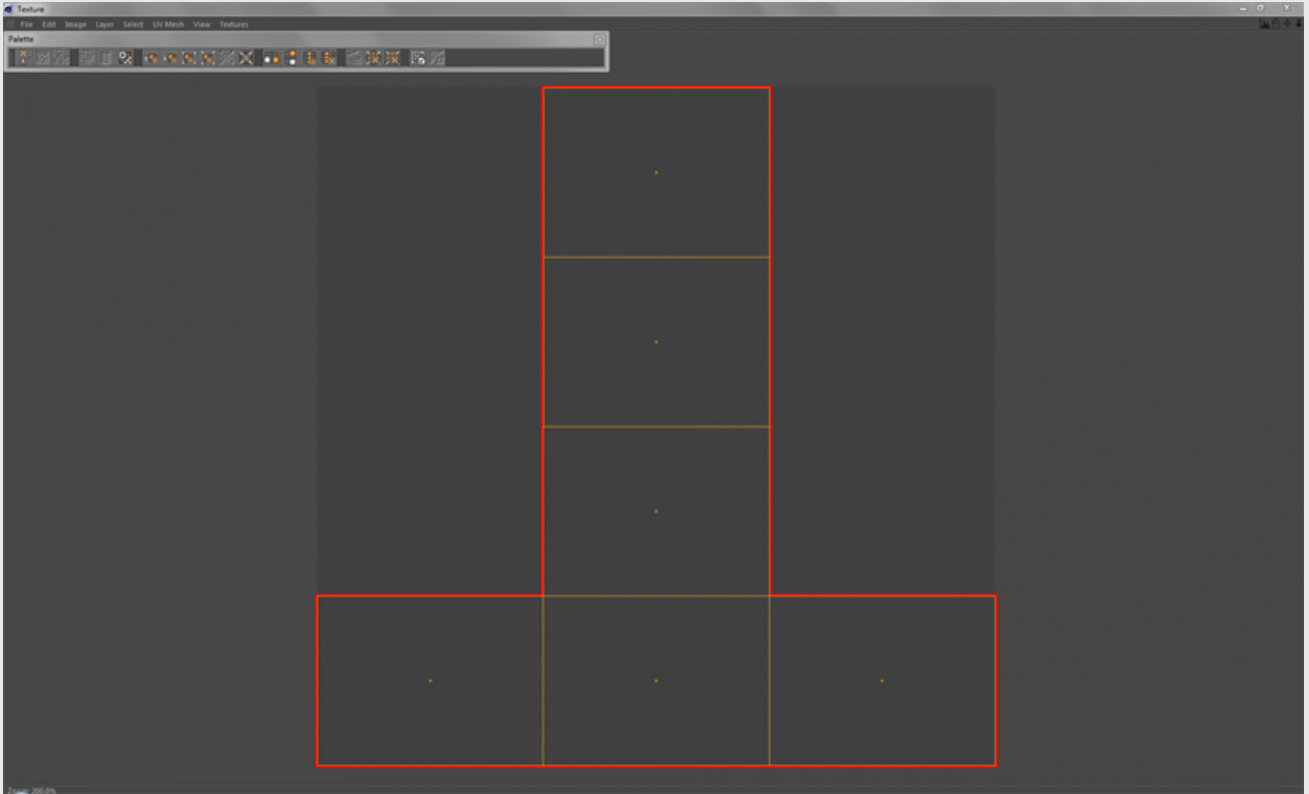

UV editor of Cinema4D

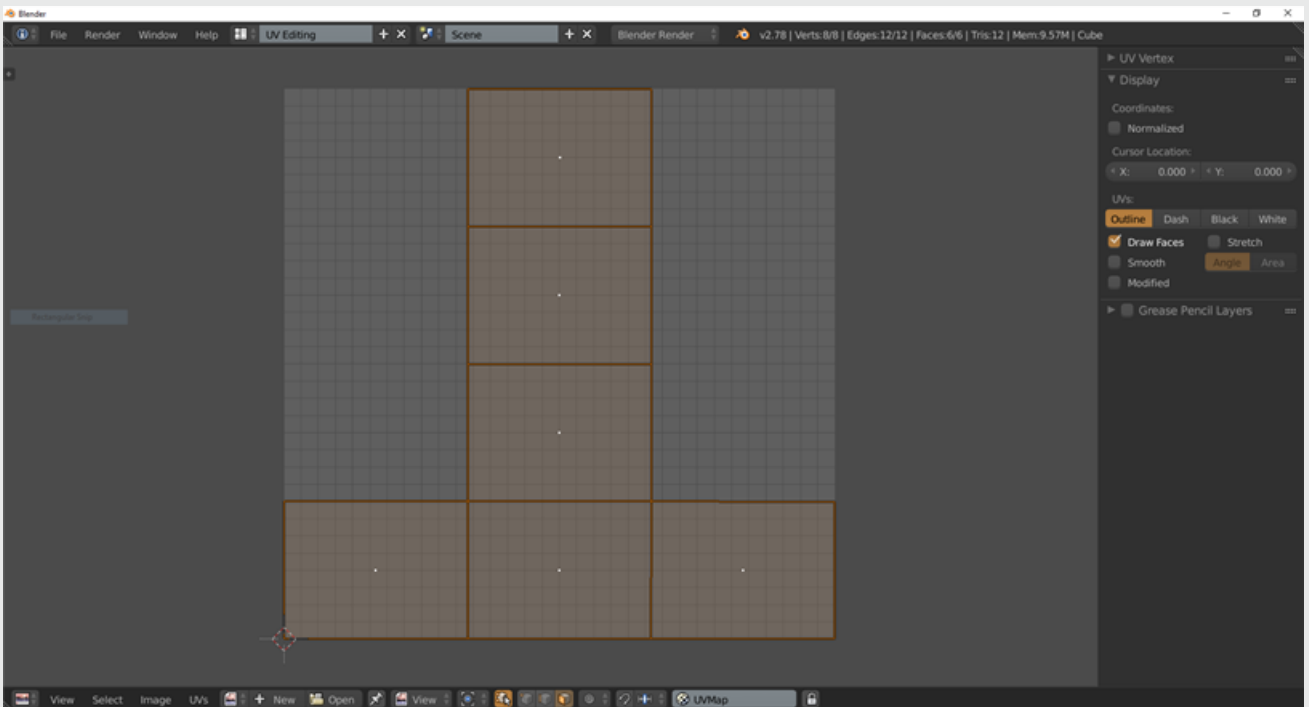

UV editor of Blender

# Helpful resources

## 3ds Max

- [Unwrap UVW Modifier](#)
- [Edit UVW](#)

## Maya

- [UV editor](#)
- [Viewing and evaluating UVs](#)

# Rendering UV maps to content templates

If rendering the UV map to a template image with the correct resolution ("correct" referring to sufficient pixel density and square pixels) it can be used as a background image for a 2D animator. Assuming that the animator creates graphics within the geometries and lines of the UV map, the rendered content will perfectly map back again onto corresponding faces of the 3D model.

3ds Max, Maya and Cinema4d can render out the UV map to a preferred resolution with different shading options.

## Useful external link:

 [Render UV's Dialog \(3ds Max\)](#)

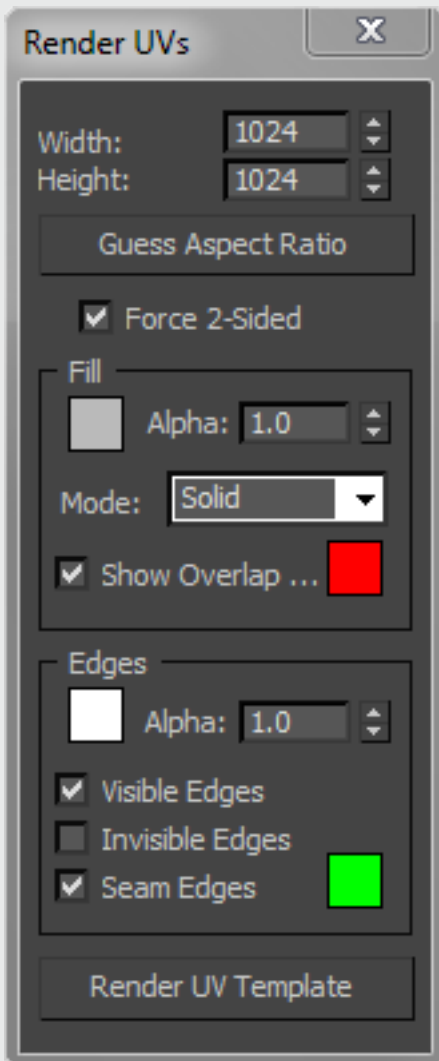



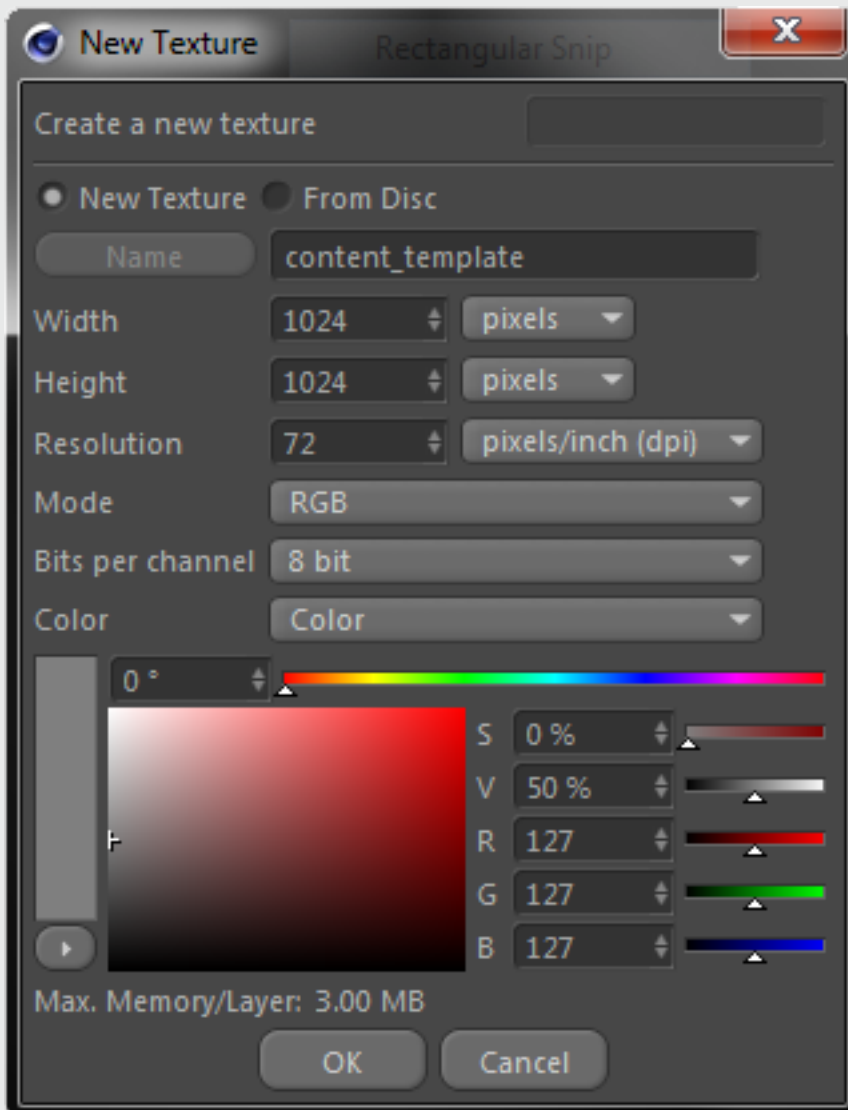

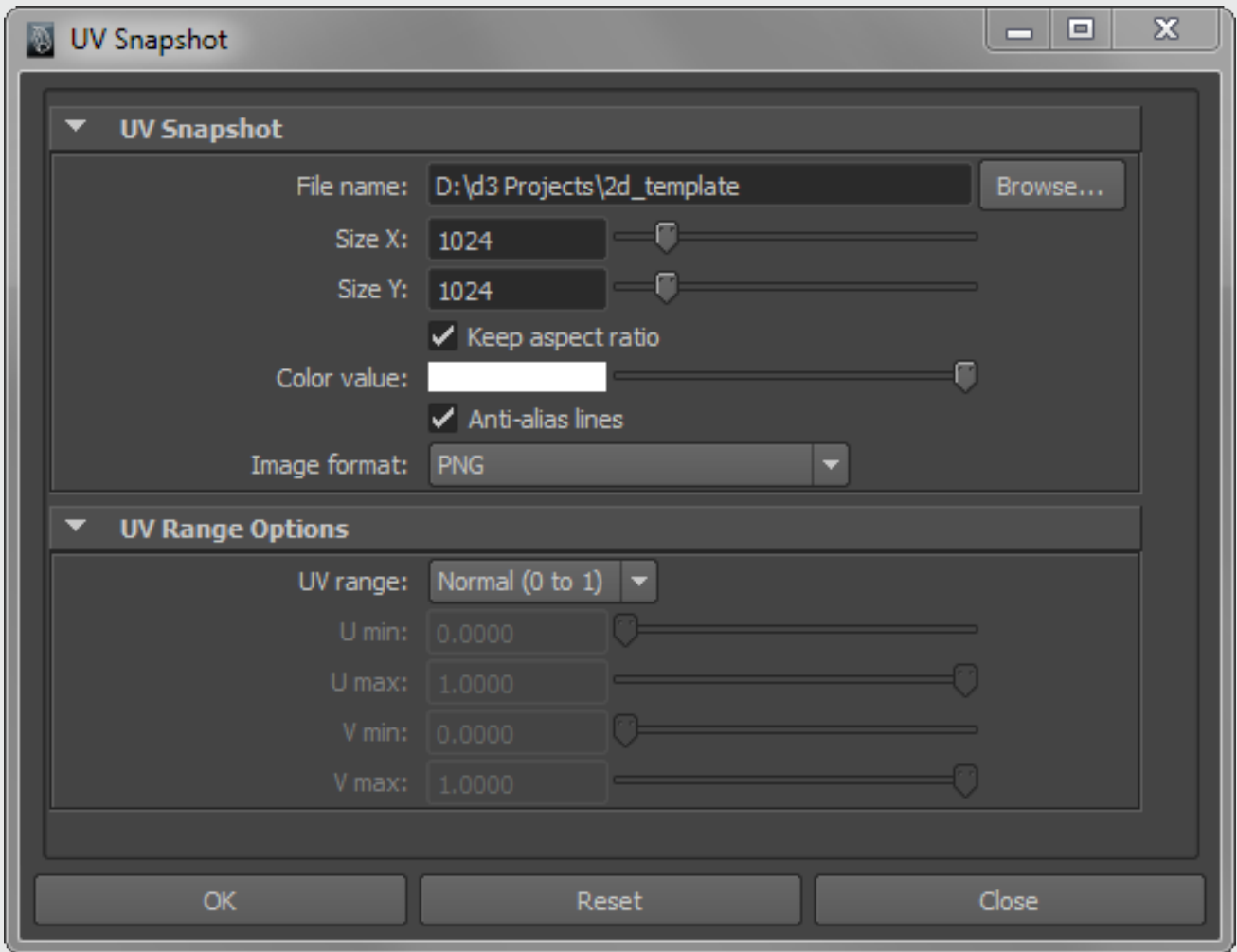

A good trick to ensure square pixels is, except applying a pixel perfect square using the bitmap layer described in the Setting resolutions and rendering UV maps page, is to also bring the rendered UV template into Photoshop and add a perfect square and circle to it. If applying the template as Direct map inside Disguise software, the square and circle should still appear as a perfect square and circle. If not, your resolution is set incorrectly. In order to verify correct mirroring of the UV coordinates, and to give the content creator an idea what screen his making content for it's also a good idea to write the name of the screen and its resolution.

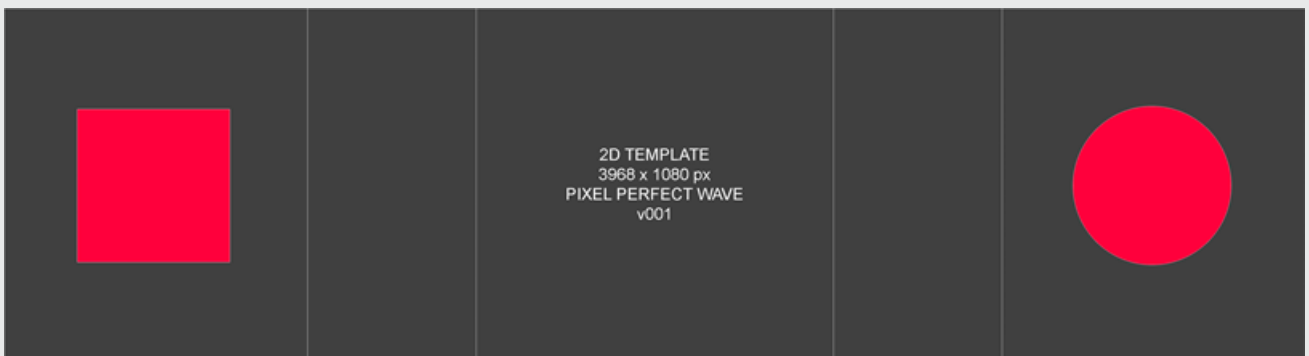

For complex unwrapped surfaces you may need to highlight specific areas in the 2D unwrapped template, apply the template in Disguise and make a screenshot of it being applied onto the screen.

The animator can now know what area in the 2D template that represents what part on the 3D model. Of course, best approach is that the content creator has a copy of Designer so he/she can test out the content himself.

# The UV map as the content template

As explained on the previous page, the UV map determines the output to the LED processor. However, preparing UV maps for projection surfaces requires a different workflow.

Normally the projection surface is unwrapped into a texture that the content creator can generate video content from, in a similar way to how artists texture 3D models in the video games industry. The UV map is rendered into a content template to be placed as a background in Adobe Photoshop, Illustrator, After Effects or any other image / video editing application. The template's resolution is calculated from two variables: aspect and density.

- The template's aspect ratio should match the UV map's to enable square pixels. This requires knowing precisely how the UV coordinates have been mapped to the 3D model. If the aspect is calculated incorrectly the rendered content may appear stretched across the projection surface.
- The template's pixel density should match, or preferably exceed, the projector's to enable a 1:1 pixel density. This requires knowing precisely how many pixels produced by the projector will hit the projection surface. If the density is calculated incorrectly the content may appear pixelated across the projection surface.

When video content has been rendered from the content template, it can then be Direct mapped to the screen in Disguise. The content will map perfectly to the 3D model if the UV map for the template matches the UV map for the screen. In Disguise software, virtual projectors can be configured to sample content from the screen, and in realtime the sampled content is outputted to the physical projectors. Therefore, the projector outputs are independent of the content, which means the creative workflow for the content creator is separated from the technical workflow for the hardware technicians, as explained in The UV Map as the Hardware Output page.

## Example

The example below demonstrates how the unwrapped UV map is rendered into a 2D image which can be used as a background template for 2D animations. When re-applied onto the screen in Disguise software, the same template perfectly maps onto the 3D geometry. Virtual projectors are then sampling different parts of the screen and sends the output to the physical projectors. In this example, three HD projectors are covering the screen. This example below is identical to the example on the Pixel-perfect mapping page except the details how to create the UV map.

## Step 1 - initial UV unwrap

The UV map has been unwrapped and normalised. See the [Pixel Perfect Mapping](#) page for more details how to create the UV map.

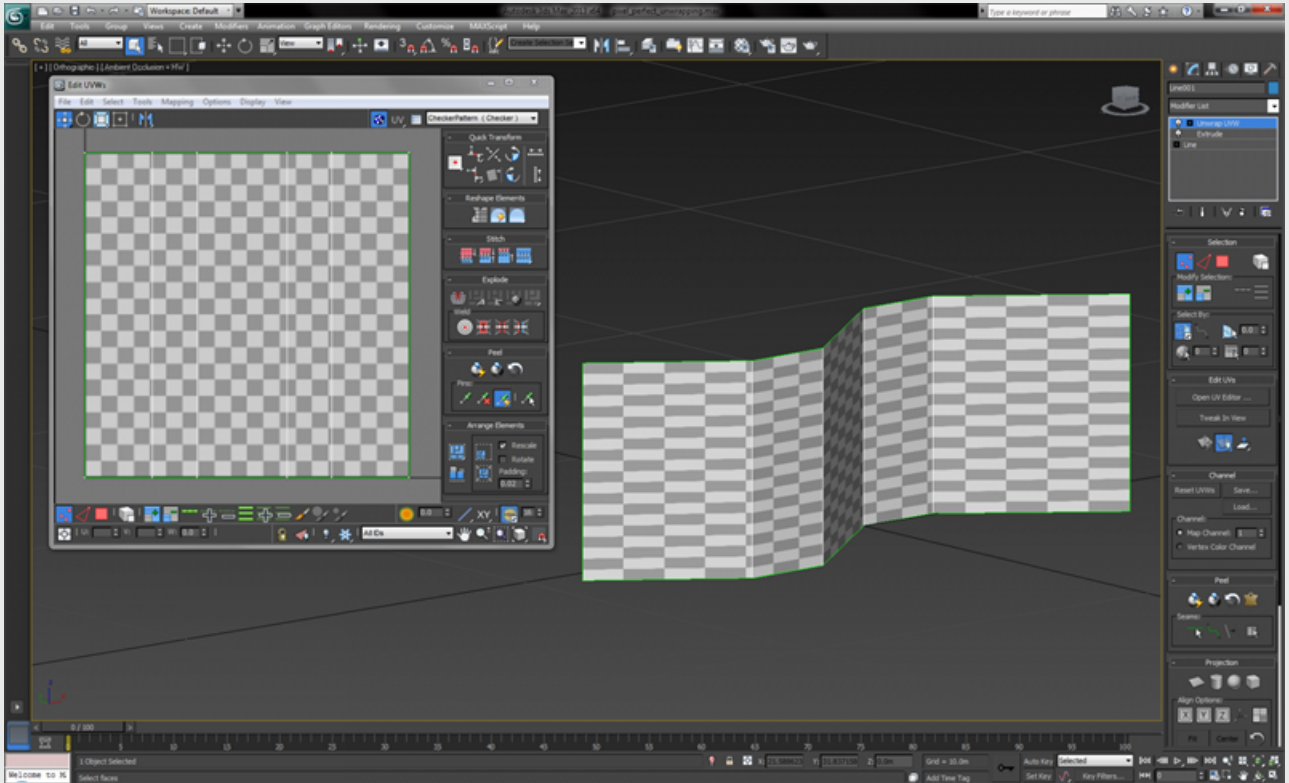

*The UV map of the linear screen has been unwrapped and normalized.*

## Step 2 - Rendering UV maps to content templates

The image below shows the content template, which was rendered from the UV map. The template's resolution was calculated by:

- Knowing precisely how many pixels produced by the projector will hit the projection surface, across either the horizontal or vertical axis.
- Dividing this value by the projection surface's dimension across the chosen axis, to calculate a pixel density.
- Multiplying the pixel density by the remaining axis' dimension, to calculate its resolution.

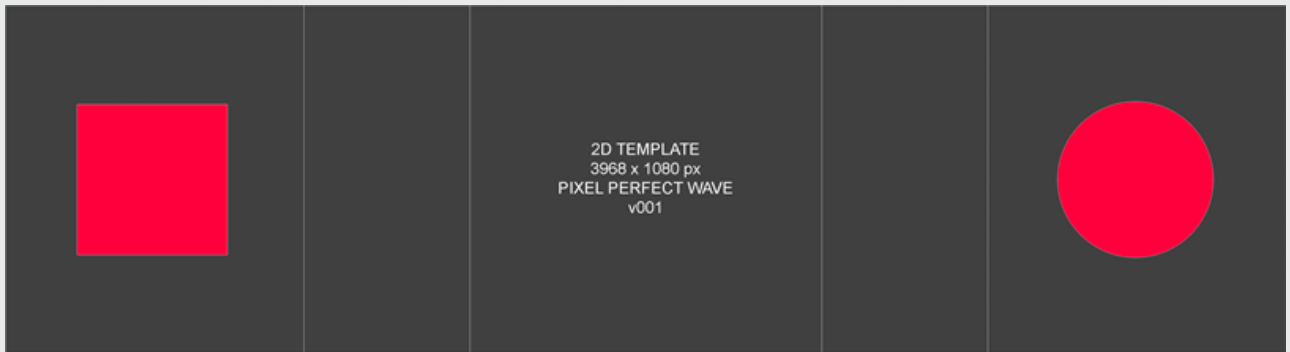

*UV map rendered to a content template.*

It is important to measure the projection surface's dimensions based on the UV map. In this case, the total length of the extruded spline should be measured, because the extrusion automatically generated the normalised UV map.

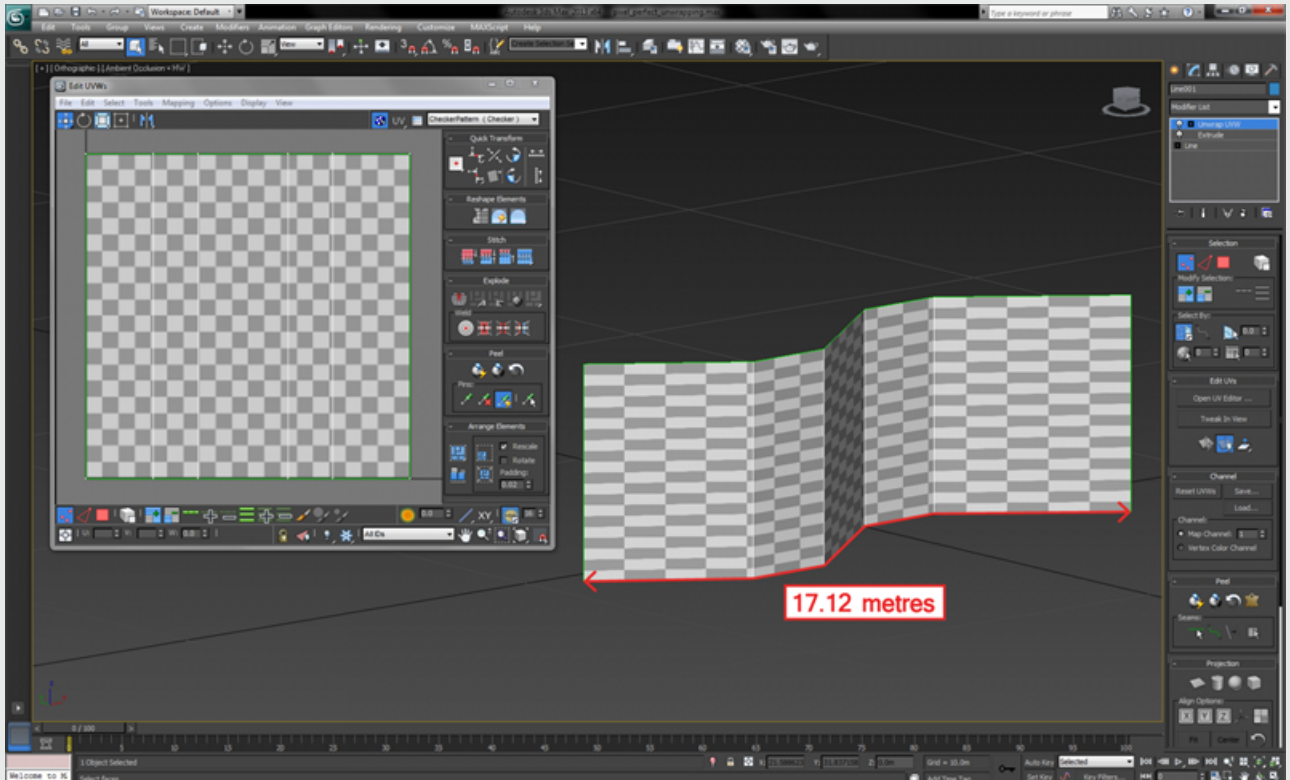

By calculating both the template's horizontal and vertical resolutions from a single pixel density value, the content should enable square pixels. This is important because if the resolution is calculated incorrectly the content may appear stretched across the projection surface. The template's resolution is 3698x1080 pixels. This was calculated by:

- Knowing approximately 1080 pixels will hit the projection surface vertically.
- $1080 \text{ pixels} / 5 \text{ metres (the projection surface's height)} = 216 \text{ pixels per metre (hitting the projection surface vertically)}$ .
- $216 \text{ pixels} \times 17.12 \text{ metres (the projection surface's length)} = 3698 \text{ pixels (the horizontal resolution)}$ .

As a result, the aspect of the template's resolution should match that of the surface's dimensions. This can be checked by:

- Dividing the template's horizontal resolution by the vertical resolution.
- Dividing the surface's length by the physical height (remember to base the measurements on the UV map, explained earlier).

In this case:

- $3698 / 1080 = 3.424$
- $17.2 / 5 = 3.424$

Both values are matching, which indicates the template's resolution is correct. To double-check this, a uniform square and circle should be drawn on the template in an image editing application, for example [Adobe Illustrator](#), before the template is exported to Disguise. If the square and circle appear uniform across the screen in Disguise the template's resolution is correct.

## Step 3 - Mapping content to screens

The image below shows the content template directly mapped to the screen in Disguise, which was exported as an .obj file from 3ds Max. In Disguise software, three HD virtual projectors have been configured to sample content from the screen. Each virtual projector samples a different part of the screen, and in realtime the sampled content is outputted to the physical projectors by three unique feeds.

**Please note:** Remember to set the resolution of the screen in Disguise to match the content template by opening the [Screen editor](#).



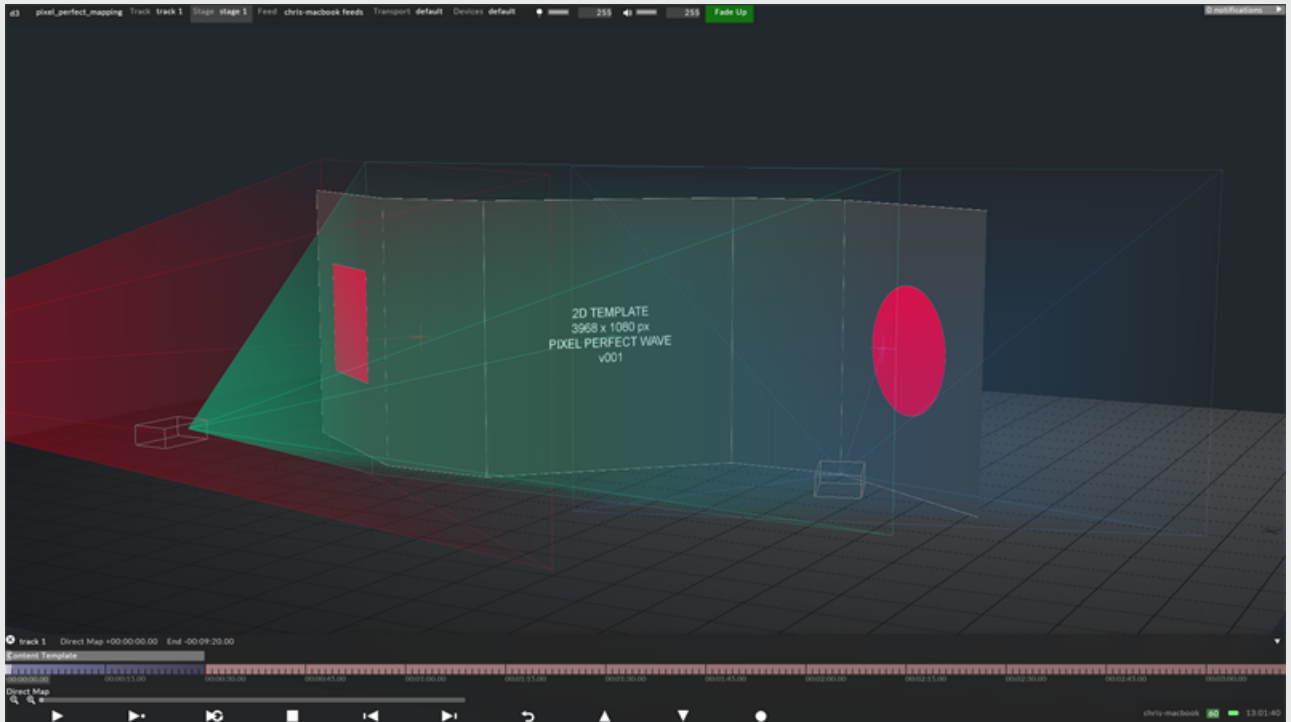

Template re-applied on the screen in Disguise.

## Step 4 - Outputting content to projectors

The image below shows the three unique feeds to be outputted to the physical projectors. If a virtual projector changes position its corresponding output will automatically update in realtime to show the virtual projector's updated point of view. Therefore, if a virtual projector's position changes onsite, content does not require re-rendering, because the outputs are independent of the content. To read more about Disguise's projector simulation toolkit see the [Projector simulation](#) chapter, which explains how to [quick calibrate](#), [warp](#), and [blend](#) projectors.



*The automatically generated outputs from the three virtual projectors.*

## Helpful Resources

- [Unwrapping UV maps 3ds Max](#)
- [Unwrapping UV maps in Maya](#)

# The UV map as the hardware output

Direct mapping means that content is being applied directly onto the UV map of the screen's mesh, inside Disguise's visualiser. But the UV map itself, set to the assigned resolution by the screen editor also turns into the output that can be added to the displayhead and further sent to the LED processor. The output is captured by the processor pixel per pixel and sent to the physical LED technology. As LED processors only can capture strict rectangular outputs it is therefore necessary to generate a precise grid-like UV map for LED screens.

## Creative and Technical workflow separation

With Disguise software's advanced capabilities of mapping surfaces in various ways (using the different Mapping types), you are not bound not to make content only according to the layout of the UV map or resolution of the screens. Content can for example be virtually projected using a Parallel map, Perspective map, Cylindrical map, Radial map, or re-distributed using a Feed map. Only when using a Direct Map the content is applied directly onto the UV coordinates. When virtually projecting the content onto the pixels using a Parallel map the content instead gets "baked" it into the respective UV maps of all screens included in the map while the output always stays in the format of the UV maps.

With this unique system, you can use multiple content templates (i.e. mapping types) throughout your project while the outputs always stay in the same format defined by the UV map of the screens. As a result of this the content workflow and the technical output get separated; the content people can work from content templates that don't reflect the layout of the outputs.

In the example below a screen made of 20 MiStrips receives content from a Parallel map. The Parallel map virtually projects the content into the UV coordinates of the object, i.e the content gets baked into the UV coordinates as explained above. However, the output is still in the format of the UV map and is to be captured by a LED processor.

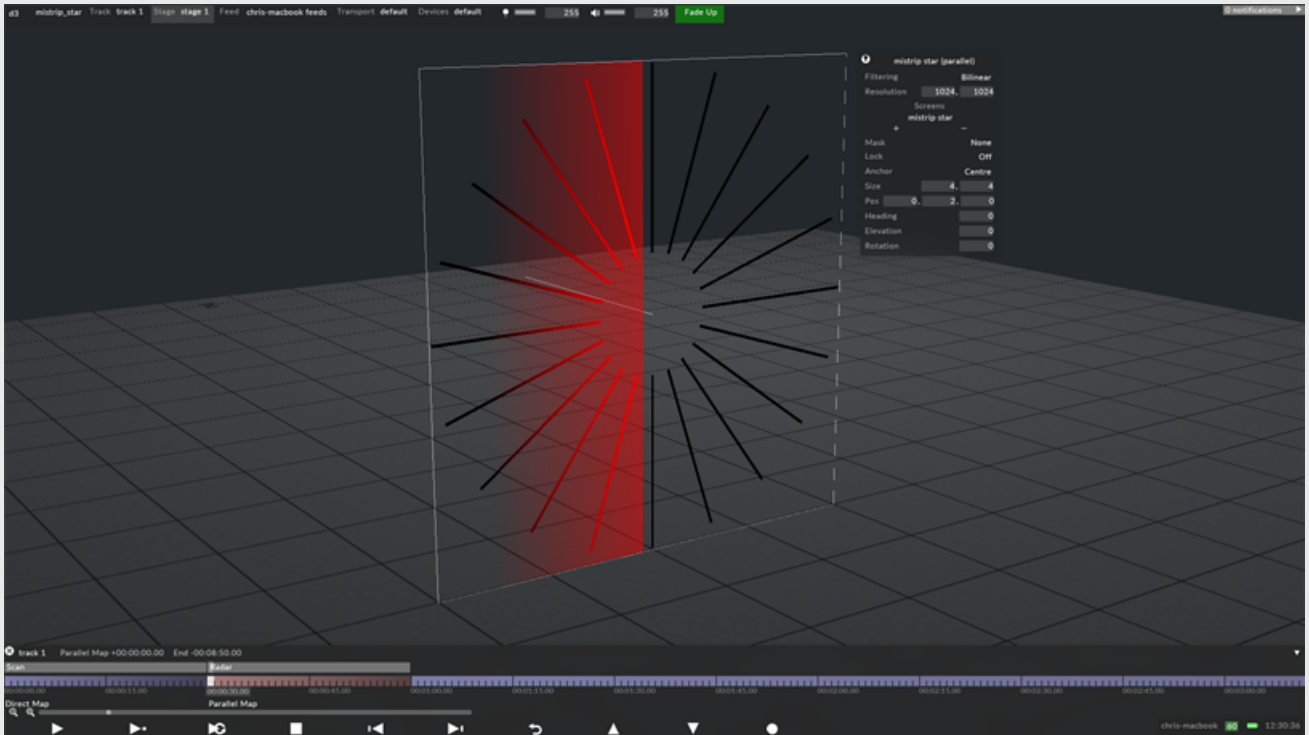

Content rendered out onto a display head for an LED processor to receive from Disguise.

## Re-configure the outputs

If the output does not match the LED processor's specifications, it can be reconfigured using Disguise's quick editing controls including the ability to re-position, chop, mirror, and rotate the output.

This allows for even more freedom and separation between the creative and technical workflow.

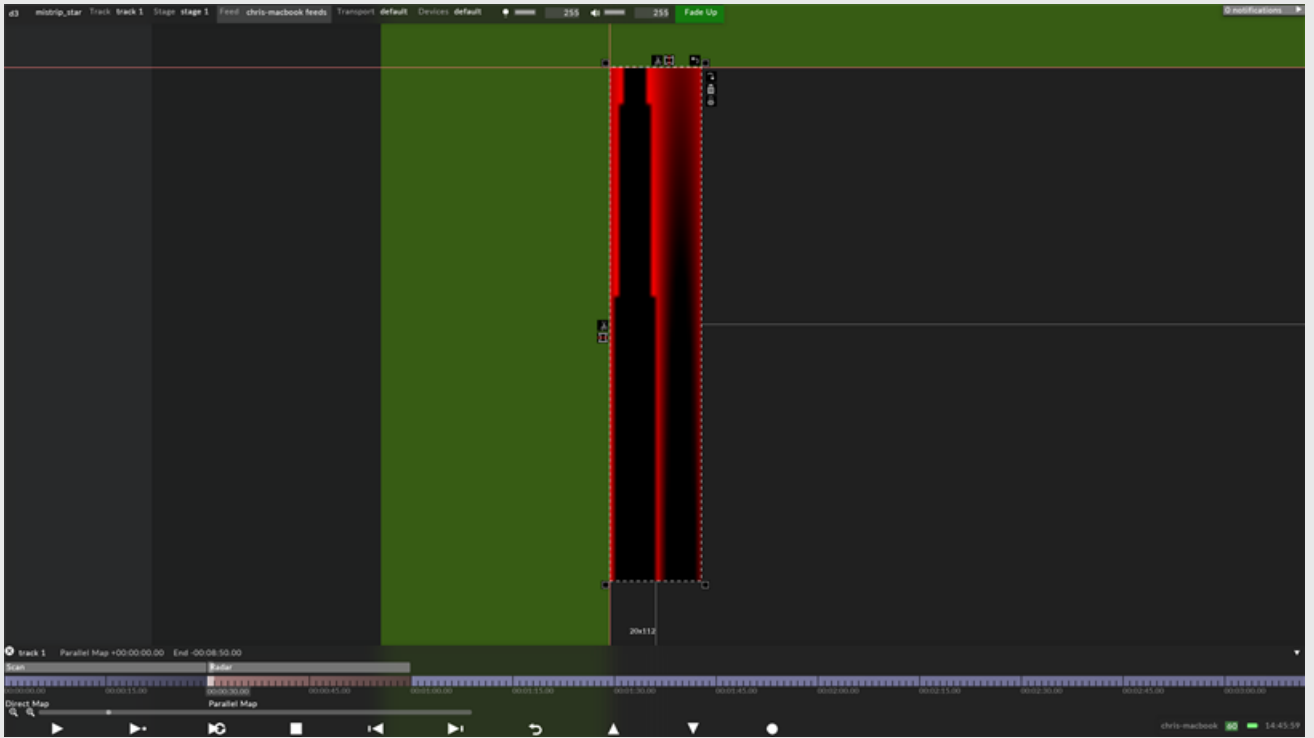

Same example as above but the output has been reconfigured using Disguise's quick editing controls.

# LED screen examples overview

This sub-chapter will teach you how to UV map LED screens for Disguise software, which are controlled either by DVI or DMX signals. The following examples revisit the UV mapping principles covered in the previous sub-chapter. Therefore, it is recommended to read this first. Topics include:

Example 1: MiSTRIP star

Example 2: OLite column

Example 3: DNA spiral

Example 4: Millenia Tower



# Example 1: MiSTRIP star

This case study shows how to prepare a star shaped LED screen constructed from [Barco MiSTRIPS](#) for Disguise software. The first step is to UV map the 3D model by unwrapping the mesh into a grid. As explained on [The UV Map as the Hardware Output page](#), the UV map should comprise a grid because this is the output to the LED processor from the software, and LED processor's can only capture outputs composed from rectangles.

## How the UV map is generated

A plane can be **arrayed around a local pivot point** to recreate the surface with the UV map **automatically generated**. However, the UV map will have **overlapping** UV shells and therefore will require editing, either **manually** using UV editing tools or **automatically** using a script, depending on the level of complexity.

## Step 1 - Generating the UV map (3ds Max)

1. Draw a plane that matches a MiSTRIP's dimensions, 0.063x1.484 metres.
2. Ensure you have the box called **generate mapping coordinates** checked. Doing so will enable the plane to automatically generate a normalised UV map.
3. Position the plane's local pivot point to the scene's origin. The origin is 0,0,0 in 3D space corresponding to the X,Y,Z axes.
4. With the plane selected, select the **Array** tool.
5. **Array** the plane by a count of **20** around **360** degrees. This will array twenty planes around the local pivot point.

6. **Attach** all the plane's together into one **Editable Mesh / Editable Poly**.
7. Select the **Unwrap UVW** modifier.
8. Open the **Edit UVWs** window to view the UV map.
9. At this stage, the UV map will have overlapping UV shells. To **unwrap** the UV map, reposition the UV shells next to each other, either **manually** using UV editing tools or **automatically** using a script.
10. It is important to **snap** the UV shells next to each other into a **grid**. Doing so will remove gaps in the UV map, which in turn will remove virtual pixels from Disguise's output to the LED processor.
11. **Normalise** the UV map by rescaling it to fill UV space entirely from a range of 0-1 in both the U and V axes.

The image below shows the MiSTRIPs arrayed in a 360 degree **arc**, but in UV space they are arrayed in a horizontal **row** as a **grid**. Importantly, the surface's outer ring of vertices correspond to the UV map's bottom row of UV coordinates, highlighted in red. This indicates the surface's UV coordinates are **uniformly** positioned.



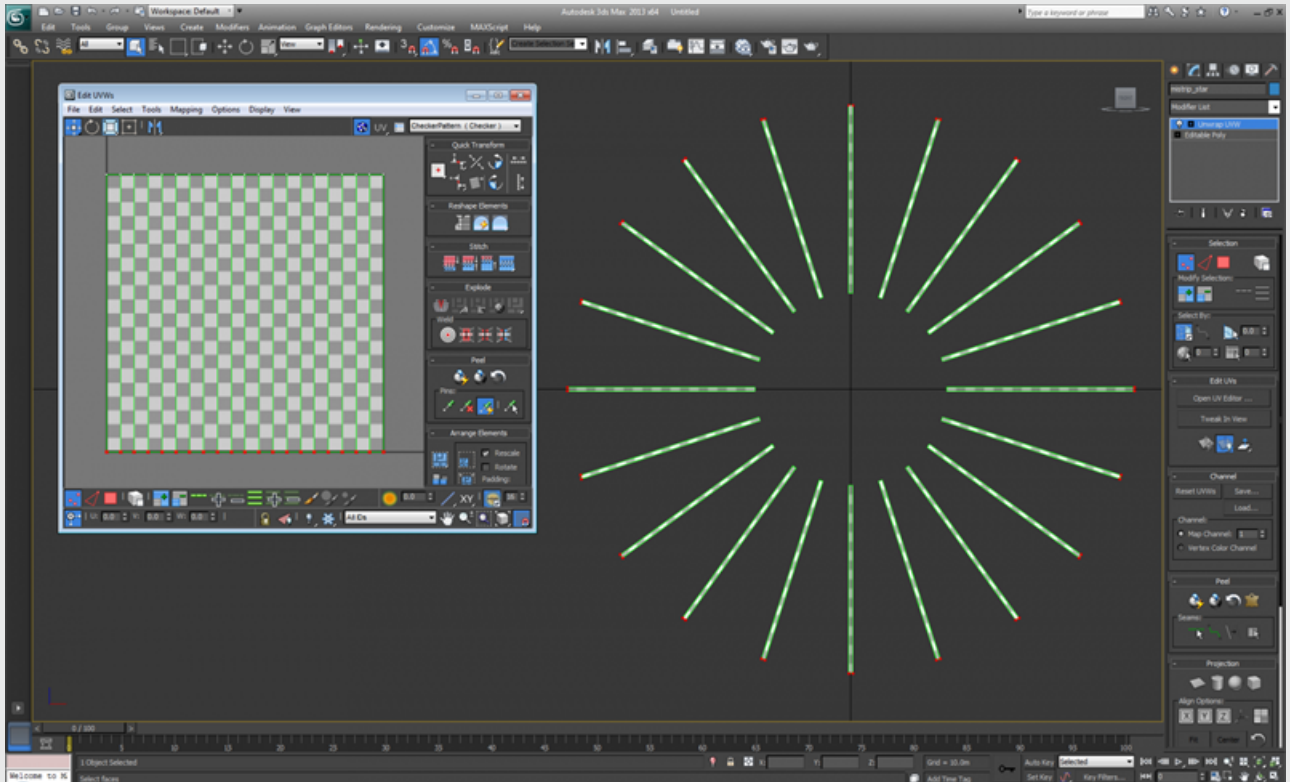

The image below shows how each MiSTRIP corresponds to a UV shell, highlighted in red. Importantly, each UV shell is *equal* in scale to each MiSTRIP, which indicates the UV map has an *even* distribution of UV coordinates.

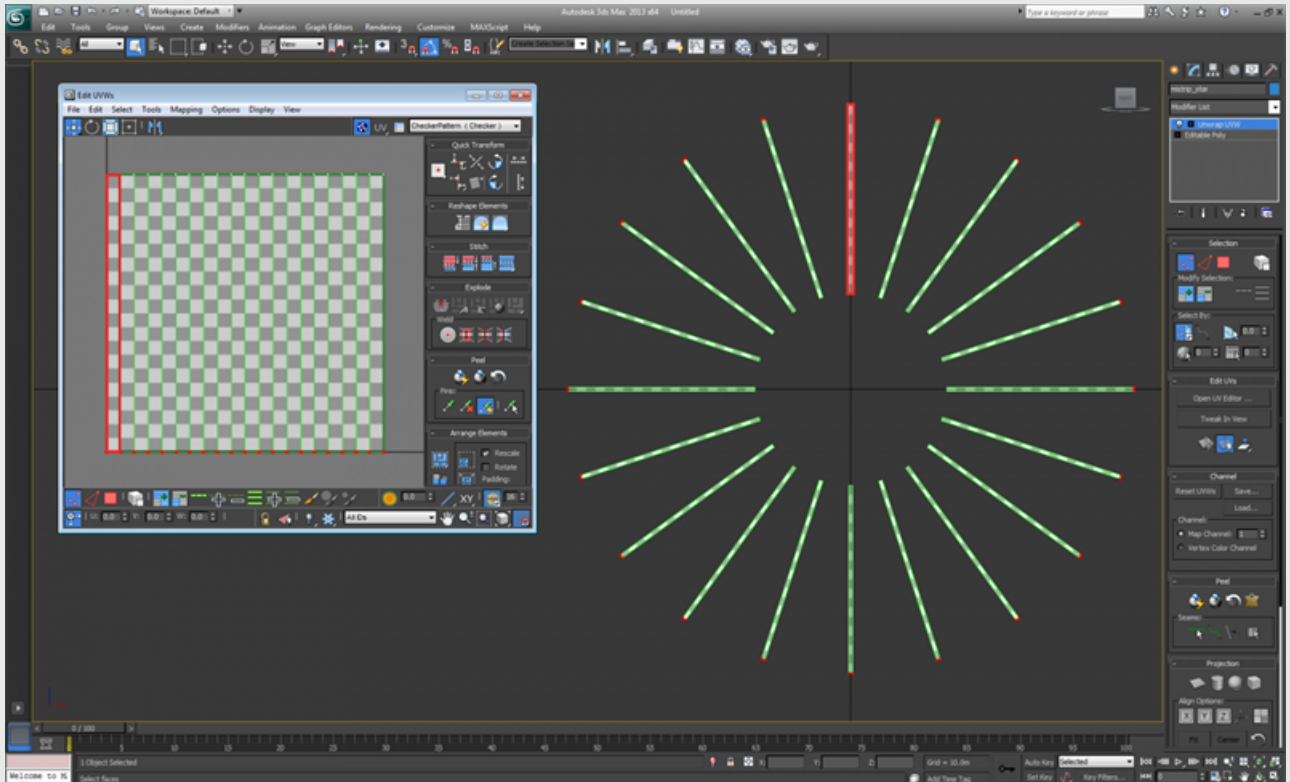

The image below shows how the MiSTRIPs are arrayed in UV space. Importantly, the MiSTRIPs are arrayed in a *clockwise* direction, and this order follows the UV map, where the UV shells are arrayed in a *left to right* direction.

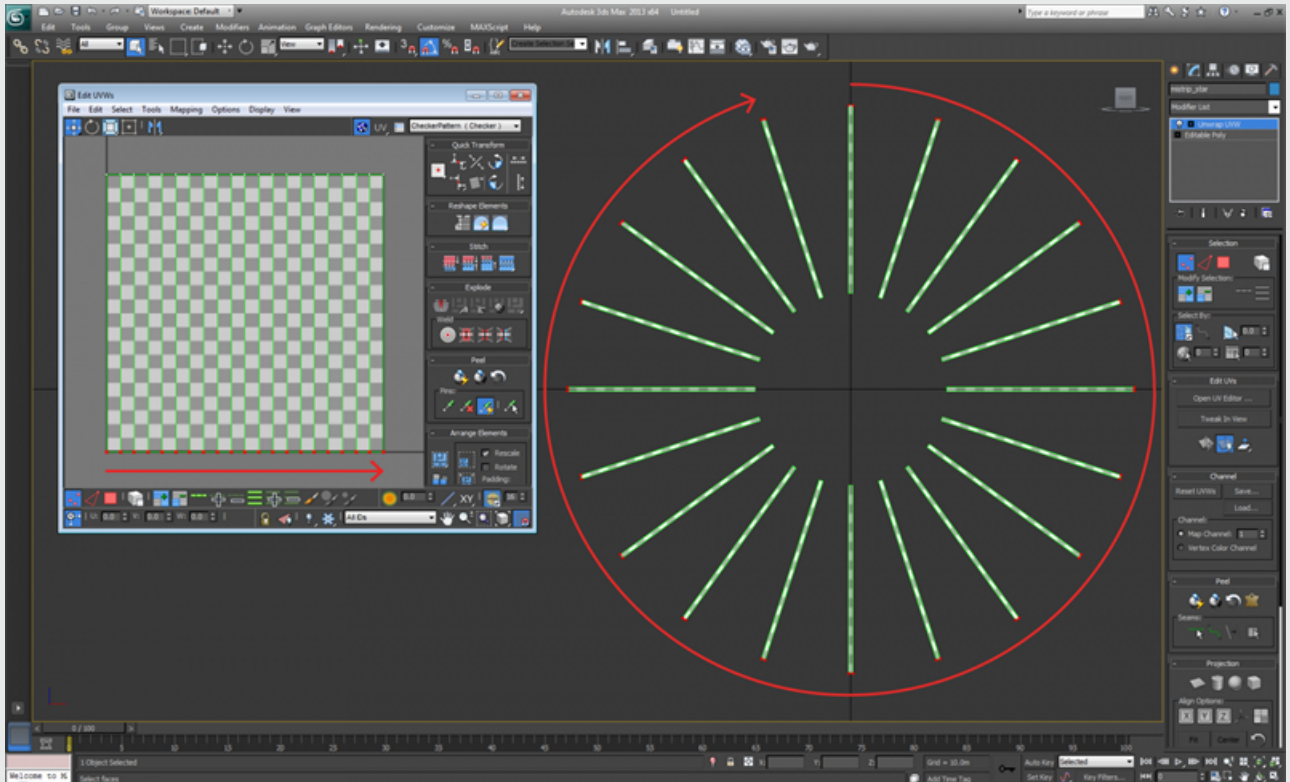

In order to set a resolution of this screen made of 20 strips it is crucial to turn each strip into a rectangle in UV space.

## Step 2 - Mapping content to screens

The left-image below shows a **Radar layer Parallel** mapped to the screen in Disguise software, which was exported as an **.obj** file from **Autodesk 3ds Max**. The right-image shows the **Output Feed** from Disguise to the LED processor, which is being generated in **realtime** by the Parallel map applied in Disguise's **Stage simulator**. The feed output is **independent** of the video content, which means the output can be a **different** resolution. In this case, the content has a resolution of 1024x1024 pixels, but the output has a resolution of 20x112 pixels. This is possible because **the Parallel map does not apply content directly to the screen's UV coordinates**; enabling the content creator to design content using templates that are **independent** of the LED outputs. Therefore, the creative workflow for the content creator is **separated** from the technical workflow for the hardware technicians, as explained on [The UV Map as the Hardware Output](#) page.

The resolution of the screen in Disguise software should **exactly** match the physical screen's number of pixels. The resolution of 20x112 pixels was calculated by:

- Knowing precisely how many pixels each MiSTRIP contains **horizontally**.
- Multiplying this value by the **total** number of horizontal MiSTRIPs, to calculate a horizontal resolution.
- Knowing precisely how many pixels each MiSTRIP contains **vertically**.

In this case:

- 1 MiSTRIP = 1 pixel **horizontally**.
- The total number of horizontal MiSTRIPs is 20. Therefore, 1 pixel x 20 MiSTRIPs = 20 pixels horizontally in **total**.
- 1 MiSTRIP = 112 pixels **vertically**.

**Please note:** When setting the resolution of a screen in the software, the UV map is **divided** into a **grid** of the same resolution, and in turn each of the grid's quads are **sampled** by the screen and **outputted** to the LED processor. Therefore, it is important to **match** the resolution of Disguise's screen to the physical screen. For further information see the [How Does Disguise Sample UV Maps](#) page.

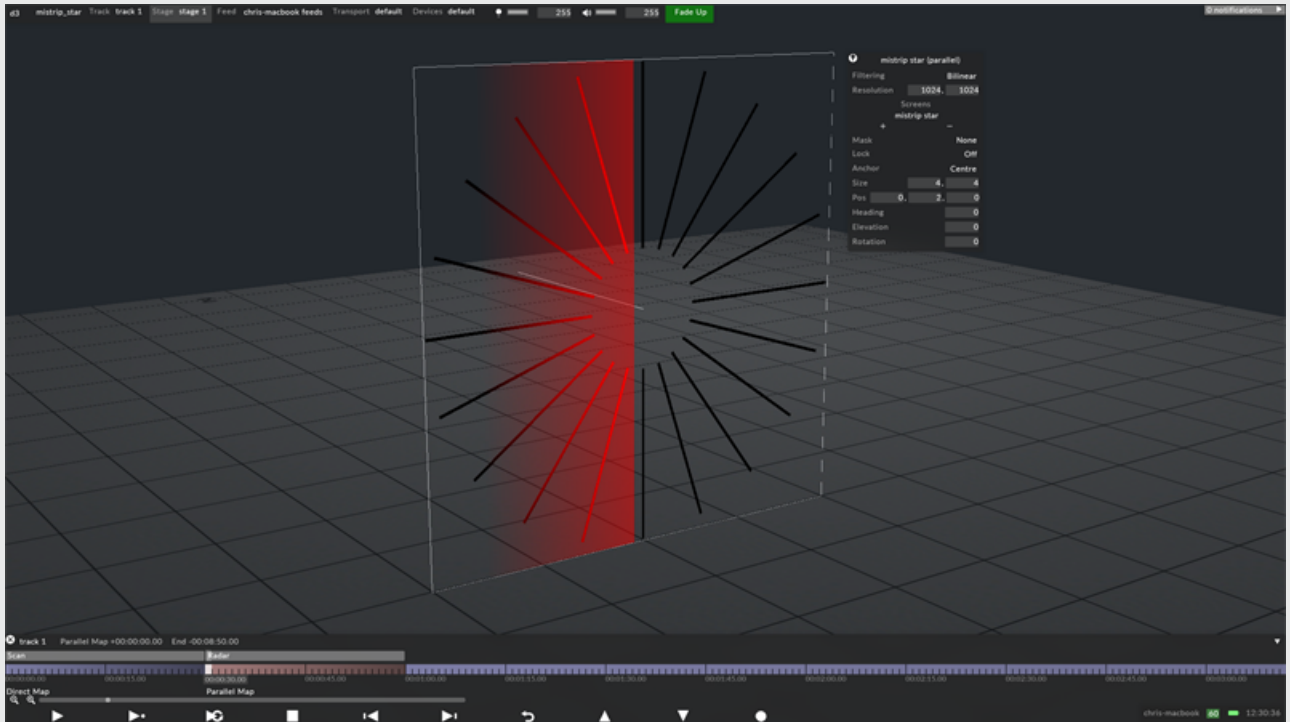

*The UV map also represent the output sent to the physical LED strips.*

The image below shows a Population mask applied to the screen in Disguise software, which was exported as a **.png** from **Adobe Photoshop**. The Population mask has removed MiSTRIP sections from the screen and, in turn, from the output to the LED processor, which maybe necessary if the screen's geometry requires updating. To read more about generating Population masks, see the [Population masks](#) page.

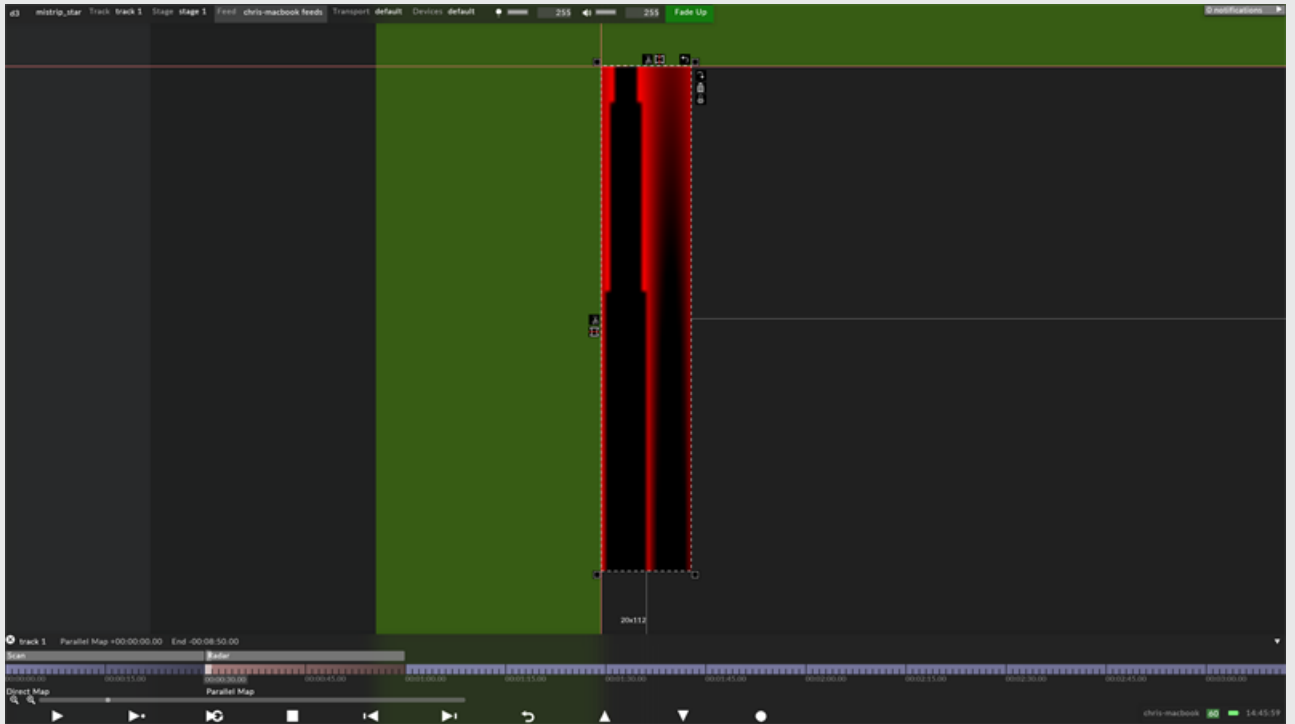

## Example 2: OLite column

This case study shows how to prepare a column shaped LED screen constructed from [Barco OLites](#) for [Disguise](#) software. As explained on the [MiSTRIP Star](#) page, the first step is to UV map the 3D model by unwrapping the mesh into a grid.

### How the UV map is generated

A plane can be **arrayed across a spline** to recreate the surface with the UV map **automatically generated**. However, the UV map will have **overlapping** UV shells and therefore will require editing, either **manually** using [UV editing tools](#) or **automatically** using a script, depending on the level of complexity.

### Step 1 - Generating the UV map (3ds Max)

1. Draw a plane that matches an OLite's dimensions, 0.084x0.112 metres.
2. Ensure you have the box called **generate mapping coordinates** checked. Doing so will enable the plane to automatically generate a normalised UV map.
3. Draw a [spline](#) that snaps to the outer edge of one OLite column.
4. With the plane selected, select the **Spacing** tool.
5. From the spacing tool's parameters select **pick path**, and select the spline.
6. From the spacing tool's parameters select **count**, and enter a value of **34**. This will array thirty four planes across the spline.
7. **Attach** all the plane's together into one **Editable Mesh / Editable Poly**.

8. **Clone** the column by a count of **11**.
9. Align each column into position using the **move** and **rotate** tools.
10. **Attach** all the column's together into one **Editable Mesh / Editable Poly**.
11. Select the **Unwrap UVW** modifier.
12. Open the **Edit UVWs** window to view the UV map.
13. At this stage, the UV map will have overlapping UV shells. To **unwrap** the UV map, reposition the UV shells next to each other, either **manually** using UV editing tools or **automatically** using a script.
14. It is important to **snap** the UV shells next to each other into a **grid**. Doing so will remove gaps in the UV map, which in turn will remove virtual pixels from Disguise's output to the LED processor.
15. **Normalise** the UV map by rescaling it to fill UV space entirely from a range of 0-1 in both the U and V axes.

The image below shows the OLites arrayed in a **curved** direction, but in UV space they are arrayed in a **linear** direction as a **grid**. Importantly, the surface's outer ring of polys correspond to the UV map's top row of UV shells, highlighted in red. This indicates the surface's UV shells are **uniformly** positioned.



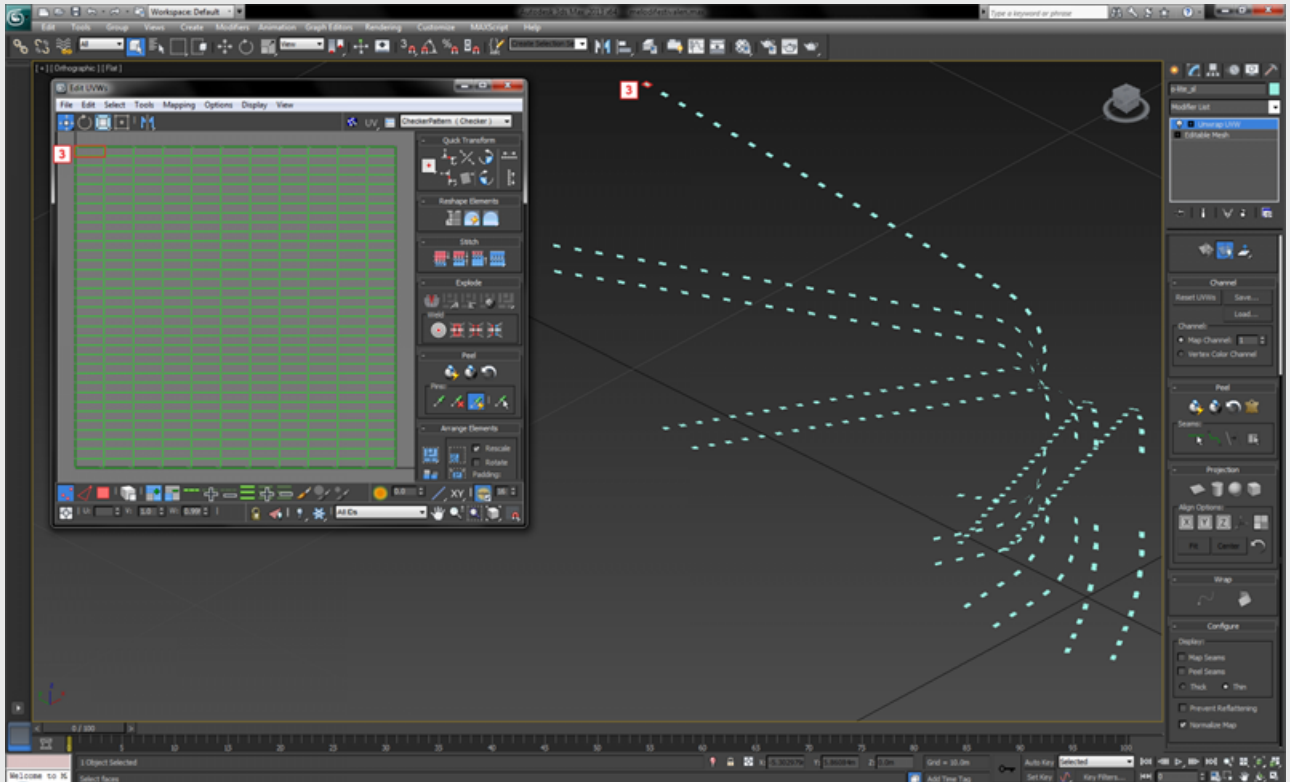

## Step 2 - Mapping content to screens

The image below shows a content template **Feed** mapped to the screen in Disguise, which was exported as an **.obj** file from **Autodesk 3ds Max**. The template was rendered from the UV map, and therefore contains no information about the **physical gaps** between the OLites. If video content is to be mapped to the screen with the physical gaps included, then a **Feed** map could be generated in d3. The Feed map **samples** different areas of the template, and in turn the sampled areas are **mapped** to the OLites. The advantage here is the sampled areas can be **reconfigured**, allowing for content to be moved, cropped, scaled and rotated, in the same way the Output Feeds can be reconfigured.

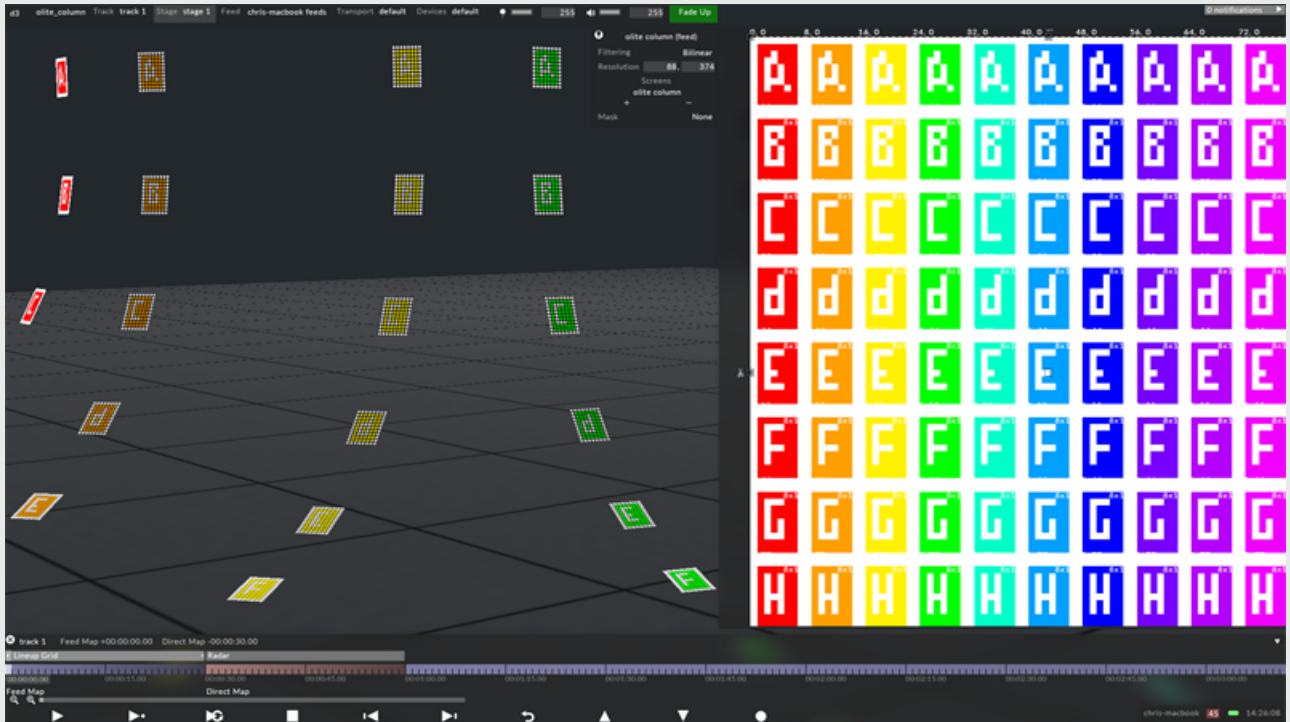

A **Parallel** or **Perspective** map can be generated from Disguise software. As explained on the [MiSTRIP Star](#) page, these mappings **do not apply content directly to the screen's UV coordinates**; enabling the content creator to design content using templates that are **independent** of the LED outputs. Therefore, the creative workflow for the content creator is **separated** from the technical workflow for the hardware technicians, as explained on [The UV Map as the Hardware Output](#) page.

The resolution of the screen in Disguise software should **exactly** match the physical screen's number of pixels. The resolution of 80x374 pixels was calculated by:

- Knowing precisely how many pixels each OLite contains **horizontally**.
- Multiplying this value by the **total** number of horizontal OLites, to calculate a horizontal resolution.
- Knowing precisely how many pixels each OLite contains **vertically**.
- Multiplying this value by the **total** number of vertical OLites, to calculate a vertical resolution.

In this case:

- 1 OLite = 8 pixels **horizontally**.
- The total number of horizontal OLites is 11. Therefore, 8 pixels x 11 OLites = 88 pixels horizontally in **total**.
- 1 OLite = 11 pixels **vertically**.
- The total number of vertical OLites is 34. Therefore, 11 pixels x 34 OLites = 374 pixels horizontally in **total**.

**Please note:** When setting the resolution of a screen in Disguise software, the UV map is **divided** into a **grid** of the same resolution, and in turn each of the grid's quads are **sampled** by the screen and **outputted** to the LED processor. Therefore, it is important to **match** the resolution of Disguise software's screen to the physical screen. For further information see the [How Does Disguise Sample UV Maps](#) page.

## Example 3: DNA Spiral

This case study shows how to prepare a spiral shaped LED screen constructed from pucks for Disguise software. As explained in the previous case studies, the first step is to UV map the 3D model by unwrapping the mesh into a grid.

### How the UV map is generated

The DNA spiral's UV map was generated using a combination of techniques applied to the [MiSTRIP Star](#) and the [OLite Column](#). However, the key difference here is the UV map contains **gaps**. This is because the content creator required a 2D template that **accurately** represented the 3D model. In this case, **virtual gaps** were included to represent the **physical gaps** between the pucks.

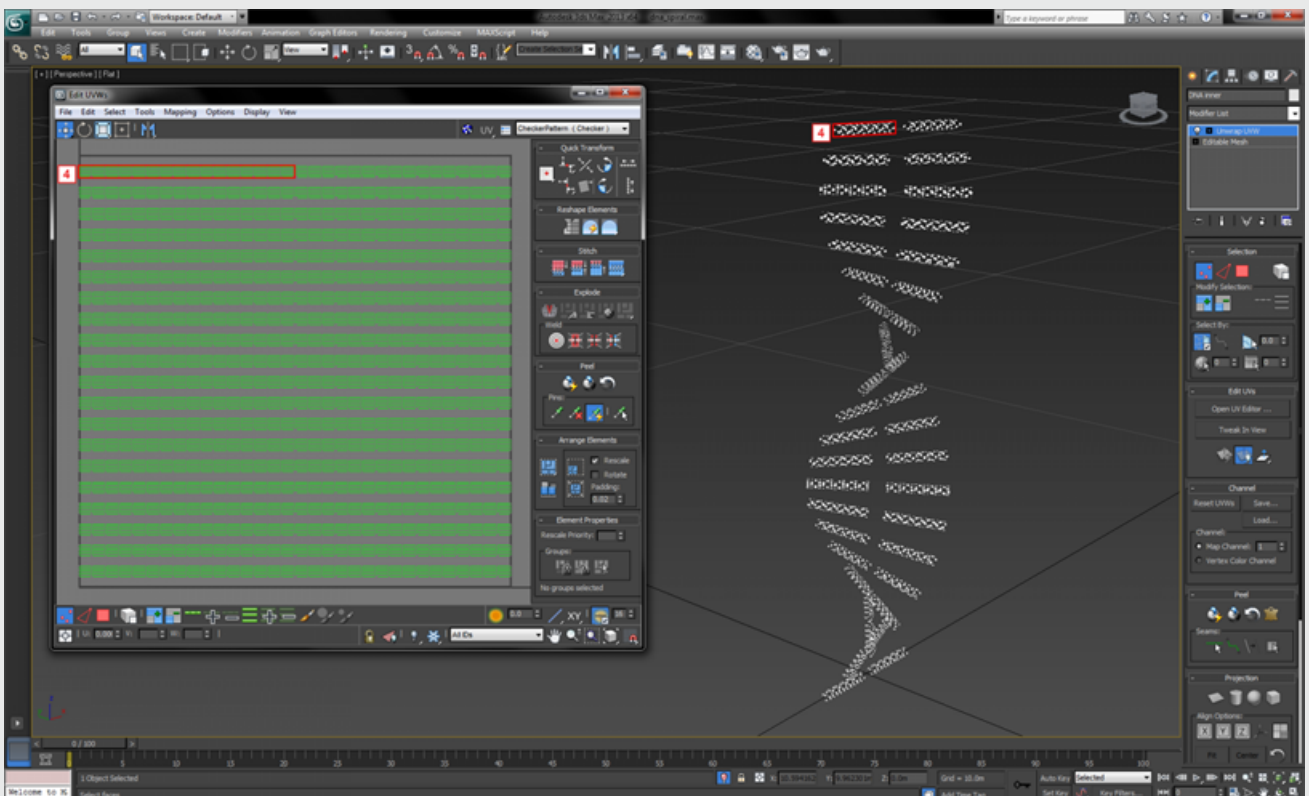

### The UV map of the DNA spiral.

The left-image below shows a content template **Direct** mapped to the screen in Disguise software, which was exported as an **.obj** file from **Autodesk 3ds Max**. The template was rendered from the UV map, and therefore includes **virtual gaps** to represent the **physical gaps** between the pucks. The Direct

map samples the **entire** UV map including the **virtual gaps**, but only the UV coordinates **assigned** to the 3D model will display video content; enabling the content creator to design content using a template which **accurately** represents the 3D model. However, here the disadvantage is Disguise's screen will require a **higher** resolution than the physical screen, **which may affect video performance**. The right-image below shows the **Output Feed** from Disguise software to the LED processor. The output is **independent** of the content, which means the output can be a **different** resolution. In this case, the content has a resolution of 32x164 pixels, but the output has a resolution of 32x82. This is possible because the Output Feeds can be **reconfigured**, allowing for virtual pixels to be **removed** from the output, and for the output to be **edited** to match the LED processor's pixel map. Therefore, the creative workflow for the content creator is **separated** from the technical workflow for the hardware technicians, as explained on [The UV Map as the Hardware Output](#) page.

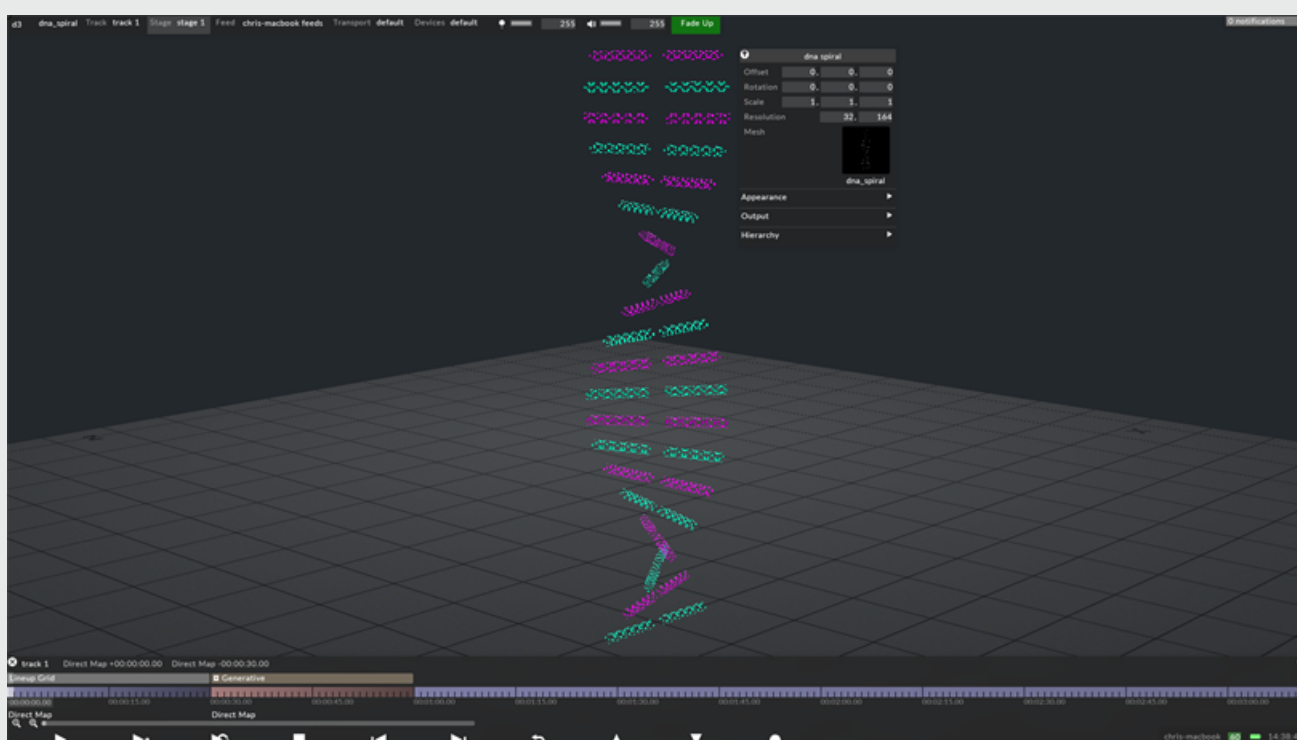

Normally, the resolution of the screen in Disguise software should **exactly** match the physical screen's number of pixels. However, in this case the resolutions can **differ**. The resolution of 32x164 pixels was calculated by:

- Knowing precisely how many pixels each puck contains **horizontally**.
- Multiplying this value by the **total** number of horizontal pucks, to calculate a horizontal resolution.
- Knowing precisely how many pixels each puck contains **vertically**.
- Multiplying this value by the **total** number of vertical pucks, and **doubling** the sum, to calculate a vertical resolution.

In this case:

- 1 puck = 1 pixel **horizontally**.
- The total number of horizontal pucks is 32. Therefore, 1 pixel x 32 pucks = 32 pixels horizontally in **total**.
- 1 puck = 1 pixel **vertically**.
- The total number of vertical pucks is 84. Therefore, 1 pixel x 82 pucks = 82, and 82 x 2 = 164 pixels horizontally in **total**.

The vertical resolution was **doubled** because the UV map contains **gaps**. **Importantly, the gaps were spaced evenly to match the heights of the UV shells**. Doing so ensures Disguise's screen will **precisely** sample the UV map. If the resolution is incorrect the screen will sample virtual pixels, which in turn will display **black** across the output. Therefore, it is important to generate a **pixel-perfect** content template to render video content from.

**Please note:** When setting the resolution of a screen in Disguise software, the UV map is **divided** into a **grid** of the same resolution, and in turn each of the grid's quads are **sampled** by the screen and **outputted** to the LED processor. Normally, it is important to **match** the resolution of the screen to the physical screen but, in this case, Disguise's screen should have a **higher** resolution to allow for virtual pixels. Therefore, it is **highly recommended** to test playback performance before running a live show. For further information see the [How Does Disguise Sample UV Maps](#) page.

## Example 4: Millenia Tower

This case study shows how Singapore's [Millenia Tower](#) was prepared for Disguise software. The key difference here is the screens used Pulsar Chroma lights, which are DMX controlled fixtures. The previous case studies explained how to prepare DVI controlled fixtures for Disguise, although Disguise maps DMX pixels in the *same* way it does DVI pixels. Therefore, the 3D modelling and UV mapping techniques covered earlier apply here. However, it is important to understand Disguise's DMX screen sends RGB data over Art-Net and other supported protocols, instead of the Output Feeds. To read more about DMX screens, see the [Creating DMX screens](#) sub-chapter.

### How the UV map is generated

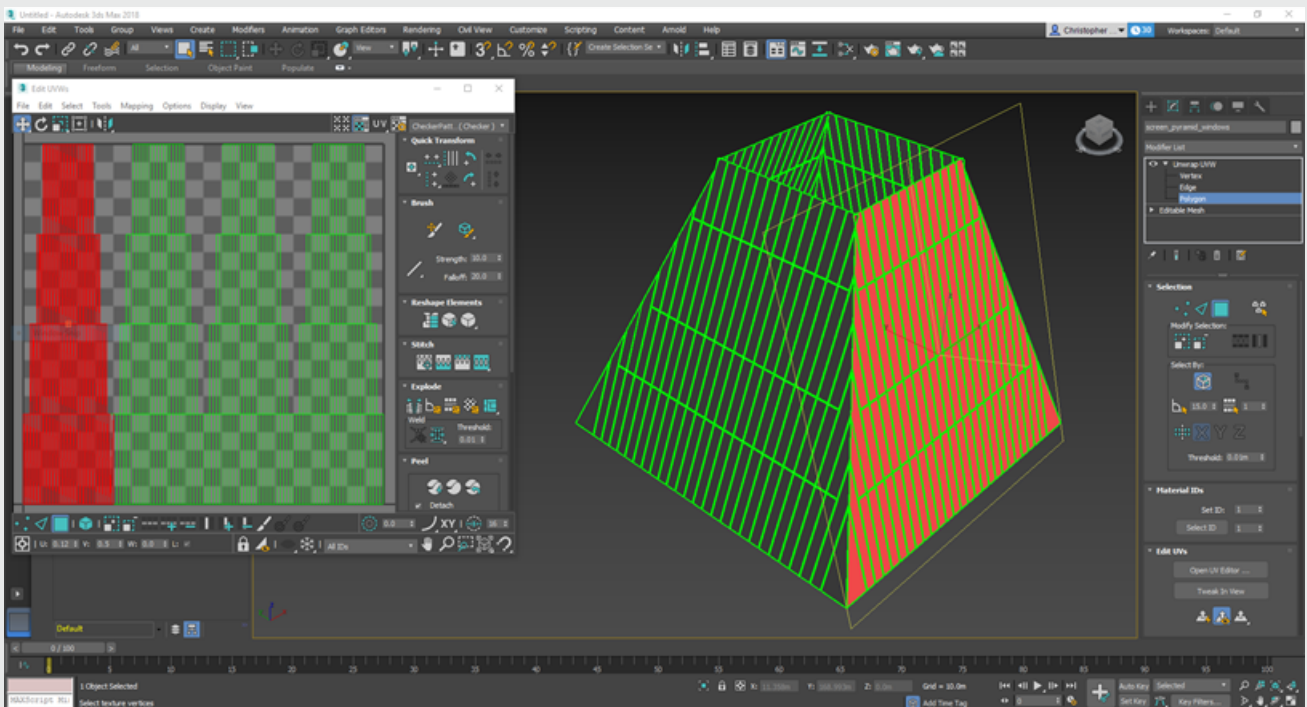

The Millenia Tower's UV map was generated using a combination of techniques applied previously, which explained how to **unwrap** a 3D model into a **grid**.

Similar to the [DNA Spiral](#), this UV map contains gaps **separating** the tower's four sides, although in this case the 3D model does **not** contain the same gaps.

The UV map was designed on the basis that each Chroma light would be mapped in Disguise to a resolution of 1x1 pixels. Consequently, in **Autodesk 3ds Max** each Chroma light was assigned one UV shell, all of which **matched** in scale, because



this ensured Disguise's **Direct** map **precisely** sampled the UV map. Because the tower's upper levels contain less Chroma lights than the lower levels, the UV map's upper levels contained less UV shells than the lower levels, resulting in **virtual gaps**.

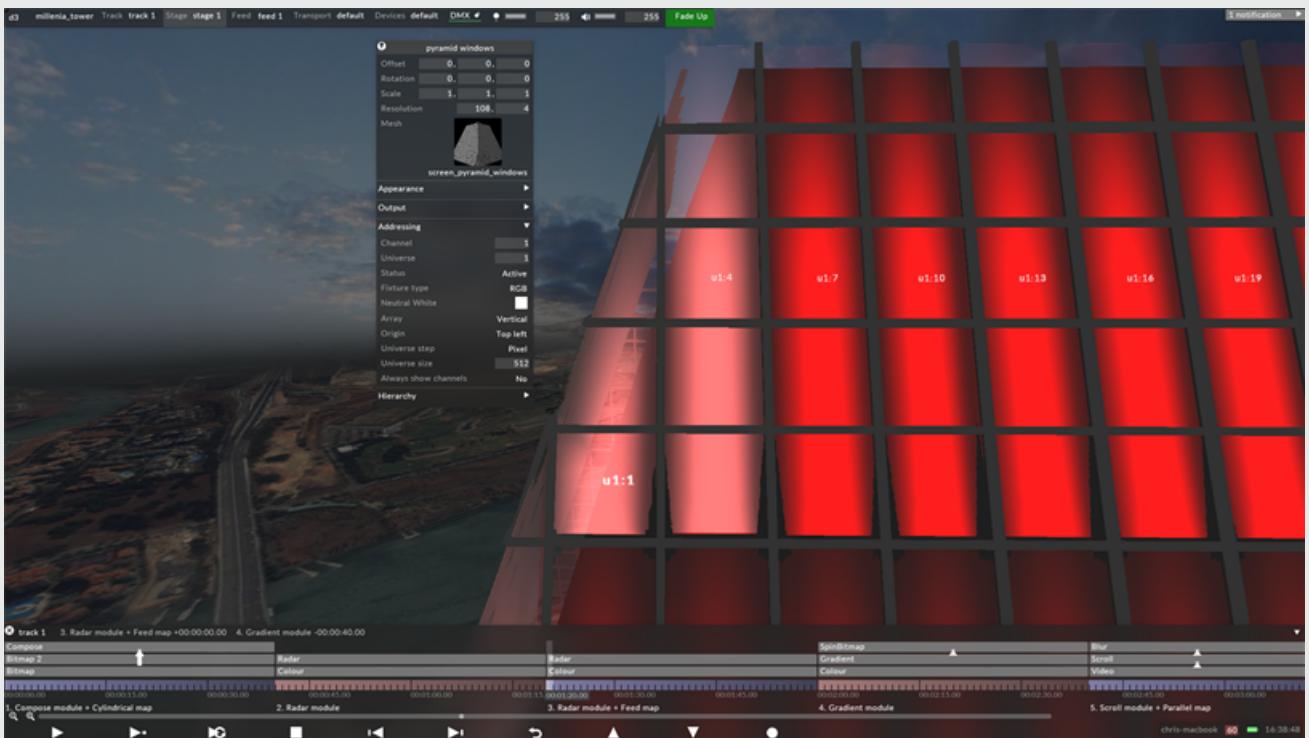
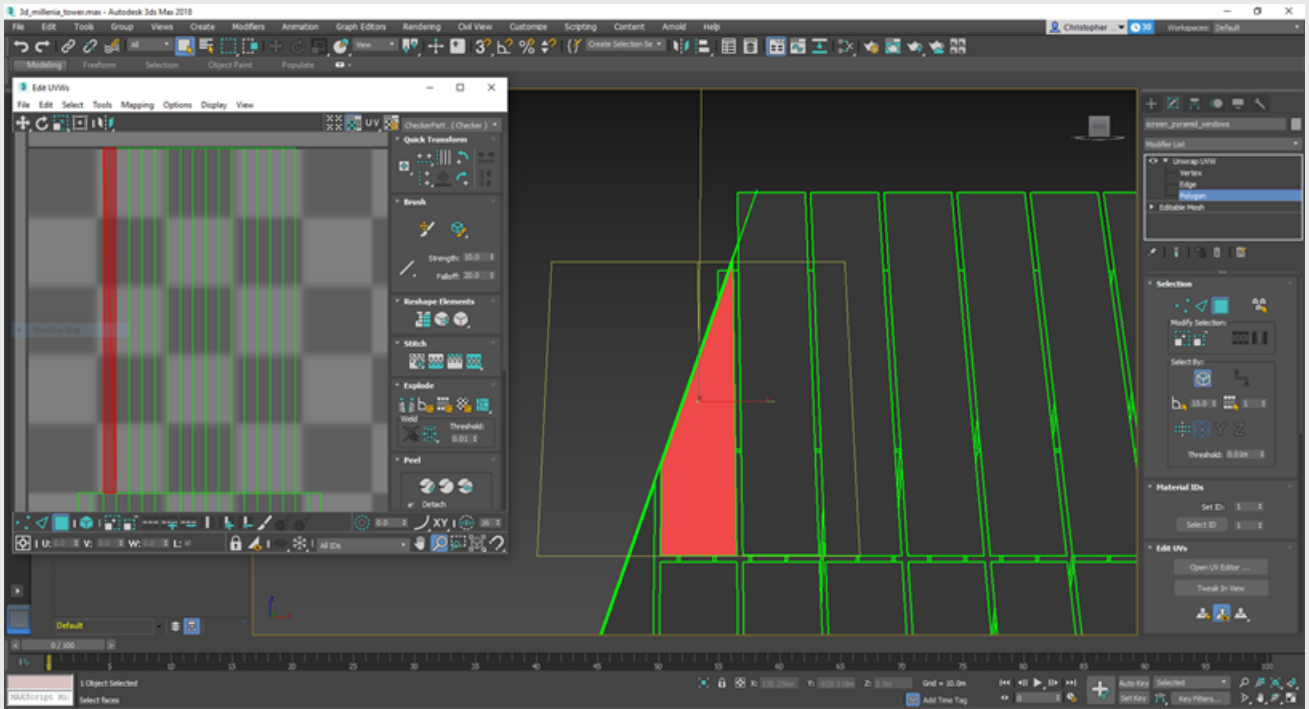



#3 millenia\_tower Track track 1 Stage stage 1 Feed feed 1 Transport default Device default DMX 2 255 255 Fade Up

Monitor	DMX Monitor	Output
Universe		Decimal
Layer		10 Per Row
1	2 3 4 5 6 7 8 9 10	
11	255 33 33 255 29 29 255 19 19 255	
21	0 252 0 0 252 0 0 252 0 0	
31	252 0 0 252 0 0 252 0 0 252	
41	0 0 252 0 0 252 0 0 252 0	
51	0 252 0 0 252 0 0 252 0 0	
61	252 0 0 252 0 0 252 0 0 252	
71	0 0 252 0 0 252 0 0 252 0	
81	0 252 0 0 252 0 0 252 0 0	
91	252 0 0 252 0 0 252 0 0 252	
101	0 0 252 0 0 252 0 0 252 0	
111	0 252 0 0 252 0 0 252 0 0	
121	252 0 0 252 247 245 255 234 255	
131	225 223 255 218 216 255 212 210 255 207	
141	206 255 198 196 235 186 185 235 174 173	
151	255 159 158 255 143 142 255 129 128 255	
161	112 111 255 98 95 255 81 81 255 49	
171	49 255 38 37 255 47 47 255 40 40	
181	0 0 0 0 0 0 0 0 0 0	
191	0 0 0 0 0 0 0 0 0 0	
201	0 0 0 0 0 0 0 0 0 0	
211	0 0 0 0 0 0 0 0 0 0	
221	0 0 0 0 0 0 0 0 0 0	
231	0 0 0 0 0 0 0 0 0 0	
241	0 0 0 0 0 0 0 0 0 0	
251	0 0 0 0 0 0 0 0 0 0	
261	0 0 0 0 0 0 0 0 0 0	
271	0 0 0 0 0 0 0 0 0 0	
281	0 0 0 0 0 0 0 0 0 0	
291	0 0 0 0 0 0 0 0 0 0	
301	0 0 0 0 0 0 0 0 0 0	
311	0 0 0 0 0 0 0 0 0 0	
321	0 0 0 0 0 0 0 0 0 0	
331	0 0 0 0 0 0 0 0 0 0	
341	0 0 0 0 0 0 0 0 0 0	
351	0 0 0 0 0 0 0 0 0 0	
361	0 0 0 0 0 0 0 0 0 0	
371	0 0 0 0 0 0 0 0 0 0	
381	0 0 0 0 0 0 0 0 0 0	
391	0 0 0 0 0 0 0 0 0 0	
401	0 0 0 0 0 0 0 0 0 0	
411	0 0 0 0 0 0 0 0 0 0	
421	0 0 0 0 0 0 0 0 0 0	
431	0 0 0 0 0 0 0 0 0 0	
441	0 0 0 0 0 0 0 0 0 0	
451	0 0 0 0 0 0 0 0 0 0	
461	0 0 0 0 0 0 0 0 0 0	
471	0 0 0 0 0 0 0 0 0 0	
481	0 0 0 0 0 0 0 0 0 0	
491	0 0 0 0 0 0 0 0 0 0	
501	0 0 0 0 0 0 0 0 0 0	
511	0 0 0 0 0 0 0 0 0 0	

Track 1 2. Radar module +00:00:00.00 3. Radar module + Feed map -00:00:40.00

Composite Bitmap 2 Bitmap 2. Radar Colour Radar Colour Scrollmap Gradient Colour Scroll Video

1. Composite module + Cylindrical map 00:00:15.00 2. Radar module 00:00:40.00 3. Radar module + Feed map 00:01:15.00 4. Gradient module 00:02:15.00 5. Scroll module + Parallel map 00:03:00.00

rbt-madben 14:40:29

# Projection Examples Overview

This sub-chapter will teach you how to UV map Projection screens for Disguise software. The following examples revisit the UV mapping principles covered in the previous sub-chapter. Therefore, it is recommended to read this first.

Topics include:

- Cylindrical Mapping
- Pelt Mapping
- Perspective Mapping
- Pixel Perfect Mapping
- Planar Mapping
- Shrink Wrapping
- Spline Mapping



# Cylindrical mapping

Cylindrical mapping is suitable for projection surfaces wrapping around 360 degrees, for example a cylinder or a bottle.

## How the UV map is generated

The Cylindrical map will **cylindrically** project UV coordinates to the surface, by **arraying** the map around 360 degrees. This will enable **symmetrical** content to flow across the surface **smoothly**. However, because the UV map is joined at a seam, **asymmetrical** content will **not** flow around the surface smoothly.

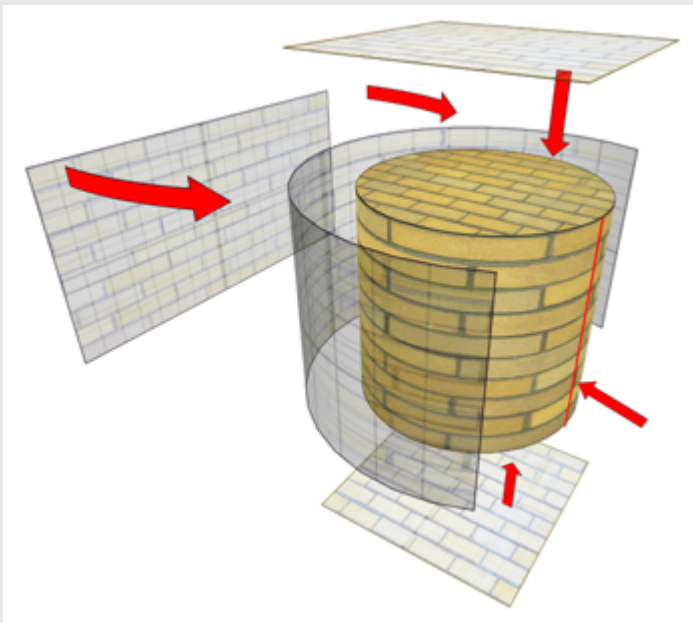

# Step 1 - Generating the UV map (3ds Max)

1. Select the UVW Map modifier.
2. From the list of projection types select **cylindrical**.
3. The cylindrical map will project UV coordinates from its normals to the surface. Therefore, it is necessary to fit the cylindrical map's position, orientation and scale to the surface.
4. Select the Unwrap UVW modifier.
5. Open the Edit UVWs window to view the UV map.

The image below shows a **non-uniform** checker pattern rendered to the surface, which indicates the UV map has an **uneven** distribution of UV coordinates. To fully unwrap the surface the UV map should be *relaxed*.

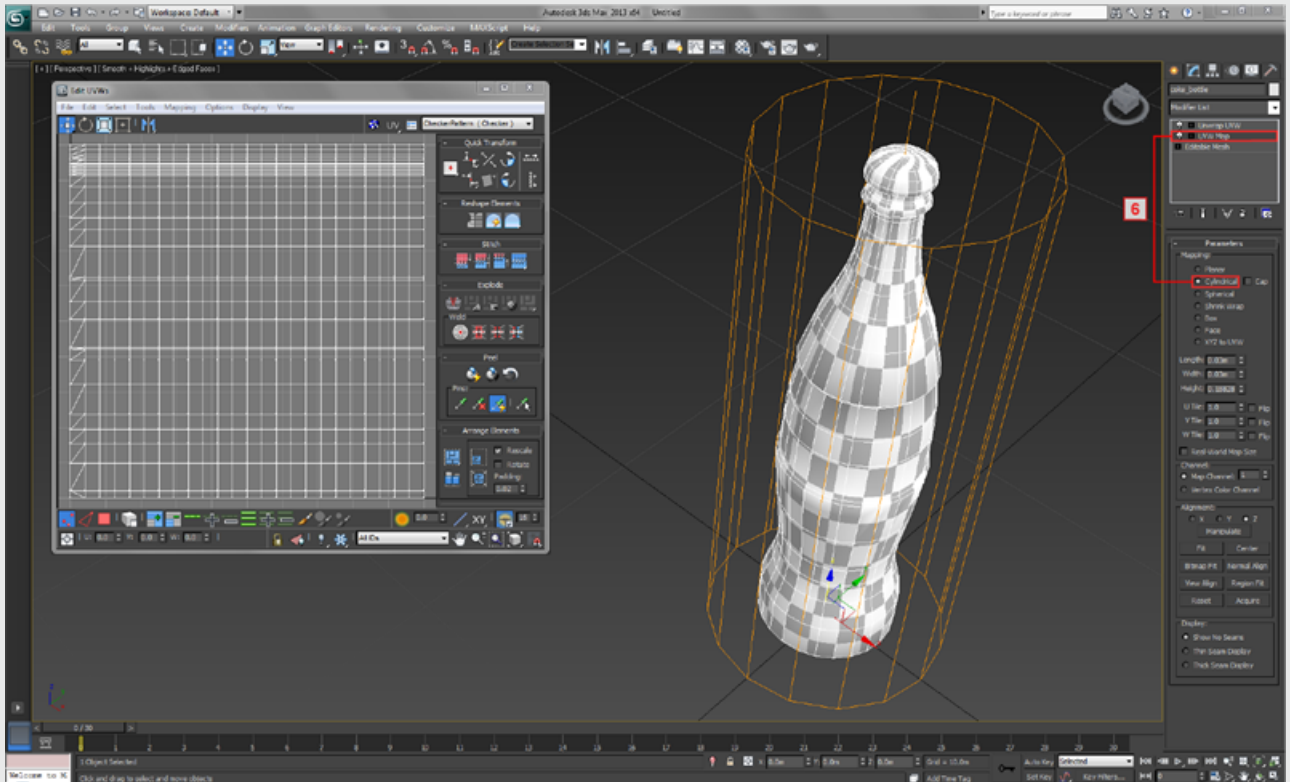

A 3D model of a coke bottle cylindrically mapped in 3ds Max.

## Step 2 - Rendering UV maps to content templates

The images below show two content templates mapped to the screen in Disguise software. The template's resolution was calculated by following the same technique used for Shrink wrapped projection surfaces, because when a surface is Cylindrically mapped it is problematic to calculate the resolution **mathematically**.

If a **horizontal** line is drawn across the template, in Disguise it will seamlessly map to the screen.

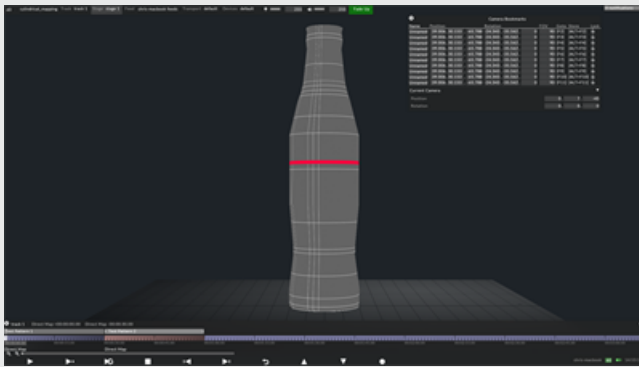
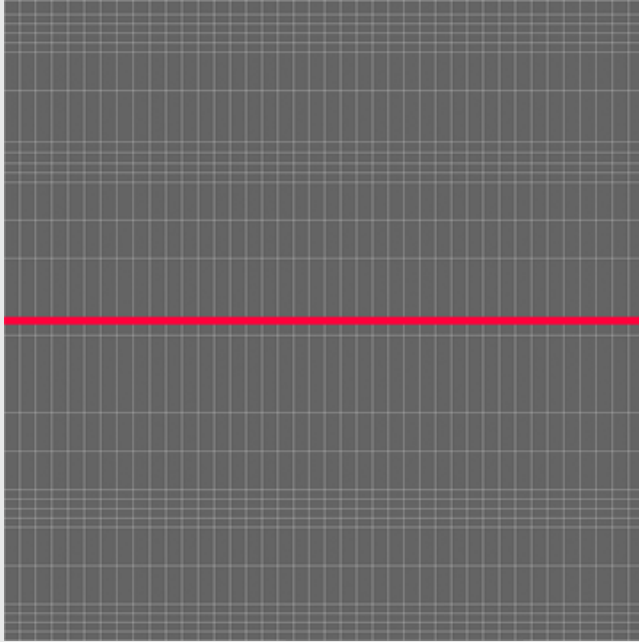

A 2D content template rendered from 3ds Max and applied to the coke bottle in Disguise. Notice how the horizontal line maps onto the 3D model seamlessly.

If a **diagonal** line is drawn across the template, in Disguise it will reveal a seam when mapped to the screen.

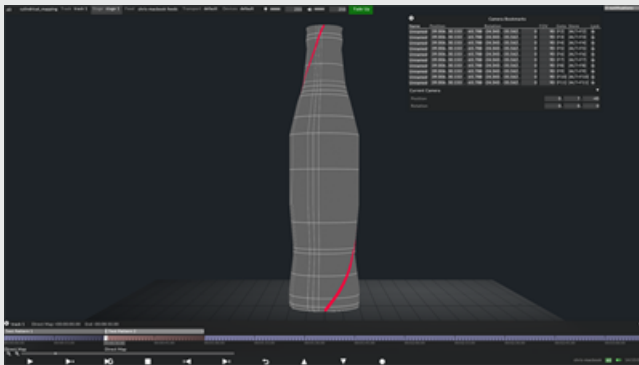
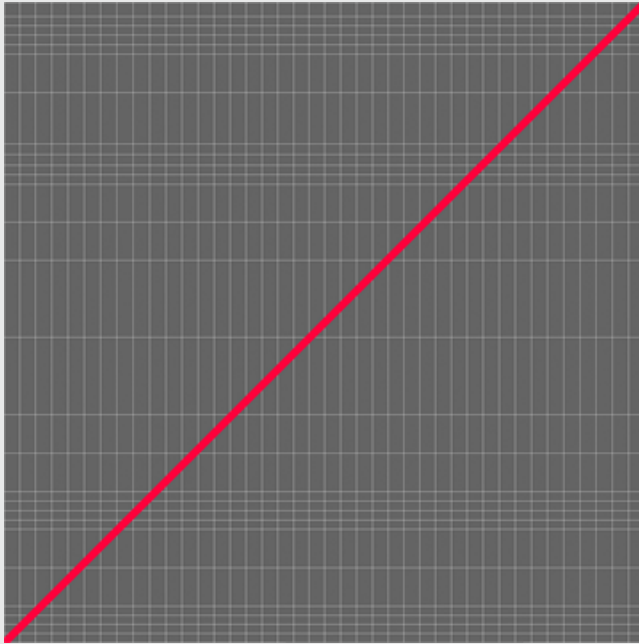

A 2D content template rendered from 3ds Max and applied to the coke bottle in Disguise. Notice how the diagonal line reveals a seam at its start and end points.

## Helpful resources

- [Projecting cylindrical maps in 3ds Max](#)
- [Unwrapping UVs in 3ds Max](#)
- [Editing UVs in 3ds Max](#)
- [Flattening UVs in 3ds Max](#)
- [Unfolding UVs in 3ds Max](#)
- [Rendering content templates in 3ds Max](#)

# Pelt mapping

Pelt mapping is suitable for projection surfaces curving across multiple axes, which are problematic to unwrap using other mapping types, for example a body or a head.

## How the UV map is generated

The Pelt map features a **stretcher** that can be manipulated by **springs** to **pull** the UV map outwards. This enables **precision** control over the UV coordinates to ensure they are **evenly** distributed across the **most** complex surfaces, which other mapping types are incapable of **completely** unwrapping.

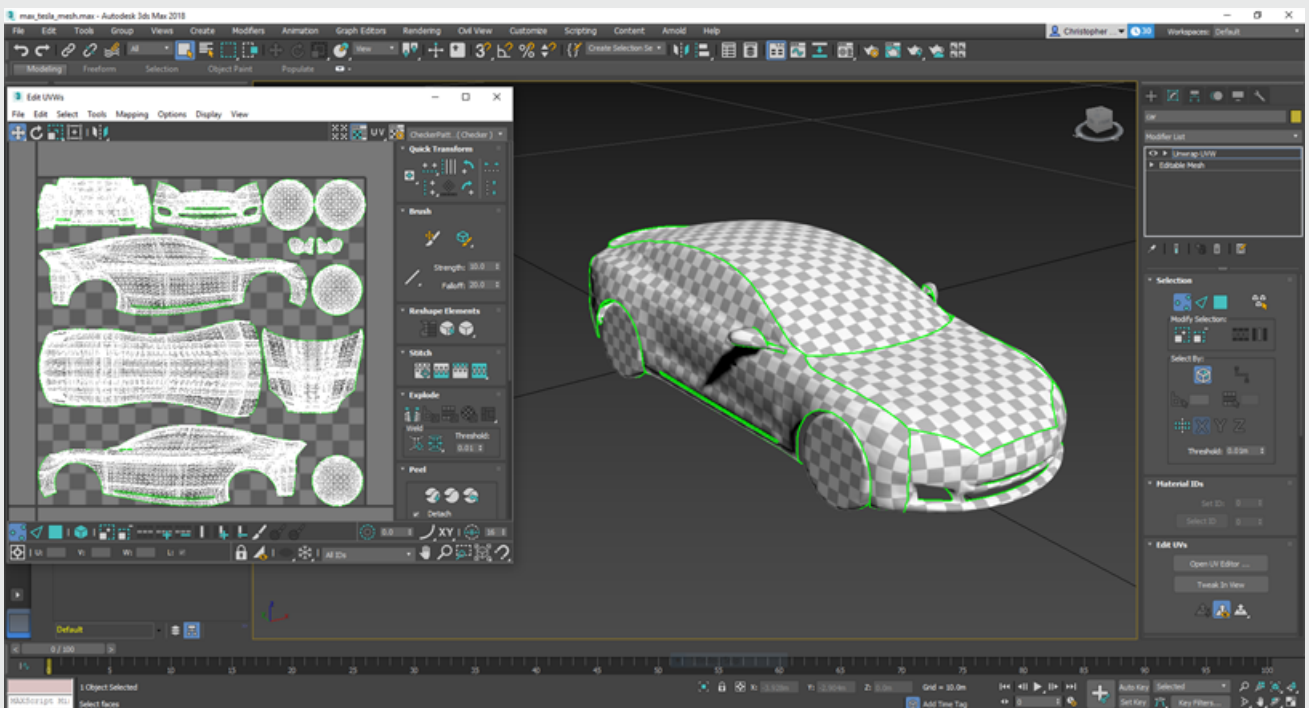



# Step 1 - Generating the UV map (3ds Max)

1. Select the **Unwrap UVW** modifier.
2. From the list of projection types select **pelt mapping**.
3. Open the **Edit UVWs** window to view the UV map.

The image below shows a **non-uniform** checker pattern rendered to the surface, which indicates the UV map has an **uneven** distribution of UV coordinates.

4. To fully unwrap the surface the pelt map's stretchers should be **pulled** outwards until the UV map **accurately** represents the **true** shape of the projection surface.

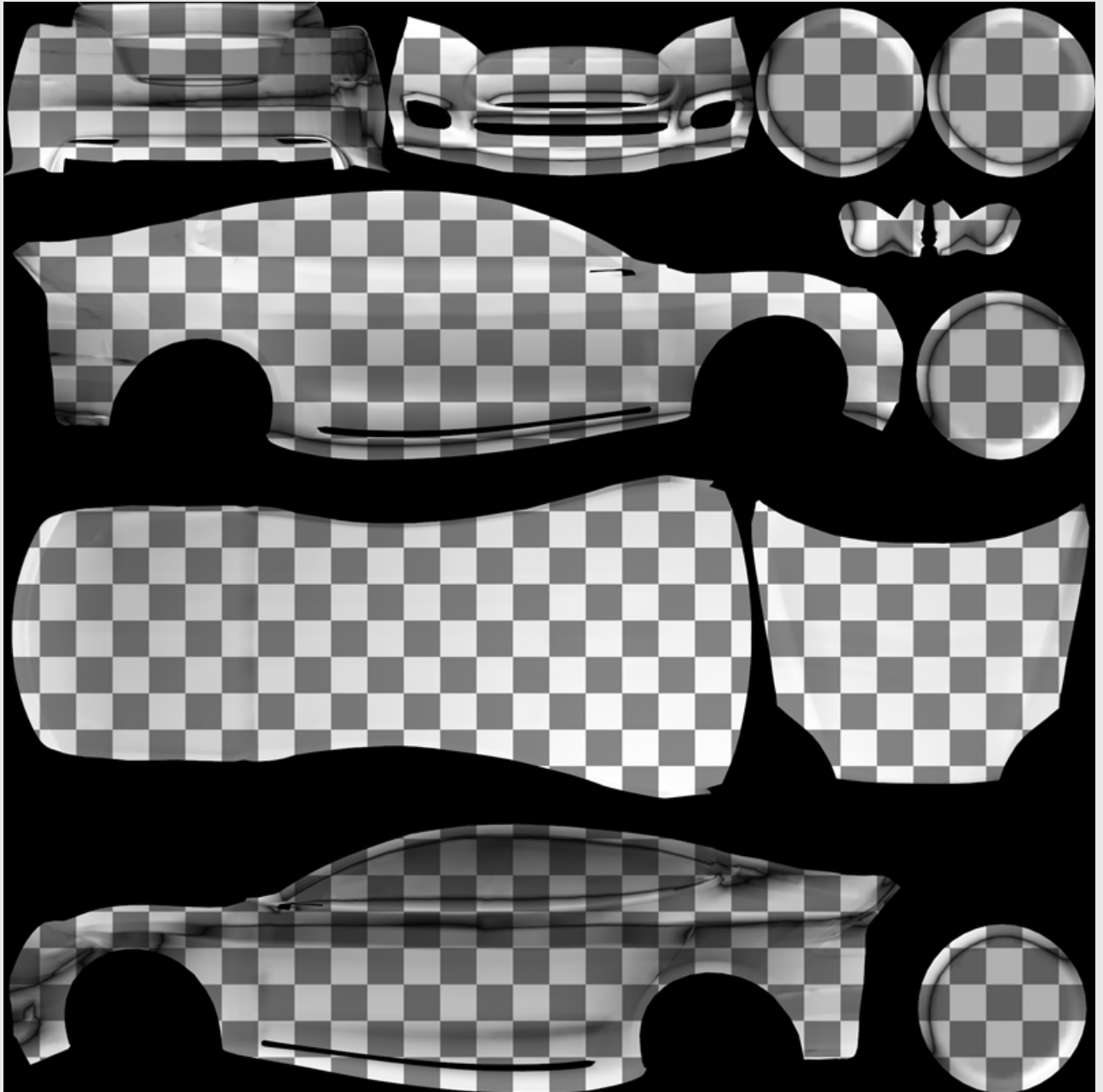

*A 3D model of a car pelt mapped in 3ds Max.*

## Step 2 - Rendering UV maps to content templates

The image below shows the content template mapped to the screen in Disguise. The template's resolution was calculated by following the same technique used for Shrink wrapped / Cylindrical mapped projection surfaces, because when a surface is Pelt mapped it is problematic to calculate the resolution **mathematically**.

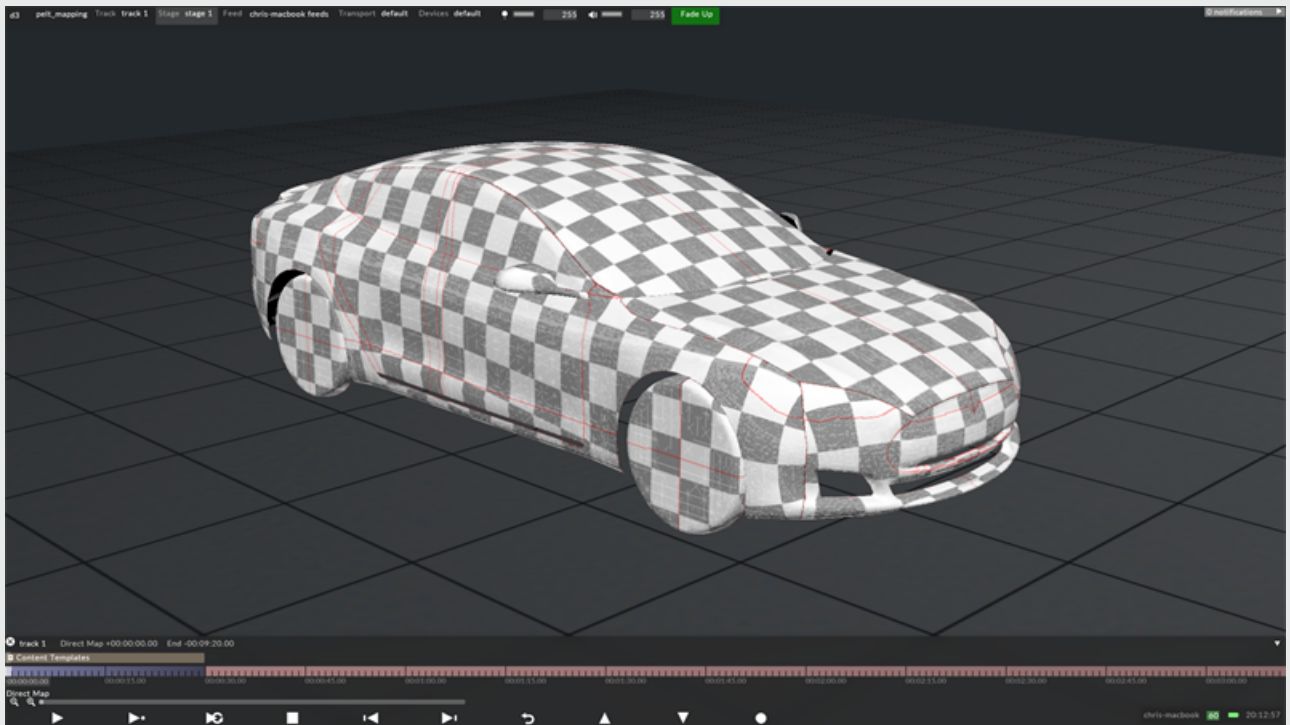

For more information:

[Autodesk 3ds Max Learning center](#)

# Perspective Mapping

Perspective mapping is suitable for projection surfaces to display content rendered to a single point of view, for example building blocks animating into a building. However, perspective mapping is also suitable for 2D content, as explained below.

## How the UV map is generated

A camera can perspective project UV coordinates from its point of view to the surface. The UV map can then be rendered to a content template to be placed as a background in Adobe After Effects. Here the content creator can render 2D content and in Disguise software the content will map perfectly to the screen. The 2D content will appear correct from any point of view.

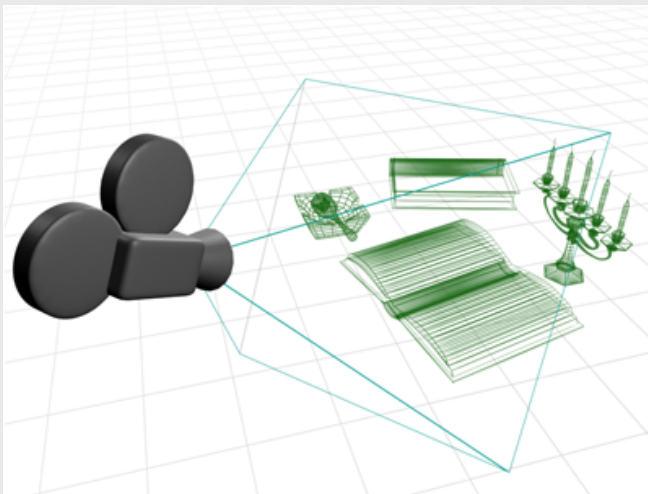

In a 3D application the content creator can also render 3D content by rendering 3D effects from a camera's point of view. The render camera should match the position of the previous camera, and the 3D content should be rendered to a resolution that matches the 2D content. The mapped 3D content will only appear correct from the render camera's point of view. Therefore, both cameras should be positioned to the point of view from which the audience will view the projection surface.

# Step 1 - Generating the UV map (3ds Max)

1. Create a camera in your 3D scene.
2. Adjust its position, field of view and zoom, to capture the surface's outer edge. In the camera's viewport safe frames can be enabled to show the captured area more clearly.
3. Select the surface and apply a Camera Map modifier.
4. From the Camera Map modifier pick camera. The camera will perspective project UV coordinates onto the surface.
5. Select the Unwrap UVW modifier.
6. Open the Edit UVWs window to view the UV map.

The image here shows a non-uniform checker pattern rendered to the surface. However, from the camera's point of view the UV map will appear to have an even distribution of UV coordinates.

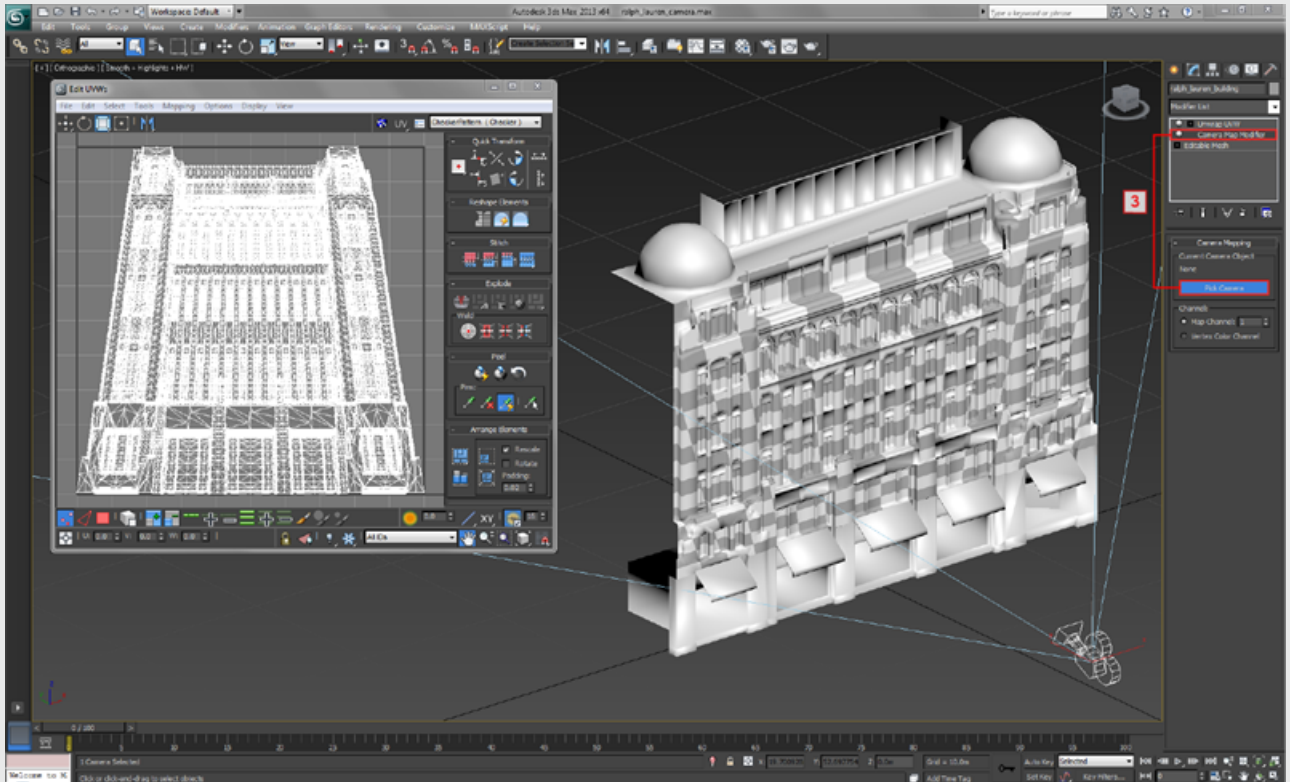

## Step 2 - Rendering UV maps to content templates

- The images below show the content template and how its resolution was calculated. The template's resolution was calculated from the render settings set to generate 3D content, because when a projection surface is perspective mapped the UV map can be used to generate both 2D and 3D content. Therefore, the 2D and 3D content should match in resolution.
- The UV map can be rendered to a template to be placed as a background in Adobe After Effects, to generate 2D content.
- The UV map can have animated geometry baked into it in a 3D application, for example 3ds Max, to generate 3D content.

The template's resolution is 4096x1576 pixels. This was calculated by:

- Knowing the aspect ratio of the camera's output (this is automatically generated by the camera output's width and height, shown in the render settings).
- Knowing precisely how many pixels produced by the projector will hit the projection surface, across either the horizontal or vertical axis.
- Multiplying or dividing this value by the aspect ratio, to calculate a resolution for the remaining axis.

Therefore, the following calculations apply:

- The camera's output has an aspect ratio of 2.599.
- Approximately 4096 pixels will hit the projection surface horizontally.
- $4096 \text{ pixels} / 2.599 = 1576 \text{ pixels}$  (the vertical resolution).

# Render settings from 3ds Max.

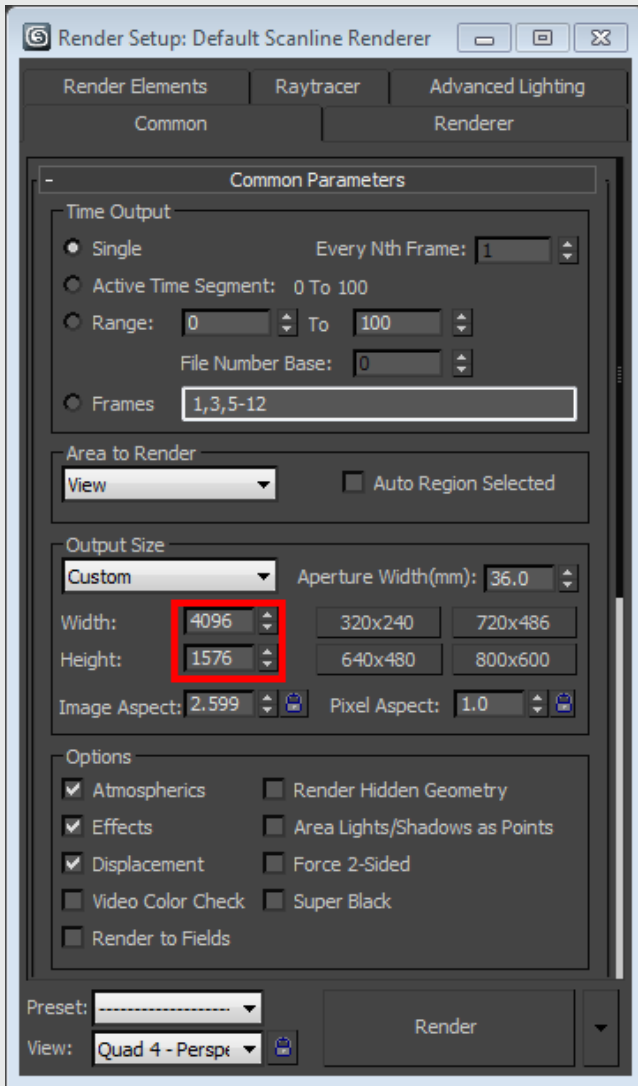

The images below show the content template and examples of 2D and 3D content rendered from the UV map.





*A 2D content template of the Ralph Lauren London Flagship Store rendered from 3ds Max.*

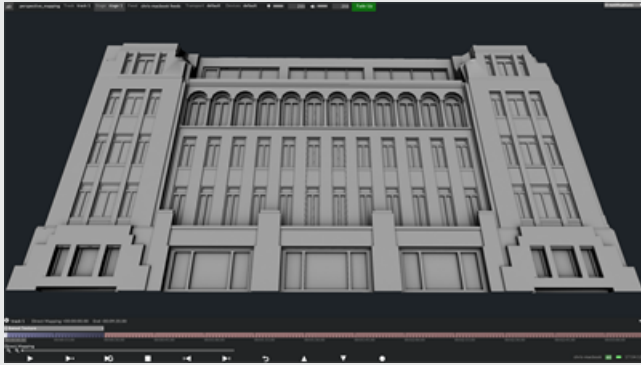

# Pixel-perfect mapping

Pixel-perfect mapping is suitable for projection surfaces bending across one axis, for example a wall constructed from multiple angled surfaces.

## How the UV map is generated

A spline can be **extruded** to recreate the surface with the UV map **automatically generated**. Because the UV coordinates are generated by the extrusion, the UV map will have a **perfectly** even distribution of UV coordinates.

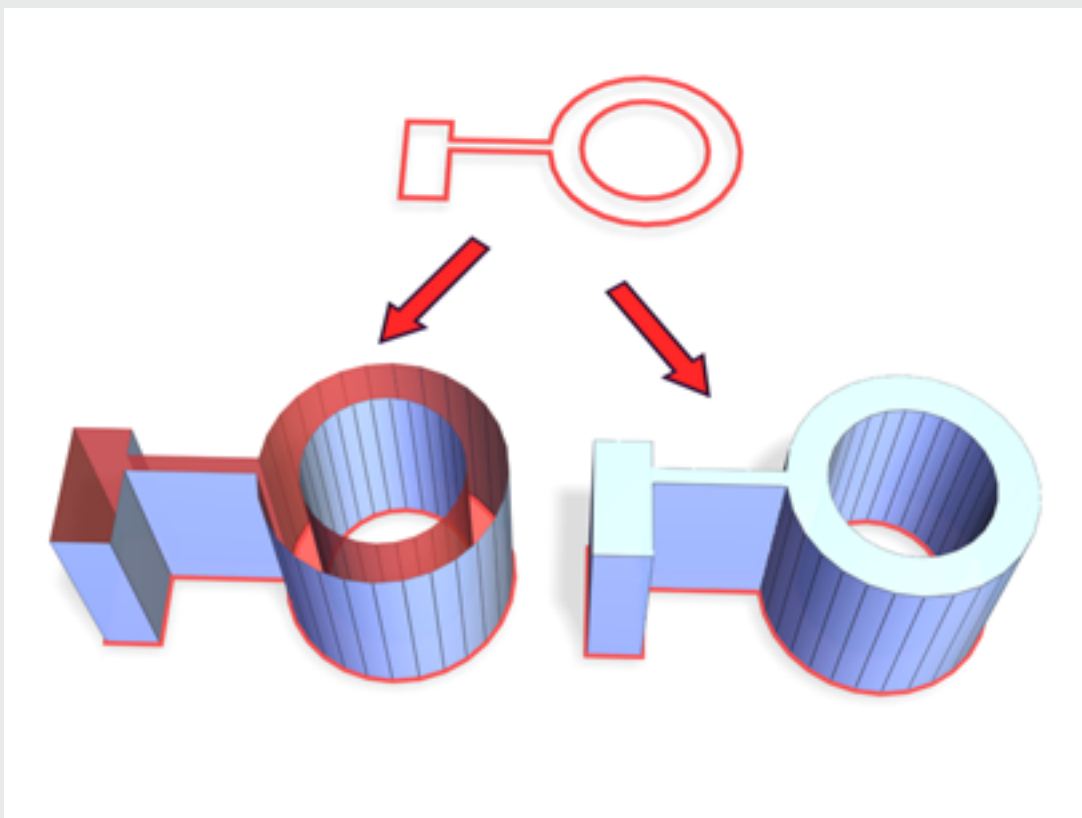

# Step 1 - Generating the UV map (3ds Max)

1. Draw a spline that traces the surface's bottom edge.
2. Apply an Extrude modifier to extrude the spline to match the surface's height.
3. Ensure you have the box called **generate mapping coordinates** checked when extruding the spline. Doing so will enable the extrusion to automatically generate a normalised UV map.
4. Select the Unwrap UVW modifier.
5. Open the Edit UVWs window to view the UV map.
6. Check the UV coordinates are correctly **flipped** by comparing the positions of the surface's vertices to the UV map's texture coordinates. Before performing the check, ensure the surface is orientated and viewed in a south-north (front-back) direction. The image below shows the surface's top-left vertice corresponds to the UV map's top-left texture coordinate. This is correct. If the UV coordinates were incorrectly flipped, in Disguise, the video content would be **mirrored** across the screen when Direct mapped, for example a **Radar** layer would scan the screen in the **opposite** direction.

The image below shows a **uniform** checker pattern rendered to the surface, which indicates the UV map has an **even** distribution of UV coordinates. If the checker pattern appeared non-uniform, i.e. the checkers were differently sized, this would indicate the UV map had an **uneven** distribution of UV coordinates.

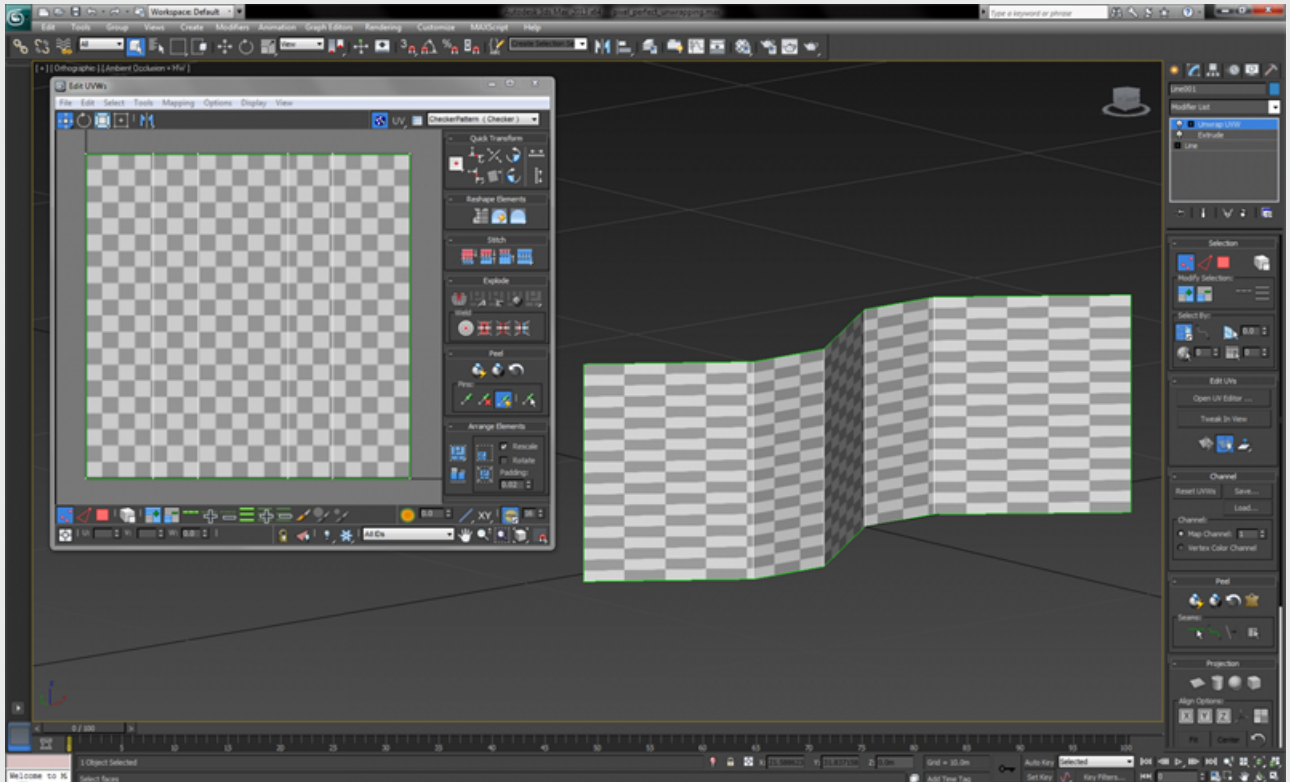

*A pixel-perfect UV mapped surface in 3ds Max.*

## Step 2 - Rendering UV maps to content templates

The image below shows the content template, which was rendered from the UV map. The template's resolution was calculated by:

- Knowing precisely how many pixels produced by the projector will hit the projection surface, across **either** the horizontal or vertical axis.
- Dividing this value by the projection surface's dimension across the chosen axis, to calculate a **pixel density**.
- Multiplying the pixel density by the remaining axis' dimension, to calculate its resolution.

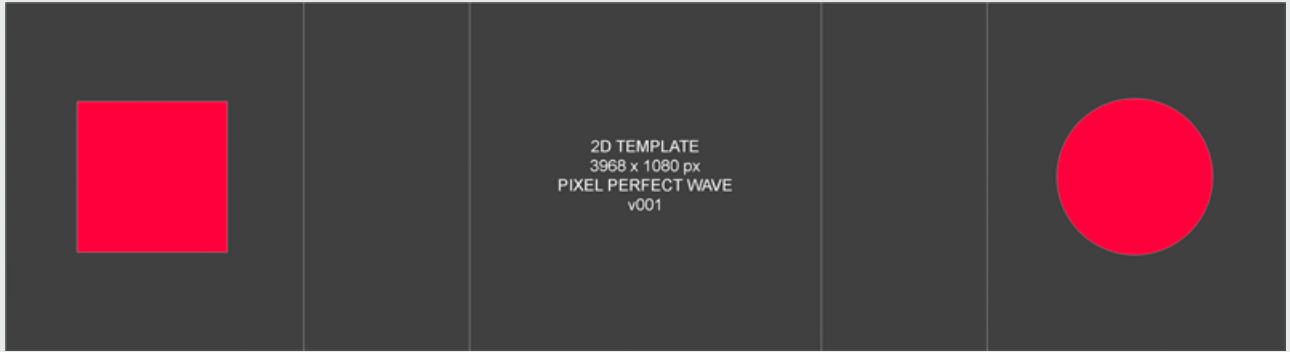

## UV map rendered to a content template.

It is important to measure the projection surface's dimensions based on the UV map. In this case, the total length of the extruded spline should be measured, because the extrusion automatically generated the normalised UV map

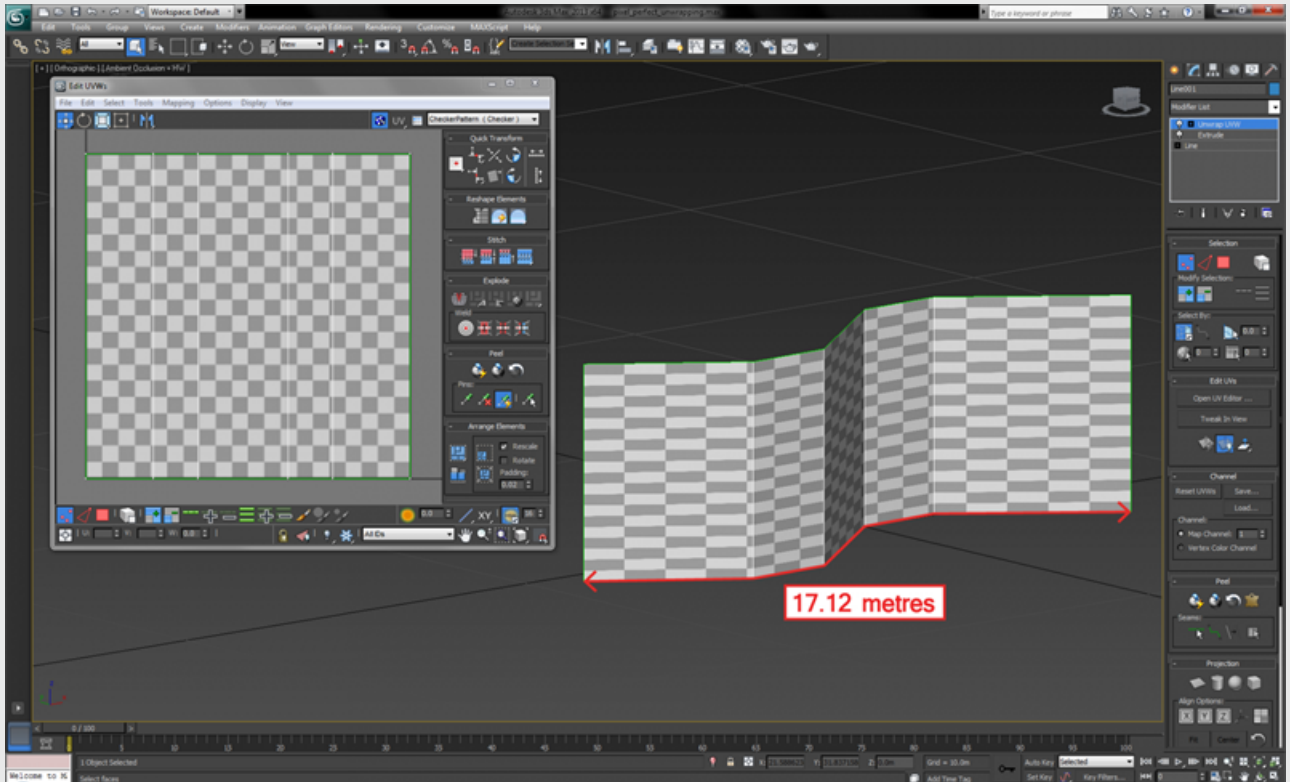

By calculating both the template's horizontal and vertical resolutions from a single pixel density value, the content should enable square pixels. This is important because if the resolution is calculated incorrectly the content may appear stretched across the projection surface. The template's resolution is 3698x1080 pixels. This was calculated by:

- Knowing approximately 1080 pixels will hit the projection surface vertically.
- $1080 \text{ pixels} / 5 \text{ meters (the projection surface's height)} = 216 \text{ pixels per meter (hitting the projection surface vertically)}$ .
- $216 \text{ pixels} \times 17.12 \text{ meters (the projection surface's length)} = 3698 \text{ pixels (the horizontal resolution)}$ .

As a result, the aspect of the template's resolution should match that of the surface's dimensions. This can be checked by:

- Dividing the template's horizontal resolution by the vertical resolution.
- Dividing the surface's length by the physical height (remember to base the measurements on the UV map, explained earlier).

In this case:

- $3698 / 1080 = 3.424$
- $17.2 / 5 = 3.424$

Both values are matching, which indicates the template's resolution is correct. To double-check this, a uniform square and circle should be drawn on the template in an image editing application, for example Adobe Illustrator, before the template is exported to Disguise software. If the square and circle appear uniform across the screen in Disguise the template's resolution is correct.

## Step 3 - Mapping content to screens

The image below shows the content template directly mapped to the screen in Disguise, which was exported as an `.obj` file from 3ds Max. In Disguise software three HD virtual projectors have been configured to sample content from the screen. Each virtual projector samples a different part of the screen, and in realtime the sampled content is outputted to the physical projectors by three unique feeds.

**Please note:** Remember to set the resolution of the screen in Disguise to match the content template by opening the Screen editor.

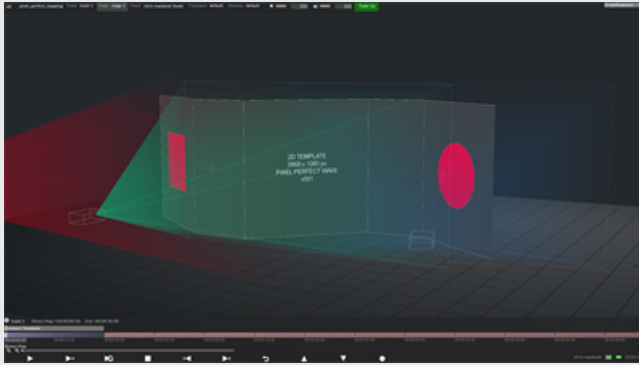

Template re-applied on the screen in Disguise.

## Step 4 - Outputting content to projectors

The image below shows the three unique feeds to be outputted to the physical projectors. If a virtual projector changes position its corresponding output will automatically update in realtime to show the virtual projector's updated point of view. Therefore, if a virtual projector's position changes onsite, content does not require re-rendering, because the outputs are independent of the content. To read more about Disguise's projector simulation toolkit see the [Projector simulation](#) chapter, which explains how to [quick calibrate](#), [warp](#), and [blend](#) projectors using Disguise software.

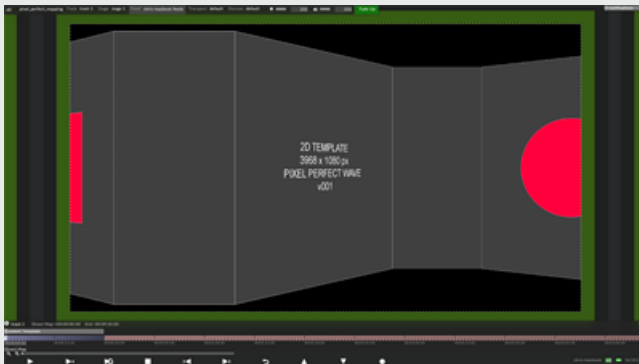

The automatically generated outputs from the three virtual projectors.

## Helpful resources

- [Drawing splines in 3ds Max](#)
- [Extruding splines in 3ds Max](#)



- Unwrapping UVs in 3ds Max
- Editing UVs in 3ds Max
- Rendering content templates in 3ds Max

# Planar mapping

Planar mapping is suitable for projection surfaces that have:

- flat surfaces requiring one side to be UV mapped
- shallow surfaces requiring multiple oblique sides to be UV mapped
- for example a plane or a facade

## How the UV map is generated

The Planar map will parallel project UV coordinates to the surface. Therefore, it is important to align the Planar map's position, orientation and scale to the surface.

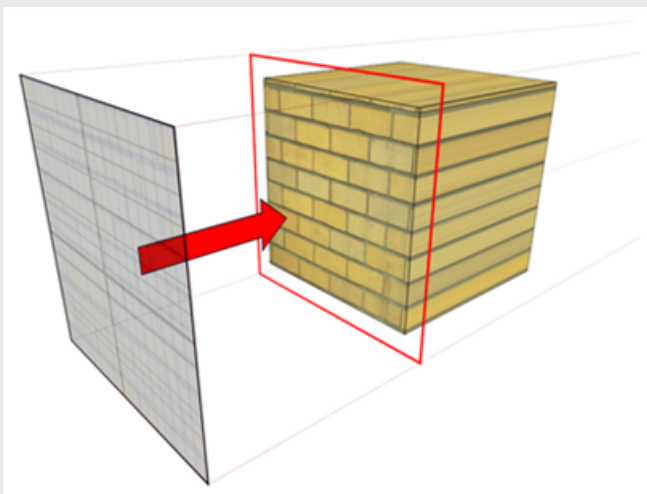

# Step 1 - Generating the UV map (3ds Max)

1. Select the UVW Map modifier.
2. From the list of projection types select planar.
3. The Planar map will project UV coordinates from its normals to the surface. Therefore, it is necessary to fit the planar map's position, orientation and scale to the surface.
4. Select the Unwrap UVW modifier.
5. Open the Edit UVWs window to view the UV map.

The image here shows a uniform checker pattern rendered to the surface, which indicates the UV map has an even distribution of UV coordinates, for all areas facing towards the Planar map. As a result, those areas have a higher UV density than the areas facing away from the Planar map. For example, the windows' side faces have a lower UV density, which will result in content appearing stretched. To avoid this the UV map should be relaxed.

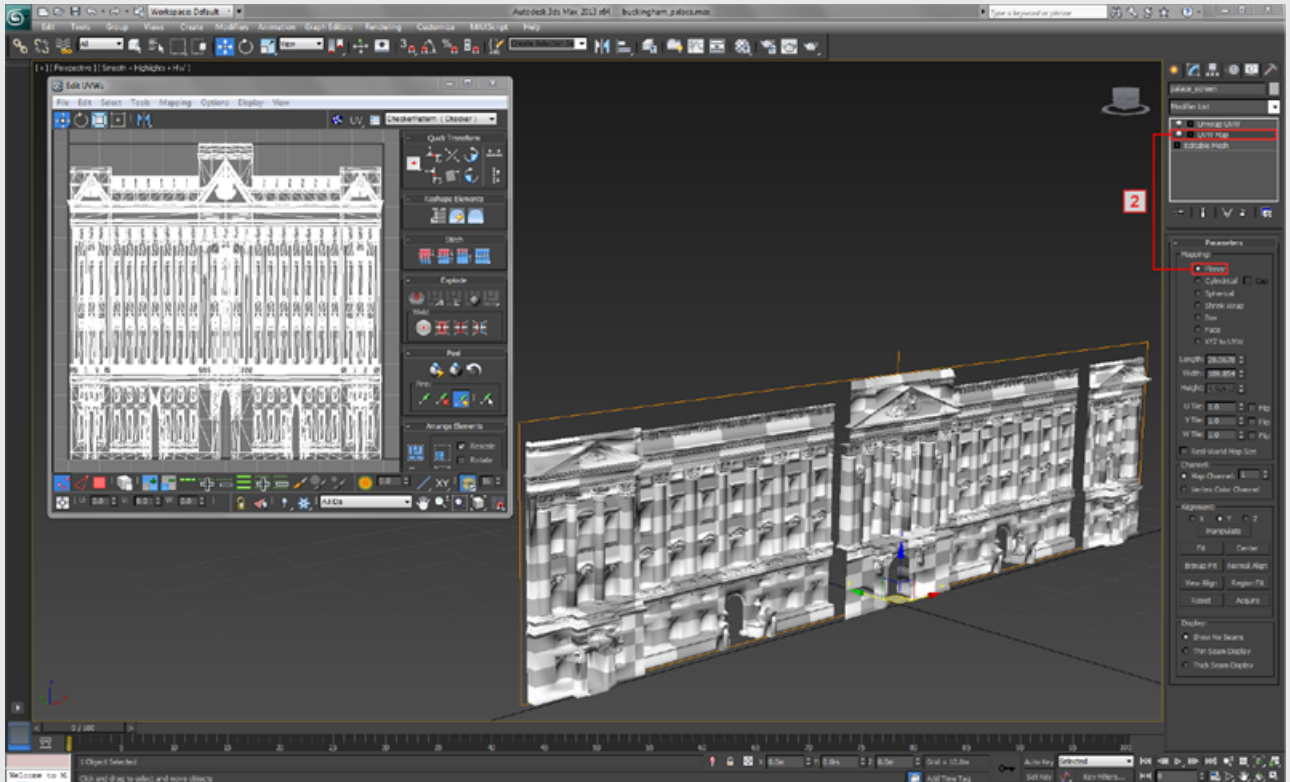

A 3D model of the Buckingham Palace planar mapped in 3ds Max.

## Step 2 - Rendering UV maps to content templates

The image below shows the content template, which was rendered from the UV map. The template's resolution was calculated by following the same technique used for pixel-perfect projection surfaces. However, the key difference is this template was calculated by measuring the dimensions of the Planar map object, because in this case the Planar map automatically generated the normalised UV map.



*A 2D content template of the Buckingham Palace rendered from 3ds Max.*

## Helpful Resources

- [Projecting planar maps in 3ds Max](#)
- [Unwrapping UVs in 3ds Max](#)
- [Editing UVs in 3ds Max](#)
- [Relaxing UVs in 3ds Max](#)
- [Rendering content templates in 3ds Max](#)

# Shrink wrapping

Shrink wrapping is suitable for projection surfaces curving across multiple axes, for example a sphere or a car. However, depending on the creative requirements, a Pelt map may be more suitable.

## How the UV map is generated

The Shrink wrap will spherically project UV coordinates to the surface, by truncating the corners of the map and joining them at a single pole. This will enable content to flow across the surface smoothly, because the UV map will only contain one singularity.

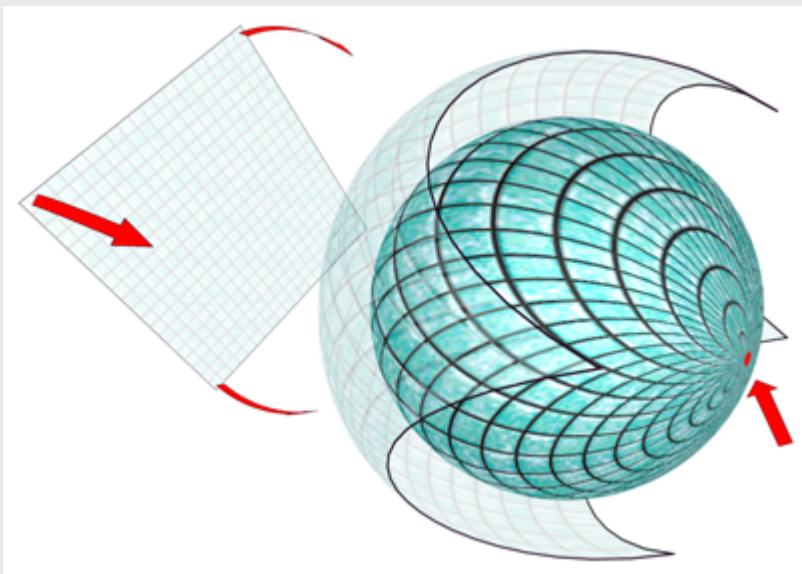

## Step 1 - Generating the UV map (3ds Max)

1. Select the UVW Map modifier.
2. From the list of projection types select shrink wrap.
3. The shrink wrap will project UV coordinates from its normals to the surface. Therefore, it is necessary to fit the shrink wrap's position, orientation and scale to the surface.
4. Select the Unwrap UVW modifier.
5. Open the Edit UVWs window to view the UV map.

The image below shows a non-uniform checker pattern rendered to the surface, which indicates the UV map has an uneven distribution of UV coordinates. To fully unwrap the surface the UV map should be relaxed.

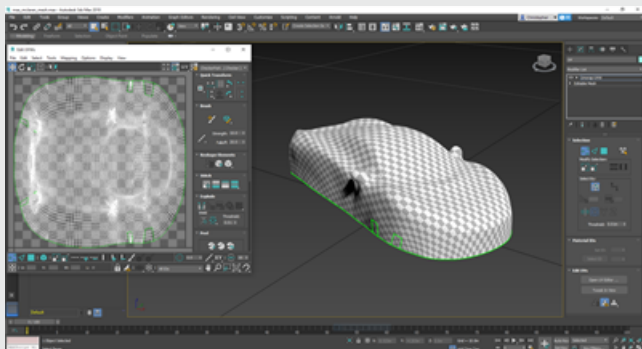

*A 3D model of the Audi A7 mesh shrink wrapped in 3ds Max.*

## Step 2 - Rendering UV maps to content templates

The images below show the content template and how its resolution was calculated. When a projection surface is shrink wrapped, it is problematic to calculate the resolution mathematically. However, it is possible to calculate the resolution visually. The template's resolution is 3448x1424 pixels. This was calculated following the steps below:

1. Export the projection surface as an .obj from the 3D application to Disguise software. Remember to export the .obj's texture coordinates, as explained in the Exporting UV maps

page.

2. In Disguise add the .obj to the Stage as a Screen.
3. Create a Bitmap layer on the Timeline.
4. From the layer's DxTexture library, select a texture with a square aspect.
5. Direct map the texture to the screen.
6. Set the layer's scale mode to pixel-perfect.
7. From the screen's editor, set a resolution for the horizontal or vertical axis that matches, or preferably exceeds, the projector's pixel density. This requires knowing precisely how many pixels produced by the projector will hit the projection surface.
8. Increase / decrease the screen's resolution across the remaining axis until the texture appears square. This will ensure square pixels are enabled.
9. Offset the texture using the pos x and y parameters, to check square pixels are visible across the entire surface.





*A square Bitmap Direct mapped to the car screen in Disguise.*



*A content template rendered from the Audi A7 UV map with a paint texture baked into the shrink wrap.*

## Helpful Resources

- [Projecting shrink wraps in 3ds Max](#)
- [Unwrapping UVs in 3ds Max](#)
- [Editing UVs in 3ds Max](#)
- [Flattening UVs in 3ds Max](#)
- [Unfolding UVs in 3ds Max](#)
- [Rendering content templates in 3ds Max](#)

# Spline mapping

Spline mapping is suitable for projection surfaces curving across multiple axes, for example a coiled snake or a winding road.

## How the UV map is generated

The Spline map will extrude UV coordinates from a selected spline to be projected to the surface. This will enable content to flow across the surface smoothly, because the UV coordinates will match the surface's curvature.

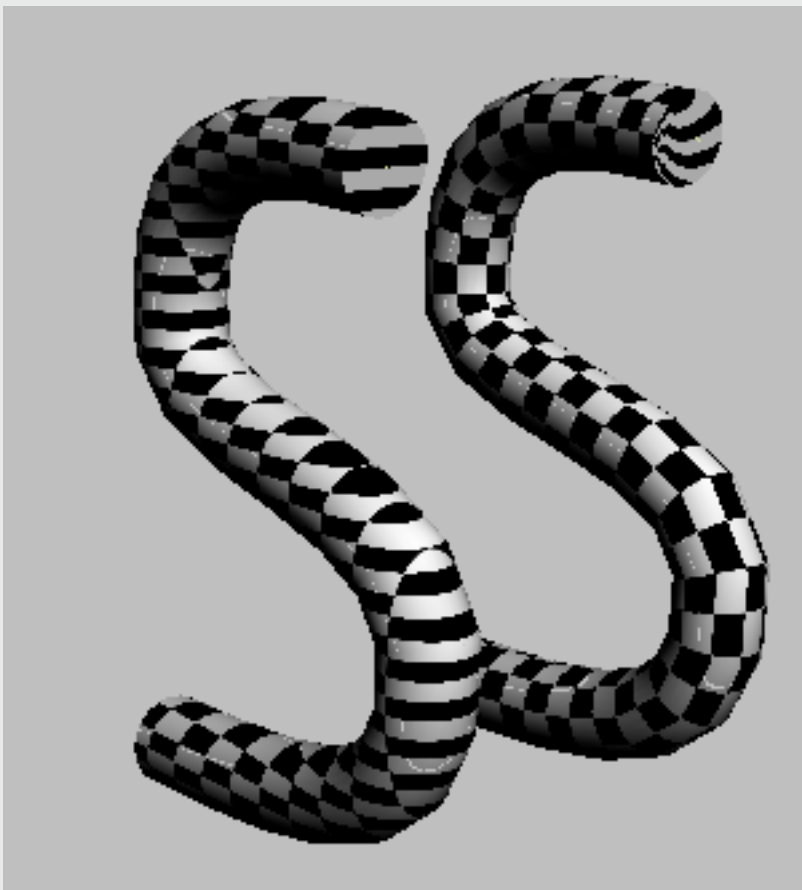

# Step 1 - Generating the UV map (3ds Max)

1. Draw a spline that snaps to the surface's bottom edge.
2. Plot all the vertices in the same vertical position to ensure the UV projection is orientated correctly.
3. Plot the spline across the surface's widest points to ensure the UV projection is assigned to the entire surface.
4. Select the Unwrap UVW modifier.
5. Select all of the surface's faces.
6. From the list of projection types select spline mapping.
7. From the spline map's parameters select pick spline.
8. Open the Edit UVWs window to view the UV map.
9. Rotate and normalise the UV map, if necessary.

The image here shows a uniform checker pattern rendered to the surface, which indicates the UV map has an even distribution of UV coordinates.

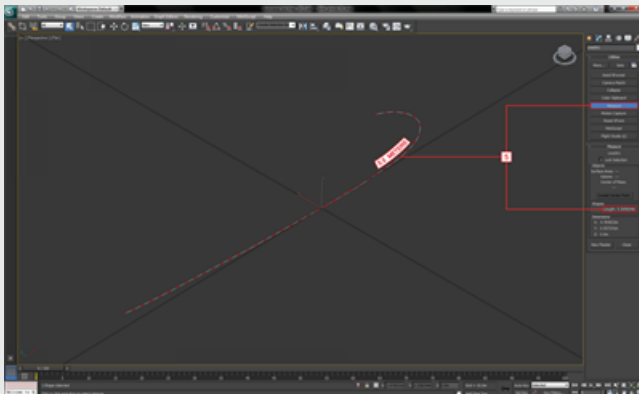

## Step 2 - Rendering UV maps to content templates

The images below show the content template and how its resolution was calculated. The template's resolution was calculated by following the same technique used for pixel-perfect projection surfaces. However, the key difference is this template was calculated by measuring the total length of the extruded spline, because in this case the extrusion automatically generated the UV map.

**Please note:** The 3D application should calculate the total length of the spline automatically. In 3ds Max select the spline, **Command Panel > Utilities > Measure**.

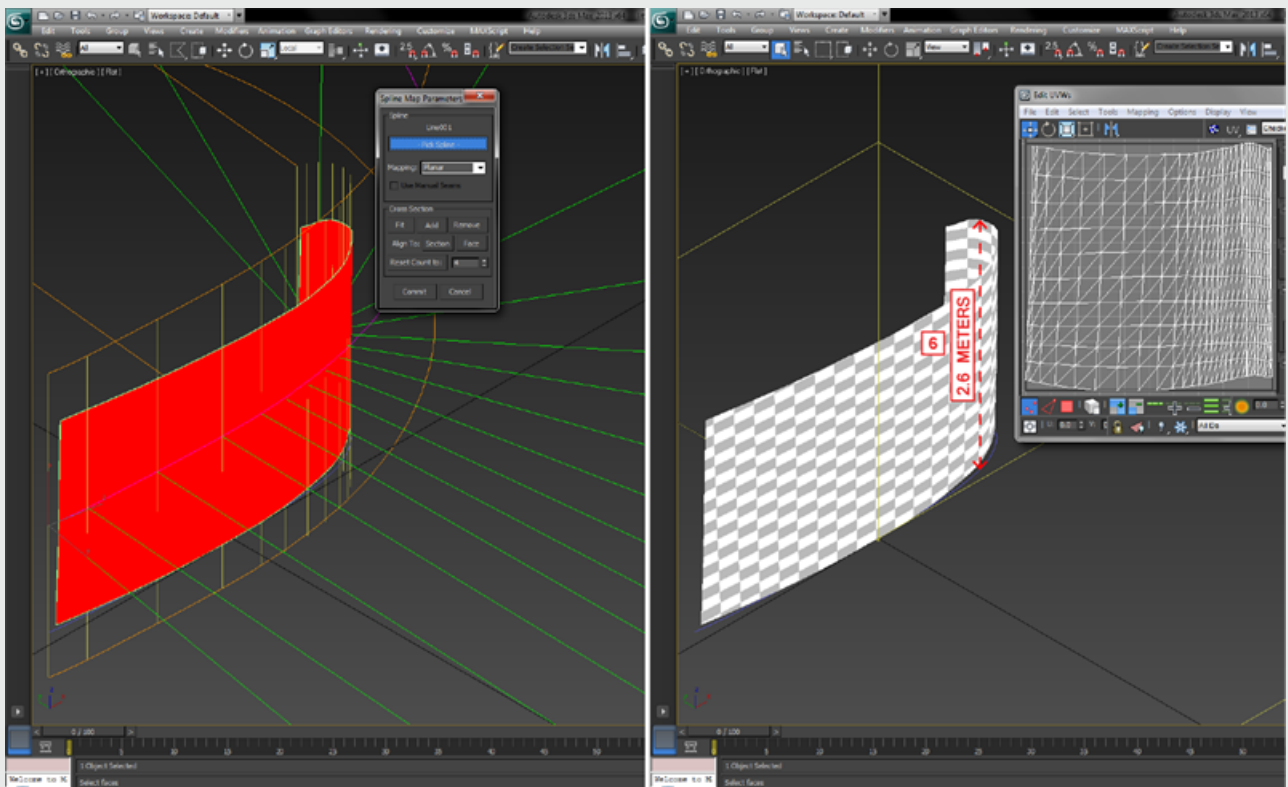

The length of the spline can be measured by selecting it and then selecting Utilities > Measure.

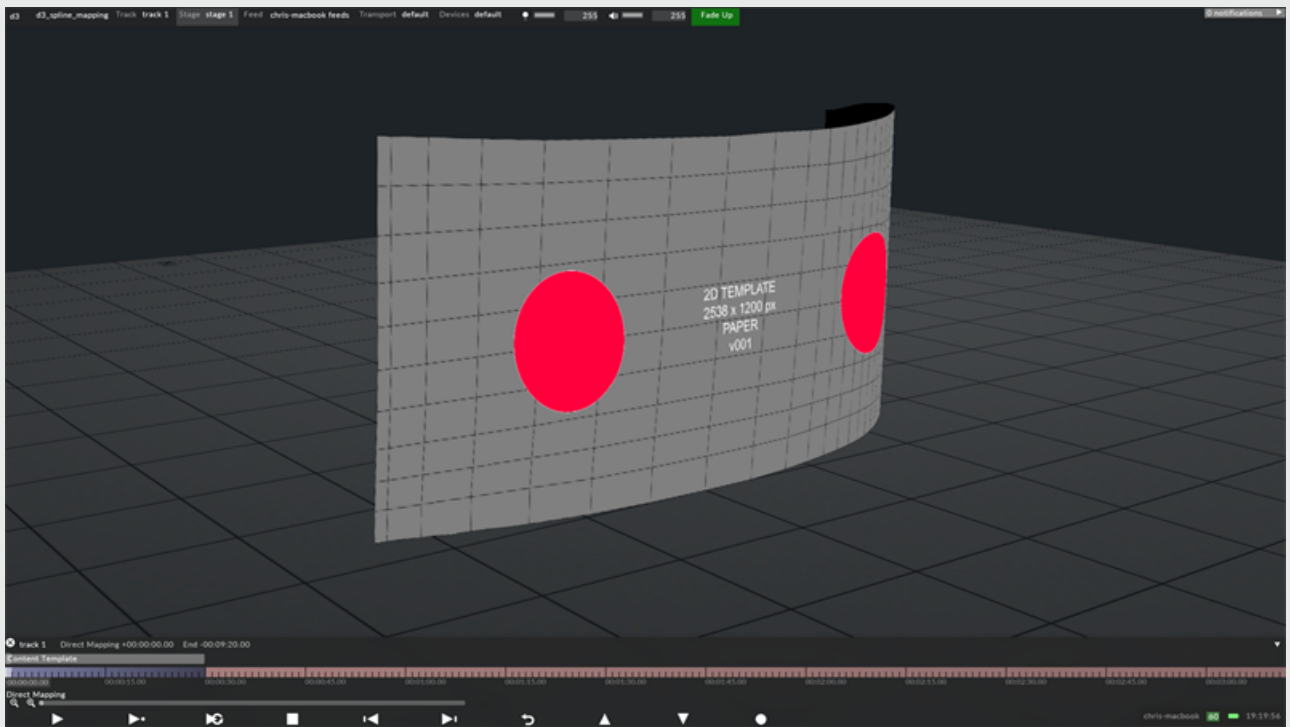
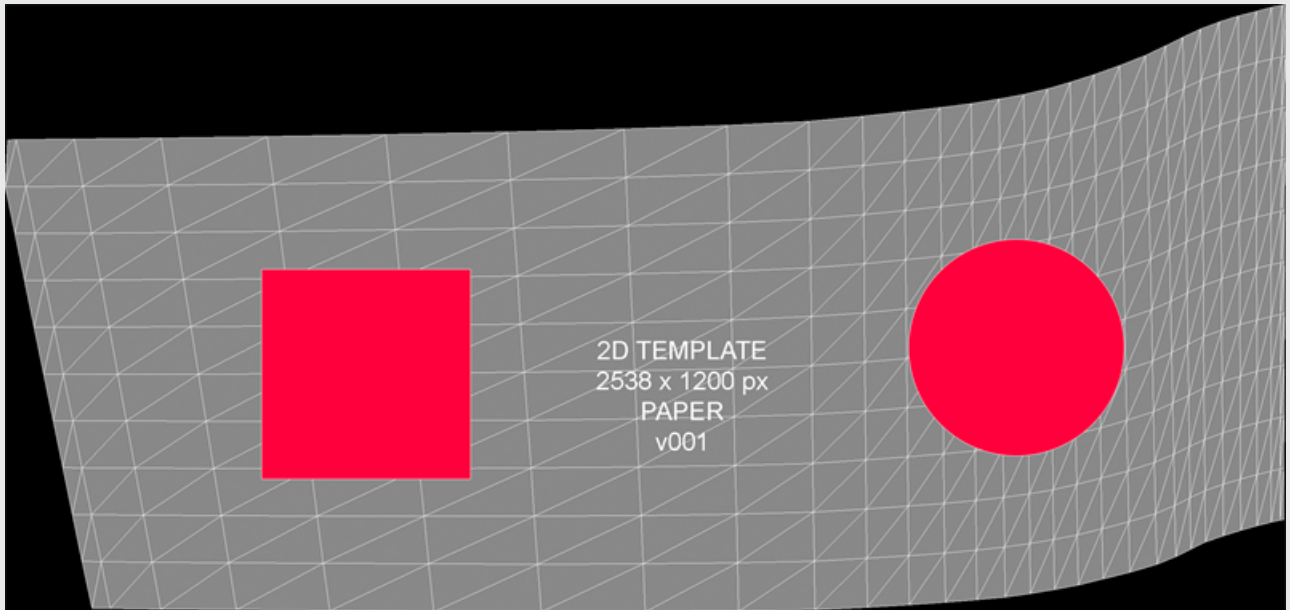

A 2D content template of a screen from the Little Prince musical rendered from 3ds Max.

# Helpful Resources

- [Projecting spline maps in 3ds Max](#)
- [Unwrapping UVs in 3ds Max](#)
- [Editing UVs in 3ds Max](#)
- [Rendering content templates in 3ds Max](#)



# EVO

## Overview

Disguise is a workflow platform, designed to be flexible and enable you to interoperate multiple functions within the platform to create your own workflows. One example of this is a collection of workflows known as EVO.

EVO (External Visualiser Overlay) is in essence two parts. An incoming video stream (NDI) from a third party visualiser, and sharing of camera coordinates between the disguise camera and the external visualiser's camera.

By combining these two workflows, you are able to create a seamless link between the two systems - essentially visualising the lighting and video systems together in one view port.

In this example, we will focus on GrandMA 3D, but other visualisers can be implemented in a similar way.





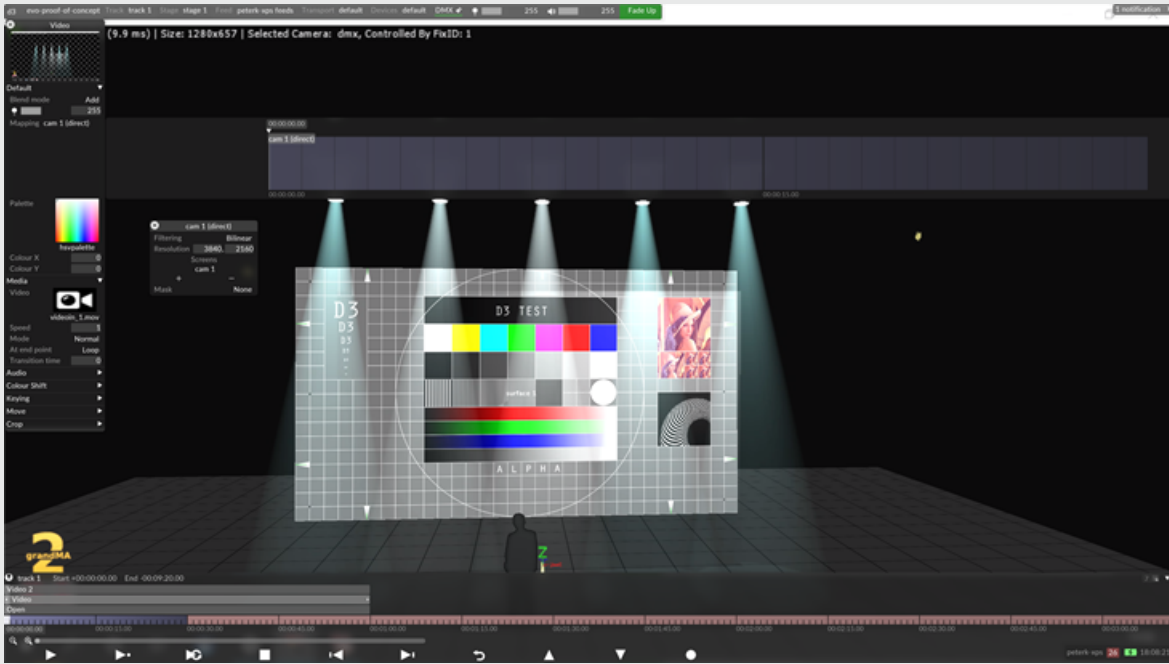

## Setup

### NDI Video Streams

To set up the NDI stream:

1. Start the NDI Scan Converter on the visualiser PC
2. In the third party visualiser, set all video surfaces & props to render as black. It might be helpful to use the Export Stage to FBX option in Disguise software to export the stage directly into the visualiser, to ensure all objects are scaled identically
3. Start Disguise software project
4. In Disguise software, create a new camera and position it as required. This will become your main visualiser camera, so you may also need to increase the resolution if you are running a 4K GUI (the new camera will default to 1920 x 1080)

5. In Disguise, select the visualiser camera to be that new camera in the Stage menu
6. In the Video Input Patch, map one of the Video Inputs to the incoming NDI stream from the visualiser PC. Check with the preview function that this is routing correctly.
7. Add a new Video layer to the timeline
8. In the Video layer, select the Video In clip as the media asset
9. Set the video layer to **Add** blend mode
10. Create a new Direct mapping and add the new camera you created to that mapping
11. Select the new mapping as the mapping for the video layer

✕
Video

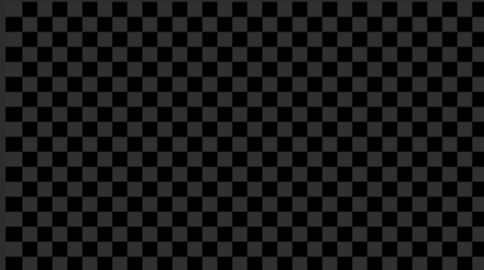

Default
▼

Blend mode Add

Mapping gui camera (direct)

Palette +

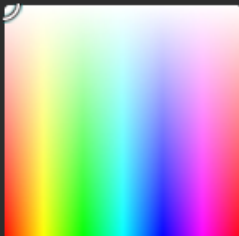

hsvpalette

Colour X

Colour Y

Media
▼

Video



videoin\_1.mov

Speed

Mode Normal

At end point Loop

Transition time

Audio ▶

Colour Shift ▶

Keying ▶

Move ▶

Crop ▶

✕
gui camera (direct)

Filtering Bilinear

Resolution

Screens cam 1

+

Mask -

None

2892

At this point the incoming NDI stream from the external visualiser will be overlaid from the disguise visualiser. If you manually line up the two cameras, this is all that is needed - but using the tracking and control modules in Disguise software it's possible to link the two cameras together, via open protocols (DMX).

## Camera Positions

To set up the camera position - there are two options - either disguise can receive the camera position from the visualiser, or the visualiser can receive the position from disguise.

## Visualiser receiving position from disguise - via DMX

1. Add a DMX device to the project, and patch it to Output DMX
2. Create a DMX lights screen and assign it to create an appropriate number of DMX addresses
3. Add an DMXLightsControl layer to the timeline
4. Select the DMX lights screen as the mapping for the DMXLightsControl layer
5. Use an arrow to connect the control layer to the stage camera (the expression syntax created is **camera:{camera name}.offset.x**)

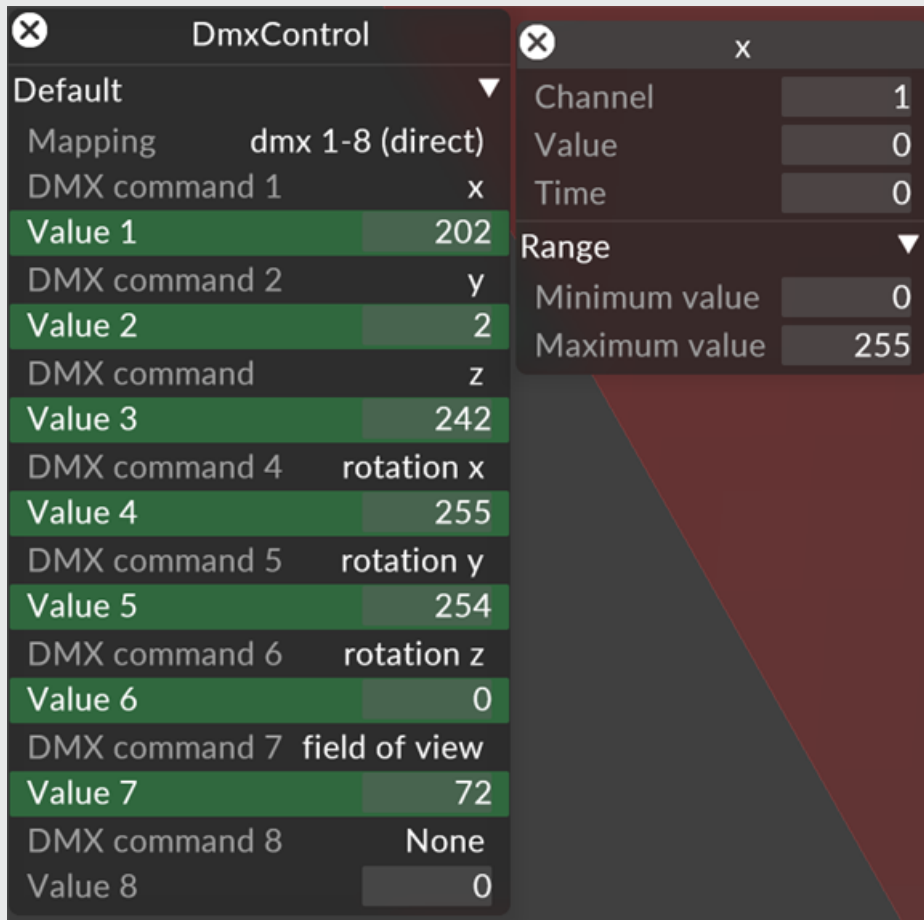

6. Set up the appropriate commands to send from Disguise software to the visualiser - note that the DMX LightsControl layer sends only 8 bit values so you will need to convert these to 16 bit or 24 bit depending on the external visualiser requirements. See below.
7. Apply any scale factors needed in the expression to center the two worlds  
Note - you will need multiple DMXcontrol modules to send all the properties of the camera)
8. Patch the external visualiser according to the data stream you created

**Please note:** World Offsets - It might be helpful to set up Disguise software camera as a CHILD of a null object (prop). This means that you can set the world offset using the position and rotation properties of the null object, rather than modifying the expressions (above). Create the prop, then use Add Child to select the camera as a child of the prop. When the position of the prop is adjusted, the camera will move by the same relative value. No mesh needs to be selected on the prop.

## Open Layer workflow

1. Add a DMX device to the project file, and patch it to Input DMX
2. Add an Open layer to the timeline
3. Hold down Alt and drag an arrow between the Open Layer and the Cameras position and rotation properties. This will connect the Open layer to the camera Position & Rotation, enabling control of them from the timeline.
4. Right click on each property and use an expression to connect each of these properties to the appropriate incoming DMX value - you may need to scale these values to match the world-scaling in the third party visualiser.

## PositionReceiver Workflow

### MA2 setup:

1. Create a new project file, go to setup MA Network Control>create a new session, then go to Network protocols and enable the Art-Net
2. Open the camera pool, select the Front view, it should be highlighted in green, then store a new camera view in one of the empty slots



3. Go to Setup and patch an MA camera controller fixture (18 channel) in a new universe to address 1.
4. Once the camera controller fixture is patched to the right address please invert the Tilt of the MA camera controller personality. This will allow synchronizing the tilt of the disguise virtual camera an MA camera
5. Go to the camera pool and right-click on the new camera and select the camera control fixture. Set the x,y,z values to 0 and the rotation x,y,z to 0 and the FOV at 0.79

Edit 13. 'evo 13'						Previous	Next			
No.	Name	X	Y	Z	Rot. X	Rot. Y	Rot. Z	FOV	Step Thro	Fixture
13	evo	0.00	0.00	0.00	0.00	0.00	0.00	0.79		CC 1 21

These steps will allow you to control the new camera using the encoders of the desk.

## MA3D setup:

1. Set the default camera to Front
2. Select the Stage Plane and make it 25m height x 25m wide, the default size of the disguise floor is 25m x 25m
3. Create a new plane with a size of 8m wide x 4.5m height, and set the position z at 3m. This plane is the same size and position of the default surface 1 of disguise.
4. Set the default camera to the new camera created previously

5. The visualizer will go to black since the new camera is at 0,0,0. Use the MA2 desk to move the camera to a desirable view and store a position preset for it.
6. Set the MA3D visualizer to full screen on your external monitor

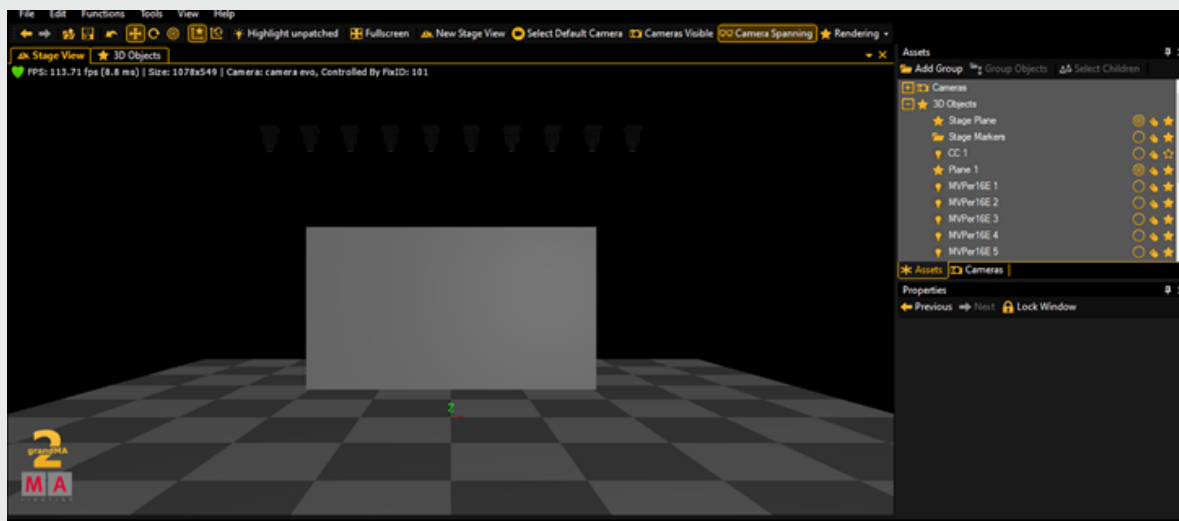

These steps are needed in order to replicate the disguise 3D environment with the MA3D environment to help align both visualizer cameras

## NDI setup:

1. Once the machine with the MA onPC and MA3D is ready, run NDI Scan convertor. This app will convert the outputs of the GPU in video streams over IP.
2. Open the NDI studio monitor and check that screen with the MA3D is working as an NDI stream.



## Disguise setup:

1. Open a new project file, remove the projector out of the stage and create a new virtual camera
2. Right click on Devices > Video input patch. Select video.in1>input configuration> select the NDI stream of the MA3D. Click on Start preview to check the stream, then stop the preview.
3. Create a DMX device, and use the IP address of the MA onPC or MA desk, and check the data with the DMX monitor.
4. Create a PositionReceiver Device and build new expressions to control the position x,y,z and rotation x,y,z of the virtual camera within Disguise software using the data coming from the MA lighting desk.

## Expressions

Expressions are used within Disguise software to calculate the mathematical values needed to align the virtual worlds of both visualizers. The information that follows will be used in the expressions that need to be created within Disguise:

- The MA camera controller has a range from -1000m to 1000m for the x,y,z positions and a range of -720 to 720 degrees for the pan and tilt.
- The position x,y,z of the MA camera control has a resolution of 24bits for the x,y,z, pan and tilt. Expressions within Disguise software only support 16bits, meaning that the camera movement in Disguise will be smooth using 16bit data.
- The 'position y' of the MA camera controller is the 'offset z' value of the virtual camera within Disguise software; The 'position z' of the MA camera controller is the 'offset y' value of the virtual camera within Disguise.

1. These are the expressions you need to build:

— Camera offset x:

camera x	
Expression	dmx16:6.1
Object	camera evo
Property	offset.x
Minimum input	0
Maximum input	65536
Minimum output	-1000
Maximum output	1000
Output	0

— Camera offset y:

camera y	
Expression	dmx16:6.7
Object	camera evo
Property	offset.y
Minimum input	0
Maximum input	65536
Minimum output	-1000
Maximum output	1000
Output	2.99072

— Camera offset z:

camera z	
Expression	dmx16:6.4
Object	camera evo
Property	offset.z
Minimum input	0
Maximum input	65536
Minimum output	-1000
Maximum output	1000
Output	-15.014

— Camera pan (rotation y)

camera pan (rotation y)	
Expression	dmx16:6.10
Object	camera evo
Property	rotation.y
Minimum input	0
Maximum input	65536
Minimum output	-720
Maximum output	720
Output	0.70312

— Camera tilt (rotation x)

camera tilt (rotation x)	
Expression	dmx16:6.13
Object	camera evo
Property	rotation.x
Minimum input	0
Maximum input	65536
Minimum output	-720
Maximum output	720
Output	-1.4502

2. If the expressions are correctly built the new virtual camera within Disguise software will move to the same x,y,z position location of the MA3D camera.

3. Create a new Video layer, map it to surface 1, and add some media.
4. Create another Video layer, change the blend mode to Add, and select video-in 1 as media; the thumbnail will display the MA3D NDI stream with a checkerboard. Make a new direct mapping for your new virtual camera
5. Go to Stage>Visualizer Camera and assign to the new virtual camera
6. The Disguise camera and the MA3D camera will be aligned
7. Open the virtual camera properties editor and change the background colour to black.

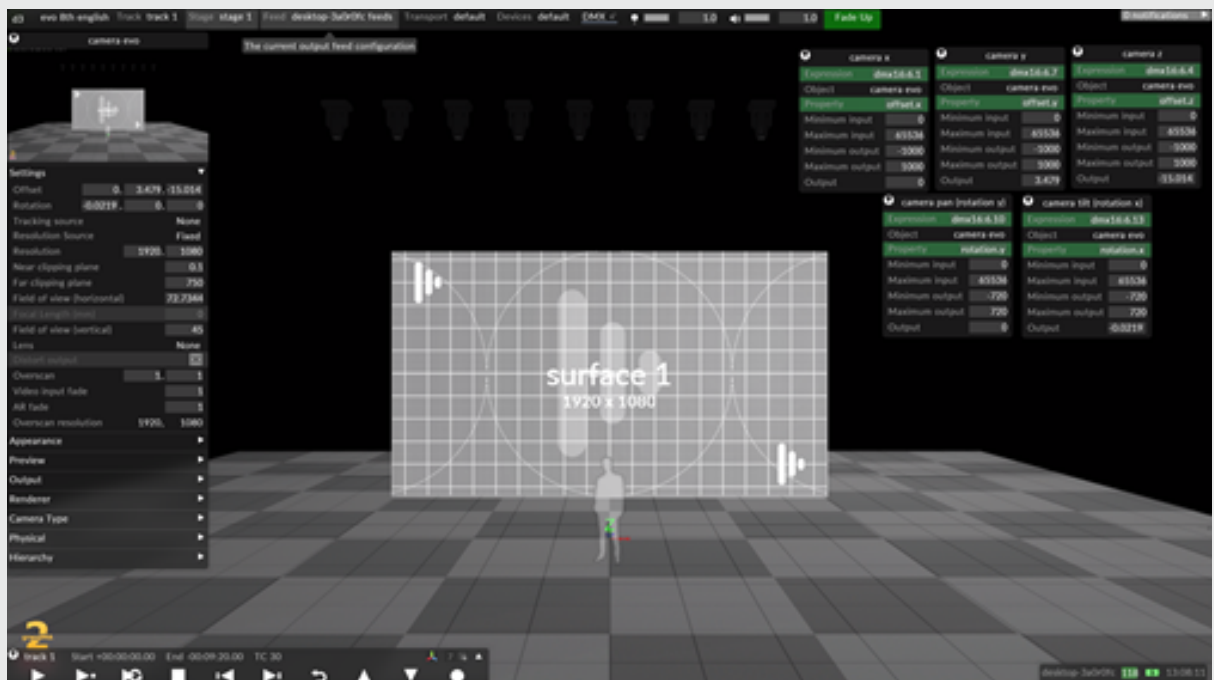

Once you have finished all the steps you can make the stage plane in MA3D invisible; it will not be needed once the alignment of the cameras is completed. You can start patching lights on the grandMA2 and add screens in disguise to create your show.

# MA3D

## Controlling the disguise camera from MA3D

### General Information

The MA 3D world is scaled between -1000m and +1000m, and rotation between -720 and +720°. DMX values for control are output as 24 bit control signals, using 3 DMX channels (bytes). Disguise only supports the input of 8 or 16-bit values, so we take the most significant bits from these values.

Using these real world values, we are then able to plug them into the following formulas to create the expressions needed to connect an external visualiser camera to the internal camera within disguise:

**{world centre offset in meters/ degrees}+(dmx16:universe.address/65536)\*{world size in meters/ degrees}-{world size in meters/ degrees}**

### Position X

**1000+(dmx16:1.1/65536)\*2000-2000**

### Position Y

**1000+(dmx16:1.7/65536)\*2000-2000**

Since Y and Z are flipped in GrandMA 3D, we pick up opposing DMX values

### Position Z

**1000+(dmx16:1.4/65536)\*2000-2000**

## Rotation X

$720 - (\text{dmx16:1.13} / 65535) * 1440 - 1440$

## Rotation Y

$720 + (\text{dmx16:1.10} / 65536) * 1440 - 1440$

## Rotation Z

No expression

GrandMA 3D does not support Rotation Z via DMX

## Field of View

Set this manually

MA 3D measures field of view as half horizontal value compared to Disguise software (eg if MA 3D is 22.5°, Disguise software field of view is 45°).

In the above expressions, the constants 1440 and 2000 are derived from the world scale of the GrandMA 3D scene.

- 2000 is the scale factor between the GrandMA 3D world positions into meter scaling.
- 1440 is the scale factor between the GrandMA 3D world rotations and degrees.
- The above constants can be modified for integration with other visualisation systems.
- Note that these expressions are only reading the top two bytes (16-bits) of the 24-bit values

- At this point when you move the external visualiser camera, Disguise software visualiser camera will move too.

## Using disguise to control the MA3D camera

Disguise only supports the sending of 8 bit values from the DMXLightsControl layer, so we need to use expressions to split the 24 bits into separate bytes:

### High Byte Position X

DMX Channel 1

```
(((camera.offset.x+1000)*8388.608)/65536)
```

### Mid Byte Position X

DMX Channel 2

```
(((camera.offset.x+1000)*8388.608)%65536)/256)
```

### Low Byte Position X

DMX Channel 3

```
(((camera.offset.x+1000)*8388.608)%256)
```

### High Byte Position Y

DMX Channel 4

```
(((camera.offset.y+1000)*8388.608)/65536)
```

**Please note:** Note that Y and Z are flipped in MA 3D world

## Mid Byte Position Y

DMX Channel 5

$$\left(\left(\left(\text{camera.offset.y}+1000\right)*8388.608\right)\%65536\right)/256$$

## Low Byte Position Y

DMX Channel 6

$$\left(\left(\left(\text{camera.offset.y}+1000\right)*8388.608\right)\%256\right)$$

## High Byte Position z

DMX Channel 7

$$\left(\left(\left(\text{camera.offset.z}+1000\right)*8388.608\right)/65536\right)$$

## Mid Byte Position z

DMX Channel 8

$$\left(\left(\left(\text{camera.offset.z}+1000\right)*8388.608\right)\%65536\right)/256$$

## Low Byte Position z

DMX Channel 9

$$\left(\left(\left(\text{camera.offset.z}+1000\right)*8388.608\right)\%256\right)$$

## High Byte Rotation X

DMX Channel 10

$$\left(\left(\left(\left(\text{camera.rotation.x}-1\right)+720\right)*\left(\left(256*256*256\right)/1440\right)\right)/65536\right)$$



## Mid Byte Rotation X

DMX Channel 11

$$\left(\left(\left(\text{camera.rotation.x} - 1\right) + 720\right) * \left(\left(256 * 256 * 256\right) / 1440\right)\right) \% 65536 / 256$$

## Low Byte Rotation X

DMX Channel 12

$$\left(\left(\left(\text{camera.rotation.x} - 1\right) + 720\right) * \left(\left(256 * 256 * 256\right) / 1440\right)\right) \% 256$$

## High Byte Rotation Y

DMX Channel 13

$$\left(\left(\left(\text{camera.rotation.y} - 1\right) + 720\right) * \left(\left(256 * 256 * 256\right) / 1440\right)\right) / 65536$$

**Please note:** Y is inverted in MA3D so we invert the expression with the negative conversion on the bytes

## Mid Byte Rotation Y

DMX Channel 14

$$\left(\left(\left(\text{camera.rotation.y} - 1\right) + 720\right) * \left(\left(256 * 256 * 256\right) / 1440\right)\right) \% 65536 / 256$$

## Low Byte Rotation Y

DMX Channel 15

$$\left(\left(\left(\text{camera.rotation.y} - 1\right) + 720\right) * \left(\left(256 * 256 * 256\right) / 1440\right)\right) \% 256$$

## High Byte Zoom

DMX Channel 16

## Mid Byte Zoom

DMX Channel 17

## Low Byte Zoom

DMX Channel 18

### Constants

In the above expressions, the constants are derived from the world scale of the GrandMA 3D scene.

Position constant: **8388.608** is the scale factor between the GrandMA 3D world positions (-1000m to +1000m = 2000m) and the 24-bit DMX value  $(256 \times 256 \times 256) / 2000 = 8388.608$ .

Rotation constant:  $((256 \times 256 \times 256) / 1440)$ : **11650.84444444** is the scale factor between the GrandMA 3D world rotations (-720 to +720 degrees = 1440 degrees) and the 24-bit DMX value  $(256 \times 256 \times 256) / 1440 = 11650.84444444$

The above constants can be modified for integration with other visualisation systems.

You will need to patch these same values in the external visualiser.

At this point when you move the disguise camera, the external visualiser camera will move.

The only final adjustments that need to be set manually are field of view.

## Capture

These are suggested expressions for controlling the visualizer camera within Capture from disguise based on the following information available from Capture documentation.

bit depth = 16 max value =  $2^{\text{pow}(\text{bit depth})} = 65536$

output min = -32768 output max = 32768 output range = output max - output min = 65536

output to bit ratio = max value / output range = 1

## Capture Camera control X, Y, Z:

value 1:  $(\text{camera:camera.offset.x} * 100 + 32768 \% 65536) / 256$

value 2:  $\text{camera:camera.offset.x} * 100 + 32768 \% 256$

value 3: (unassigned)

value 4:  $(\text{camera:camera.offset.y} * 100 + 32768 \% 65536) / 256$

value 5:  $\text{camera:camera.offset.y} * 100 + 32768 \% 256$

value 6: (unassigned)

value 7:  $((\text{camera:camera.offset.z} * -1) * 100 + 32768 \% 65536) / 256$

value 8:  $(\text{camera:camera.offset.z} * -1) * 100 + 32768 \% 256$

## Camera Control Rotation:

value 1:  $(\text{camera:camera.rotation.y} * 182 + 180 * 182.044 \% 65536) / 256$

value 2:  $\text{camera:camera.rotation.y} * 182 + 180 * 182.044 \% 256$

value 3: (unassigned)

value 4:  $(\text{camera:camera.rotation.x} * 182 + 180 * 182.044 \% 65536) / 256$

value 5:  $\text{camera:camera.rotation.x} * 182 + 180 * 182.044 \% 256$

value 6: (unassigned)

value 7:  $(\text{camera:camera.rotation.z} * 182 + 180 * 182.044 \% 65536) / 256$

value 8:  $\text{camera:camera.rotation.z} * 182 + 180 * 182.044 \% 256$

### Please note:

- The Camera position range is -32768 to 32768 for X, Y, and Z; this value is in cm\*
- The Camera rotation range is -180 to 180
- Capture requires 16bit resolution
- Z axis is inverted in Capture so you need to use camera z \* -1
- Expressions must be converted to METERS so we use \*100 in the expressions to convert cm to m

# Projector Calibration

Projection Calibration is the process of calibrating your projectors to the 3D space.

## Overview

The Disguise software offers three different calibration methods. Each has their own benefits and draw backs. We recommend planning which form of calibration will be used during pre-production.

1. To learn more about manual calibration see [here](#).
2. To learn more about QuickCal see [here](#).
3. To learn more about OmniCal see [here](#).

# Manual Calibration - Projectors



**Warning:** reset all digital and optical warps inside the projector, including lens-shift, otherwise the lineup features will be interrupted.

- Open the projector editor by either right-clicking the projector directly in the Stage, or by right-clicking the projector from the **screens** list in the Stage editor.
- Familiarize yourself with the properties of a projector. After this follow the instructions explained below.

## Set the correct resolution

Set the **resolution** of the projector to match the corresponding output head's resolution.



**Warning:** If the resolution of the projector doesn't match the real world output, you will end up with an incorrect calibration.

## Add surfaces

Under the **Surfaces** tab add the projection screens that the particular projector is covering.

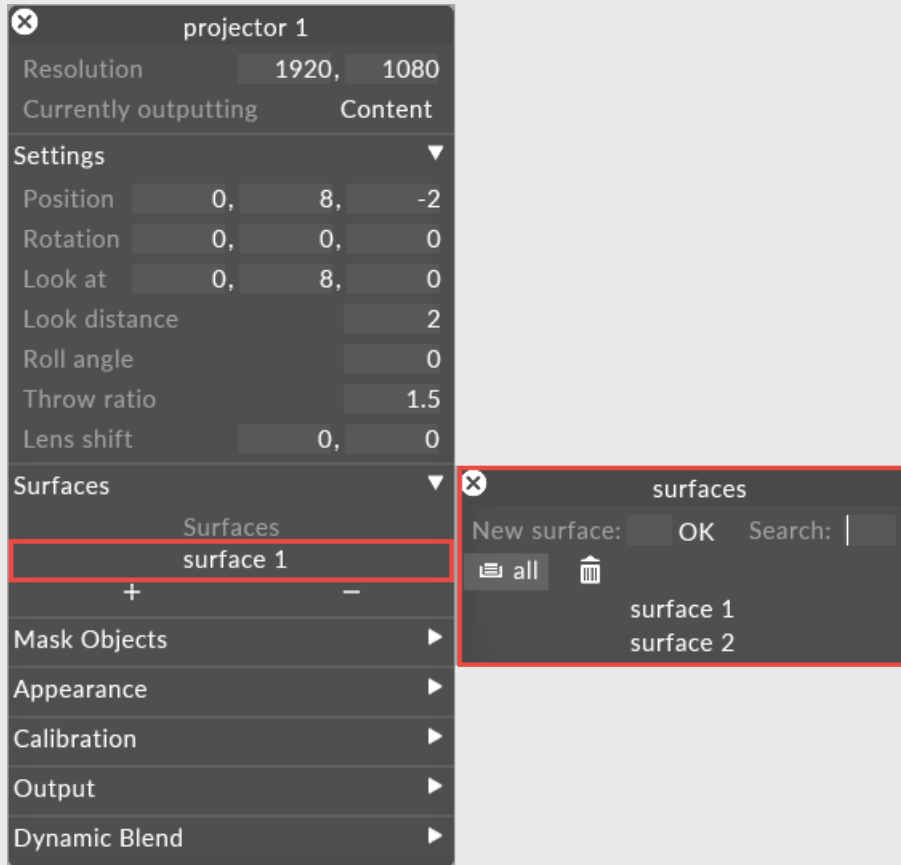

**Warning:** If you don't add a screen to the projector the output will stay black.

## Add the projector outputs to the Output Feeds

Ensure all of the Feed rectangles from the projector outputs have been added to the output heads.

Please see [adding feed rectangles](#) for information how to do this.

# Place the projector correctly

Change the **pos** (projector position) and **the throw ratio** (lens value) properties so that the projector covers the required part of the screen surface. A laser measure may be required to calculate the correct position by measuring the distance from the physical projector to the video surface.

## Adjust the Look at position

The **Look at** position of a projector defines the centre point of its corresponding output feed. When lining up a virtual projector to the physical projector it is therefore crucial to match the Look at position to its corresponding point in the real world.

Disguise has a built-in wireframe feature allowing the system to generate a line-drawing based on the 3D mesh of the projection surface. In the same output frame Disguise will also output a red cross positioned in the centre of the output feed. When the wireframe test pattern is applied, Disguise will output this red cross regardless of the orientation of the projector.

Consequently, if the look at position of the projector is aligned to the red cross on the physical projection surface, the virtual projector and the physical projector are orientated around the same point which is a great starting point for an accurate manual lineup.

## Align the look at position of the projector

- Change the output mode to **wireframe** by clicking the **output** tab at the bottom of the projector editor.
- Return to the Stage level. Set the **step** value of the look at position to 0.01 to enable smoother scrolling of the look at values. To change the step value, right-click the property **name** and change the value in the Step value property.
- Begin aligning the look at position of the projector to the red cross by comparing the look at positions crosshair in the Stage level and the red cross being outputted from the physical projector.





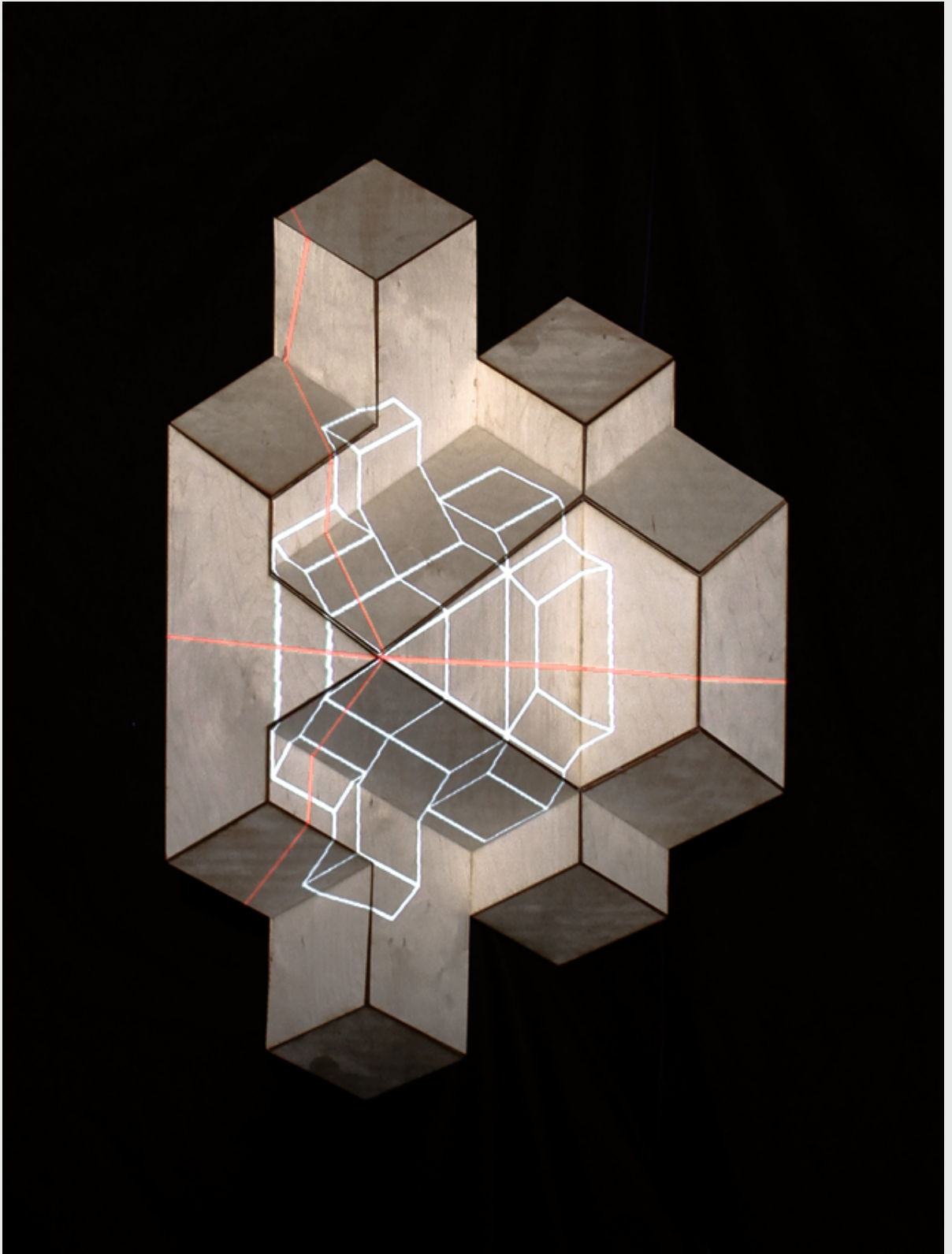

Look at position of the virtual projector now matches its corresponding point on the physical video screen, in this example a wooden sculpture

## Adjust the throw Ratio

- To zoom in on the physical video screens content, change the **throwRatio** value. This value corresponds to the lens size of the physical projector.
- If the exact lens size is known (for example a fixed lens size is being used), type it in.
- If a zoom lens is being used, set the start value to the lowest (or highest) value in the zoom range. Slowly change the value by scrolling the mouse wheel in the property field.

## Fine tune property values

- After setting the initial lens value, try not to edit the position properties. Instead, start adjusting the **rotation** parameters if needed, in particular the x and y rotations. Aim to establish parallel lines mapping onto the video screen **globally** rather than focusing only on one part of the screen. Adjust the **step** value if needed.
- Go back and fine tune the values of the lookAt position to center the output to the physical video screen. **Remember to establish parallel lines.**
- Adjust the throw ratio to zoom in/out of the content on the video screen. Assuming that the 3D mesh is accurate to the physical video screen, the mapping should gradually fall into place.

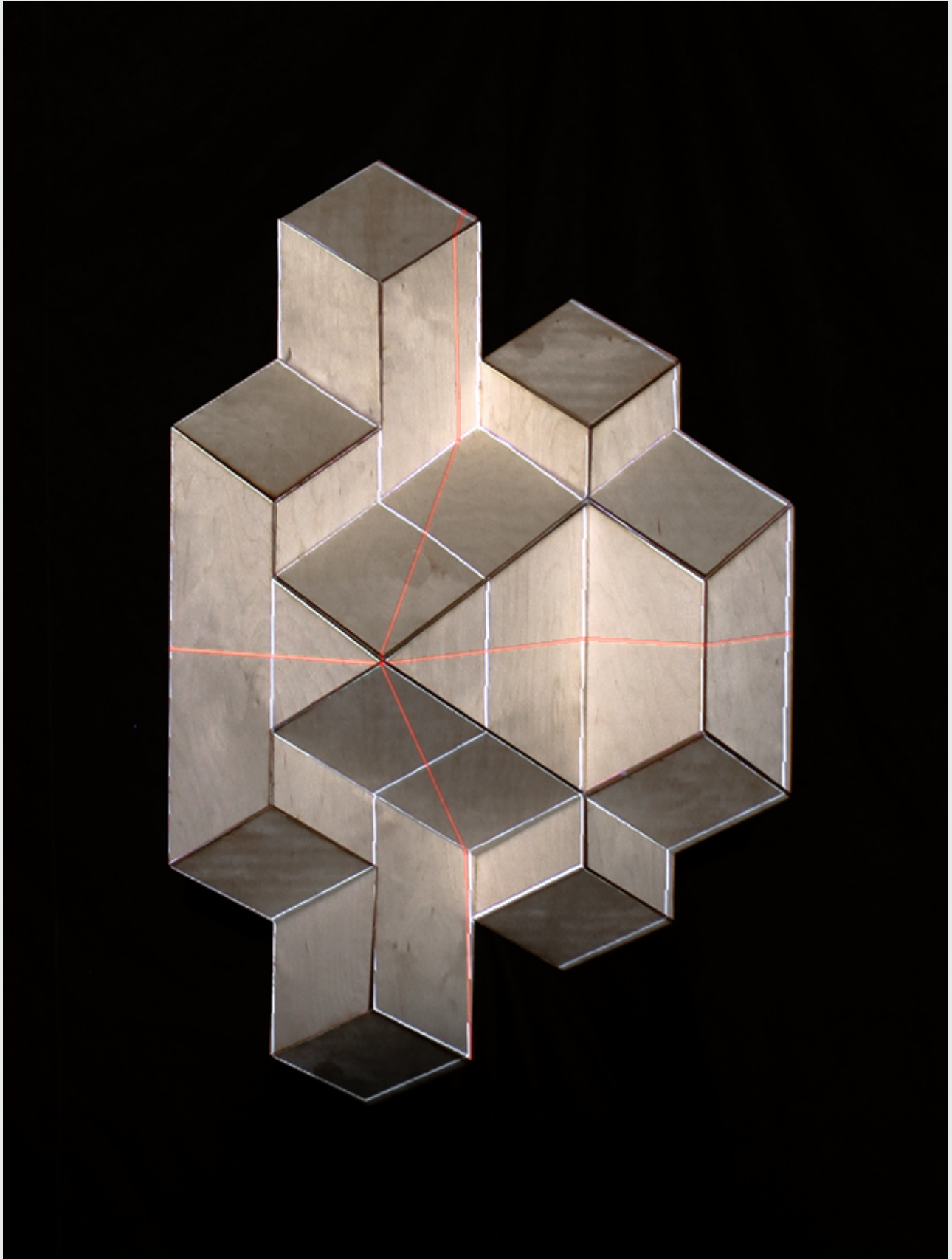

Projector has been manually calibrated; the 3D mesh test pattern now lines up with the wooden sculpture

If the projection surface does not match the 3D model after carrying out manual calibration the lineup may need to be fine-tuned. Please see the sub-chapter [Warping outputs](#) for more information.

# Multi-Pose Projection Calibration Overview

The QuickCal configuration includes a Multi-Pose workflow to allow for the calibration of objects that move.

## Multi-Pose Projection Workflow

1. place the moveable object in a particular position (the “pose”) and then perform a standard quick-calibration.
2. Then rotate the object to a second position.
3. Drag the existing markers to the correct positions and add new ones if necessary, until the projected image is correct and sharp.
4. This process is then repeated for as many poses as are required.

Unlike in the single-pose workflow, we see the dropped calibration points rotate along with the model.

## Example

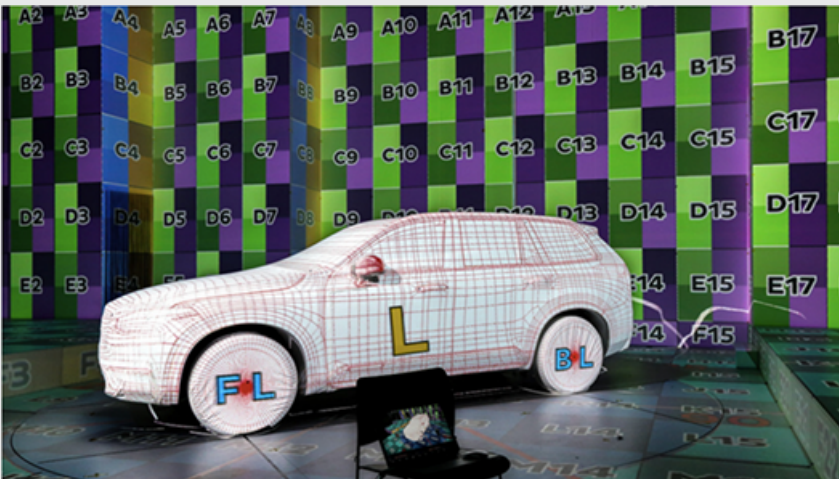

Example application : a car on a rotating turntable, with encoder

In this image, is an example of a car on a motorised turntable. During configuration as the car rotates, the calibrated points gradually drift from their locations on the real model, showing that the calibration isn't perfect across the space. Once the car is in a new pose, we simply drag the existing markers to the correct positions, and add new ones if necessary, until the projected image is correct and sharp.

# Calibration errors

Troubleshooting calibration errors.

## Calibration errors

The process of calibrating a camera or projector requires a set of input data and a model that expresses the geometry and physics. This model is a set of known equations that are determined by unknown parameters. For projectors or cameras the model usually involves a *3D position and orientation*, as well as lens parameters such as *focal length*, *lens shift* or *distortion coefficients*.

During the calibration process suitable model parameters are estimated, based on the input data observations.

**Calibration errors are a measure of how well the estimated model parameters conform to the input data.**

Calibration in Disguise typically involves several pairs of 2D and 3D points. The source of these point pairs can be for example:

- manual input (2D lineup position in QuickCal)
- automatic detection (2D blob positions in OmniCal or xR)
- existing file data (3D mesh vertices used in QuickCal)
- reconstructed 3D points (based on automatically detected 2D blobs in OmniCal or xR)

Error measurements are often calculated as *Reprojection Errors*: the input 3D points are projected back onto the projector (or camera) image using the equations and parameters of the calibrated model.

The resulting 2D points are compared against the original input 2D points. The difference between them (usually the absolute 2D distance) is used for the error calculation. The total error is aggregated over all point pairs in different ways (see below).

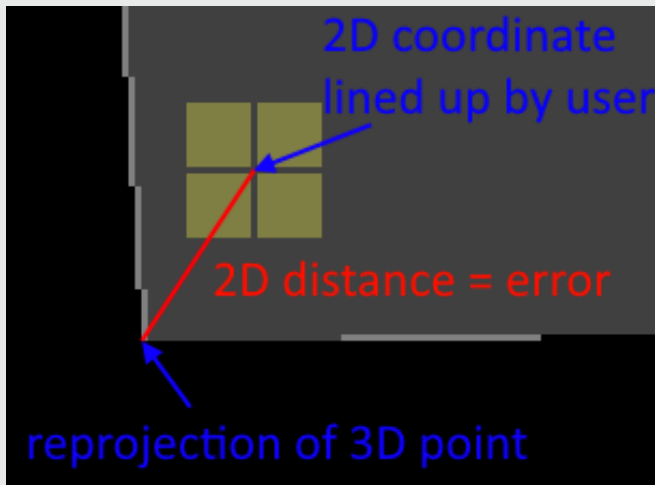

The unit for these reprojection errors is usually in pixels.

Lower error values are better.

Typically, a reprojection error below 1 pixel is desirable, although in some circumstances higher values can be acceptable. This is a judgment call that depends on the shape of the surface, what content is used, or the effective resolution that the content will be visible at on the projection surface. If the audience is far away, or the resolution is very high, then higher errors may not be noticeable.

In QuickCal, it is more difficult to achieve true subpixel accuracy, since the user can only line up the 2D cursor at full pixel boundaries. This introduces systematic errors of up to a half pixel in either direction.

In OmniCal and xR, the 2D blobs are detected with sub-pixel accuracy due to the relative size of the blobs in the camera images.

There are several ways of calculating errors from the above-mentioned point differences:

## Average or Mean absolute error (Avg)

The average (or mean) error is simply the sum of absolute errors divided by the number of errors. The use of absolute values means that it cannot be negative. A value of 0 would be a perfect result. Individual differences have a proportional influence on the total average error. This makes it easy to understand and a good measure of success.

## Root Mean Square error (RMSE)

The RMSE is the square root of the average of squared individual errors. It also cannot be negative, and a value of 0 would be a perfect result. Because the individual differences are squared, larger errors have a disproportionately large effect on the total RMSE. Consequently, RMSE is sensitive to outliers.



This is why OmniCal will remove any outliers from the data set before and between calibration steps. The RMS error is often used during the calibration itself to drive the process faster in the best “direction”. But it is also used at the end of a calibration as a measure of success.

In QuickCal, the RMS reprojection error is always calculated again after the calibration completes. For some algorithms, QuickCal also reports back the internal RMS error from the algorithm itself. In the UI this is shown as “rest”.

## Notes

- It is possible for two different calibration input data sets to have the same average error, but different RMS errors.
- A calibration error is not always a guarantee for a successful calibration that is visually convincing. If there are only few input point pairs, then it is possible that redundant information or mistakes lead to unrealistic model parameters, despite low error values.

## Further Reading

[Mean absolute error \[Wikipedia\]](#)

[Root-mean-square deviation \[Wikipedia\]](#)

# Quick Calibration overview

This sub-chapter explains the process of using QuickCal to line up projectors to real world screens.

## QuickCal overview

QuickCal is a user-driven process of calibrating a virtual projector's position, orientation and lens properties to match the real-world projector. QuickCal is based on reference points on given 3D meshes for a projector's target surfaces, and user-defined 2D image coordinates that are manually assigned to these 3D reference points. As long as the 3D meshes are good matches to the real-world projection surfaces, QuickCal can accurately calculate the projector parameters.

The basic process of QuickCal is relatively simple : drop reference points onto the 3D model of the projection surface, and then 'line up' by dragging each point in the projector's output raster until it hits the corresponding point on the real surface. Once you've done enough points (about 10- 15 per projector) Disguise software can work out exactly where the projector is, and what lens qualities it has.

## 3D mesh accuracy

When calibrating projectors using QuickCal it is **crucial** that the 3D mesh object is modelled accurately to the physical model. The reason for this is that Disguise's calibration algorithm assumes that the virtual reference points link exactly to their corresponding real-world points. The best way to generate a highly accurate 3D model is to laser scan the physical model, or to laser cut the physical model based on the same 3D file you later use in Disguise software. For building projections we recommend a mesh with a +- 5mm error margin.

## Using QuickCal

To start using QuickCal, first move the virtual projector into roughly the right position and orientation, and set up its lens qualities to roughly match the real projector. You don't have to be particularly accurate in this, but when you're trying to select projectors in the visualiser for editing, it's easier when they're in roughly the right place. Then move on to creating reference points, and then line them up.

## Tips & tricks

# General QuickCal background information

The calibration goal is to calculate a projector's projection matrix so that it produces physically valid projections on its assigned projection surfaces in the real world (the scene). This means that the matrix does not need to be absolutely physically correct, but should be correct for at least this projection area (or rather volume). Indeed, it helps to think of the calibration as a process that works on a volume in space, rather than on 2-dimensional surfaces.

The calibration process uses as main inputs:

### **3D Reference Points (in world space)**

These are usually created from vertices of the mesh/object. Note that the mesh needs to match the real object, at least in the vertices used for creating Reference Points. In d3 Reference Points are 3D objects themselves, and a certain point can be used by several Projectors.

### **2D coordinates (in the projector image plane)**

These are created during line up of a Reference Point in a given Projector. In Disguise software the Projector Configuration stores a pair that links the 2D coordinate to the 3D Reference Point.

## Projection matrix

The projection matrix is a linear transformation that represents the projector's position, orientation and internal sensor and lens properties. Note that Disguise software currently does not support correction of non-linear lens distortion in QuickCal. Lens distortion is only calculated and compensated for in OmniCal.

In Disguise software the projection matrix is applied to all 3D meshes in the Surfaces list, so they get transformed and projected on to the virtual Projector's image plane. This creates the projector's output image that is visible in the Feed Scene.

# Choice of Reference Points and Order of line-ups

A Reference Point and the 2D line-up coordinate together form a correspondence point pair. Several such pairs are required for a calibration. QuickCal supports several algorithms that have different requirements on the minimum number of points (e.g. 4, 6, or more).

It doesn't matter for the calibration itself which object/mesh the Reference Points come from, as long as that 3D point exists in the real world as a recognisable feature. Object corners are usually good choices.

It is possible to use Reference Points from several objects for a single Projector.

Important requirements are:

- The real-world equivalents of the Reference Points are actually visible by the physical projector (lie inside its light cone).
- All Reference Points that are used for a projector:
  - » span a large enough 3D volume. Often this is referred to as "adding enough depth". The main issue is to ensure that the Reference Points do not all lie on the same (virtual) plane in 3D space.
  - » should evenly cover a large enough area in the Projector's image. It's a good idea to use Reference Points that get lined-up in all four corners of the projector output image.

Additionally, if you want to verify the wireframe of an object during QuickCal line-up, then the objects needs to be added to the Projector's Surfaces list.

It is worth to keep in mind that calibrating creates a working volume for a projector, using the 3D Reference Points as a helper. So the volume in which the projector "is valid in" is always limited by the extent of Reference Points you have lined up. As an example, lining up 6 points that are all in the same image corner of the projector will likely produce a calibrated matrix that doesn't work well for the rest of the image. The same goes for points that are in close proximity in the real world, i.e. the calibrated matrix will only be valid in the small volume within those points.

The order in which Reference Points are created and lined up does not affect the calculation of the projection matrix. The calibration will produce the same result no matter what points are lined up first.

However, to help the calibration work out things faster, it makes sense to line up Reference Points from extreme parts of the scene first, before adding points that are closer to each other. Otherwise there may not be a good visual output until enough points are lined up so that they cover the whole scene with enough depth.

## Short QuickCal Rules

1. Leave the Calibration Method setting at Auto, unless you really have a good reason to force a specific algorithm. Auto will choose the best algorithm based on how many Reference Points you have, and what their 3D relationship is.
2. Don't "cheat" with your line-up coordinates unless you absolutely have to.
3. Never "cheat" until all Reference Points have been added and lined-up.
4. Line up the extreme parts of the mesh(es) and projector image first (e.g. image corners Left/Right/Top/Bottom and Close/Far in the scene). Then improve on that by adding more points. E.g. concentrate on Reference Points in areas where the projected images are still "off" when looking at the real object.

## Limited Scene Depth and number of Reference Points

Meshes/Objects that are flat or have little depth are more difficult to use for calibration. This is even more problematic if the real world object has few or no visible features, like a wall where only 4 corners are easily usable as Reference Points.

However, with 4 correspondence point pairs it's already possible to do a simple calibration (usually IterLM algorithm). This calibration is not able to calculate internal lens parameters such as lens shift or throw ratio. It will take values for these parameters from the manual projector settings. Note that these settings are still editable when using QuickCal with under 6 points, or if certain algorithms are set. It

can be difficult to get these values right by hand, but if the throw ratio and lens shift of the physical projector is roughly known, then adjusting this can help improve the calibration significantly.

With 6 or more correspondence point pairs a different algorithm is used (usually Zhang algorithm), which also calculates lens shift and throw ratio parameters automatically. If the Reference Points provide little or no depth, then this algorithm has problems finding a good projector matrix. This is because mathematically it is very difficult to differentiate between some internal lens parameters and 3D parameters. For example throw ratio (or focal length, if you prefer) and distance to an object are interchangeable to a certain degree. Think of the famous Dolly Zoom effect used by Hitchcock in the film "Vertigo", where the face always stays the same size, only fore- and background objects get smaller or disappear). This ambiguity can only be resolved by more depth. It is necessary to line up more points from the scene background/foreground to constrain the calibration better, essentially thereby increasing the calibration volume.

In practice, it may be preferable in certain rare situations to stick with 4 or 5 points, rather than adding a 6th, because the switch to the different algorithm may make the visual result worse rather than better.

## Correspondence Point influence on calibration

A correspondence point pair is not like guide points for splines, or a fixed warp or rule that associates the two to each other.

Instead, they are inputs into an iterative algorithm that tries to solve a matrix so that all of these point pair conditions are (more or less) satisfied. But due to mesh/ reality discrepancies, line-up inaccuracies, constraints of the optical model, even rounding errors, etc. there will never be a perfect matrix that fits all these pairs. There are many matrices though that will be good enough, so that the error for each of these point pairs is small (e.g. ideally below 1 pixel). If the inaccuracies in the input data are high, then some correspondence point pairs will basically contradict each other strongly. In that case the overall error will be high, too (e.g. 5-10 pixels, or even more). If the error is due to mesh/object discrepancies, then "cheating" might help (see below).

## Cheating

If the 3D model and the physical object don't match exactly, then QuickCal allows to "cheat" a bit. "Cheating" isn't recommended, but often it's not possible to get a better 3D model while being on-site.

There are several ways to "cheat":

- Moving the line-up cursor slightly off from where it should be, so that the overall calibration looks better and the reprojection error gets smaller.

Note that the advanced option 'Disable reference point bounds' allows moving the 2D line-up coordinate outside of the projector's image, e.g. to a negative value.

- Moving a 3D Reference Point away from its original vertex position. In QuickCal this can be done in "Manage" mode by holding the Shift key and moving the 3D Reference Point left, right, up or down. This will move the point in 3D space according to the current visualiser view, and allows placing the point in a non-vertex position. By default, Reference Points snap to the nearest mesh vertex, indicated by a green cross.

The problem with any of these tricks is to know which Reference Points to cheat with, and how it eventually affects the calibration.

# Quick Calibrating - Projectors

## Quick calibrating projectors

1. Right-click the projector you wish to line up.
2. Right-click the configuration file to open the QuickCal editor.

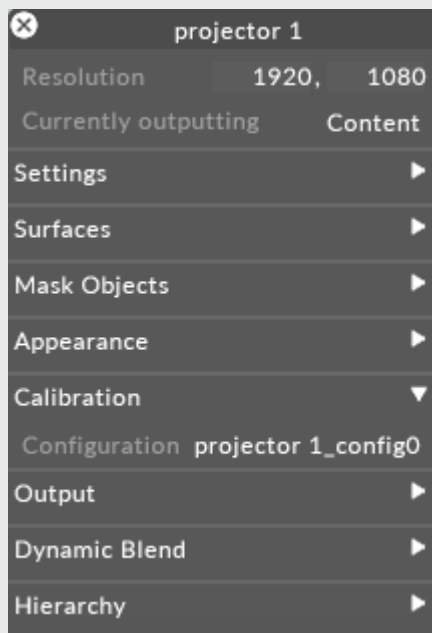

Projector configuration menu.



- At the top of the QuickCal editor select **line up points**.

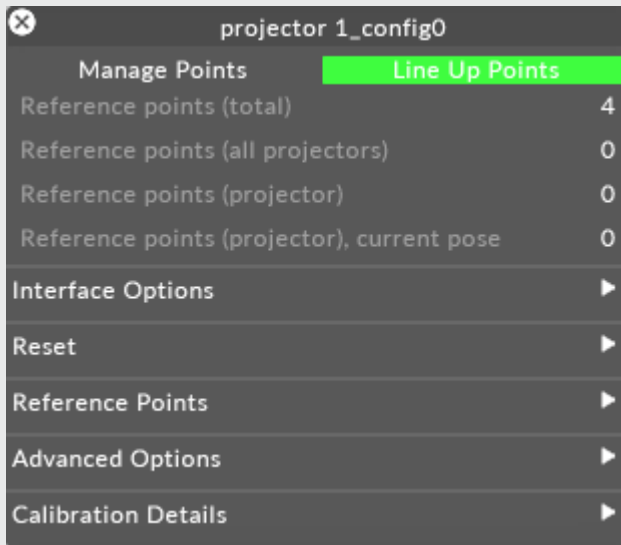

Line up point selection.

**Please note:** You must have the projector you're configuring assigned to an output otherwise the button is greyed-out

- Left-click a point (representing a reference point on the video screen), hold the left-click and drag the cursor in the output and match it to its physical corresponding point.  
Note: The output of the projector you working with will tinted the colour that you have set in the **appearance** tab in the projectors configuration.
- Once the point is in the right position release the point and now its set.
- To adjust cursor location using finer increments use the arrow keys to adjust in 1px movements.

When you have adjusted a point it will be displayed in the colour that matches the projectors colour.



Buckingham Palace with points calibrated.

# Remove a reference point from the projector

This will remove the 2D lineup between the selected reference point and the current projector. The reference point itself will not be deleted.

## To remove a reference point:

- Right-click on the reference point that you wish to remove from the projector lineup. The options menu will open.

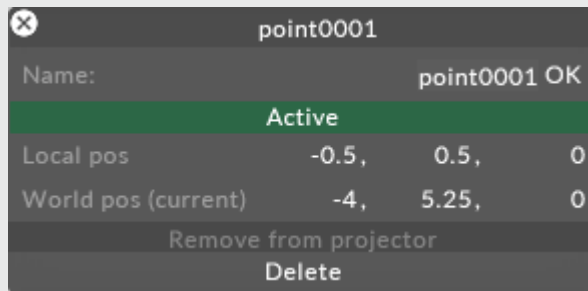

## To remove a reference point from a projector.

- Left-click on the remove from projector button.

# Rotate Controls

This option allows you to rotate your controls whilst lining up, This is especially useful when your projectors are rotated for example if they are portrait in orientation rather than landscape.

There are four options:

- None: Mouse and keyboard operate normally.
- 90 degrees clockwise: mouse and keyboard are rotated 90 degrees clockwise
- 180 degrees: mouse and keyboard are rotated 180 degrees.
- 180 degrees anti-clockwise: mouse and keyboard are rotated 180 degrees anti-clockwise.

# Lineup output mode

Lineup output mode allows you to change what is applied to the output whilst lining up.

**Please note:** During QuickCal lineup all lined up reference points will be drawn on top of the selected output.

You can choose between the following output modes:

- **Content:** Outputs the content that's on the timeline.

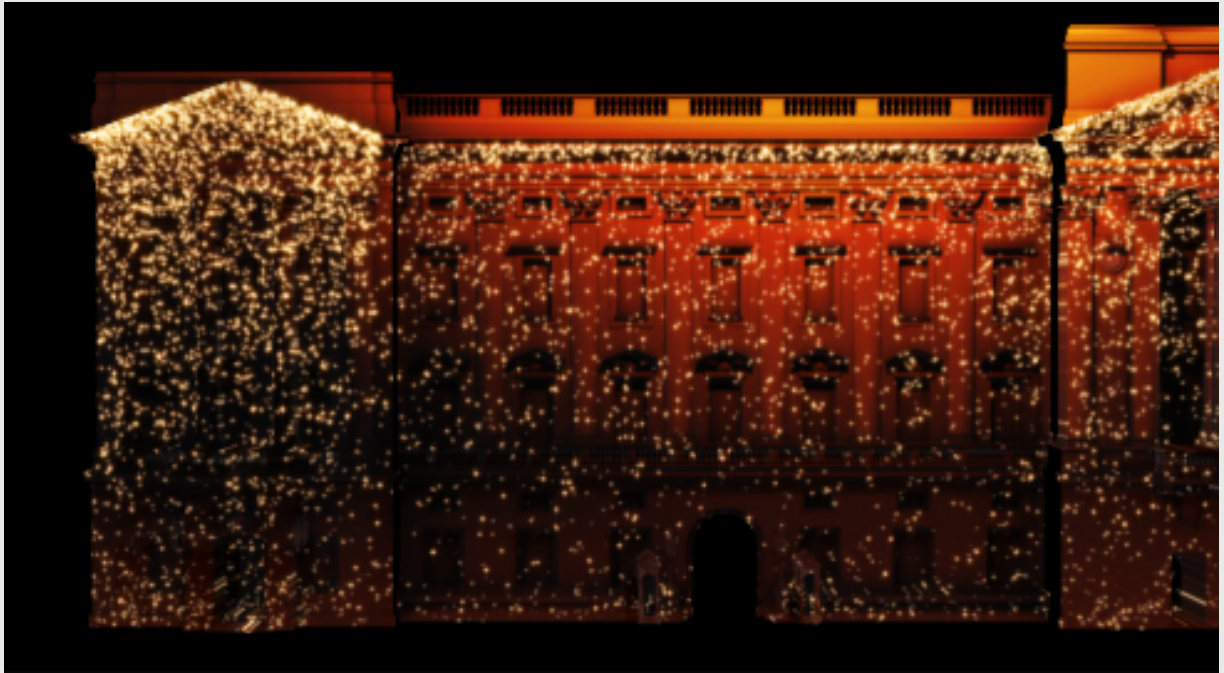

- **Wireframe:** Outputs the wire frame of the model.

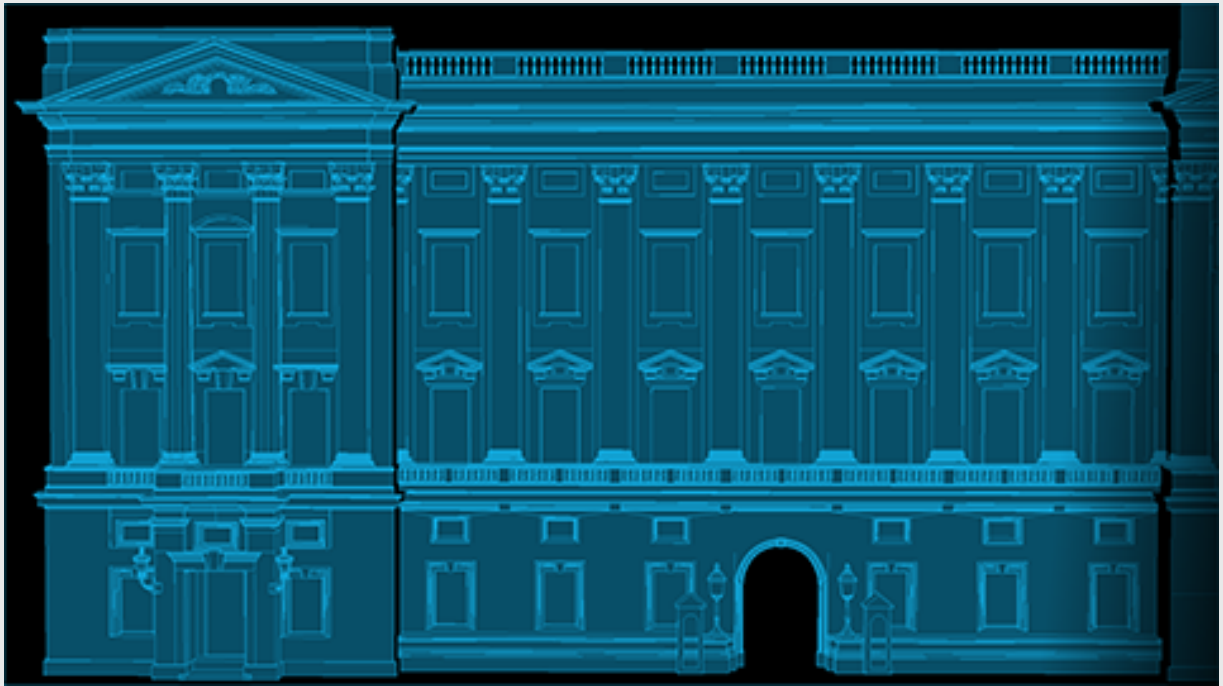

Image of wireframe applied to Buckingham Palace.

- **Identify:** Outputs a full colour grid that has the projectors name on it.



- **Grid:** Outputs a grid that is applied to the model

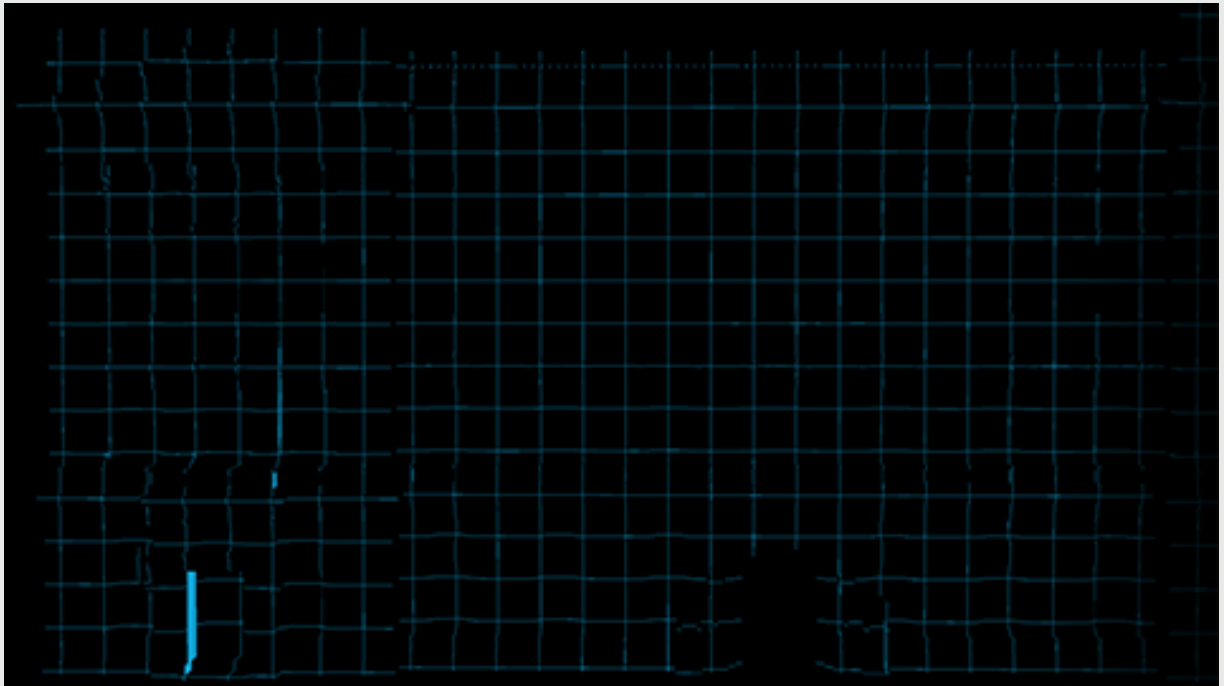

Image of grid pattern applied to Buckingham Palace.

- **None:** Outputs nothing but the line up points.

## Cursor Types

There are four cursor types to choose from:

Horizontal

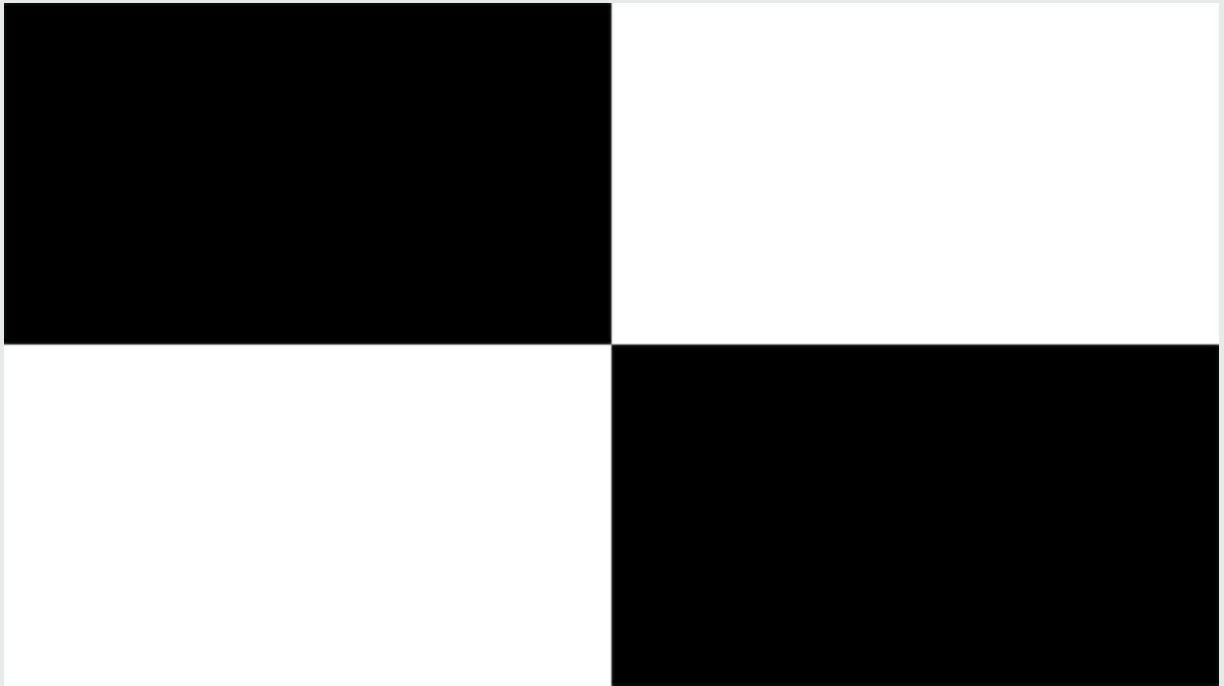

Image of horizontal lineup cursor.

Diagonal

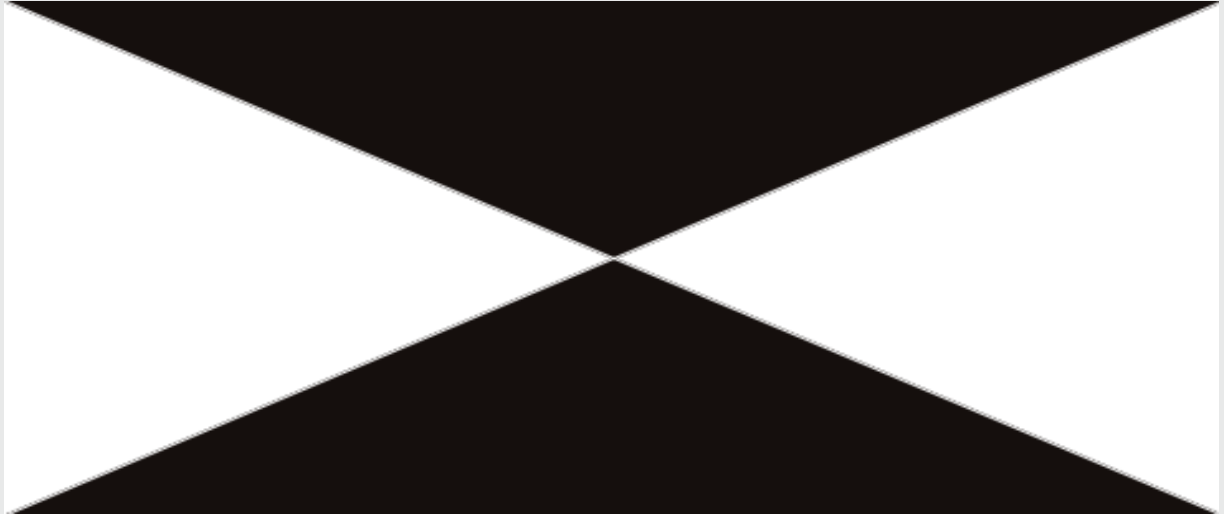

Image of horizontal diagonal cursor.

## Horizontal Lines

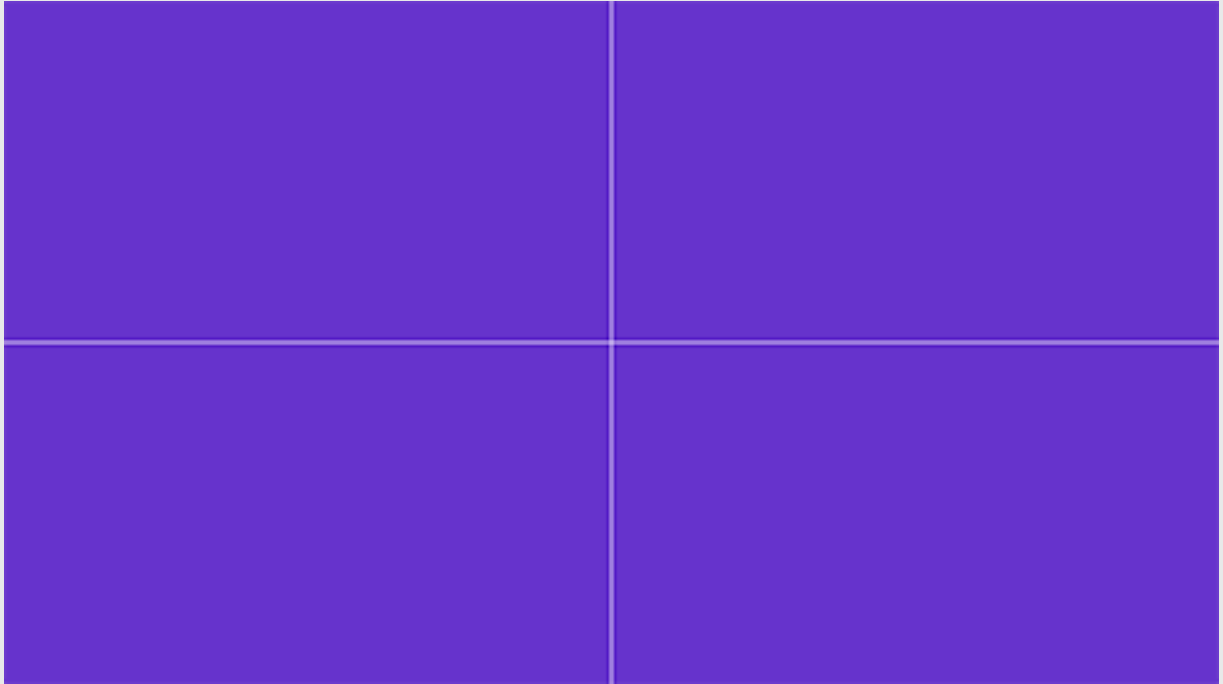

Image of horizontal lines cursor.

## Diagonal Lines

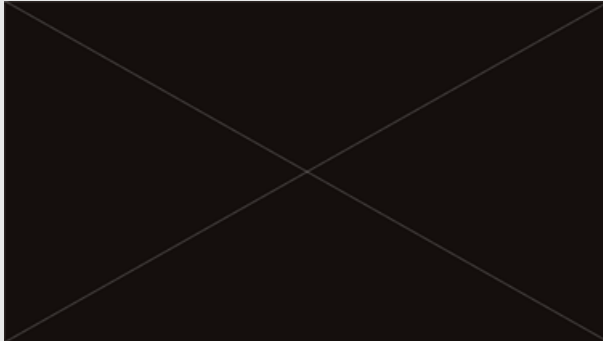

Image of diagonal lines cursor.

## Marker Size

This setting allows you to adjust the size of the marker that's left behind once you have calibrated a point. The default marker size is 16.

## Reset options

To reset the projector so no points have been selected or calibrated either:

- select **reset reference point lineup (current pose)** to reset the points for that pose in a multi-pose line up (see the [Multi-pose calibration](#) sub-chapter for more info on this topic)
- select **reset reference point lineup**

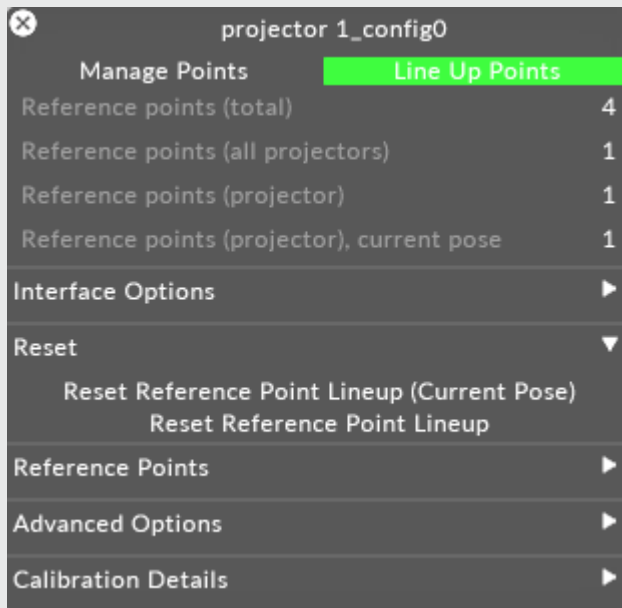

Reset reference point lineup.

- A warning message will pop up when you select **reset projector config**. Click **yes** to **reset projector config**.

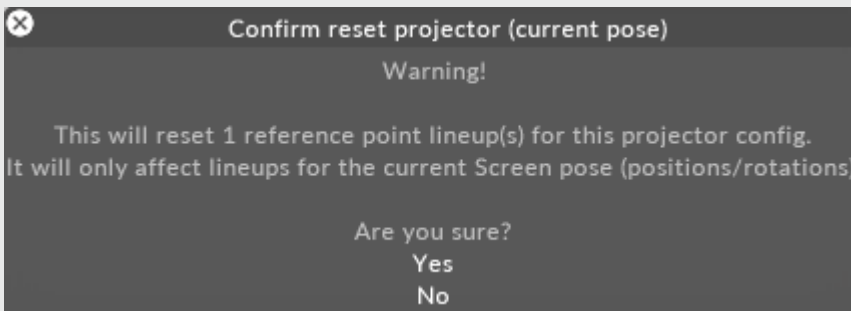

Confirm reset projection config.



# Removing reference points

There are 3 options for removing reference points under the **Reference points** tab:

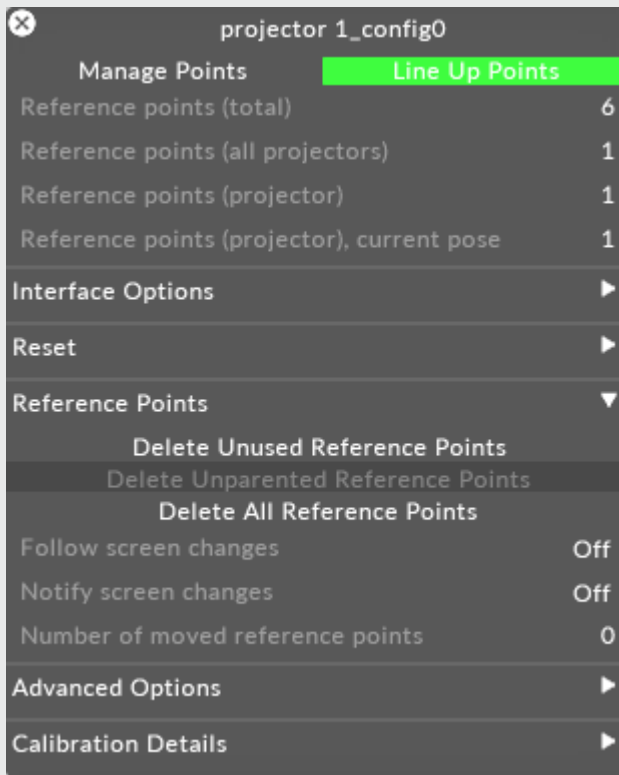

Deleting reference points.

## Delete unused reference points

This option deletes reference points which have not been associated with a projector lineup.

## Delete unparented reference points

This option deletes reference points which are not parented to a screen

## Delete all reference points

This option deletes all reference points from the virtual stage.

A warning message will pop up when you select **delete all reference points** , **Click yes to delete all reference points.**

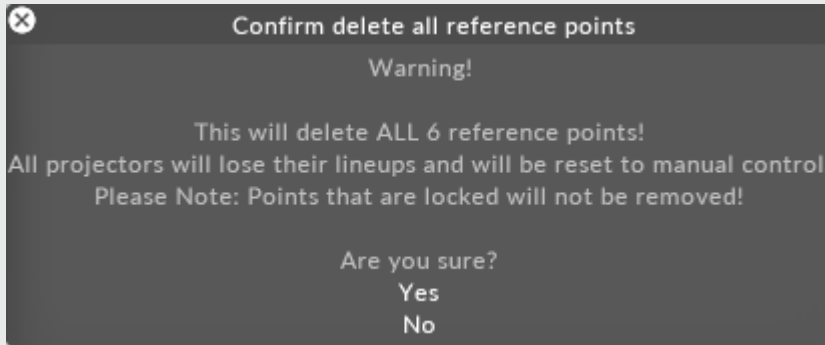

Confirm delete of all reference points.



**Warning:** Delete all reference points is a global action, It will affect all the reference points on the model not just the ones associated with the current projector.

## Advanced options

### Follow screen changes

This option allows you to choose if the reference points follow screen changes. For example if you change your screen position the reference points will move with the screen.



**Warning:** This will automatically update any projector's QuickCal calibration using the new 3D positions of the reference points

### Notify screen changes

This options allows you to choose if you want to be notified of screen changes. For example if the screen position changes and the points move with the screen you will be notified. The notification will ask you whether you want to update the QuickCal calibration with the new 3D positions. It will also show by how much each reference point has moved.

### No. of moved reference points

This informs you how many points have moved with a screen position change for example.

### Auto z-clipping

If auto z-clipping doesn't work, this means some parts of a Screen, which are either very close or very distant, may only be partially visible. then manually adjusting these near/far values can make sure that the projector renders the whole screen.

### Lineup Result

Here is a real world photo of a lineup of Buckingham Palace without the edge blending.



# Creating & deleting reference points

## To create reference points:

1. Open the projector editor.
2. Locate the **Calibration** tab.

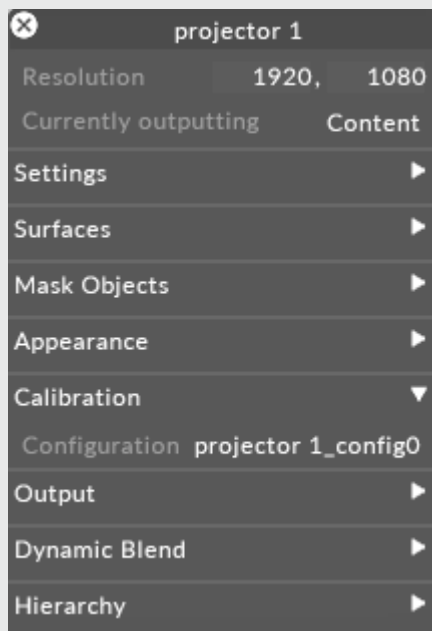

Projector config editor selecting the configuration tab.

3. click the configuration file to open the QuickCal editor. If **left-clicking** you will instead open the Projector Configuration manager which stores all the configuration files for the existing projectors.

4. Select **manage points**.

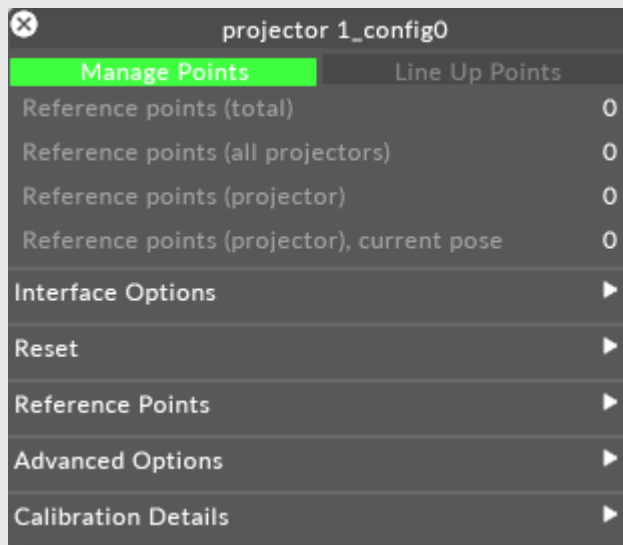

Projector config editor, Selecting manage points.

5. The d3 cursor will now turn in a circle. This indicates that you are in **manage points** mode and when you click on the model a reference point will be created at that location.

**Please note:** The reference points will automatically snap to a vertex near to where you clicked. If you have a really complicated model they may not snap to the correct position select the point you wish to move and hold down the left mouse button to drag it to the desired location.

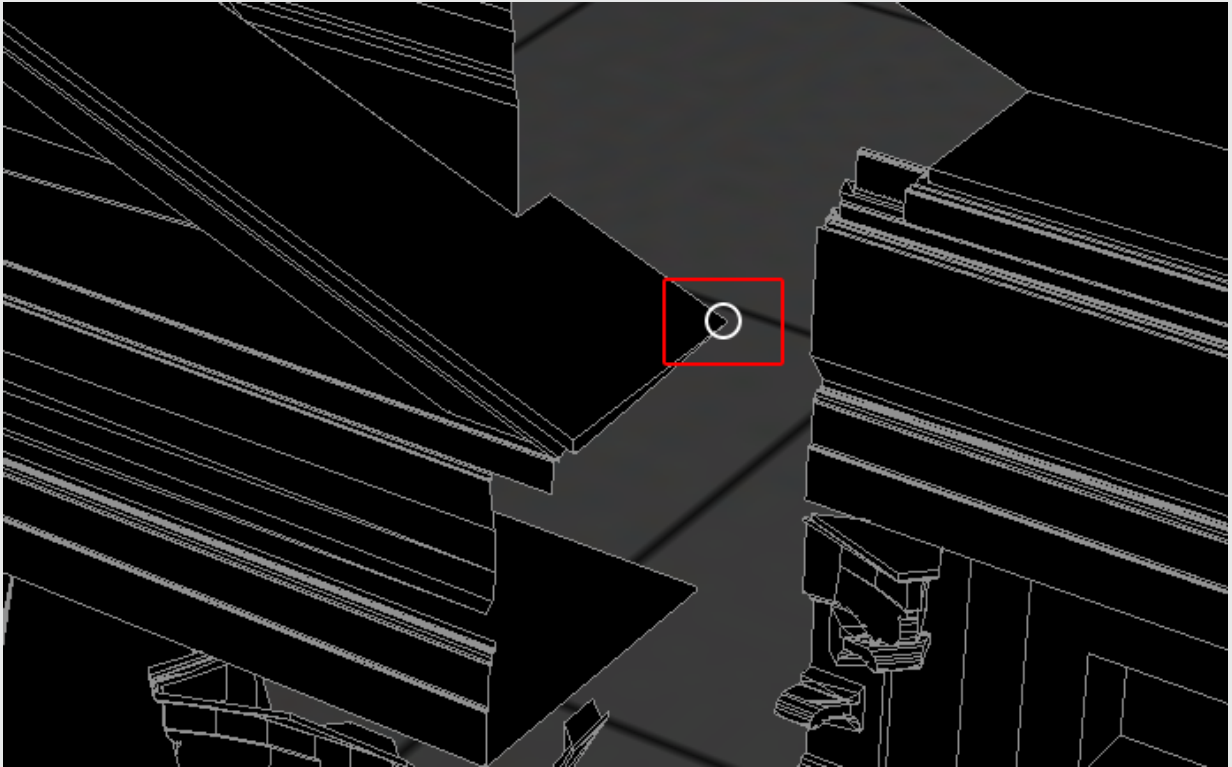

Point creation cursor, Adding a point.

6. Create a minimum of 6 reference points and place them on **clearly** identifiable real-world reference points. This is to make it easier to link the virtual reference points to the corresponding real-world points at a later stage in the lineup process. Usually, there is no need to create more than 6-12 reference points per virtual projector but for more complex geometry it may be necessary to create more. Some complex building mapping projects have required up to 30 reference points per projector.
7. Notice that multiple projectors can use the same reference points.



## To delete a reference point

1. Right-click on the point that you wish to delete.  
The options menu will open.

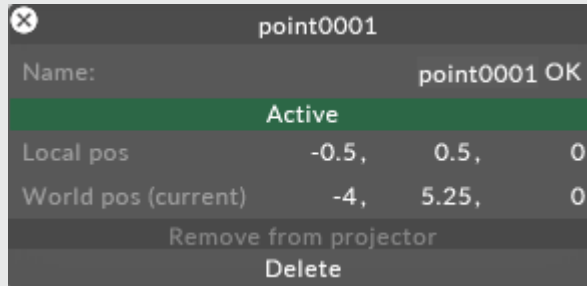

Delete a reference point from the virtual model.

2. Left-click on the **delete** button.



**Warning:** reference points that are lined up in another projector cannot be deleted (since this would affect the other projector's calibration).

# OmniCal Overview

OmniCal is a camera based calibration system which gives disguise the ability to “see”.

## Overview

One of the big frustrations of our powerful 3D workflow has always been achieving accurate 3D models and calibrating those - solutions so far have been based around laser scanning or having a skilled CAD person on site who can modify the CAD model when inconsistencies are found between the 3D mesh and reality.

OmniCal removes the requirement to have accurate 3D models using its powerful calibration and Mesh Deform tools.



## Workflow

### Features

- OmniCal uses structured light patterns to calibrate the relationship between projection surfaces, projectors and cameras.



- The captured images are used to construct a 3D representation of projection surfaces as a point cloud.
- Users then use the QuickAlign tool to manually align projection surfaces in the Disguise project to match their real world positions and proportions. This is an “offline” process which doesn’t require access to the physical stage.
- We provide a single click Mesh Deform tool which deforms a 3D Model to match the real world (using the point cloud data)
- Single click recalibration is supported if only projectors have moved. If cameras or projection surfaces have moved then an operator will need to adjust the previous alignment using current camera images.
- The Disguise simulator also allows you to simulate cameras, view their coverage and perform test calibrations to ensure that the system will perform as required on site.



**Warning:** The simulator should be used as part of the production workflow to assess project suitability.

- Supports 360° projection environments.
- Designed for calibration of surfaces and scenes with 3D depth.

View the [OmniCal Product](#) page.

One camera option is available:

- OmniCal MV system: For fixed installs. Reliable, continuous Ethernet camera connection; choice of lenses for three different fields-of-view; cameras only need setting up once.

## Current limitations

- The quality of the calibration will depend on having suitable lighting conditions.
- Requires constant light levels during capture process.
- Works best with low ambient light levels.
- As mentioned above a Simulation must be run first to check project suitability. For large projects we recommend doing separate calibrations with groups of projectors and manually blending overlaps between the groups.

- Requires non-reflective, opaque projection surfaces (no gauzes or mirrors).
- Needs a few clearly defined feature points on the 3D mesh and real object, which can be visually identified on the camera images. Projection surfaces with sharp corners work well for example, but NOT smooth surfaces with no features.
- OmniCal requires depth from the projectors point of view. Scene depth is particularly important when using moving elements such as Automation.

## For a trained OmniCal operator

### 1. Create a simulated Camera Plan

- a. Use the Disguise simulator to check project suitability.
  - a. You can place virtual cameras and simulate a capture and calibration. You will need to have a project file with projectors and projection surfaces in the same configurations and positions as they will be on-site.
  - b. The basic rule for camera placement is that at least 2 cameras need to see every point on your projection surface(s). Also cameras should also have a large angular separation. i.e the directions they face should not be parallel.
  - c. The simulation will help you determine how many cameras are needed, their positions and lenses and the calibration parameters. It will also show you the ideal calibration results you should expect on-site. Note that these ideal results are without real-world influences like unsuitable lighting conditions, reflections, occlusions, movement in the scene during capture etc.

### 2. Setup Cameras On-site

- a. You will need to make sure the position, orientation and field-of-view of your real cameras matches your simulated Camera Plan. To help you with this, there is a camera setup editor that shows what the cameras are looking at.
- b. When mounting the OmniCal MV system, you need to manually adjust the physical focus and aperture (iris) on the lens, so that the images of the scene are sharp and well exposed. Exposure time can be controlled from within Disguise.
- c. From the Camera Setup tool you check how well Blob Detection is working (the dots that we project in the structured light patterns).
- d. You may need to adjust camera parameters (like exposure time) according to the light level to get the best results.

### 3. Capture



**Warning:** A clear stage without movement or major lighting changes is required for this.

- a. Capture is an automatic 'one-button' process that typically takes less than a minute. Exact duration depends on number of projectors, cameras and the resolution of the structured light pattern (number of blobs).
- b. Once this is complete, the physical stage is free. The next steps can be done "offline".

### 4. Calibration

- a. You can view the point cloud after this stage and see check the calibration errors in pixels for each projector.
- b. You may need to adjust calibration parameters to get the best results, but usually these will be chosen automatically.

### 5. Alignment

- a. This is a manual step which aligns the point cloud with the projection surfaces in Disguise.
- b. Users add alignment points to camera images to line up wireframe views of the projection surfaces with reality.
- c. This only needs to be done once as long as cameras or projection surfaces do not move.
- d. Re-shape points can also be added to correct the shape of the mesh. This can be thought of as a 3D warp from the camera's point of view.

### 6. Mesh Deform

- a. This is a final key step which deforms a mesh in Disguise software to match the real world by using the depth information from the point cloud.

## For an untrained operator (recalibration)

### 1. **Select Camera Plan**

- a. A user would select a Camera Plan previously created by a trained operator which contains known good settings for Capture, Calibration and Alignment.

### 2. **Rig Check**

- a. This tool allows a user to compare live camera images to those from a previous Capture to check whether cameras or projection surfaces have moved. If so, the user can adjust the alignment reference points by dragging them into the correct positions.

### 3. **Execute**

- a. A button which triggers a new Capture and Calibration using the settings from the Camera Plan.
- b. No user interaction is required after this point. Projectors will automatically be calibrated at the end of this process.

## Hardware

OmniCal Machine vision camera kit

The OmniCal MV system come in kits up to 4 or 8 (depending on kit size) and are perfect for fixed installs. They are powered via PoE, so only require a single Ethernet connection.

Lenses including 6, 8 and 12mm are incorporated into the kit depending on your project needs with a total of 24 lenses available, allowing for on the fly customisation to ensure the perfect setup.

### Small Kit



#### **Upper Foam**

Up to 4 disguise MV Cameras

#### **Lower Foam**

Up to 12 Lenses

Options Include:

-  Fujinon 6mm Lens
-  Fujinon 8mm Lens
-  Fujinon 12mm Lens

## Large Kit

### Upper Foam

Up to 8 disguise MV Cameras

### Lower Foam

Up to 24 Lenses

Options Include:

- Fujinon 6mm Lens
- Fujinon 8mm Lens
- Fujinon 12mm Lens

## Not included:

The kits do not contain network equipment like cables, switches or PoE injectors. The Disguise MV cameras require a switch that provides at least 1 GBit/s bandwidth and supports PoE to power the cameras.

## Field of View options

The Disguise OmniCal kits offer camera and lens options to provide various needs in terms of camera coverage and Field of View angles (FOV).

The widest Field of View is with a disguise machine vision camera on a 6mm lens. The most narrow / tele option is with a 12mm lens.

Please note that the Field of View / opening angle depends on the focal length of the lens, and also the physical size of the image sensor. For example, the camera inside an iPod has a much smaller image sensor compared to the disguise MV cameras. Given a certain focal length, a smaller sensor will result in a smaller FOV than a larger sensor.

The focal length mentioned in a lens data sheet is usually the actual value, not the 35mm-film-equivalent. Therefore focal length values can only be directly compared for cameras with the same sensor size.

In our d3 software all information regarding focal length, 35mm-equivalents and FOV is either editable or automatically calculated, when editing a Camera in an OmniCal plan.

An overview of OmniCal camera and lens combinations and the resulting field of view:

Disguise G-507 machine vision cameras have a 3.908 crop factor (compared to 35mm film) when used with approved C-mount lenses.

<b>Focal length</b>	<b>Focal length 35mm equivalent</b>	<b>Horizontal Field of View angle</b>
<b>6 mm</b>	<b>23.4mm</b>	<b>~70.6 degrees</b>
<b>8 mm</b>	<b>31.3 mm</b>	<b>~56 degrees</b>
<b>12 mm</b>	<b>46.9 mm</b>	<b>~39 degrees</b>
<b>25 mm</b>	<b>97.7 mm</b>	<b>~19.3 degrees</b>

## Tips & tricks

- The fast way to tell if you have a good calibration is to look at the reprojection scores for each projector and camera in the calibration report (this is found at the very bottom) - any score below 1 pixel is considered good, similar to the error margin that would be accepted when using QuickCal.
- Anything above 1 pixel usually indicates that something went wrong. In simulations you will normally see errors of around 0.5 pixels or below.
- Avoid reflective surfaces as they can cause issues with calibration
- Use surfaces with a lot of depth features as they make the calibration more accurate. It is especially important to have depth from each projector's "point of view". For example, if all the visible blobs from a projector land on a flat surface it will not be calibrated correctly. One way to fix this is to place an object in your environment temporarily during a capture to provide depth information.
- Each blob needs to be seen by at least 2 cameras to be used in a calibration
- Ensure blobs from across a projectors output can be seen. For example, if only blobs from the top left of a projector are detected it won't be calibrated correctly.
- Ensure a large difference in angles of attack between cameras.

- Capture Setup is important for good blob detection - you will most likely have to change the blob size, grid density and camera exposure to suit your environment.
- Blobs should be as small as possible while still being detected by cameras. This improves the calibration accuracy. Also if they are too large they won't be detected at all.
- Elongated blobs can cause higher calibration errors. Try reducing the blob size to handle this. Avoid large angles between the projector and projection surface normal e.g 45 degrees
- More blobs doesn't mean a better calibration. Usually the default of grid size of 32 is sufficient. Use more blobs if you require a detailed point cloud for Mesh Deform.
- Avoid lighting gradients, if the light level changes across an image blob detection may not work as well.
- If you are calibrating a perfectly flat surface and getting strange results, toggle the epipolar/homography camera calibration algorithm under the Plan's Calibration Setup window and see if you get a better result.
- If most blobs are landing on a flat surface this can skew the calibration results in favour of those areas. Enabling planar point removal in the Plan's Calibration Setup window may improve your results.
- It can be difficult to line up geometrically symmetrical shapes (cubes / pyramids / bowl shapes). You could embed features or identification letters and numbers into the OBJ. You can also name reference points in the Quick Align window.
- Surfaces without corners or visible reference points such as domes and cylinders are difficult to line up.
- If you need to use mesh deform, use the point cloud visualisation mode to preview the results
- Point cloud visualization affects performance, once you have verified the validity of your calibration, turn it off to ensure good performance.

# Troubleshooting



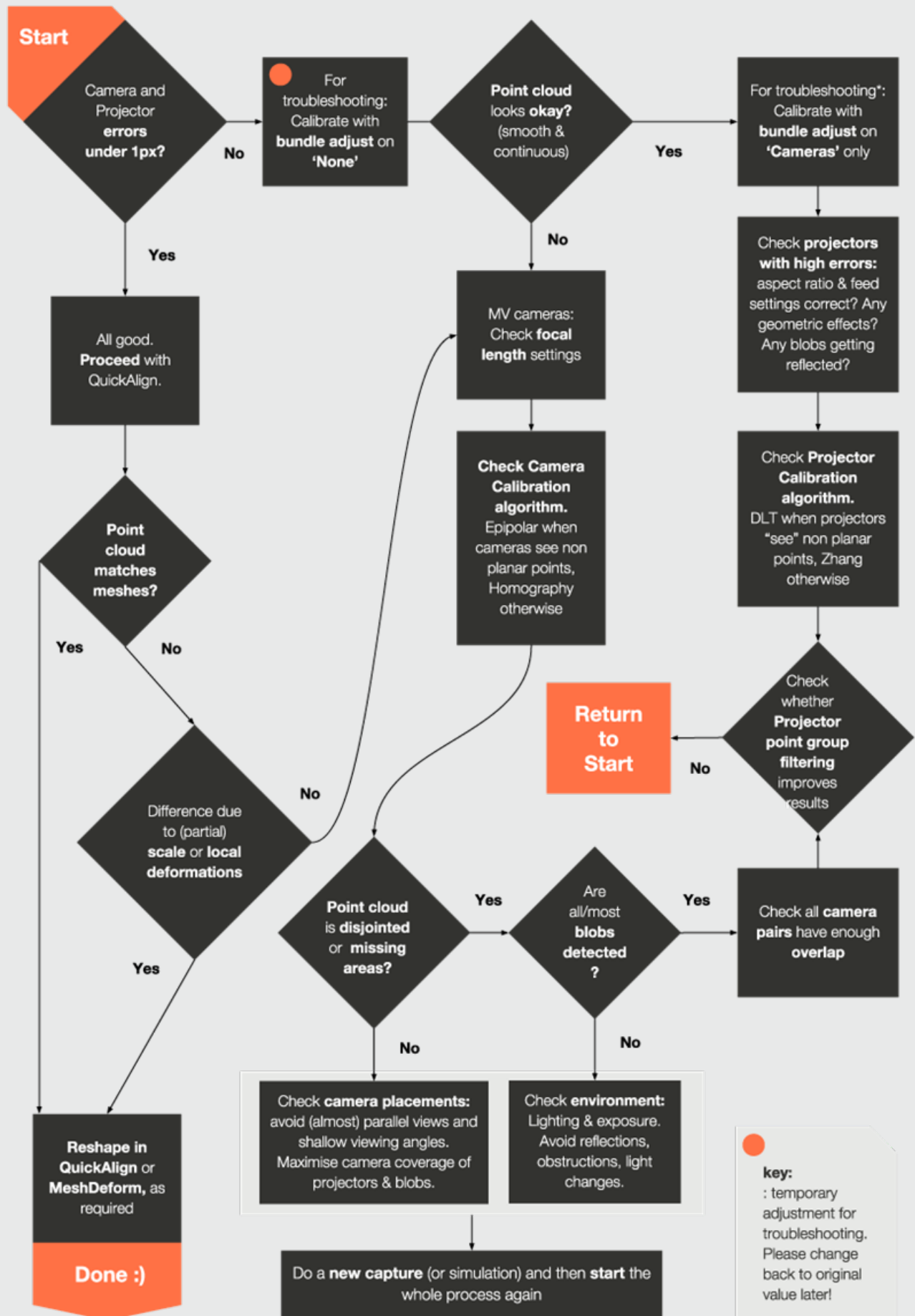

# OmniCal Camera setup

This camera setup must be done before you run Disguise software.



**Warning:** OmniCal camera networks must use a separate network adapter to all other network traffic.

## Overview

1. Download [Vimba for Windows](#).
2. Install Vimba Viewer to configure the cameras.
3. Network setup.
4. Verify camera connections.
5. Adjust exposure & focal length.

## OmniCal MV system

## Network setup



**Warning:** OmniCal MV system cameras use all the available network bandwidth, so they must always remain on a dedicated network, away from any other traffic.

**Please note:** When Camera Discovery is enabled, machine vision cameras continuously capture images and send them to master. This only affects the camera network and not disguise directly, however it consumes CPU time processing these packets.

**Please note:** Camera Discovery can be disabled explicitly in the OmniCal Calibrator window and is also turned off automatically when the OmniCalCalibrator and Plan windows are not open.

## Network infrastructure:

The OmniCal MV system is based on the GigE Vision (R) standard and requires a bandwidth of 1 Gb/s or higher. For example, on 10 Gb/s setups the discovery of Disguise MV cameras and the transmission of captured images will be faster.

The Disguise MV cameras are powered via PoE, which needs to be provided either by the network switch or a PoE injector. The power requirement over PoE is quite low at 2.8W.

Make sure that all parts of the network infrastructure (switches, cables...) match the desired bandwidth and power specifications.

In case of wired cables (as opposed to fibre), we recommend using at least Cat6 cables, because they are more reliable than Cat5e over longer distances or in the presence of electromagnetic interference (EMI).

## Network Adapter Setup

You may need to update to the latest drivers to see some of these advanced options.

- Jumbo Frames: Enabled, with packet size (MTU) 8228 bytes or larger (e.g. 9000 or 9014, depending if the adapter counts the packet header or not).
- DMA Coalescing: Disabled (since it may increase latency)
- Flow Control:
  - » Can be left in default setting. (In most network situations enabling it for Rx/Tx is beneficial, but it will not have an impact on GigE Vision performance).
- Interrupt Moderation Rate: Extreme
- Transmit buffers: 256 bytes
- Receive buffers: max setting available, e.g. 4096 bytes
- See [here](#) for further explanation.

# Setting up the Network adapter

1. Navigate to the **Network and Sharing Center** and click to open the **D - Media 10Gbit adapter**.

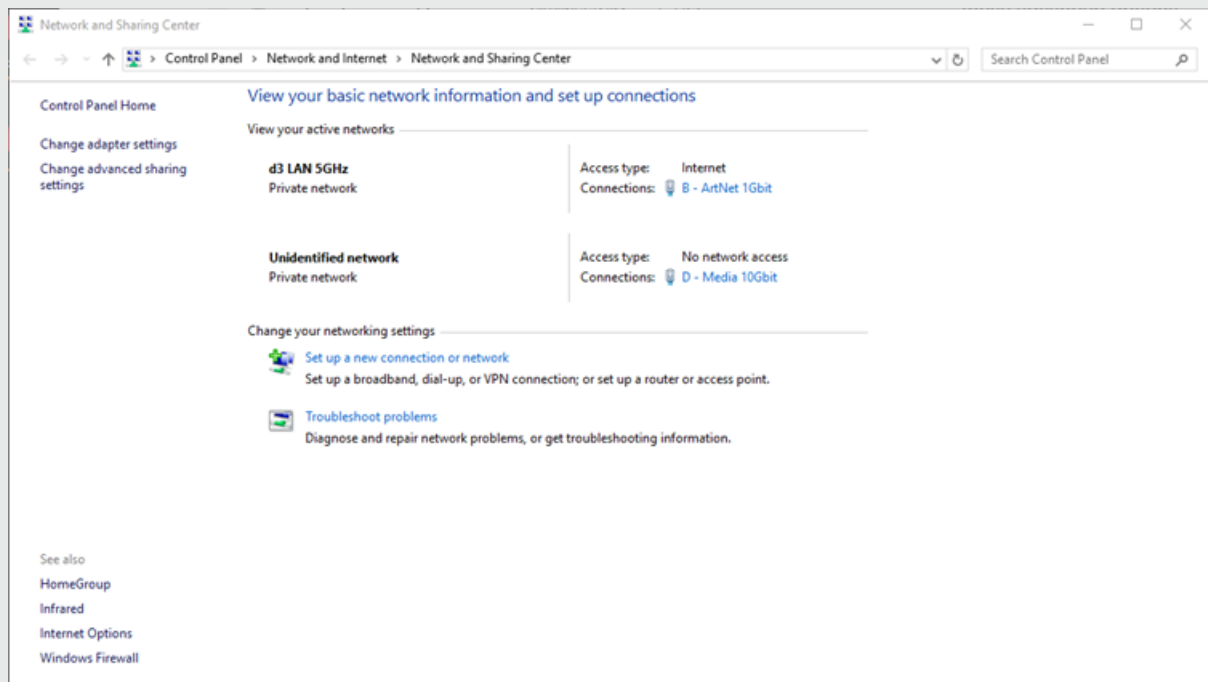

2. On the General tab, click to open **Properties**.

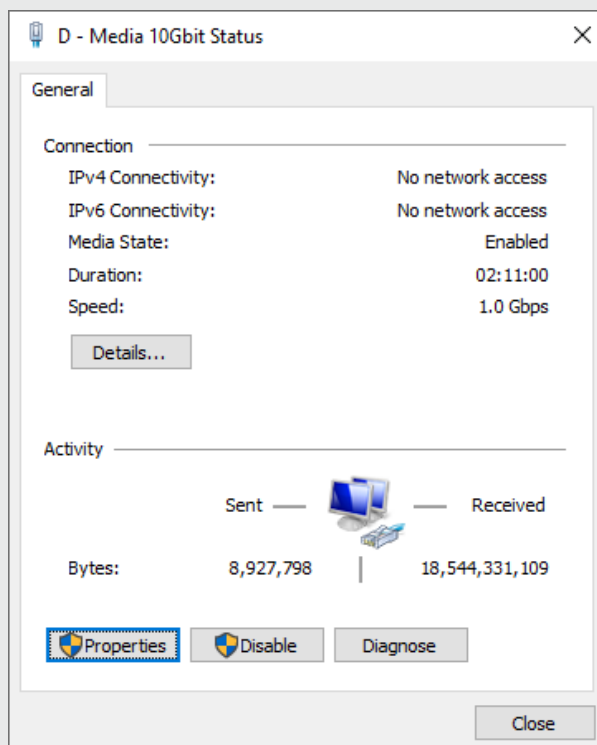

3. Enable the following settings and click **Configure**.

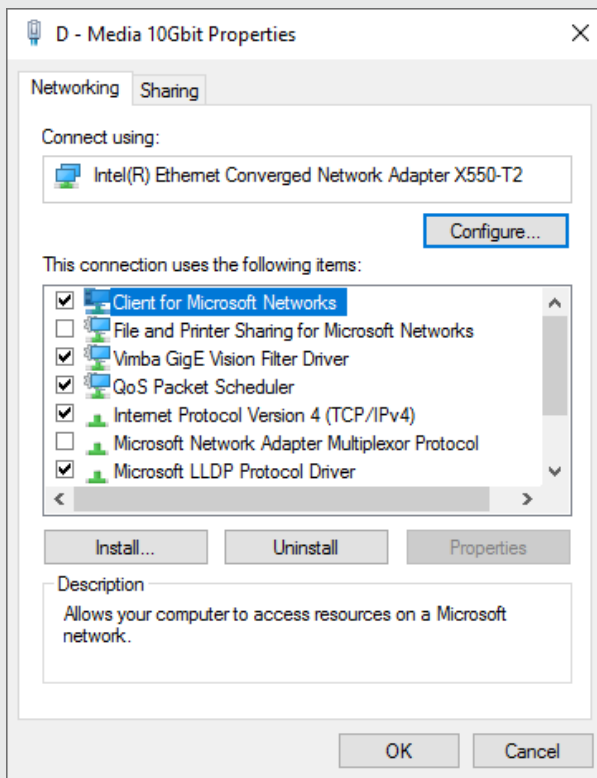

4. Select **Jumbo Packet** and assign it a value of **9014 bytes**.

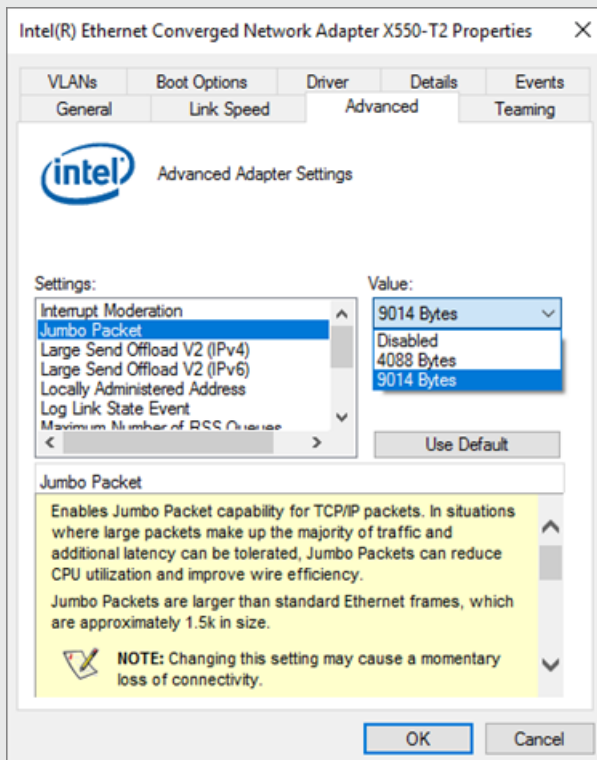

5. On the Advanced tab, select **Performance Options**.

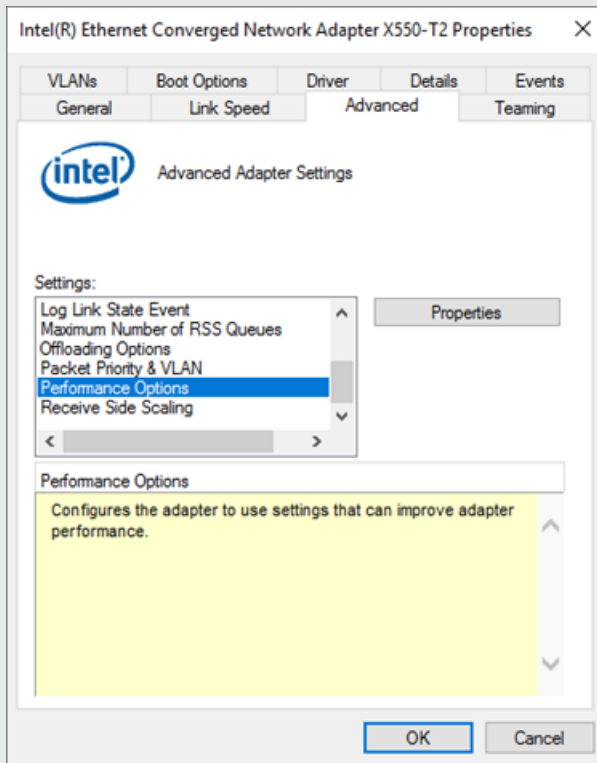

6. Select **Flow Control** and click **Disabled**.

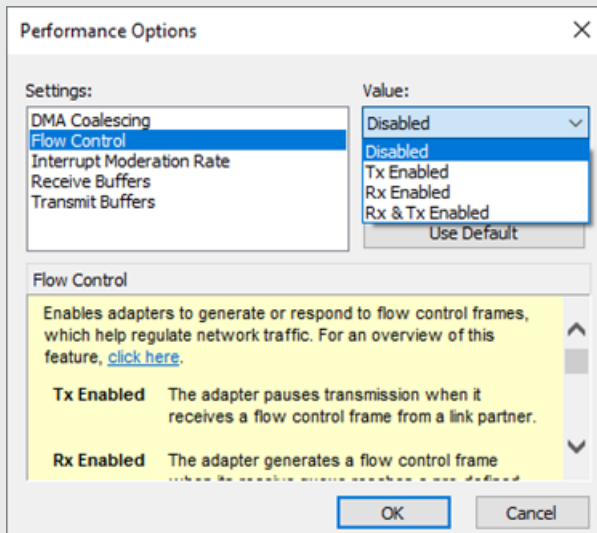

7. Set the **Interrupt Moderation Rate** to **Extreme**.

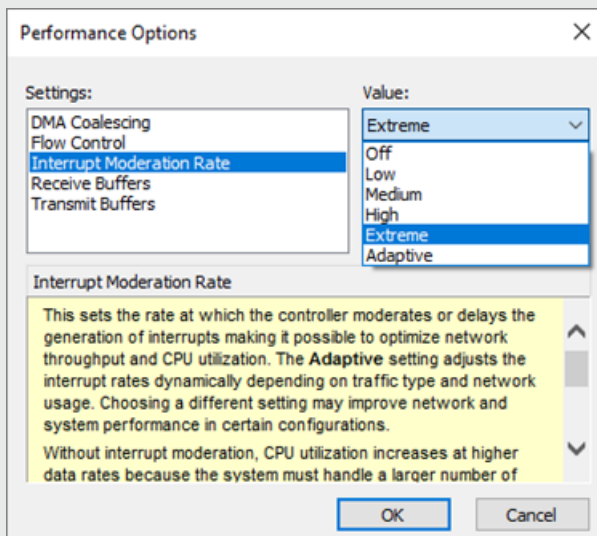

8. Select **Receive Buffers** and set it to **4096**.

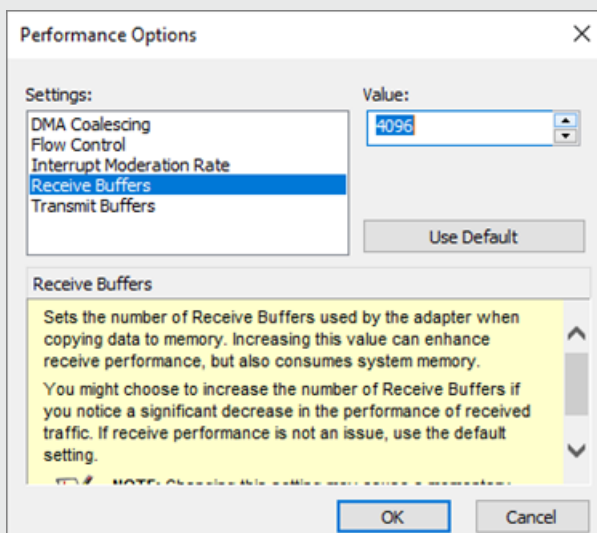

9. Select **Transmit Buffers**, set it to **256** and click **OK**.

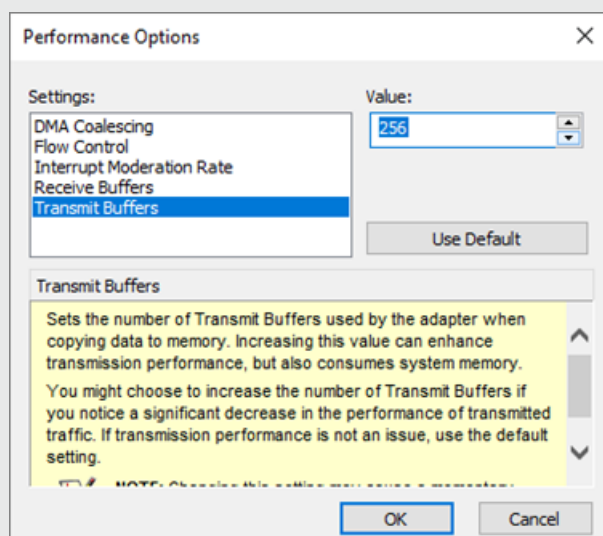

**Please note:** A 1 Gb port should work fine but we normally use a 10 Gb port when available as the max receive buffer size is larger. Some network adapters may show some of the above settings under an Advanced button. Others may not provide some at all. E.g. the external Promise SANLink3 adapter only offers the Jumbo Frames setting.

## Switch Setup

1. Connect a PoE network switch with bandwidth 1 Gb/s or higher.
2. Enable jumbo frames/packets by setting the max packet size to the highest it will go (usually around 9k).

## OmniCal MV system setup (in windows)

The Vimba software installs camera drivers, SDK and the Vimba Viewer application used for testing and trouble shooting.

1. Install Vimba for windows SDK from [here](#).

**Please note:** We recommend Vimba Viewer v2.1.3

2. In the Vimba installer, select **Application Development**.
3. Keep **install drivers** checked and complete the installation as normal.



4. Hit Start.

Open **Vimba Viewer**

5. Plug your cameras in if they are not already.
  - a. They will show up in the Detected Cameras list in Vimba, in white.
  - b. These may have a red lock icon on them if Disguise software is running. Camera access is exclusive to each application. I.e. if you have a camera capturing in Disguise software you will not be able to view it in Vimba and vice versa.

## Verify camera communication

1. Open Vimba and select a camera.
2. Press play button and verify images are streaming

**Please note:** In case camera connections are lost, and replugged, the software should detect them again, but in case they don't you can press the refresh button in the top left corner.

## Troubleshooting

- No image is displayed in Vimba Viewer: try disabling jumbo frames on the network adapter. We've seen this can be an issue on 4x4s. When using jumbo frames over 2034 bytes we aren't able to get complete images from the cameras (due to packet loss). The other workaround is to limit the packet size on the switch. Use Vimba Viewer to verify the GVSP packet size setting is 2034 or below. This is negotiated automatically so you don't set this directly.
- Network adapter becomes disabled after applying the above settings: try reverting the interrupt moderation rate to the default.
- Capturing images is very slow / cameras become unresponsive: try reverting the interrupt moderation rate to the default.

## Configuring cameras in Vimba

You can right-click or double-click on the cameras to see and adjust metadata of the camera.

This window also shows the Play button in the top left hand corner, on pressing this the camera image should appear in this window, this can be zoomed using the mouse scroll button.

# Focus, aperture and focal length

Align the cameras to look at the object that is to be projected onto. Adjust focus as needed. We recommend that you open the aperture as far as it can go, so you can use the exposure time to control the amount of light that comes in. Make note of the focal lengths used by the cameras, you will need these later.

## The Brightness Tab

### Exposure time

Exposure time will heavily depend on the light levels in the calibration environment. On the right hand side you will see a value in milliseconds that allows you to calculate roughly the FPS the camera is producing. High exposure time will make it slow.

The other parameter we will not touch. The only other tab we'll interface with is the All tab.

### All

Here we can type in a filter pattern and search through settings. We might need to change the DeviceUserID here. Just type it in and click search. The ID will be visible inside disguise.

## Connecting to cameras in Disguise software

Part of Disguise software is a separate program called VimbaCamServer.exe which is used to discover and connect to one or more OmniCal MV system cameras on a network.

- In Disguise software the **OmniCal Calibration editor** configures and enables camera discovery on the network.
- Usually, the VimbaCamServer is launched automatically from within disguise, as soon as the Discovery Adapter is set to the localhost Loopback adapter. In that case, the network switch with the cameras needs to be connected directly to a separate network adapter on the disguise server.
- The VimbaCamServer can also be run separately, e.g. on a standalone computer. In that case the Discovery Adapter inside disguise needs to be selected as the network port with which the disguise server machine is connected to this other computer. The disguise server then does not need a direct connection to the OmniCal MV system cameras or the network switch they are on.
- In other words, the Discovery Adapter needs to be set to the network adapter that the camera server app is on. For an OmniCal MV system the VimbaCamServer can be anywhere as long as it can somehow see and connect to the cameras.

The Mobile Cameras button opens a list of cameras that are currently connected to disguise. If you have many MV cameras on a network (especially if it is only 1Gb/s), then the cameras may appear one by one over the course of several seconds.

## Renaming cameras in Vimba Viewer

It is recommended to add unique names for each camera for easier identification within Disguise software. Follow these steps to set this up:

1. Open Vimba Viewer.
2. Locate the setting "DeviceUserID" (not to be confused with a similiar setting labelled "DeviceID" which can not be changed).
3. Rename the camera as desired.

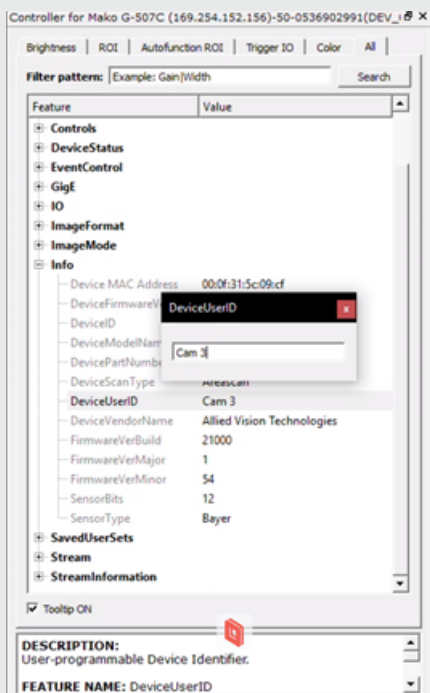

4. Press Enter and close this window. Note that Vimba must be closed in order for the re-name to be visible.

## Further Reading

[GeniCam Network Card Performance Settings](#)

[Advanced Driver Settings for Intel®Ethernet 10 Gigabit Server Adapters](#)

# OmniCal Capture

Capture is the process of projecting structured light patterns and taking images of these to later use in the calibration process.

## Overview

OmniCal Capture is the process of projecting structured light patterns, taking images of these and detecting blobs within these images.

1. Define the position & properties of cameras and projectors.
2. Setup the Capture.
3. Perform the Capture.

## Workflow Example

### Defining cameras & projectors

1. Left click the OmniCal calibration editor from the stage editor to open it.
2. Create a new Capture Plan by right clicking the capture plan to open the **capture plan manager**, entering a name in the new plan field and clicking **OK**.
3. Right click the newly created capture plan.
4. At this point, if you wish to do a simulated capture, set **Use simulated cameras** to Yes.
5. Click the **+** icon to add each of your cameras to the plan.

6. Right click on each of the plan cameras. This will open up the Camera plan editor.
  - a. Left click Mobile Camera and select the required camera from the list of available cameras.
  - b. If you are doing a simulation, you can choose your virtual camera settings here.
7. Click the **+** icon to add your projectors to the plan.

## Setup capture

1. Left click **Setup Capture** to open the Capture editor
2. Set the blob size and the grid size.
  - a. The blob is the size of the blobs we are projecting in pixels.
  - b. The grid size is the number of blobs projected horizontally.

**Please note:** Generally speaking, blobs should be as small as possible whilst still remaining detected by all cameras. More blobs does not necessarily mean better calibration, but will increase calibration time. 32 blobs across should be sufficient for most use cases. More blobs can be useful in a scenario where mesh deform needs to be used.

3. Left click **Grid** to see how many blobs are projected, and how well they cover the surfaces you are calibrating.
4. Left click on **Blobs**. A test blob detection will be performed highlighted in the camera views. The colour coding of the blobs is based on the colour of the projector wireframe. The blobs should be made as small as possible, whilst still being detected in this view.

- a. At this stage, you may need to adjust camera exposure for better blob detection.
- b. To adjust exposure, left click on the camera name and adjust exposure time in the camera plan editor.

**Please note:** A good way of getting setting a suitable exposure time, is turning continuous capture on, selecting grid mode and adjusting the exposure time and turning continuous capture off when you are happy the blob levels are clearly visible.

5. Ensure your **Alignment level** in the Capture setup is at a level where you can see the detail on your models clearly, as this image is the one that will be shown in Alignment.

## Performing a capture



**Warning:** The stage should be clear.

**Warning:** No changing light levels.

**Warning:** No people walking across stage.

1. Click **Capture** from the OmniCal plan editor
2. The system will perform a capture, the time taken will depend on number of projectors & cameras and whether projectors are converging or not. For example, 4 cameras & 4 projectors non converging takes roughly a minute.
3. Verify the results of the capture by clicking **View Capture**.
4. Left click **Blobs** from the **View Capture Editor**.
5. Verify the blob detection results are as expected. These results should be consistent with what you saw in the capture setup. If something went wrong with the capture (change in light levels, people walking across stage), then perform the Capture process again.

# Camera Diagnostics

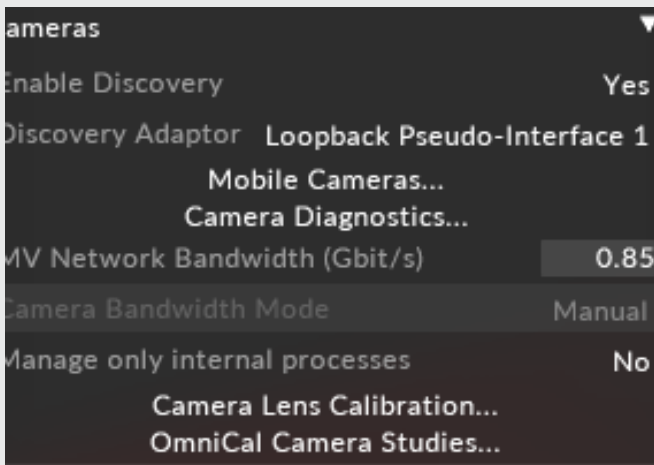

Available in the camera collapsible widget.

1. This will only be enabled if there is a plan and there are plan cameras mapped to MV cameras.

The following is shown for info:

User Name	Device Name	IP Address	Frames Delivered [s]	Frames Incomplete [s]	FPS Camera	Frames Delivered	FPS Bytes Per Second	Test	Graph
cam 1	gnc_01	192.168.1.125	0	0	0	0	0	Start	Open
cam 2	gnc_02	192.168.1.108	0	0	0	0	0	Start	Open

2. Right click header to show columns:

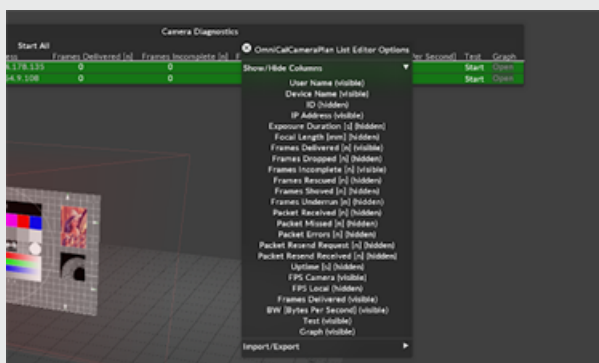

3. This displays camera stats and feedback of settings (such as IP, name). Disguise software only displays plan cameras.
4. Click **Start Per Cam** to enable stats feedback.

Visit this [link](#) for additional information about each of the specific stats.

## Column descriptions

- **Frames incomplete** is the only one measured by Disguise and provides some feedback to the user as to the stability of the cameras in vimbacamserver.  
  
This setting indicates that Disguise software failed to validate the frame data or there may have been an exception when handling frame data from vimba api.
- **Green** means cameras are ok and receiving data from vimbacamserver (with respect to the stats measuring incomplete frames between each receipt of stats).
- **Red** means there have been incomplete frames between the last read and the current read.  
  
The count of incomplete frames will continue to increase .  
  
The red colour will reset if there have been no incomplete frames between each read of the stats.
- Grey indicates the camera has been disabled.
- **Brown** indicates the camera is disconnected/ offline.
- Change mv camera BW to adjust bw per camera. This is split between cameras.
- The graph button will show the stats in graph format.
- Bandwidth allocation can be adjusted while diagnostics are running.
- Dropped packets means you need to lower the bandwidth settings or there is a physical problem like a bad cable



# OmniCal Calibration & alignment

## Overview

The calibration process triangulates the position of the blobs detected in a capture as well as the relative positions of cameras & projectors and their lens intrinsics.

Alignment is the process of marrying the point cloud coordinate system with that of Disguise software.

## Workflow

### Calibration

- Once the calibration is completed, you can view the point cloud and check the error in pixels, for each projector.
- You may need to adjust the calibration parameters to get the best results, but usually these are chosen automatically.

### Alignment

1. Manually align the point cloud with the projection surfaces in Disguise software.
2. Add alignment points to the camera images to line up wireframe views of the projection surfaces with reality.
3. This only needs to be done once as long as cameras or projection surfaces do not move.
4. Re-shape points can also be added to correct the shape of the mesh, this can be thought of as a 3D warp from the cameras point of view.

### Example

# Calibration



**Warning:** From this point, you no longer need access to the physical stage to continue the calibration process.

1. Click **Calibrate**

The system runs the calibration and reports the calibration results in the calibration results widget. The pixel error per camera & projector will be displayed at the bottom of this widget. Values below 1px are considered good, and above 1px usually points to something going wrong in the process.

The generated point cloud will appear in the Disguise stage visualiser at this point but will not be aligned to the stage, unless you previously performed an alignment.

## Alignment

1. The generated point cloud will be aligned to the stage based on the previously performed simulated calibration. If no simulated calibration has been performed, the point cloud will be unaligned with the stage.

There are some automatic options to automatically align the point cloud to the stage. Click **Quick Align**, and choose **Alignment Estimate** which is automatic alignment estimation based on point cloud and all projection surfaces.

**Align to plan cameras** which is the automatic alignment based on positions of plan cameras.

**Align to plan** which aligns to plan cameras and projectors.

**Align to point cloud** is useful for alignment using 2D camera reference points. Use this option when you want to apply the current alignment data to the stage.

If the Alignment assistance tools do not work, proceed to the next step.

2. Manually align the point cloud with the stage using **Initial position**, **Initial rotation** and **Initial scale** settings.
3. Once the point cloud is roughly aligned, you can perform a **Quick Align**.
  - a. Left-click **Quick Align** to open the Quick Align editor.
  - b. The top two views relate to cameras which can be chosen from the view tab.  
The bottom two views relate to the cursor location in the camera view. This is essentially a zoomed in view, for better view finding.

- c. Left-click a point on the wireframe.
- d. Drag it to the corresponding point in the image. Do the same for the corresponding point in the second camera view.
- e. Repeat this process for a minimum of three points.
  - i. Red point means this point is not being used as part of the alignment, but has been added to the view.
  - ii. Yellow means it has been aligned in the current camera, but it is not being used in the calculations.
  - iii. Orange means it has been aligned in a different camera.
  - iv. Green means it has been aligned in both cameras and is being used in the calculation.
  - v. Selected points flash, and you can use the arrow keys to move them around.
  - vi. When points are selected, use **SHIFT** + arrow keys to move the point around & hold **CTRL** & left-click for fine control.

## Alignment re-shape

If the proportions of the model are correct, the alignment should fit perfectly. If the proportions are not correct, you will need to perform a reshape. This can be done by holding **SHIFT** and left-clicking a point which will turn it into a reshape point. Left-clicking the point again will turn it back to a alignment point. A reshape does not use the point cloud, and simply adjusts the proportions of the model to match.

## Multi-screen alignment

- The master screen should be aligned first.
- It not moved on the stage. It acts as a registration point for other screens. Reshaping or scaling of the Master screen will therefore affect all other screens.
- When aligning secondary screens, they will be moved to the correct position relative the Master screen.
- Its best to choose a screen that does not move, for a master screen.

## Mesh deform



**Warning:** This may take a while, depending on mesh size, number of vertices and point cloud size.

If the depth of the mesh in Disguise software does not match the real world object, it will require mesh deforming. Mesh deform will deform the mesh to match the point cloud.

It is a good idea to try the default settings for mesh deform first, to see if you get a good deform. If not, proceed to tweak the settings as required.

You can quickly preview Mesh deform results by changing the Point Cloud visualisation mode to Deform in the OmniCal calibration editor. The results are updated in real-time so you can try out different deform settings using this. The lines indicate where each point on the mesh would be moved to.

**Please note:** You must have added re-shape points to the screens for Mesh deform to work.

1. To perform a Mesh deform, click **Mesh deform** from the Alignment tab of the Plan editor
2. Select the screen you wish to deform by left-clicking the **screen property** in the deform editor.
3. Left-click **Deform**

# OmniCal Multi-pose alignment

Multi-pose alignment improves the way OmniCal works with objects controlled by automation.

## Overview

OmniCal QuickAlign currently positions secondary (non-master) objects. Multi-pose adds the ability to do this in multiple positions, or “poses”. The automation system can then be given information about these poses and interpolate between them when moving objects.

Currently only movement along a linear path is supported, which requires 2 poses per object.

## Prerequisites

- A master screen is required as well as the objects that are moving. The master screen must be stationary.
- Accurate Meshes: Multi-pose is designed to interpolate between object poses. These poses are determined by reference points, therefore an accurate model is required.
- It is recommended that the master screen matches the scale in the real world as this will define the scale for the whole calibration. If your master screen scale is incorrect, you may have to adjust the scale of all secondary screens.

## Limitations

- Only supports linear paths, with a single input value from the automation system.
- Does not support calculating rotation pivot points. If an object rotates between poses, the system will simply linearly interpolate between these rotations, which may not be what is desired.
- Multi-pose alignment only uses a single calibration (it is not multi-pose calibration like QuickCal). Therefore there are some important requirements for projector calibration:
  - » Projectors need to be calibrated with depth using the DLT algorithm. Blobs cannot be on a single plane.

- » Projection will only be accurate within the calibrated "space". ie around same place where blobs land. Surface movement should be limited to this area.

- No mesh interpolation is done

- Mult-pose alignment is not supported by the Rig Check workflow. It shouldn't normally be necessary to use multipose on a regular basis. It should only be necessary to redo it when there are changes to the automation system causing screens to move along a different path.

## Workflow

1. Extract good Meshes.
2. Setup automation axes for all moving screens.
3. Perform a capture and calibration.
4. Align master screen and all static screens in base pose.
5. Create 2 poses for each moving screen.

## Example

### Extract Good Meshes

The multi-pose workflow requires that you have accurate meshes. You can skip this step if you already have these or if you are in a simulation

Please see "Extracting a mesh using OmniCal" for further information

Setup automation axes for all moving screens

1. Create an automation device and driver using the regular workflow. For information on creating automation devices, visit [this link](#).
  - Create 6 axes all with the same input ID from automation, for XYZ position and XYZ rotation of the object as follows.



**Warning:** Note that all 6 axes are required even if the object is moving in a single dimension and no rotation is expected. This is because QuickAlign will calculate a composite rotation and translation of the surface. Ignoring rotation will mean the



translation will not be correct. This will become especially apparent when local origin of the mesh is far way from its centroid.

Perform a capture and calibration

Follow the regular OmniCal workflow capture and calibrate.

Open the Quick Align editor.

Align master screen and all static screens in base pose

1. Align the Master screen.
  - a. Make sure the Current Pose is set to base, the Master Screen and Current Screen are set to the actual master screen object in the visualiser.
  - b. Perform an alignment.
  - c. Repeat for all static screens
    - i. You can only use reshape tools in the base pose. In min and max poses, the current mesh is being moved, but no reshaping is supported. Note that the UI does not yet prevent you from turning alignment points into reshape points.
    - ii. If you need to reshape a mesh for which you need to use the Multi-Pose workflow, then you can either do this by aligning and reshaping in the base pose, or doing it in a separate step, and export+re-import the mesh (probably preferred).

## Create poses for each moving screen

1. With the Quick Align editor open, ask automation to move the moving piece to its minimum position.
2. Create min pose
  - a. Click Create Pose
  - b. This will take a capture and present the camera images for the user to align to. It will also take a snapshot of the current automation input values.
  - c. Select the Current Screen as the object which has just been moved by automation to be aligned.

- d. Perform an alignment of the screen at the minimum position.
  - e. Each pose can contain multiple screens so you can repeat this for each screen that is visible. Alternatively you could create a separate pose per screen.
  - f. Click the Set Min Range in the automation section of the Quick Align editor.
  - g. The minimum pose has now been set.
  - h. You can right click on a pose to view the screens and automation data contained within it.
3. Keeping the Quick Align editor open, ask automation to move the moving piece to its maximum position.
  4. Create max Pose
    - a. Repeat the same pose creation steps and instead select Set Max Range in the automation section of the Quick Align editor.
  5. Click Normalise Rotation (always required unless a rotation of  $\geq 180$  degrees is required between the poses)
    - a. For example, after a multi-pose alignment, if you get  $-0.2\text{deg}$  as the min output and  $359.7\text{deg}$  as the max output, then the min output should be set to  $359.7$  or the max output should be set to  $-0.3\text{deg}$ . This is because the direction of rotation is ambiguous.
  6. Close the Quick Align editor and ensure automation is engaged.



# OmniCal Rig-check

## Overview

Rig check is the tool for quickly re-calibrating without advanced knowledge of the rest of the OmniCal system. It is primarily used by touring operators to re-calibrate shows moving into new venues.

## Workflow

The Rig Check workflow is used after a full OmniCal calibration & alignment has been completed. The plan is used as a template to repeat the calibration with the same settings. The plan is not modified in this workflow.

1. Ensure that you have a plan already calibrated by a Trained user. It should be selected in the OmniCal Calibrator editor.
2. Left-click **Check Cameras** in the OmniCal Calibrator editor.
3. Verify there are no errors when the **Check Cameras** window opens. Errors can include the following:
  - a. Cameras are unavailable
  - b. Camera names have been modified in the plan. The plan capture is used as a reference for Rig Check. Any changes to cameras names after the plan capture was done will invalidate it.
4. The **Check Cameras** window will open which shows camera pairs consisting of the original plan capture and a snapshot capture of the current stage. You can take a new snapshot using the Refresh Camera Views button.
5. Ensure that the camera views match:
  - a. They don't need to be identical, but the coverage of projection surfaces should match and they should be in approximately the same positions.
  - b. The brightness of the images should also match. The exact camera settings specified in the plan (like exposure time) will be used here, so any differences would be either due

to the physical aperture or focus of the camera lens (for machine vision cameras) or the lighting environment. It is therefore recommended that the focus and aperture of machine vision cameras be locked in place for repeatability

6. Once you are happy with the camera views, close the **Check Cameras** window.
  7. Left-click **Execute Plan**. This will perform a capture, calibration, alignment and optionally a mesh deform if it was configured to run automatically in the plan's deform settings. A new **Result** object is created which contains the capture and calibration.
  8. Ensure that the correct **Plan** and **Result** are selected in the OmniCal Calibrator editor.
  9. Left-click **Check Result** in the OmniCal Calibrator editor. Note that this will apply the result's alignment to the stage (if it hasn't been applied already). This will update both projectors and projection surfaces if they have alignment points. If **Check Result** is greyed out a tool tip should tell you the reason, which can include the following:
    - a. The **Plan** has no capture or calibration
    - b. The **Result** has no capture or calibration
  10. Verify there are no errors when the **Check Result** window opens. Errors can include the following:
    - a. The camera names in the **Plan** and **Result** don't match. The **Plan** may have been modified since the **Result** was created.
  11. The **Check Result** window will open which shows camera pairs consisting of the original **Plan** capture and the **Result** capture that was taken.
  12. Left-click on a camera image to open the **Result Aligner** window. If an **Mesh Deforms** have been applied these will be undone in order for alignment points to be editable.
  13. On the left hand side is the camera view from the original **Plan** (read only) and on the right the **Result**. You can then update the alignment points on the right to match the left. This will update the alignment on the stage as you do it. The controls are identical to **Quick Align**.
  14. Select the next screen by pressing the button at the bottom of the camera views or selecting it from the surfaces drop down and repeat the process of checking and adjusting alignment points.
  15. Repeat this for all cameras. You could in theory only check cameras or projection surfaces which you know to have moved.
  16. Close the **Check Result** window. You will be asked if you'd like to re-apply the mesh deform
-



**Warning:** The stage should be clear

**Warning:** No changing light levels

**Warning:** No people walking across stage

## Example

# Accessing rig-check

1. Open the stage editor by right-clicking Stage in the dashboard, or by right-clicking the floor in the visualiser.
2. Left-click **OmniCal Calibration** to open the OmniCal editor.
3. Ensure that you have a plan already calibrated by a Trained user.
4. Left-click **Check cameras**.

# Using rig-check

1. Ensure that you have a plan already calibrated by a Trained user. It should be selected in the OmniCal Calibrator editor.
2. Left-click Check Cameras in the OmniCal Calibrator editor.
3. Verify there are no errors when the rig-check editor opens.

Errors can include the following:

- Cameras are unavailable
  - Camera names have been modified in the plan. The plan capture is used as a reference for Rig Check. Any changes to cameras names after the plan capture was done will invalidate it.
4. The **Check Cameras** window will open which shows camera pairs consisting of the original plan capture and a snapshot capture of the current stage. You can take a new snapshot using the Refresh Camera Views button.
  5. Ensure that the camera views match:

- a. They don't need to be identical, but the coverage of projection surfaces should match and they should be in approximately the same positions.
    - b. The brightness of the images should also match. The exact camera settings specified in the plan (like exposure time) will be used here, so any differences would be either due to the physical aperture or focus of the camera lens (for machine vision cameras) or the lighting environment. It is therefore recommended that the focus and aperture of machine vision cameras be locked in place for repeatability
  6. Once you are happy with the camera views, close the Check Cameras window.
  7. Left-click **Execute Plan**. This will perform a capture, calibration, alignment and optionally a mesh deform if it was configured to run automatically in the plan's deform settings. A new Result object is created which contains the capture and calibration.
  8. Ensure that the correct Plan and Result are selected in the OmniCal Calibrator editor.
  9. Left-click **Check Result** in the OmniCal Calibrator editor. Note that this will apply the Result's alignment to the stage (if it hasn't been applied already). This will update both projectors and projection surfaces if they have alignment points. If Check Result is greyed out a tool tip should tell you the reason, which can include the following:
    - a. The Plan has no capture or calibration
    - b. The Result has no capture or calibration
  10. Verify there are no errors when the Check Result window opens. Errors can include the following:
    - a. The camera names in the Plan and Result don't match. The Plan may have been modified since the Result was created.
  11. The Check Result window will open which shows camera pairs consisting of the original Plan capture and the Result capture that was taken.
  12. Left-click on a camera image to open the Result Aligner window. If an Mesh Deforms have been applied these will be undone in order for alignment points to be editable.
  13. On the left hand side is the camera view from the original Plan (read only) and on the right the Result. You can then update the alignment points on the right to match the left. This will update the alignment on the stage as you do it. The controls are identical to Quick Align.
  14. Select the next screen by pressing the button at the bottom of the camera views or selecting it from the surfaces drop down and repeat the process of checking and adjusting alignment points.
-

15. Repeat this for all cameras. You could in theory only check cameras or projection surfaces which you know to have moved.
16. Close the Check Result window. You will be asked if you'd like to re-apply the mesh deform.

Warning:



The stage should be clear.

With no changing light levels.

And no people walking across stage.

# DMX

This topic explains how to configure Disguise to prove DMX input and output, using an Art-Net device as an example.



**Warning: it is possible to map a DmxDevice to conflicting address ranges. This will result in unpredictable behaviour.**

The Disguise software also uses a number of other converter device types: sACN, Enttec, Soundlight, Exdmx, Kinet v1 and Kinet v2.

To setup the Art-Net connection you first need to create a DmxDevice. A DmxDevice represents a physical output device that connects to the computer (via USB or ethernet) and outputs and/or receives DMX to/from physical devices. d3 supports a number of such DMX converters and protocols. You will need to create a separate DmxDevice for each physical converter device.

## Create a DmxDevice

A DmxDevice is created in the same way as any other device type. Please see the sub-chapter [Creating devices](#) for step-by-step instructions on how to create a device, and select **DmxDevice** from the menu of different device types.

# Edit the DmxDevice

1. Right-click the new DmxDevice, in this case Art-Net, to open the DmxDevice editor.

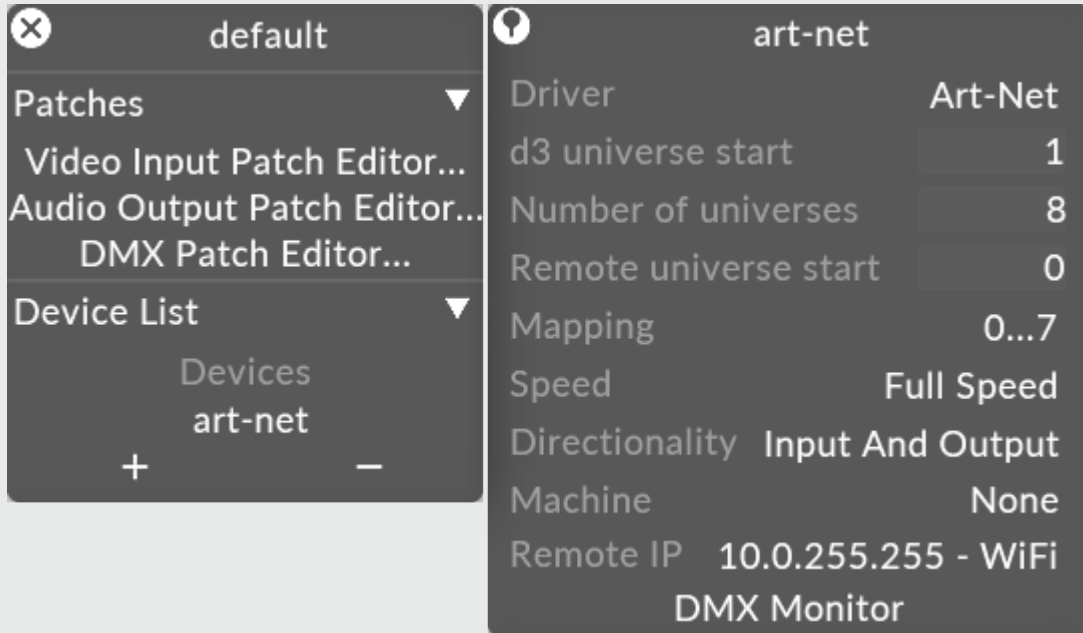

2. Left-click **driver**. This is an option switch that selects the converter device type.

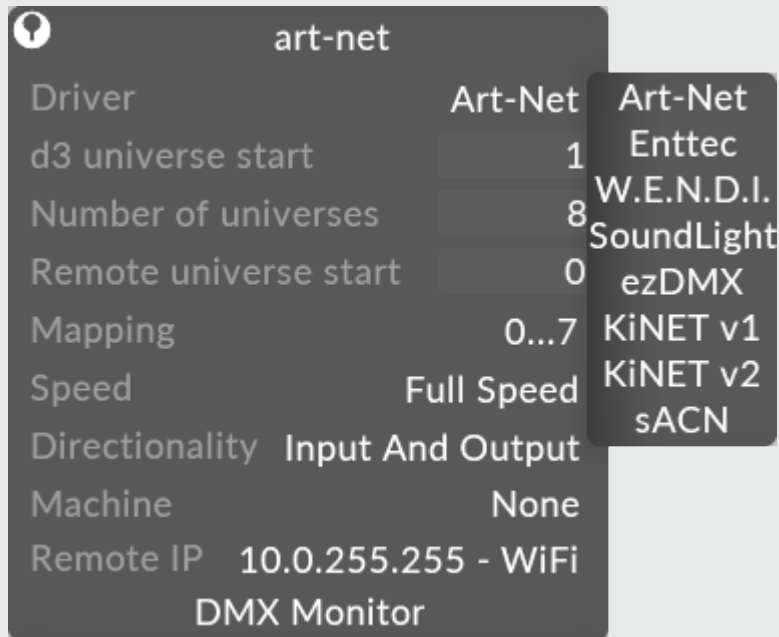

Driver property points to different options of converter device types

## Protocols Supported

The following options are supported:

### — Art-Net

This is the most commonly used DMX-over-ethernet protocol. Art-Net can transmit up to 32,768 Universes of data via a single ethernet cable.

### Art-Net broadcast

To do Art-Net Broadcast, set the remote IP of the device to be the broadcast address of the network. **Example** - if the node's IP is 2.0.0.1 and the net mask is 255.0.0.0 then the broadcast IP will be 2.255.255.255.



# Art-Net IP Address Filtering

We've modified the way we manage Art-Net/sACN connections to allow for more precise layering of DMX data. This means that Disguise is now more strict regarding which IP address it will receive data from, as opposed to the previous behaviour in which it would listen to the entire subnet. In light of this change, users will now need to be more specific when entering remote IP addresses, ensuring that either the correct unicast address or the subnet's broadcast address is used.

## sACN

Streaming-ACN, also known as ANSI E.131-2016, is an alternate DMX-over-Ethernet protocol that is supported by Disguise. Unlike Art-Net, which is a broadcast (or unicast) protocol, sACN is a multicast protocol and can transmit up to 63,999 Universes of control data via an ethernet network.

When selecting an adapter for multicast traffic in Disguise software, it loads the list of the adapters present on the local machine. Note that the name of the adapter that is being used to transmit the sACN signal must be labeled the same way on each of the servers in the network in order to connect properly.

Incorrect example:

Server A (Director) NIC B labeled "B - sACN 1Gbit"

Server B (Actor) NIC B labeled "B - Artnet 1Gbit" (NIC B will not receive DMX)

Correct example:

Server A (Director) NIC B labeled "B - sACN 1Gbit"

Server B (Actor) NIC B labeled "B - sACN 1Gbit"

## — Enttec

This is the protocol supported by the popular Enttec Datagate conversion devices.

## — Soundlight

This is a USB based protocol communicating with DMX devices made by Soundlight Inc.

## — EZDMX

This is a USB based protocol communicating with Avolites EZDMX devices.

## — Kinet V1 and V2

This is a lighting control protocol supported by Color Kinetics devices.

For this example:

- Select **Artnet** from the list of driver converter types.
- Left-click **IP-address** to open the IP address editor. Ethernetbased protocols (Artnet, Enttec, Wendi) identify each physical device with a different IP address. This property has no function for USBbased protocols (Soundlight, Ezdmx).
- Left-click **Manual address** to open the **Select Remote Node** window and type in the IP address of the device. In this example the IP address for a GrandMA lighting desk is being typed in.
- Left-click **OK** when you have finished typing in the IP address.
- Type in the **start universe** value; universe numbers always start from 1. The **start universe** property specifies the first universe number of the device. Disguise software makes an arbitrary number of DMX universes available to you and maps ranges of universes to

individual DMX converter devices. This number specifies the universe number of the first universe mapped to this device.

- Type in the **universes** value. This specifies the number of universes to be mapped to the DMX device. In the example above, universes 1 through 8 are mapped to the Art-Net device located at 10.0.0.83.

## Prove DMX input/output

1. Open the DMX monitor by left-clicking **DMX monitor** in the Device editor. The DMX monitor is used to prove DMX input and output, in this example for an Artnet device.

The screenshot shows three overlapping windows from a software interface:

- default** window: Shows 'Patches' (Video Input Patch, Audio Output Patch) and 'Device List' (Devices: artnet).
- artnet** window: Shows configuration for 'Driver: Art-Net', 'Start universe: 1', 'Number of universes: 8', 'Speed: Full Speed', and 'IP address: 2.0.0.1 - <manual>'. A 'DMX Monitor' button is visible at the bottom.
- DMX Monitor** window: Displays a grid for monitoring DMX data. The grid has 16 columns (labeled 1-16) and 16 rows (labeled 1-16). The 'Output' column is set to '1' and 'Decimal'. The grid contains a 16x16 matrix of zeros, indicating no DMX data is currently being received or transmitted.

DMX monitor is used to prove DMX input and output, opened by left-clicking DMX Monitor from the DmxDevice editor

2. Type in the **universe** value to prove DMX input on that specific universe.

3. Left click on **Monitor** to change the value from **Output** to **Input**.
4. Check if the values are coming into Disguise software.

## DMX Transports Overview

DMX Transports allow d3's transport controls to be controlled by external DMX sources, mainly lighting desks.

# Setup DMX transports

This sub-chapter explains how to configure Disguise software to control the [Timeline](#) with Art-Net.

Please note: GrandMA2 users can find a pre-built Timeline personality on our [download page](#).

## Creating a EventTransportDmx Object

1. Right-click on the Transport menu from the d3 State menu bar.
2. Under the **Event Transports** tab click the + icon and create a new **EventTransportDmx** object. This will open the **EventTransportDmx** editor.

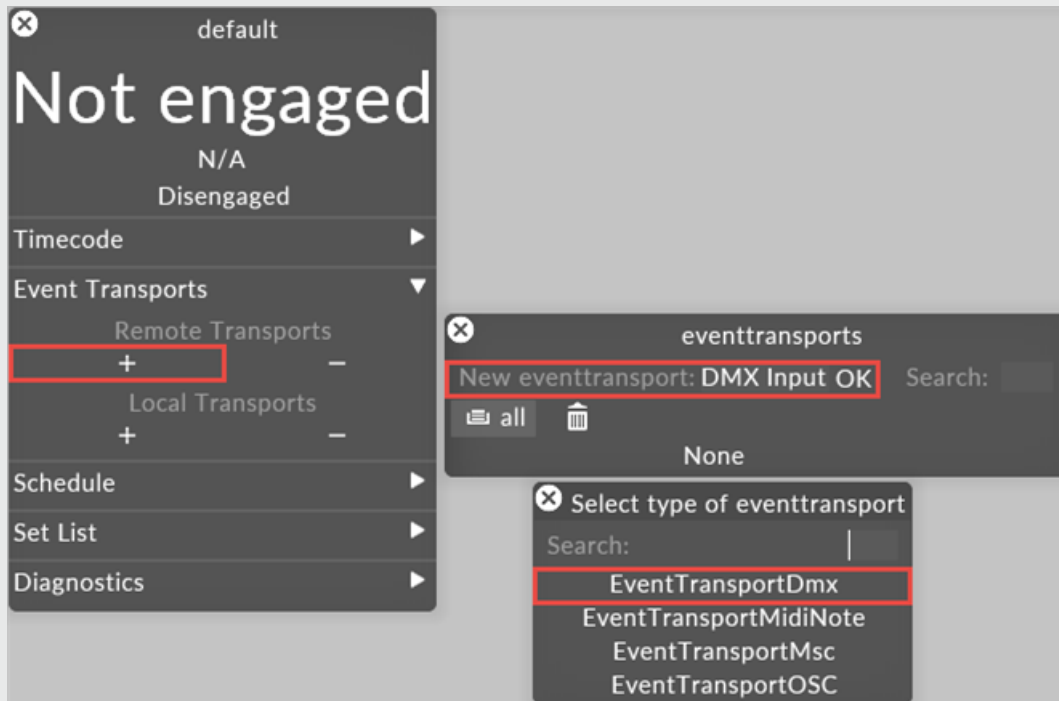

## State Listen/Command operating modes

Before creating a EventTransportDmx object it is important to understand the difference between the **state listen** and **command** operating modes.

The Disguise software offers two operating modes to utilise DMX as a show control protocol:

- State Listen mode
- Command mode



## Universe (1-base)

This is the universe Disguise software will listen on for Art-Net commands.

## Channel (1-base)

This is the channel Disguise software will listen on for Art-Net commands.

## Personality Section

### Command Channel (1-base)

**Command operating mode only.**

This is the channel Disguise software will listen for commands. When the value sent to this channel is within a range defined in the command ranges section, and the trigger channel is set to 255, Disguise will perform that command. For example, to trigger a next section command with the default settings, send a value in the range defined in the next section field, and send the value 255 to the trigger channel.

### Parameter Channel (1-base)

**Command operating mode only.**

The parameter is used when the track select command is issued. It defines which track to select.

### Trigger Channel (1-base)

**Command operating mode only.**

This is the channel Disguise will listen for triggers. A trigger triggers the command the command channel is set to when the value is 255



## Play Mode

This the play mode to be in when jumping to a cue.

## Play Status (1-base)

**State Listen Mode only**

This is the channel Disguise will listen to for play state changes.

## Brightness Channel (1-base)

This is the channel Disguise will listen to for any changes to the master brightness.

## Cue XX Number (1-base)

The value sent to this channel will set the cue xx number for any *go to cue* commands when in command operating mode. In state listen mode, Disguise will automatically jump to the cue when the value sent changes.

## Cue YY Number (1-base)

The value sent to this channel will set the cue yy number for any *go to cue* commands when in command operating mode. In state listen mode, Disguise will automatically jump to the cue when the value sent changes.

## Cue ZZ Number (1-base)

The value sent to this channel will set the cue zz number for any *go to cue* commands when in command operating mode. In state listen mode, Disguise will automatically jump to the cue when the value sent changes..

## Command Ranges Section

Command operating mode only.

This section is where you define the ranges for commands

## State Ranges Section

**State listen operating mode only.**

This section is where you define the ranges for play status channel.

## Behaviour Section

### Cues Are

This option defines where cues are global or local to the current track.

When set to **global (all tracks)**, Disguise will change track if jumping to a cue that is not on the current track. This means that all cue tags need to be unique over multiple.

When set to local (**current track**), Disguise will only jump to cues on the current track. This means cue tags do not need to be unique over multiple tracks.

## State Listen mode

In State Listen mode, Disguise listens to the state of various channels to understand how it should be responding.

State Listen utilises five channels to control the Disguise show and reacts instantly to changes in these channel values. A list of the default channels used in State Listen mode can be seen in the section EventTransportDmx Personality properties above. It allows jumping to cues at any point on any track in your project and allows you to control the play mode in which it should be.

For most purposes the State Listen mode is the most appropriate methodology.

**Please note:** If Disguise software is receiving a play status instruction via DMX, this overrides the GUI play status controls so after receiving the command from the GUI, the DMX instruction will override again. Cueing this parameter to 0 (Idle) will keep the play status and allow for the GUI controls to override.

## Command mode

In Command mode, you build a command utilising two (or more) channels and then use a trigger channel (spiking to 255) to issue the command.

In this mode two actions are required for a command to be executed:

- You construct a command by setting values in various channels
- You issue the command using a trigger channel

**Please note:** When a command has been triggered by spiking the trigger channel to 255, the trigger channel should be returned to 0 before triggering the next command.

The only exception to this is the brightness channel, which constantly matches the channel value.

Now that you understand the difference between the State Listen and Command modes, you can take the first step to controlling the Timeline with Art-Net.

# Switching tracks with DMX

## Switching tracks with DMX

1. Open the Track editor by right-clicking the titlebar of the Track Player.
2. Open the **track-select** section by left-clicking the tab.
3. Enter a value into the **track ID** text field (this value should be programmed into the lighting desk).

**Please note:** in Disguise software the **track ID** should be written in decimal format.

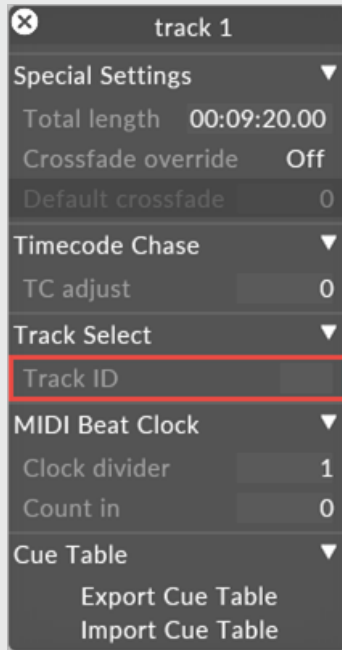

Track ID property of the Track editor is used to assign a note number to the current track, this number can then be programmed into the lighting desk

4. Set the **parameter channel** value within the EventTransportDmx object editor to match the **track ID** value.
5. Set the **command channel** value within the EventTransportDmx object object editor to within 81...90 (default).
6. Execute the trigger (with a value move from 0 to 255).

For more information on the Track editor please see [The track editor page](#).

# Triggering cues with DMX

The format for Art-Net, OSC and MSC cues is `xx.yy.zz`. (e.g. 3.1.1) and is communicated via three channels.

In State Listen mode, Disguise constantly monitors the three cue channels. If a change in any of the three channels is detected, it will attempt to go to the specified cue on the Timeline within Disguise software. These cues can be set at any Timeline point in any track.

## How to create a DMX cue

For this example we are going to use the DMX cue 1.1.3.

1. Right-click on the bar you want to jump to and create a **CUE** tag.
2. Type in the DMX cue number using the CUE tag format ( `xx.yy.zz` )into the **tag** text field.

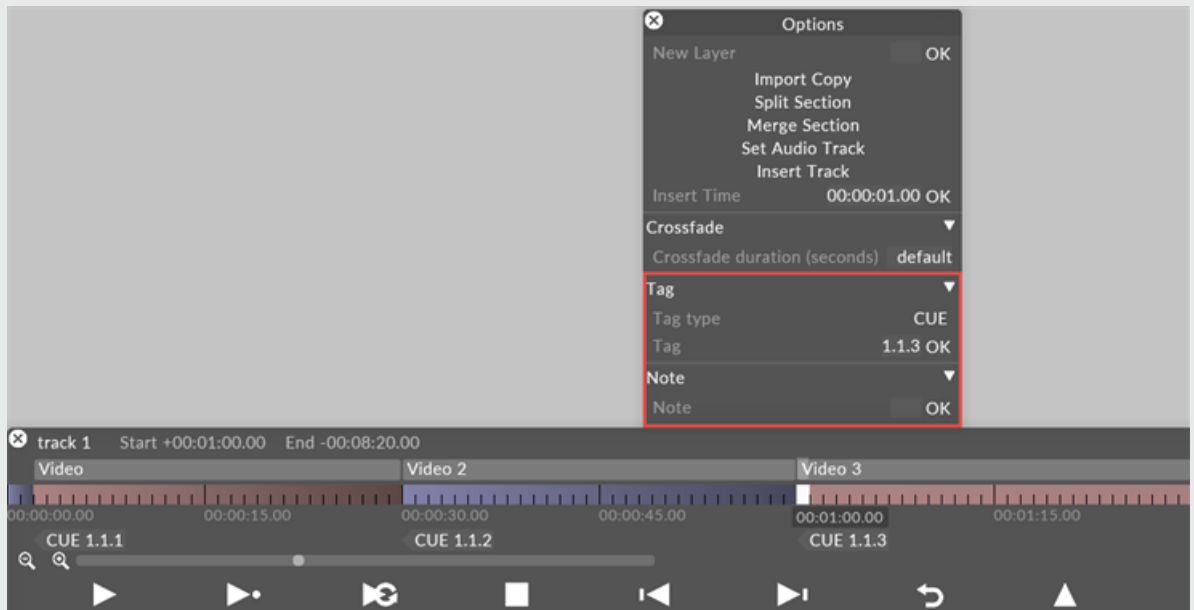

To jump to this cue the DMX channels have be set to:

- Channel 5 = 1
- Channel 6 = 1
- Channel 7 = 3

**Please note:** If Disguise cannot find the specified cue, it will simply ignore the cue and not jump to any point. Cues can be in any position on the Timeline and on any track.

# Sockpuppet overview

## What is Sockpuppet

Sockpuppet fully implements DMX & OSC controls into Disguise software. This feature enables the user to fully control all layers and their parameters from a lighting desk or OSC application. As a result, the operator is no longer restricted to timeline based sequencing, but can now program their project using the lighting desk's cue stack, or a combination of both; by having certain layers controlled from the lighting desk and others controlled from the Timeline. In short, Sockpuppet works by treating all of the layer types as fixture personalities.

## Compatibility

Sockpuppet is fully compatible with any lighting desk capable of outputting Art-Net or sACN, as well as any OSC platform capable of sending OSC control strings.

Additionally, for added usability XML personalities can be exported from Disguise software and imported into any XML compatible console.

### **Known Limitations**

Frame accurate sync across multiple machines cannot be guaranteed. This is because sockpuppet playback responds locally to control packets received on each machine, rather than the director receiving the control data and distributing it synchronously across the machines in the session. This is to guarantee as low latency response as possible.

In setups where a single screen is stitched from outputs across multiple servers, sockpuppet cannot guarantee synchronous playback across the whole surface.

## Network setup - console



First ensure the lighting desk and server are networked together and able to **ping** each other. You will need to assign the IP address and Subnet mask on both the lighting desk's Art-Net port and the server's Art-Net port. These will normally be addressed as shown below:

- server - DMX port - 2.0.0.x - 255.0.0.0
- lighting desk - Art-Net port - 2.0.0.x - 255.0.0.0

**Please note:** Each device needs a unique IP address within the same IP range and subnet

## Network setup - OSC

First ensure the OSC app and server are networked together and able to **ping** each other. You will need to assign the IP address and Subnet mask (ensuring they are both set to the same IP and Subnet range) on the system hosting the OSC application and the server's network port that is receiving the OSC data.

- Set OSC application send IP
- Set OSC application receive IP
- Set the OSC application outgoing port
- Set the OSC application incoming port
- Set Disguise software OSC device send IP
- Set Disguise software OSC device receive IP
- Set the OSC Disguise software outgoing port
- Set the OSC Disguise software incoming port

# Confirm the connection

To check the two devices can communicate with each other, a command line called **ping** should be used.

**Please note:** If using sockpuppet on a Director/Actor system, you will need to give each machine its own Art-Net or OSC connection as each machine needs to receive the data from the control source.

## Setup

Once network connectivity has been confirmed between the server and the lighting desk, the next step is to create a DMX or OSC device in Disguise software.

Read more about DMX setup [here](#).

Read more about OSC devices [here](#).

# Patch assignments

Sockpuppet treats all of Disguise's layer types as fixture personalities. The Patch Assignments window is where we patch or assign our layers on our Timeline to incoming DMX values or channels. For OSC the process is slightly different.

## DMX

### Patching a layer to DMX control

1. Access the patch assignments window by right-click on the d3 icon in the top left corner of the interface.
2. Navigate down to the Sockpuppet tab.
3. Beneath this you will find two fields, the first will be **Patch assignments** and the second **Bank assignments**.
4. Left-click Patch Assignments to open the patch assignments window.

Patch Assignments															
Editor tracking															On
View type															Patch Grid
Viewing universe															1
1	2	3	4	5	6	7	8	9	10	11	12	13	14	15	16
17	18	19	20	21	22	23	24	25	26	27	28	29	30	31	32
33	34	35	36	37	38	39	40	41	42	43	44	45	46	47	48
49	50	51	52	53	54	55	56	57	58	59	60	61	62	63	64
65	66	67	68	69	70	71	72	73	74	75	76	77	78	79	80
81	82	83	84	85	86	87	88	89	90	91	92	93	94	95	96
97	98	99	100	101	102	103	104	105	106	107	108	109	110	111	112
113	114	115	116	117	118	119	120	121	122	123	124	125	126	127	128
129	130	131	132	133	134	135	136	137	138	139	140	141	142	143	144
145	146	147	148	149	150	151	152	153	154	155	156	157	158	159	160
161	162	163	164	165	166	167	168	169	170	171	172	173	174	175	176
177	178	179	180	181	182	183	184	185	186	187	188	189	190	191	192
193	194	195	196	197	198	199	200	201	202	203	204	205	206	207	208
209	210	211	212	213	214	215	216	217	218	219	220	221	222	223	224
225	226	227	228	229	230	231	232	233	234	235	236	237	238	239	240
241	242	243	244	245	246	247	248	249	250	251	252	253	254	255	256
257	258	259	260	261	262	263	264	265	266	267	268	269	270	271	272
273	274	275	276	277	278	279	280	281	282	283	284	285	286	287	288
289	290	291	292	293	294	295	296	297	298	299	300	301	302	303	304
305	306	307	308	309	310	311	312	313	314	315	316	317	318	319	320
321	322	323	324	325	326	327	328	329	330	331	332	333	334	335	336
337	338	339	340	341	342	343	344	345	346	347	348	349	350	351	352
353	354	355	356	357	358	359	360	361	362	363	364	365	366	367	368
369	370	371	372	373	374	375	376	377	378	379	380	381	382	383	384
385	386	387	388	389	390	391	392	393	394	395	396	397	398	399	400
401	402	403	404	405	406	407	408	409	410	411	412	413	414	415	416

# View Types

Left click on the view type field to open the list of available view options.

## Patch grid

Displays all 512 channels in a grid format. You are able to patch to any free channels here or view which channels you have already populated with a patch. Left-click on Patch Grid to view different options to change the layout of the patch window.

Please note: this is the view type you will need to be in to patch your layers.

## Patch list

This shows us a list of all of the current layers patched and their start channels within any selected universe (selectable from the Viewing Universe field).

## Global patch list

This follows the same format as the Patch List, however this will show us a full list of all layers patched regardless of which universe they start on.

## Universe occupancy

This will show us in grid format which of our universes we currently have layers patched to (a blue square over any universe indicates we have layers patched).

# Patching layers

To patch layers within Disguise software ensure:

- The Patch Assignments window is open & in the patch grid view type.
- The layer you want to patch is added to the Timeline. Click [here](#) for more information on working with layers.
- Hover the cursor over the DMX channel you want to patch to in the Patch Assignments window.

- Select the DMX channel while holding down **ALT** to generate a white arrow, which should be dragged down to the layer on the Timeline that you want to patch to.

**Patch Assignments**

Editor tracking On

View type Patch Grid

Viewing universe 1

1	2	3	4	5	6	7	8	9	10	11	12	13	14	15	16
17	18	19	20	21	22	23	24	25	26	27	28	29	30	31	32
33	34	35	36	37	38	39	40	41	42	43	44	45	46	47	48
49	50	51	52	53	54	55	56	57	58	59	60	61	62	63	64
65	66	67	68	69	70	71	72	73	74	75	76	77	78	79	80
81	82	83	84	85	86	87	88	89	90	91	92	93	94	95	96
97	98	99	100	101	102	103	104	105	106	107	108	109	110	111	112
113	114	115	116	117	118	119	120	121	122	123	124	125	126	127	128
129	130	131	132	133	134	135	136	137	138	139	140	141	142	143	144
145	146	147	148	149	150	151	152	153	154	155	156	157	158	159	160
161	162	163	164	165	166	167	168	169	170	171	172	173	174	175	176
177	178	179	180	181	182	183	184	185	186	187	188	189	190	191	192
193	194	195	196	197	198	199	200	201	202	203	204	205	206	207	208
209	210	211	212	213	214	215	216	217	218	219	220	221	222	223	224
225	226	227	228	229	230	231	232	233	234	235	236	237	238	239	240
241	242	243	244	245	246	247	248	249	250	251	252	253	254	255	256
257	258	259	260	261	262	263	264	265	266	267	268	269	270	271	272
273	274	275	276	277	278	279	280	281	282	283	284	285	286	287	288
289	290	291	292	293	294	295	296	297	298	299	300	301	302	303	304
305	306	307	308	309	310	311	312	313	314	315	316	317	318	319	320
321	322	323	324	325	326	327	328	329	330	331	332	333	334	335	336
337	338	339	340	341	342	343	344	345	346	347	348	349	350	351	352
353	354	355	356	357	358	359	360	361	362	363	364	365	366	367	368
369	370	371	372	373	374	375	376	377	378	379	380	381	382	383	384
385	386	387	388	389	390	391	392	393	394	395	396	397	398	399	400
401	402	403	404	405	406	407	408	409	410	411	412	413	414	415	416

track 1 Start +00:00:00.00 End -00:09:20.00

Video

00:00:00.00 00:00:15.00 00:00:30.00 00:00:45.00

⏪ ⏩ ⏮ ⏭ ⏸ ⏪

This will create a green block over the channels in our patch grid that the layer will take up, and also turn the layer on the timeline green to signify the layer is patched and only controllable through Sockpuppet DMX.

We will also be presented with some key information regarding our patch. This will include the start address, a user specified name (this will be "untitled" by default) the layer type, and the personality version.



**Patch Assignments**

Editor tracking On

View type Patch Grid

Viewing universe 1

**1:1 Video (VideoModule v16)**

82	83	84	85	86	87	88	89	90	91	92	93	94	95	96	
97	98	99	100	101	102	103	104	105	106	107	108	109	110	111	112
113	114	115	116	117	118	119	120	121	122	123	124	125	126	127	128
129	130	131	132	133	134	135	136	137	138	139	140	141	142	143	144
145	146	147	148	149	150	151	152	153	154	155	156	157	158	159	160
161	162	163	164	165	166	167	168	169	170	171	172	173	174	175	176
177	178	179	180	181	182	183	184	185	186	187	188	189	190	191	192
193	194	195	196	197	198	199	200	201	202	203	204	205	206	207	208
209	210	211	212	213	214	215	216	217	218	219	220	221	222	223	224
225	226	227	228	229	230	231	232	233	234	235	236	237	238	239	240
241	242	243	244	245	246	247	248	249	250	251	252	253	254	255	256
257	258	259	260	261	262	263	264	265	266	267	268	269	270	271	272
273	274	275	276	277	278	279	280	281	282	283	284	285	286	287	288
289	290	291	292	293	294	295	296	297	298	299	300	301	302	303	304
305	306	307	308	309	310	311	312	313	314	315	316	317	318	319	320
321	322	323	324	325	326	327	328	329	330	331	332	333	334	335	336
337	338	339	340	341	342	343	344	345	346	347	348	349	350	351	352
353	354	355	356	357	358	359	360	361	362	363	364	365	366	367	368
369	370	371	372	373	374	375	376	377	378	379	380	381	382	383	384
385	386	387	388	389	390	391	392	393	394	395	396	397	398	399	400
401	402	403	404	405	406	407	408	409	410	411	412	413	414	415	416

track 1 Start +00:00:00.00 End -00:09:20.00

Video

00:00:00.00 00:00:15.00 00:00:30.00 00:00:45.00

⏪ ⏩ ⏮ ⏭ ⏸ ⏪

**Please note:** Any previous keyframing / sequencing done on the layer will be overwritten and deleted by the default values sent from the desk once the layer is patched.

## Patch settings

To access this patch settings menu, right click on the green patch block, this will open the patch settings.

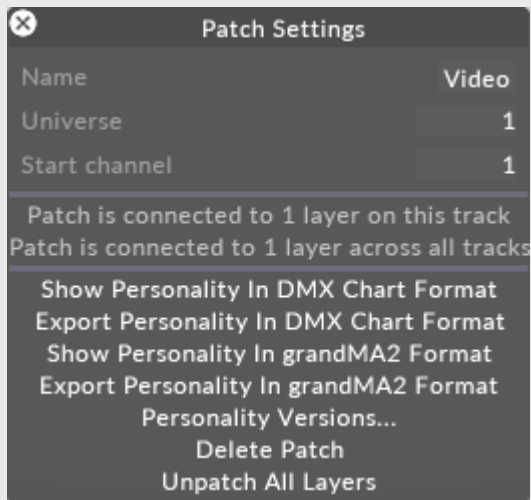

### Name

Here we can give the layer a user friendly name, this might be particularly useful if we have a high number of video layers patched for example, and want to easily distinguish which ones are which.

### Universe

Here we can specify the universe we want to patch our layer to.

### Start channel

Here we can specify the start channel we want to patch our layer to.

## Patch info

Here we are presented with some basic information as to where and how many layers our patch assignment is connected to.

## Show Personality

By left clicking this, we are presented with a window displaying the layers personality. This is a table highlighting which incoming DMX channel is assigned to what function or parameter within the layer, in addition to this we are shown the default values of channels, their ranges, and the title displaying the layer type and its total footprint size.

## Show Personality XML

Left clicking Show personality XML will do two things. The first will present the user with a window showing the video layer personality in XML form. The second action performed will be to create a new folder in the d3 projects folder, this will be named "output". (see the below file directory)

**Computer > Media (E:) > d3 Projects > Project Name > output**

This folder will be populated with an XML file containing the Personality data for the selected layer. This can then be transferred via USB stick onto your XML compatible lighting console.

**Please note:** You will need to follow this process for each layer type patched. A new XML document will be created within this output folder, for each new layer type that the user opens the show personality XML function on.

## Personality Versions

Here we will find an archive of the previous personality versions used in our project. A personality profile may be updated / changed with a new release of Disguise software, this function will allow you to roll back to the personality version that you originally programmed your show with, meaning you will not have to update any of the programming on your console.

# Delete Patch

By left clicking on delete patch we will remove the selected layer from our patch assignment. This will return it to its standard operating mode (controlled through the timeline & keyframable)

## OSC

### Patching a layer to OSC control

1. Right click a layer on the timeline
2. Left click **Patch to OSC**

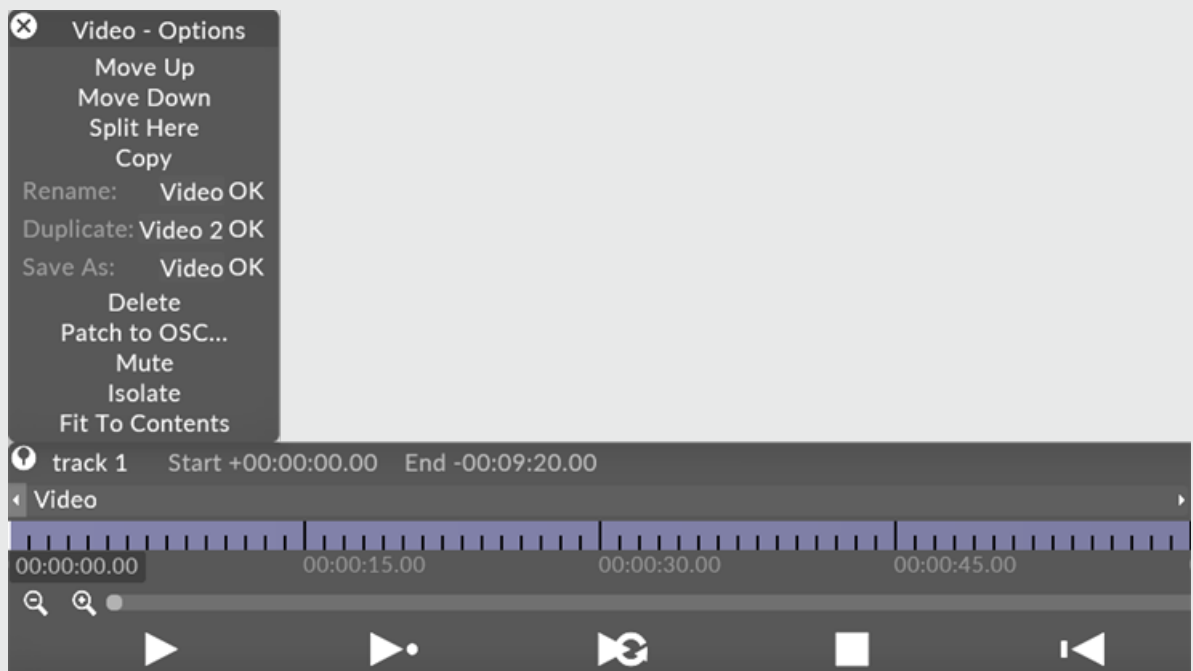

3. Choose OSC device

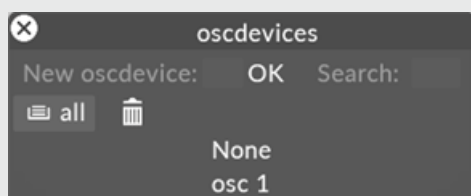

The layer will now turn green, indicating that it is controlled by an external sockpuppet system.

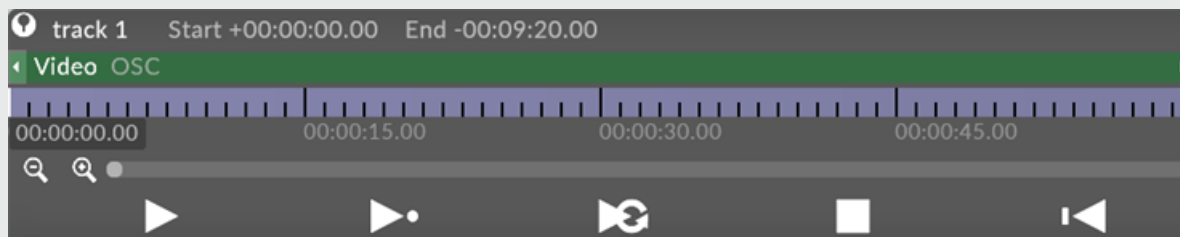

# View the personality

1. To view the personality of the layer for OSC, right click the layer and choose **Edit OSC patch**.

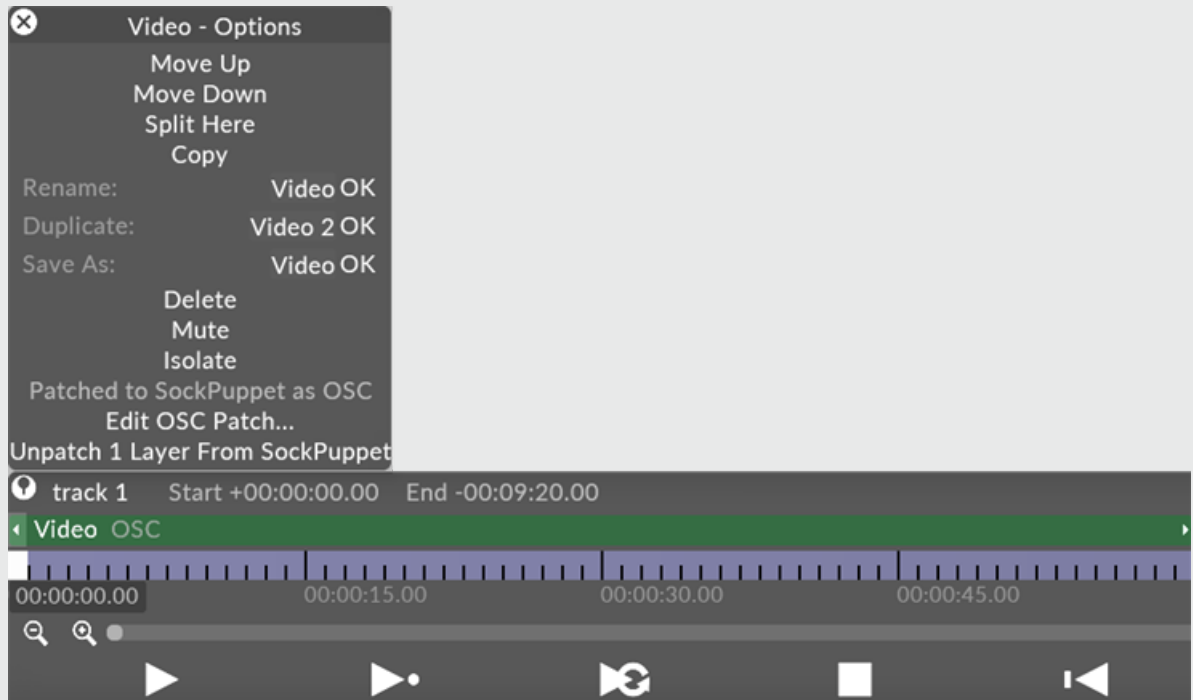

2. Left click **View personality**

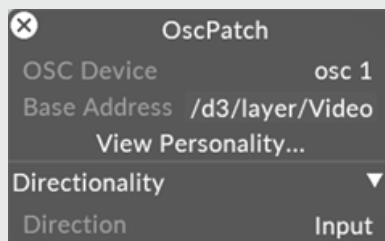

The default OSC personality opens.



## Export the personality

1. Repeat the previous steps to view the OSC patch.
2. Once the patch is open, left click the Export button at the bottom of the window.

# Bank Editor

Please note: it is important to note for best results have the console set up to work in decimal rather than percent.

## What is the bank editor?

The bank editor enables us to assign DMX values to the various resources needed within a layer, examples of such resource parameters include, video or bitmap files, mapping types or HTML bookmarks. This process is managed on a bank and slot basis.

## Banks & slots

Within the layer personality, sockpuppet will assign two channels to each resource parameter, the first of these channels will be for the resource bank, and the second will be for the resource slot. For example within the video layer personality, channel 8 is for the video bank & channel 9 is for the video slot.

Example: If we had a video asset assigned to video slot 5 in video bank 3, we would need to output the following from the lighting console to recall it.

**channel 8 @3, channel 9 @5.**

This means that we can have a maximum of 255 video banks and within each of those we can have 255 video slots, giving us a total of 65025 assignable video slots (255\*255) for each resource type.



# Main Interface elements

To open the Bank editor right click on the state menu (top left) and underneath the sockpuppet tab left click "bank".

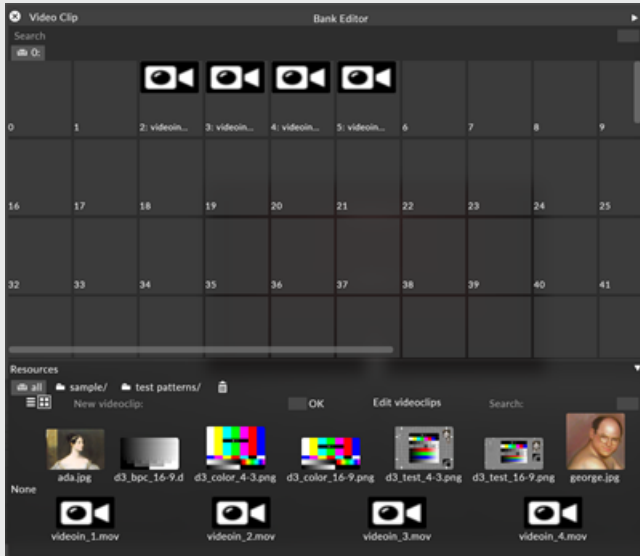

At the top of the window we have the currently selected resource type, in this case, video clip. Left click Video Clip to open a menu for other resource types. You can populate the resource bank with resources by dragging them from the resources view in the bottom of the window, to empty bank slots.



# Preferences

The bank editor preferences can be opened by left clicking the small white triangle in the top right corner of the window.

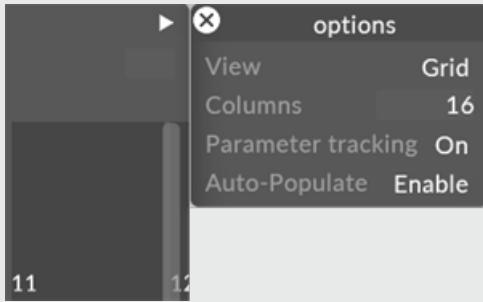

## View type

Here we can select the way in which we want to view the bank editor. Grid will display the slot window in a grid format and List will display the slot window as a list.

## Columns

Specifies the number of columns displayed by default.

## Parameter tracking

By left clicking on this field and setting it to "on" we will have a visual representation of which slot we currently have selected; so as the console programmer scrolls through the slots and banks on the encoders, a red square will be drawn over the slot we currently have selected.

## Auto-populate

When disabled, it stops assets being added automatically based on their file name.

## Search function

This enables you to search through the assets already assigned to a slot, and will highlight them with a light blue square if they match the search criteria.

## Working with banks

The banks are all configured and managed in the tabs bar above the slot layout. By default we will have bank 0 already created. In order to open the bank options window right click on an existing bank or on bank 0.

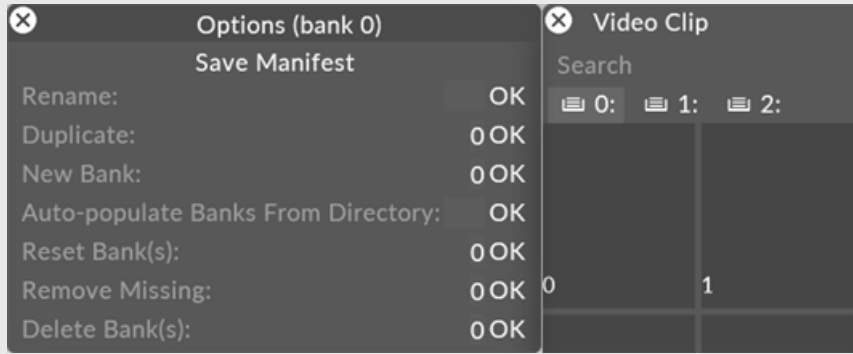

## Rename

Here we can specify a custom name for our bank, type it into the field and click **ok** or press the return key.

## Duplicate

Here we can copy the contents of our selected bank into another, specify the destination bank number in the field and click **ok** or press the return key.

## New bank

Here we can create a new bank. to do this enter the number for your new bank and click **ok** or press the return key.

## Auto-populate banks from directory

Please see below, "under adding assets to slots"

## Reset bank

This will return the bank to its default state, and empty any populated slots.

## Remove missing

Allows you to remove missing media from a selected bank.

## Delete bank

By left clicking here, we will completely delete the bank from our bank editor.

## Adding assets to slots

### Manually add assets to slots

To manually add an asset to a slot, simply select the resource type you wish to assign, such as textures, left click on the thumbnail in the library and drag and drop it over the slot you wish to assign it to. repeat this process for all of your content. If you have your content organised into files and boxes ([click here to read about organising your content](#)) then you can quickly populate your slots with whole boxes at a time. To do this simply hold down **Alt** on the keyboard and left click over the box you wish to use, this will turn our cursor into a white arrow which we can drag from our box to the first slot we wish to use, release and it will populate the slots with the contents of that box.

### Using auto-populate to add assets to slots

Another widely used method of assigning DMX values to assets, is adding numerical values to folders and files within your assets library. The Disguise software also supports this workflow and is managed via the auto-populate field in the bank options (see above for how to access).

#### **Auto-populate file structure:**

Each of the content folders located within the objects/videofile folder needs to be labelled numerically, for example: **001\_Foldername**

Files within this folder should follow this same numeric labelling scheme: **001\_filename**

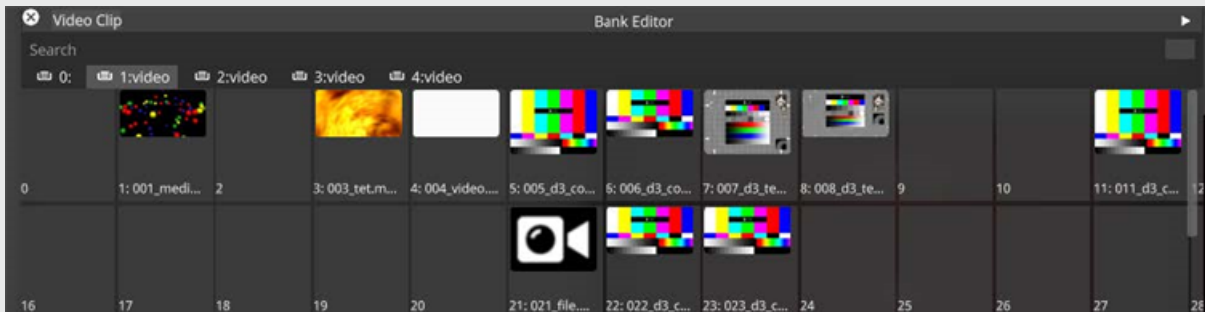
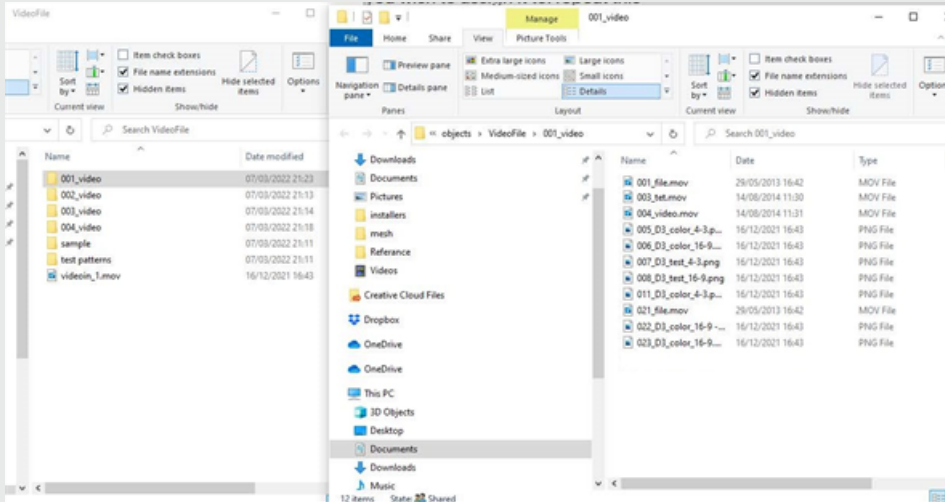

Auto-populated results within the Bank Editor

## Creating a directory

When using this method to populate your banks and slots, you will need to start by numbering your folders and files within the project directory in Windows.

Navigate to the resource folder you wish to use (we will be using DxTexture as an example) and number your folders within the DxTexture folder, these will become your bank numbers. Within each of these folders you will need to number your asset files, these will become your slot numbers.

## Clearing assets from slots

In order to clear a slot we will need to overwrite it with the "none" thumbnail from our resource library. To do this simply left click on the none thumbnail and drag it over a populated slot. We could also use the reset bank option to clear out the whole bank.

## Banks with OSC

As of r17.3, banks can also be used with OSC sockpuppet.

- The path is always the same: `/d3/layer/Typeoflayer/Nameoflayer` - Example:  
`/d3/layer/Video/video`
- It's always one message (One address/path + one or two integers)
- Option one: One path and one integer with bank and slot encoded into one number (e.g, bank 1 slot 1 is  **$256+1=257$** ).
- The formula for a single int is  **$\text{bank} * 255 + \text{slot}$**  (eg. bank 0 slot 1 is  $0 * 255 + 1$ )
- Option two: One path and two integers with bank in the first integer and slot in the second integer.

# Sockpuppet personality editor

The **Sockpuppet** personality editor is a feature of Disguise software that allows users to edit the default personality of a patched layer.

It's important to note that currently, the functionality is limited to patched layers and you cannot store a custom personality for use with other layers of the same type.

The functionality is useful for setting 16-bit control of some control channels, as well as removing parameters from the personality.

## Accessing & using the personality editor

1. Patch a layer as specified in the [patch assignments topic](#).
2. Right click the patched layer in the patch assignments widget.

Patch Assignments	
Showing	Universe
1:1 Video (VideoModule r17.0)	1
8	9
10	11
12	13
14	15
16	
17	18
19	20
21	22
23	24
25	26
27	28
29	30
31	32
33	34
35	36
37	38
39	40
41	42
43	44
45	46
47	48
49	50
51	52
53	54
55	56
57	58
59	60
61	62
63	64
65	66
67	68
69	70
71	72
73	74
75	76
77	78
79	80
81	82
83	84
85	86
87	88
89	90
91	92
93	94
95	96
97	98
99	100
101	102
103	104
105	106
107	108
109	110
111	112
113	114
115	116
117	118
119	120
121	122
123	124
125	126
127	128
129	130
131	132
133	134
135	136
137	138
139	140
141	142
143	144
145	146
147	148
149	150
151	152
153	154
155	156
157	158
159	160
161	162
163	164
165	166
167	168
169	170
171	172
173	174
175	176
177	178
179	180
181	182
183	184
185	186
187	188
189	190
191	192
193	194
195	196
197	198
199	200
201	202
203	204
205	206
207	208
209	210
211	212
213	214
215	216
217	218
219	220
221	222
223	224
225	226
227	228
229	230
231	232
233	234
235	236
237	238
239	240
241	242
243	244
245	246
247	248
249	250
251	252
253	254
255	256

- In the DMX Patch Settings widget, right click the **DmxPersonality** object.

**DMX Patch Settings**

Name Video

Channel 1

Universe 1

Personality DmxPersonality

---

Patch is connected to 1 layer on this track

Patch is connected to 1 layer across all tracks

---

Personality Versions...

Delete Patch

Unpatch All Layers



The personality editor will open. You can now edit values in the editor which will be stored to the personality in use for that layer.

✕
DmxPersonality
r17.0

Variant name
Channels
81

Channel	Offset	Type	Field	Display Name	Group Name	Minimum	Maximum	Default Value
0		options	blendMode	blendMode	Default	0	18	1
1		8-bit	brightness	brightness	Default	0	1	1
2		bank/slot	mapping	mapping	Default	0	255	0
4		RGB-colour	RGB colour	RGB colour	Default	0	1	255
7		bank/slot	video	video	Media	0	255	0
9		16-bit	speed	speed	Media	-4	4	1
11		options	mode	mode	Media	0	9	1
12		options	at end point	at end point	Media	0	2	0
13		16-bit	loop inFrame	loop inFrame	Media	0	65535	0
15		16-bit	transition time	transition time	Media	0	10	0
17		8-bit	volume	volume	Audio	0	1	1
18		bank/slot	Output	Output	Audio	0	255	0
20		16-bit	brightness (shift)	brightness (shift)	ColourShift	-1	1	0
22		16-bit	contrast (scale)	contrast (scale)	ColourShift	0	2	1
24		16-bit	saturation scale	saturation scale	ColourShift	0	4	1
26		16-bit	hue shift	hue shift	ColourShift	-360	360	0
28		options	RGB controlled	RGB controlled	ColourShift	0	1	1
29		8-bit	red min	red min	ColourShift	0	1	0
30		8-bit	red max	red max	ColourShift	0	1	1
31		16-bit	red gamma	red gamma	ColourShift	0.1	4	1
33		8-bit	green min	green min	ColourShift	0	1	0
34		8-bit	green max	green max	ColourShift	0	1	1
35		16-bit	green gamma	green gamma	ColourShift	0.1	4	1
37		8-bit	blue min	blue min	ColourShift	0	1	0
38		8-bit	blue max	blue max	ColourShift	0	1	1
39		16-bit	blue gamma	blue gamma	ColourShift	0.1	4	1
41		8-bit	key colour.r	key colour.r	ColourShift	0	1	0
42		8-bit	key colour.g	key colour.g	ColourShift	0	1	0
43		8-bit	key colour.b	key colour.b	ColourShift	0	1	0
44		options	clip_type	clip_type	Move	0	4	4
45		16-bit	size	size	Move	0	4	1
47		16-bit	scale.x	scale.x	Move	0	4	1
49		16-bit	scale.y	scale.y	Move	0	4	1
51		16-bit	pos.x	pos.x	Move	-1	1	0
53		16-bit	pos.y	pos.y	Move	-1	1	0
55		16-bit	rotation	rotation	Move	-180	180	0
57		16-bit	left	left	Crop	0	1	0
59		16-bit	right	right	Crop	0	1	0
61		16-bit	top	top	Crop	0	1	0
63		16-bit	bottom	bottom	Crop	0	1	0
65		options	on clock lost	on clock lost	Timecode	0	2	0
66		8-bit	hours	hours	Timecode	0	255	0
67		8-bit	minutes	minutes	Timecode	0	255	0
68		8-bit	seconds	seconds	Timecode	0	255	0
69		8-bit	frames	frames	Timecode	0	255	0
70		8-bit	threshold	threshold	ColourShift	0	1	0
71		16-bit	hardness	hardness	ColourShift	0	1	1
73		16-bit	cropSoftness	cropSoftness	Crop	0	1	0
75		16-bit	frame index	frame index	Media	0	65535	0
77		16-bit	trim frames	trim frames	Media	0	65535	0
79		16-bit	loop outFrame	loop outFrame	Media	0	65535	0

Actions

- Show Personality In DMX Chart Format
- Export Personality In DMX Chart Format
- Show Personality In grandMA2 Format
- Export Personality In grandMA2 Format

Use the actions tab to show or export the personality in either text or grandMA2 format.

4. Editing and creating a custom DMX personality:

#### **Removing channels**

Channels can be removed from a personality as well to create a custom DMX profile. Right-click on the empty space between a column in the DMXPersonality editor and select Remove Properties.

**DmxPersonality**

Variant name: r17.4.12

Channels: 81

**Settings**

Channel Offset	Type	Field	Display Name	Group Name	Minimum	Maximum	Default Value
18	bank/slot	Output	Output	Audio	0	255	0
20	16-bit	brightness (shift)	brightness (shift)	ColourShift	-1	1	0
22	16-bit	contrast (scale)	contrast (scale)	ColourShift	0	2	1
24	16-bit	saturation scale	saturation scale	ColourShift	0	4	1
26	16-bit	hue shift	hue shift	ColourShift	-360	360	0
28	options	RGB controlled	RGB controlled	ColourShift	0	1	1
29	8-bit	red min	red min	ColourShift	0	1	0
30	8-bit	red max	red max	ColourShift	0	1	1
31	16-bit	red gamma	red gamma	ColourShift	0.1	4	1
33	8-bit	green min	green min	ColourShift	0	1	0
34	8-bit	green max	green max	ColourShift	0	1	1
35	16-bit	green gamma	green gamma	ColourShift	0.1	4	1
37	8-bit	blue min	blue min	ColourShift	0	1	0
38	8-bit	blue max	blue max	ColourShift	0	1	1
39	16-bit	blue gamma	blue gamma	ColourShift	0.1	4	1
41	8-bit	key colour.r	key colour.r	ColourShift	0	1	0
42	8-bit	key colour.g	key colour.g	ColourShift	0	1	0
43	8-bit	key colour.b	key colour.b	ColourShift	0	1	0
44	options	clip_type	clip_type	Move	0	4	4
45	16-bit	size	size	Move	0	4	1
47	16-bit	scale.x	scale.x	Move	0	4	1
49	16-bit	scale.y	scale.y	Move	0	4	1
51	16-bit	pos.x	pos.x	Move	-1	1	0
53	16-bit	pos.y	pos.y	Move	-1	1	0
55	16-bit	rotation	rotation	Move	-180	180	0
57	16-bit	left	left	Crop	0	1	0
59	16-bit	right	right	Crop	0	1	0
61	16-bit	top	top	Crop	0	1	0
63	16-bit	bottom	bottom	Crop	0	1	0
65	options	on clock lost	on clock lost	Timecode	0	2	0
66	8-bit	hours	hours	Timecode	0	255	0
67	8-bit	minutes	minutes	Timecode	0	255	0
68	8-bit	seconds	seconds	Timecode	0	255	0
69	8-bit	frames	frames	Timecode	0	255	0
70	8-bit	threshold	threshold	ColourShift	0	1	0
71	16-bit	hardness	hardness	ColourShift	0	1	1
73	16-bit	cropSoftness	cropSoftness	Crop	0	1	0
75	16-bit	frame index	frame index	Media	0	65535	0
77	16-bit	trim frames	trim frames	Media	0	65535	0
79	16-bit	loop outFrame	loop outFrame	Media	0	65535	0

**Actions**

- Options For loop outFrame
  - Remove Properties
  - Show Personality In DMX Chart Format
  - Export Personality In DMX Chart Format
  - Show Personality In grandMA2 Format
  - Export Personality In grandMA2 Format

### **Creating a custom DMX personality**

The Channel Offset, Display Name, Group Name, and Min/Max/Default Values can also be customized in this editor and exported.

# Sequencing with Sockpuppet

There are a number of changes to the way in which layers are programmed or sequenced when running in sockpuppet mode. The following section will outline these differences.

## Dormant layers

### Overview

Dormant layers is a feature to enable the stacking of large numbers of layers on the timeline. The issue with this previously was that each layer on the timeline required a certain amount of system resources in order to run, which would quickly add up when working with large numbers and result in a significant drop in performance. Now when a layer is set to be dormant it will not require any system resources, and therefore mean we can have large stacks of layers on our timeline and not have to worry about performance issues.

## Setting a layer to be dormant

To make a layer dormant simply set the brightness to 0. This will change the colour of the layer to a dark grey to signify the layer is now dormant. Raise the value above zero to make the layer active.

## RGB colour overview

When running in sockpuppet mode the colour palette system with its X and Y values are ignored and instead replaced by a RGB colour system. This is to reflect the typical way of working with colour on a lighting console.

**Please note:** there is a know issue whereby the RGB colour control system will not be reflected in the layer editor within Disguise software, this will be fixed in a later release.

## Video playback modes overview

When running a layer in sockpuppet mode there are a number of behaviour changes and additions to the video play modes. The functions are listed below:

### Normal

Play forward

---

## Locked

Play forward: no difference from Normal

## Reset

Reset to the first frame in the clip and hold

## Pause

Pause at the current frame

## Inframe

Go to a specific frame

## Outframe

Set a specific outframe

## Reverse

Play clip backwards

## Timecode

Playback will chase timecode

## LoopInFrame

Set a specific inframe for a video clip loop

## LoopOutFrame

Set a specific outframe for a video clip loop

## Toggle Sockpuppet

The toggle sockpuppet feature allows us to remove the sockpuppet functionality on any parameter within a patched layer.

If for example, we have a Bitmap layer patched and we want to have DMX control over everything apart from the brightness parameter, which we want to keyframe. We can now right click on the parameter we want to toggle, and click "toggle sockpuppet" this will now take my parameter out of the sockpuppet mode.

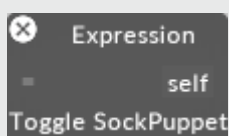

# EVO

## Overview

Disguise is a workflow platform, designed to be flexible and enable you to interoperate multiple functions within the platform to create your own workflows. One example of this is a collection of workflows known as EVO.

EVO (External Visualiser Overlay) is in essence two parts. An incoming video stream (NDI) from a third party visualiser, and sharing of camera coordinates between the disguise camera and the external visualiser's camera.

By combining these two workflows, you are able to create a seamless link between the two systems - essentially visualising the lighting and video systems together in one view port.

In this example, we will focus on GrandMA 3D, but other visualisers can be implemented in a similar way.

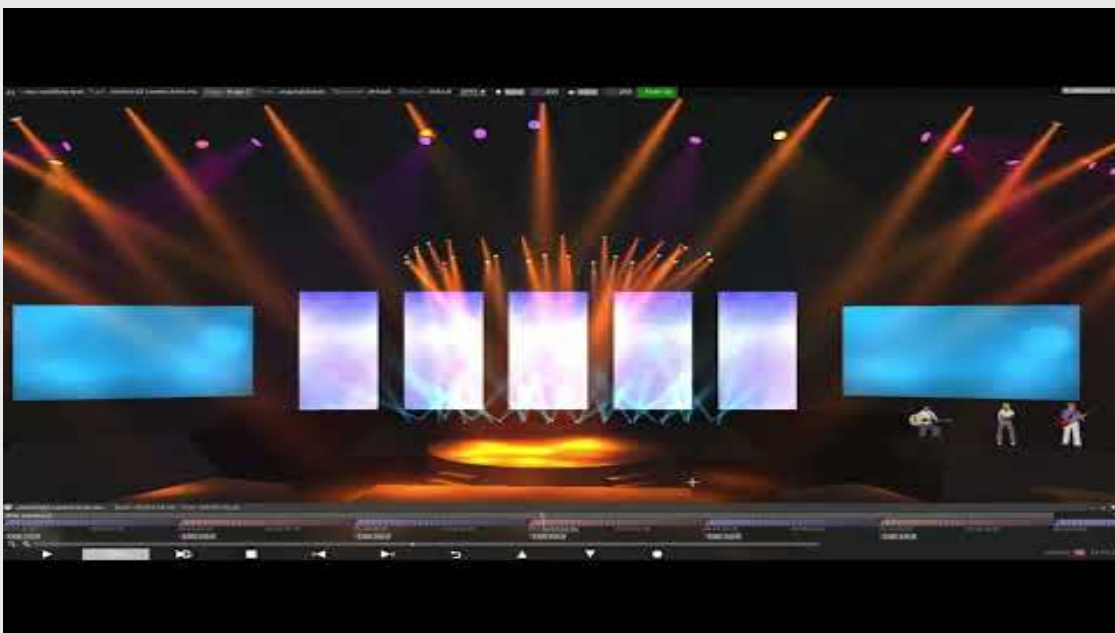



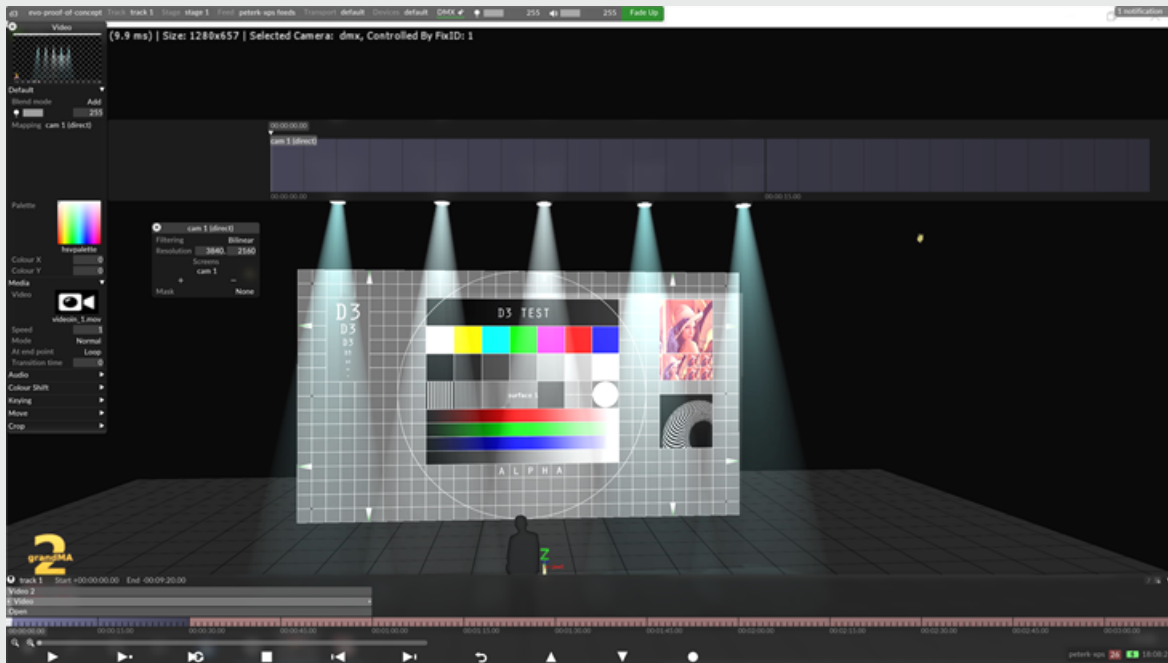

## Setup

### NDI Video Streams

To set up the NDI stream:

1. Start the NDI Scan Converter on the visualiser PC
2. In the third party visualiser, set all video surfaces & props to render as black. It might be helpful to use the Export Stage to FBX option in Disguise software to export the stage directly into the visualiser, to ensure all objects are scaled identically
3. Start Disguise software project
4. In Disguise software, create a new camera and position it as required. This will become your main visualiser camera, so you may also need to increase the resolution if you are running a 4K

GUI (the new camera will default to 1920 x 1080)

5. In Disguise, select the visualiser camera to be that new camera in the Stage menu
6. In the Video Input Patch, map one of the Video Inputs to the incoming NDI stream from the visualiser PC. Check with the preview function that this is routing correctly.
7. Add a new Video layer to the timeline
8. In the Video layer, select the Video In clip as the media asset
9. Set the video layer to **Add** blend mode
10. Create a new Direct mapping and add the new camera you created to that mapping
11. Select the new mapping as the mapping for the video layer

**Video**

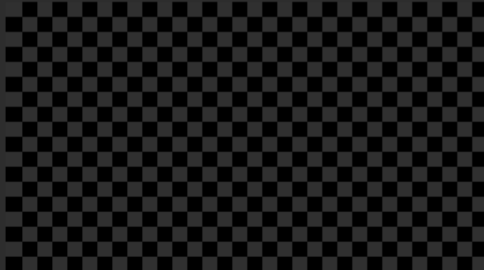

Default ▾

Blend mode  255

Mapping **gui camera (direct)**

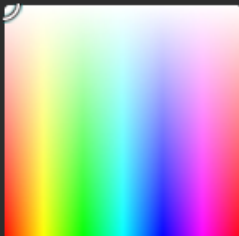
Palette   
hsvpalette

Colour X

Colour Y

Media ▾

Video   
videoin\_1.mov

Speed

Mode **Normal**

At end point **Loop**

Transition time

Audio ▶

Colour Shift ▶

Keying ▶

Move ▶

Crop ▶

**gui camera (direct)**

Filtering **Bilinear**

Resolution

Screens **cam 1**

**+** **-**

Mask

At this point the incoming NDI stream from the external visualiser will be overlaid from the disguise visualiser. If you manually line up the two cameras, this is all that is needed - but using the tracking and control modules in Disguise software it's possible to link the two cameras together, via open protocols (DMX).

## Camera Positions

To set up the camera position - there are two options - either disguise can receive the camera position from the visualiser, or the visualiser can receive the position from disguise.

## Visualiser receiving position from disguise - via DMX

1. Add a DMX device to the project, and patch it to Output DMX
2. Create a DMX lights screen and assign it to create an appropriate number of DMX addresses
3. Add an DMXLightsControl layer to the timeline
4. Select the DMX lights screen as the mapping for the DMXLightsControl layer
5. Use an arrow to connect the control layer to the stage camera (the expression syntax created is **camera:{camera name}.offset.x**)

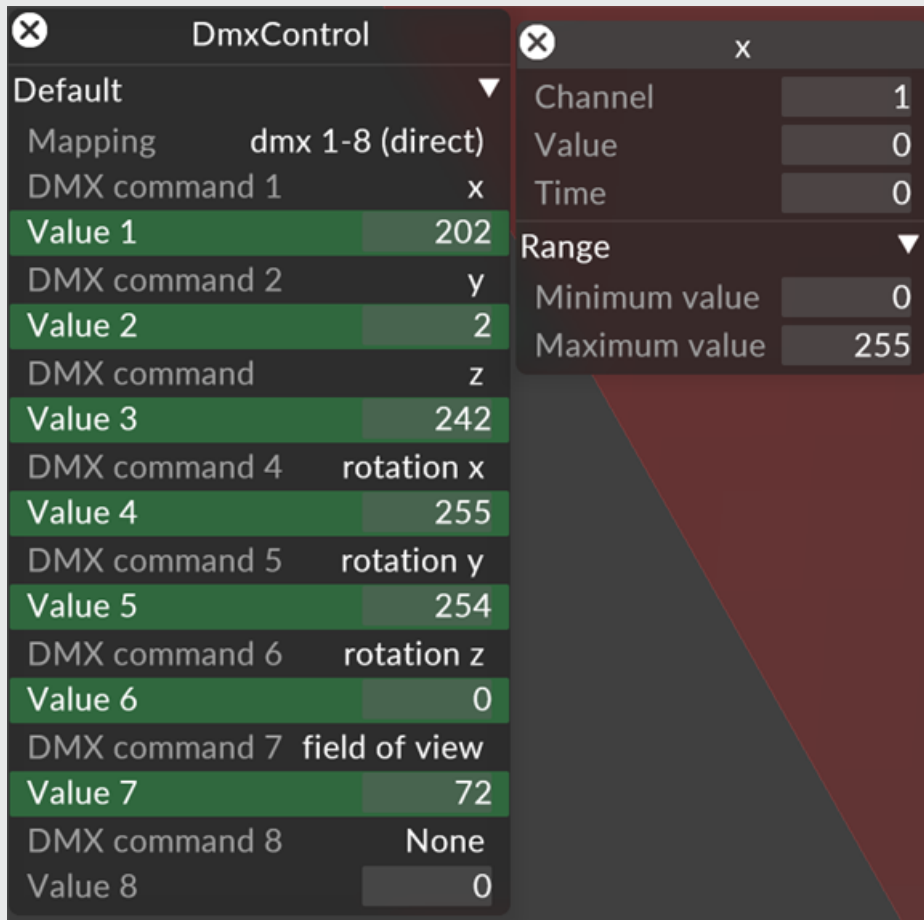

6. Set up the appropriate commands to send from Disguise software to the visualiser - note that the DMX LightsControl layer sends only 8 bit values so you will need to convert these to 16 bit or 24 bit depending on the external visualiser requirements. See below.
7. Apply any scale factors needed in the expression to center the two worlds  
Note - you will need multiple DMXcontrol modules to send all the properties of the camera)
8. Patch the external visualiser according to the data stream you created

**Please note:** World Offsets - It might be helpful to set up Disguise software camera as a CHILD of a null object (prop). This means that you can set the world offset using the position and rotation properties of the null object, rather than modifying the expressions (above). Create the prop, then use Add Child to select the camera as a child of the prop. When the position of the prop is adjusted, the camera will move by the same relative value. No mesh needs to be selected on the prop.

## Open Layer workflow

1. Add a DMX device to the project file, and patch it to Input DMX
2. Add an Open layer to the timeline
3. Hold down Alt and drag an arrow between the Open Layer and the Cameras position and rotation properties. This will connect the Open layer to the camera Position & Rotation, enabling control of them from the timeline.
4. Right click on each property and use an expression to connect each of these properties to the appropriate incoming DMX value - you may need to scale these values to match the world-scaling in the third party visualiser.

## PositionReceiver Workflow

### MA2 setup:

1. Create a new project file, go to setup MA Network Control>create a new session, then go to Network protocols and enable the Art-Net
2. Open the camera pool, select the Front view, it should be highlighted in green, then store a new camera view in one of the empty slots



3. Go to Setup and patch an MA camera controller fixture (18 channel) in a new universe to address 1.
4. Once the camera controller fixture is patched to the right address please invert the Tilt of the MA camera controller personality. This will allow synchronizing the tilt of the disguise virtual camera an MA camera
5. Go to the camera pool and right-click on the new camera and select the camera control fixture. Set the x,y,z values to 0 and the rotation x,y,z to 0 and the FOV at 0.79

Edit 13. 'evo 13'						Previous	Next			
No.	Name	X	Y	Z	Rot. X	Rot. Y	Rot. Z	FOV	Step Thro	Fixture
13	evo	0.00	0.00	0.00	0.00	0.00	0.00	0.79		CC 1 21

These steps will allow you to control the new camera using the encoders of the desk.

## MA3D setup:

1. Set the default camera to Front
2. Select the Stage Plane and make it 25m height x 25m wide, the default size of the disguise floor is 25m x 25m
3. Create a new plane with a size of 8m wide x 4.5m height, and set the position z at 3m. This plane is the same size and position of the default surface 1 of disguise.
4. Set the default camera to the new camera created previously
5. The visualizer will go to black since the new camera is at 0,0,0. Use the MA2 desk to move the camera to a desirable view and store a position preset for it.

6. Set the MA3D visualizer to full screen on your external monitor

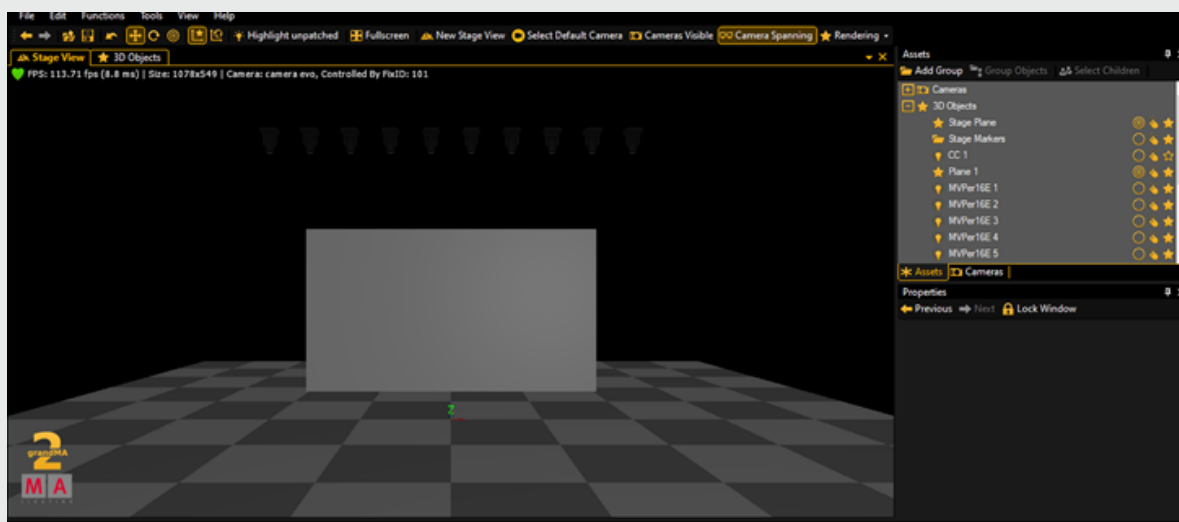

These steps are needed in order to replicate the disguise 3D environment with the MA3D environment to help align both visualizer cameras

## NDI setup:

1. Once the machine with the MA onPC and MA3D is ready, run NDI Scan convertor. This app will convert the outputs of the GPU in video streams over IP.
2. Open the NDI studio monitor and check that screen with the MA3D is working as an NDI stream.

## Disguise setup:

1. Open a new project file, remove the projector out of the stage and create a new virtual camera
2. Right click on Devices > Video input patch. Select video.in1>input configuration> select the NDI stream of the MA3D. Click on Start preview to check the stream, then stop the preview.
3. Create a DMX device, and use the IP address of the MA onPC or MA desk, and check the data with the DMX monitor.



4. Create a PositionReceiver Device and build new expressions to control the position x,y,z and rotation x,y,z of the virtual camera within Disguise software using the data coming from the MA lighting desk.

## Expressions

Expressions are used within Disguise software to calculate the mathematical values needed to align the virtual worlds of both visualizers. The information that follows will be used in the expressions that need to be created within Disguise:

- The MA camera controller has a range from -1000m to 1000m for the x,y,z positions and a range of -720 to 720 degrees for the pan and tilt.
- The position x,y,z of the MA camera control has a resolution of 24bits for the x,y,z, pan and tilt. Expressions within Disguise software only support 16bits, meaning that the camera movement in Disguise will be smooth using 16bit data.
- The 'position y' of the MA camera controller is the 'offset z' value of the virtual camera within Disguise software; The 'position z' of the MA camera controller is the 'offset y' value of the virtual camera within Disguise.

1. These are the expressions you need to build:

- Camera offset x:

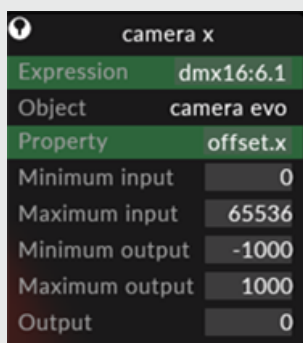

camera x	
Expression	dmx16:6.1
Object	camera evo
Property	offset.x
Minimum input	0
Maximum input	65536
Minimum output	-1000
Maximum output	1000
Output	0

- Camera offset y:

camera y	
Expression	dmx16:6.7
Object	camera evo
Property	offset.y
Minimum input	0
Maximum input	65536
Minimum output	-1000
Maximum output	1000
Output	2.99072

Camera offset z:

camera z	
Expression	dmx16:6.4
Object	camera evo
Property	offset.z
Minimum input	0
Maximum input	65536
Minimum output	-1000
Maximum output	1000
Output	-15.014

Camera pan (rotation y)

camera pan (rotation y)	
Expression	dmx16:6.10
Object	camera evo
Property	rotation.y
Minimum input	0
Maximum input	65536
Minimum output	-720
Maximum output	720
Output	0.70312

Camera tilt (rotation x)

camera tilt (rotation x)	
Expression	dmx16:6.13
Object	camera evo
Property	rotation.x
Minimum input	0
Maximum input	65536
Minimum output	-720
Maximum output	720
Output	-1.4502

2. If the expressions are correctly built the new virtual camera within Disguise software will move to the same x,y,z position location of the MA3D camera.
3. Create a new Video layer, map it to surface 1, and add some media.
4. Create another Video layer, change the blend mode to Add, and select video-in 1 as media; the thumbnail will display the MA3D NDI stream with a checkerboard. Make a new direct mapping for your new virtual camera
5. Go to Stage>Visualizer Camera and assign to the new virtual camera
6. The Disguise camera and the MA3D camera will be aligned
7. Open the virtual camera properties editor and change the background colour to black.

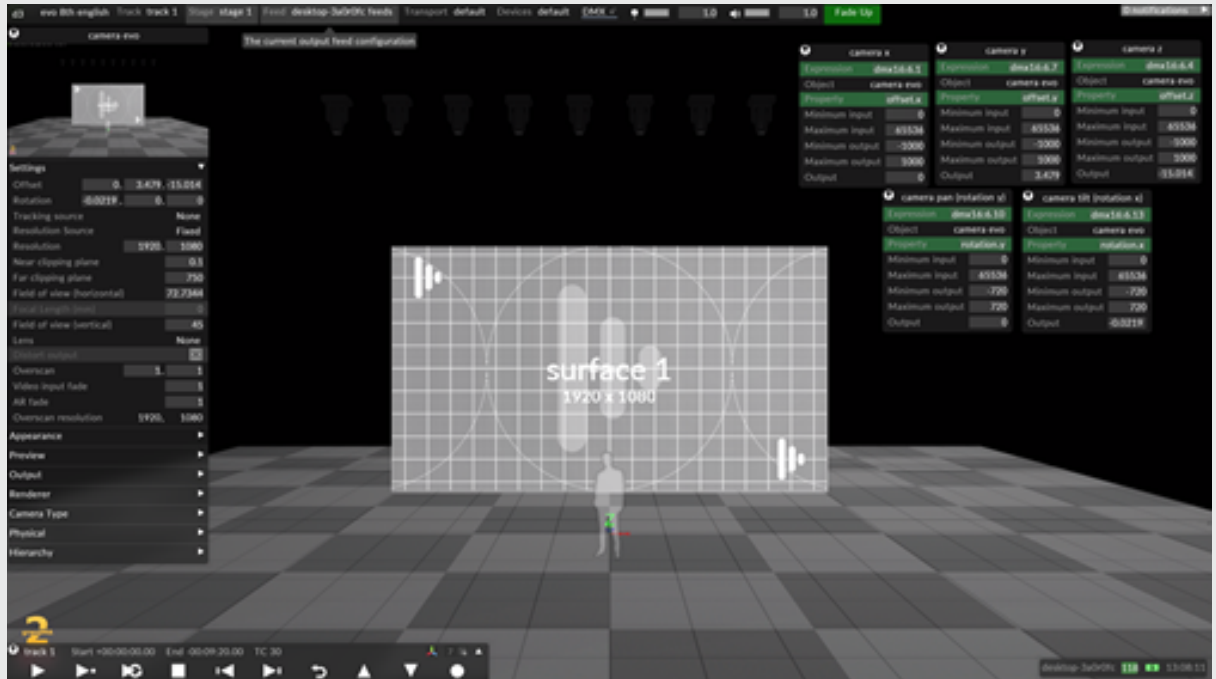

Once you have finished all the steps you can make the stage plane in MA3D invisible; it will not be needed once the alignment of the cameras is completed. You can start patching lights on the grandMA2 and add screens in disguise to create your show.

## MA3D

# Controlling the disguise camera from MA3D

## General Information

The MA 3D world is scaled between -1000m and +1000m, and rotation between -720 and +720°. DMX values for control are output as 24 bit control signals, using 3 DMX channels (bytes). Disguise only supports the input of 8 or 16-bit values, so we take the most significant bits from these values.

Using these real world values, we are then able to plug them into the following formulas to create the expressions needed to connect an external visualiser camera to the internal camera within disguise:

**{world centre offset in meters/ degrees}+(dmx16:universe.address/65536)\*{world size in meters/ degrees}-{world size in meters/ degrees}**

## Position X

**1000+(dmx16:1.1/65536)\*2000-2000**

## Position Y

**1000+(dmx16:1.7/65536)\*2000-2000**

Since Y and Z are flipped in GrandMA 3D, we pick up opposing DMX values

## Position Z

**1000+(dmx16:1.4/65536)\*2000-2000**

## Rotation X

**720-(dmx16:1.13/65535)\*1440-1440**

## Rotation Y

**720+(dmx16:1.10/65536)\*1440-1440**

## Rotation Z

No expression

GrandMA 3D does not support Rotation Z via DMX

## Field of View

Set this manually

MA 3D measures field of view as half horizontal value compared to Disguise software (eg if MA 3D is 22.5°, Disguise software field of view is 45°).

In the above expressions, the constants 1440 and 2000 are derived from the world scale of the GrandMA 3D scene.

- 2000 is the scale factor between the GrandMA 3D world positions into meter scaling.
- 1440 is the scale factor between the GrandMA 3D world rotations and degrees.
- The above constants can be modified for integration with other visualisation systems.
- Note that these expressions are only reading the top two bytes (16-bits) of the 24-bit values
- At this point when you move the external visualiser camera, Disguise software visualiser camera will move too.

## Using disguise to control the MA3D camera

Disguise only supports the sending of 8 bit values from the DMXLightsControl layer, so we need to use expressions to split the 24 bits into separate bytes:

### High Byte Position X

DMX Channel 1

```
(((camera.offset.x+1000)*8388.608)/65536)
```

### Mid Byte Position X

DMX Channel 2

```
(((camera.offset.x+1000)*8388.608)%65536)/256)
```

### Low Byte Position X

DMX Channel 3

```
(((camera.offset.x+1000)*8388.608)%256)
```

### High Byte Position Y

DMX Channel 4

```
(((camera.offset.y+1000)*8388.608)/65536)
```

**Please note:** Note that Y and Z are flipped in MA 3D world

## Mid Byte Position Y

DMX Channel 5

$$\left(\left(\left(\text{camera.offset.y}+1000\right)*8388.608\right)\%65536\right)/256$$

## Low Byte Position Y

DMX Channel 6

$$\left(\left(\left(\text{camera.offset.y}+1000\right)*8388.608\right)\%256\right)$$

## High Byte Position z

DMX Channel 7

$$\left(\left(\left(\text{camera.offset.z}+1000\right)*8388.608\right)/65536\right)$$

## Mid Byte Position z

DMX Channel 8

$$\left(\left(\left(\text{camera.offset.z}+1000\right)*8388.608\right)\%65536\right)/256$$

## Low Byte Position z

DMX Channel 9

$$\left(\left(\left(\text{camera.offset.z}+1000\right)*8388.608\right)\%256\right)$$

## High Byte Rotation X

DMX Channel 10

$$\left(\left(\left(\left(\text{camera.rotation.x}*-1\right)+720\right)*\left(\left(256*256*256\right)/1440\right)\right)/65536\right)$$

## Mid Byte Rotation X

DMX Channel 11

$$\left(\left(\left(\left(\text{camera.rotation.x}*-1\right)+720\right)*\left(\left(256*256*256\right)/1440\right)\right)\%65536\right)/256$$

## Low Byte Rotation X

DMX Channel 12

$$(((\text{camera.rotation.x}^* - 1) + 720) * ((256 * 256 * 256) / 1440)) \% 256$$

## High Byte Rotation Y

DMX Channel 13

$$(((\text{camera.rotation.y}^* - 1) + 720) * ((256 * 256 * 256) / 1440)) / 65536$$

**Please note:** Y is inverted in MA3D so we invert the expression with the negative conversion on the bytes

## Mid Byte Rotation Y

DMX Channel 14

$$(((\text{camera.rotation.y}^* - 1) + 720) * ((256 * 256 * 256) / 1440)) \% 65536 / 256$$

## Low Byte Rotation Y

DMX Channel 15

$$(((\text{camera.rotation.y}^* - 1) + 720) * ((256 * 256 * 256) / 1440)) \% 256$$

## High Byte Zoom

DMX Channel 16

## Mid Byte Zoom

DMX Channel 17

## Low Byte Zoom

DMX Channel 18

### Constants



In the above expressions, the constants are derived from the world scale of the GrandMA 3D scene.

Position constant: **8388.608** is the scale factor between the GrandMA 3D world positions (-1000m to +1000m = 2000m) and the 24-bit DMX value  $(256 \times 256 \times 256) / 2000 = 8388.608$ .

Rotation constant:  $((256 \times 256 \times 256) / 1440)$ : **11650.84444444** is the scale factor between the GrandMA 3D world rotations (-720 to +720 degrees = 1440 degrees) and the 24-bit DMX value  $(256 \times 256 \times 256) / 1440 = 11650.84444444$

The above constants can be modified for integration with other visualisation systems.

You will need to patch these same values in the external visualiser.

At this point when you move the disguise camera, the external visualiser camera will move.

The only final adjustments that need to be set manually are field of view.

## Capture

These are suggested expressions for controlling the visualizer camera within Capture from disguise based on the following information available from Capture documentation.

bit depth = 16  
max value =  $2^{\text{pow}(\text{bit depth})} = 65536$

output min = -32768  
output max = 32768  
output range = output max - output min = 65536

output to bit ratio = max value / output range = 1

## Capture Camera control X, Y, Z:

value 1:  $(\text{camera:camera.offset.x} \times 100 + 32768 \% 65536) / 256$

value 2:  $\text{camera:camera.offset.x} \times 100 + 32768 \% 256$

value 3: (unassigned)

value 4:  $(\text{camera:camera.offset.y} \times 100 + 32768 \% 65536) / 256$

value 5:  $\text{camera:camera.offset.y} \times 100 + 32768 \% 256$

value 6: (unassigned)

value 7:  $((\text{camera:camera.offset.z} - 1) \times 100 + 32768 \% 65536) / 256$

value 8:  $(\text{camera:camera.offset.z} - 1) \times 100 + 32768 \% 256$

## Camera Control Rotation:

value 1:  $(\text{camera:camera.rotation.y} \times 182 + 180 \times 182.044 \% 65536) / 256$

value 2:  $\text{camera:camera.rotation.y} \times 182 + 180 \times 182.044 \% 256$

value 3: (unassigned)

value 4:  $(\text{camera:camera.rotation.x} * 182 + 180 * 182.044 \% 65536) / 256$

value 5:  $\text{camera:camera.rotation.x} * 182 + 180 * 182.044 \% 256$

value 6: (unassigned)

value 7:  $(\text{camera:camera.rotation.z} * 182 + 180 * 182.044 \% 65536) / 256$

value 8:  $\text{camera:camera.rotation.z} * 182 + 180 * 182.044 \% 256$

**Please note:**

- The Camera position range is -32768 to 32768 for X, Y, and Z; this value is in cm\*
- The Camera rotation range is -180 to 180
- Capture requires 16bit resolution
- Z axis is inverted in Capture so you need to use camera z \* -1
- Expressions must be converted to METERS so we use \* 100 in the expressions to convert cm to m

# ISAAC Bridge

## ISAAC Bridge

### Overview

ISAAC is a multifaceted platform from Smart Monkeys that redefines the way AV systems are deployed, monitored and managed. Covering a spectrum of elements from lighting and audio to video projections and displays, it allows users to monitor and manage all elements of an AV system from a single on-premise portal without the need for internet connection. Users are also able to distribute and schedule content playback remotely using ISAAC.

Integrating ISAAC with Designer extends its functionality to both technical and non-technical users, enabling the user to remotely monitor and manage the disguise platform alongside their wider AV system- removing the need for 24/7 on-site monitoring. ISAAC bridge creates a simplified and unified experience for users running fixed installation projects.

Learn more about ISAAC [here](#).

The **ISAAC Bridge** app is currently still in development. For more information, please contact our product team [product-team@disguise.one](mailto:product-team@disguise.one).



## Workflow

### Installation

ISAAC Bridge installs to **Windows\Start Menu\Programs\Disguise**.

ISAAC Bridge should be installed on the director machine when run across a multiple machine setup. When disguise is running on a single server, ISAAC Bridge should be installed on that server.

### Interface Overview

The ISAAC Bridge interface is split into three sections:

- **Configuration**
- **Status**
- **Actions**

### Configuration:

On first launch, set the following:

- IP address of the ISAAC server
- IP address of the disguise machine  
In a multiple machine setup this will be the **director**. This configuration persists between restarts.
- Module ID of the module in ISAAC.

In a multi-machine setup the IP address of the disguise machine will be the director. This configuration persists between restarts.

## Status:

### — Bridge Status:

Status of the ISAAC Bridge application, either **RUNNING** or **STOPPED**.

### — ISAAC:

Status of the ISAAC server, either **ONLINE** or **OFFLINE**.

### — ISAAC TCP:

Status of the connection to the ISAAC server, either **CREATED**, **CONNECTED**, **ERROR** or **CLOSED**.  
This is the connection by which scheduled events are received by disguise.

### — disguise:

Status of the disguise machine, either **ONLINE** or **OFFLINE**.

### — Project:

Whether there is a disguise project currently running on the specified disguise server. Either **RUNNING** or **NOT RUNNING**.

## Actions:

### — Populate Events:

Creates or updates ISAAC events. Requires a connection to ISAAC.

### — Populate Playables:

Creates or updates ISAAC Playables for each Track in the Default Transport in the running disguise project. Requires a connection to both ISAAC and disguise, and for the disguise project to be running.

## Supported ISAAC Features:

### Events:

ISAAC Bridge exposes two events to ISAAC:

- **Start Project** - starts the last run disguise project
- **Stop Project** - stops the currently running disguise project

To populate these events in ISAAC, click **Populate Events**.

### Playables:

ISAAC Bridge exposes Tracks on the Default Transport in disguise to ISAAC as Playables. To populate ISAAC Playables with available disguise Tracks, ensure that a disguise project is RUNNING and click **Populate Playables**.

### Variables:

Variables exposed to ISAAC:

**Running Project** - project path of the running disguise project.

# VR

Virtual Reality visualiser is an OpenVR / Steam compatible visualiser mode allowing the user to enter and navigate through the scene.

VR was designed to primarily work with Designer machines, utilising GPU's such as GTX 1060 & higher (or other manufacturer equivalent).

As such, gx range machines are well suited for VR work. However, Pro & Plus ranges are not recommended for VR usage as they are not as well suited to the feature as newer machines. However VR does also work on these machines, but performance may vary.

We have tested HTC Vive and Oculus headsets on Disguise software and they are known to work. However, there are some known issues.

## HTC Vive

- The machine needs to be restarted after first installation, otherwise the headset will not be detected
- All EDID's need to be de-emulated otherwise the headset will not work
- The box needs to be plugged into a USB 3 port.

**Please note:** Modern rendering modes such as VR depend on appropriately powerful GPU choices. This feature requires significantly more GPU power than other rendering features in Disguise software. For project specific guidance, please contact [support@disguise.one](mailto:support@disguise.one).

So far there is no plan to add more UI functionality; it's just for viewing and walking around.

You need to have the Steam system running; you should be able to get to the point where the headset and one controller are reporting green and working, and the headset should show the Steam basic scene. Once that's working, if steam is installed, and the VR equipment is connected - when starting a Disguise project, you will automatically be placed into VR mode.

- The visualiser shows you the position and orientation of the headset in stage space (small white cuboid about the same size as a headset, with an orange line down to the floor). It also shows you where the controller is pointing (white line when it hits the floor level, blue line otherwise).
- Navigation - the VR user navigates by pointing the controller at the floor location they want to go to; it goes white; they click the button and they jump there. The property **movement speed** in the VR Navigator window can be set to zero (jump immediately) or some non-zero number, which moves the VR world in a straight line on a linear path. This gives you a little 'jerk' at start and end but doesn't seem to result in nausea. It's less confusing for new users, but may be annoying for experienced users.

The Virtual reality navigator also lets you set up the position and orientation of the scene relative to the physical world. The VR experience keeps this orientation constant to avoid users getting lost. They still get lost of course, and when they do you can hit the **reset** button to bring them back to the center.

## Opening the virtual reality navigator

1. Open the stage editor by right clicking **Stage** from the dashboard or by right clicking the **floor** in the visualiser.
2. Select the **Cameras** tab
3. Left click **Virtual reality navigator** and then you can see what the VR user sees.



**Warning:** Navigation is restricted to floor level. We need to be able to move to the nearest horizontal surface on whatever venue / stage you're on.

**Warning:** There's no 'reverse' button; the workaround is just to point behind you and hit the button.

The image shows the basic elements of VR functionality.



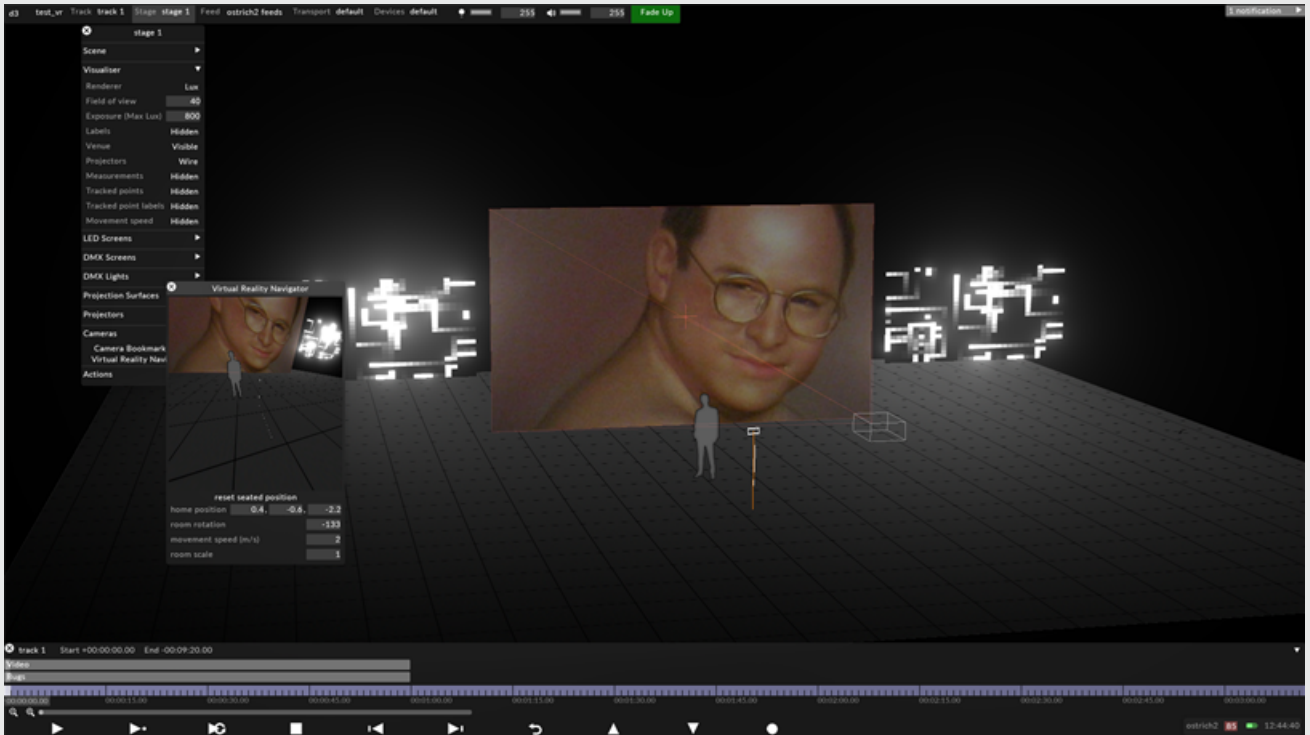

## Using HTC Vive for virtual camera tracking

As of r17.2, virtual cameras can now be tracked by the headset or controller of the HTC Vive

To assign HTC Vive as tracking source for a virtual camera:

1. Connect your HTC Vive to your machine and ensure the device is working in SteamVR.
2. Launch your disguise project version r17.2 or later.
3. Create a new virtual camera in your project file by right clicking on the Stage menu.
4. Hit the + icon under the Cameras tab and input the name and specifications of your camera.
5. Open the camera's menu by right clicking on its name from the Stage menu, or on the icon of the object in the visualiser.

6. Under the first tab called Settings, right click on the Tracking source field.
7. The Vive's headset and any active controllers will be listed here; left clicking on one will assign the position of the camera to it.
8. The Offset and Rotation fields of the virtual camera's menu will turn green when receiving a working signal.

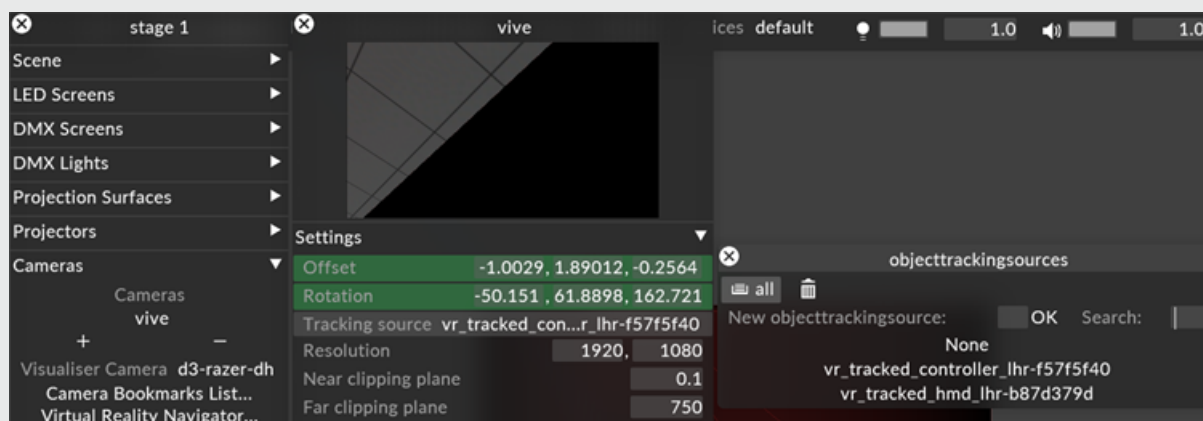

**Please note:** Any headset that supports Steam Open VR can be used with disguise. Please check the manufacturer's specifications of the headset type you would like to use to confirm if it supports Steam Open VR.

# disguise cloud

## Overview

The disguise cloud platform is a collection of web apps that are designed to empower and improve users' daily workflows with the disguise platform. The focus of disguise cloud is to provide online-based interactions and experiences, with some additional offline features. Disguise Cloud is available for desktop and mobile.

## Cloud Dashboard

The disguise cloud dashboard is where users manage member access to their organisation, manage, and create drives, subscriptions, billing details, and any third-party connections. Manage the users of your organisation to fit your needs with [Cloud Dashboard](#).

## disguise Drive

Content teams involved in media and entertainment projects typically operate across various storage platforms. These solutions are not built specifically for complex, high-resolution projects and they don't acknowledge the modern way that studios and creatives are producing content. [disguise drive](#) allows users to upload and consolidate all of their project content in one simple online interface. A Drive is a place to collect and store content. Feel free to use it however best suits your setup. A Drive could be used for a project, a branch of your company or a location.

# Previz

Previz empowers creative teams to publish and share 3D experiences and streamline the content review process. Users can preview 3D models from various perspectives with speed and ease. Designer users can share their creations to Previz, enabling collaboration and enhancing project efficiency. Sharing projects on Previz is straightforward, granting teams easy access to 3D visualizations for collaborative review. Previz supports 3D animations, cameras, and lighting, ensuring that your creative vision is accurately represented.

Collaboration is at the heart of Previz. Multiple users can work on a project simultaneously, promoting real-time teamwork and productivity. Previz streamlines approval workflows for both internal teams and external clients, making the decision-making process more efficient and transparent. Discover how Previz can transform your creative projects [here](#).

# Mapping Matter

Mapping Matter is a simulation tool designed for audio visual professionals who need to create Video Projection Specs and recommendations for Large Scale Projects. It serves as a comprehensive solution for confirming budget estimates, assessing luminance, pixel densities, and refining projector placements.

With the integration of Mapping Matter, disguise Cloud is the only platform that offers interactive previsualisation and projection mapping tools directly in one web browser-based platform. Create large scale video projections in a simple 3D environment to plan everything you need before showtime. Learn more [here](#).

# disguise cloud

## Overview

The disguise cloud platform is a collection of web apps that are designed to empower and improve users' daily workflows with the disguise platform. The focus of disguise cloud is to provide online-based interactions and experiences, with some additional offline features. Disguise Cloud is available for desktop and mobile.

## Cloud Dashboard

The disguise cloud dashboard is where users manage member access to their organisation, manage, and create drives, subscriptions, billing details, and any third-party connections. Manage the users of your organisation to fit your needs with [Cloud Dashboard](#).

## disguise Drive

Content teams involved in media and entertainment projects typically operate across various storage platforms. These solutions are not built specifically for complex, high-resolution projects and they don't acknowledge the modern way that studios and creatives are producing content. [disguise drive](#) allows users to upload and consolidate all of their project content in one simple online interface. A Drive is a place to collect and store content. Feel free to use it however best suits your setup. A Drive could be used for a project, a branch of your company or a location.

## Previz

Previz empowers creative teams to publish and share 3D experiences and streamline the content review process. Users can preview 3D models from various perspectives with speed and ease. Designer users can share their creations to Previz, enabling collaboration and enhancing project efficiency. Sharing projects on Previz is straightforward, granting teams easy access to 3D visualizations for collaborative review. Previz supports 3D animations, cameras, and lighting, ensuring that your creative vision is accurately represented.

Collaboration is at the heart of Previz. Multiple users can work on a project simultaneously, promoting real-time teamwork and productivity. Previz streamlines approval workflows for both internal teams and external clients, making the decision-making process more efficient and transparent. Discover how Previz can transform your creative projects [here](#).

## Mapping Matter

Mapping Matter is a simulation tool designed for audio visual professionals who need to create Video Projection Specs and recommendations for Large Scale Projects. It serves as a comprehensive solution for confirming budget estimates, assessing luminance, pixel densities, and refining projector placements.

With the integration of Mapping Matter, disguise Cloud is the only platform that offers interactive previsualisation and projection mapping tools directly in one web browser-based platform. Create large scale video projections in a simple 3D environment to plan everything you need before showtime. Learn more [here](#).

# disguise cloud

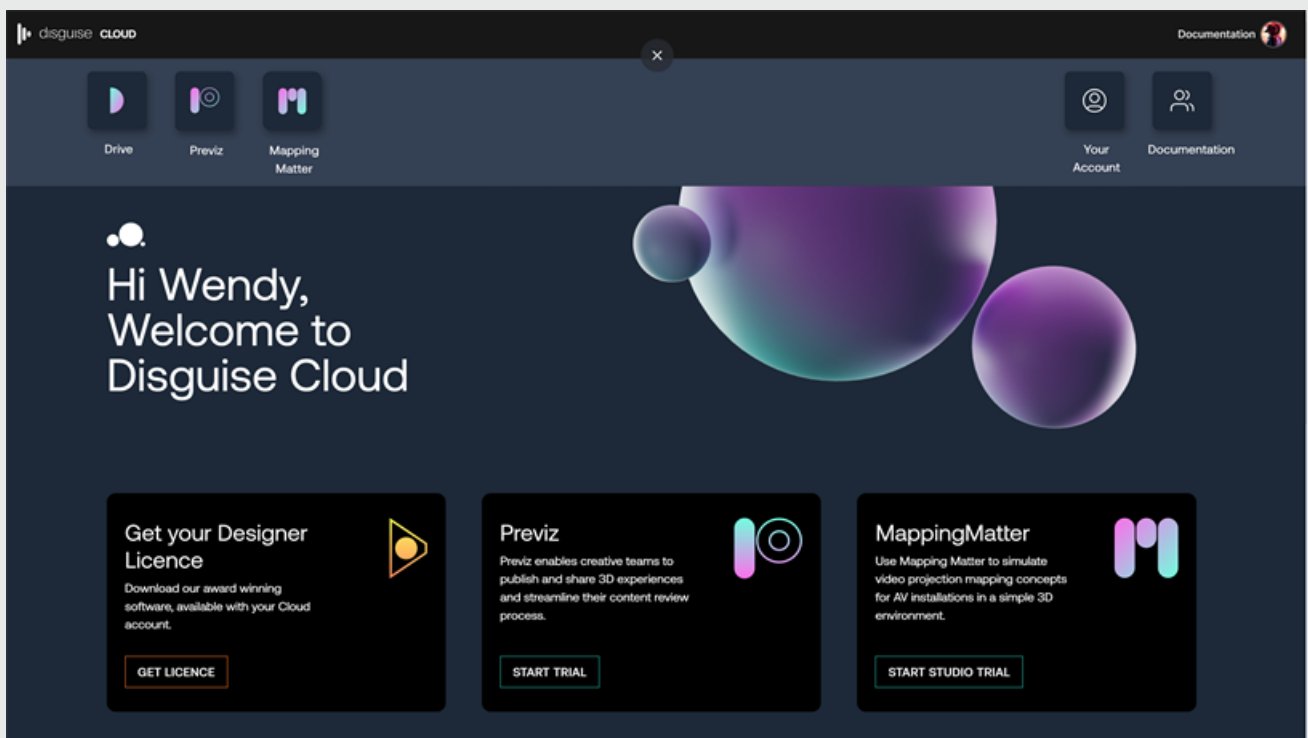

## Cloud Dashboard

Cloud Dashboard enables users to launch Drive, Previz and Mapping Matter on the Cloud platform. With Cloud Dashboard, it's easy to manage your organisation and administer your team. You can access your account through the Cloud Dashboard to update your profile and customize your preferences.

Users can also generate a Designer licence. Designer licences are optional and can be created free of charge through your Cloud Dashboard or directly through d3Manager.

Paid plans are offered on a per-user basis. Details can be found on the pricing page or in your Cloud Dashboard.





# Creating a Cloud account

## Create a Disguise Cloud account

To sign up for Disguise Cloud, you can create an account on the [Disguise Cloud website](#).

It is free to sign up, no credit card is required.

Please note that we recommend using a Chrome Browser to access disguise cloud.

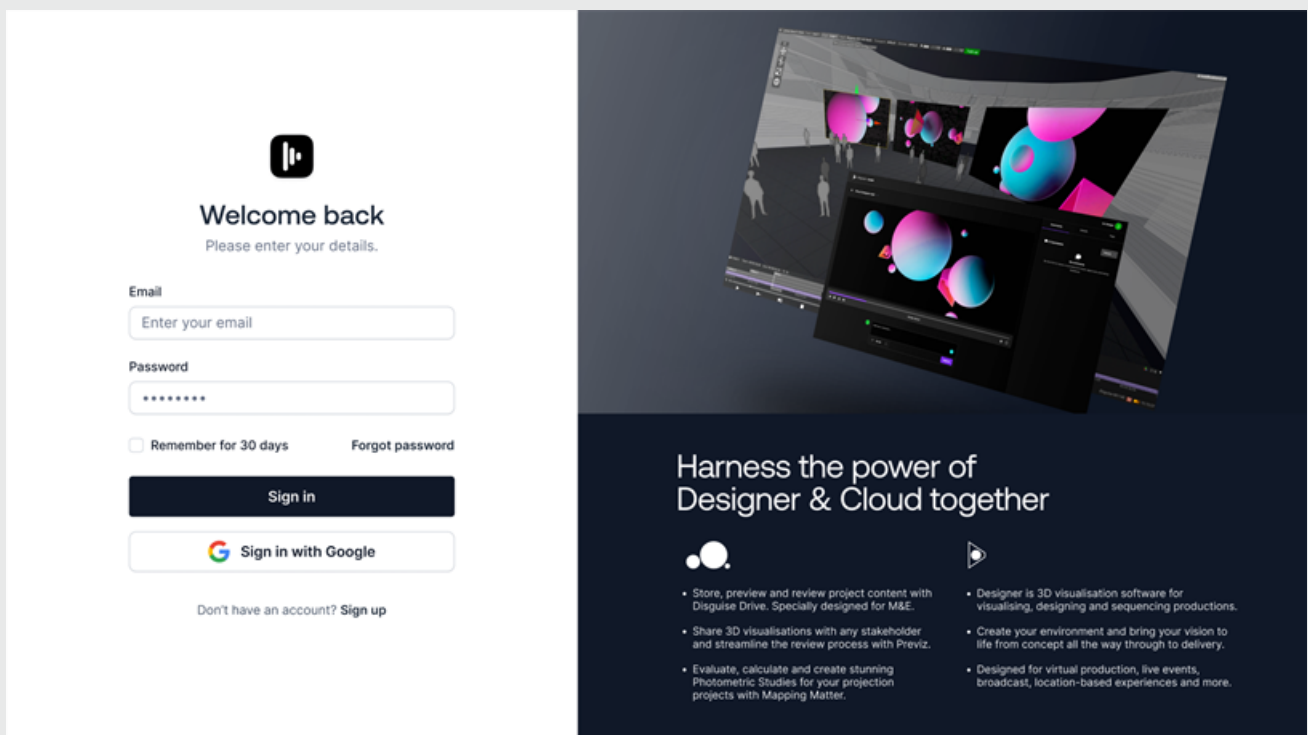

## Sign up with Google

1. Go to the disguise cloud account creation page, <https://disguise.cloud/signup>.
2. Click on the **Sign in with Google** button.
3. Confirm your Google email credentials

## Join with email

1. Go to the disguise cloud account creation page, <https://disguise.cloud/signup>.
2. Click on the **Join with email** button.
3. Confirm your email credentials.

## Sign in

1. Go to the disguise cloud website, <https://disguise.cloud>.
2. Confirm your Google email credentials.

## Sign out

1. Click on your profile avatar image.
2. Click **Sign Out**.

# d3 Manager Cloud Login

## d3 Manager Cloud Login & Licensing

There are three ways you can apply the cloud license and log in to the d3 Manager:

- Download Designer from the disguise website. From here you will have access to an existing Cloud platform and you are logged in.
- Download Designer from the disguise website. From here you will need to set up and log in to a new Cloud account.
- If you already have a Designer license, open the d3 manager and log in to your Cloud account by clicking the Log in button and following the instructions. You will be prompted to confirm an access code through your browser to sync your Designer license with your Cloud account.

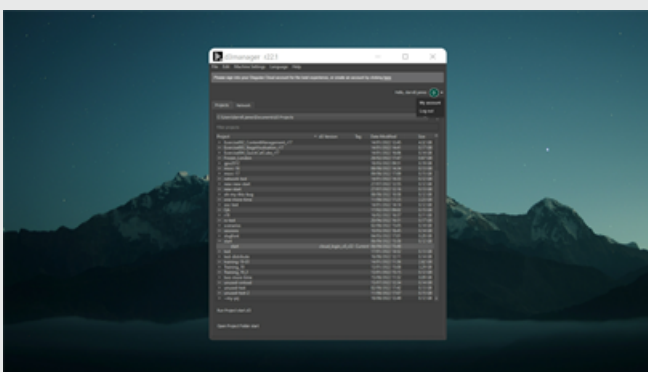
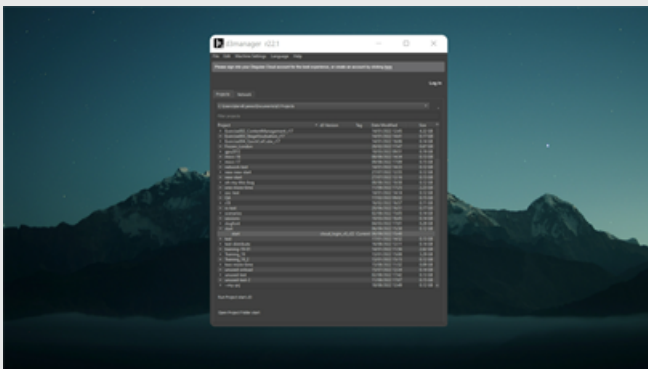

# Editing your profile

## Edit your account details

1. To find your account details, select your Disguise Cloud avatar photo.
2. From the pop-up menu, click on your email address.
3. On the **Your Account** page, on the **General** tab, you can update your name, avatar photo, and light or dark mode application preference.
4. Simply click **Update**, edit the field that you wish to change, and then click **Save**.

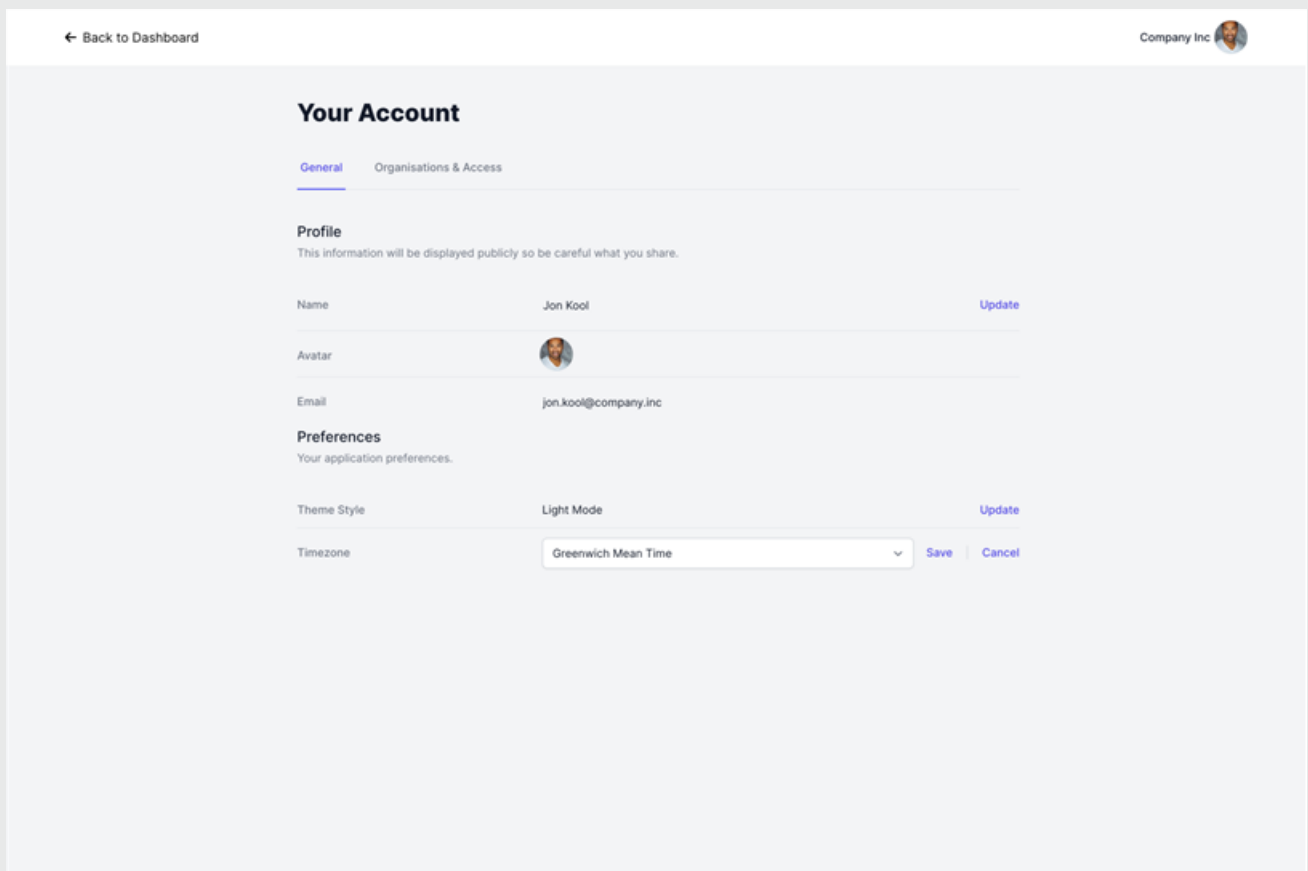

The screenshot displays the 'Your Account' page with a navigation bar at the top. On the left, there is a 'Back to Dashboard' link. On the right, the user's name 'Company Inc' and a profile picture are shown. The main content area is titled 'Your Account' and has two tabs: 'General' (selected) and 'Organisations & Access'. Under the 'Profile' section, there is a warning: 'This information will be displayed publicly so be careful what you share.' Below this, there are three rows of settings: 'Name' (Jon Kool) with an 'Update' button; 'Avatar' (a profile picture); and 'Email' (jon.kool@company.inc). The 'Preferences' section follows, with the note 'Your application preferences.' It includes 'Theme Style' (Light Mode) with an 'Update' button, and 'Timezone' (Greenwich Mean Time) with a dropdown menu, 'Save', and 'Cancel' buttons.

# Working with organisations

## Create a new organisation

1. To create an organisation, left-click on your Disguise Cloud avatar photo.
2. From the pop-up menu, click on your email address.
3. From the **Your Account** page, on the General tab, click on the **Organisations & Access** tab.  
Here you can see any existing organisations.
4. Click on the **Create an org** button.
5. Type the name of your new organisation in the **Organisation Name** field and click on the **Create** button.

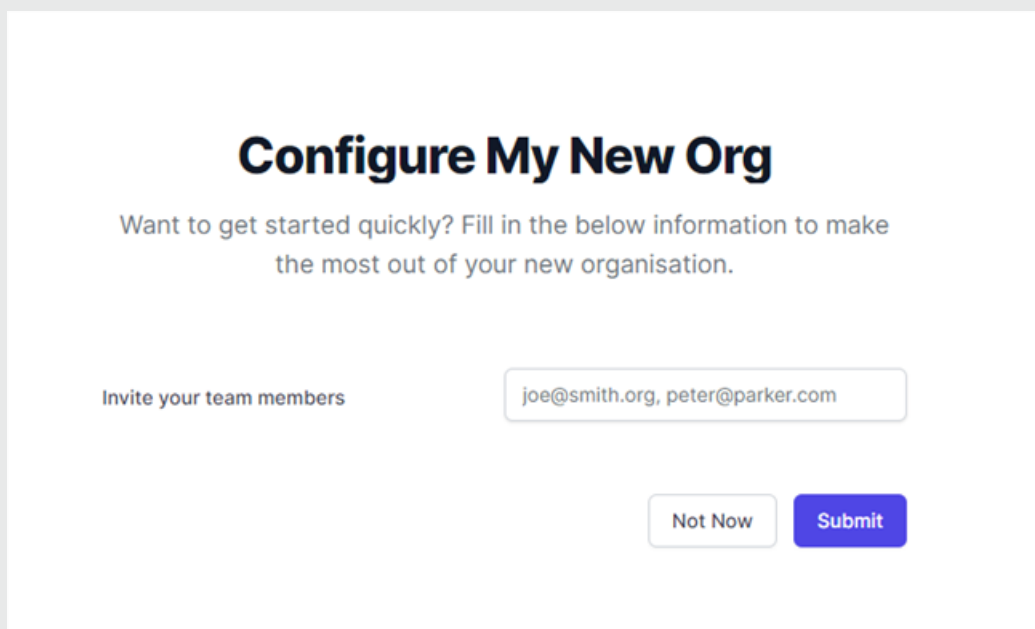

**Configure My New Org**

Want to get started quickly? Fill in the below information to make the most out of your new organisation.

Invite your team members

# Member management

## Invite a new member to an organisation

1. To access organisation management from the Dashboard, click on the **Management** button.
2. Click on the **Members** tab.
3. Click on the **Invite to team** button.
4. Input the email address of the team member you want to add.
5. Select a Team Role for the new member by clicking on **Member** or **Administrator**.
6. Click on the **Invite** button.

## View recent invites

1. Click on your Disguise Cloud avatar photo.
2. From the menu, click on the name of your organisation.
3. On the **Your Account** page, click on the **Organisations & Access** tab

Here, you can see all invitations to join organisations, and any entitlements that you may have.

# Troubleshooting

## Create a support ticket

1. To create a support ticket, click on your Disguise Cloud avatar photo.
2. From the pop-up menu, click on **Contact Support**.
3. Type your feedback into the input box and click on **Submit Feedback**.

# Known Issues

Disguise Cloud has some known issues that we are working hard to fix.

## The sign in button has stopped working when the browser was closed during sign-up.

If this happens:

1. Restart your computer.  
Going offline and restarting will cause Designer to sign out of the cloud.
2. Sign back in once the computer has restarted and is connected to the internet.

## Disguise Cloud avatar is cropped.

This will be fixed in the next update.

## Cloud login on Designer is not yet localised.

Localisation is a key feature planned for a later release.

For further help please contact [cloud support](#).



# Using drive

## Set up a drive

When you create an organisation a primary drive is automatically created for you with the name of your organisation. Primary drives are indicated as such by a star icon in the Drive table in the Management area.

To add another Drive you will need to be on a paid plan.

If you want to add more drives:

1. On your **Drive** page, click on the **+ New** icon and name the drive.

Alternatively, here is a second method to create a drive:

1. Click on the **Drives** tab if it is not the current tab.
2. Click on the **Create a Drive** button.
3. Type the drive name in the **Drive Name** field.
4. Click on the **Create** button.
5. To configure your drive, click on the **Update** button. Or if you'd rather do this at a later stage, click on **Not Now**.

## Create a Drive

Drives are collections of assets that you and your teammates can store and collaborate on together.

Drive Name

Drive Owner



Jon Kool  
jon.cool@company.inc

Back

Create

## Rename a drive

1. To rename a drive, click on **Settings** in Drive Settings.
2. To change the title, click on **Update**, type the new name, and then click **Save**.

## Create a folder

1. To create a folder in your drive, click on the plus icon **[+]** next to **Folders** below your drive name.
2. Type the name for your new folder in the **Folder Name** text field and click **Create**.

## Rename a folder

1. To rename a folder, click on the "..." symbol below **OPTIONS** in the drive details view.
2. Click **Rename**.

3. Type the new name for your new folder in the **Rename Asset** field and click the **Rename Asset** button.

## Delete a folder

1. To delete a folder, click on the "..." symbol below **OPTIONS** in the drive details view.
2. Click **Delete**.
3. Click on the **Delete Asset** button to confirm you want to delete the folder.

# Using drive

## Set up a drive

When you create an organisation a primary drive is automatically created for you with the name of your organisation. Primary drives are indicated as such by a star icon in the Drive table in the Management area.

To add another Drive you will need to be on a paid plan.

If you want to add more drives:

1. On your **Drive** page, click on the **+ New** icon and name the drive.

Alternatively, here is a second method to create a drive:

1. Click on the **Drives** tab if it is not the current tab.
2. Click on the **Create a Drive** button.
3. Type the drive name in the **Drive Name** field.
4. Click on the **Create** button.
5. To configure your drive, click on the **Update** button. Or if you'd rather do this at a later stage, click on **Not Now**.

## Create a Drive

Drives are collections of assets that you and your teammates can store and collaborate on together.

Drive Name

Drive Owner



Jon Kool  
jon.cool@company.inc

Back

Create

## Rename a drive

1. To rename a drive, click on **Settings** in Drive Settings.
2. To change the title, click on **Update**, type the new name, and then click **Save**.

## Create a folder

1. To create a folder in your drive, click on the plus icon **[+]** next to **Folders** below your drive name.
2. Type the name for your new folder in the **Folder Name** text field and click **Create**.

## Rename a folder

1. To rename a folder, click on the "... " symbol below **OPTIONS** in the drive details view .
2. Click **Rename**.
3. Type the new name for your new folder in the **Rename Asset** field and click the **Rename Asset** button.

## Delete a folder

1. To delete a folder, click on the "... " symbol below **OPTIONS** in the drive details view .
2. Click **Delete**.
3. Click on the **Delete Asset** button to confirm you want to delete the folder.

# Working with content

## Supported file formats

The file formats currently supported are:

- Image: png, .jpg, .bmp, .webp, .gif
- Video: mp4, .mov, .ts, .avi, .y4m, .mkv
- Audio: .mp3, .wav
- 3D: .glb, .obj, .glTF, .fbx

## Upload content

1. From your **Drive** page, select the drive you want to use from the dropdown menu.
2. Click on the **+ New** icon and select **Upload Content**.  
This will allow you to browse your local files.
3. Select the item you want to upload and click **Open**.

The item will upload and appear listed in your drive.

Alternatively, you can drag and drop a file or asset or several files from your computer into the main drive content area to upload to the current directory you are in.

You can also upload a folder that will upload all files within that folder along with any nested folders.

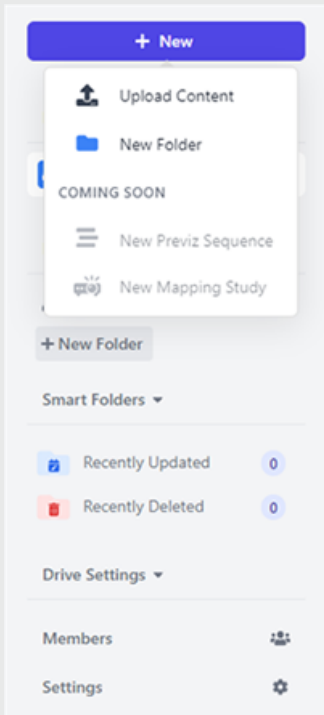

## Preview content

To preview content, click on the item in drive view.

This will open a view of the item. Here, you can see any comments and details.

## Leave a comment on an asset

1. To leave a comment on an asset, click on the item name to view it.
2. Then type on in the box below the item.
3. Click **Submit**.



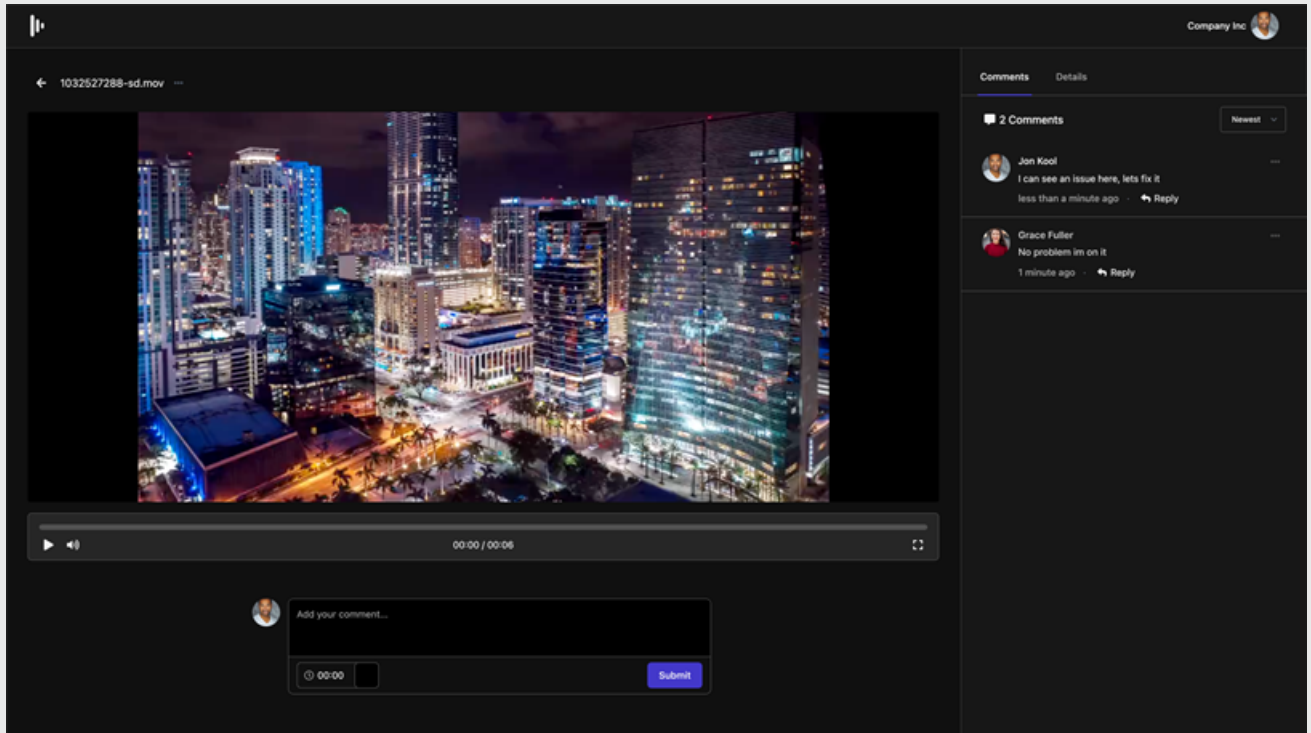

## View the Metadata of an asset

1. To view an asset's Metadata, click on the item to preview it.
2. Click on the **details** tab.

Company Inc

1032527288-sd.mov

Information

Filename	1032527288-Sd.Mov
Uploaded by	Jon Kool
Created	about 3 hours ago
Last modified	about 3 hours ago
Type	Video
Size	7.5MB
Format	Quicktime
File Size	
Duration	7 Seconds
Mime Type	Video/Quicktime
Aspect Ratio	71:40
Frame Rate	25
Resolution	SD
File Extension	quicktime

## Add timestamped comments on a video

In the comment box, you can change the timestamp by clicking on it and adjusting the time and frames.

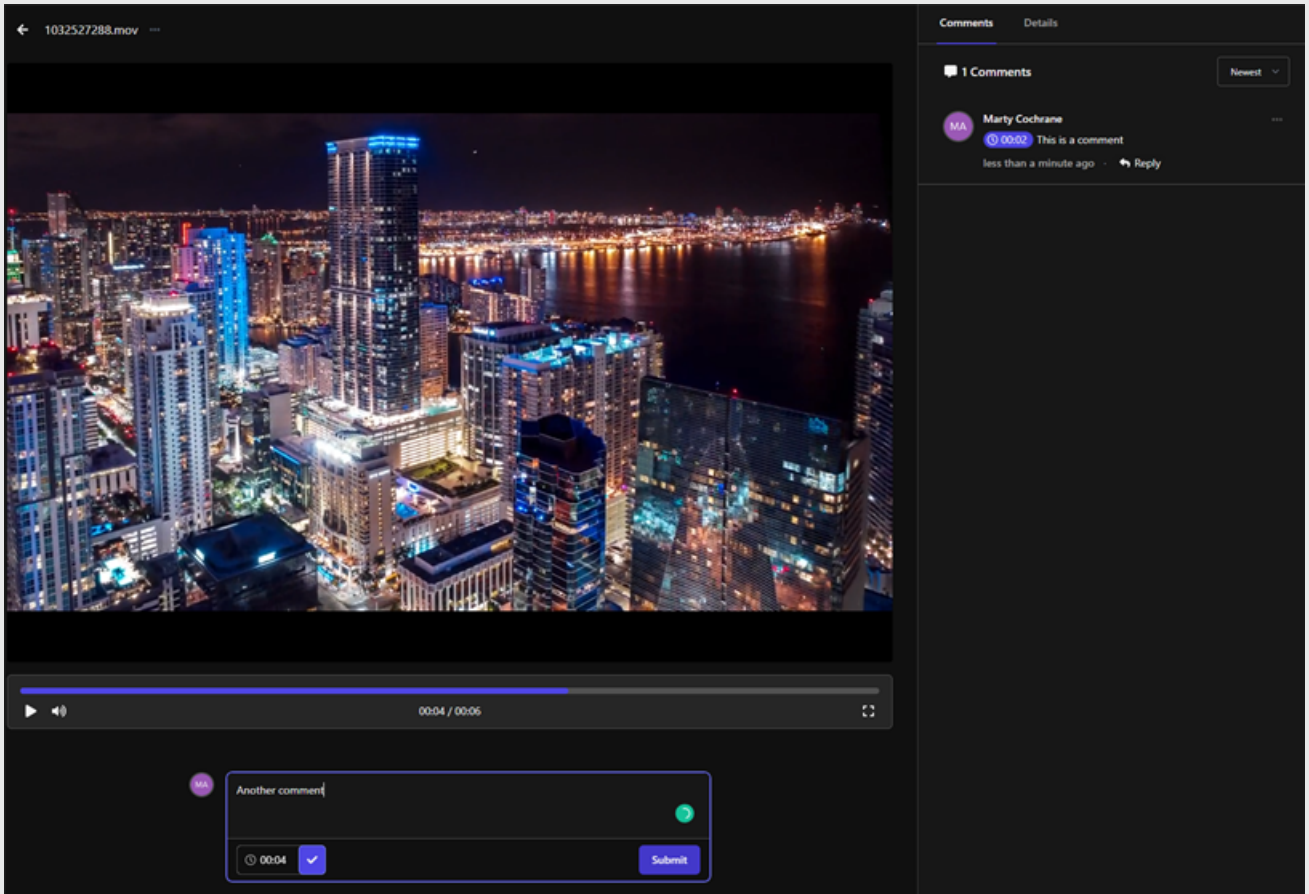

Clicking on a timestamp will jump you to the point in the video where the comment was left so you can review the frame it relates to.

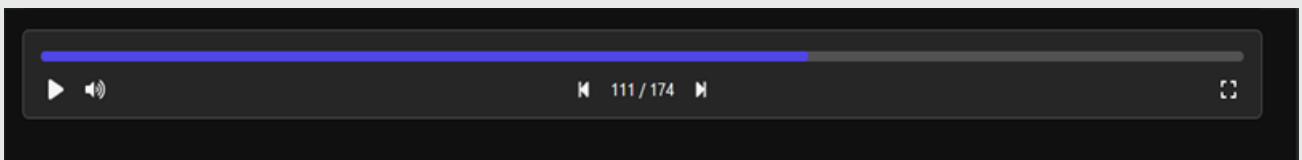

## Download an asset

1. From your drive's file list, click on the "..." below OPTIONS.
2. Click **Download**.

## Delete an asset

1. From your drive's file list, click on the "..." below **OPTIONS**.
2. Click **Delete**.

## Access recently deleted files

From your drive's file list view, click on the **Recently Deleted** SMART FOLDER.

This will list all of the recently deleted files and folders.

# Creating a Previz

With Previz you can plan and preview your content in a real-time 3D environment.

Sequences in Previz can contain a range of different media including images, videos, 3d and scenes.

## Create a new Previz

To create a new Previz:

1. In the dropdown menu labelled "New" accessible from Drive select "New Previz" next to the team name in the team sidebar.

When you select this option you will then need to enter the name for your new project.

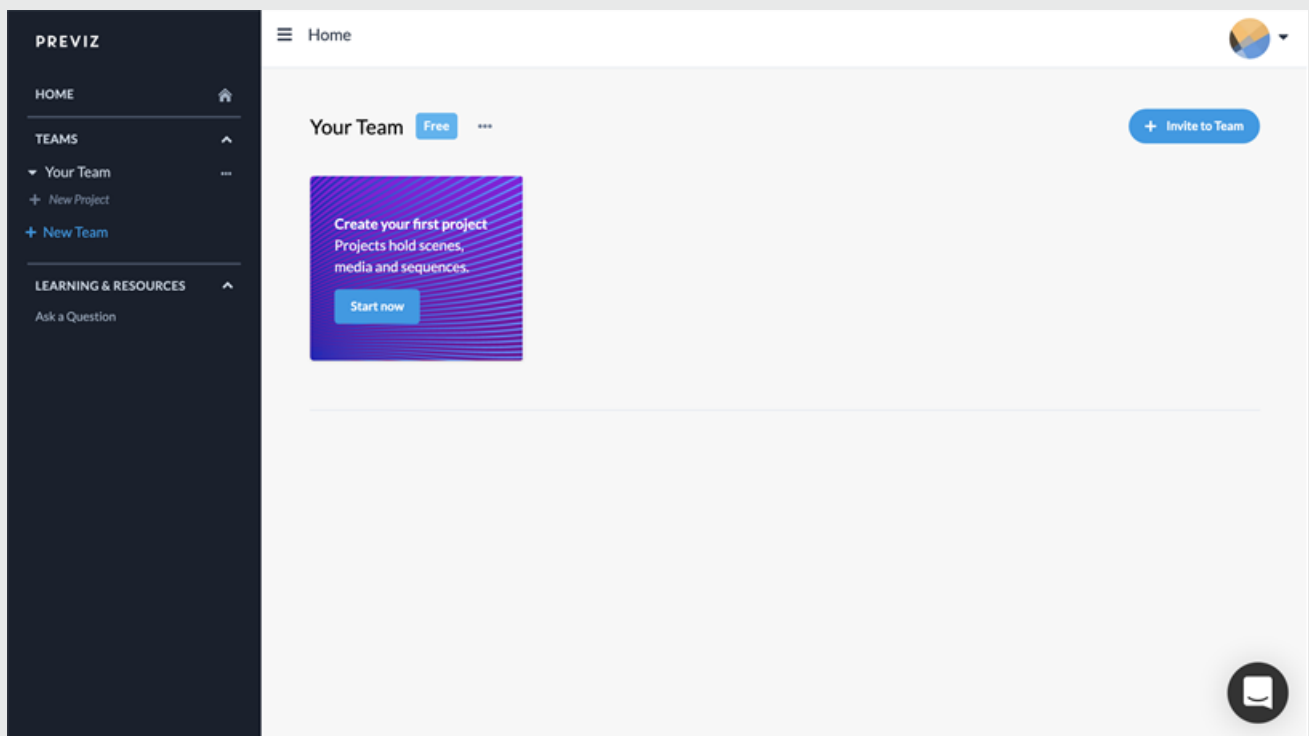

Create a Previz

# Uploading Content

## Types of files

- Images
- Video
- 3d Scenes (.gltf/ .glb format)

**Note:** The amount of storage available is dependent on your subscription level.

There are two ways to add content to your previz:

1. Adding the files in the drive application.
2. Dragging and dropping the files you want to upload to the Drive sidebar in your Previz.

## Drag files into Previz

1. In your Previz project navigate to the Drive content area.
2. Open or create a folder.
3. To upload files and folders, drag them into the Drive content folder.













Product X Launch

Overview **Content** Team Project Settings

+ Create 

Home

Sort: Newest

Name	Type	Uploader	Modified	File size	Options
 Sequences 4 Children	folder		3 minutes		...
 Scenes 2 Children	folder		3 minutes		...
 Images 2 Children	folder		4 minutes		...
 Textures 13 Children	folder		3 minutes		...
 previz_mappings_01.mp4	video		9 months	2.4MB	...
 wh_feed_all.png	image		9 months	120.1KB	...
 wh_direct_HR.png	image		9 months	12.6KB	...
 prop_6k_set3.jpg	image		9 months	783.1KB	...
 circ.png	image		9 months	10...	...
 grey.png	image		9 months	3.3...	...
 wh_direct_outer_HR.png	image		9 months	17...	...
 wh_direct_centre.png	image		9 months	52.9KB	...

Uploading 2 files

- downtown.mp4
- stars-at-elqui-valley.mov



Drag files

# Guest Accounts

## Guest Accounts

The Guest Accounts feature in [disguise Cloud](#) is designed to enable collaboration with a broader team within a structured and secure workspace. It provides sharing and interaction while maintaining control over access. Currently, guests using this feature do not have access to Previz or Mapping Matter

When you send an invitation to a guest, it grants them access to a specific designated folder, inclusive of all its sub-folders, on a single Drive.

The Guest Accounts feature is a useful tool for inviting external team members to collaborate within a controlled workspace, ensuring that they can access the necessary content while keeping sensitive materials secure.

To invite a guest to collaborate:

1. **Access Organisation Management:** From the Members tab in Organisation Management, click **Invite to Team**.

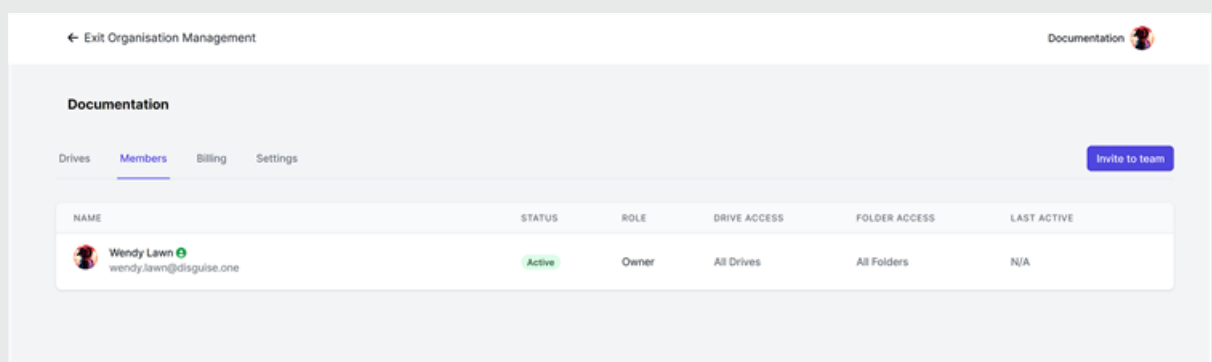

2. **Provide Guest Email:** Enter the email of the guest you wish to invite.
3. **Select Guest Role:** In the **Guest Role** section and choose the appropriate role for the guest based on the permissions they will need:



- **Reviewer:** Reviewers can leave comments and view assets but cannot modify them.
  - **Collaborator:** Collaborators can upload new content and edit existing assets within their designated folder but cannot leave comments.
4. **Select Drive Folder:** Click **Select Drive Folder** to specify the Drive and folder that the guest will access.
  5. **Confirm and Invite:** Click **Confirm** once you have entered the invitation details. Then, click **Invite** to send the invitation to the guest.

← Exit Organisation Management Documentation

**Documentation**

Drives Members Billing Settings

### Invite Team Members

Send email invites to your team members and start collaborating today.

Email

**Team Role**  
Select the role for your new team members.

**Admin**  
Full drive access, plus can invite and manage members.

**Guest Roles**  
Guests have limited access to your team but don't count towards seats.

**Reviewer**  
Reviewers users can view and comment on assets in a specific Drive's folder.

**Collaborator**  
Collaborators can upload and manage content in a specific Drive's folder.

Guests are given access to a single folder on a drive of your choosing. You can select the folder below.

6. **Email Notification:** The guest will receive an email notification containing a link to the designated Drive folder, allowing them to access and collaborate within that folder.

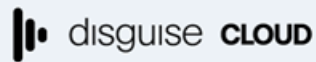

You have been invited by **Wendy Lawn** to join the **Documentation** organisation on disguise Cloud.

You have been invited to this organisation as guest on the Drive named **Documentation** with access to the **Guest Login** folder.

If you do not have a disguise Cloud account, you'll be prompted to sign up.

[Review the Invitation](#)

If you did not expect to receive an invitation to this organisation, you may discard this email.

© 2023 disguise cloud. All rights reserved.

7. **Plan Limitations:** Be aware of the limitations of your plan. Check the table provided to understand how many guests are permitted with each plan, as different plans may have varying guest access allowances.

The table below indicates how many guests are permitted with each plan:

Plan	Total no. of guests
Starter plan	3
Pro plan	10
Studio plan	25

For further role information, review the list below detailing permissions and limitations for guests, reviewers and collaborators.

Role permissions and limitations:

---

- Guests can't access your organisation management area.
- Guests can't access Smart Folders in Drive.
- Reviewers can view versions but can't add versions.
- Collaborators can add versions but they can't change the active version.
- Both reviewers and collaborators can view tags but can't add, edit, or remove them.
- Neither guest roles can lock assets.
- Neither guest roles can share assets.

# Video Specifications

## Automatic Transcoding

Previz automatically transcodes your media for optimal performance in the viewer.

We can also accept a range of common video formats.

## Video Formats

- MP4
- WebM
- MXF
- MPEG-2 TS container
- MPG
- fmp4
- FLV

## Supported Video Codecs

- H.264
- VP9
- VP8

- MPEG-2

## Not Supported

- HAP
- HAP-Q
- DXV

## Audio Codecs

- AAC
- MP3

## Recommended Video Specifications

- no larger than 8192 x 8192px
- h264 in a mp4 or quicktime container for the video
- aac or mp3 for audio

## Transparency

Transparency in videos is not supported.

We are limited by the technologies implemented by the web browser vendors. WebM (the open video format pushed by the Mozilla Foundation in Firefox and Google in Chrome) allows video with transparency, but it is not supported by Safari nor IE / Edge. There is no good cross browser technology available to us at the moment.

If you upload a video with a transparency layer, the transparent pixels will be rendered solid black in Previz.

# Previz



## About Previz

Previz is a flexible, user-friendly, pre-production workflow for transforming ideas into incredible experiences.

It's been conceived to improve the collaborative working environment and communication of different event professionals, wherever they may be.

It features:

- A direct connection to disguise drive, comprehensive Content Management System that supports images, videos, and sequences.
- A real-time interactive 3D Scene editor and viewer that supports textures, lighting and cameras.
- A feature rich Sequencer to combine and integrate 3D scene data, production images and video assets into a timeline.

- Shareable view pages to provide clarity and alignment, helping with the review and approval process of your project.

## Compatibility

To display 3D content in real-time we use WebGL, which is a standard in most modern browsers. You can check if your browser is compatible on <https://get.webgl.org/>

For more technical details about WebGL on your machine, see <https://webglreport.com>

## Desktop

Previz is compatible with the following browsers:

- Mozilla Firefox
- Google Chrome
- Opera
- Safari
- Edge

## Mobile

- iOS 8+
- Android 4.0
- Troubleshooting
- WebGL

If you run into problems in the 3d viewer, make sure your graphics driver and browser are up-to-date. If that doesn't help, try one of the other browsers listed above. <https://get.webgl.org/> is a good place to start troubleshooting.

Sometimes, your browser may disable WebGL based on your GPU. If you are using a compatible browser, but you see an incompatible warning or the viewer performs very badly, try forcing the browser to use your GPU:



## Chrome

Go to System Settings ( **chrome://settings/** → **Advanced** → **System** ) and make sure Use hardware acceleration when available is enabled.

Go to **chrome://flags/#ignore-gpu-blacklist** and enable the Override software rendering list flag.

In Firefox, type **about:config** into the address bar and enable **webgl.force-enabled**.

## Touch Screen / Tablets

Sometimes, navigating a model may not work on a touch screen or tablet device. This is especially common on certain Windows 10 devices. In Chrome, for example, visit **chrome://flags/#touch-events** and enable the "Touch Events API" flag.

# Getting Started

## Getting started with Previz

If you have signed up for [disguise Cloud](#), then you can get access to the web-based Previz application. If not, you can create a disguise Cloud account [here](#).

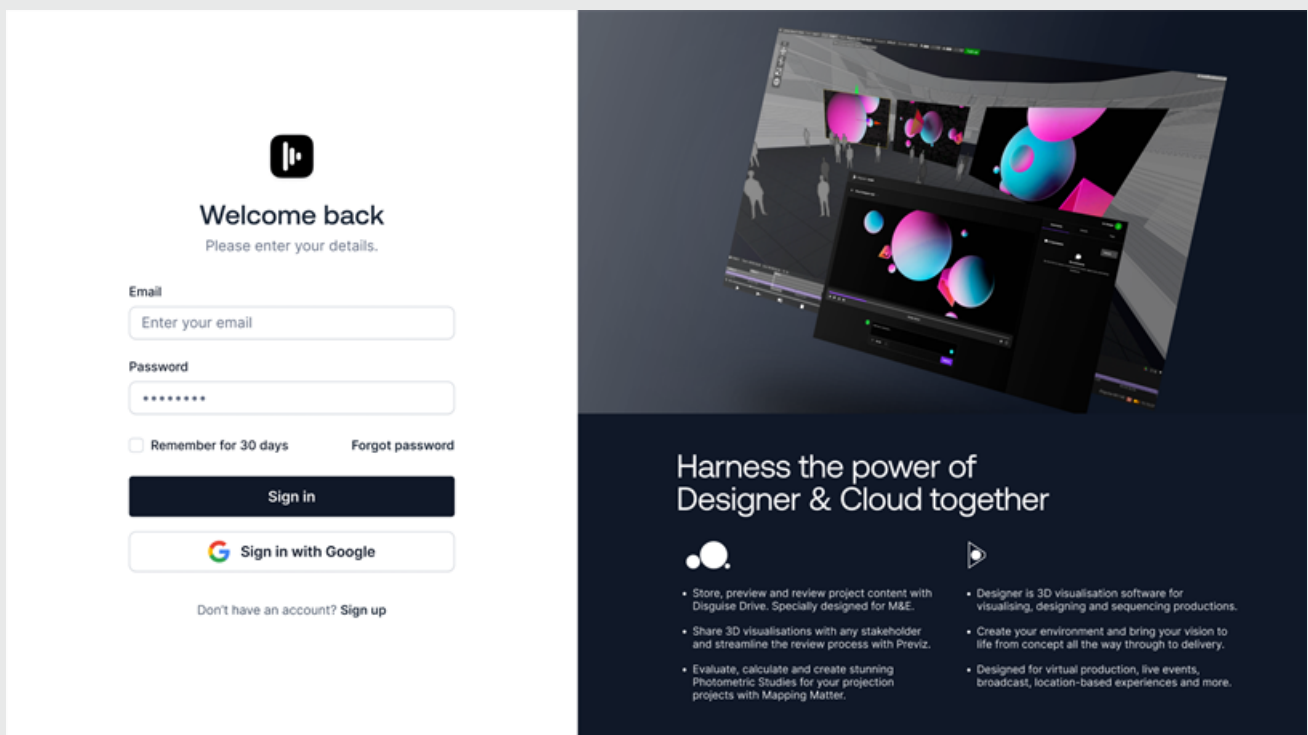

## Accessing Previz from Cloud

In Cloud Drive, you can create a new Previz project by clicking **New > New Previz**.

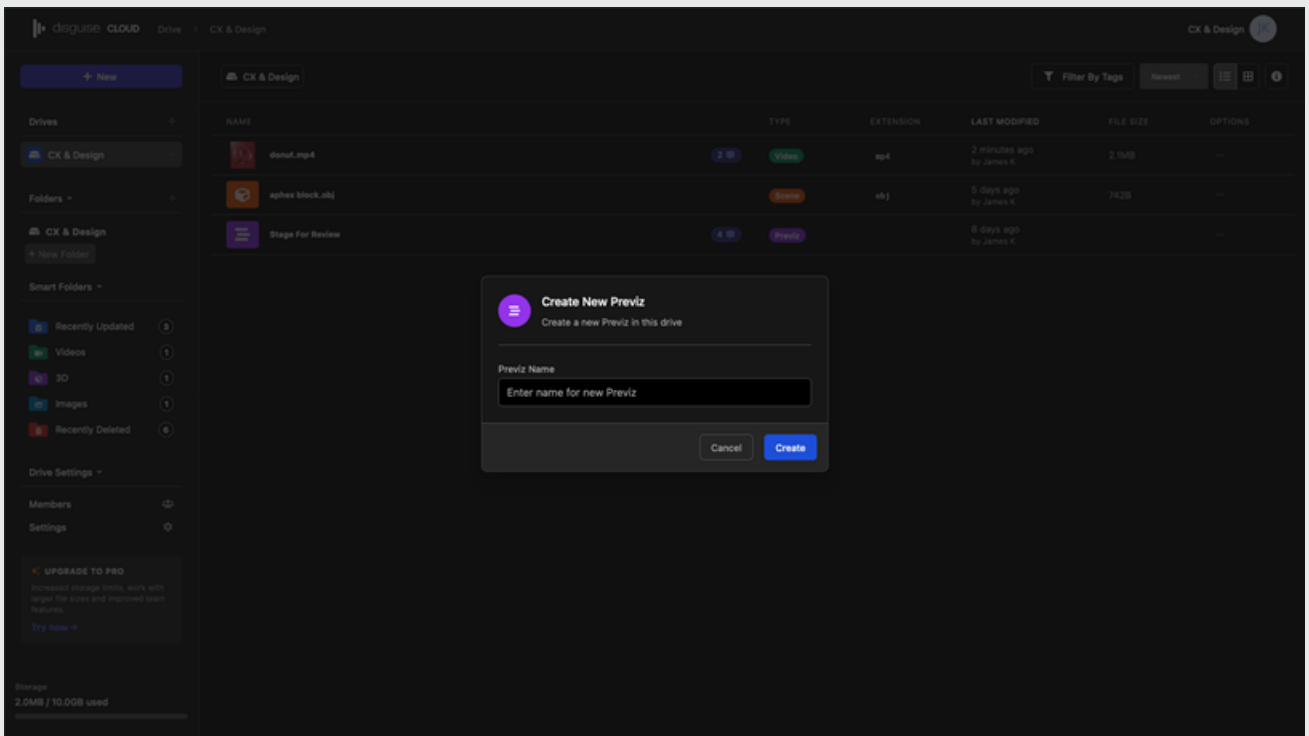
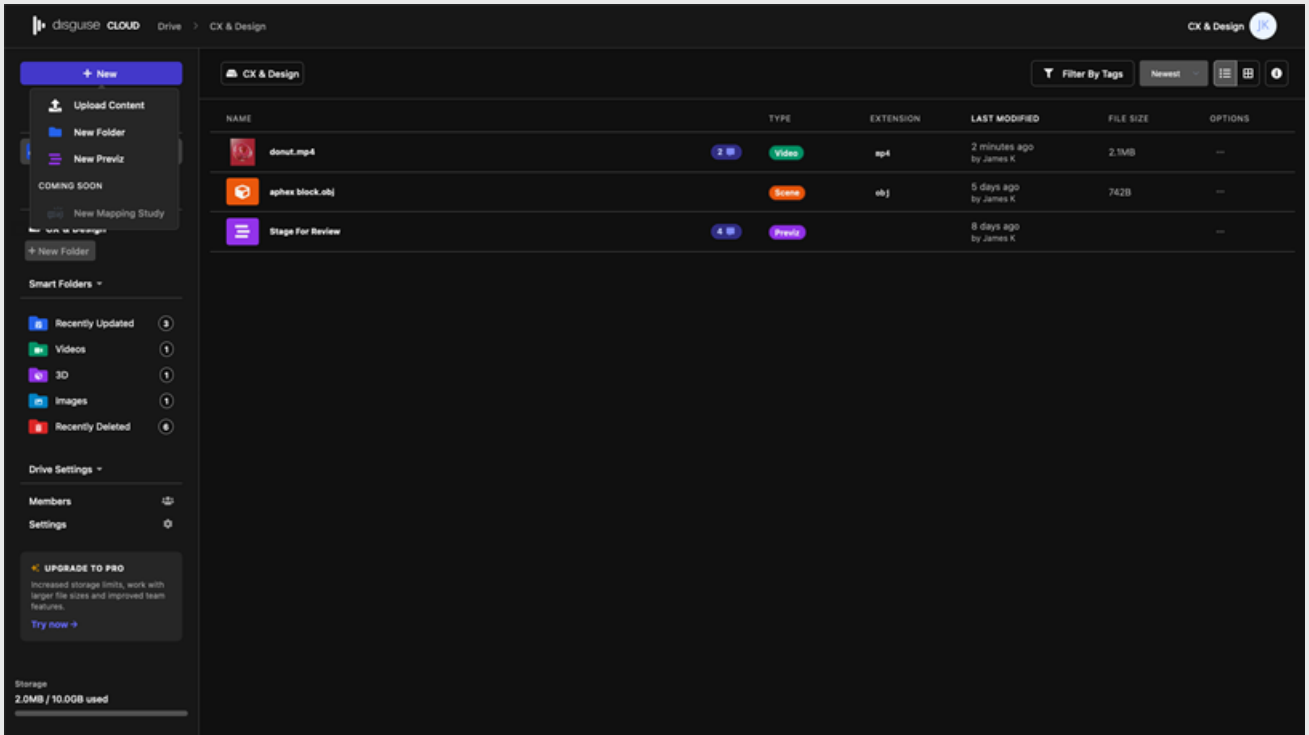

## Create a Previz link in Designer

1. From **d3manager**, sign in to your Cloud account.
2. Open your Designer project.
3. Right-click to open the **D3State** tab.
4. Select **Share to Previz**.

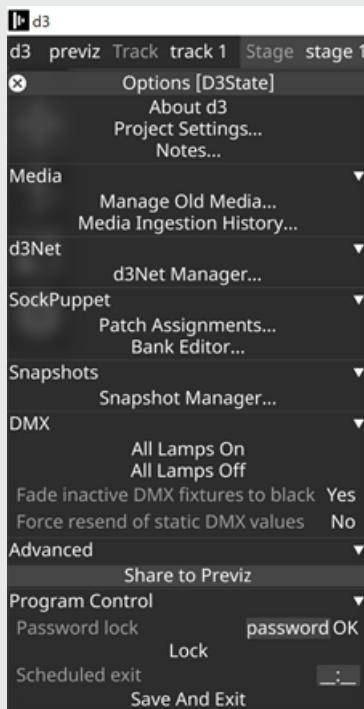

This will open a new widget with two tabs, **Export Location** and **Timeline**.

5. Select the export location which can be either a drive or an organisation.
6. Next, select the sequence on the timeline, hold down the shift key and left-click to drag over and select an area of the timeline.

The timeline export range will default to **whole timeline** if opened from the d3state tab or **selected portion** if opened by right-clicking on the selected area of the timeline.

7. Finally, select the option to export the scene to the Cloud. This will export the selected range as a video file to a temporary folder, and then automatically upload it to your Cloud Drive.
8. Once complete, navigate to the **Recently Updated** folder in drive. In the folder will be 3 files – a .glb model file, a video in WebM format, and a Share to Previz link which will take your Designer previsualization and enable you to share it with clients and collaborators.

# Navigating the Viewer

## Viewer Controls

- **Orbit** - To orbit around the scene click and drag with your mouse. If you are on a touch device pointing and dragging will have the same affect.
- **Pan** - To pan, right click and drag. Use two fingers on a touch device.
- **Zoom** - To zoom, scroll the mouse or pinch and zoom on a touch device.

# Creating a Previz

With Previz you can plan and preview your content in a real-time 3D environment.

Sequences in Previz can contain a range of different media including images, videos, 3d and scenes.

## Create a new Previz

To create a new Previz:

1. In the dropdown menu labelled "New" accessible from Drive select "New Previz" next to the team name in the team sidebar.

When you select this option you will then need to enter the name for your new project.

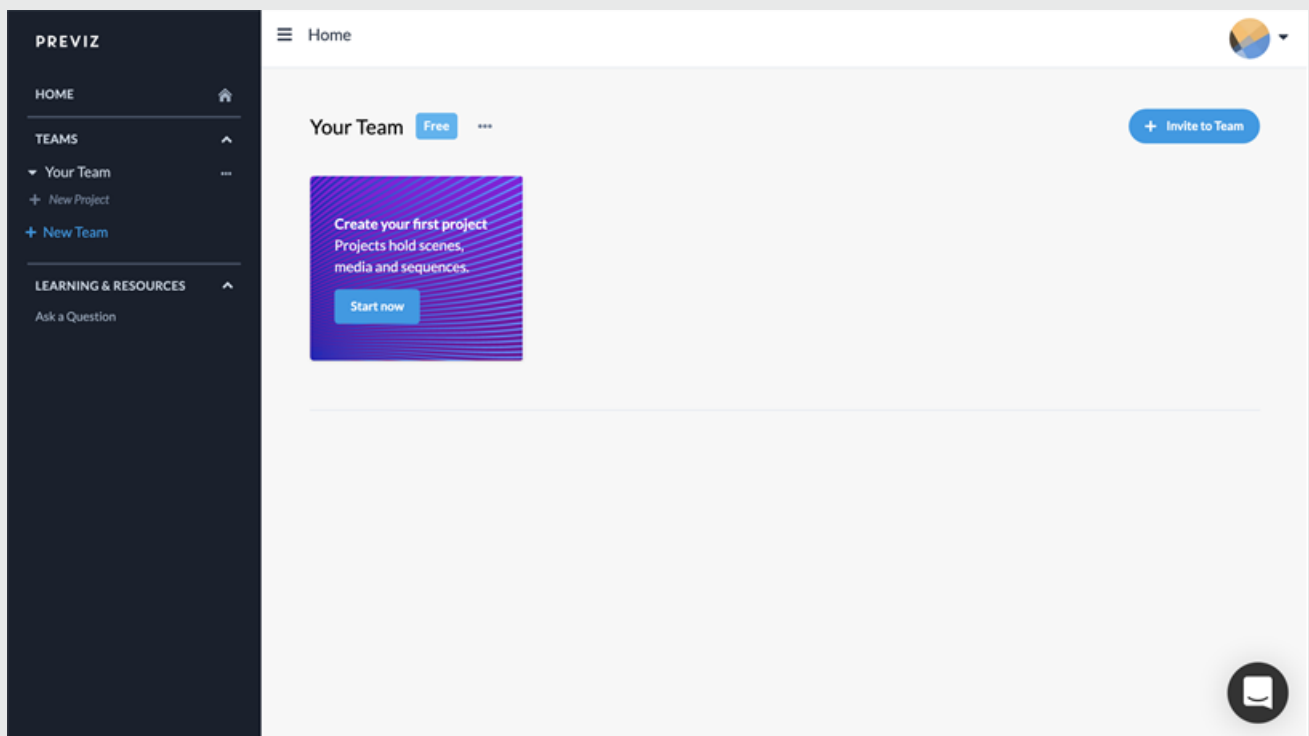

Create a Previz

# Renaming a Previz

## Renaming a Previz

1. Select the ellipsis in the main navigation next to the Previz sequence. From the dropdown menu select **Rename**. This will trigger a modal where you will be able to rename your project.

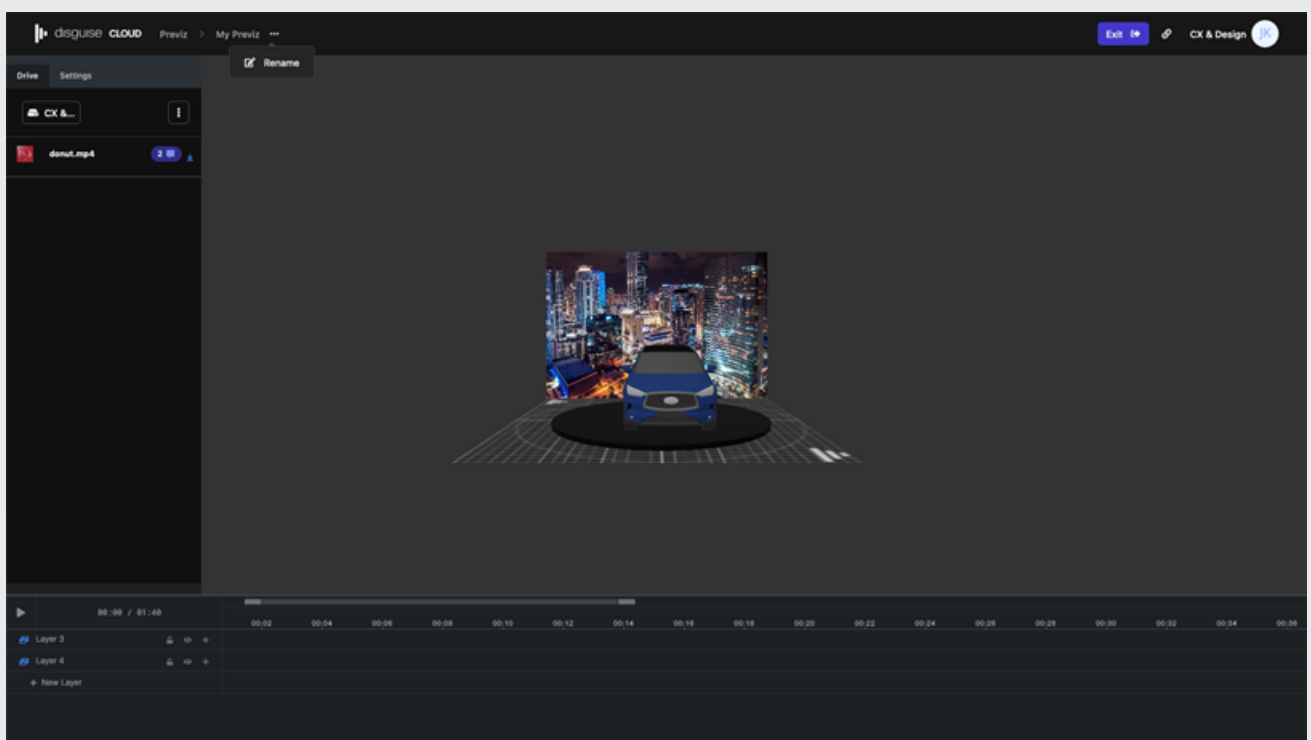

## Rename a Previz

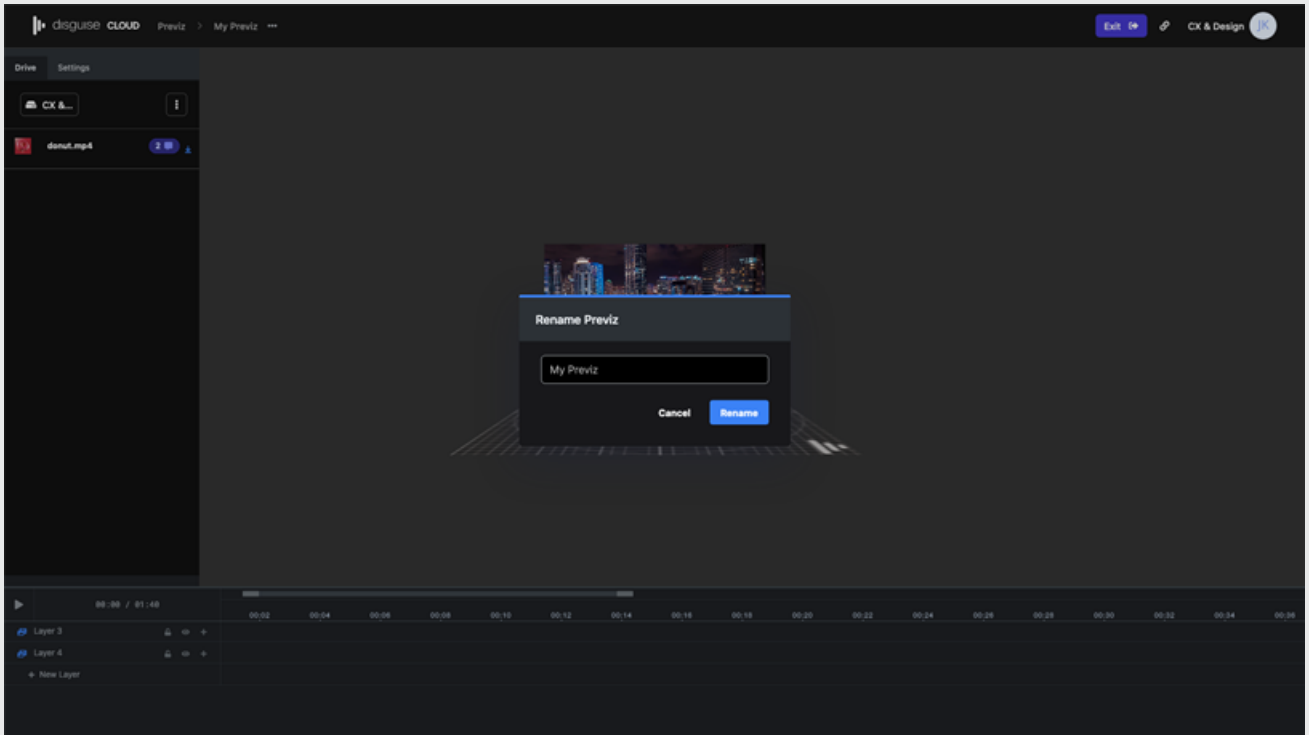

Rename a Previz



# View and Open Files

With Previz you can view content including videos, images and 3D scene files.

## View a file

In your Drive, when you open a scene or sequence, it will open in View Mode.

**Note:** there are two types of view modes for and sequences.

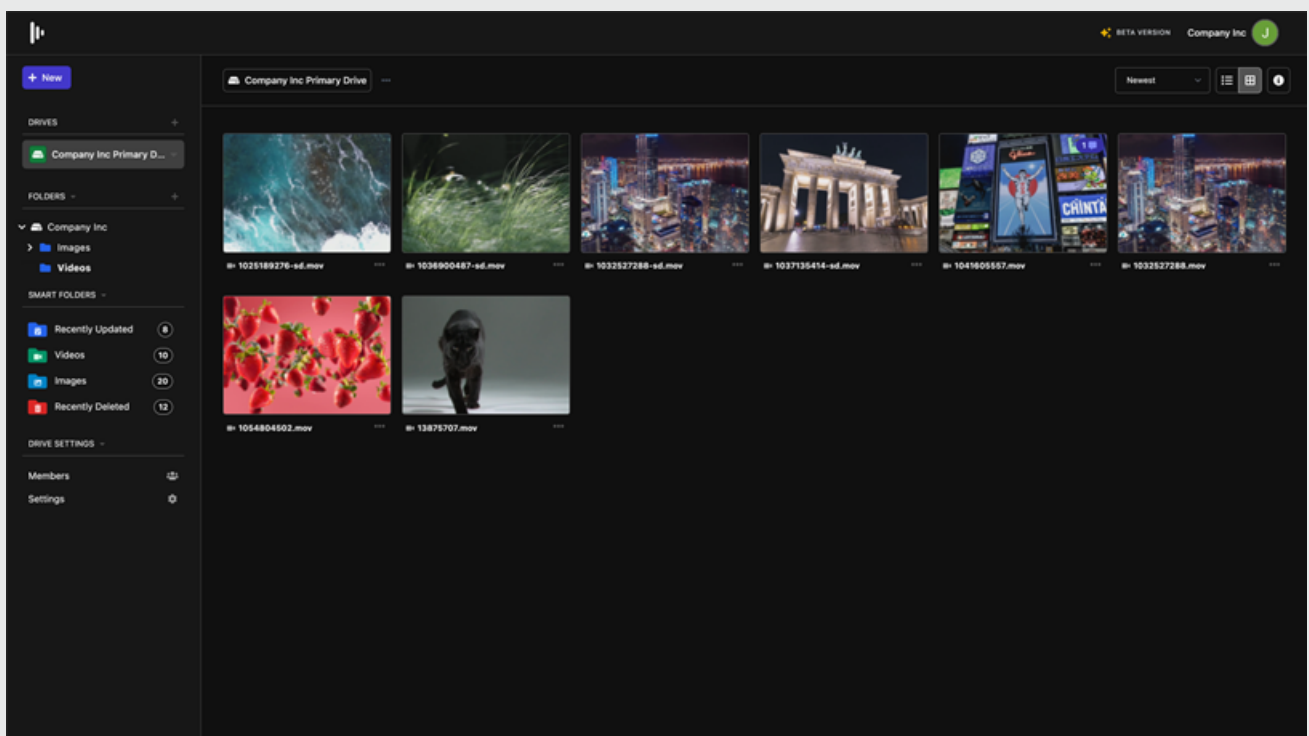

## Play Videos

To play your video:

1. Single-click a file.
2. Press the play icon in the play controls at the bottom of the video.
3. To play full-screen, in the bottom, click Fullscreen.

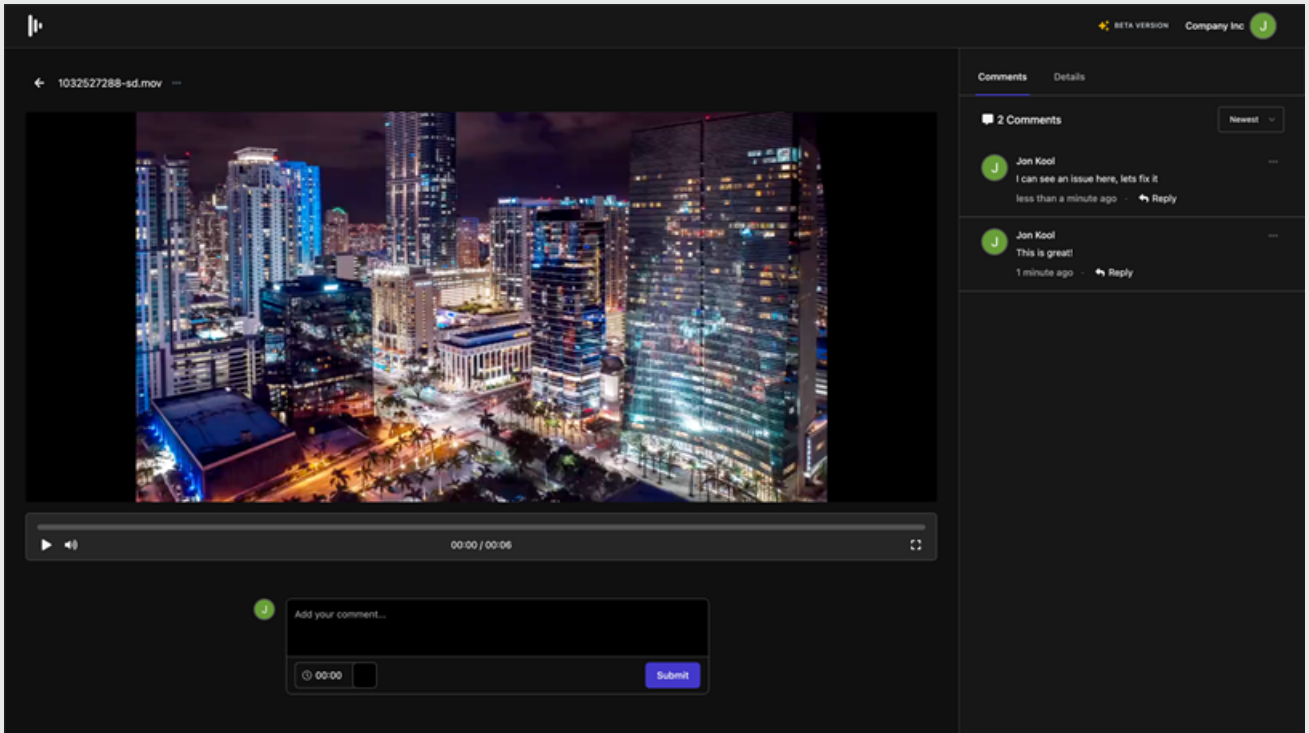

# View Modes

Sequences can be accessed by two different view modes - **view mode** and **edit mode**. You can switch between these modes when you are viewing a scene or sequence. You can access the view switcher in the **top right corner** is a view mode button to toggle between views.

## Preview Mode

Preview mode is a way of previewing your content or current published state. It is the same view external guests have when you share an item with them.

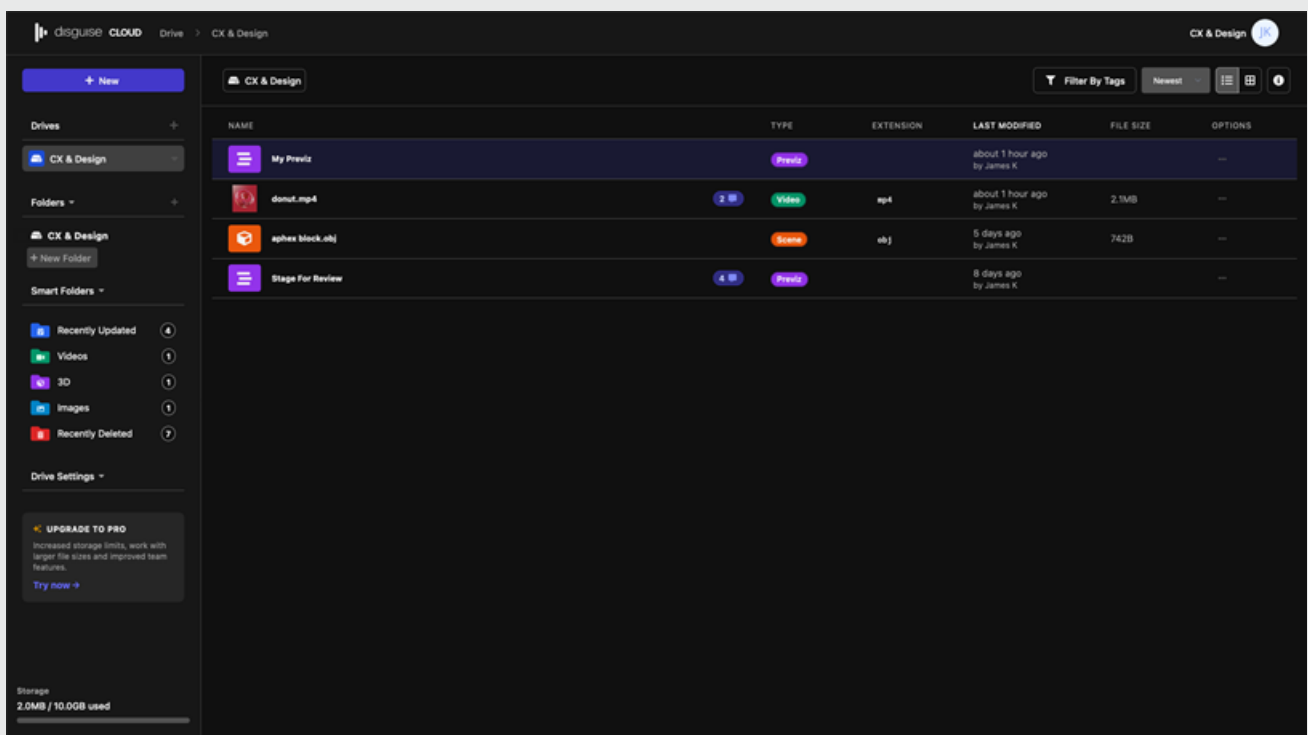

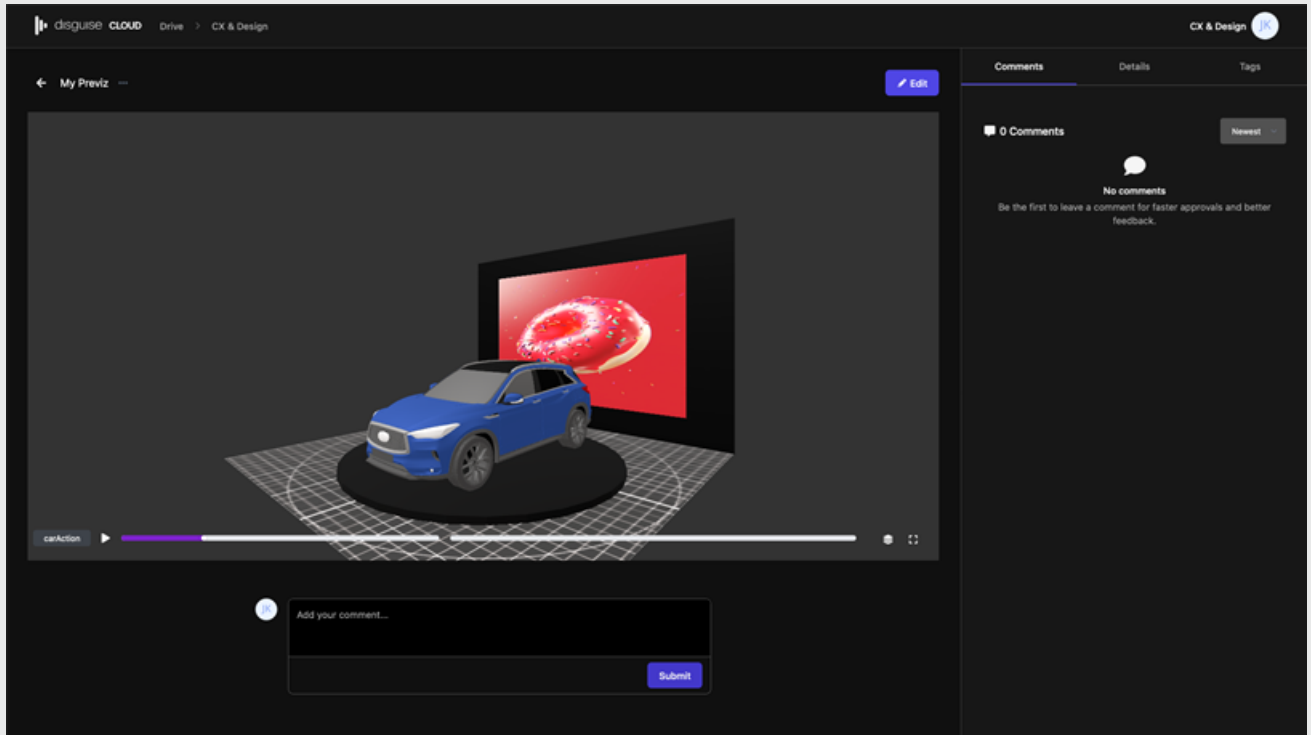

## Edit Mode

View mode is a way of previewing your content or current published state. It is the same view external guests have when you share an item with them.

**Note:** Your access to the Edit Mode is dependent on your team permission settings.

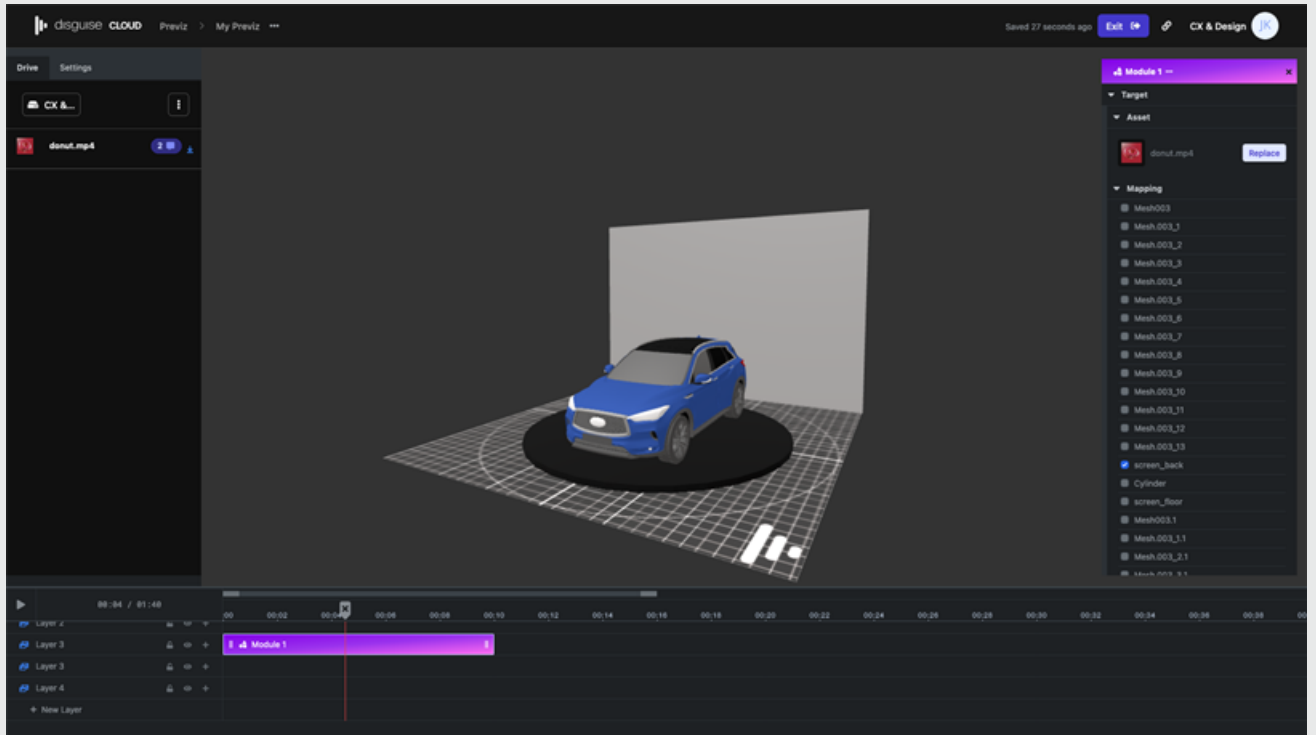

# Scenes

Upload your scenic data and share with unlimited guests for review and approval. Guests can interact with your scene directly in their browser.

Scenes are a way to present set designs and geometry. Each scene file can contain data such as objects and materials as well as lights and cameras. These scenes first need to be created in your 3D program of choice.

## General Considerations

- We support **.glb** files (.glb is the binary version of the glTF 2.0 file format).
- Your .glb must be under 20MB in total. The smaller the better.
- Strip out unused data whenever possible. Unused vertex colors, UV's, etc. all add to the file size.
- Use PNG or JPEG files for textures.
- Use JPEG files unless you need transparency. This will make your files much smaller.
- Textures must be power-of-2 in each dimension (512x1024 for example).
- Textures can be up to 4k, but try to keep them under 2k.
- Once you have a **.glb** file, you can just drag it into the content area, pick a background color and share it.

## Reference Links

- [Blender glTF reference](#)
- [Cinema 4D reference](#)

## Concierge Service

If you need help converting your model including point clouds, CAD models or laser scans consider using our concierge service. Previz has backed by a team of event professionals with more than a decade of experience working in the live events sector. Supported by a team of 3D artists and developers, we can create your Previz project for you, including optimizing your model, creating content templates and training your team. Please contact [info@previz.co](mailto:info@previz.co) for more information.

# Editing Scenes

## Global Settings

Previz offers you a convenient way to tweak your basic model settings including lighting and positioning to make sure your model is rendered exactly the way you want it. These options can all be controlled in the Viewer tab in the scene editor. Changes are rendered in real time and saved automatically.

## Illumination

The illumination field allows you to edit the lighting exposure for the scene.

**Note:** This is independent of any lights you may have within your scene.

To edit the lighting exposure:

1. In the content view pick the scene you wish to edit.
2. Whilst in edit mode in the sidebar navigate to the Viewer tab and then the World sub-tab.
3. In the Illumination field adjust the lighting exposure by either clicking and adjusting the slider or by editing the number input field.

**Note:** The slider adjusts a range from 0 to 2. The number input will allow any value.



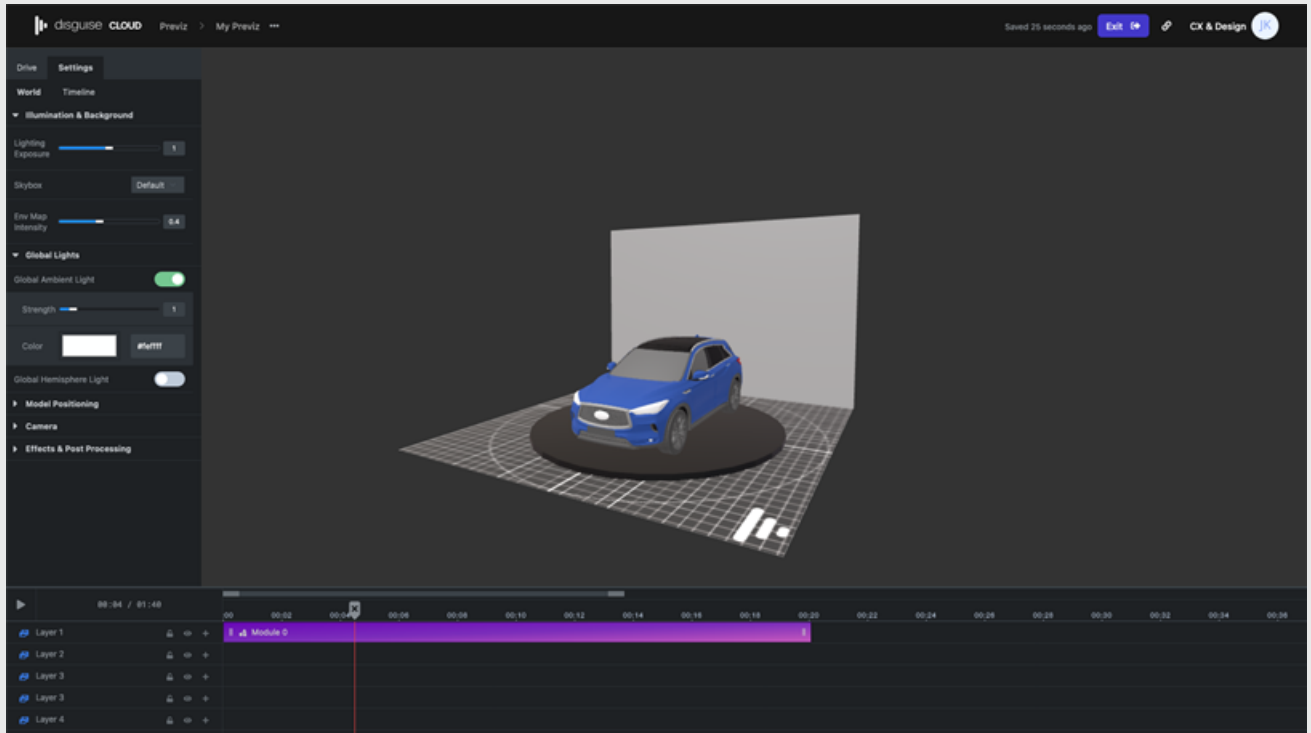

Illumination & background

## Global Lighting

There are two lights added to every scene by default.

1. Global Ambient Light
2. Global Hemisphere Light

It is up to you whether to use these or not. If you have setup lighting in your imported 3D scene it is likely that you will want to turn both of these off.

## Global Ambient Light

This light globally illuminates all objects in the scene equally. This light cannot be used to cast shadows as it does not have a direction.

1. In the content view pick the scene you wish to edit.
2. Whilst in edit mode in the sidebar navigate to the **Viewer** tab and then the **World** sub-tab.

3. In the Illumination field adjust the lighting exposure by either clicking and adjusting the slider or by editing the number input field.

## Global Hemisphere Light

1. In the content view pick the scene you wish to edit.
2. Whilst in edit mode in the sidebar navigate to **Settings**.
3. In the Illumination field adjust the lighting exposure by either clicking and adjusting the slider or by editing the number input field.

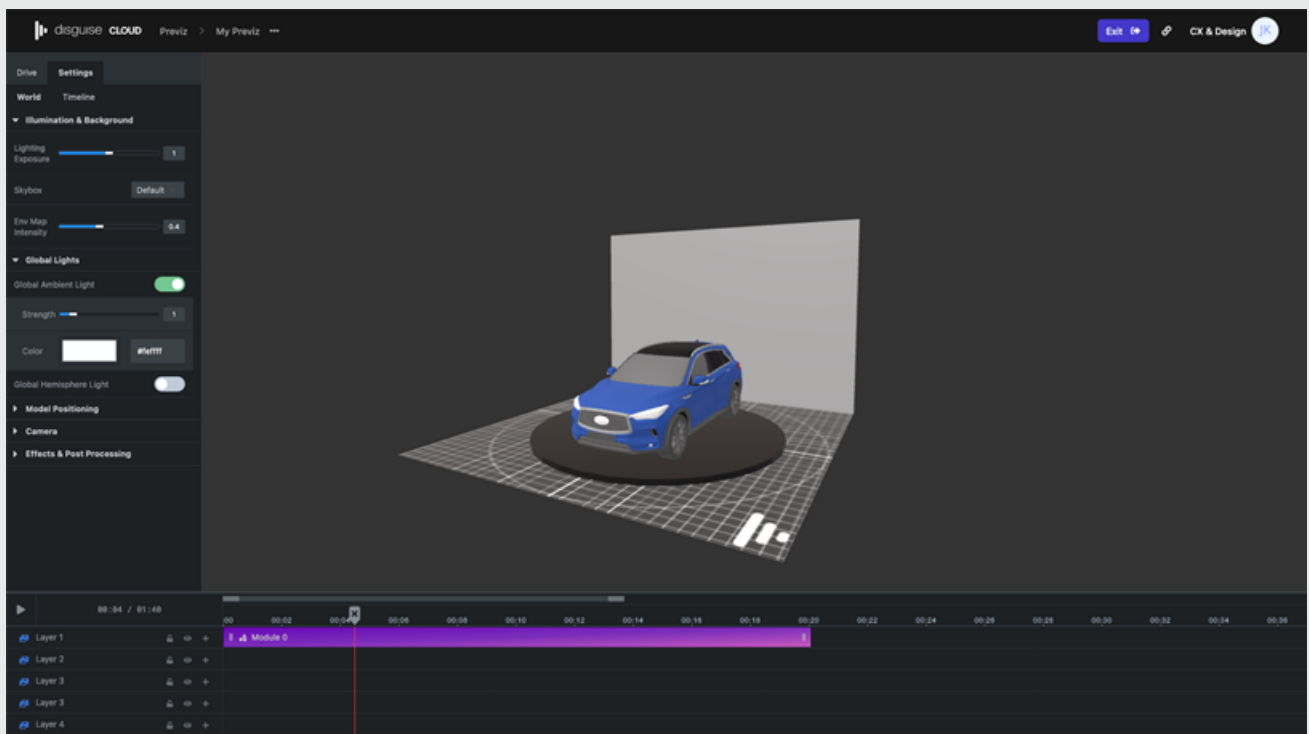

Global lights and illuminations

## Model Positioning

There are three ways in which you can edit your model position.

1. World Scale
2. World Position
3. World Rotation

## World Scale

Editing **World Scale** allows you to set the relative scale of your model in relation to the world space.

To edit the world scale:

1. In the content view pick the **scene** you wish to edit.
2. Whilst in edit mode in the sidebar navigate to the **Viewer** tab and then the **World** sub-tab.
3. In the **World Scale** field adjust the scale by either clicking and adjusting the slider or by editing the number input field.

**Note:** The slider adjusts a range from 0 to 2. The number input will allow any value.

## World Position

Editing **World Position** allows you to adjust the XYZ coordinates.

To edit the world position:

1. In the content view pick the **scene** you wish to edit.
2. Whilst in edit mode in the sidebar navigate to the **Viewer** tab and then the **World** sub-tab.
3. In the **World Position** field adjust the coordinates by entering your desired values in the number fields.

**Note:** You can also adjust these input fields by clicking and dragging.

## World Rotation

Editing **World Scale** allows you to set the relative scale of your model in relation to the world space.

To edit the world scale:

1. In the content view pick the **scene** you wish to edit.
2. Whilst in edit mode in the sidebar navigate to the **Viewer** tab and then the **World** sub-tab.
3. In the **World Rotation** field adjust the coordinates by entering your desired values in the number fields.

**Note:** You can also adjust these input fields by clicking and dragging.

## Set to Defaults

To reset the model position click **set to defaults**.

# Camera Bookmarks

Camera bookmarks let you save the current viewing angle and position of the viewport. These bookmarks are saved and can then be accessed in the view page.

## Add Camera Bookmark

1. Open a sequence file in edit mode.
2. In the scene sidebar, in the viewer tab, select the "**Bookmarks**" sub-tab.
3. Position your viewer to the desired viewing angle and position.
4. Click "+ New Bookmark".

You can set as many bookmarks as you wish.

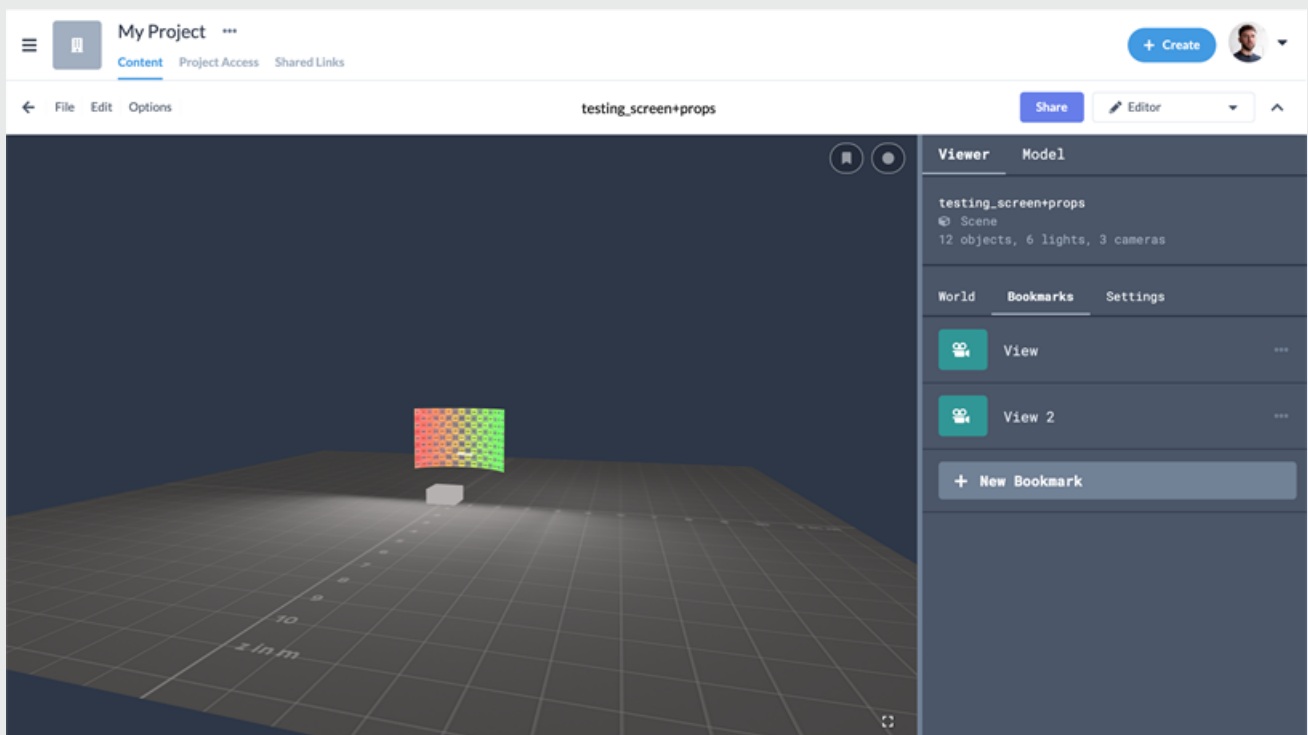

Creating a camera bookmark

## Edit Camera Bookmark Name

1. In the scene sidebar, in the viewer tab, select the "**Bookmarks**" sub-tab.
2. Identify the bookmark you wish to rename.
3. Click the ellipsis button to the right of the bookmark name.
4. Select "Rename".
5. Enter the new name in the modal.
6. Press "Rename".

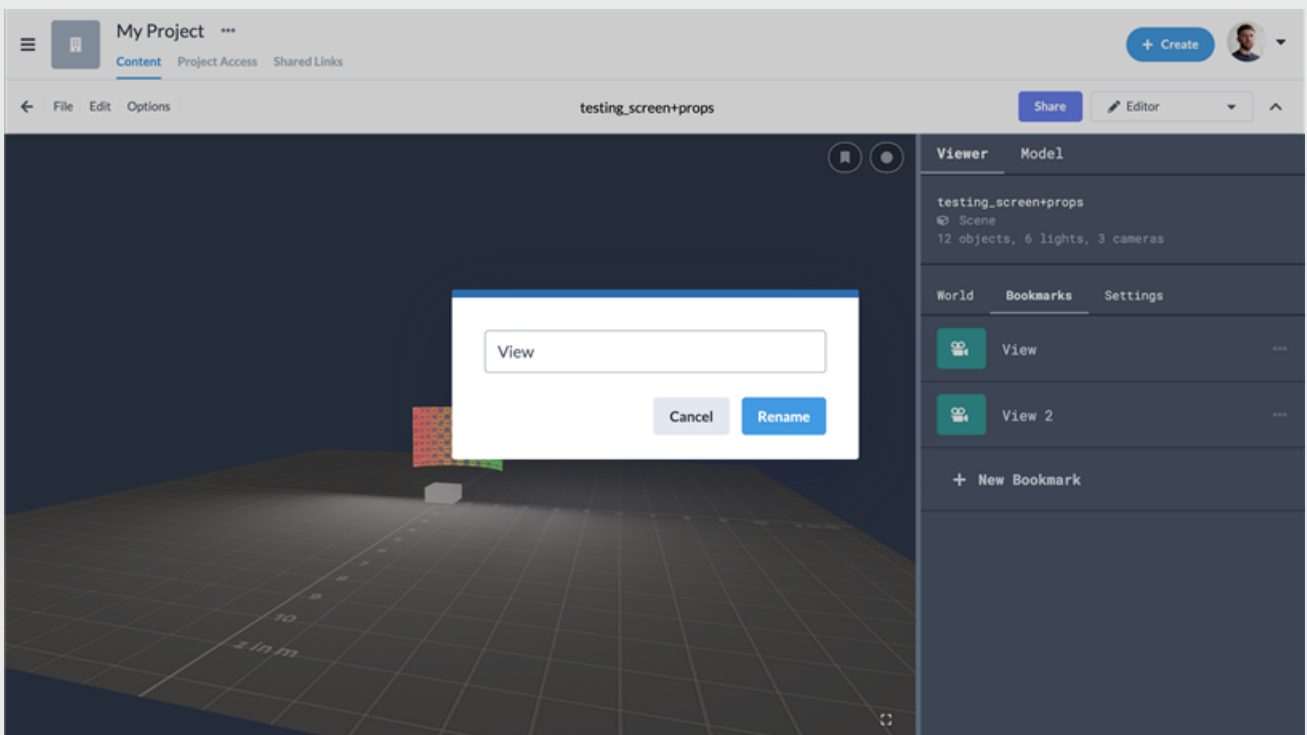

Renaming a bookmark

## Remove Camera Bookmark

1. In the scene sidebar, in the viewer tab, select the "**Bookmarks**" sub-tab.
2. Identify the bookmark you wish to rename.

3. Click the ellipsis button to the right of the bookmark name.
4. Select "Rename".
5. Enter the new name in the modal.
6. Press "Rename".

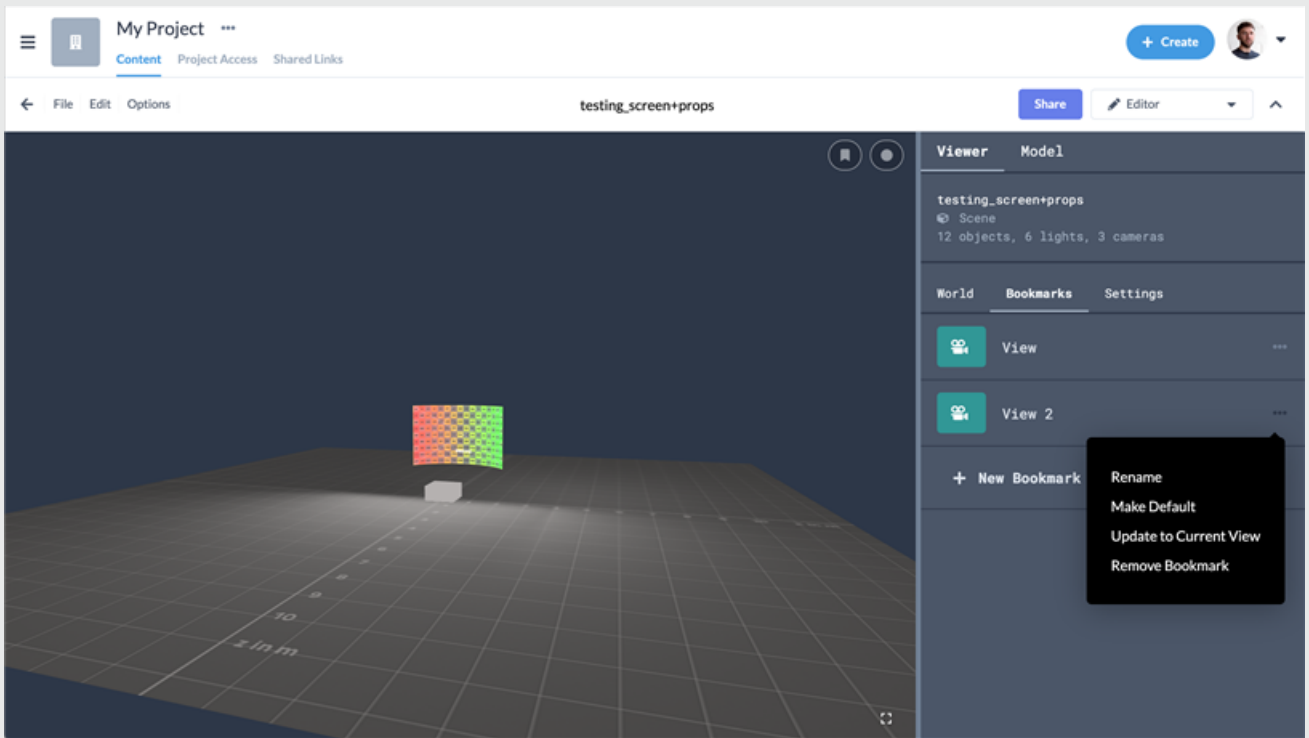

Deleting a bookmark

# Preparing Scenes

## Preparing Scenes for Upload

The Previz platform is optimised to use the glTF (GL Transmission Format) 3d file format.

glTF reduces the size of 3D models and the runtime processing needed to unpack and render those models.

## glTF Feature Support

The Previz platform supports the following glTF 2.0 features:

- Meshes
- Materials (Principled BSDF) and Shadeless (Unlit)Textures
- Cameras
- Punctual lights (point, spot, and directional)
- Animation (keyframe, shape key, and skinning)

## Checklist before exporting to Previz

- Make sure geometries from CAD / LIDAR files have:
  - » No orphan vertices
  - » Only manifold objects



- » No inner faces
- Objects are logically regrouped into single meshes
- Each mesh has an unique name
- UV sets are properly named:
  - » Mapping unique to a single mesh have an unique name
  - » Mappings shared between several meshes have the exact same name
- A nice props look is baked into a texture

After checking these points, the scene is ready to be exported to Previz.

# Uploading 3D Models

Uploading 3D models to Previz is quick and easy. There are two ways to upload 3D models - either by dragging them from a folder anywhere onto the project or by clicking **Create > Scene** from the top right of your project.

**Note:** At present we only support files in .glb format.

Once you have your file(s) ready:

1. Navigate to the content view within your Previz project.
2. Click **Create > Scene** (or drag & drop on any content page)
3. Click **Choose File** and navigate to the file on your device
4. Click **Continue**.
5. Once the transfer is complete, click the item in the content view page to go to your new model.

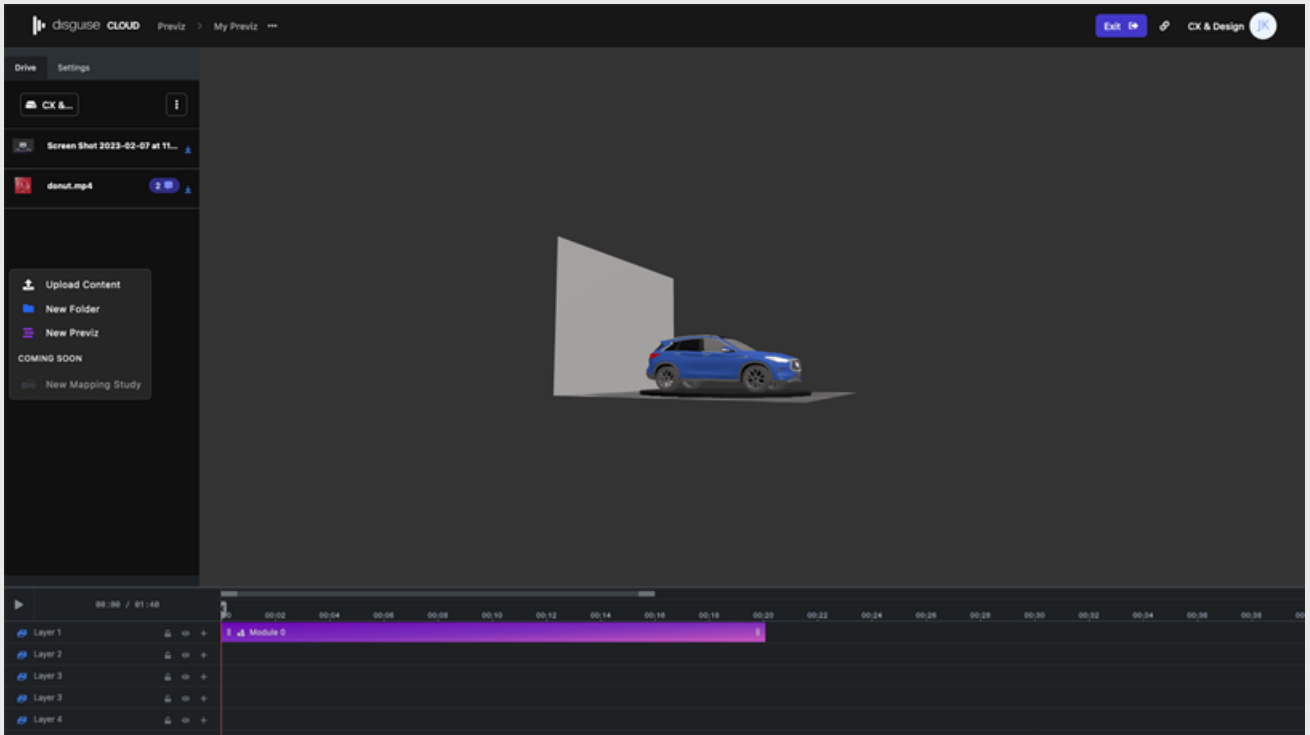

Uploading a 3D model via file system

# Exporting .glTF files from Blender

## To export from Blender

- go to **File > Export > glTF 2.0 (.glb/.gltf)**

## File Format Variations

The glTF specification identifies different ways the data can be stored. To export for the Previz platform:

- Select glTF Binary (.glb)

This produces a single .glb file with all mesh data, image textures, and related information packed into a single binary file.

## Include

If you want to export your entire scene make sure that Selected Objects is **not checked**.

## Transform

This option should be selected by default. Ensure it is to export your file using the glTF convention, +Y up.

## Geometry

Make sure all options are selected by default.

## Animation

glTF allows multiple animations per file, with animations targeted to particular objects at time of export. To ensure that an animation is included, either (a) make it the active Action on the object, (b) create a

---

single-strip NLA track, or (c) stash the action.

## Supported

Only certain types of animation are supported:

- Keyframe (translation, rotation, scale)
- Shape keys
- Armatures / skinning

Animation of other properties, like lights or materials, will be ignored.

## Default Options

The following image shows default options for a scene file with cameras, lights and animation included.

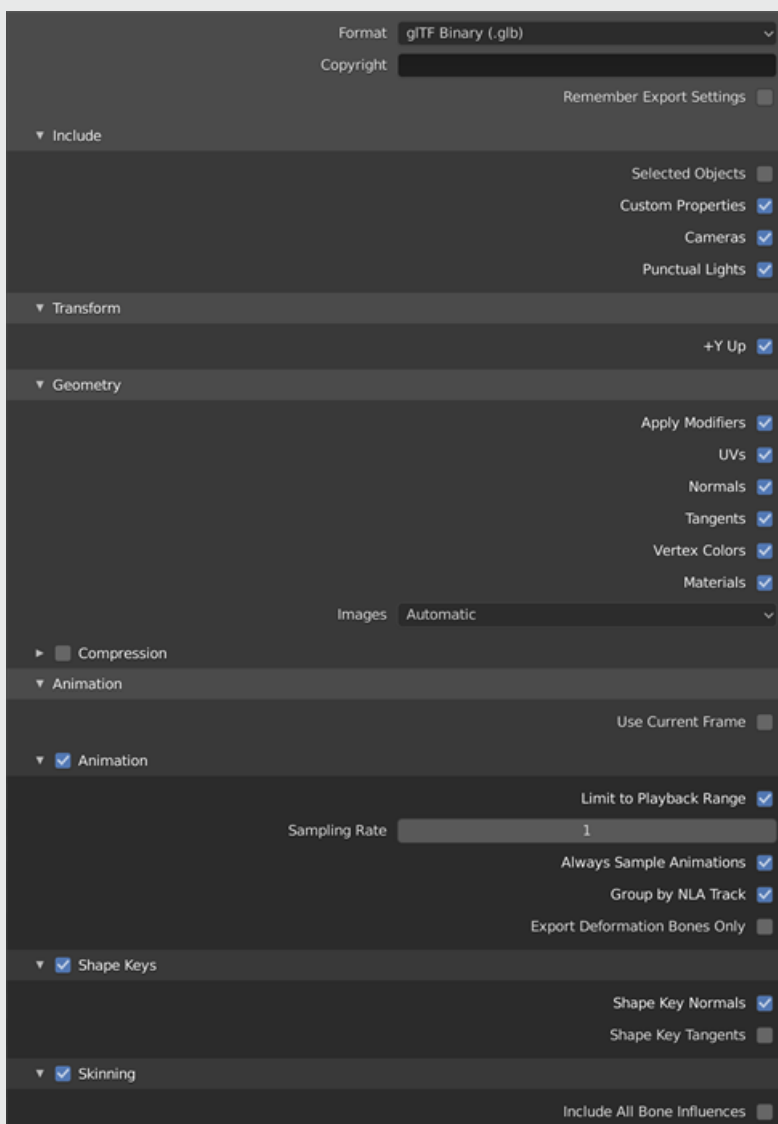

# Reference Links

- [Blender glTF reference](#)

# Creating a Share Link

You can share specific files (including scenes and sequences) with external guests such as clients or project stakeholders.

Creating a share link enables these users outside your team to be able to view your files.

There are two ways to create a share link:

1. From the edit mode of an item.
2. From the view mode of an item.

## Create a Share Link in View Mode

1. Navigate to the content view within a project.
2. Select the asset you want to share to open it.
3. In the sidebar click "Create Link".
4. In the modal that opens you'll have the option to add a title.
5. Next you'll need to enable link sharing for the asset. You can do this by toggling the enable option or clicking the "Enable Link Sharing" button.
6. This will generate a link that you can copy.

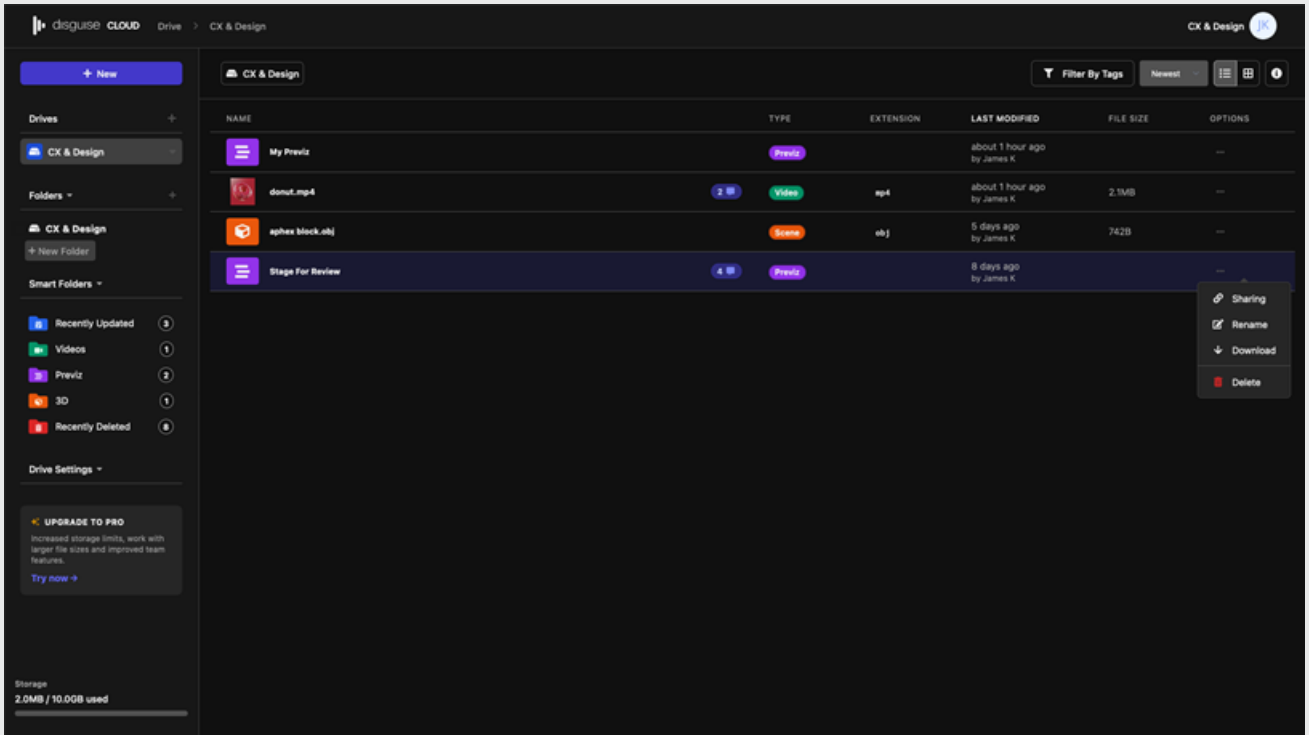

Select the asset to share

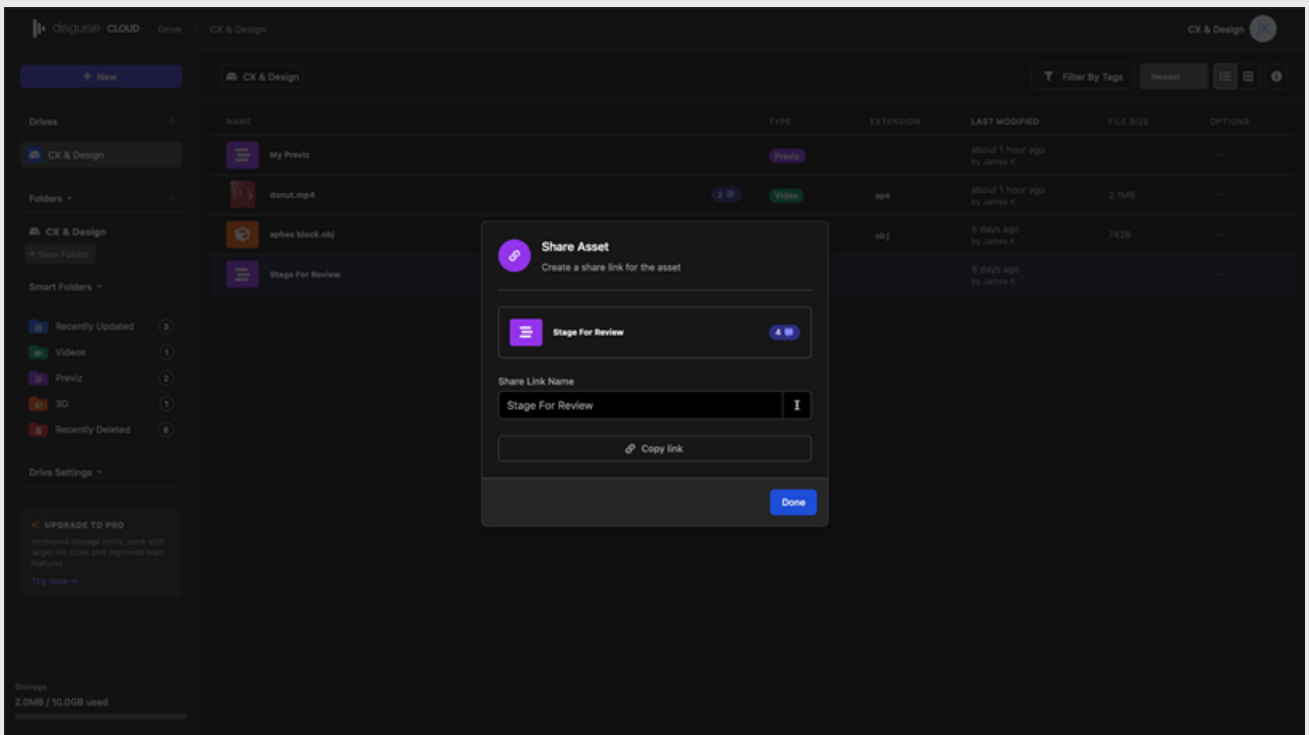

Confirm the share link name



# Video Specifications

## Automatic Transcoding

Previz automatically transcodes your media for optimal performance in the viewer.

We can also accept a range of common video formats.

## Video Formats

- MP4
- WebM
- MXF
- MPEG-2 TS container
- MPG
- fmp4
- FLV

## Supported Video Codecs

- H.264
- VP9
- VP8

- MPEG-2

## Not Supported

- HAP
- HAP-Q
- DXV

## Audio Codecs

- AAC
- MP3

## Recommended Video Specifications

- no larger than 8192 x 8192px
- h264 in a mp4 or quicktime container for the video
- aac or mp3 for audio

## Transparency

Transparency in videos is not supported.

We are limited by the technologies implemented by the web browser vendors. WebM (the open video format pushed by the Mozilla Foundation in Firefox and Google in Chrome) allows video with transparency, but it is not supported by Safari nor IE / Edge. There is no good cross browser technology available to us at the moment.

If you upload a video with a transparency layer, the transparent pixels will be rendered solid black in Previz.

# Mapping Matter Introduction

## Introduction

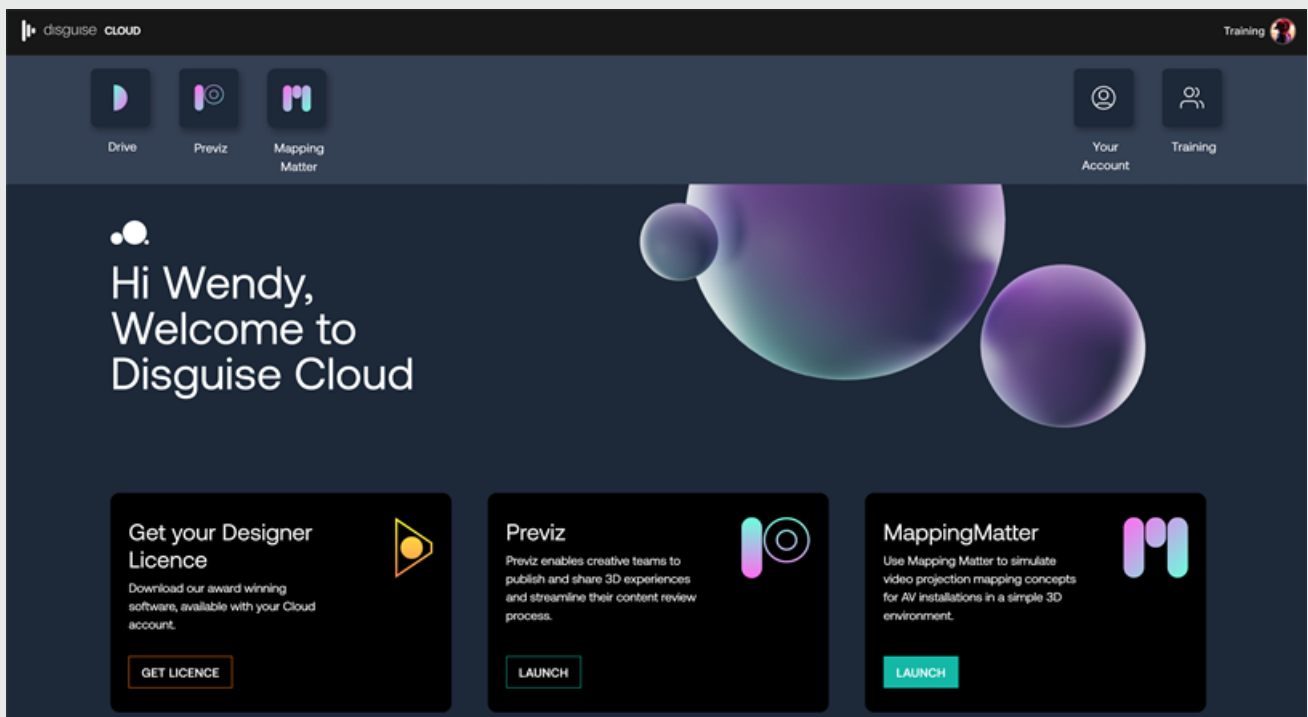

## How it works

### Data

This platform is web-based. Nothing to install / download / update / store.

All of our Data is stored on the Amazon Web Services Cloud.

### Supported Browser

We only support Google Chrome.

# OS

The platform works on both Mac and PC.

# API

We use WebGL.

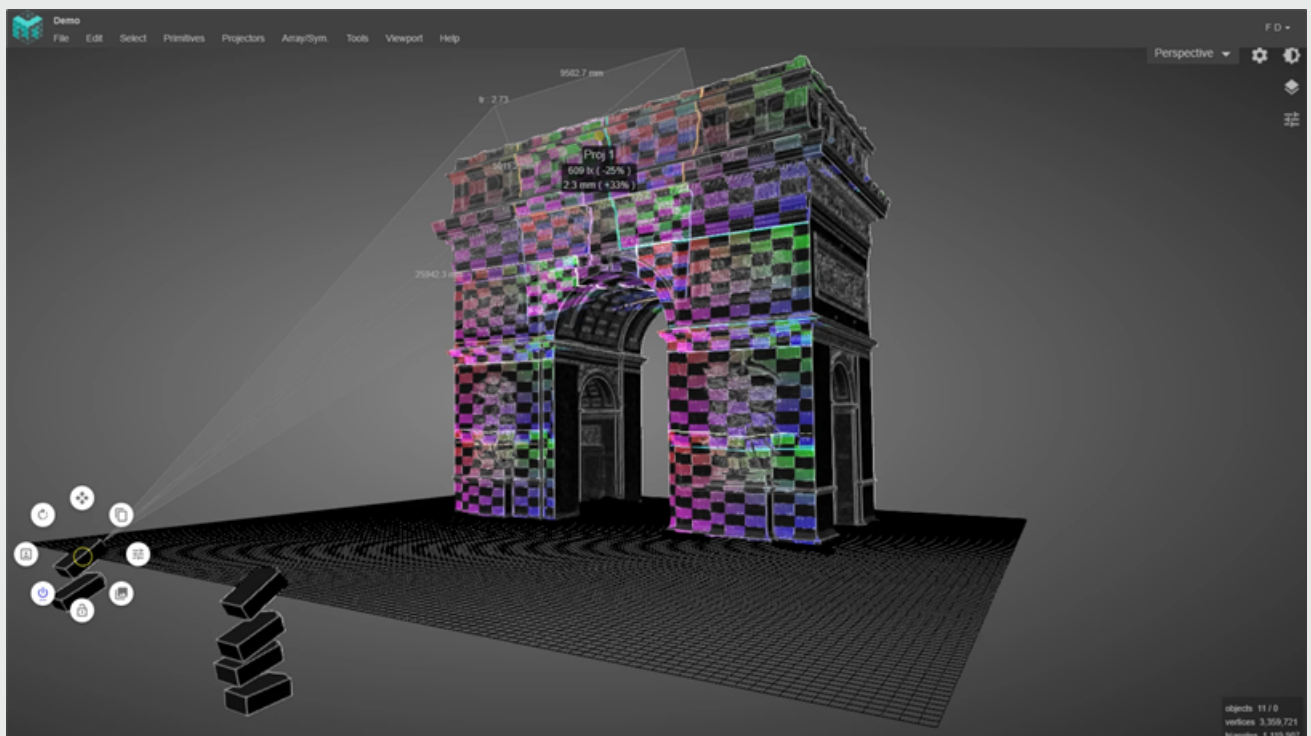

Who is Mapping Matter for/not for?

Who is it for?

Mapping Matter is a simulation tool designed for audio visual professionals such as Projectionnists, Technical Designers, Set Designers, Content Creators, Sales Team Members.

It will help them creating Projection Specs and Recommendations for large-scale projects (Shows, Permanent Installations, Building Projection Mapping, etc).

Mapping Matter provides fast, easy, enjoyable and highly comprehensible solutions to :

- Confirm budget estimates,
- Iterate on complex Projector placements,
- Work out Contrast Ratios (Photometric Analysis),
- Preview still Images and small Video clips on 3D Objects,
- See Projection Shadows on the Set,
- Measure Pixel Density (down to a single pixel),
- Share Client / Team Presentations,
- Define Media Server Output needs (with Convergence Simulation).

## Who is it not for?

Mapping Matter is not intended for Content Creation and/or Video Playback. However it is possible to preview still Images and small .mp4 Clips on 3D Objects.

# Mapping Matter Introduction

## Introduction

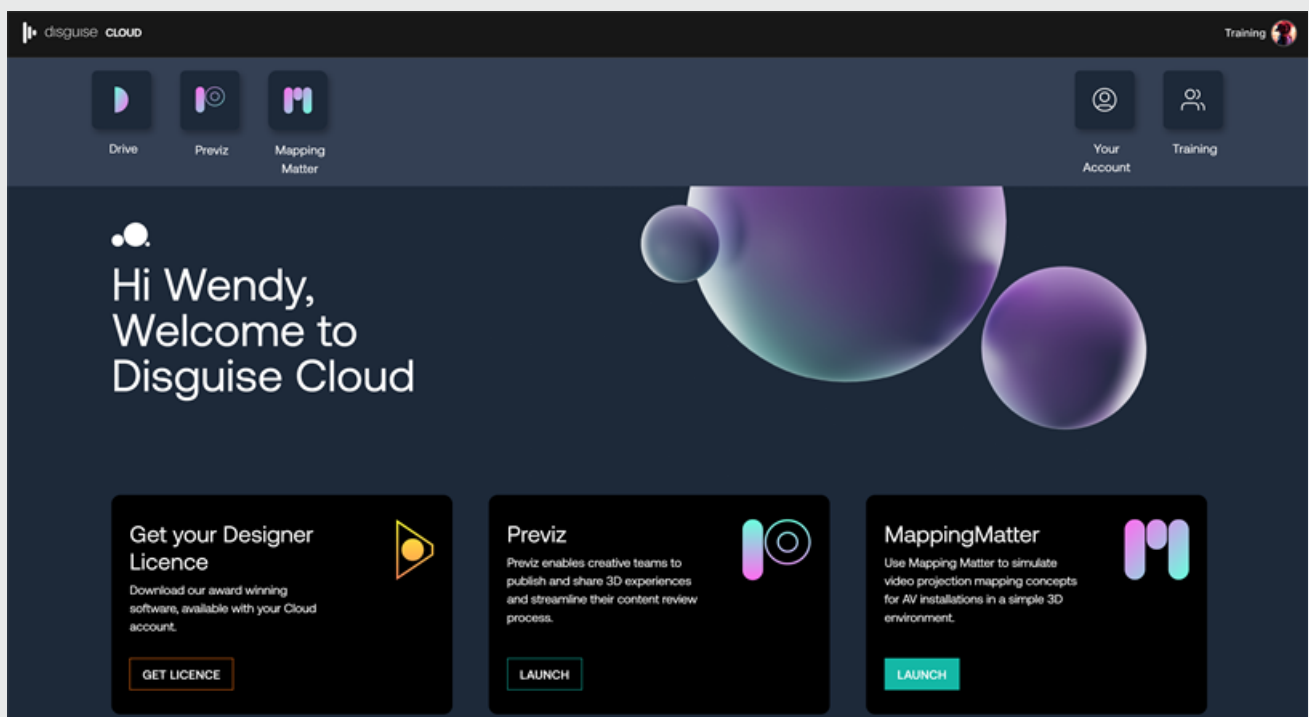

## How it works

## Data

This platform is web-based. Nothing to install / download / update / store.

All of our Data is stored on the Amazon Web Services Cloud.

## Supported Browser

We only support Google Chrome.

## OS

The platform works on both Mac and PC.

# API

We use WebGL.

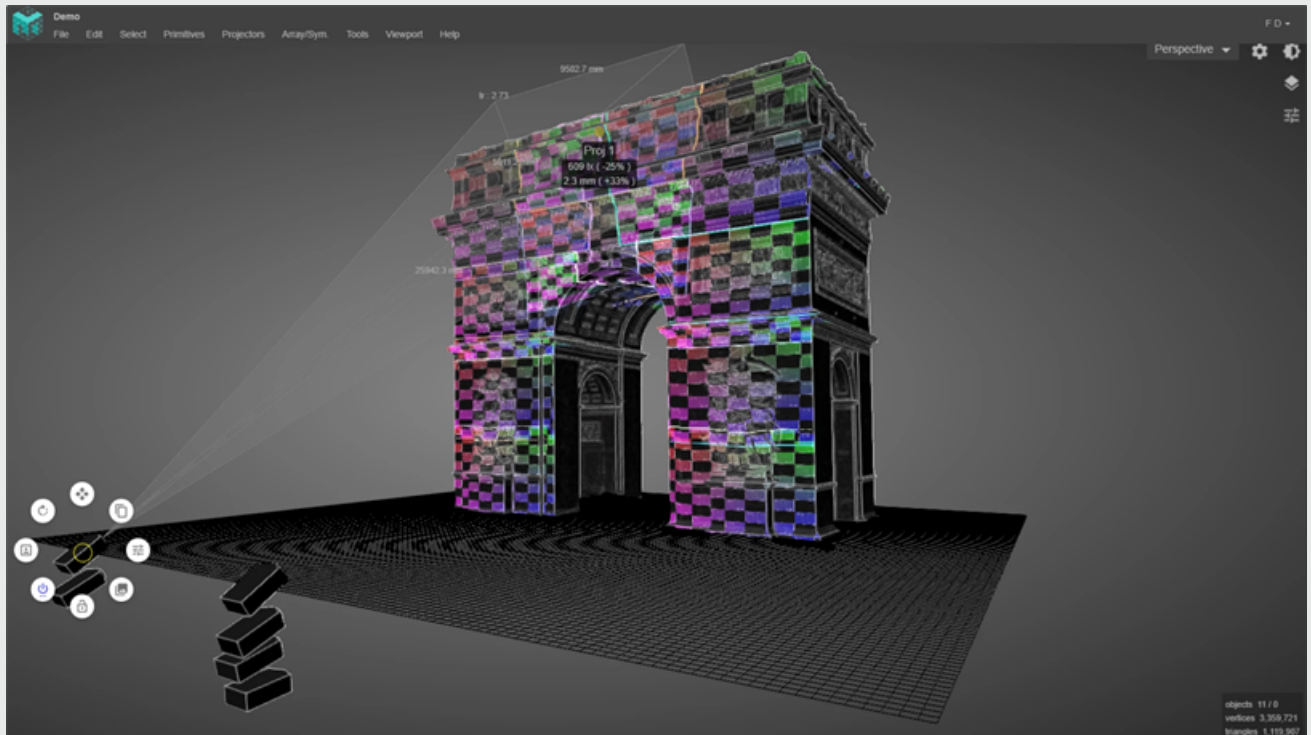

Who is Mapping Matter for/not for?

## Who is it for?

Mapping Matter is a simulation tool designed for audio visual professionals such as Projectionnists, Technical Designers, Set Designers, Content Creators, Sales Team Members.

It will help them creating Projection Specs and Recommendations for large-scale projects (Shows, Permanent Installations, Building Projection Mapping, etc).

Mapping Matter provides fast, easy, enjoyable and highly comprehensible solutions to :

- Confirm budget estimates,
- Iterate on complex Projector placements,
- Work out Contrast Ratios (Photometric Analysis),
- Preview still Images and small Video clips on 3D Objects,



- See Projection Shadows on the Set,
- Measure Pixel Density (down to a single pixel),
- Share Client / Team Presentations,
- Define Media Server Output needs (with Convergence Simulation).

## Who is it not for?

Mapping Matter is not intended for Content Creation and/or Video Playback. However it is possible to preview still Images and small .mp4 Clips on 3D Objects.

# Mapping Matter Getting Started

## Getting Started

### Home Page

- Here you can create / open / rename / duplicate / delete any Scene.
- You can change the display of all Scenes from Grid to List.
- You can sort them alphabetically / most recently used / by creation date.

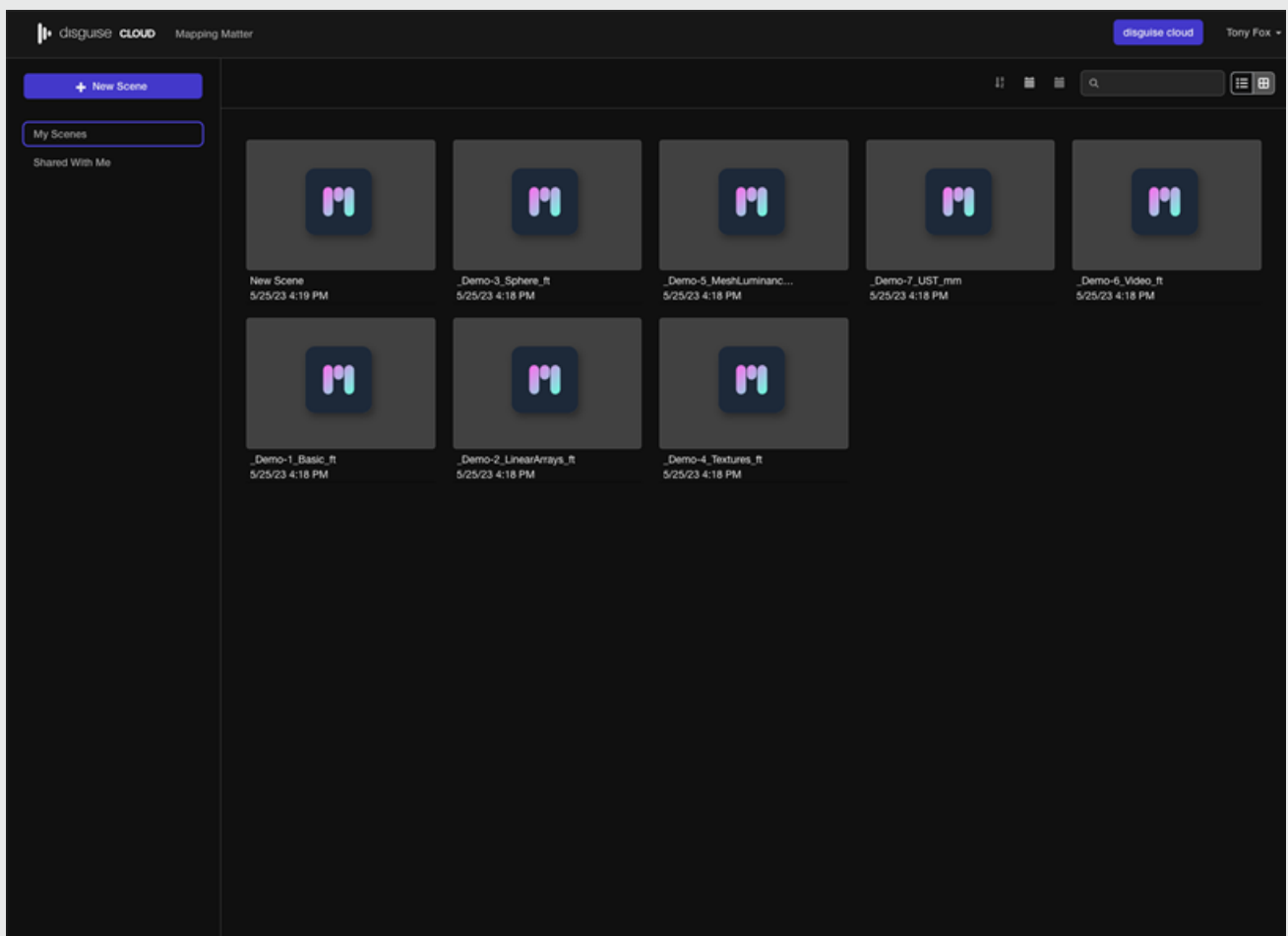

Here's how to organize all your Scenes using Tags. We don't have sub-folders.

[Here's](#) how to Share a Scene

## Base Units of Measurement

You first need to open a Scene. And then just go :

From the TOP MENU > File > Project Settings...

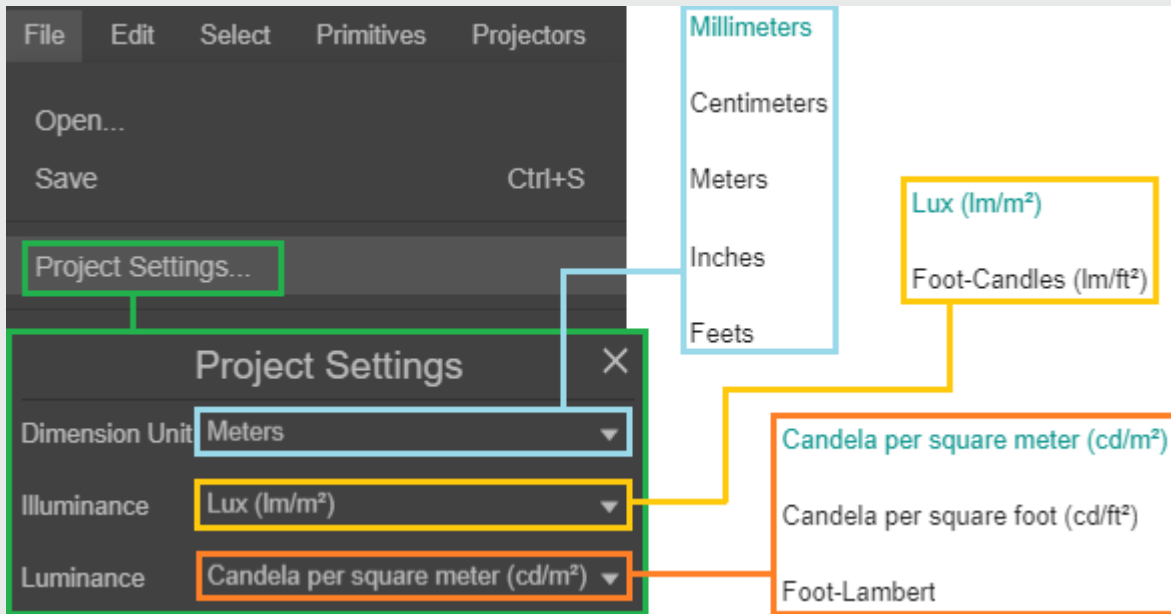

## Import a 3D Asset

We support .FBX(binary) very well, while .OBJ and .DAE work just fine. The maximum asset size is 100MB; you can load bigger assets but only locally.



### WARNING

Mapping Matter is not primarily designed for performance. If you work with very heavy / complex 3D Assets, we strongly recommend to optimize your files before import. Otherwise, the Browser may crash (especially for computers with a small GPU).

Here's an [article](#) about pre-import 3D Asset Optimization.

## Import a 3D Asset into your Scene

From the TOP MENU : File > Import 3D mesh Objects.

This will give you access to the 3D Assets Library.

Double-click on any file to import it in your Scene.

The first time you import an asset into you Scene, the **Import Settings** window will pop-up.

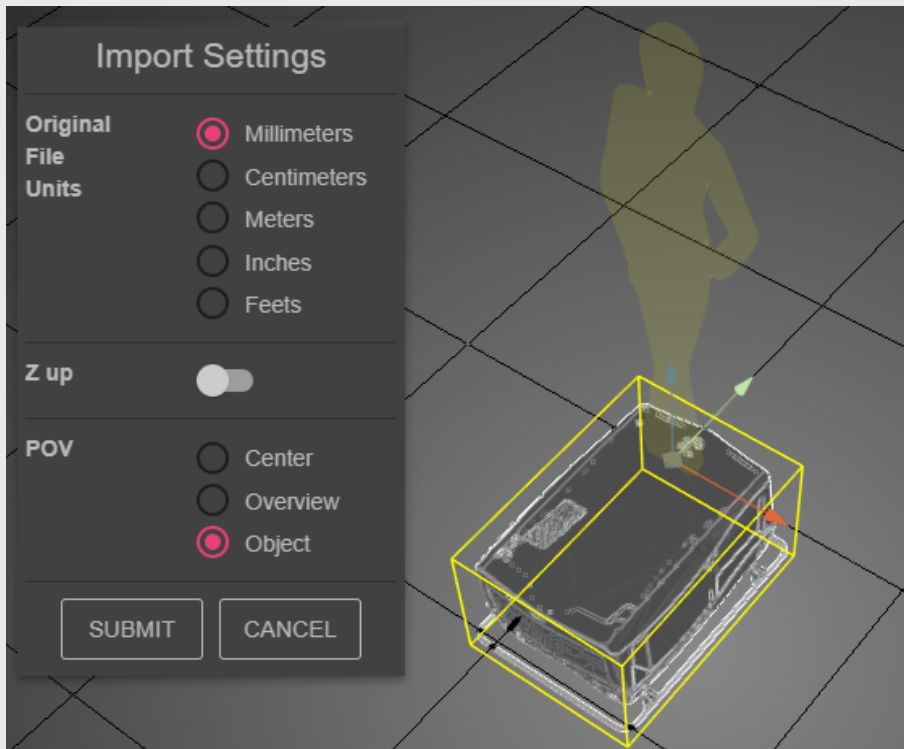

**Original File Units** = the unit of measurement your 3D mesh was exported in.

**Z up** = map the imported asset's Y axis to the Scene's Z axis. This basically rotate your asset 90° on the X axis. This option is available because some 3D softwares export meshes with the Y up.

**POV** = Point Of View = change the camera perspective.



#### TIP

Do you see the humanoid yellow shadow? It has a 180 cm (5.91feet) height. This will help get a sense of the Scale in your Scene.



#### WARNING

If you don't see your mesh despite setting the correct original file units, test with bigger units. Sometimes, files are read as if they were smaller.

You can also import it first, and then multiply its scale through its Properties. (See the following section.)

## Edit the Properties of an imported 3D mesh Object

The editing parameters available will depend on how the the asset was exported (format, software, etc).

Select your Object, go to its **Properties** , and then to the **Reference** panel.

If you have a 3D asset built with different sub-Object meshes, you can edit each of them individually by enabling the **Edit Reference** mode.

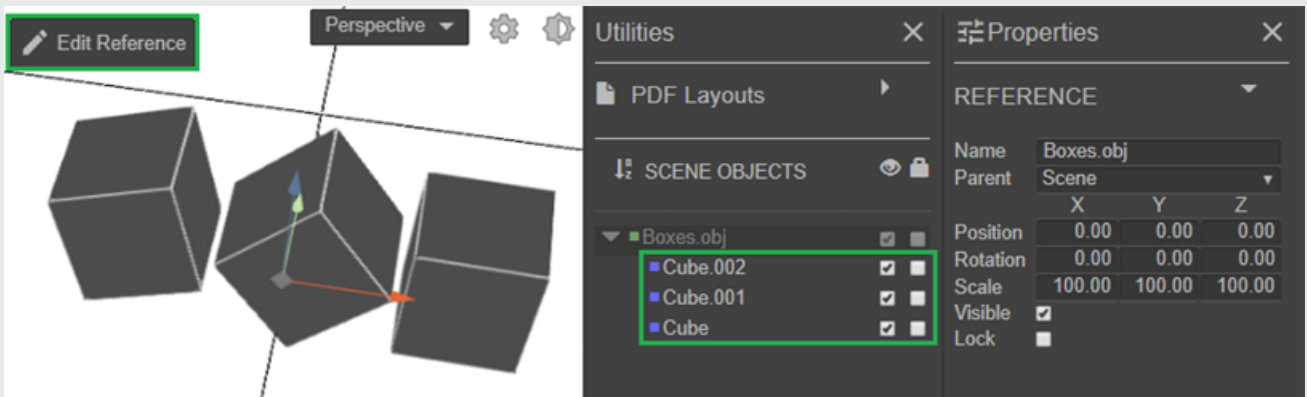

#### WARNING

You cannot move / rotate / delete any sub-Object mesh individually, you'll have to import them already all set.

But you can rename / hide them, and also edit their individual material.

If your mesh had UVs set pre-import, you can re-apply its Texture as a *Base Map*.

## Move around the Viewport

The Viewport represents the whole visible area in which your Scene is displayed.

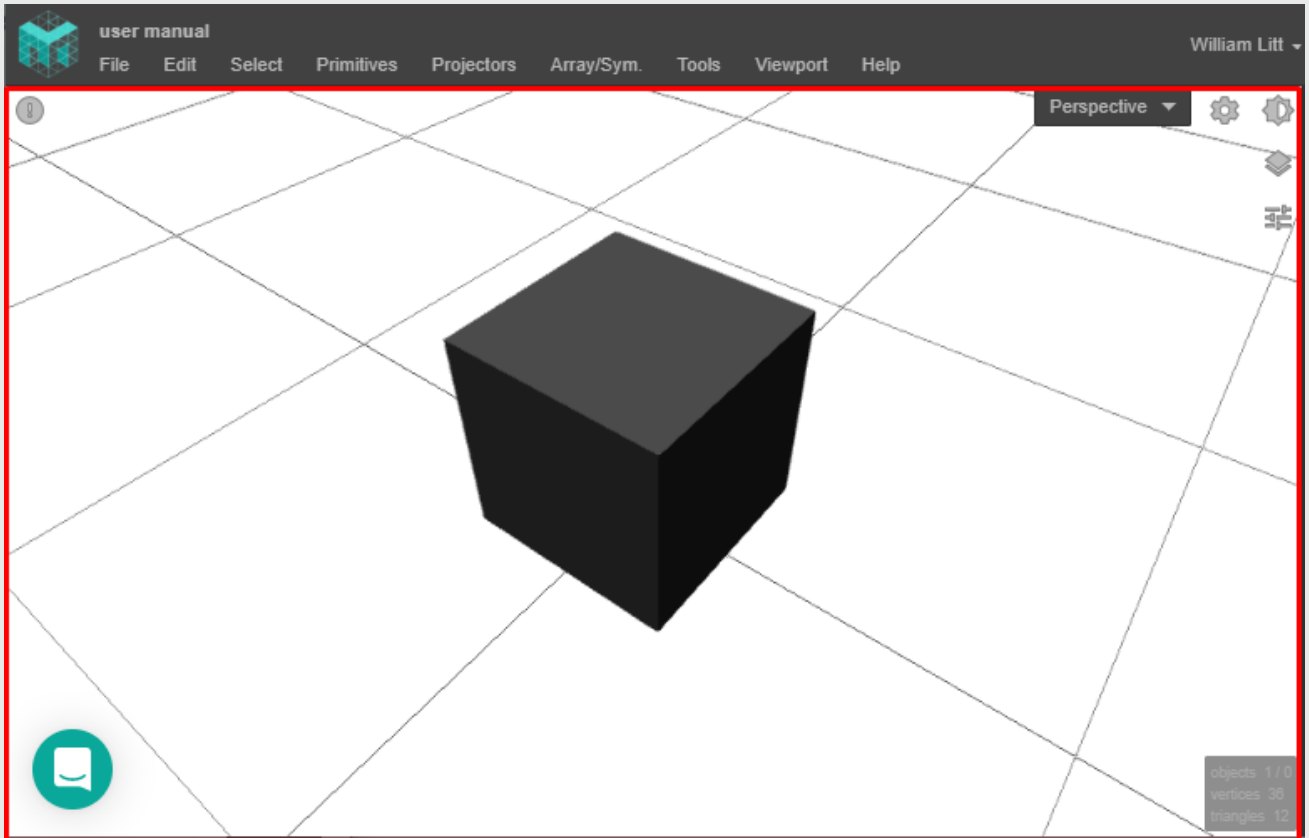

## Pan

Hold left-click and drag to slide.

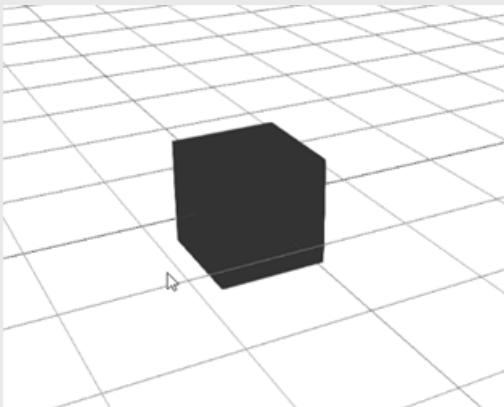

## Orbit

Hold right-click and drag to orbit your cursor. (On Mac: use two fingers while pressing on your touchpad.)

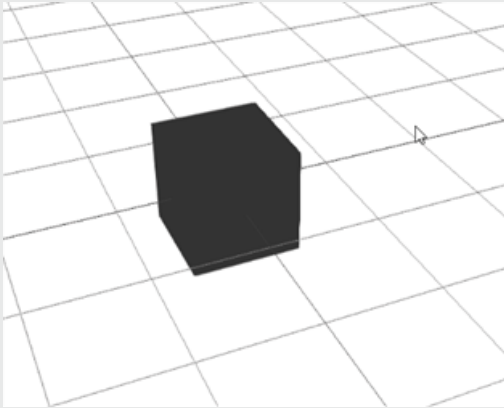

## Zoom-in & out

- Using your scroll wheel.
- Using two fingers on your touchpad.
- Zoom-extend by...
  - » Double-clicking on the Object's body in the Viewport itself.

Or double-clicking on the Object's name in the Scene Objects list.

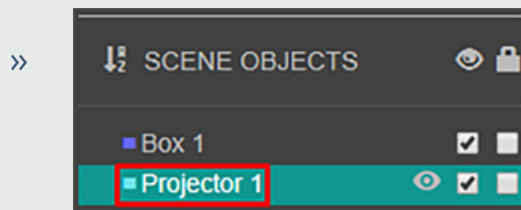

- » Or select your Object, and go to TOP MENU > Viewport > Object Focus.

## Switch to another Point Of View (POV)

The **Perspective** dropdown menu allows to quickly look through our list of POVs.

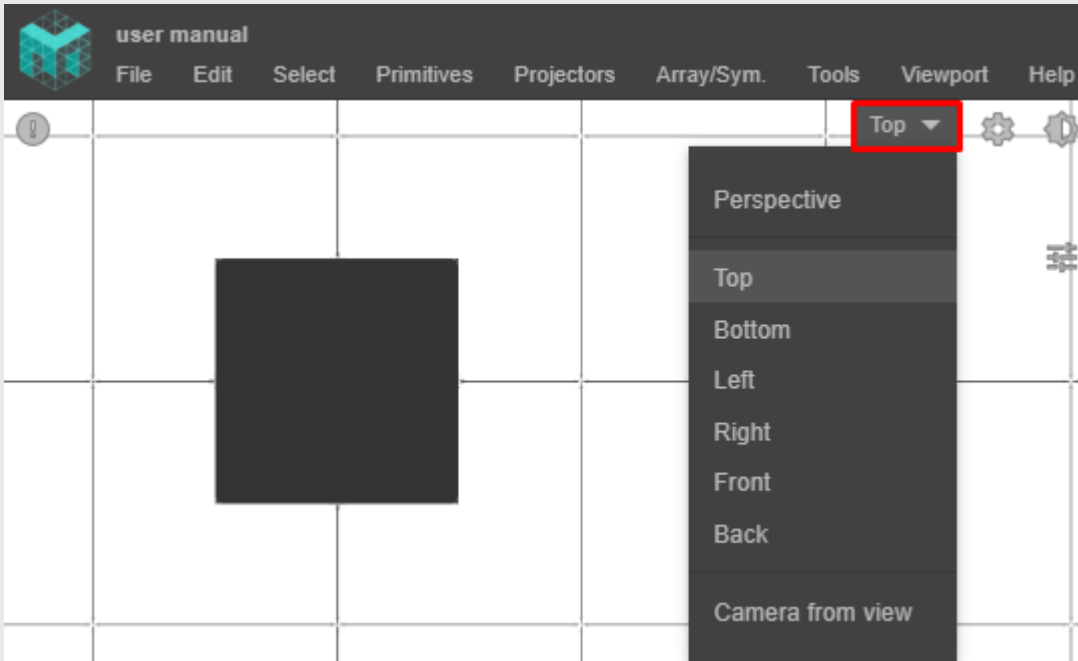

**Camera from view** = create a Camera from your current POV. This may come in handy as you may save a specific POV to come back to it later. All new Cameras will appear in the **Scene Objects** panel.

If needed, you can adjust very precisely the Position (and Target Point) of your Perspective POV (or any Orthographic Camera). Just go to **Camera Settings**.

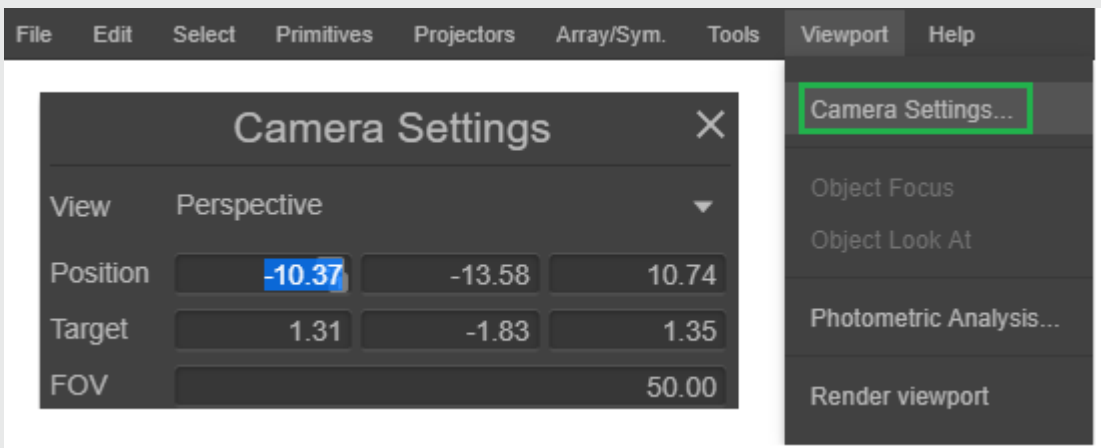

FOV = Zoom-in / out perfectly along the Target axis.

## Primitives

Mapping Matter offers a quick & easy way to customize Parametric Objects. No need for advanced 3D skills.



# Create a Primitive

Each type of Primitive has its own parameters to play with (Width, Height, Depth, Radius, Segments, etc).

TOP MENU > Primitives

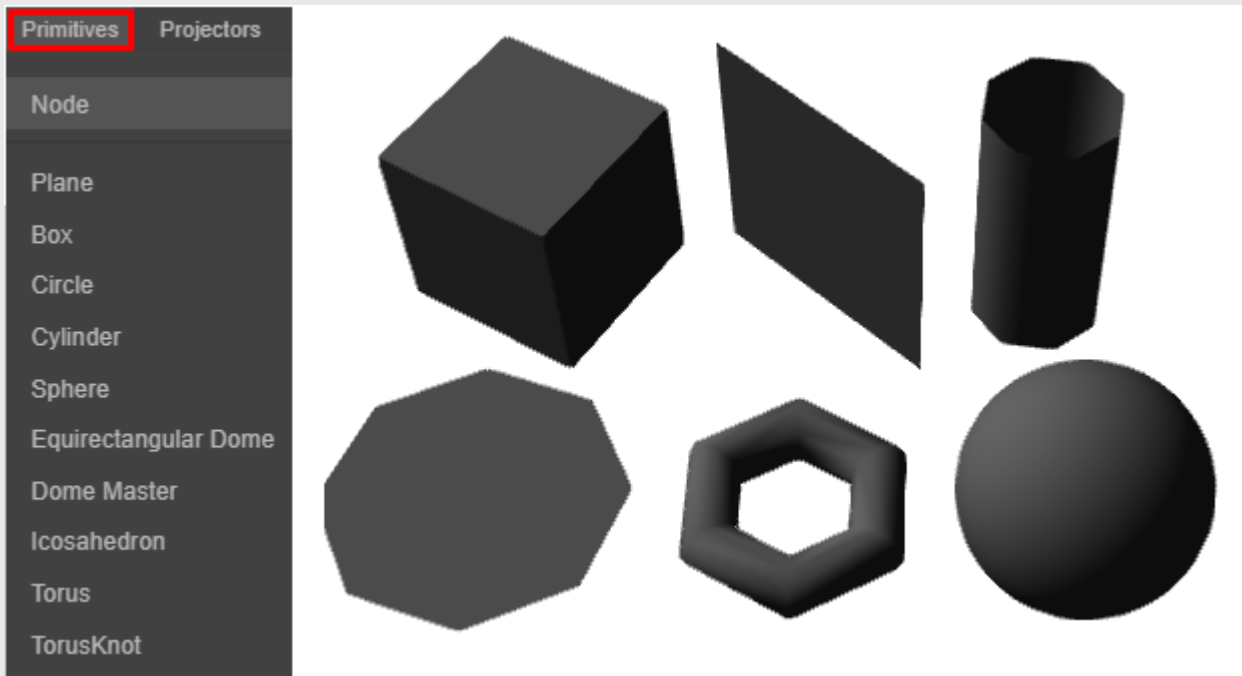

# Customize a Primitive

Select it. Go to its **Properties**, and into the **GEOMETRY** section.

**EXAMPLE 1: Build a Circular Wall with a *Cylinder Primitive***

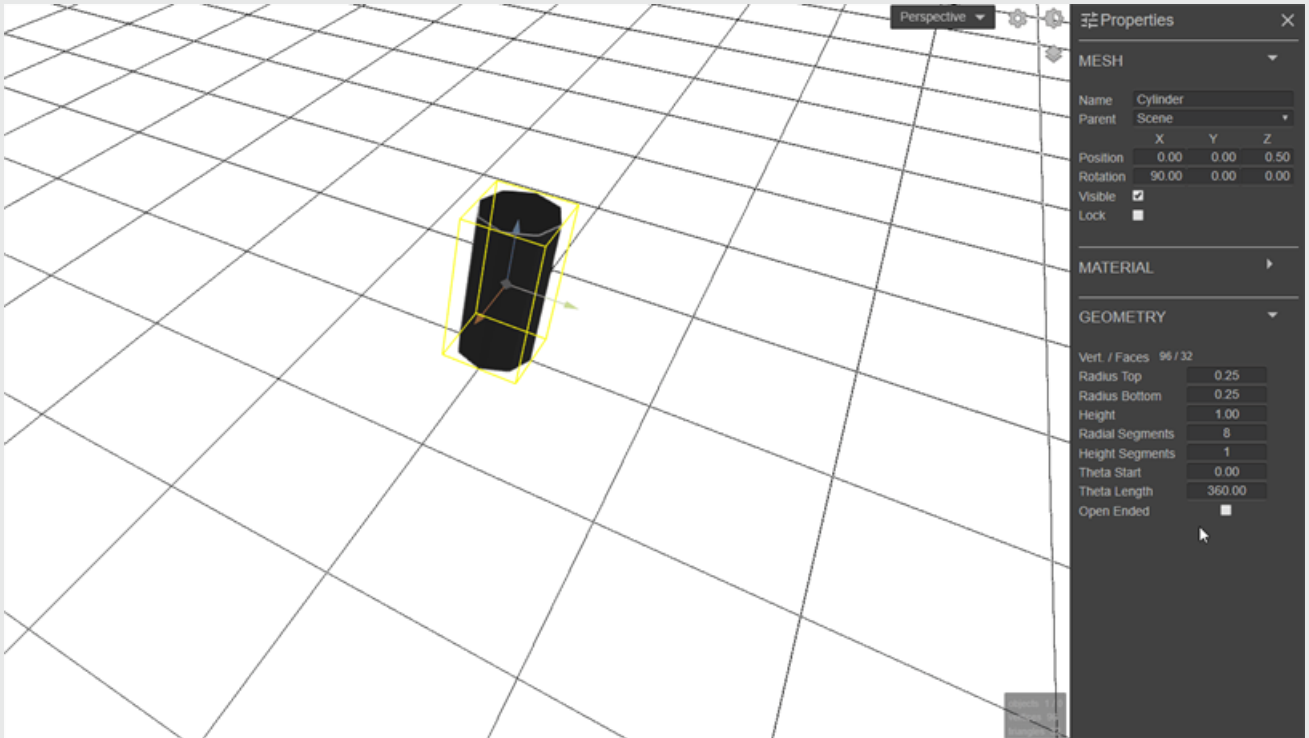

Segments = higher values increase the resolution of the Primitive.

Theta = the angle of definition.

**EXAMPLE 2: Build a semi-Dome with a Sphere Primitive**

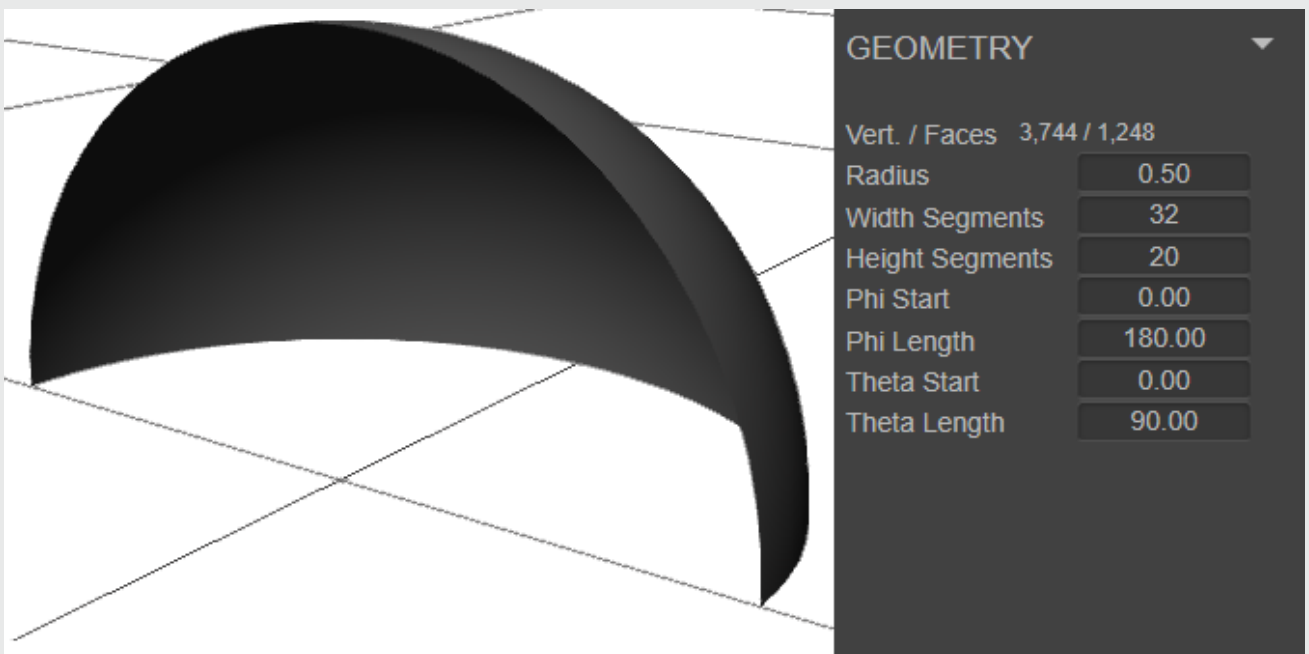

Phi & Theta = the angles of definition for a Sphere.

# Select / Sort / Rename / Delete / Hide / Lock an Object

## Select

When you create an Object in your Scene, it will be listed in the **Scene Objects** panel.

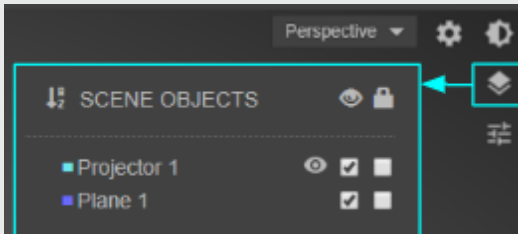

You can select an Object by clicking on its body in the Viewport, or through the Scene Objects list. Hold **Ctrl** to select many Objects.



TIP

If you have too many Objects in your Scene, try placing a group of Objects as Children of a Primitive Node. Learn about Parent / Child Hierarchy [here](#).

## Rename an Object

Select your Object in the **Scene Objects** panel.

Open the **Properties** panel, and edit its name in the textbox.



TIP

By default, all Objects will be sorted from A to Z. Click on the Scene Objects headline to sort them from Z to A. Using numbers like 1.1/ 1.2 / etc may come in handy if you have lots of Objects.

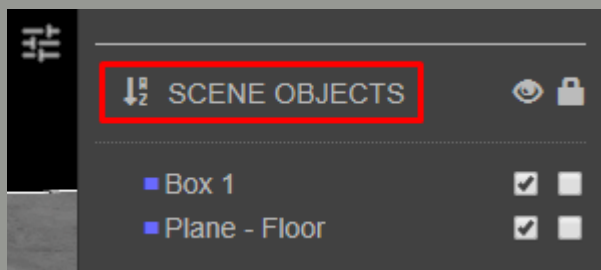

# Delete an Object

Select it. And delete it...

by pressing Delete (PC) or Fn+Delete (Mac) on your keyboard,  
or through TOP MENU > Edit > Delete



## WARNING

Imported 3D Asset's sub-Objects cannot be deleted. However, you can hide them.

# Hide / Show any Object of your Scene

You will find this option in the **Scene Objects** panel.

Tick the box to make it visible.

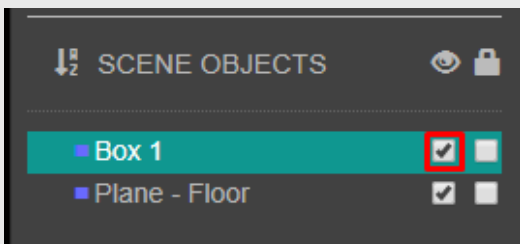

# Lock the properties of any Object in your Scene

Tick the box to lock it.

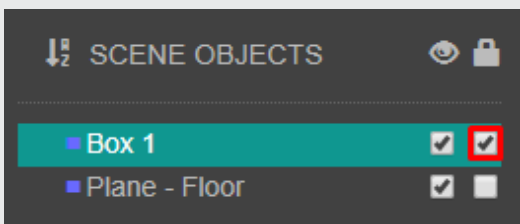

## TIP

Comes in pretty handy when you want to avoid selecting particular Objects while clicking around in the Viewport!

# Move (or Duplicate) an Object

An Object's Position will be calculated from its Center Point, which appears as a diamond-shaped indicator.

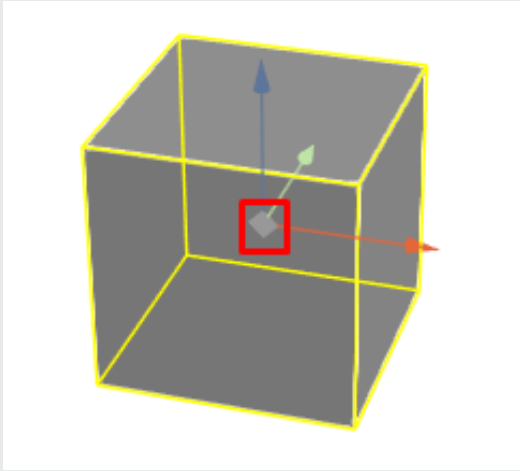

TIP

Hold **Ctrl** while clicking on different Objects to have them selected together. A new common Center Point will be calculated for the whole selection.

If you simply want to duplicate an Object, one way is to copy-paste it.

Select it.

Use Ctrl+C & Ctrl+V to have duplicated in any position.

Or go to TOP MENU > Edit > Clone to have it duplicated in the exact same position.

## Using the Movement Gizmo in the Viewport

DEFINITION

**Movement Gizmo** = visual 3D tool allowing you to move an Object in function of 3 axes (X, Y, Z).

Three arrows point out of the Object's Center Point. By default, Red is for the X axis. Green for the Y axis. And Blue for the Z axis.

Hold-click on any axis vector and drag your cursor.

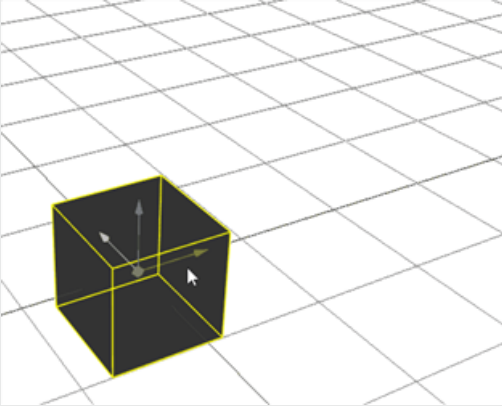

TIP

You can also duplicate your Object by holding **Ctrl** while moving it.

Or click once on any axis vector, type a **World Position** value in the input box, and press **Enter**.

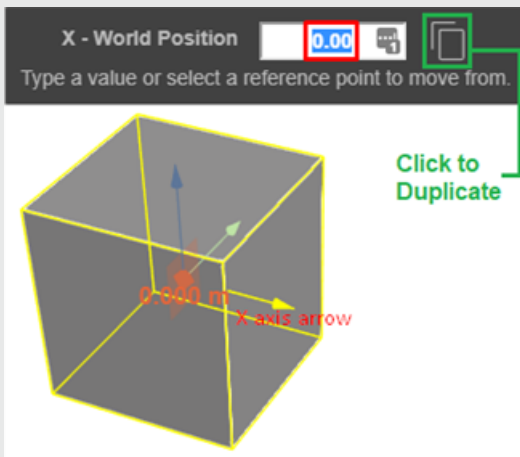

TIP

You can also move it away from its current position by inputting +X (positively) or +-X (negatively).  
E.g. to move it by -6 units on a given axis, set +-6 and press **Enter**.

## Using coordinates in the properties panel

Hold-click on the input box of any coordinate and drag your cursor.

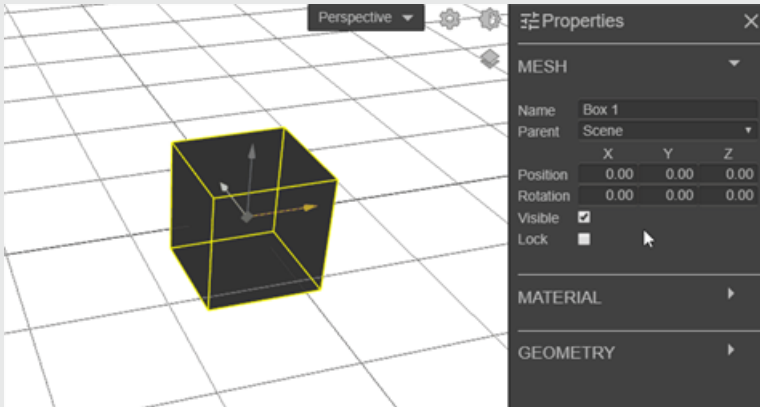

Or type-in a specific value and press **Enter**

## Using two reference points

One to move from + one to move to.

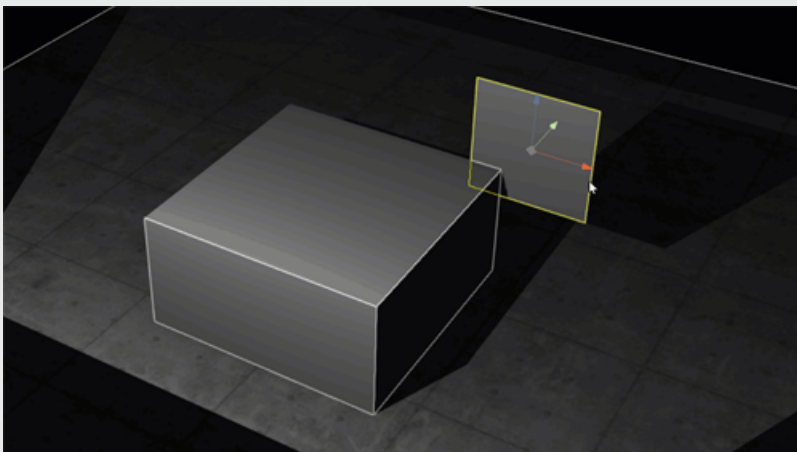

Select an Object, and click on its Center Point.

If you want to duplicate it, just click here.

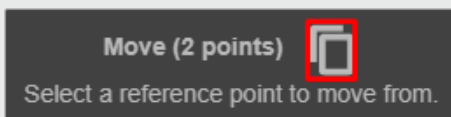

Click on a reference point to move from, and then another to move to.

Use the SNAP Tool to select a reference point more accurately in your Scene. This window will pop up automatically.

When neither Bounding Box or Vertex are enabled, the Red dot will appear at any intersection between the surface and your cursor.

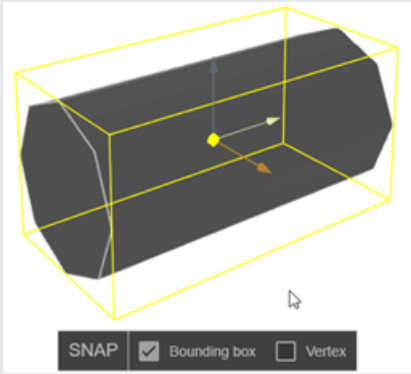

#### TIP

You can add a constraint of movement on any given axis. Your Object will move (or be duplicated), but only along the chosen axis.

Select your Object. Click on its Center Point. Click on the axis of constraint. Select a Point to move from, and another to move to.

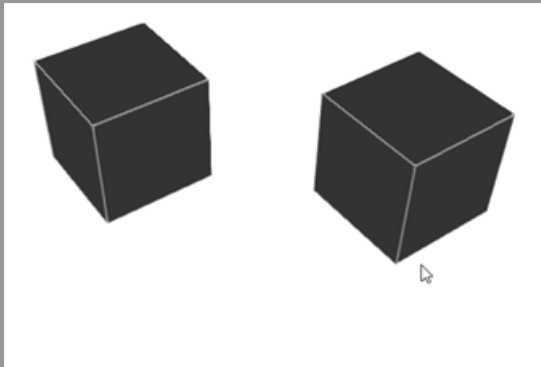

## Move an Object A in orbit of an Object B

[Here's a tutorial](#) on how to set up a Pivot Point.

## Rotate an Object

Select an Object. (Or many, holding **Ctrl**)

Press **R** on your keyboard to see the Rotation Gizmo.

Hold-click on any axis curve, and drag your cursor to adjust.



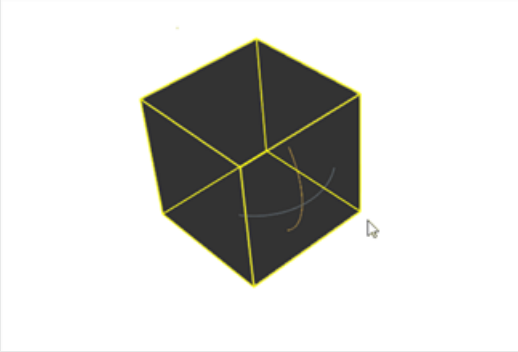

Or click once on any axis curve, and type in a specific angle rotation value.



Press **M** to get back to the Movement Gizmo.



#### WARNING

You have to be aware of a potential Gimbal Lock issue.



= "When the pitch (green) and yaw (magenta) gimbals become aligned, changes to roll (blue) and yaw apply the same rotation to the airplane." [Credits](#)

## Material

The *Material* of an Object refers to the characteristics of its surface. This has an impact on its appearance, reflectivity, and texture mapping.

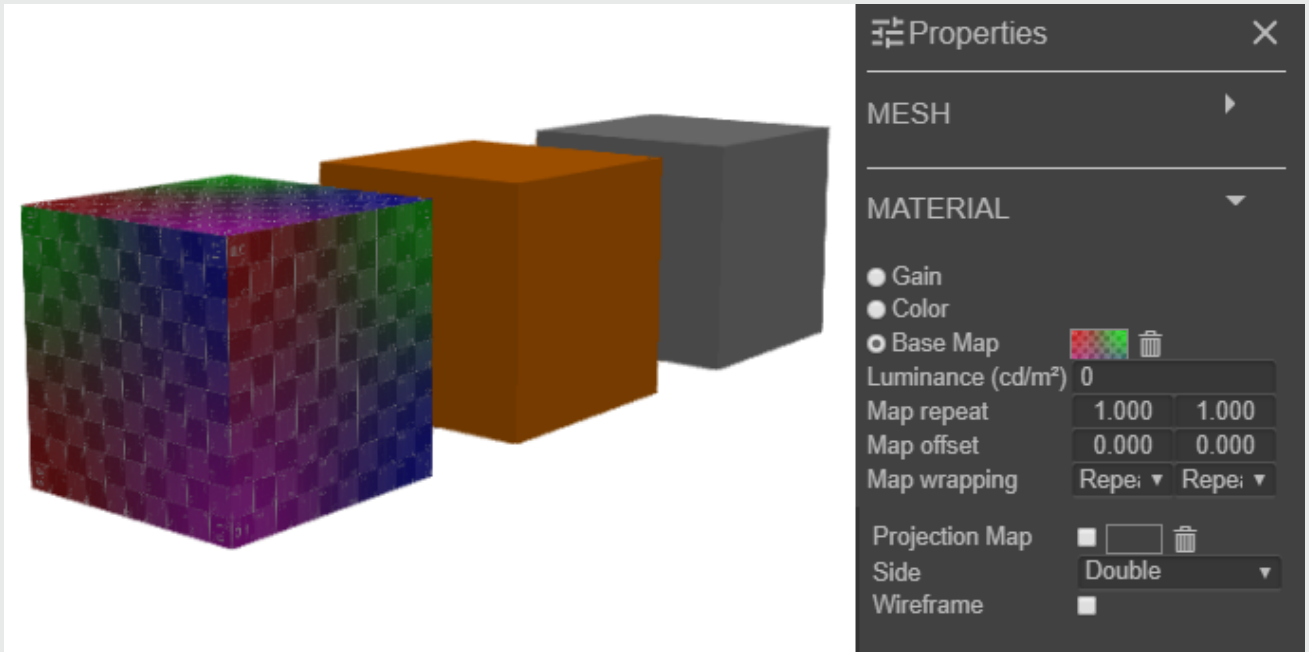

Select your Object.

You can also select an individual (sub-Object) mesh from an Imported 3D Asset. Just select your Asset, click on **Edit Reference**, and select any mesh in the **Scene Objects** list.

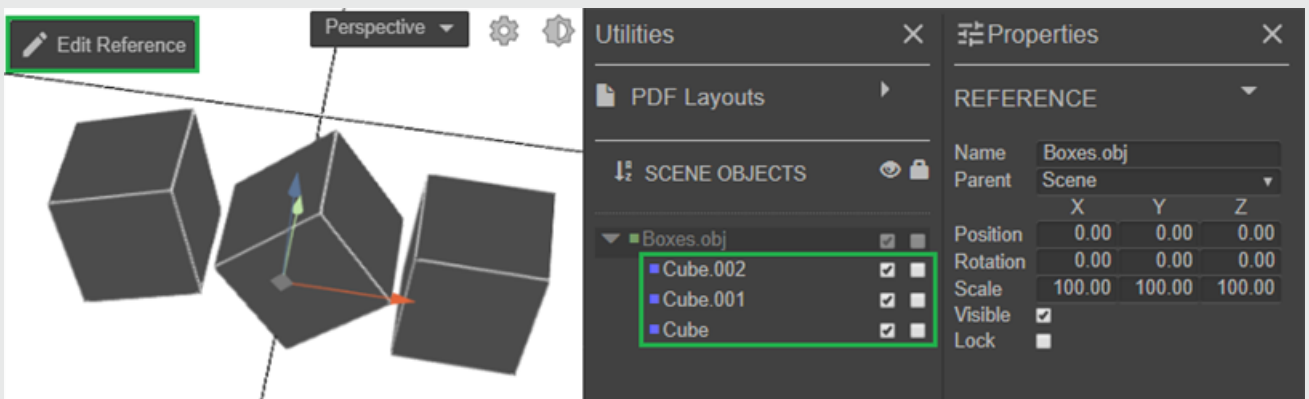

Go to its **Properties**, in the **MATERIAL** section.

## Apply Gain

**Gain** = The gain ratio represents how much light is reflected by any given surface, compared to the light reflected from a standard white (magnesium oxide) board. A ratio of 1.0 will reflect the same amount of light as that of white board. Whereas a gray board with a 0.5 rating would reflect only 50% of the Light falling on.

This has an incidence in the **Photometric Analysis** mode, on the *Luminance* values

# Apply Color

The brighter the selected color, the higher its reflectivity.

This has an incidence in the **Photometric Analysis** mode, on the *Luminance* values.



TIP

You can also manually adjust the Luminance setting below, to enhance its intrinsic brightness.

Usually best to keep it at 0, unless you want to simulate a Screen / LED wall.

Luminance (cd/m<sup>2</sup>) 100

# Apply Base Map

The *Base Map* tool allows you to map (or "wrap") an Image (or Video) onto the surface of a 3D mesh Object.



WARNING

This will only work with **Primitives**, and imported 3D mesh Objects which already had their UVs set. You can set UVs in any good CAD software (e.g. Blender). To learn more, search for tutorials about "UV unwrapping".

Go to **Base Map** and click in the framebox to open the **Texture Library**.

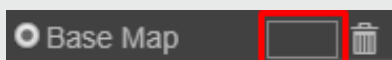

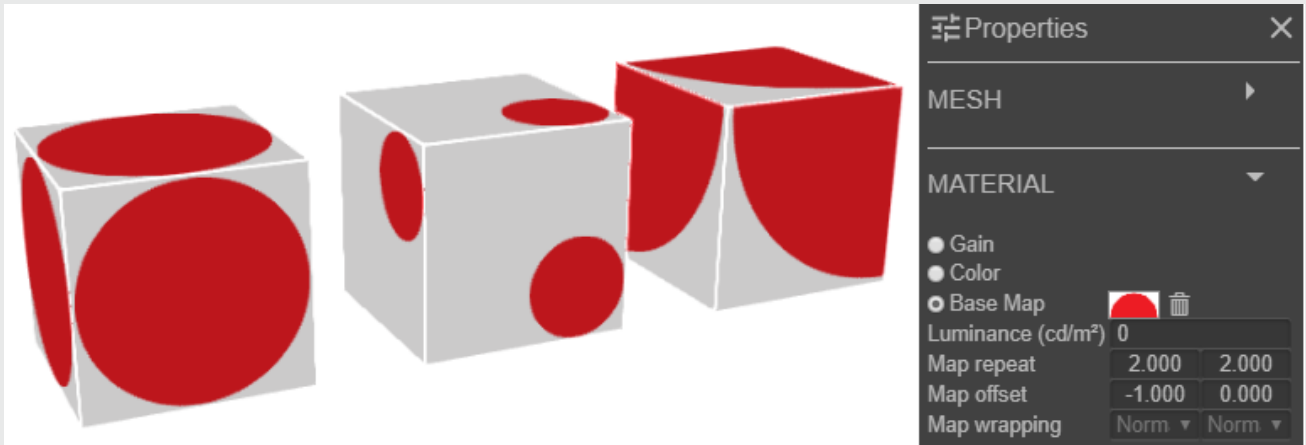

To learn how to use the Texture Library, click [here](#).

Adjust the placement of your Texture with the **Map repeat** and **Map offset** ratios.

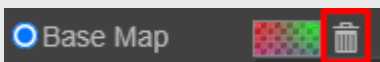

After you've selected an Image, you can remove it by clicking on the Trash



 **TIP**

You can also manually adjust the *Luminance* setting below, to enhance its intrinsic brightness. Usually best to keep it at 0, unless you want to simulate a Screen / LED wall.

**Luminance (cd/m<sup>2</sup>)**

## Apply a Projection Map (Projection Texture)

The Projection Map tool allows you to map (or "wrap") an Image (or Video) onto the surface of a 3D mesh Object.

 **WARNING**

This will only work with **Primitives**, and imported 3D mesh Objects which already had their UVs set. You can set UVs in any good CAD software (e.g. Blender). To learn more, search for tutorials about "UV unwrapping".

The **Base Map** represents the intrinsic appearance of an Object.

Whereas the **Projection Map** represents a projected Texture onto the surface of an Object. By default, it won't be visible in the Viewport. It will have to be "revealed". Either by a Projector in Reverse Mapping mode, or using the Projection Texture tool.

Go to **Projection Map** and click in the framebox to open the **Texture Library**.

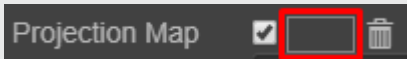

To learn how to use the [Texture Library](#), click here.

After you've selected an Image, you can remove it by clicking on the Trash icon.

## Use Side to make it transparent



### WARNING

First, make sure **Global Material Override** is disabled.

Go to **Viewport Settings**, and tick off the **Double Side** option.

Also note that it will only work with 1-face meshes (e.g. it won't work with a double wall).

Select an Object. Go to its **Properties**, and to the **MATERIAL** section.

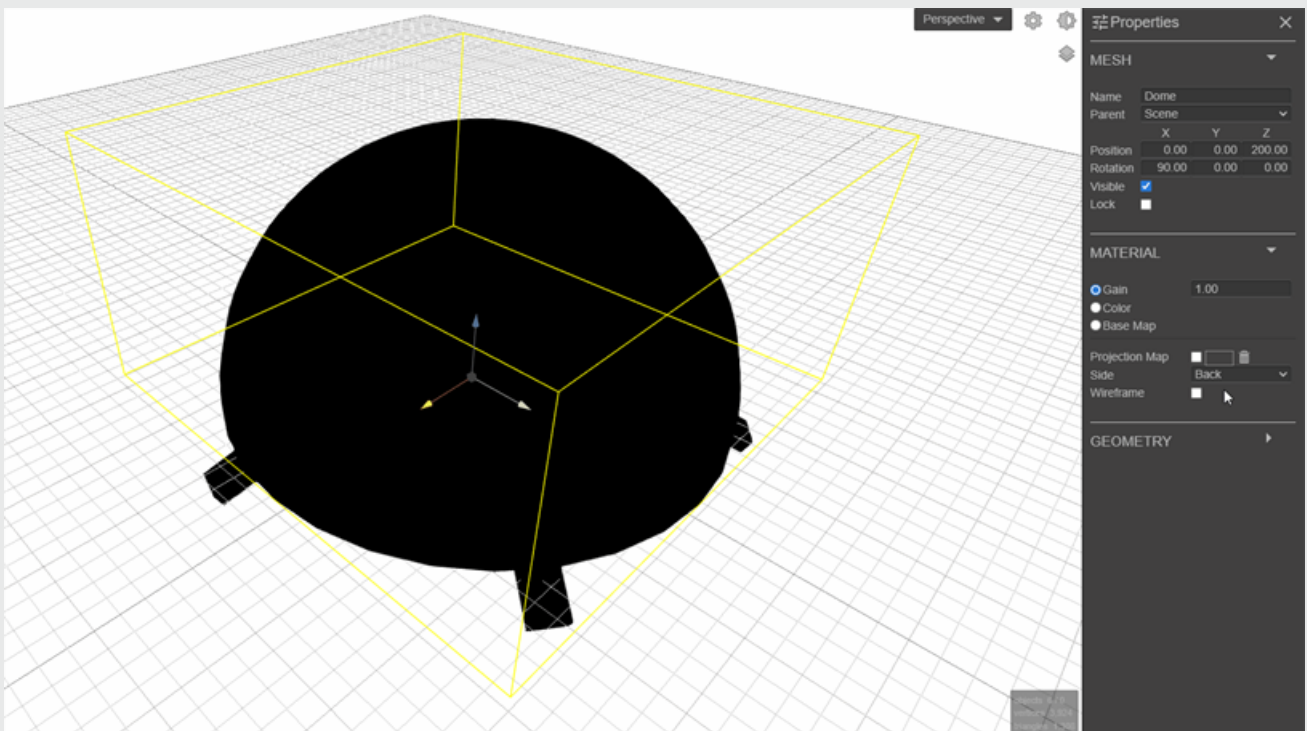

**Back** = opacity prevents us to see through the surface.

**Front** = we can see through the surface.

**Double** = what appears on one side also appears on the other

## Use Wireframe to make it transparent

Wireframe = visual representation of a Mesh Object, only showing its vertices



TIP

Use a *Circle Primitive* as a reference to measure any angle in your Scene, setting *360 Segments* and playing with its *Theta*. You can use the SNAP tool to easily pin it where needed.

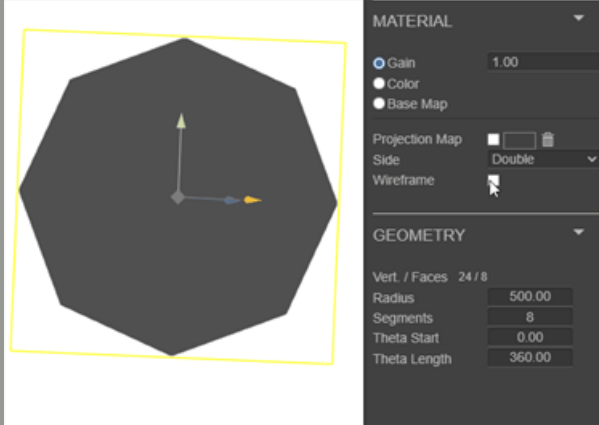

TIP

You can also use *Wireframe* to create a "Transparent" Gauze / Scrim Material.

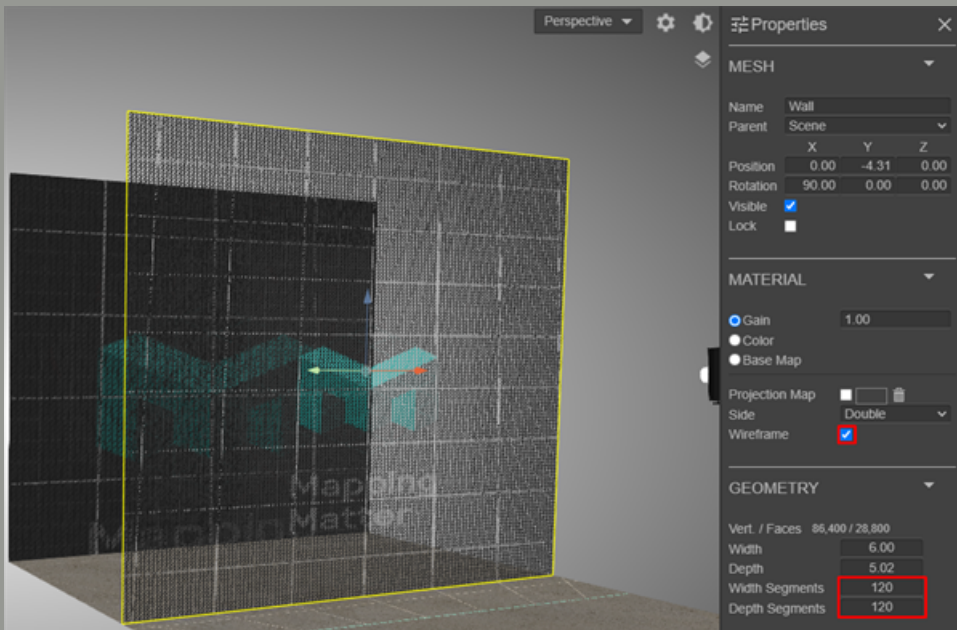

# Parent Child Hierarchy

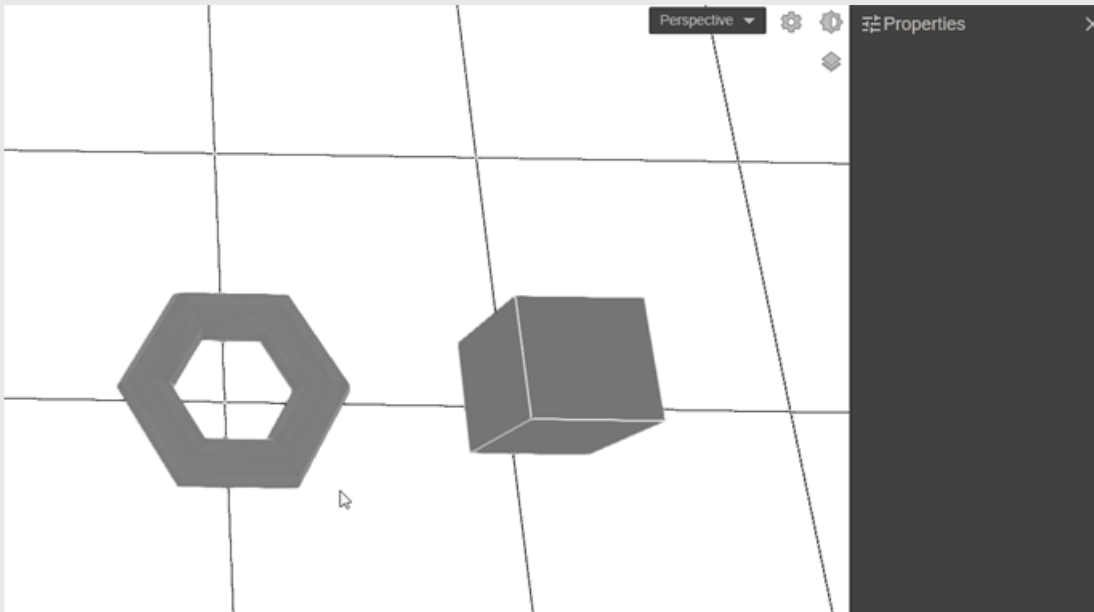

The *Position* of an Object is calculated in function of the Center Point of its *Parent* Object.

By default, each new Object is the *Child* of the Scene itself.



TIP

Here's how to offset the Center Point of the whole Scene. This may be useful when you're working on an imported Geometry which isn't centered already.

To change the Hierarchy between Objects :

Select your Object, go to its **Properties**, and to the **Parent** dropdown menu.

ILLUSTRATION

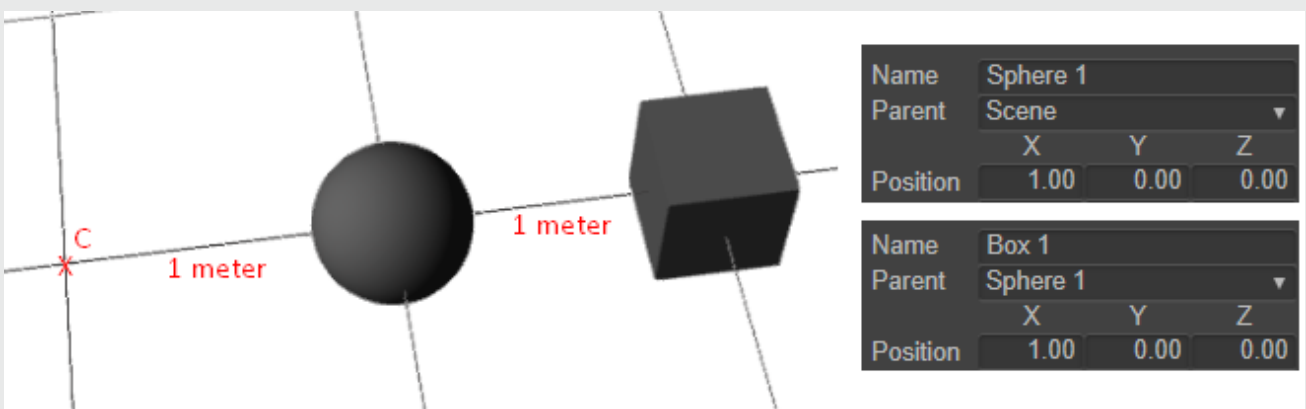

Here both Sphere 1 and Box 1 have the coordinates (X=1, Y=0, Z=0). But Sphere 1 is positioned in function of its *Parent* the Scene (C), 1 meter away on the X axis. And Box 1 is 1 meter away from its Parent Sphere 1.

## Arrays and Symmetries

These tools offer an easy, quick, and accurate way of creating large Object / Projector layouts in your Scene.

### Definitions

**Array** = an immaterial Object which duplicates its Children into dummy Clones, either following a linear or a polar sequence.

**Symmetry** = an immaterial Object which duplicates its Children into dummy Clones, following a symmetric sequence.

**Dummy** = fake, visual only, not listed in Scene Objects, with no individual Propertie

## Create a Linear Array

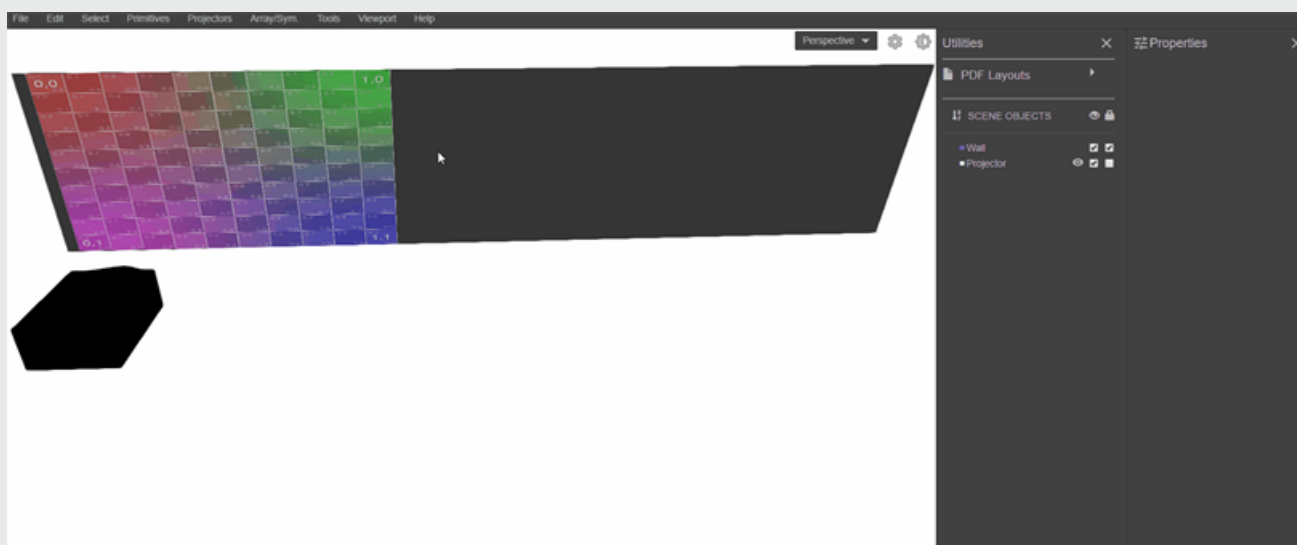

TOP MENU : Array/Sym. > Array

The Array will appear as an Object, Child of your Scene, at (0, 0, 0).

Select the Object you want to lay out.

In the **Properties** panel, make the Object a **Child of the Array**.

Customize the Linear Array parameters.

**Number** = the total amount of Objects in the Array = original + dummies

**Separation** = the distance between each Object in the Linear Array



# Create a Polar Array

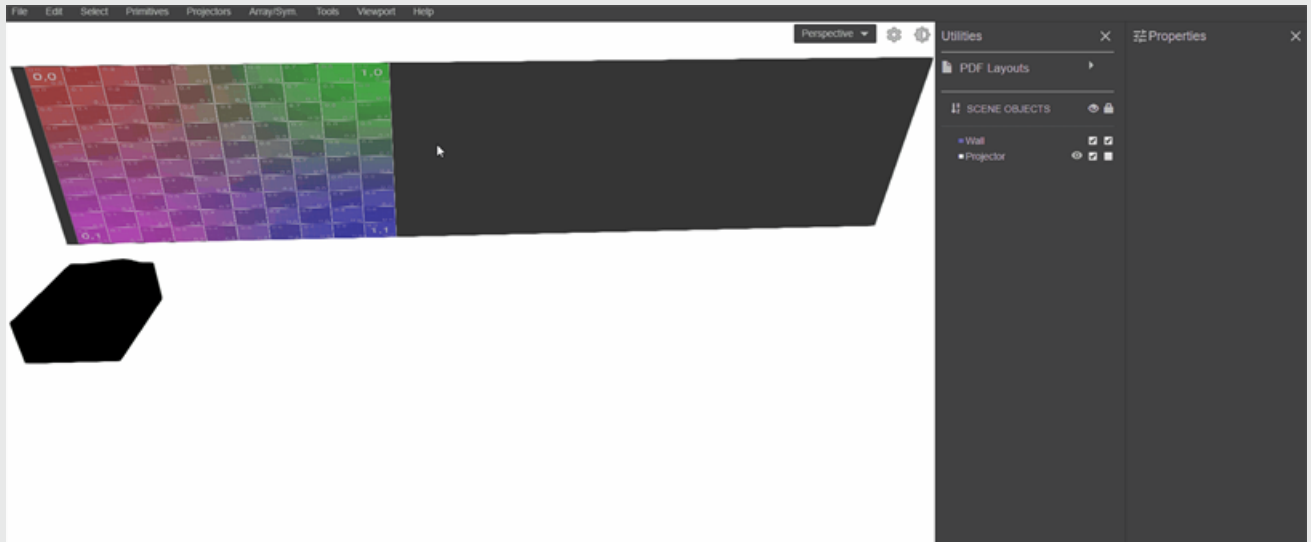

TOP MENU : Array/Sym. > Array Polar

The Array will appear as an Object, Child of your Scene, at (0, 0, 0).

Select the Object you want to lay out.

In the **Properties** panel, make the Object a **Child of the Array**.

Customize the Polar Array parameters.

**Number** = the total amount of Objects in the Array = original + dummies

**Angle** = the angle of distribution for all Objects in a Polar Array.

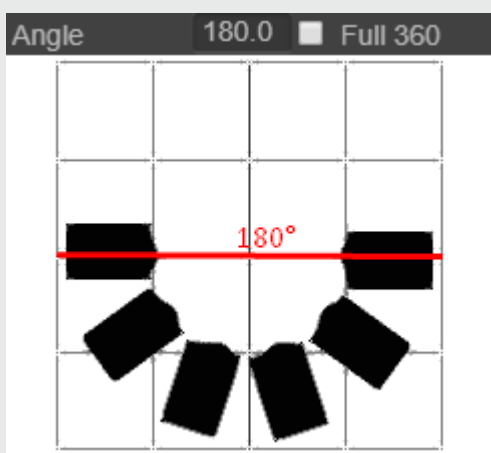

By default, a Full 360° angle distributes all Objects on a whole circle. But with a 180° input value, the distribution is limited on a 180° angle (half a circle). All Objects are automatically set equidistant to each other.



TIP

Use the **Side** tool to "see through" any Object in your Scene

## Create a Symmetry

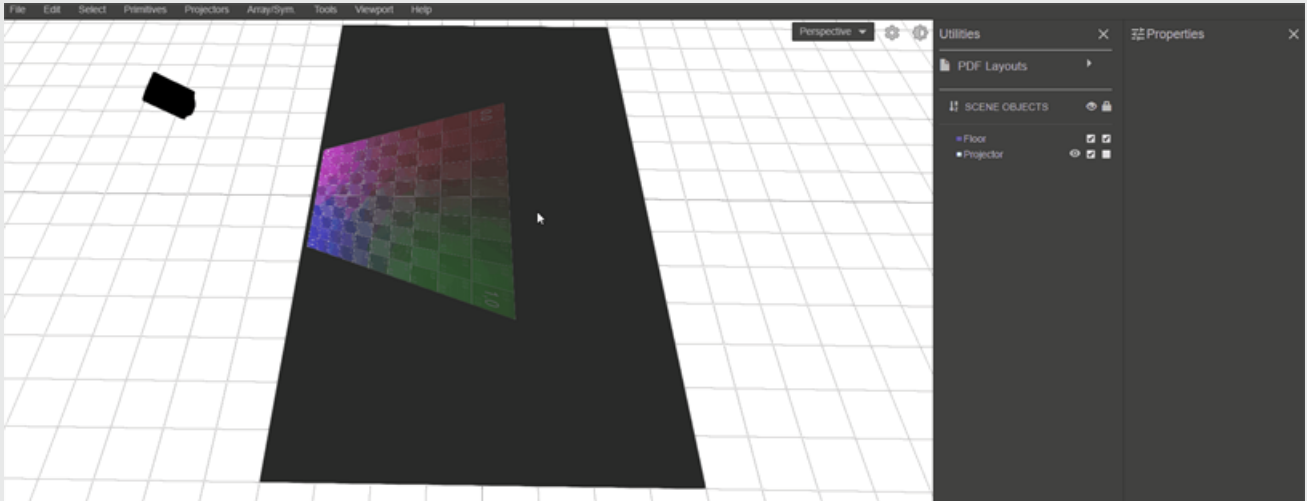

TOP MENU : Array/Sym. > Symmetry

The Symmetry will appear as an Object, Child of your Scene, at (0, 0, 0).

Select the Object you want to lay out.

In the **Properties** panel, make the Object a **Child of the Symmetry**.

Now our Object has a symmetric dummy along the X axis of our Symmetry.

The axis of symmetry is the Y axis. This is illustrated by a transparent yellow plane, which appears when the Symmetry Object is selected.

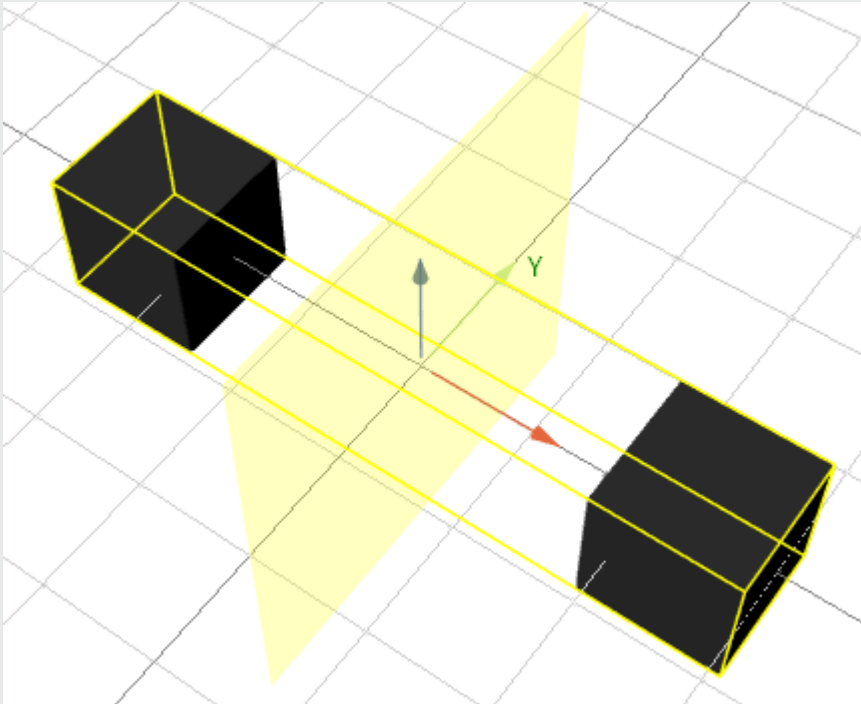

All modifications to our Object will be replicated immediately to its dummy.



TIP

You can also make an Array the Child of a Symmetry, etc.

## Convert your dummy Objects into regular Objects

This will allow you to make individual modifications to your ex-dummy Objects.

You'll find each of them in the **Scene Objects** panel.

Select your original Object.

Go to the Properties panel.

In the **Array (or Symmetry)** section, hit the **Bake** command.

Bake

## Annotations and Dimensions

The **Annotations** tool allows you to create a bodyless Object holding Text.

While **Dimensions** allows you to create a bodyless Object measuring the distance between two given points the Scene.

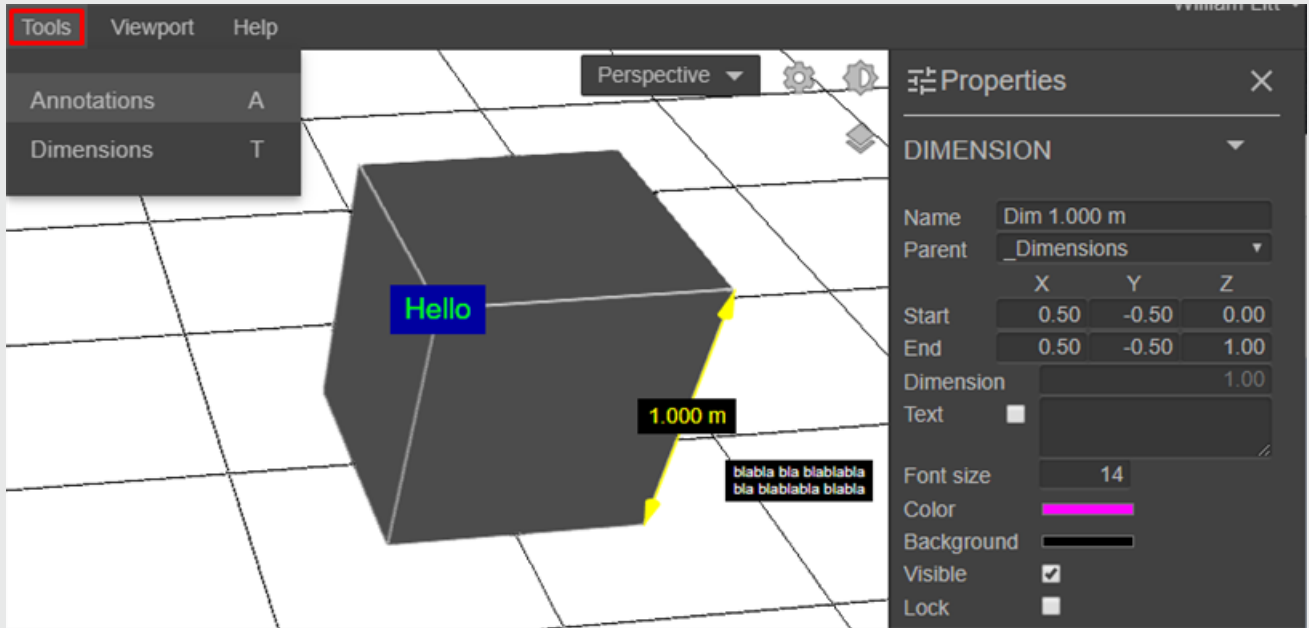

## Create an Annotation or Dimension Object in your Scene

TOP MENU > Tools



TIP

You can also use the keyboards shortcuts A (Annotation) and T (Dimension). Press ? for all keyboard shortcuts.

Select 1 or 2 Point(s) in your Scene.

1 Point only for Annotations. And 2 Points, from Start to End, for Dimensions.



TIP

Use the SNAP Tool to select a reference point more accurately in your Scene. This window will pop up automatically.

When neither Bounding Box or Vertex are enabled, the Red dot will appear at any intersection between the surface and your cursor.

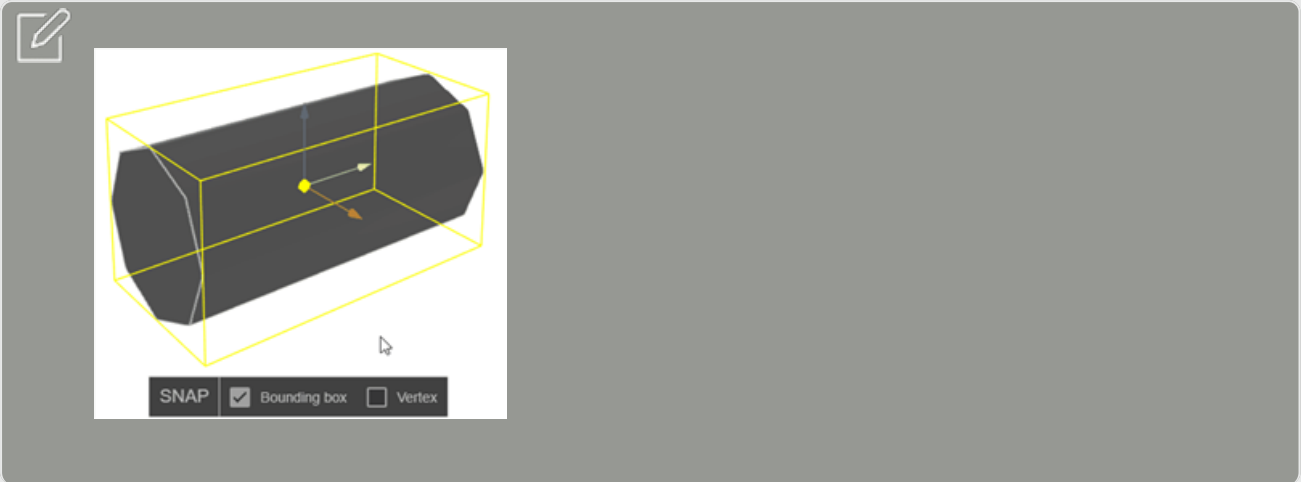

## Edit an Annotation or Dimension

Select the Object, from the Scene or the **Scene Objects** panel.

Open the Object's **Properties** panel.

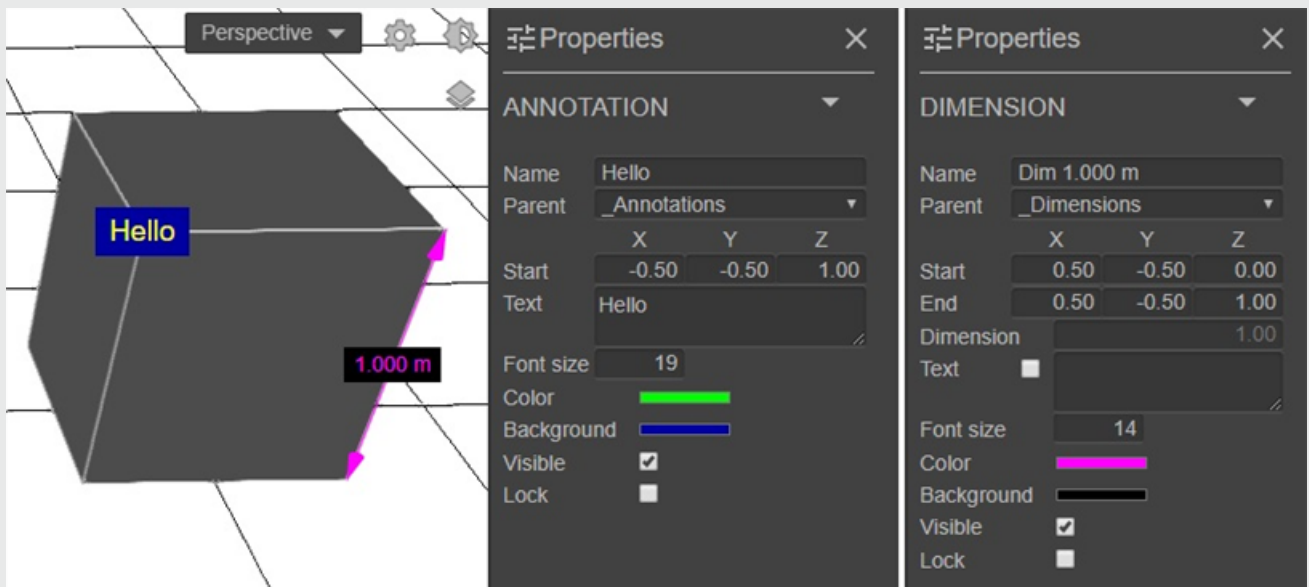

# Mapping Matter Projectors & Cameras

## Projectors/Cameras

### Create (or Swap) a Projector



WARNING

For all Projector modifications to be updated in your Scene, you'll need to refresh your Browser.

## Create a Projector in your Scene

TOP MENU : Projectors > Projector

Click to display Specs. Double-click to create it in your Scene.

To learn how to manage your Library and add new Projectors, click [here](#).

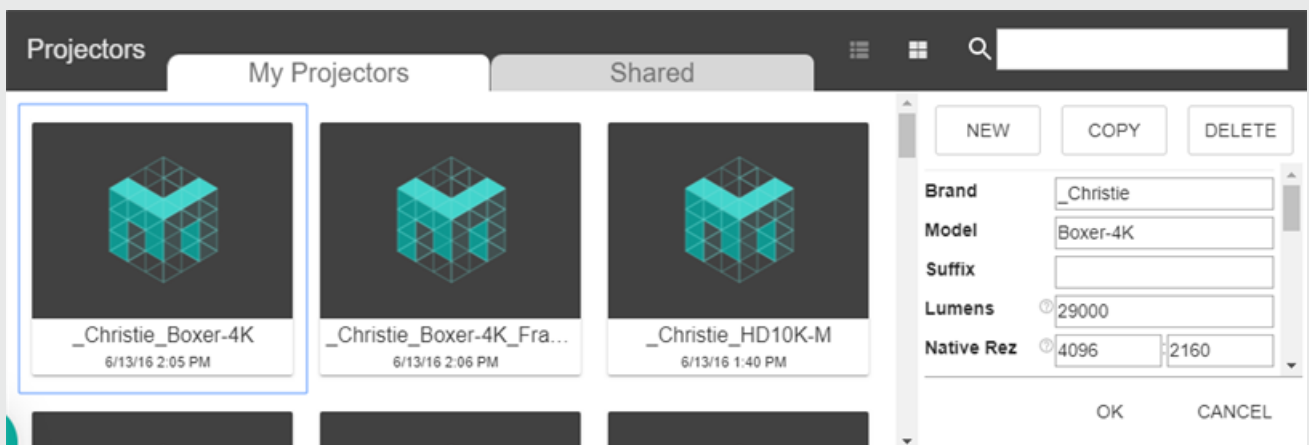

## Swap a Projector from your Scene

You can test different Projectors, while the Scene Projector's settings (position, rotation, etc) remain unchanged.

Select a Projector. Go to its **Properties** and click on **Projector Library**.



TIP

You can also select many Projectors at once, holding **Ctrl**.

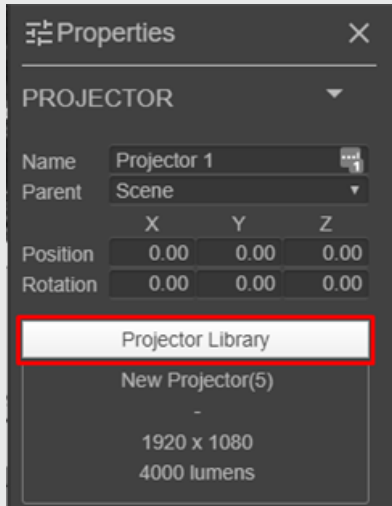

## Projector Orientation

### Use Rotation

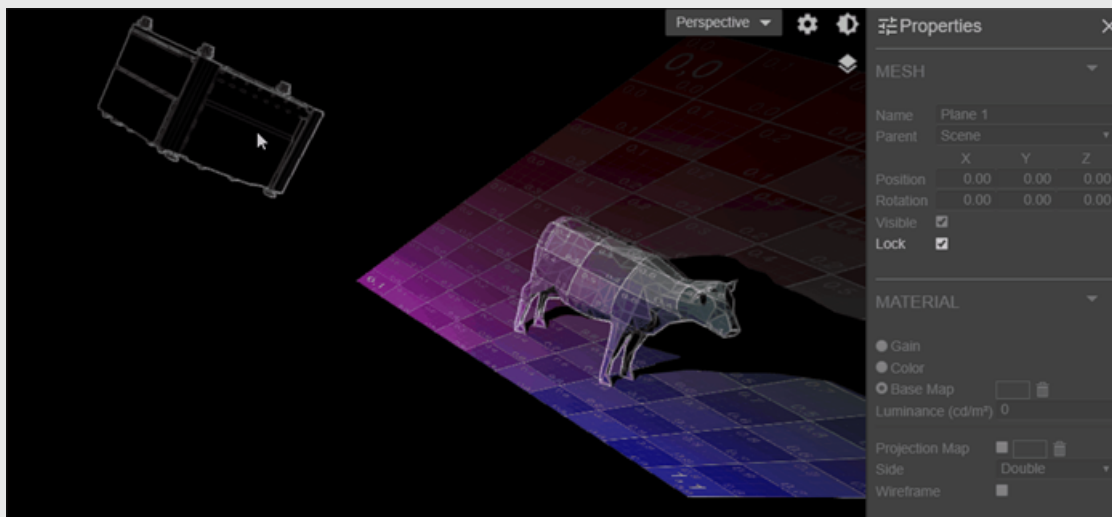

The Orientation of a Projector is determined by the axis between its Lens and its *Target Point* (the Yellow Dot).

— With your keyboard's Arrows.

Press once on any Arrow for a 0.1° increment.

Hold **Shift** while pressing on any Arrow for a 1° increment.

- Through the Properties panel, with the Rotation input boxes.

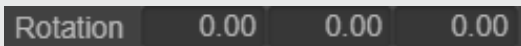

Type-in a value.

Or left-click on any value, and drag to adjust. (Hold Shift to drag faster.)

- With the Rotation Gizmo. (Press **R** on your keyboard to show the Rotation Gizmo.)

Then hold-click on any curve to drag and adjust.

Or click once on any curve, and type-in a value.

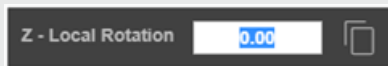

## User the Target Point

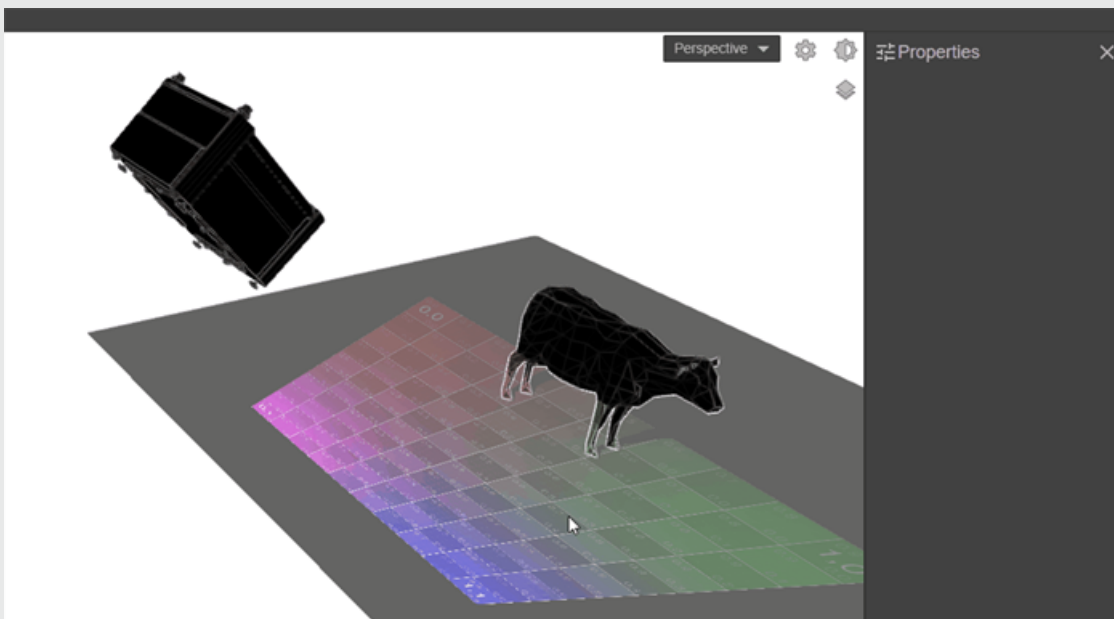

- By dragging around the *Target Point* (the Yellow Dot) of the Projector

Hold click on the **Target Point** of the Projector, and drag it around with your cursor.

- By aiming towards a Pin Point anywhere in the Scene

Click on the Projector's **Target Point**. Then on the **Pin Point** icon. And anywhere in the Viewport.

- Locking the Target Point



Select your Projector's **Target Point** and position it. Click on the **Target Point**, and enable the **Lock** icon. Now play with the **Position** and **Rotation** of your Projector.

## Projector Beam

Here you'll learn how to adjust the *Throw Ratio / Throw Distance*, calculate the *Illuminance* and *Pixel Size* at the Target Point, and also adjust the *Brightness Factor*.



TIP

You can turn On / Off the Power an individual Beam through its Projector's Shortcut Wheel (in the Viewport). Or in its **Properties**.

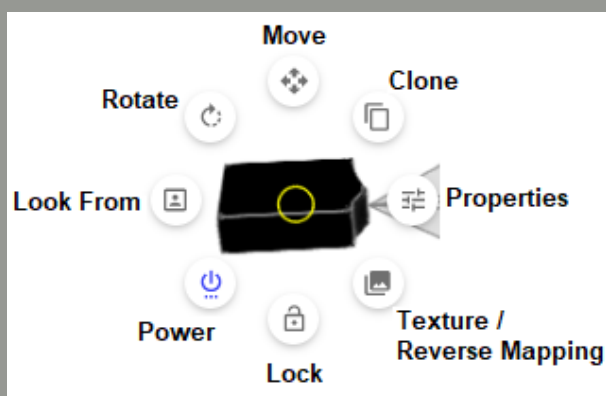

## Adjust the Width / Height / Throw Ratio

First, go to **Viewport Settings**, and make sure that **Show Projector Infos** is enabled.

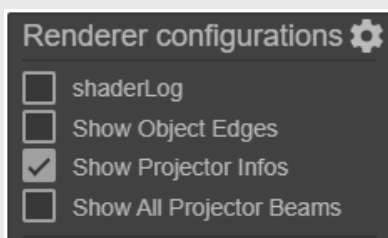

Adjust the Width / Height / Throw Ratio directly in the Viewport.

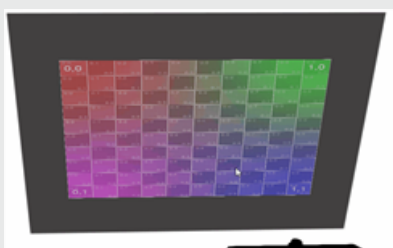

You can also adjust the **Throw Ratio** in the **Properties** panel. Just type-in a value, or hold-click on the input box and drag your cursor to adjust.

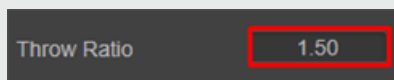

## Lens Shift

*Lens Shift* allows to deviate the optical axis of the Beam. Select your Projector. Go to its **Properties**, and to **Lens Shift**. **H** = Horizontal, **V** = Vertical.

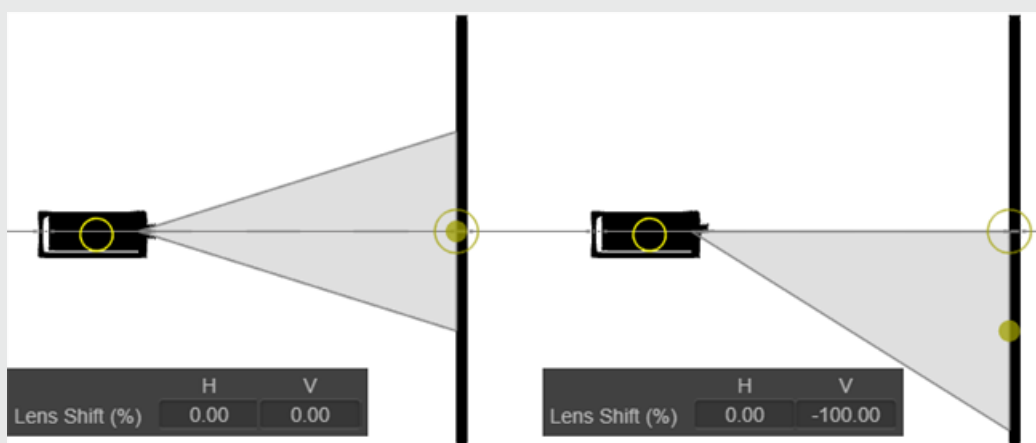

### WARNING

Our measurement reference is that 100% Shift represents 50% of the Image Height (or Width). This method is used by Barco and Christie. Other manufacturers may use another method (e.g. 100% Shift representing 100% of the Image Height).

## Throw Distance, Illuminance & Pixel Size

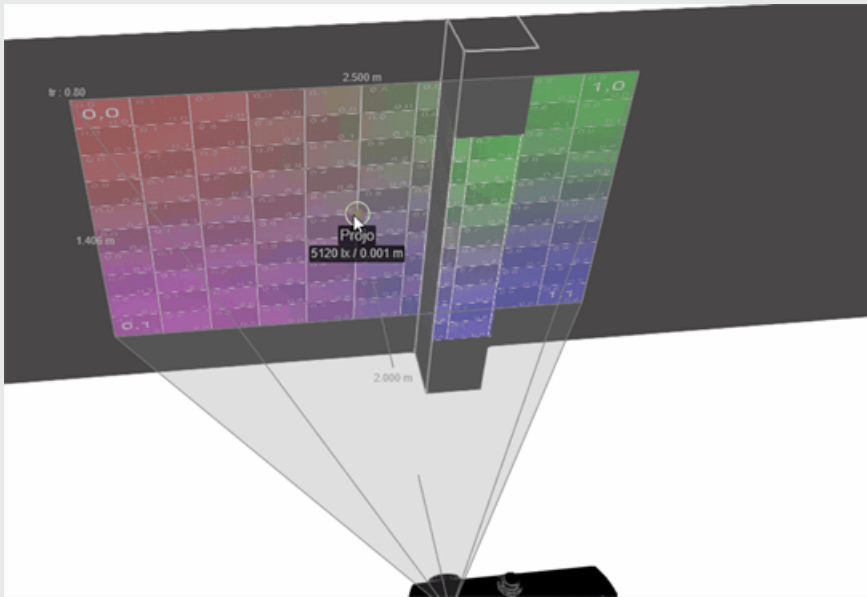

If the Beam's Depth axis hits no surface, Illuminance & Pixel Size will be calculated at its default Target Point.

But if it hits a surface, a new Target Point will be set at the intersection between the Beam's Depth axis and the given surface. Illuminance & Pixel Size will be automatically re-calculated.

**Illuminance** = value in Lux at Target Point.

**Pixel Size** = unit<sup>2</sup> at Target Point. Learn how to measure individual pixels using a Checkerboard, [here](#).

Illuminance (**Stretch**) = the angle will make it x% dimmer (on matt surfaces).

Pixel Size (**Stretch**) = the angle will make it x% bigger (Keystone effect).



TIP

You can override the automatic Target Point reset by manually typing-in any specific value for the Beam's Depth. (See the GIF above.) The minimum is 1m on manual, but it may be shorter on automatic.

## Adjust the Brightness Factor

This ratio is adjusting the total Lumens Output of the Projector.



TIP



A Projector's Lamp Life has a direct impact on the Brightness. The Brightness Factor is here to help you to integrate this reality.

Go to its Properties, and to the PROJECTOR menu.

Brightness Factor (%) 100.00

## Projector Image

The Projector Image refers to the visual content projected through the Beam.

Here you'll learn how to customize it with Images / Videos / Borders / Grid / Checkerboard.

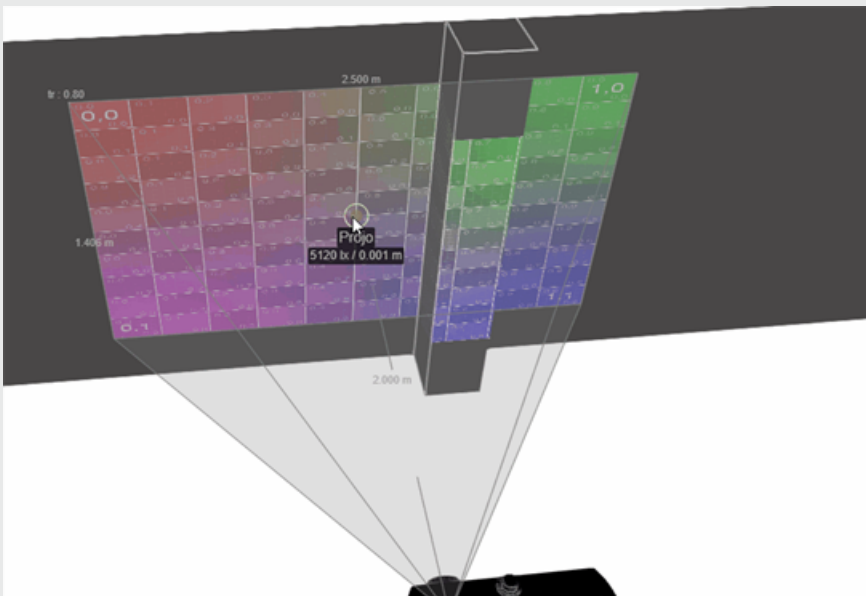

Select your Projector. Go to Properties > Projector > Projector Image

Use / Remove an Image (or Video)

Change the color of the Beam's borders

Add a parametric Grid



TIP

You can Look From any Projector. Using the Shortcut Wheel, or holding **Shift** while double-clicking on your Projector, or by clicking on the **Eye** icon from the **Scene Objects** panel.

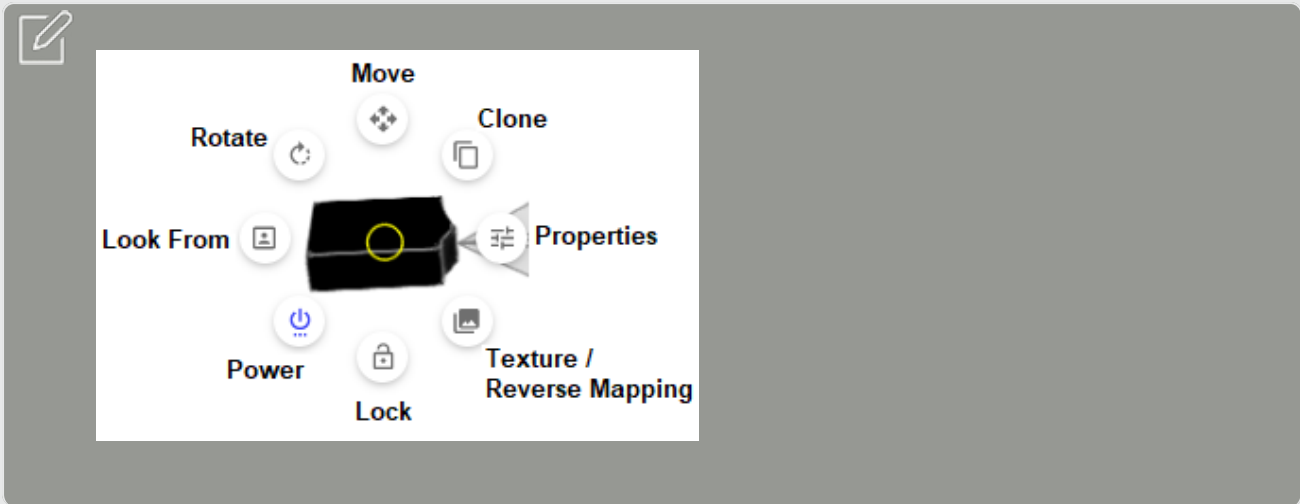

## Use / Remove an Image (or Video)

Click on the **Projector Image** button. You will have access to the Texture Library. It contains a collection of files that you may use for your Projector Image. You can also import your own files from your computer. Check how to use the Texture Library [here](#).

To remove a Projector Image, select your Projector and click on the Trash icon command.

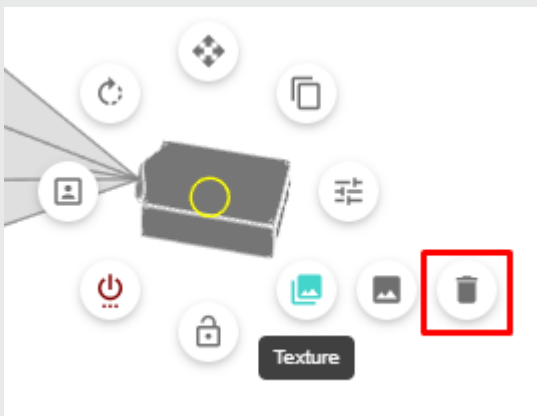

TIP

You can preview a video in the Viewport. Just hit the space bar to start / stop it.

There will be no sound.

## Use / Remove an Image (or Video)

Tick the **Border** box.

Click on the Color Bar and select a color.

To adjust the borders' thickness, type a value in the % input box.



TIP

A 5% border is a great way to represent Lens Tolerance.

## Add a parametric Grid

Tick the appropriate box : **Grid** or **Checkerboard**.



Adjust the input values for the desired amount of (Left) vertical and (Right) horizontal blocks.

Use the Checkerboard to measure down to 1 pixel.

## Projector Stack

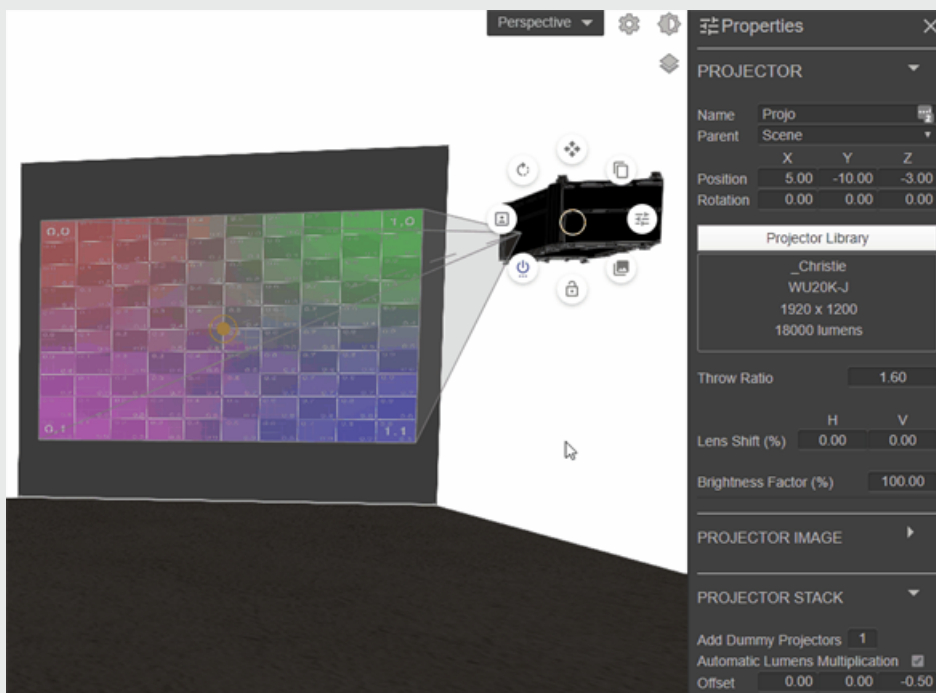

Select your Projector. Go to Properties > Projector > Projector Stack

Add any amount of dummy Projectors in the input box.

This will only create a dummy mesh and multiply the brightness.

Tick the “Automatic Lumens Multiplication” box (if you want to activate / de-activate the stacking effect on your Projector's Beam).

If activated, the Lumens output of your Beam will be automatically multiplied.

The Total Stack Lumens value will be displayed in the Properties panel.

You may change the position sequencing of all additional dummy Projector by changing the Offset values in the input boxes below.

Offset	0.00	0.00	-0.50
--------	------	------	-------

## Reverse Mapping

Reverse Mapping allows you to reveal the projected Texture onto an Object's surface.

The projected Texture may be applied as an Object's MATERIAL (Projection Map), or it may come from a Camera Projector.

*Reverse Mapping* is a powerful tool to quickly set perfectly mapped previews.

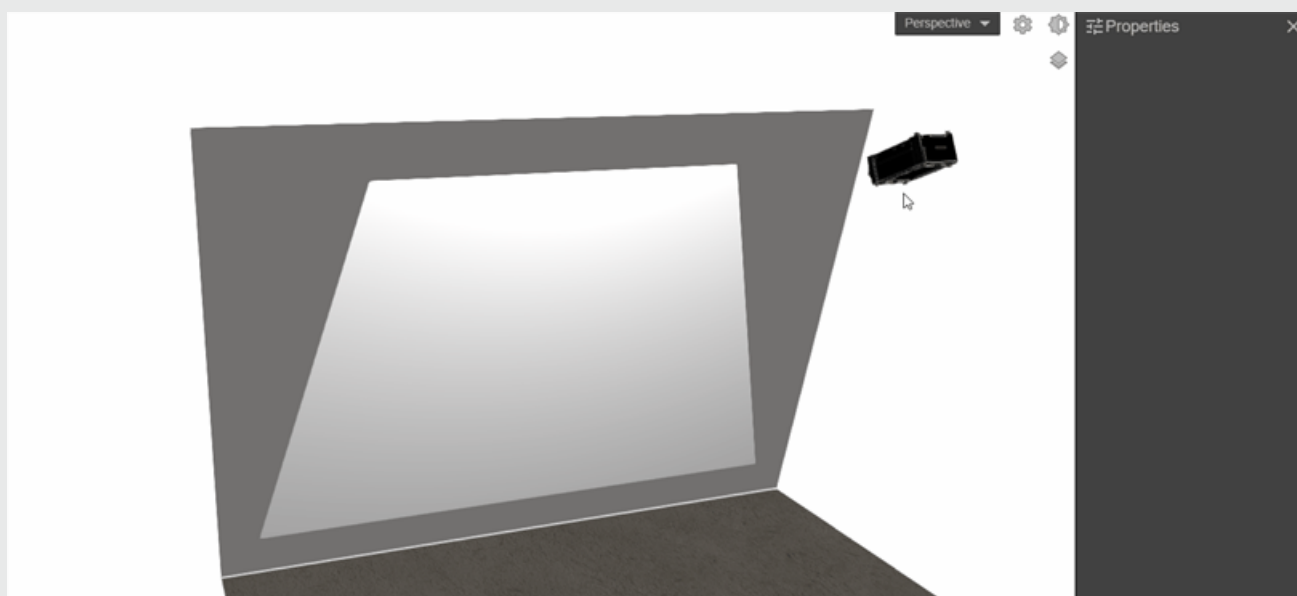

In this example, a projected Texture was applied on the wall and revealed by the Projector in *Reverse Mapping* mode.

## Activate Reverse Mapping on a Projector

Create or select a Projector.

Access its Shortcut Display in the Viewport.

Place your cursor on the Texture icon, and click on **Reverse Mapping**.



Now the Projector Beam will only reveal all projected Textures on the surfaces it hits.

## Use the Projection Texture tool

The Projection Texture tool allows you to simultaneously reveal all projected Textures from the whole Scene. No need for any Projector Beam.

Go to **Brightness Settings** and adjust the value (in lux).



TIP

This may help removing the brighter overlap between Beams.

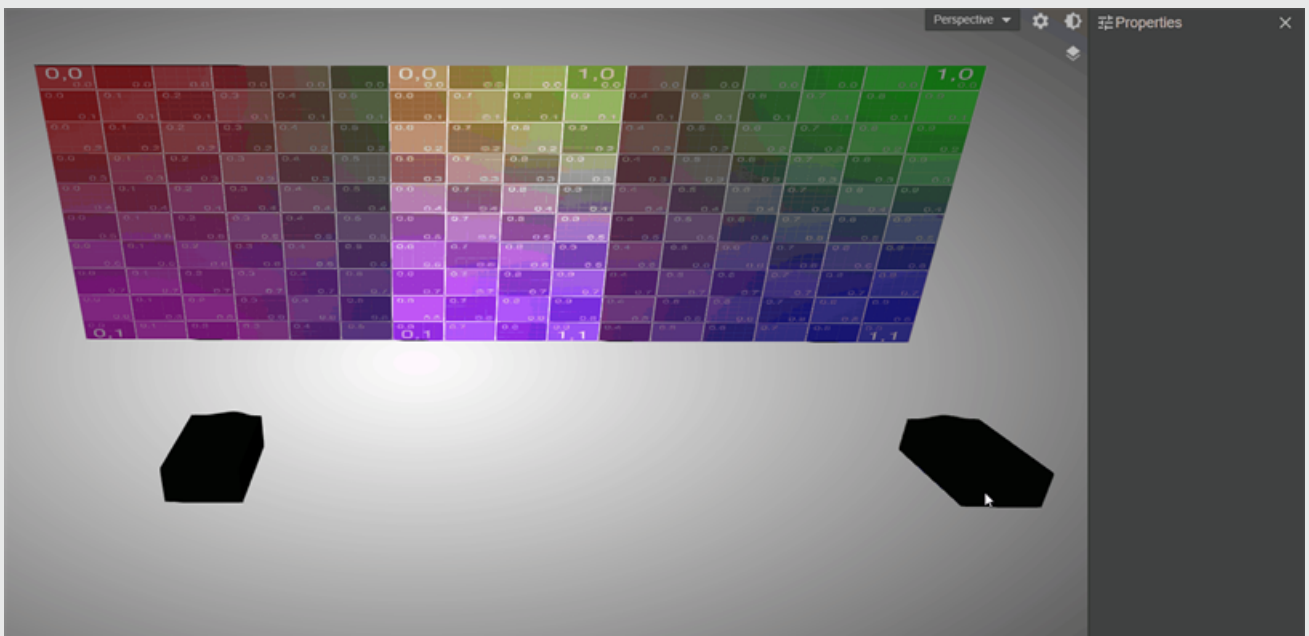

## Cameras

A Camera is a bodyless Object, no meshes attached.



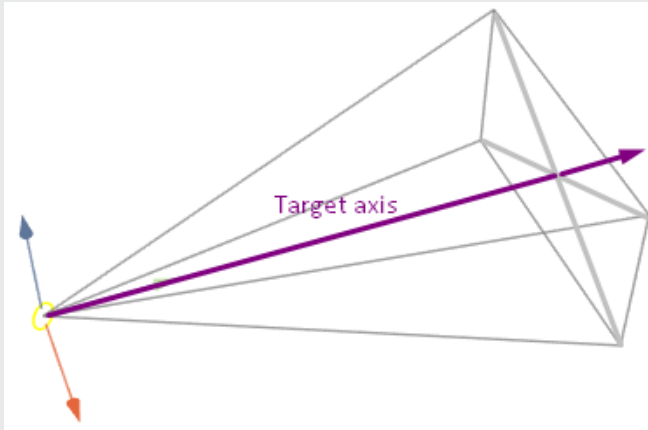

## Create a Camera

There are 2 methods to set a new Camera's position and orientation.

By default, creating it at the Center Point of your Scene.

TOP MENU > Projectors > Camera

It will be oriented towards the Scene's Y axis. Because its Target Point's position is by default (X=0, Y=2, Z=0).

Or from your current POV.

Go to  (in the top-right corner of your screen).

Select **Camera from View** in the dropdown menu.

## Set the Target Point of your Camera

A Camera's Target axis will always be automatically re-oriented towards its Target Point, regardless of your Camera's position in the Scene.

You can position the Target Point by typing-in its coordinates.

Select your Camera. Go to **Properties**, and to **Camera**.

Type-in the Target Point's (X, Y, Z) coordinates.

Target	0.00	0.00	0.00
--------	------	------	------

## Rotate your Camera's Field Of Vision (FOV)

The rotation will occur on the Target axis.

Type-in an angle value in the Roll input box, available in your Camera's **Properties**.

Roll 0.00

Example

Type-in 90 to have a 90° rotation, and get a portrait FOV.

## Adjust your Camera's FOV dimensions (Focal Length, Resolution)

The *Focal Length* simulates a standard camera's Lens Focal Length (in millimeters). The longer the focal length, the narrower the FOV values.

Adjust your Camera's Focal Length in its **Properties**.

Focal Length	35.00	
	H	V
Fov	62.727	37.849

The Resolution may also be customized in your Camera's Focal Length in its **Properties**.

Resolution (px) 1920 1080

The Horizontal (H) and the Vertical (V) will be proportional to your Camera's FOV, for its Width and Height respectively.

## Look from any existing Camera

You can switch your own POV to any of your Cameras' anytime.

Just go to **Scene Objects** and click on the **Look From** icon.

Camera 1   

To exit the Camera's POV, click on **Exit view**.

 Camera 1 ▾

## Use an Orthographic Camera

Orthographic translates into a flat FOV cone.

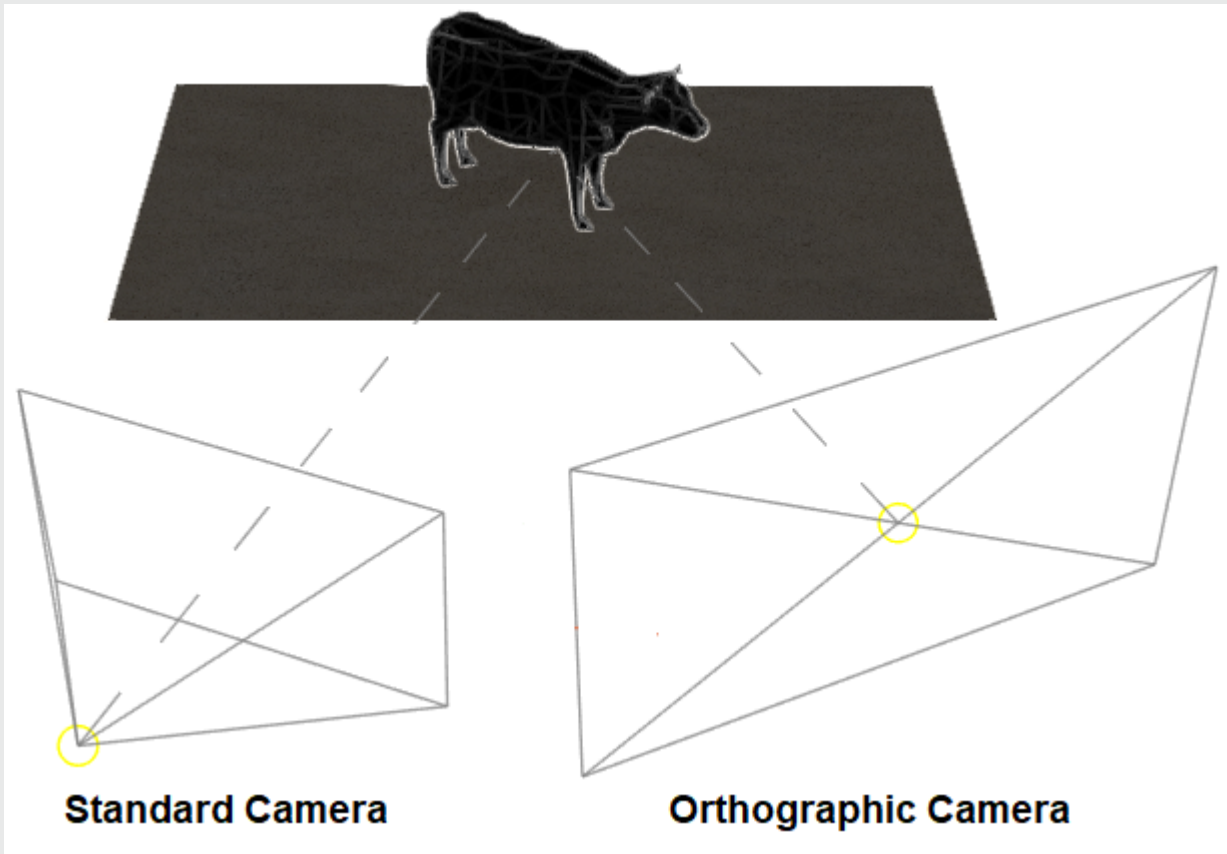

Go to Perspective ▾ (in the top-right corner of your screen).

Select among Top / Bottom / Left / Right / Front / Back

Go to TOP MENU > Viewport > Camera Settings to adjust its Position / Target / FOV.

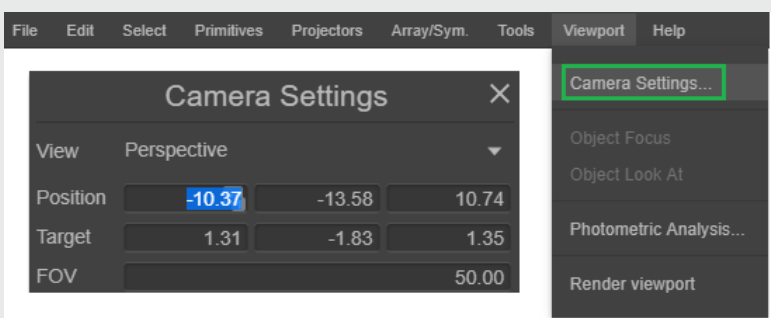

## Camera Projectors

A Camera Projector is a hybrid Object, it shares some features of both a Camera and a Projector.

It is also represented in the Scene by a *human silhouette* 3D mesh (Height= 180cm).

The FOV is represented by a pyramidal cone. The Field Of Vision's dimensions are defined by the Camera Projector's Focal Length and Resolution.

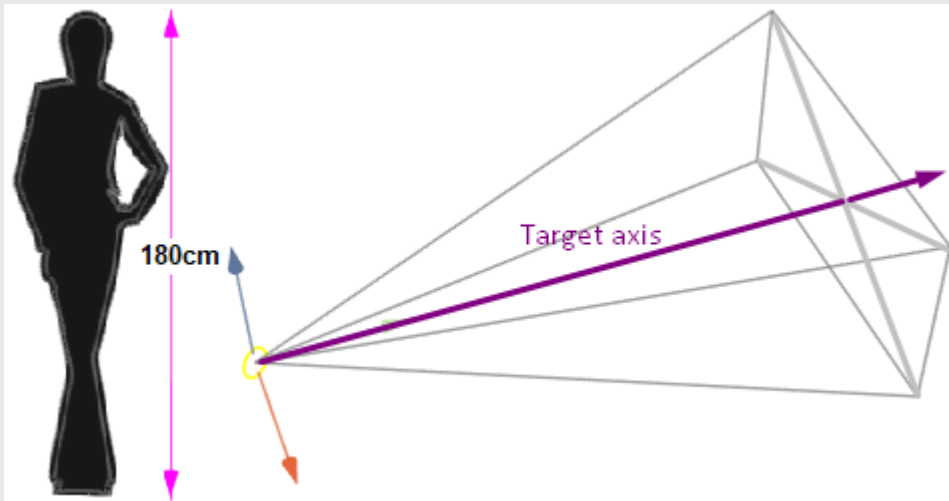

## Create a Camera Projector

You can only create it at the Center Point of your Scene.

TOP MENU > Projectors > Camera Projector

It will be oriented towards the Scene's Y axis. Because its Target Point's position is by default (X=0, Y=2, Z=0).

## Adjust your Camera's FOV dimensions (Focal Length, Resolution)

The Focal Length simulates a standard camera's Lens Focal Length (in millimeters). The longer the focal length, the narrower the FOV. And vice-versa.

Adjust your Camera Projector's Focal Length in its Properties.

Focal Length 55.00

The Resolution may also be customized in your Camera Projector's **Properties**.

Resolution 1 1

The Horizontal (**H**) and the Vertical (**V**) will be proportional to your Camera's FOV, for its Width and Height respectively

## Project a Texture from your Camera Projector (Projective Texturing)

*Projective Texturing* allows you to see how your Objects' surfaces need to be mapped, in order to produce a certain Image from a given Perspective.

This is particularly useful when you don't have any UVs on your 3D Objects.

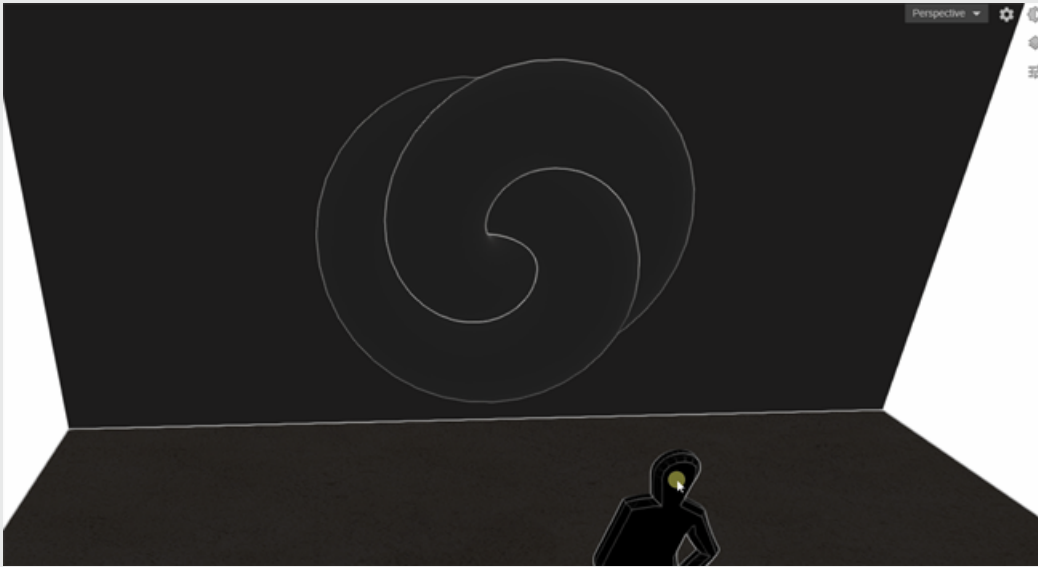

By default, the projected Texture won't be visible in the Viewport. It will have to be "revealed". Either by a Projector in [Reverse Mapping](#) mode, or using the [Projection Texture](#) tool.

Select your Camera Projector.

Go to its **Properties**, and click on Projector Image. (Or use the **Texture** shortcut icon, as displayed in the GIF.)

You will have access to the **Texture Library**. It contains a collection of files that you may use for your Camera Projector's Texture. You can also import your own files from your computer. Check how to use the Texture Library [here](#).

# Mapping Matter Viewport & Brightness

## Viewport/Brightness

### Viewport Settings

This helps you customize the visual information in your Scene.

Go to **Viewport Settings** (in the top-right corner of your screen).

### shaderlog

Enable / disable shaderlog.

This replicates *Luminance* as perceived by the human eye. It gives more detail in lower intensity, and less detail in higher intensity

### Show Object Edges

Tick the box to enable / disable it.

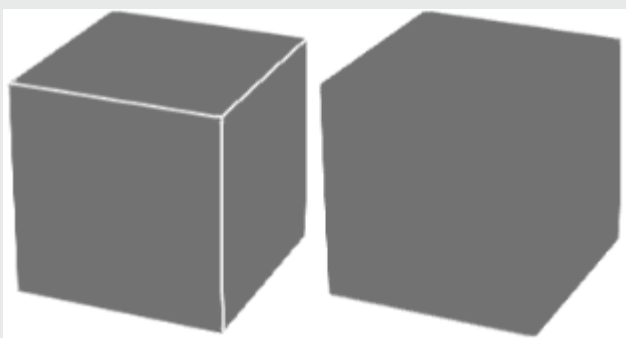

### Show Projector Infos

Tick the box to enable / disable it.

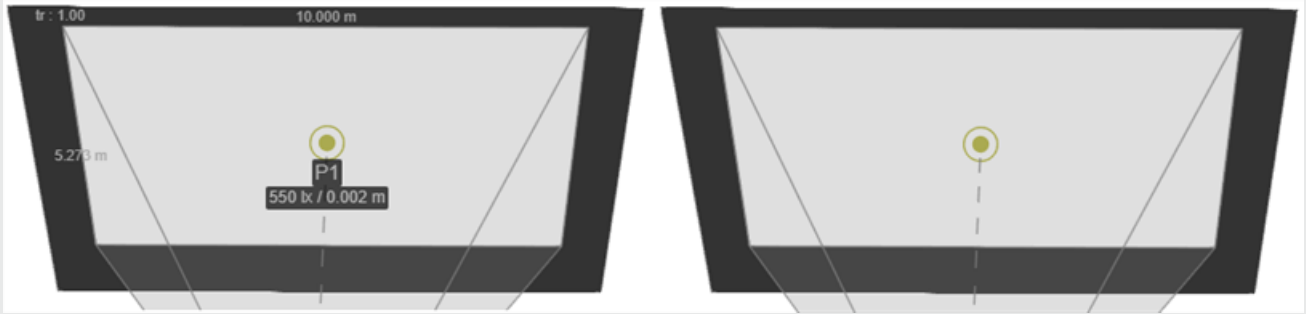

## Show All Projector Beams

Tick the box to enable / disable it.

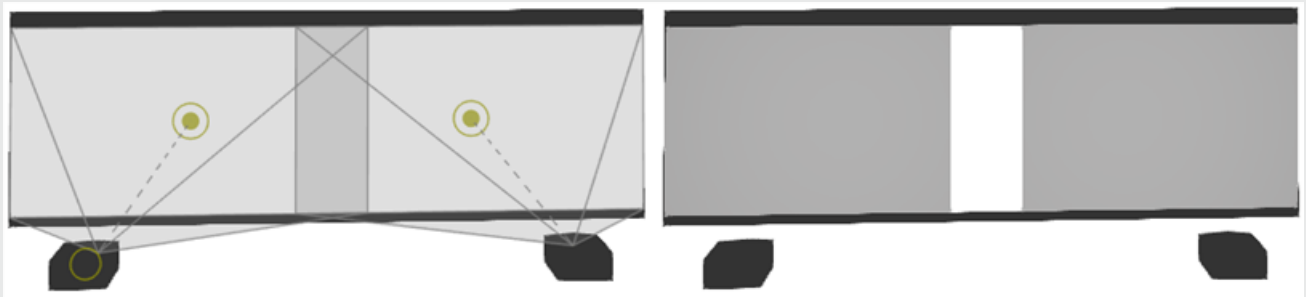

TIP

You can also turn On / Off the Power an individual Beam through its Projector's Shortcuts. Or in its **Properties**.

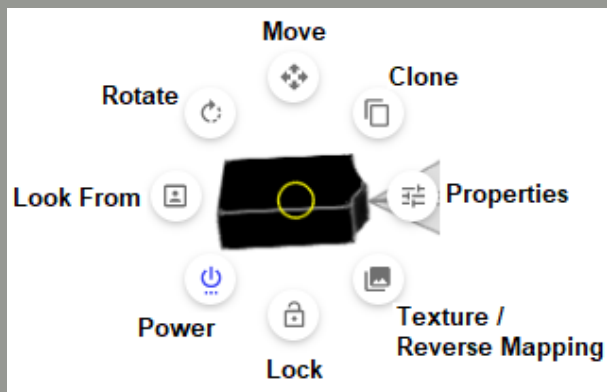

## Viewport Background

You can change the **Viewport Background** for both ergonomic or esthetic purposes.

Gradient adds a soft esthetic glow to your Background.

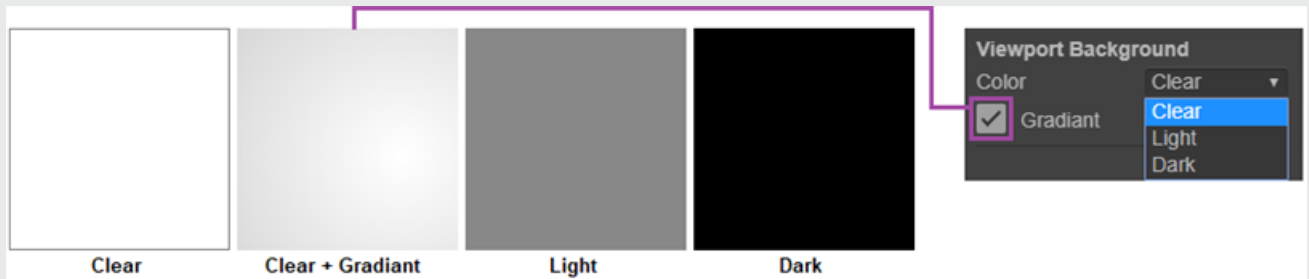

## Global Material Override

Some Objects may have a Material Override option enabled. This means you can "see through" them in the Viewport.

Learn about the Side Tool for Material Override [here](#).

This is a global effect. When enabled (with Double Side box ticked), all Material Overrides are suspended.

## Show Grid

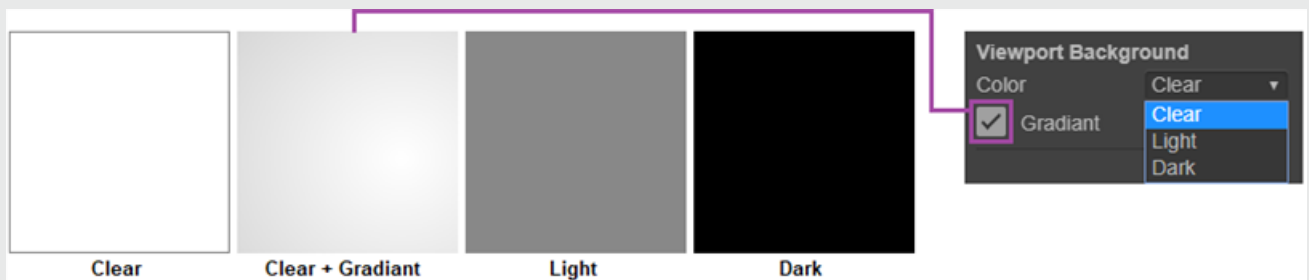

**Qte** = Quantity of Squares both Horizontal and Vertical.

**Size** = Unit Size of 1 Square.

**Sub** = Subdivisions of each Square.

## Projection Distance Helper

This tool helps you visualizing the distance variations between a Projector's Lens and the surfaces hit by its Beam. It will give you a better understanding of potential focus issues.



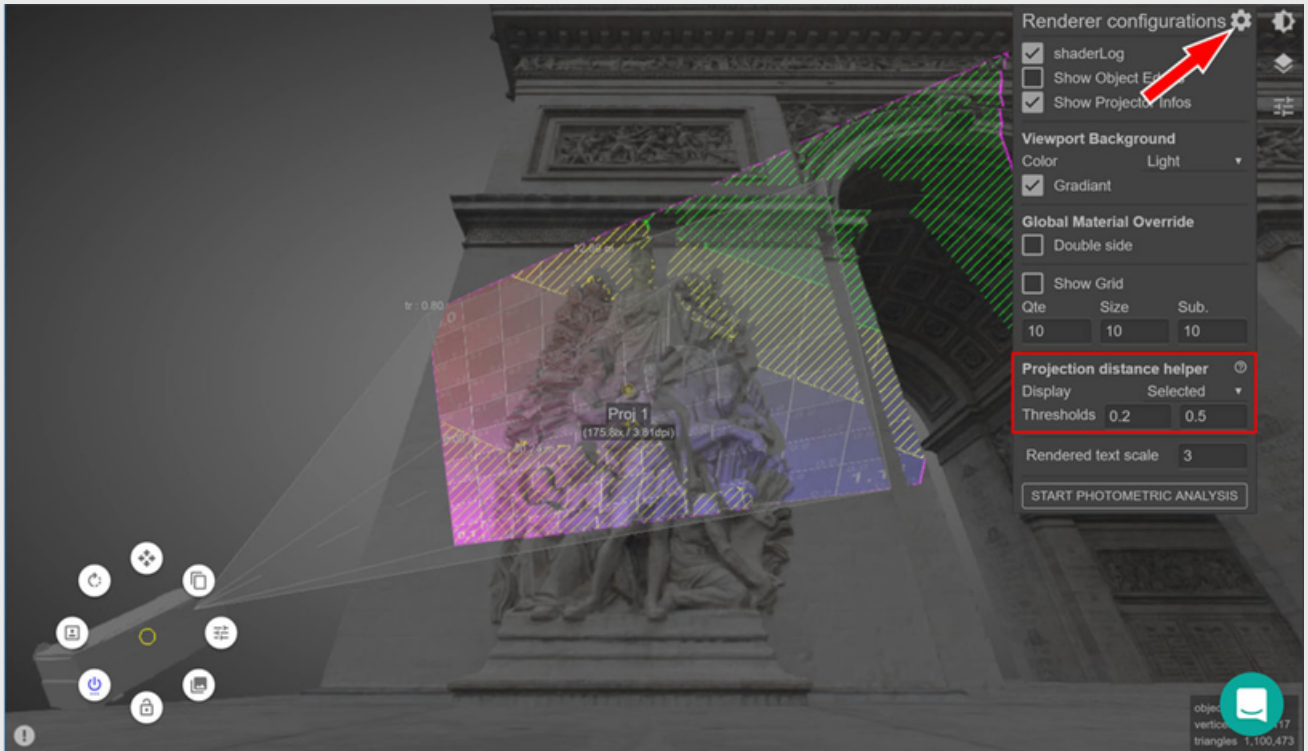

This is a global effect. When enabled, all Projectors apply it.

Go to Viewport Settings (in the top-right corner of your screen).

To disable it, go to the Display dropdown menu, and select **None**.

The two Thresholds parameters represent a fixed % value of the distance between any Projector and its Target Point.

### EXAMPLE

We have a Beam with a 10m projection distance.

Both thresholds are set to 0.1 and 0.3.

Consequently, the areas between 1m and 3m away from the Target Point will be hatched in Yellow. And when 3m away or more, it will be all Green.

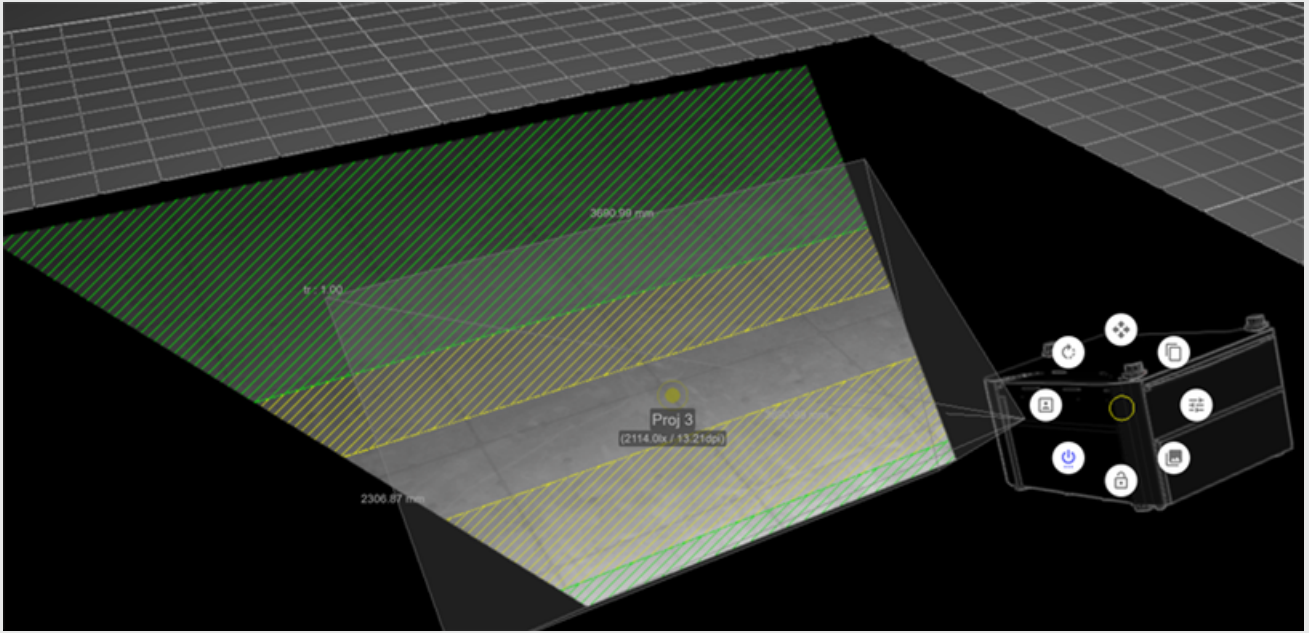

#### WARNING

This tool does not represent the real projection depth of field, or the minimum and maximum projection focus plane. But it's a simple and great way to flag potential focus issues.

## Photometric Analysis

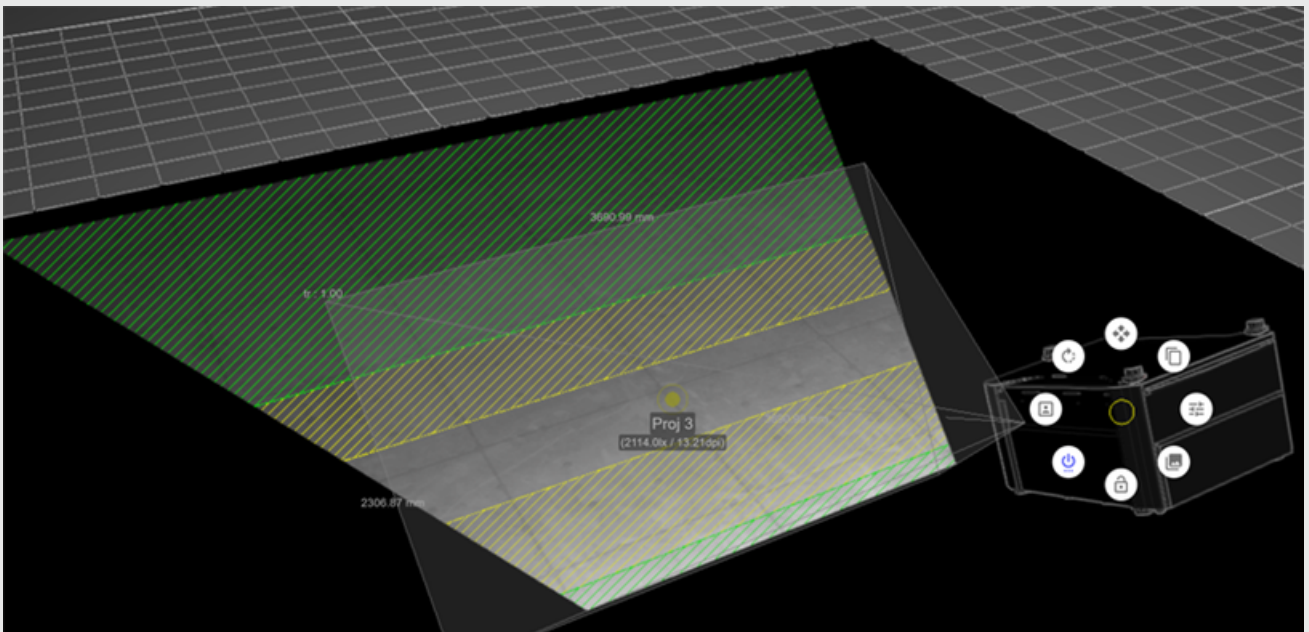

This tool allows you to evaluate both the *Illuminance* and *Luminance* on given surfaces in your Scene.

You can use this information to have an estimate of the Contrast Ratio on any surface. This will help you evaluate your needs in terms of Projection Light output.

Contrast Ratio = Projection Light / Ambient Light.



#### TIP

A 5 to 1 ratio is an indicative minimum for decent projection results. A 10 to 1 ratio is often pretty good.

In reality, this will vary in function of numerous factors such as the surfaces' characteristics. Therefore, conducting on-site tests will be essential.



#### WARNING

Photometric Analysis will exclude Ambient & Directional Light from its computation. You'll have to take that into account when estimating your Projection Light Output needs.

Start the **Photometric Analysis** mode either from the Viewport menu, or through the **Viewport Settings** panel.

## Evaluate Illuminance and Luminance

**Illuminance** = the amount of Light falling on a surface, per unit area.

The Object's Material and surface angle have no incidence on it.

**Luminance** = the amount of Light reflected from a surface, per unit area. Aka the Light Falloff.

The Object's Material (Gain / Color / Base Map) does have an incidence on it. The darker the surface, the lower the brightness.

The angle in which the Light Ray hits the surface also has an incidence. The wider the angle, the lower the brightness.

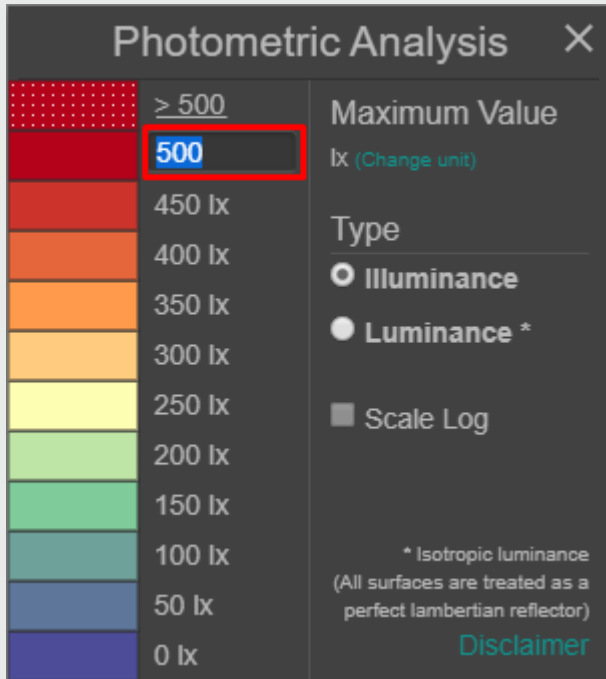

**Scale Max** is simply a reference value for all superior values in your Scene to show in a white-dotted Red.

You can also tick the **Scale Log** box to change the color distribution, as perceived by a human eye. It will give more details in the lower values, and less details in the higher ones.



TIP

Set Scale Max slightly above the Illuminance / Luminance value calculated at the Target Point. This info appears when Show Projector Infos (in Viewport Settings) is enabled.



WARNING

Changing the Color distribution with Scale Max / Scale Log does not affect the Brightness in your Scene. It simply presents you the same information on a different scale, allowing you to visualize variations as you please.

## Brightness Settings

To adjust global Brightness parameters in your Scene:

Go to **Brightness Settings** (in the top-right corner of your screen).

# Auto Viewport Range

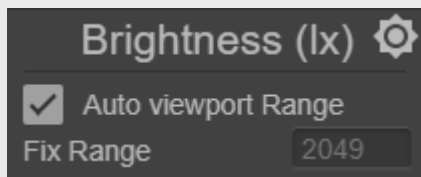

This will define a value range for both *Projection Texture and Ambient / Directional Light*.

When enabled, the range is set automatically. The max brightness (100% white) will be adjusted in function of the selected Projector's Illuminance value on its Target Point.

When disabled, the range has to be set manually.

## EXAMPLE

If we manually set 250 Lux, it will take 250 Lux to make any Object (which has a 1.0 Gain) 100% white. If it has a 0.5 Gain, 250 Lux will make it 50% white, etc. Same logic for Colors / Maps, the brighter the whiter.

# Projection Texture

The Projection Texture tool is global effect. It allows you to simultaneously reveal all projected Textures from the Scene. No need for any Projector Beam.

The projected Textures may be applied as a Material Projection Map, or emitted from a Camera Projector.

Adjust the value in lux.

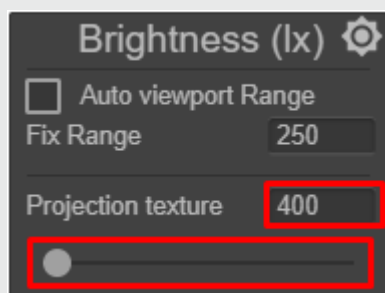

# Ambient / Directional Light

Ambient & Directional Light are global effects. applying on all Objects of the Scene.

Ambient Light = the Light is equally emitted from all directions.

Directional Light = the Light is emitted from 1 source only.

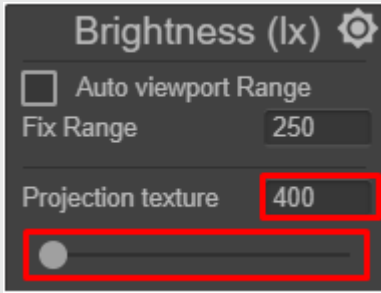

Set a value (type-in or drag to adjust).

Yaw = the direction angle of the Light source, orbiting around the Blue Z axis. 180° shifts it to the opposite direction.

Pitch = the direction angle of the Light source, orbiting around the Red X (or Green Y) axis.

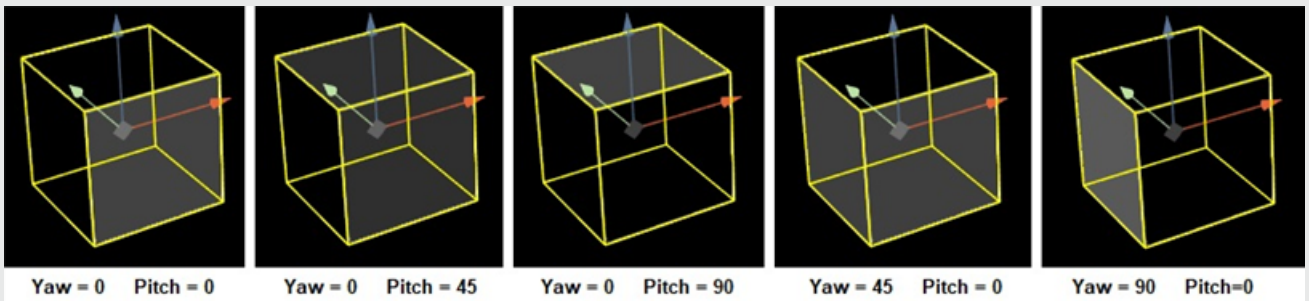

# Mapping Matter Libraries

## Libraries

### Scene Library

This is where you'll manage all your Scenes. You need to be already inside any Scene to access it:

TOP MENU > File > Open...

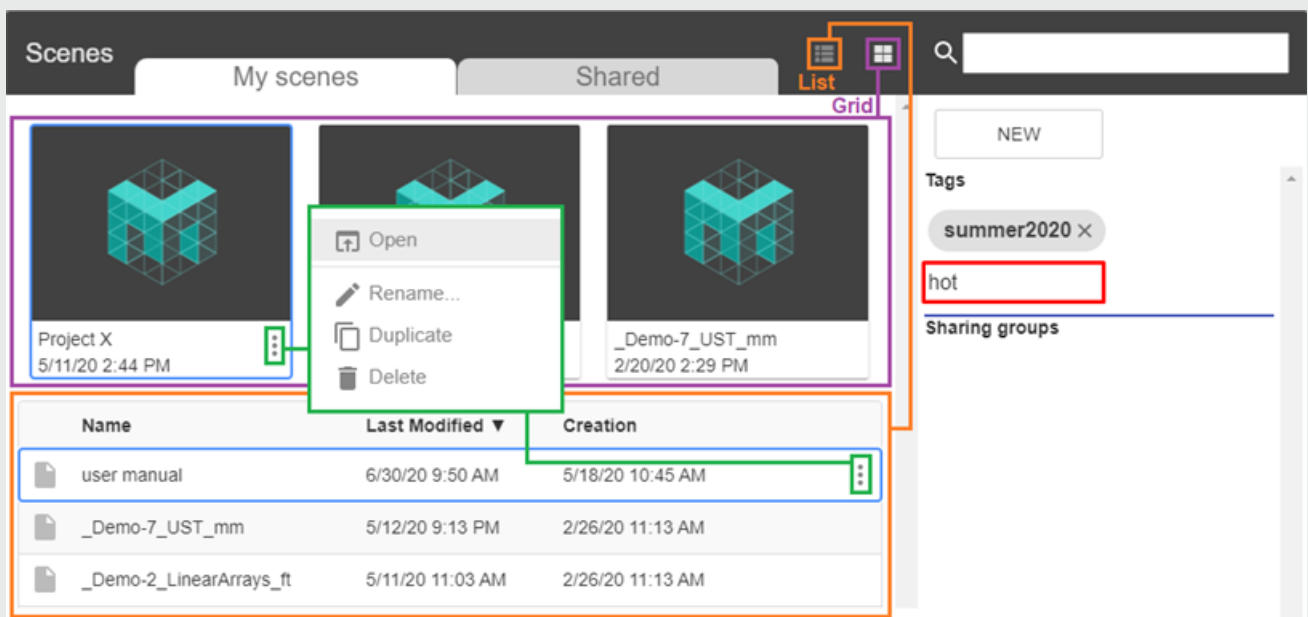

Here you can create / open / rename / duplicate / delete any Scene.

You can change the display of all Scenes from Grid to List.

You can sort them alphabetically / most recently used / by creation date.

Here's how to Share a Scene.

Click once only on any Scene to select it. Write any Tag and press Enter to save it.

## Use Tags not Folders

There are no sub-folders. But you can use Tags to easily organize your Scenes and later find them using the integrated Search engine.

## 3D Asset Library

This is where you'll manage all the 3D Assets to import into your Scene.

TOP MENU > File > Import 3D mesh Objects



### WARNING

For all updates to be effective in your Scene, you'll need to refresh your Browser.

## Select and Import a 3D Asset

To find an asset in the Library, use the Scroll bar or the Search engine.



To import a new file, click on IMPORT NEW.

Supported Formats = the best is .FBX(binary), .OBJ and .DAE work fine.

Meshes = a single asset may contain many meshes. They will be accessible as sub-Objects in the Scene Objects panel.

Max individual asset size = 100MB. You can load a bigger asset but only locally : it won't be saved online, and will need to be re-imported each time you open your Scene. To do so, hold Alt while clicking on Import 3D Mesh Objects.

Storage = all imported files will be stored in the My Assets Library.



### TIP

Learn how to share a 3D Asset here.

## Organize your 3D Assets

**Display Modes:** try switching it from Grid to List by clicking there.





Here's what the **Grid Mode** looks :

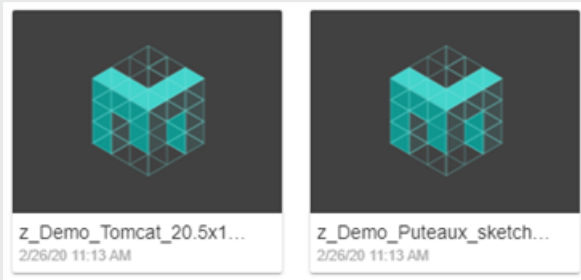



And here's what the **List Mode** looks like :

Name	Creation	Last use ▼
 z_Demo_Tomcat_20.5x10.obj	1/3/17 2:36 PM	2/26/20 11:13 AM
 z_Demo_Puteaux_sketchfab.comH...	6/13/16 2:31 PM	2/26/20 11:13 AM

**Rename / Delete** any asset by clicking here.

In the **Grid Mode** :

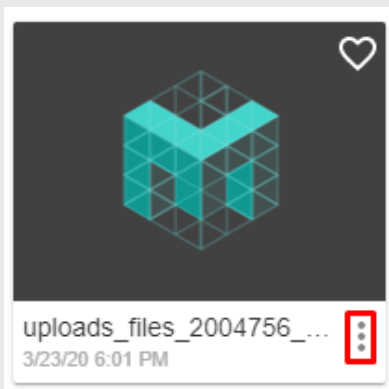

Or in the **List Mode** :

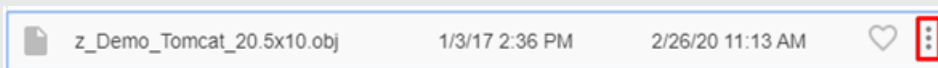

**Favorites:** click on an asset's Heart symbol to tag it as **Favorite**.

In the **Grid Mode** :



Or in the **List Mode** :



And activate **Favorite Only** to show all tagged assets:

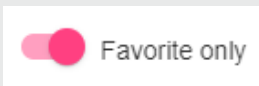

**Sort** your files.

In the **Grid Mode**, by most recently used, or alphabetical order.

Click on the Filter icon.

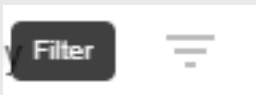

In the **List Mode** : by date of creation, last used, or alphabetically.

Click on the category title.

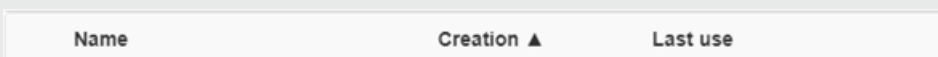

## 3D Asset Optimization

Mapping Matter is not primarily designed for performance. If you work with heavy / complex 3D Assets, we strongly recommend to optimize your files before import. Otherwise, the Browser may crash (especially for computers with small GPU).

Here are a few tips. We'll use Blender, but this is easily transposable to any advanced 3D modeling software.

**Delete all unnecessary meshes**

In Blender, switch to **Edit Mode** to delete.

### Delete all unnecessary vertices

In Blender, go to Edit Mode > Mesh > Clean Up > Delete Loose. Or select & delete them manually.

### Merge some ( or all) your meshes

Select them, holding Shift. Press Ctrl + J to get them joint.

Export in .FBX(binary) from your 3D software to Mapping Matter

.FBX(binary) will load much faster in Mapping Matter, and often be lighter. .OBJ / .DAE will also work fine.

File Size : max 100mb. Learn [here](#) how to upload bigger files (locally only).

## Projector Library

Mapping Matter is not a Projector Database. However, we provide you with a few demo Projectors.

Here you'll learn how to create and manage your own Projector Library.



### WARNING

Refresh your Browser to see Projector Library updates applied in your Scene.

## Manage all pre-existing Projectors

TOP MENU : Projectors > Projector

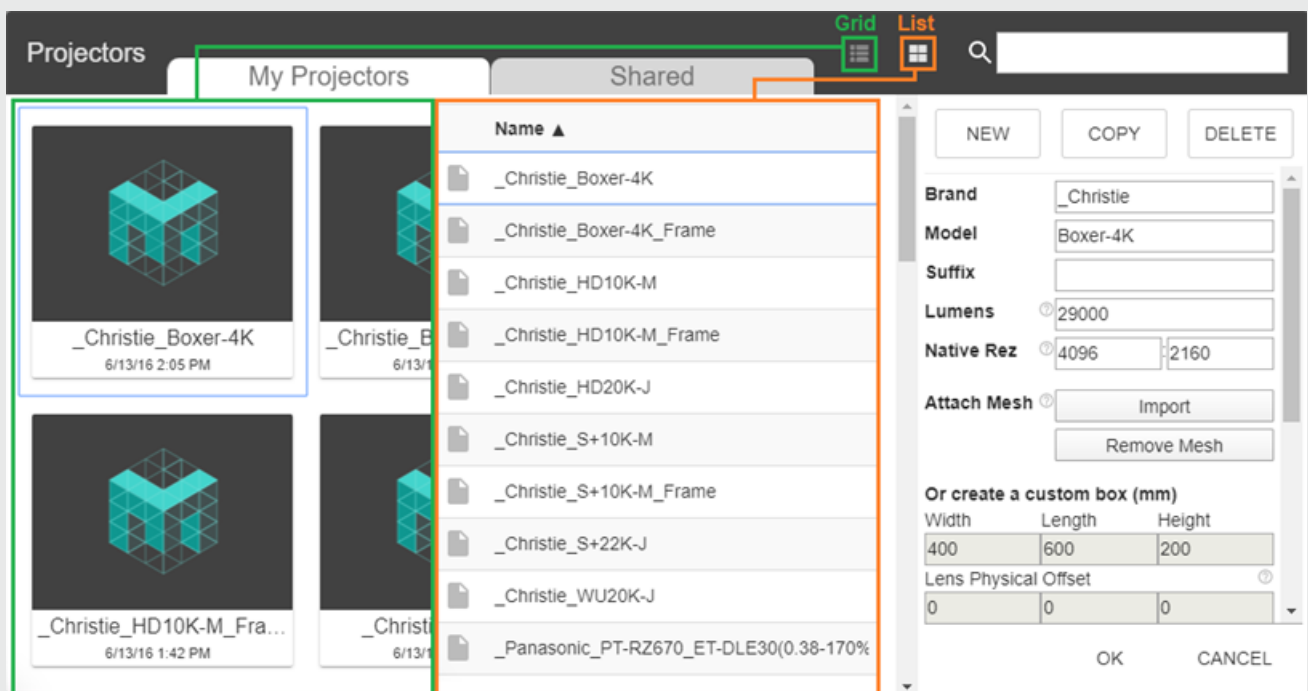

INFO

- You can display all Projectors in two modes: **Grid** or **List**.
- Sort them by Name or Creation Date, only in the **List** Display mode.
- Use the Search engine to find Projectors quicker.
- Use Tags to find them quicker in the Search engine.

## Add a custom Projector to your Library

TOP MENU : Projectors > Projector

Click on **New**. And define its Specs in the section below.

For the Projector's body, you can either Attach Mesh or Create a custom box.

The screenshot shows the 'Projector' creation dialog box with the following fields and options:

- Buttons: NEW, COPY, DELETE
- Brand: New Projector
- Model: (empty)
- Suffix: (empty)
- Lumens: 4000
- Native Rez: 1920 x 1080
- Attach Mesh: Import
- Or create a custom box (mm):
 

Width	Length	Height
400	600	200
- Lens Physical Offset:
 

0	-600	100
---	------	-----

Annotations and diagrams:

- REQUIREMENTS** (orange box):
  - single mesh .OBJ file
  - in millimeters
  - Z-up
  - front panel facing Y
  - Lens nodal point at origin
- Diagram 1 (purple box): A 3D view of a black rectangular box with a lens origin at the bottom-left-front corner. The lens rays are shown projecting from the origin. Labeled: **(0, 0, 0) Offset**.
- Diagram 2 (purple box): A 3D view of a black rectangular box with a lens origin at the bottom-left-back corner. The lens rays are shown projecting from the origin. Labeled: **(0, -600, 100) Offset**.



### WARNING

If you still don't see your mesh despite exporting it in millimeters, you may have to multiply its scale (before exporting it from your C4D software). Sometimes, the file may be read as way tinier than it is. Try multiplying its scale by 100x or 1000x.

After importing your file, try refreshing your browser and/or clearing your cache.



### TIP

For odd Lens configurations (Ultra Short Throw / Mirror), check [this article](#).

Finally, click on OK to create your Projector in the Scene.

Your new Projector and its Specs will be saved in your Projector Library.

## Texture Library

The Texture Library contains your collection of Image and Video files.

This will be used to map an Object's *Material*, define a *Projector Image*, or do *Projective Texturing*.



### WARNING

For all updates to be effective in your Scene, you'll need to refresh your Browser.

## Select and Import an Image / Video

To find a file in the Library, use the Scroll bar or the Search engine.



To import a new file, click on **Import New**

Supported Formats = JPEG / WEBP / GIF / PNG / BMP / ICO / MP4 / WEBM / OGG

Maximum file size = 50MB

All imported files will be stored in your Texture Library.



### TIP

Learn how to share a Texture [here](#).

## Organize your Texture Library

You can use different tools to organize your Texture Library.



**Display Modes:** try switching it from **Grid** to **List** by clicking on the corresponding icons.

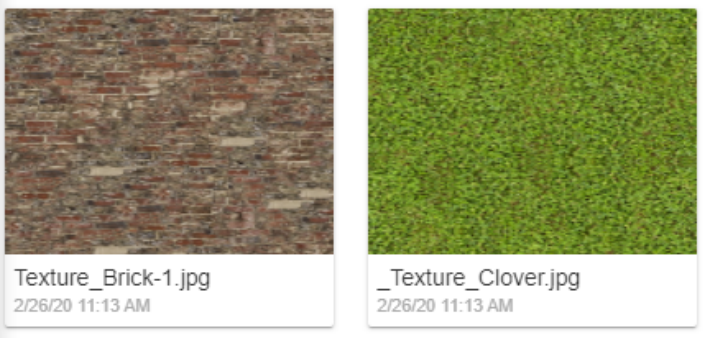

Here's what the **Grid Mode** looks :



And here's what the **List Mode** looks like :



Name	Creation	Last use ▼
 _Texture_Concrete-4.png	1/3/17 2:19 PM	2/26/20 11:13 AM
 _Texture_Grid-10x10.png	6/16/16 2:46 PM	2/26/20 11:13 AM
 _Video-Sintel-1080p.mp4	6/16/16 1:55 PM	2/26/20 11:13 AM

**Rename / Delete**

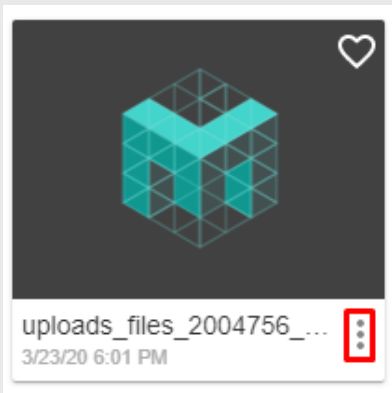
In the **Grid Mode**:



Or in the **List Mode** :



 _Texture_Concrete-4.png	1/3/17 2:19 PM	2/26/20 11:13 AM	 
---	----------------	------------------	---

**Favorites**

In the **Grid Mode**:



Or in the **List Mode** :

Name	Creation	Last use ▼
 _Texture_Concrete-4.png	1/3/17 2:19 PM	2/26/20 11:13 AM
 _Texture_Grid-10x10.png	6/16/16 2:46 PM	2/26/20 11:13 AM
 _Video-Sintel-1080p.mp4	6/16/16 1:55 PM	2/26/20 11:13 AM

And activate **Favorite Only** to show all tagged files :

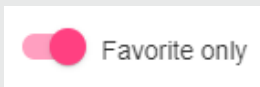

**Sort your files.**

In the **Grid Mode**, by most recently used, or alphabetical order.

Click on the **Filter** icon.

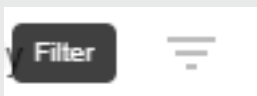

In the **List Mode** : by date of creation, last used, or alphabetically.

Click on the category title.

Name	Creation ▲	Last use
------	------------	----------

# Mapping Matter Share

## Share



### WARNING

To share any Scene / individual Asset, you'll first need a Group Sharing Folder.

For us to create one, please reach out at [support@disguise.one](mailto:support@disguise.one)

Your teammates may need to refresh their Browser to receive the copies.

## Share a Scene

When you share a Scene file, it will also copy all of its assets (Projectors, Textures, 3D Objects, etc...).



### WARNING

You'll need to be the creator of the Scene. If it was shared with you, only a duplicate version of it can be shared.

**This option won't be accessible from the Home Page. You can do it through the Scene Library.**

Access the Scene Library : TOP MENU > File > Open...

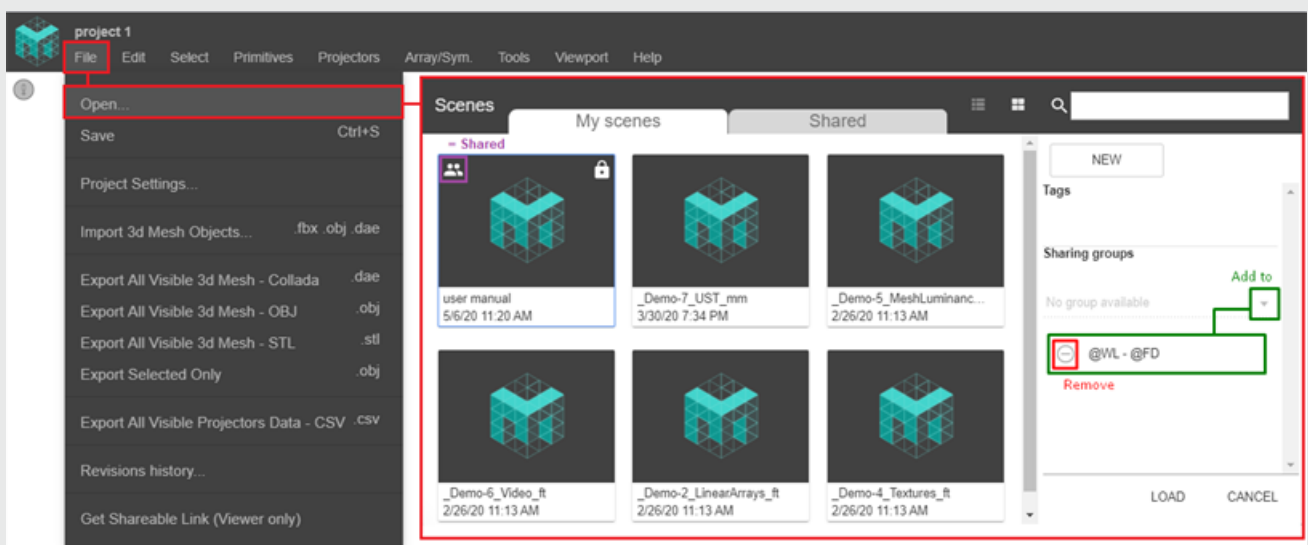



## Share an Asset

## Share a Projector

TOP MENU > Projectors > Projector

Select a Projector > Add it to any Group Sharing Folder

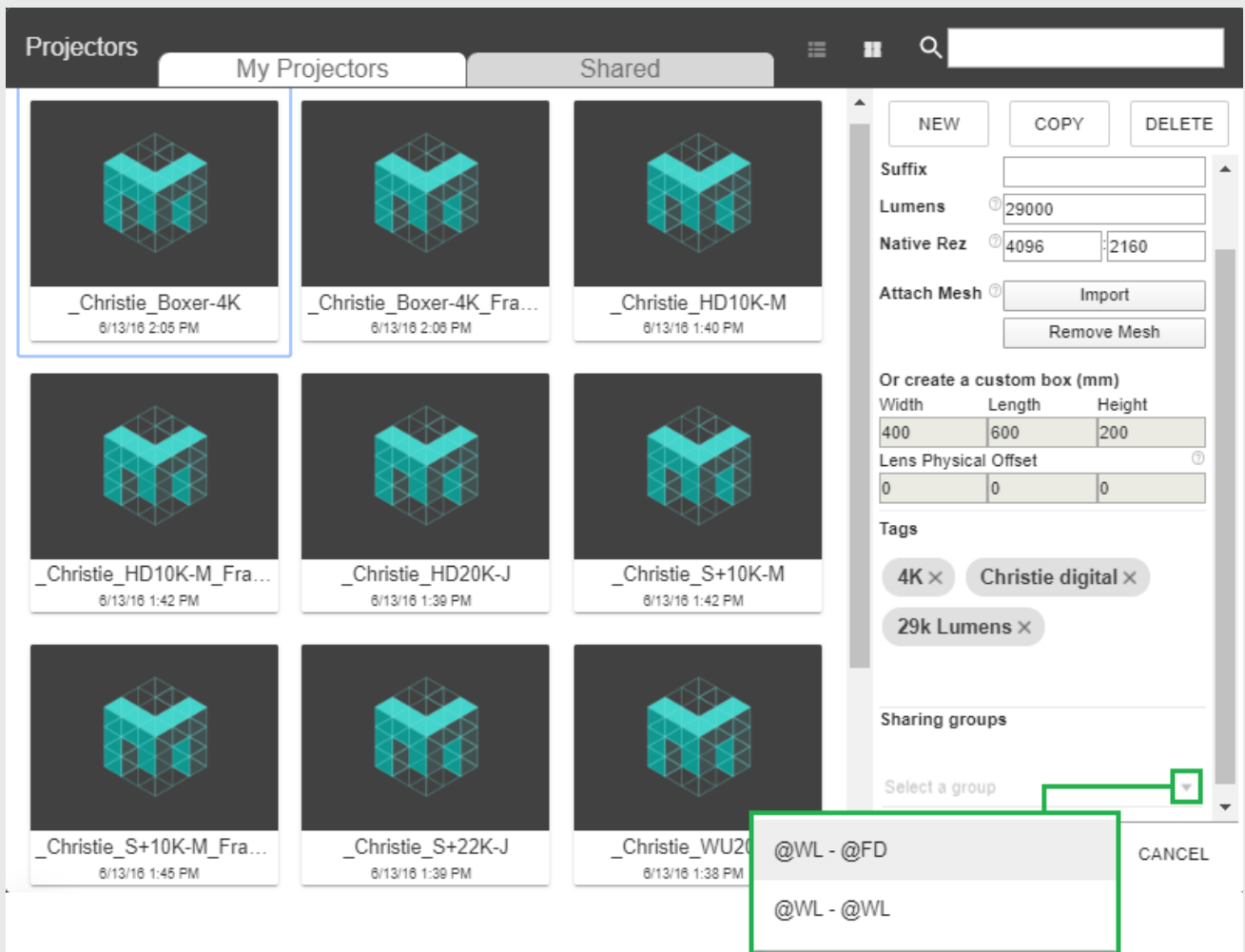

## Share a Texture

You'll have access to the [Texture Library](#) through different paths.

Select a Projector > Properties > Projector Image

Select a Primitive > Properties > Base Map (or Projection Map).

Select a Texture, and add it to any **Group Sharing Folder**.

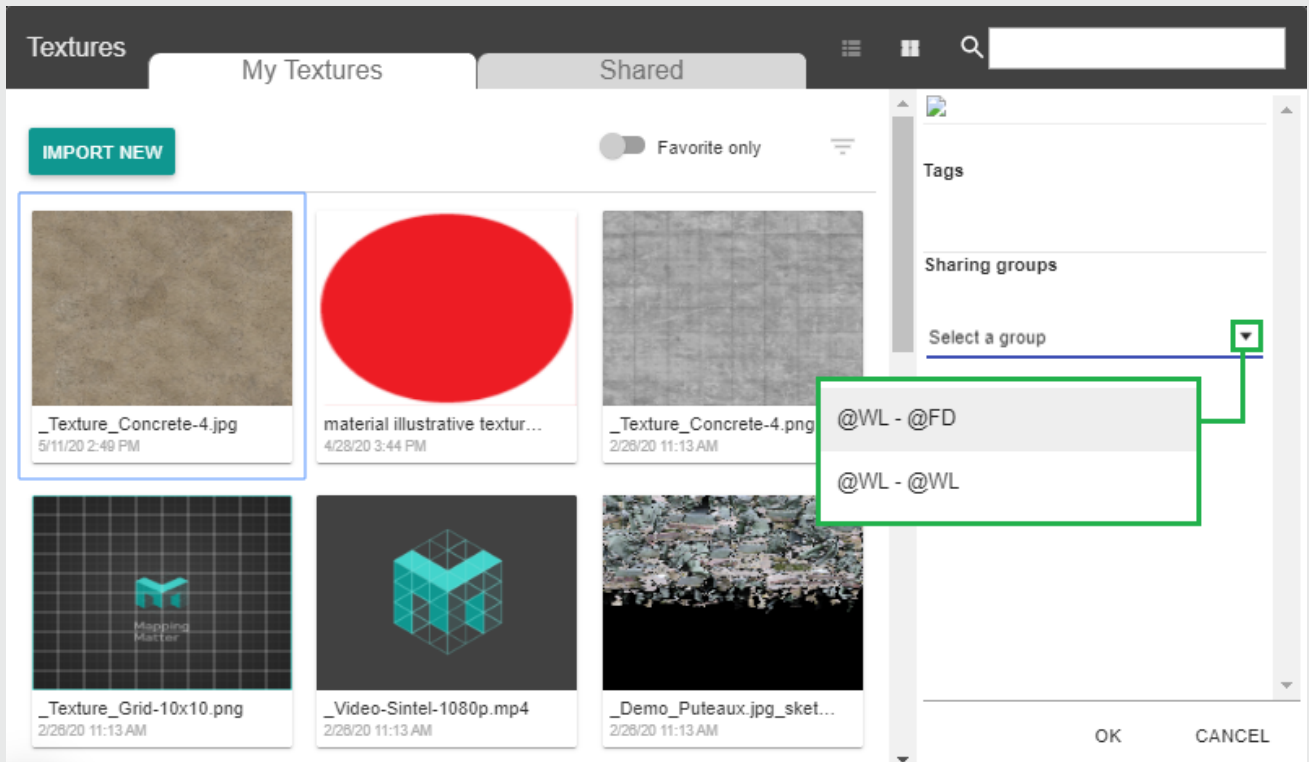

## Share a 3D mesh

TOP MENU > File > Import 3D Mesh Objects

Select an Asset, and add it to any **Group Sharing Folder**.

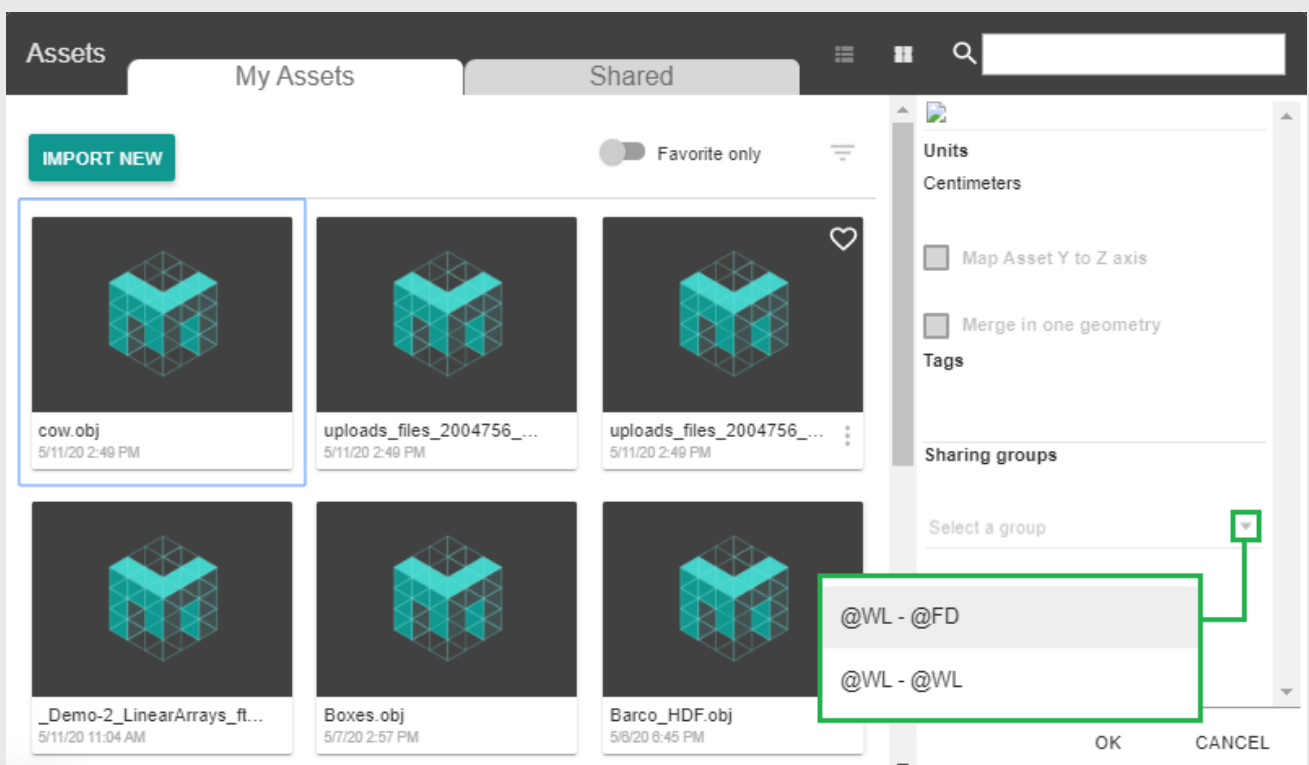

# Share a Viewer Only link

For anyone with the Link and Password to view your Scene and possibly previewing their own Content there.

## How to generate a Viewer Only link

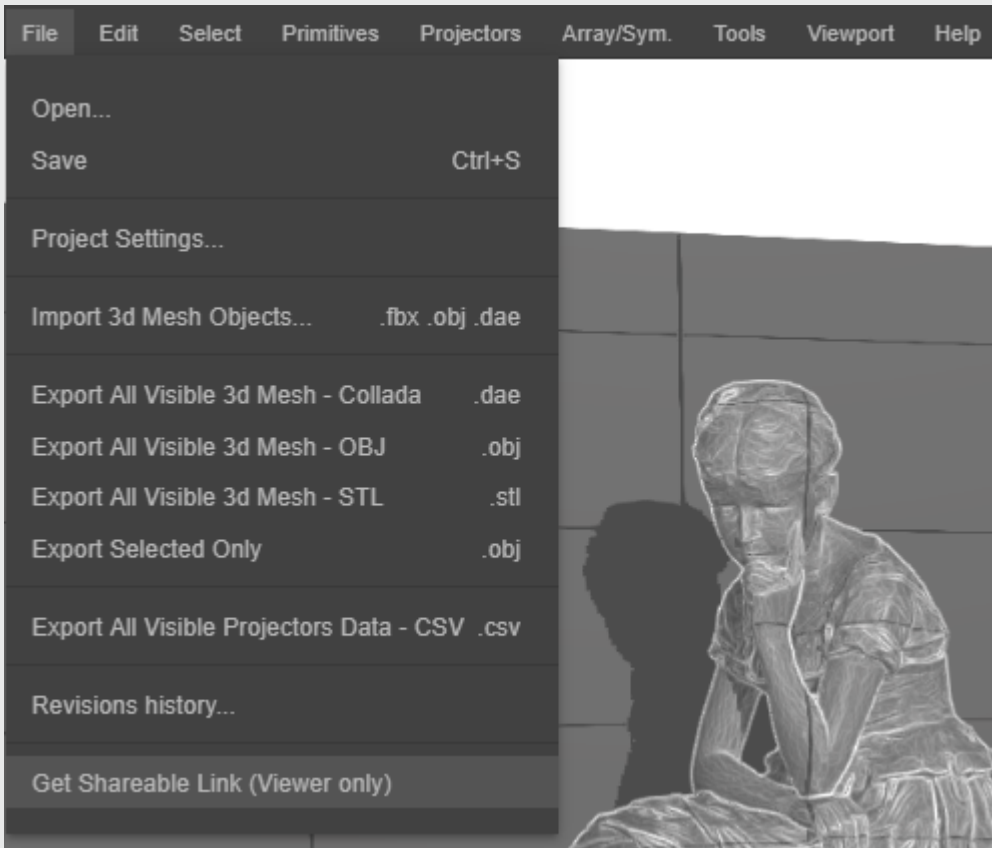

TOP MENU > File > Get Shareable Link

Tick the **Enabled Box**, and type-in a password.

## How to operate on the Viewer's Landing Page

All people with the Link can preview their own Content on Reversed-Mapped Objects.

Imported Content will only apply on Objects which already had Content (Image / Video) as *Projection Map*.

The *Projection Map* has to be revealed in your Scene, either by a Projector in *Reverse Mapping* mode, or with the *Projection Texture Tool*.



# Mapping Matter

## Print & Export

### Print/Export

#### Snapshots / PDF Layouts

## Save a Snapshot from your Scene

Adjust your Perspective in the Viewport.

TOP MENU > Viewport > Render Viewport

This will save a high resolution .PNG Image of your current *Viewport Perspective*.

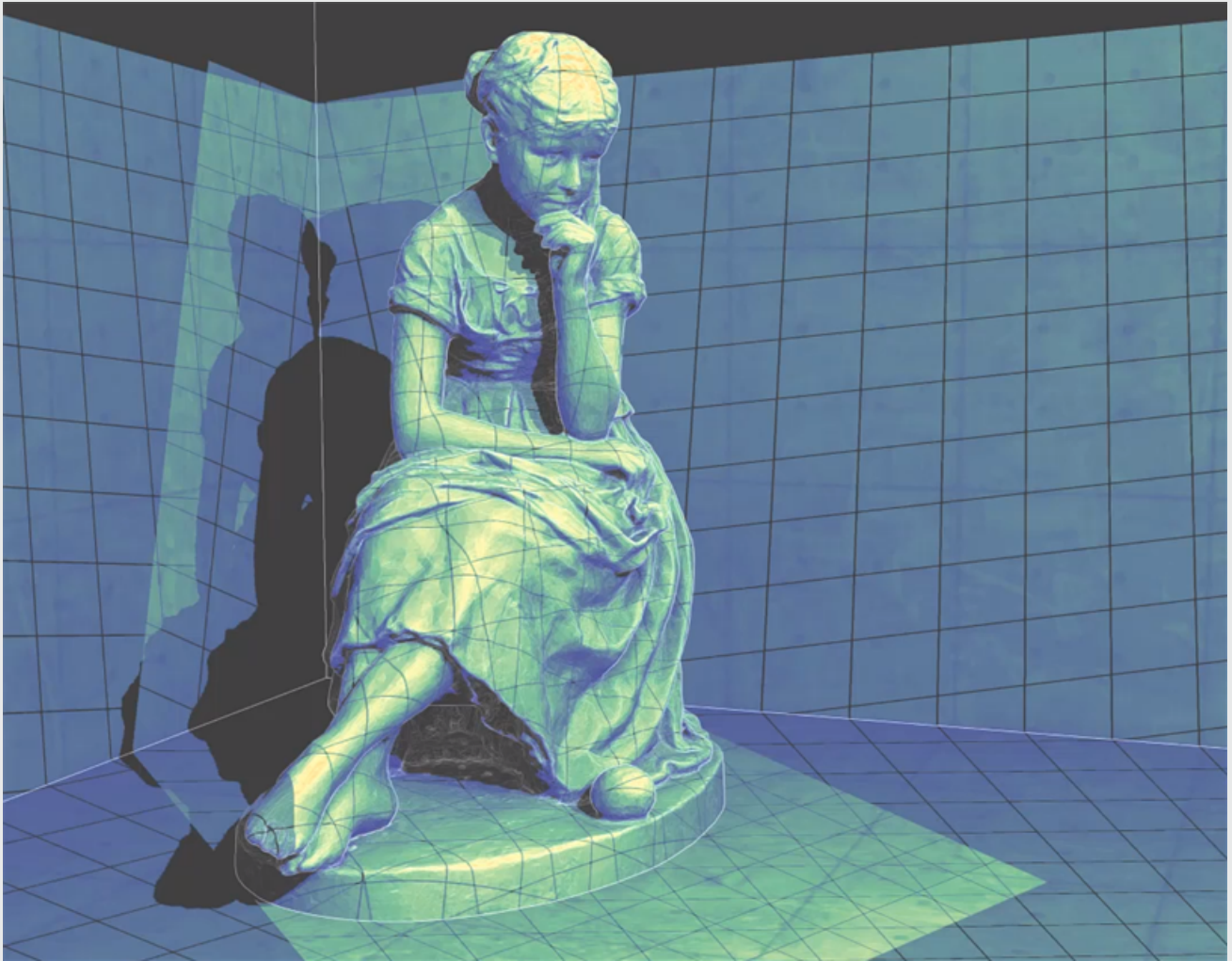

Create a PDF Layout (and a Projectors' List)

Go to **Scene Objects**, in the **PDF layout** section.

Select a Layout Template, or create a new Template.

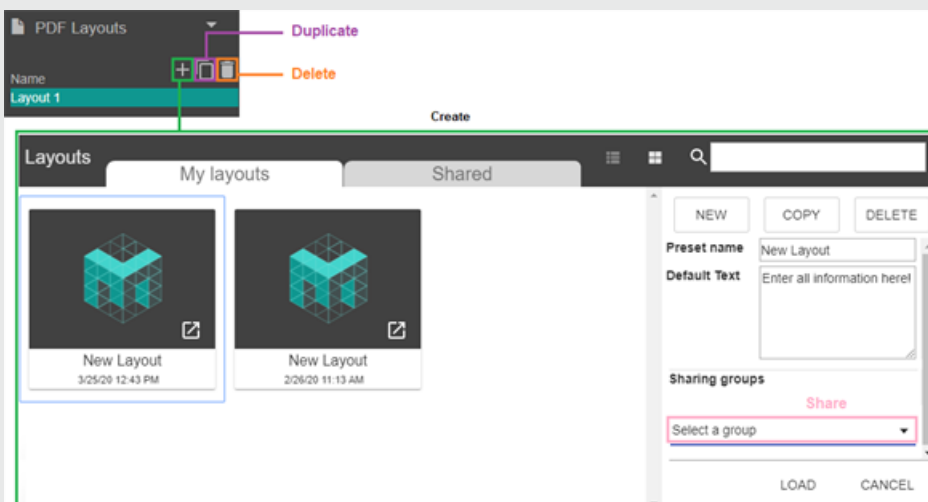

You'll have your own Template Library. You can **Share** any template, or use one from **Shared With Me**.

Go to its **Properties** panel.

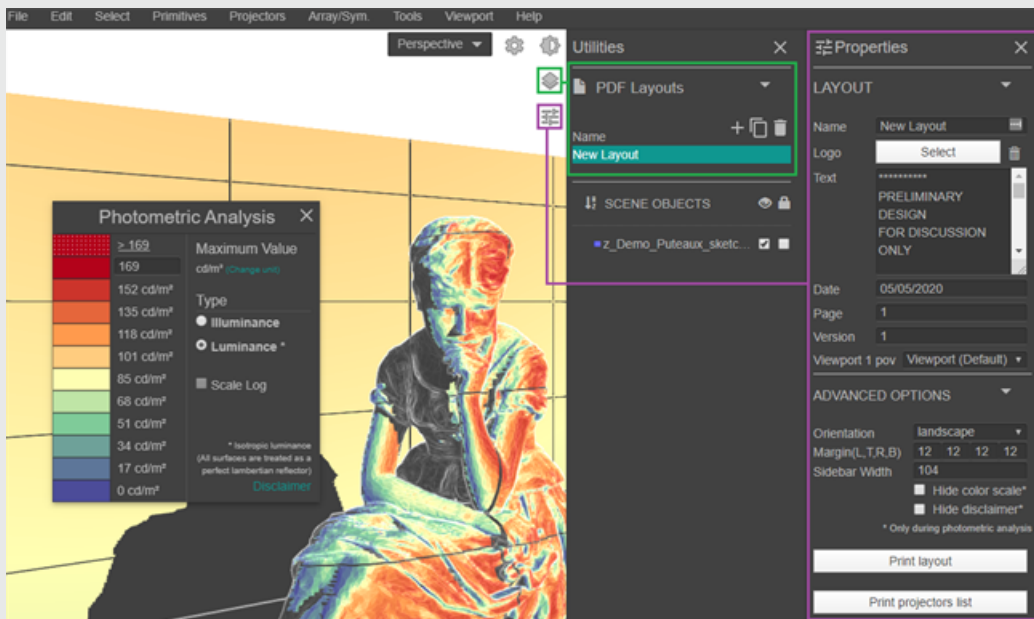

By default, the Illustration Image will be taken from the Perspective POV. You can also select a Camera's POV in the **Viewport 1 pov** section.

Click on **Print layout**.

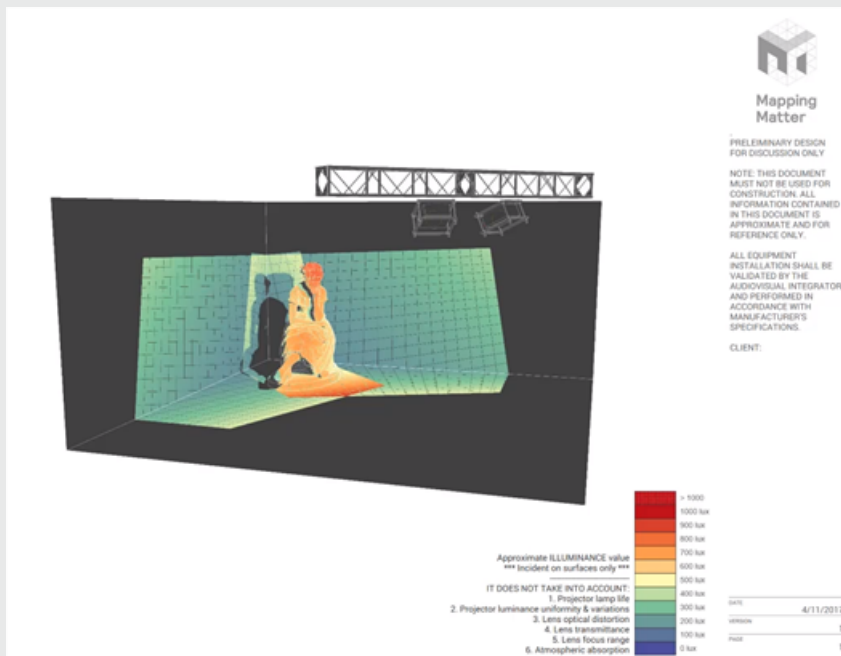

Click on **Print projectors list**.

This will include information about all your Projectors in the Scene (Specs & in-Scene adjustments).



Name	Qty (Stack)	Brand	Model	Native Rez.	Lumens	Throw Ratio		Lens shift			Position(m)			Rotation			
						H	V	X	Y	Z	X	Y	Z				
Proj A	1	Christie	S+10K-M Frame	1400 x 1050	10500	1.13	0%	0%	-1.93	-2.94	4.53	-25.00°	0.00°	-22.70°			
Proj B	1	Christie	S+10K-M Frame	1400 x 1050	10500	1.13	0%	0%	-2.93	-2.01	4.53	-25.00°	0.00°	-67.00°			

## Export All Projectors Data (.CSV file)

TOP MENU > File > Export All Visible Projectors Data - CSV

This creates a .CSV file that you can transpose into all advanced professional media servers which support a 3D environment.

**Mapping Matter**  
CSV Projector Export 24/05/2019

Projector Name	Projector_Count(Qty)	Projector_Name/Proj_X	Projector_Name/Proj_Y	Projector_Lumens	Projector_Programm(%)	Projector_Rotat_Lumens	Projector_TiltRate	Lens_Shift(H%)	Lens_Shift(V%)	Lens_X	Lens_Y	Lens_Z	Pitch(deg)	Yaw(deg)	Roll(deg)	Target_X	Target_Y	Target_Z	Target_Distance	Target_Width	Target_Height	Target_Illuminance	Unit_Dim	Unit_Lumens	Projector_UUID	
_Green	1	1920	1200	10000	100	10000	1.25	0	0	3.5	-3	4	-45	20	-90	2.400	0	0.807	4.515	3.612	2.257	1226	13.5	m	lux	5213709-8F0C-439C-8E3-81C81888188
_Red	2	1920	1080	18000	100	36000	1	-50	50	-1	-5	1	0	0	-1	0	1	5	5	2.813	2560	9.75	m	lux	84D5800D-CC43-4395-8813-0E044F78153D	
_Blue	1	1920	1200	6500	100	6500	0.38	0	170	0	-1	5.5	0	0	100	0	0	5.5	1	2.632	1.645	1502	18.53	m	lux	736594F0-AE5A-448E-887E-8E10FA512871

Lens\_X Y Z Point at the projector "Nodal Point" ( Beam Apex )  
 Target\_X Y Z Point in front of the projector "On Axis" ( Beam End )  
 Rot Projector orientation ( 90 or -90 = Portrait )  
 Unit\_Dim Options ( mm, cm, m, inch, foot )  
 \* All values are approximate and for reference only







TIP

Here's how the Mapping Matter integration works in Disguise.

## Export 3D meshes

You can export All Visible (or only Selected) 3D meshes in a single file.

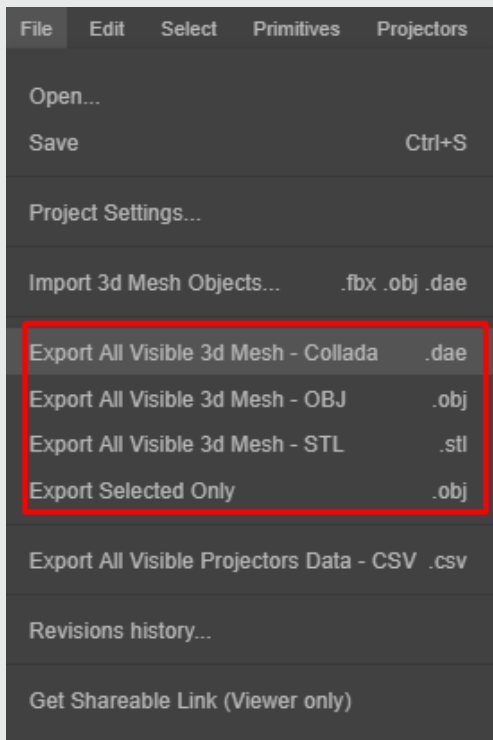

### WARNING

If you want your Projectors' Beams to be included in your export, first make sure **Show All Projector Beams** is enabled in the **Viewport Settings** panel.

# Mapping Matter My Account

## My Account

### Profile (User Name, Change Password, Notifications)

You cannot change the e-mail associated with your account. If you need to use a new e-mail, please sign up again.

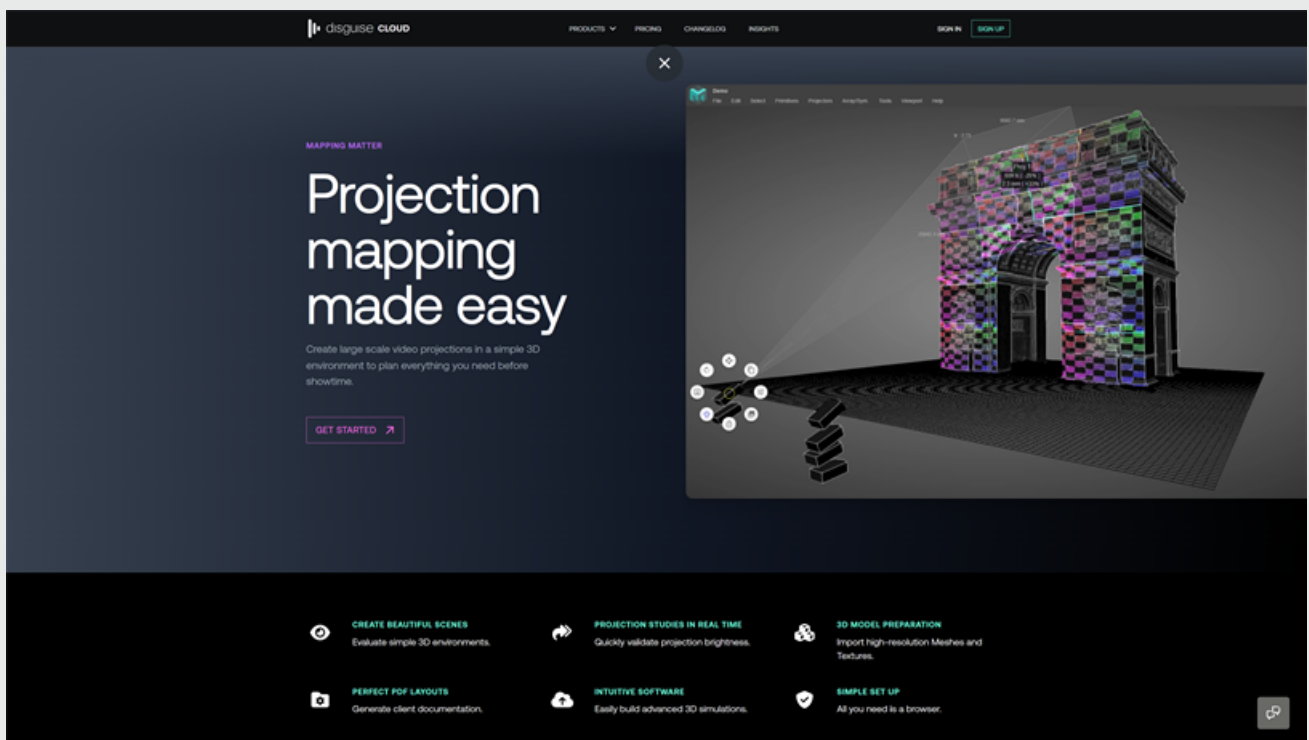

## Subscription

If you want to get (or modify) a Subscription, or obtain any information (e.g. expiry date), please reach out to [support@disguise.one](mailto:support@disguise.one).



# Mapping Matter FAQs

## FAQs

### Keystone

There's no Keystone tool in Mapping Matter. To quickly set perfectly mapped previews of your Content projected on any surface, you can use the Reverse Mapping Mode There will be no distortion / loss of image quality.

### Ultra Short Throw

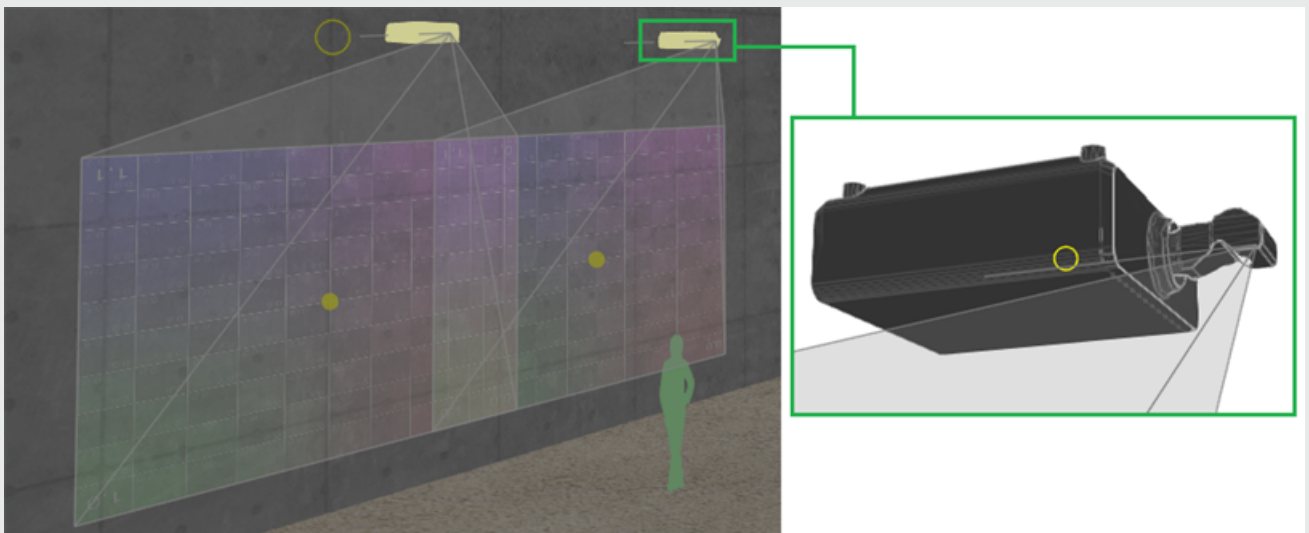

Here you'll learn how to simulate odd lens configurations (often used for Ultra Short Throw), such as *Reverse Mirror* or *Snorkel*.

# The Reverse Mirror type



## WARNING

You can design your Projector's mesh in another CAD software, and import it. Or you can directly create a basic custom box in Mapping Matter.

Create a single "joint" .OBJ body mesh in any CAD software, following all requirements below.

- Must have the axis Z-up. (Some softwares have Y-up.)
- It **MUST** be set in millimeters.
- Nodal Point must be at the Center (0, 0, 0) of your .OBJ file.

The Projector's front panel should point towards the +Y axis. Note that the its body may be oriented however you like, it will simply be attached to the Light Beam in Mapping Matter.

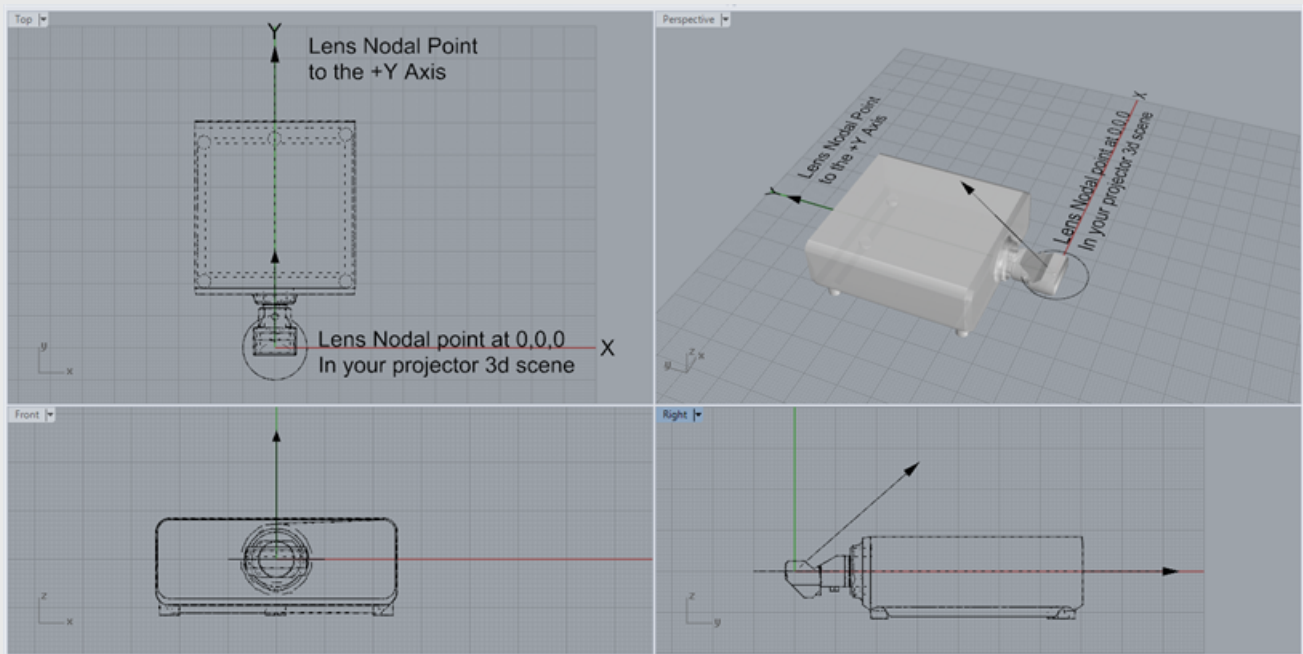

Create a Projector in Mapping Matter.



## TIP

Click [here](#) to learn how to manage your Projector Library.

TOP MENU > Projectors > Projector

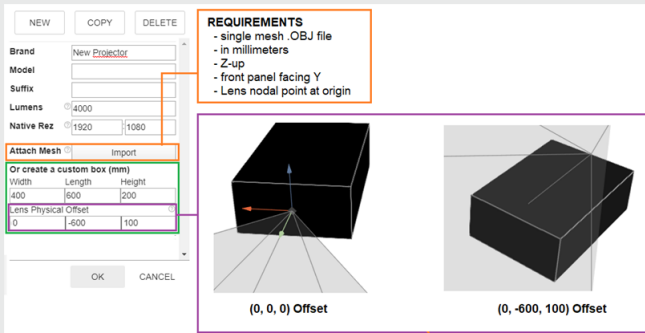

If you have any issue with your imported mesh, first make sure you followed the requirements above. Otherwise, you may have to optimize your mesh pre-import.

You'll need to refresh your Browser for all updates to appear in your Scene and the Projector Library.

- Set the Throw Ratio according to the Manufacturer's specs.
- Adjust the Vertical Lens Shift. (Go to the **Properties** panel.)

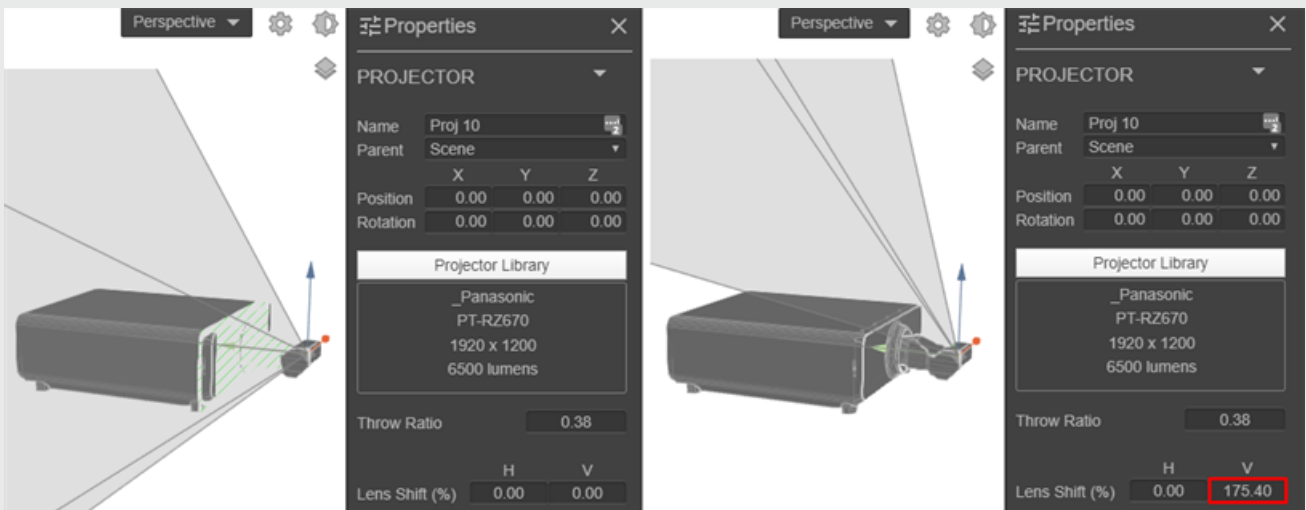

You can calculate the default (or "native") Vertical Lens Shift, using information that you will find in the Manufacturer's specs.

**FORMULA**

► We know that :  $\frac{\text{Image Height (SH)}}{2} = 100\% \text{ Vertical Shift}$

$$\frac{\frac{SH}{2}}{100\%} = \frac{\text{offset} + A1 + \frac{SH}{2}}{?}$$

**EXAMPLE**

► Let's use a *Panasonic PT-RZ660*, with an *ET-DLE030 Lens*, on a *16:10 Projection Distance Table*.

SH = 4.71  
 A1 = 1.69  
 offset = 0.085

$$\frac{\frac{4.71}{2}}{100\%} = \frac{0.085 + 1.69 + \frac{4.71}{2}}{175.4\%}$$

**TIP**

Learn how to use the [Dimension](#) Tool for your measurements.

## Fake Mirror (Mirror Bounce)

There's no Mirror feature in Mapping Matter. But there's an easy workaround to achieve an identical result.

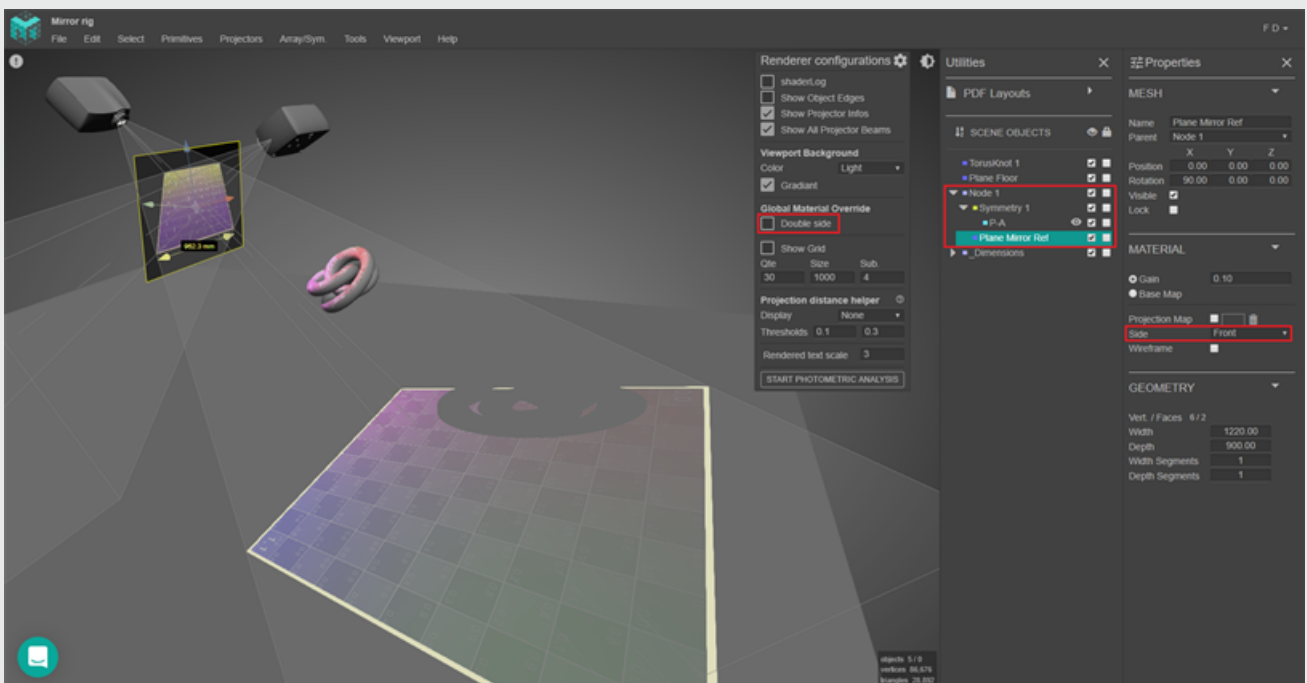

Make sure **Global Material Override** is disabled in the Viewport Settings panel.

Create a **Node** Primitive.

This will top the **Hierarchy** for all Objects of the Mirror setup, allowing you to move / rotate it all easily.

- Create a **Symmetry**, as a **Child of the Node**.
- Create a **Plane Primitive**, to simulate the Mirror itself. Make it a **Child of the Node**. And set its Side (MATERIAL) parameter to **Front**.
- Create a Projector. Make it a *Child* of the *Symmetry*. Adjust its Position / Orientation so it hits the Mirror from its Front side.

## Pixel Resolution for Pixel

This may help you obtain your Full Projection's Resolution.



### WARNING

This method won't be as accurate as if calculated in a software like Autocad.

1. Use the **Dimension** Tool to measure the full area of Projection (Height & Width).



### TIP

In the **Snap** toolbox, uncheck both **Bounding Box** and **Vertex** to get the Red Dot, which appears at any intersection between a Surface and your Cursor.

2. Check your Projector's Resolution, and solve the following equation.

Let's illustrate that with two 1920x1080 Projectors, on a 20% blending.

We'll find a Full Projection Resolution of  $3456 * 1080$  pixels.



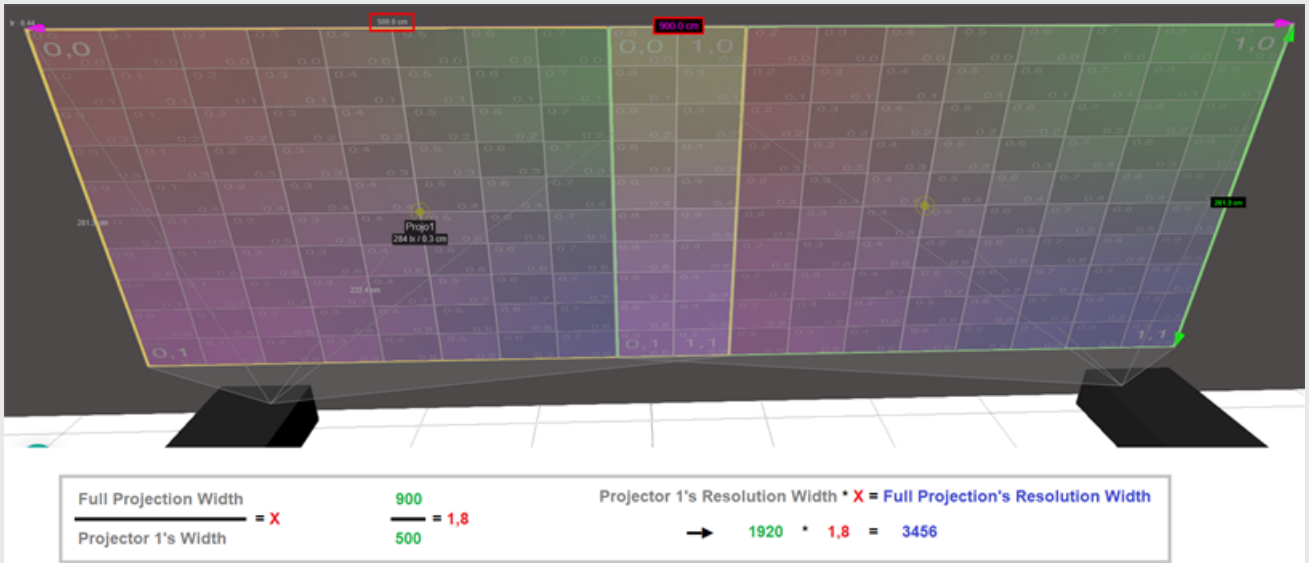

## Space Mouse

We don't support Space Mouses.

## Shortcuts

Press ? to display the full list of shortcuts.

<b>?</b>	Show / hide this help menu	<b>ctrl + c</b>	Copy
<b>space</b>	Videos - Play/Pause	<b>ctrl + v</b>	Paste
<b>h</b>	Videos - Restart	<b>ctrl + ↑ + v</b>	Paste
<b>f</b>	Videos - Forward 10 sec.	<b>m</b>	Transforms - Translate
<b>b</b>	Videos - Backward 10 sec.	<b>r</b>	Transforms - Rotate
<b>a</b>	Annotations	<b>ctrl + s</b>	Save
<b>t</b>	Dimensions	<b>c 1</b>	Camera - Front
<b>del</b>	Delete selected object	<b>c 2</b>	Camera - Bottom
<b>ctrl + z</b>	Undo	<b>c 4</b>	Camera - Left
<b>ctrl + ↑ + z</b>	Redo	<b>c 5</b>	Camera - Perspective

## Undo and Revisions History

You can Undo (**ctrl+Z**) or Redo (**ctrl+shift+Z**) any action by going to TOP MENU > Edit.

You can also use **Revisions History** to access the 10 last times you opened or refreshed your Scene.

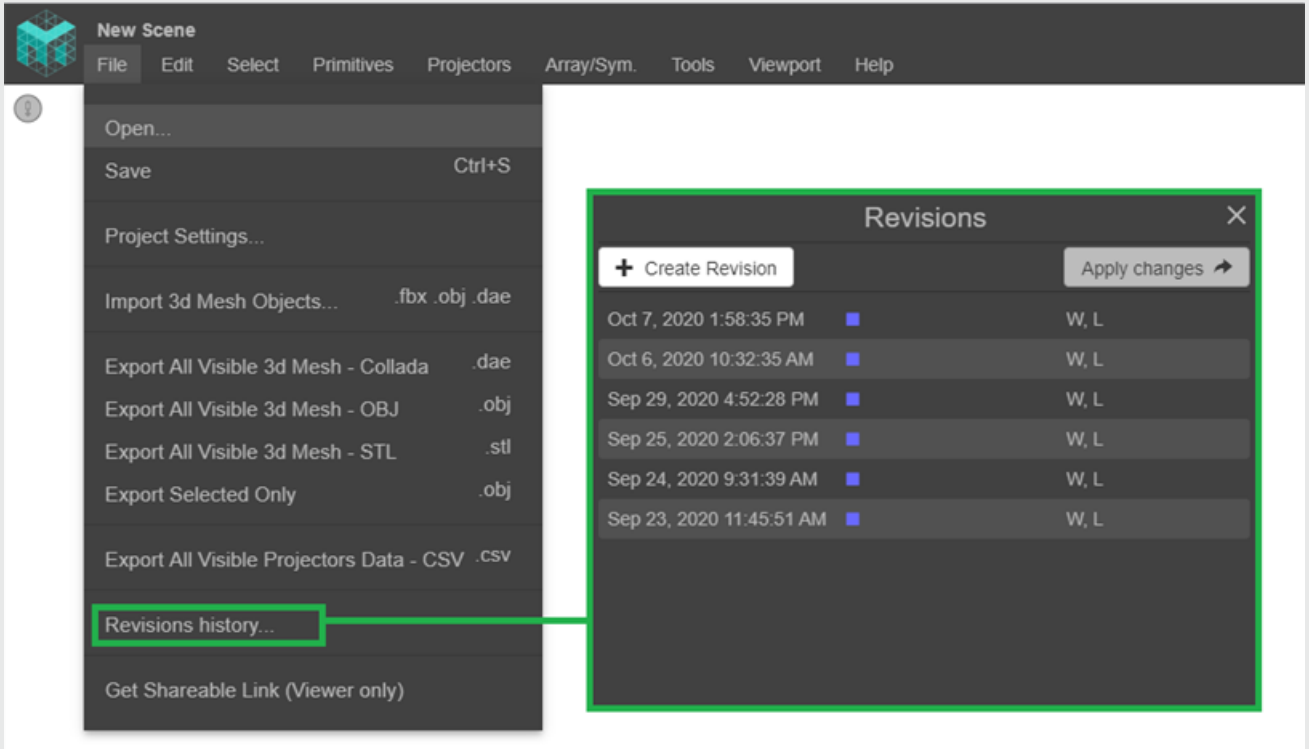

# Porta 2.0 Overview

## Porta 2.0 Overview

Porta is a cloud-native control system for broadcast that unifies the workflow for data-driven graphics in Unreal Engine that is easy to access, control, and play. Porta can sit across all your broadcast tiered productions and seamlessly integrates with newsroom systems. It features a simple interface that is Unreal Engine native and easy to operate.

Any type of playlist mode can be used, enabling multiple rundowns, and a preview mode so you can seamlessly manage your production from anywhere. Using Porta, you can manage multiple engines from one point of control. Porta offers the ability to configure projects for specific company needs.

Multiple operators can control graphics from anywhere using any browser while also being adaptable for use locally. Porta both empowers cloud-based collaboration and on-the-premises studio teams.

Porta is available as a Software as a service (SaaS) subscription.

# Porta Release Notes

## Porta 2.2

Released: September 13th 2023

### New Features

- Native compatibility with Unreal 5.3: Customers will be able to use Unreal Motion Graphics BETA and start creating any kind of graphics (AR, CG,) in one platform. This enables users to take advantage of the new production tools available in Unreal Engine.
- Improved integration with Designer. This gives users deeper D3 control. This means that you can create templates to control renderstream, calibration, timeline controls and other d3 APIs.
- Remote scheduler is a workflow for transferring, scheduling and playing out media content from Porta to Designer. This is the first iteration of an ongoing improvement.

### Improvements

- » New macros UI “Workflow Widget”, lets out macro language where you can create tasks and assign them to keyboard shortcuts to automate functions tied to keyboard shortcuts and streamdecks.
- » XML/Google drive integration.
- » Additions to Template Builder:
  - » Template color.
  - » Duration settings.

- » Improved channel monitoring.
- » Channel grouping.
- » Live Link for Unreal Data.

## Porta 2.1

Released: January 18th 2023

## New Features

### — **Porta now supports MOS Gateway**

- » Porta MOS Gateway
- » Support for MOS 2.8 protocol

### — **Newsroom Integration**

- » Porta HTML5 Newsroom plugin
- » Unreal Engine based preview server for users to have graphic preview in the Porta HTML5 Newsroom plugin
- » Support for Newsroom Systems integrations:
  - » ENPS, iNews, Open Media, Octopus, Dalet, Dina

### — **Content Scheduler**

- » Migration of the scheduling capabilities of IPSUM to Porta
- » Easy to use schedule and loop modes for playlist and content
- » Allowing Porta to schedule and trigger playlists of templates automatically, for Unreal and disguise designer content.

### — **Other Features**

- » Visual macros and custom keyboard shortcuts
- » Integration with Google Docs
- » Custom colors for pages in playlist
- » Page save names based on data

## Porta 2.0

### New Look. New Capabilities.

- Subscription based
- User driven, customizable UI
- Template Creation
- Forms
- Rundown creation
- Based on vanilla Unreal Engine
- Porta and Ipsum are fully supporting Unreal 5.0 and its sub-releases

- 
- Device, location and user agnostic
  - Unreal Engine vanilla graphics control
  - Playlist driven, non-linear playout
  - Pixel Streaming cloud preview
  - No plugins or blueprints required
  - Data-driven graphics with Polygon Ipsum.

Paired with Polygon Stream (PX) box for AR, CG, Green Screen production.





# Porta 2.0 Overview

## Porta 2.0 Overview

Porta is a cloud-native control system for broadcast that unifies the workflow for data-driven graphics in Unreal Engine that is easy to access, control, and play. Porta can sit across all your broadcast tiered productions and seamlessly integrates with newsroom systems. It features a simple interface that is Unreal Engine native and easy to operate.

Any type of playlist mode can be used, enabling multiple rundowns, and a preview mode so you can seamlessly manage your production from anywhere. Using Porta, you can manage multiple engines from one point of control. Porta offers the ability to configure projects for specific company needs.

Multiple operators can control graphics from anywhere using any browser while also being adaptable for use locally. Porta both empowers cloud-based collaboration and on-the-premises studio teams.

Porta is available as a Software as a service (SaaS) subscription.

# User Roles

## Key Industry Roles

There are three key user roles in the broadcast industry. These are Designers, Operators and IT Admin or Engineers. In some instances, Operators also do design work and are thus referred to as Technical Operators, however, we will focus on the three main areas. Workflows and user journeys in Porta have been configured around each type of user's specific tasks.

### Designer

An artist who creates the UE project and builds templates to control UE assets.

### Operator

An Operator triggers the controls using templates and playlists built by the Designer.

### IT Engineer

An IT Engineer or IT Admin focuses on configuring systems, networks, and company setups.

An Engineer would add the settings and solve any technical issues.

# User Interface

## The Porta 2.0 Interface

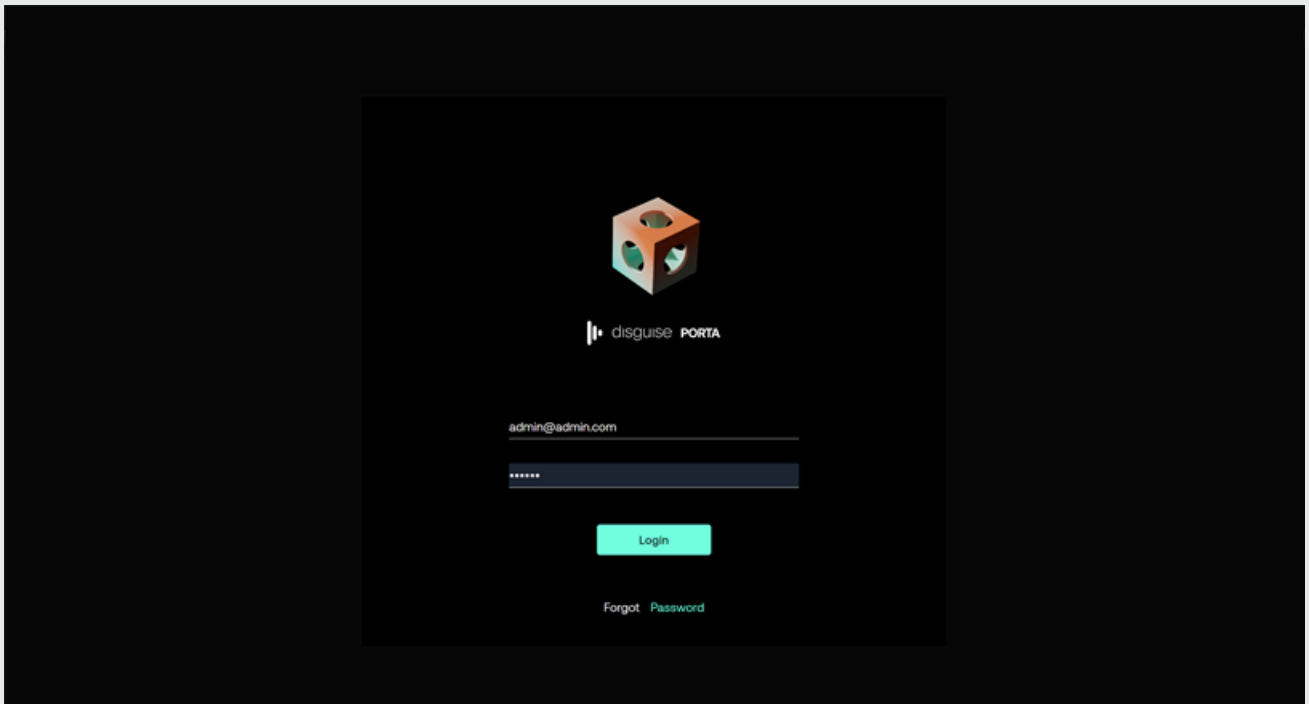

Porta login page

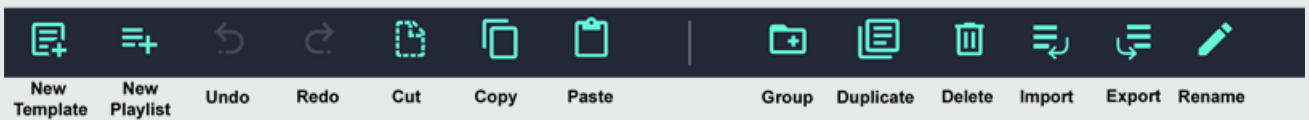

Main toolbar

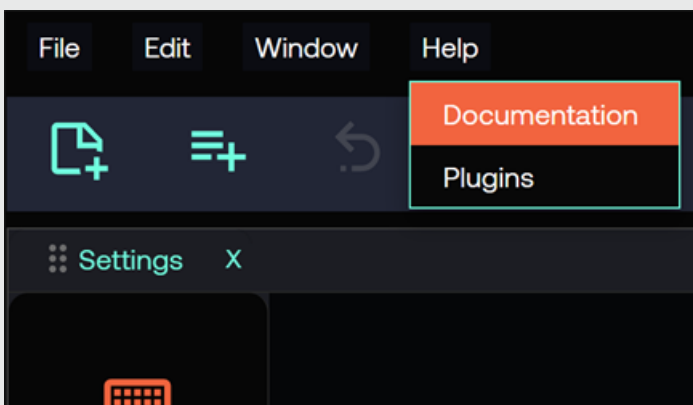
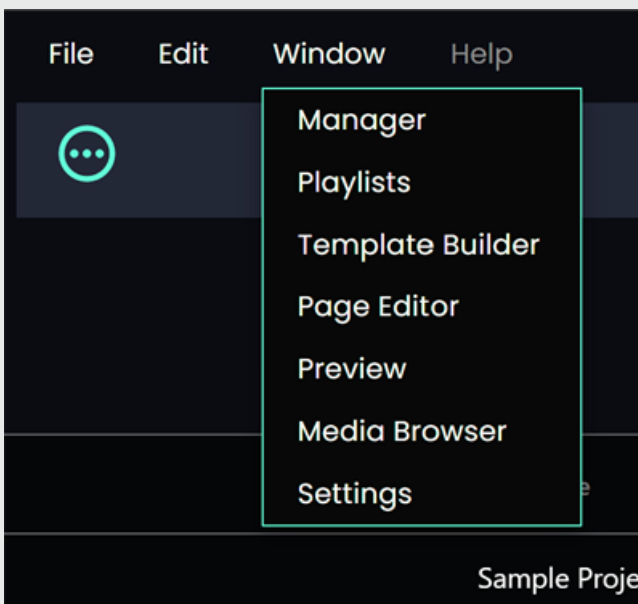
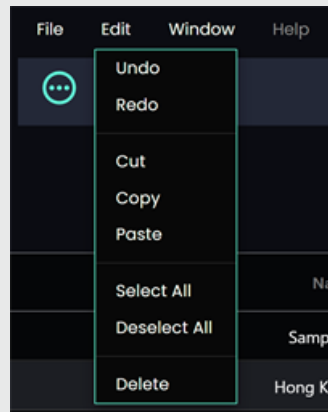
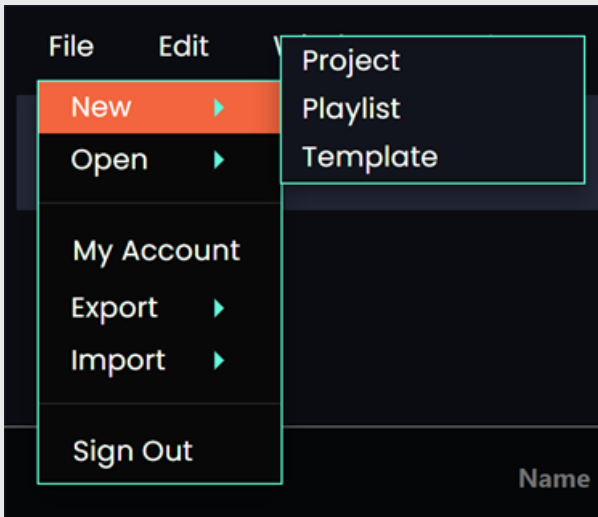

Menu tabs

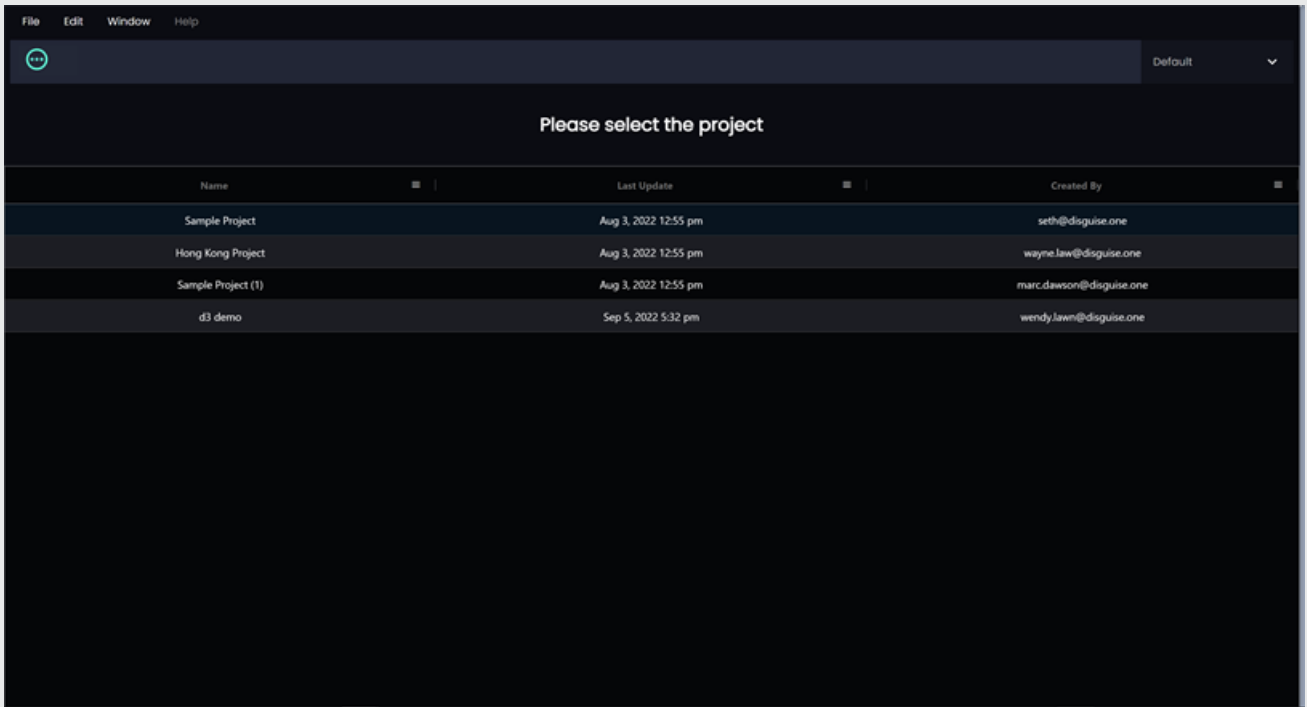

Project page

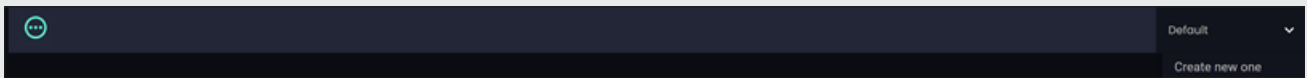

Project toolbar: New project + workspace

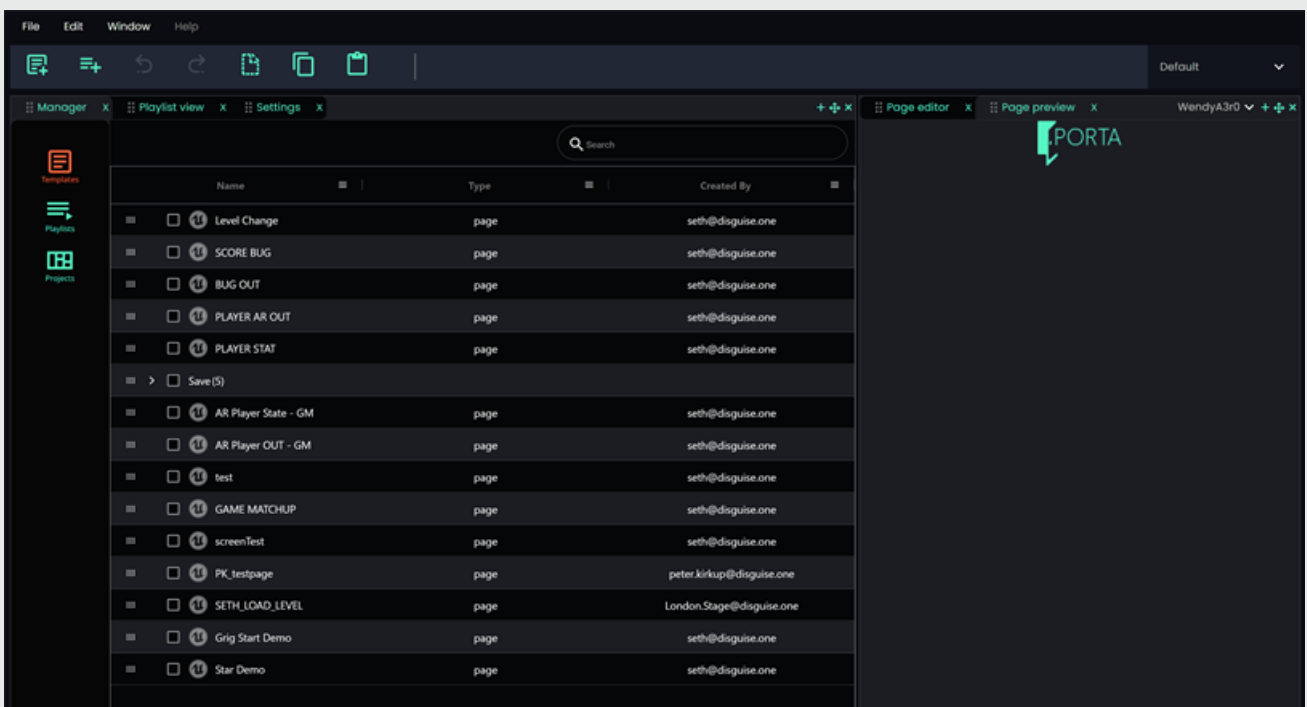

Manager: Templates view

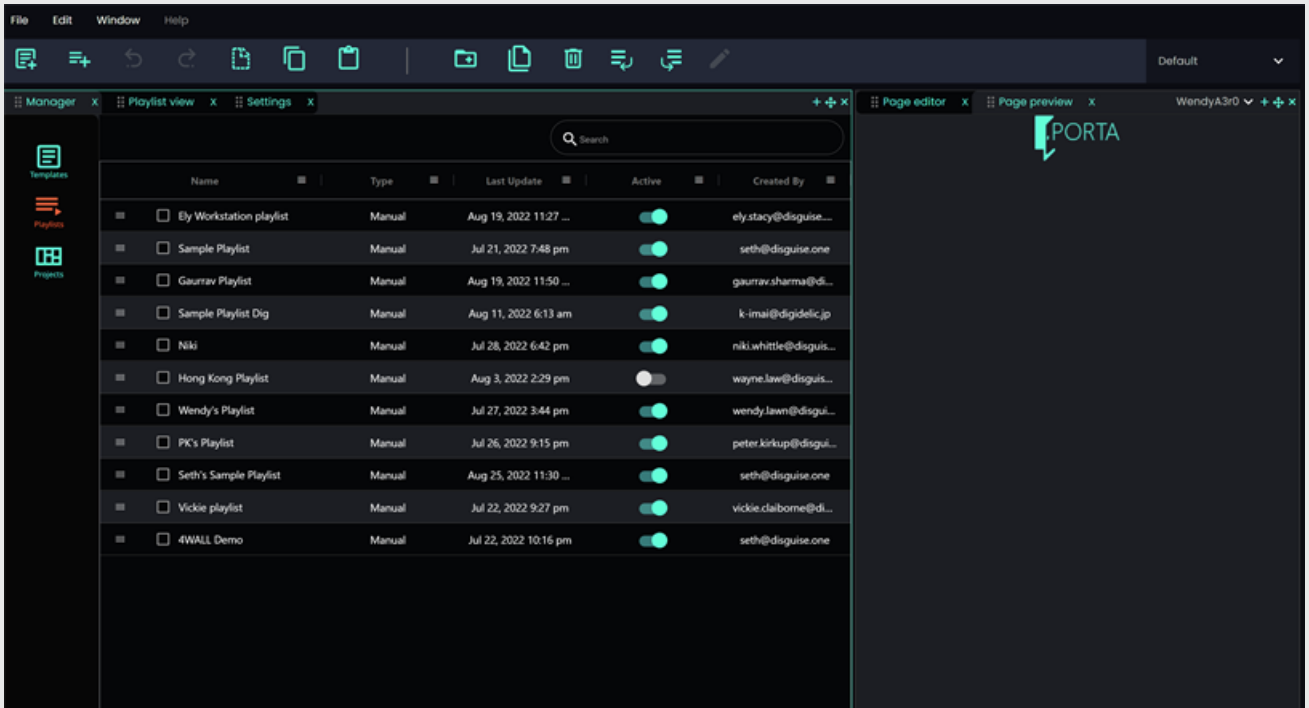

Manager: Playlists view

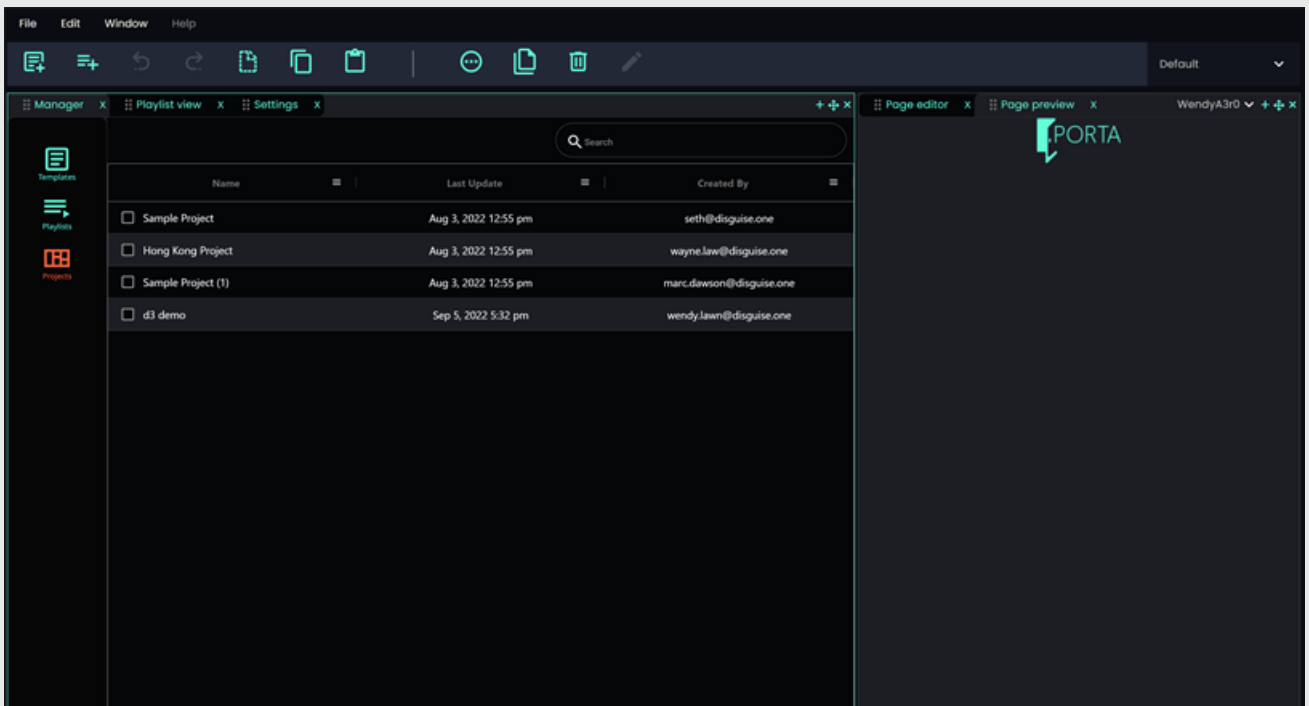

Manager: Project view

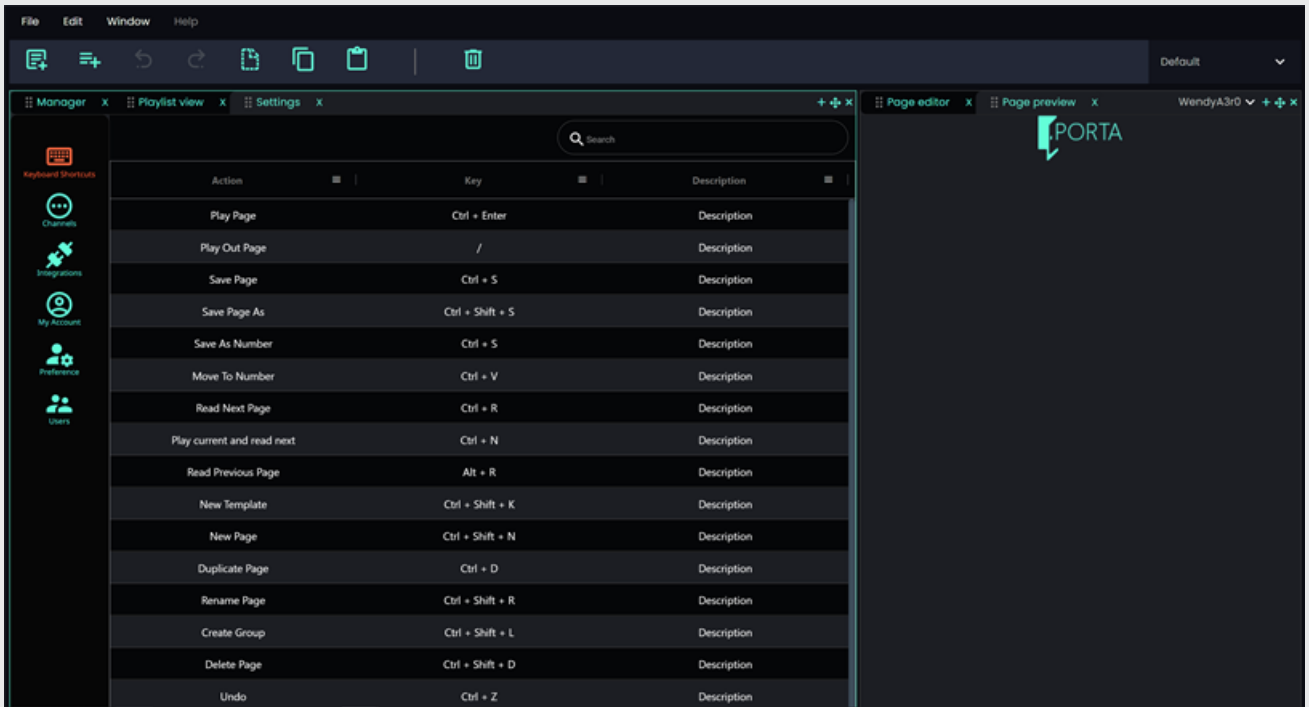

Settings: Keyboard shortcuts

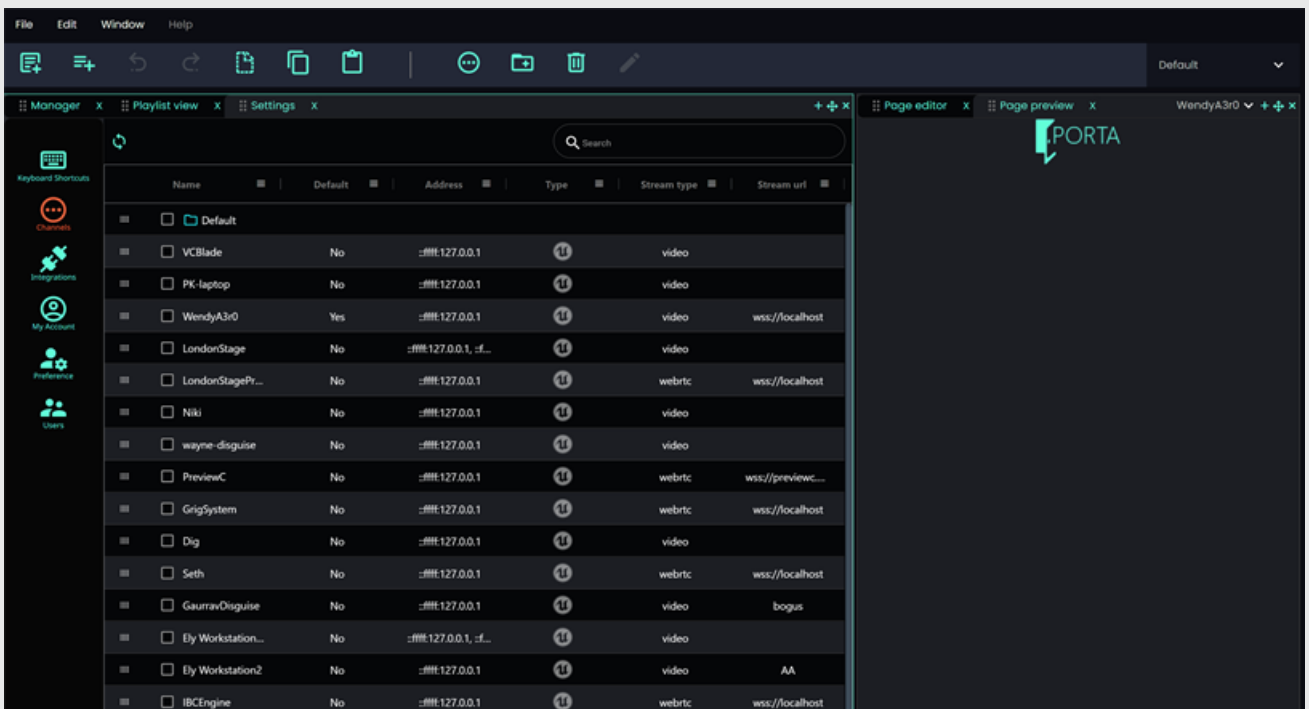

Settings: Channels

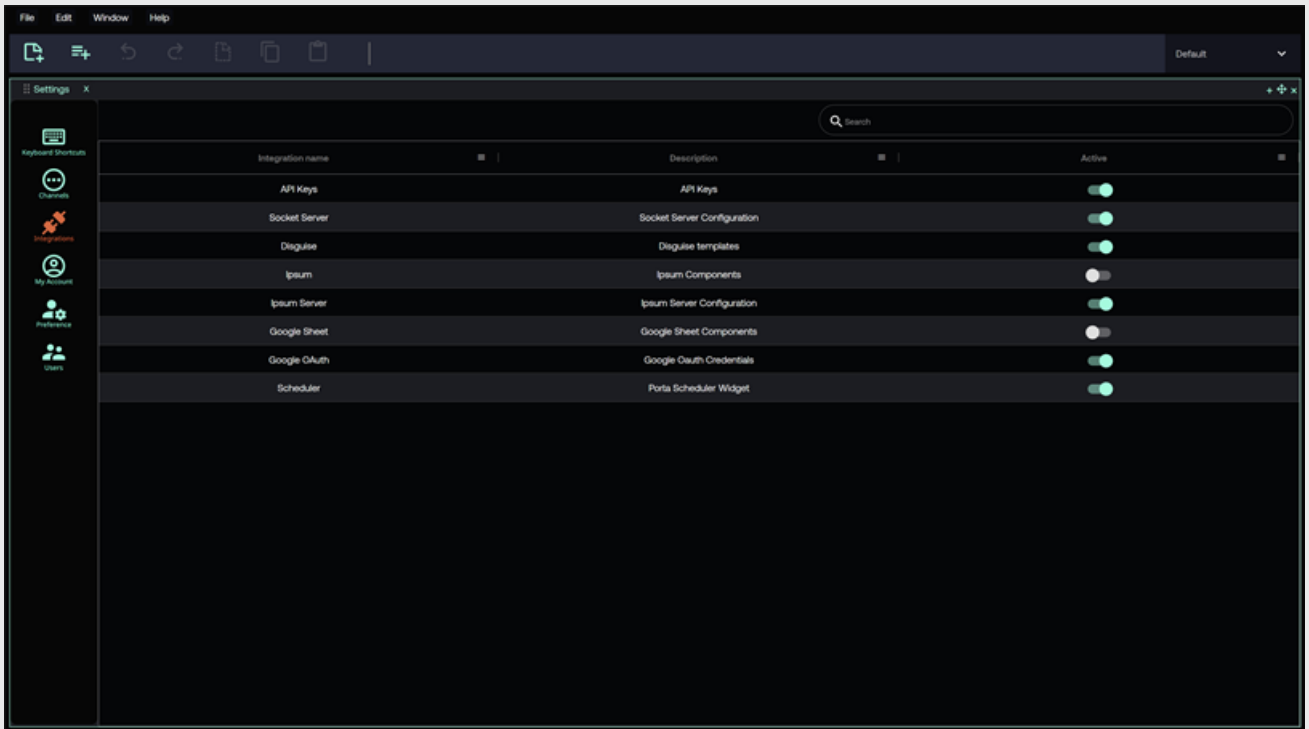

Settings: Integrations

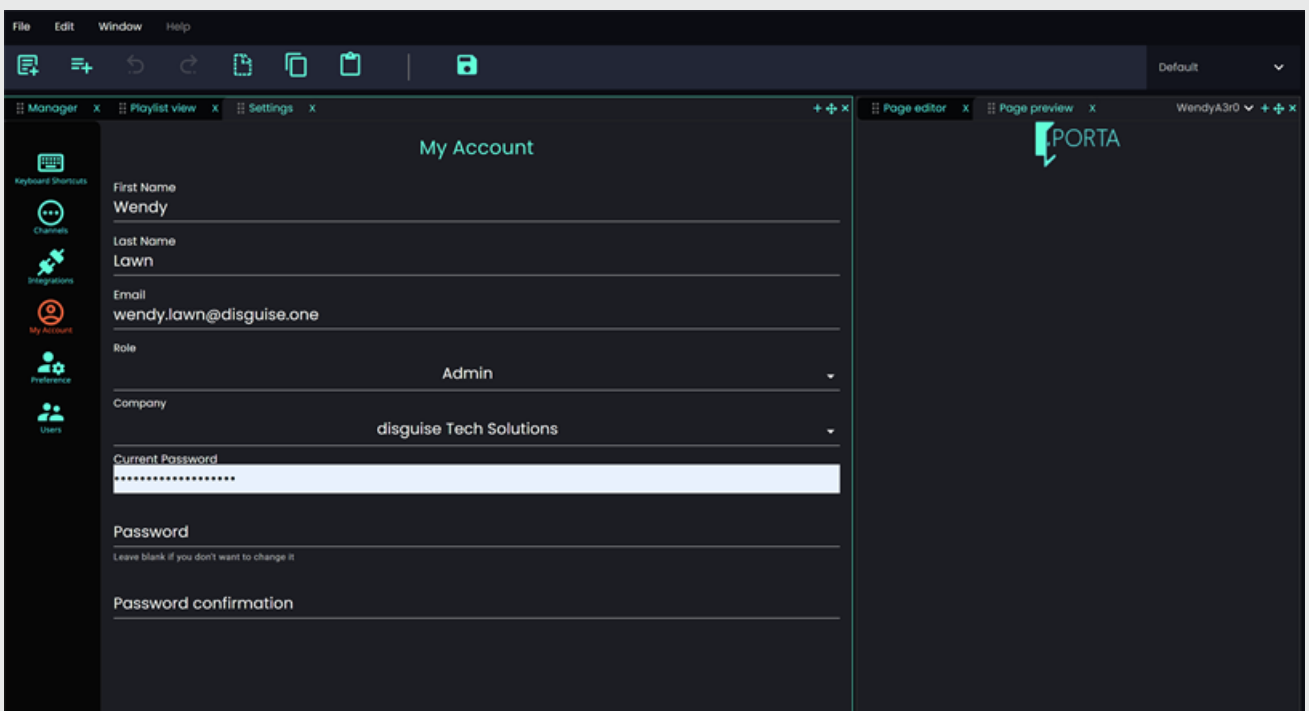

Settings: My Account



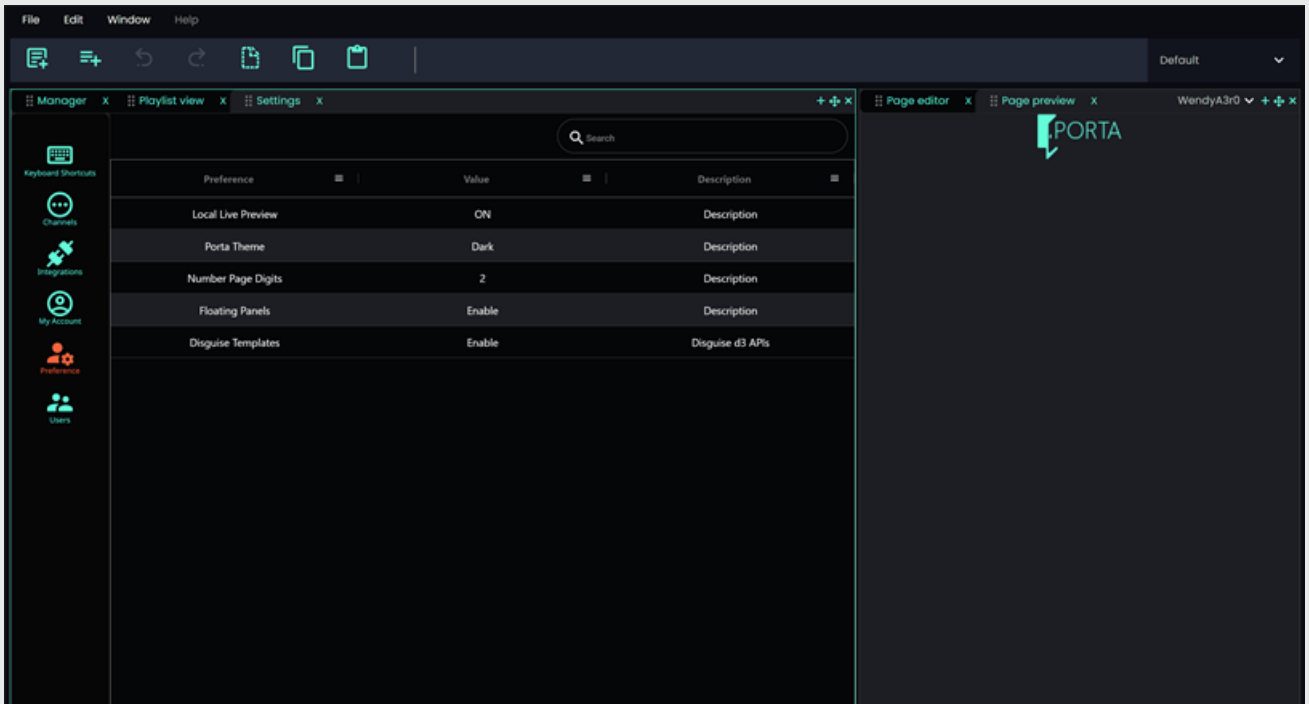

Settings: Preference

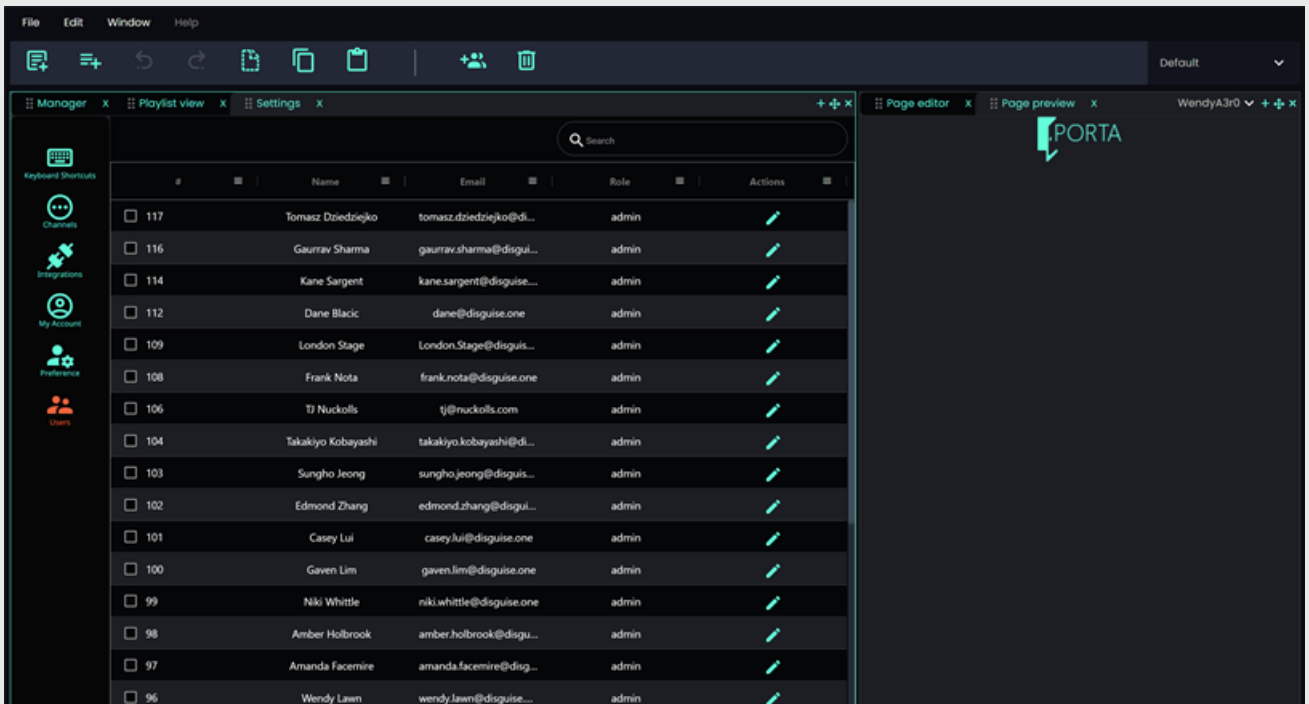

Settings: Users

# Keyboard Shortcuts

## Default Keyboard Shortcuts

Play page	Ctrl + Enter
Play Out Page	/
Save Page	Ctrl + S
Save Page As	Ctrl + Shift + S
Save As Number	Ctrl + S
Move To Number	Ctrl + V
Read Next Page	Ctrl + R
Play current and read next	Ctrl + N
Read Previous Page	Alt + R
New Template	Ctrl + Shift + K
New Page	Ctrl + Shift + N
Duplicate Page	Ctrl + D
Rename Page	Ctrl + Shift + R
Create Group	Ctrl + Shift + L
Delete Page	Ctrl + Shift + D
Undo	Ctrl + Z
Redo	Ctrl + Shift + Z

*Table: Keyboard Shortcuts in Porta 2.0 (October 2022)*

Broadcast operators often need to react quickly in a live production environment, so they like to use keyboard shortcuts to introduce and switch content. Using a mouse and keyboard combination to trigger content is much slower than using keyboard shortcuts. With this workflow in mind, many

keyboard shortcuts have been added to Porta. These are continually being updated, and can also be customized by users. In a future update, it will be possible to export customized keyboard shortcuts and import them to a different instance of Porta.

## Customize keyboard shortcuts

1. To customize a keyboard shortcut, select the **Key** column.
2. Press the new key or key combination you want to add.
3. Confirm the key/key combination shown by pressing **Enter**.

# Customising Layouts

## Workspaces

The Porta interface can be easily customized by opening, rearranging, and docking widget panels in the browser so you can organize your screen how you need it. Panels can also be tabbed so that you can jump between tabs and keep the layout organised. These layouts can be saved as workspaces.

The above example image shows the following docked panels:

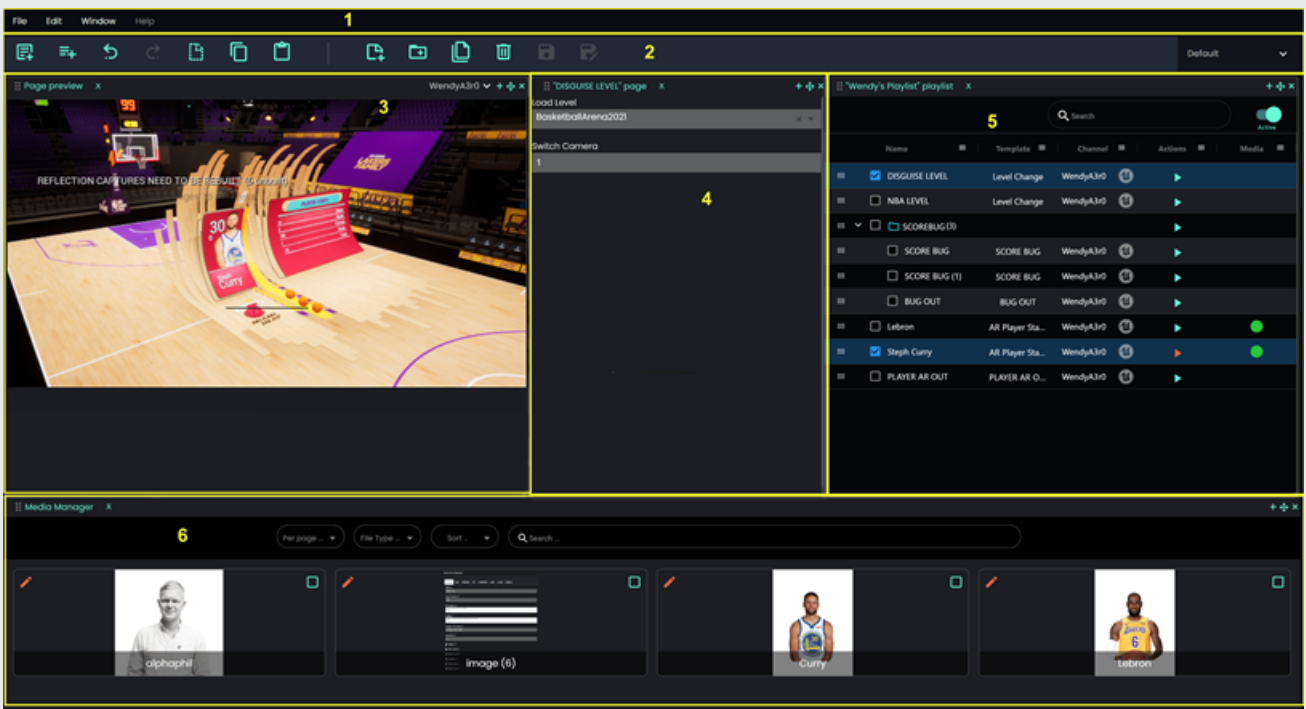

### Workspace Layout:

1. Top menu
2. Main toolbar
3. Page preview
4. Page

5. Playlist

6. Media manager

By clicking the Maximise button at the corner of all panels, you can expand the panel which sets it to Fullscreen. If a panel is fullscreen, you can click on the Minimise button to minimize the panel size.



Add | Maximise | Close

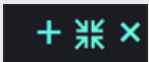

Add | Minimise | Close

# Working with Unreal Engine

## Technical requirements

Porta projects are currently built in Unreal Engine 5.0.3.

Review the recommended software and hardware specifications for running Unreal Engine 5 [here](#).

## Sample projects

There are two sample projects available that have been specifically configured to use with Porta:

- **Demo\_Light project**
- **3D Text project**

## Introduction

This guide will help you get started using Porta, it will not teach you how to use Unreal Engine. For Unreal Engine 5 [documentation](#) and [learning resources](#) check out their [website](#).

Porta supports the use of vanilla Unreal Engine and controls the Unreal project from a browser. So we will cover how Unreal project controls can be set up for Porta.

Projects are created by designers ahead of time. Projects include different environments, themes, and assets over different levels, as well as cameras, visual effects, and animations. Blueprints (Unreal Engine's visual scripting language) are used to bring it all together.

These 3D assets are also referred to as graphics in broadcast terms because they are viewed as graphics onscreen.

Designers expose the parameters of an asset in Unreal Engine and configure them so that they can be controlled from Porta running in a browser. Porta can remotely change these parameters, switching items on and off, changing levels (or environments), adjusting lighting, changing an item's positioning, switching camera views, or triggering animations. Augmented Reality (AR) assets can be also added to levels such as sports players, F1 cars, and weather elements.

Unreal Engine needs to be running in standalone play mode while using Porta. To connect Porta to Unreal Engine a binding must be added that syncs content between the two.

To begin, the 3D text item (Text3DActor) is relatively simple to add and the most common element Porta has in Unreal Engine. We will demonstrate an overview of the designer's workflow by adding a 3D text asset to our level and exposing a parameter that can be used by Porta.

## Unreal Engine Workflow

Ensure that you have Unreal Engine 5.0.3 installed.

To learn this basic workflow, the project does not need to have any sample content. However, the team has provided a sample project that demonstrates how 3D Text is configured for Porta\* which you can use.

If you are planning to use the project for production purposes, you may wish to build an environment with content on at least one level.

Enable the following plugins:

- [Substance plugin](#)
- [3D Text Plugin](#)
- [Remote Control API](#)
- Porta Manager plugin\*

\* To download the latest Porta plugin select **Help > Plugins** from the menu and select PortaPlugins\_2\_0\_1.zip.

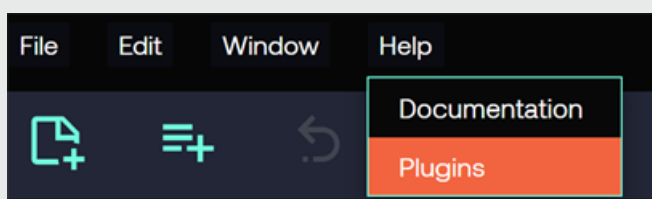

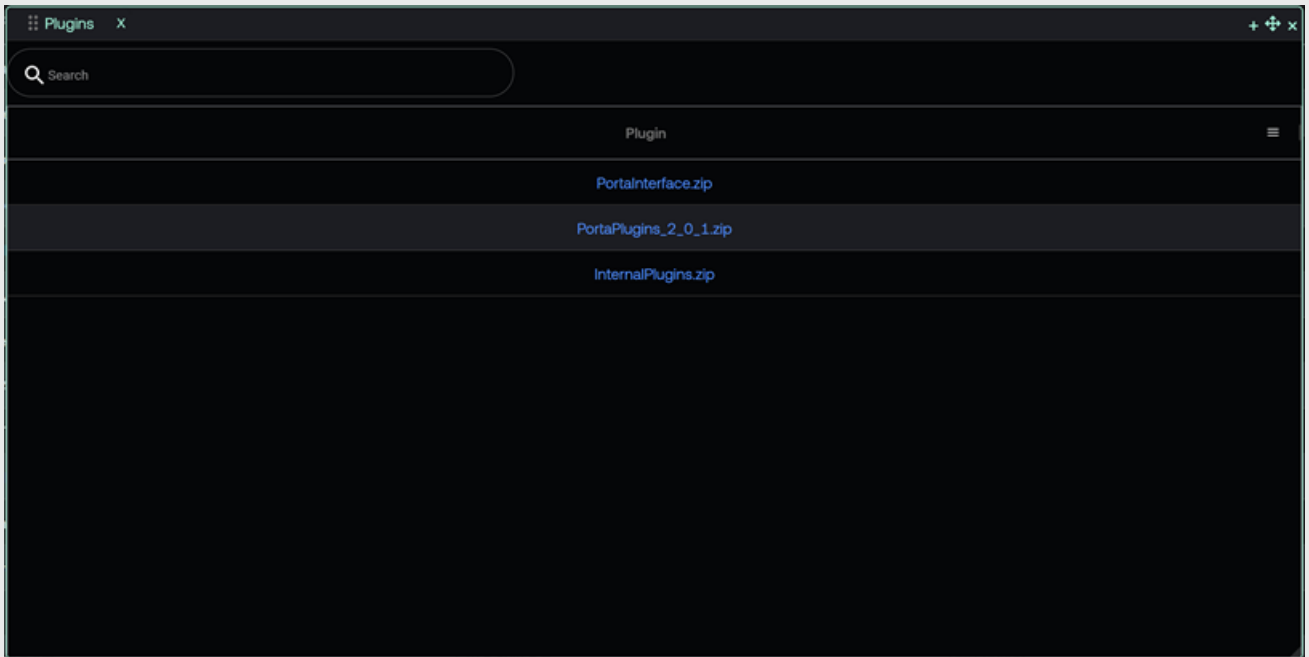

If you have a sample Porta project some of these plugins may already be enabled.

If you are not using a sample project, create a new empty project.

## Create a new project

In **Epic Games Launcher**, launch the Unreal Engine **5.0.3**.

1. Create a project by selecting the **Games** category.
2. Select a **Blank** template.
3. In Project Defaults, select **Blueprint** project with the default settings.



- Name the project "Porta".

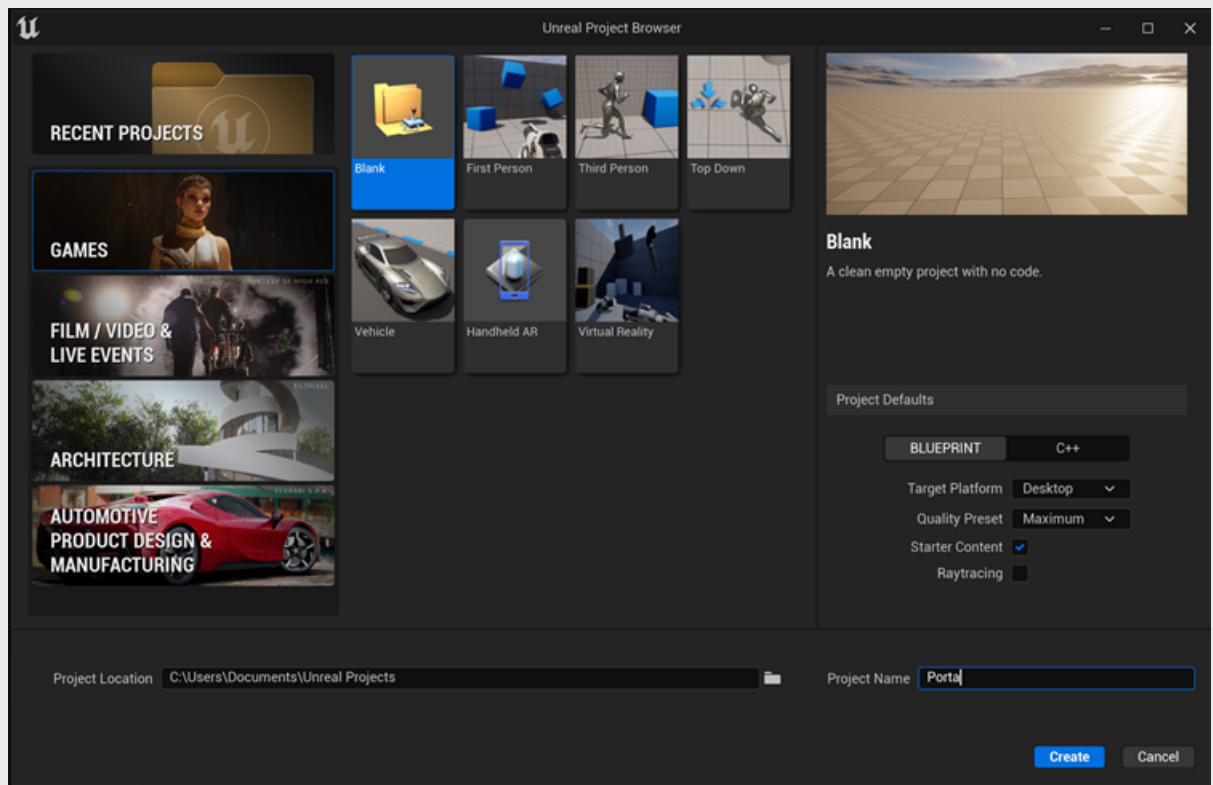

- Click **Create**
- The **Epic Games Launcher** creates a new project and opens the Unreal Editor.

# Enable the 3D Text plugin

1. Select **Edit > Plugins**.



2. Type **3D** in the search bar.
3. Click on the checkbox to enable it.
4. Click on the **Restart Now** button.

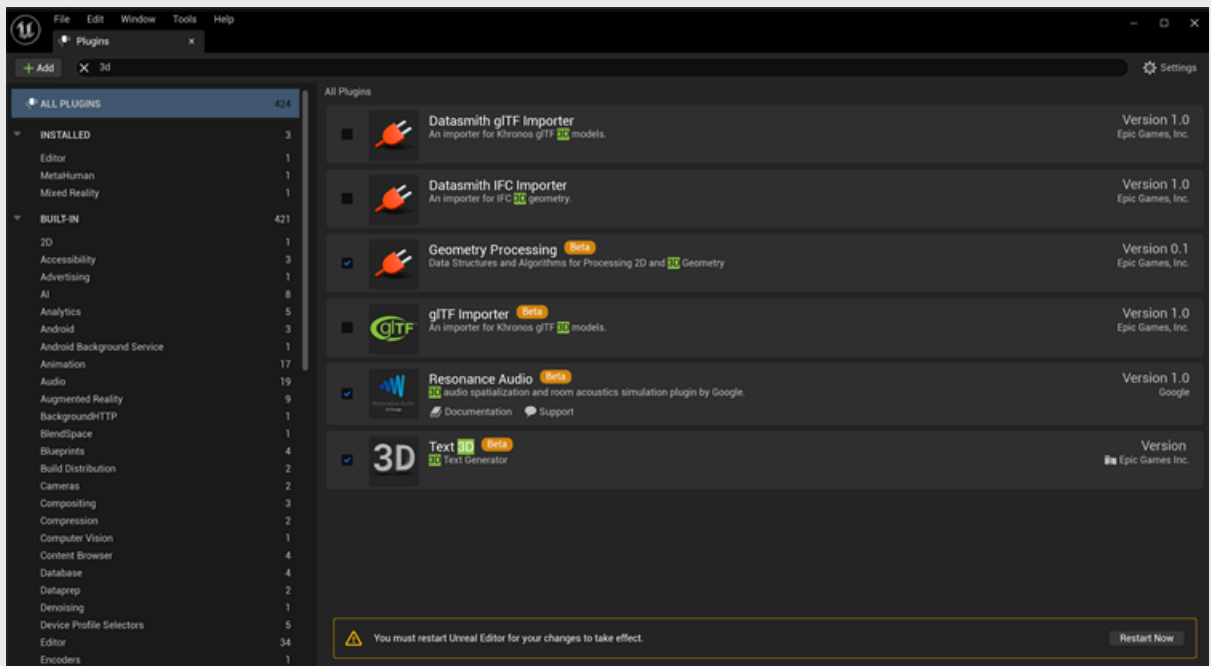

5. Click **Save Selected** to save all changes.

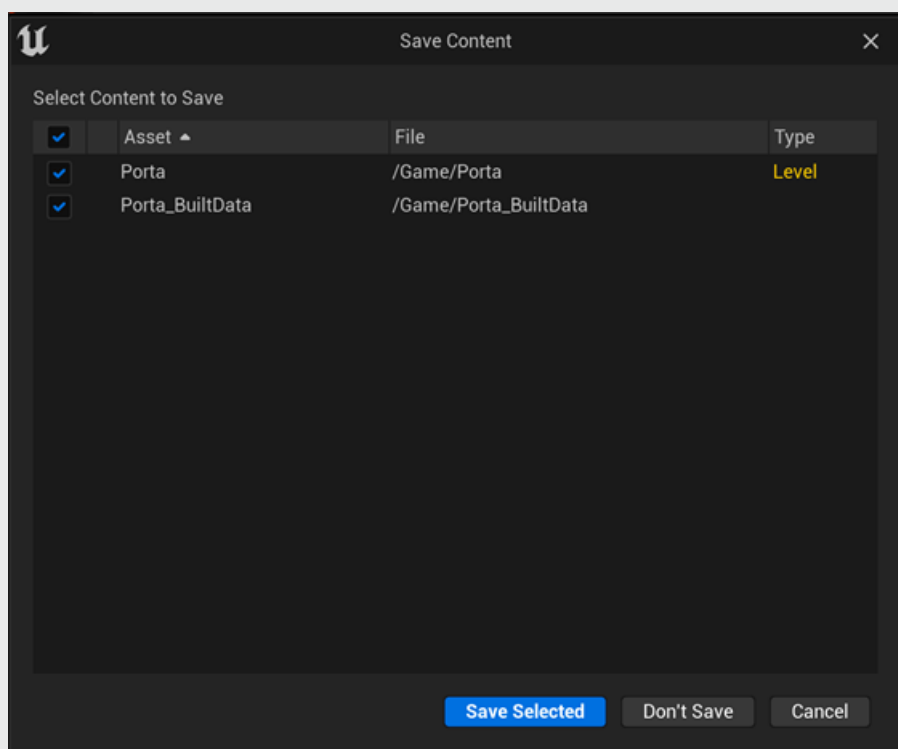

6. Unreal Editor will automatically reopen. Close the **Plugins** window.

# Add a 3D text asset to an Unreal project

1. In the Unreal project click **+** to quickly add an item.
2. Select **All Classes**.

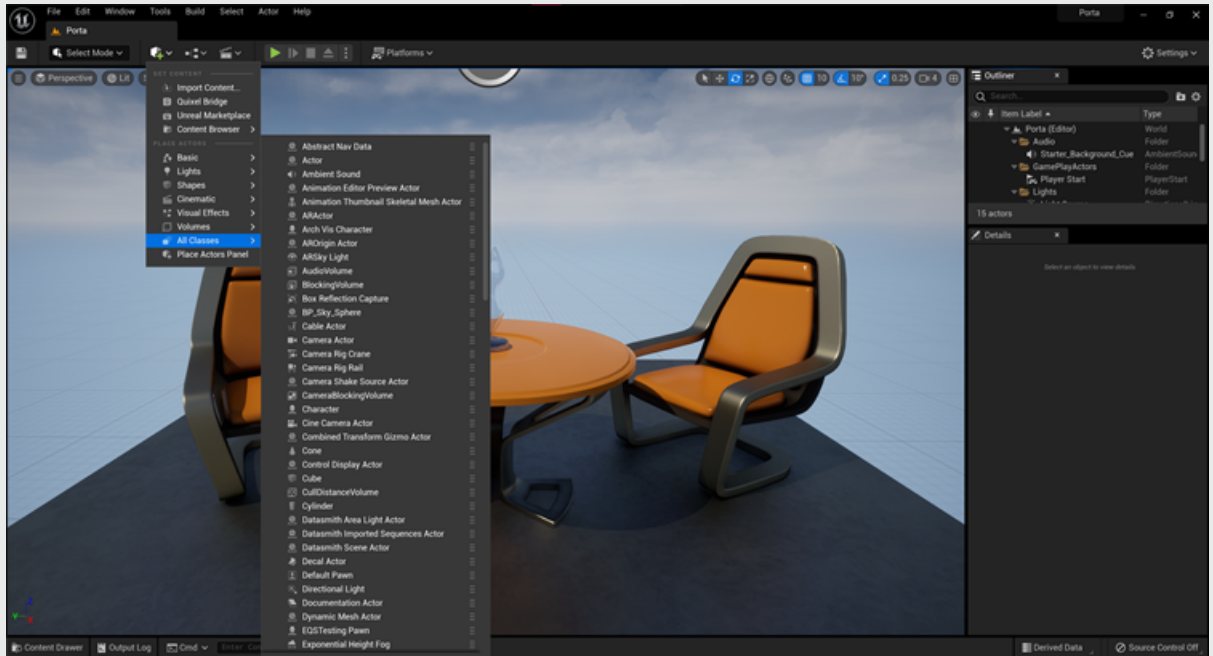

3. Press **CTRL + Spacebar** to enable search and type "3D".

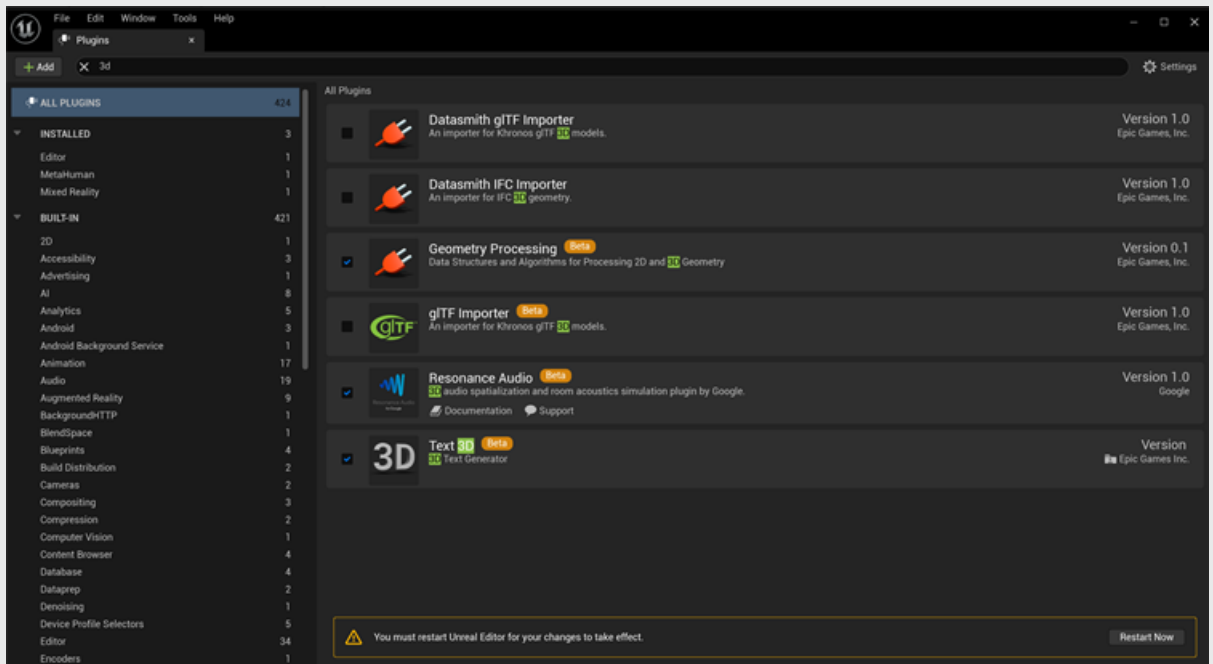

4. Click on **Text3D** to add it to the level.

- In the **Text** parameter, type "Porta".

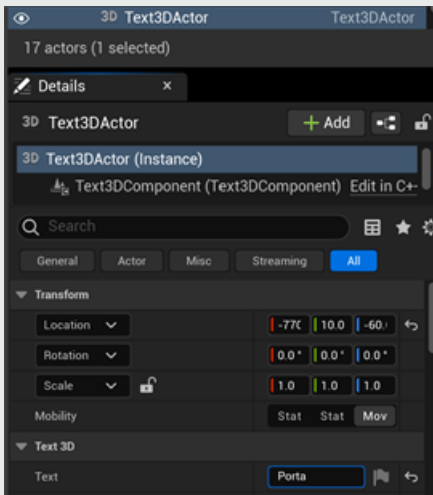

- In the **File** menu, click **Save All**.

## Expose an asset parameter in Unreal Engine

Ensure that you have enabled the Remote Control API plugin in your project.

Follow the steps above to enable a plugin

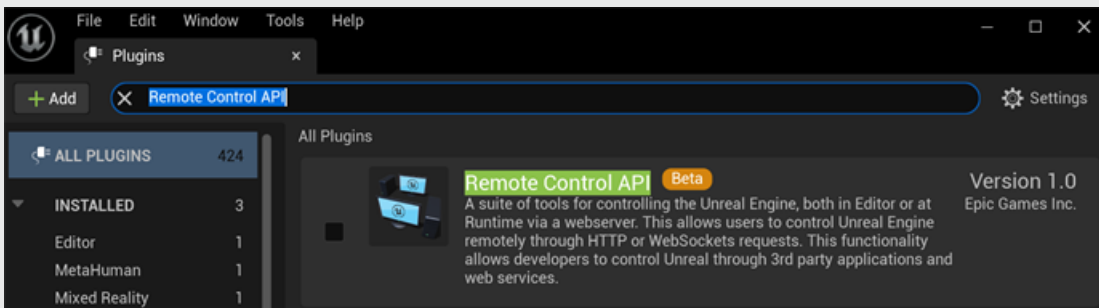

If you are using a sample project, this will already be enabled.

1. Open the **Content Drawer** and from the **Content Browser**, click **+ Add**.
2. Select: **Miscellaneous > Remote Control Preset**.

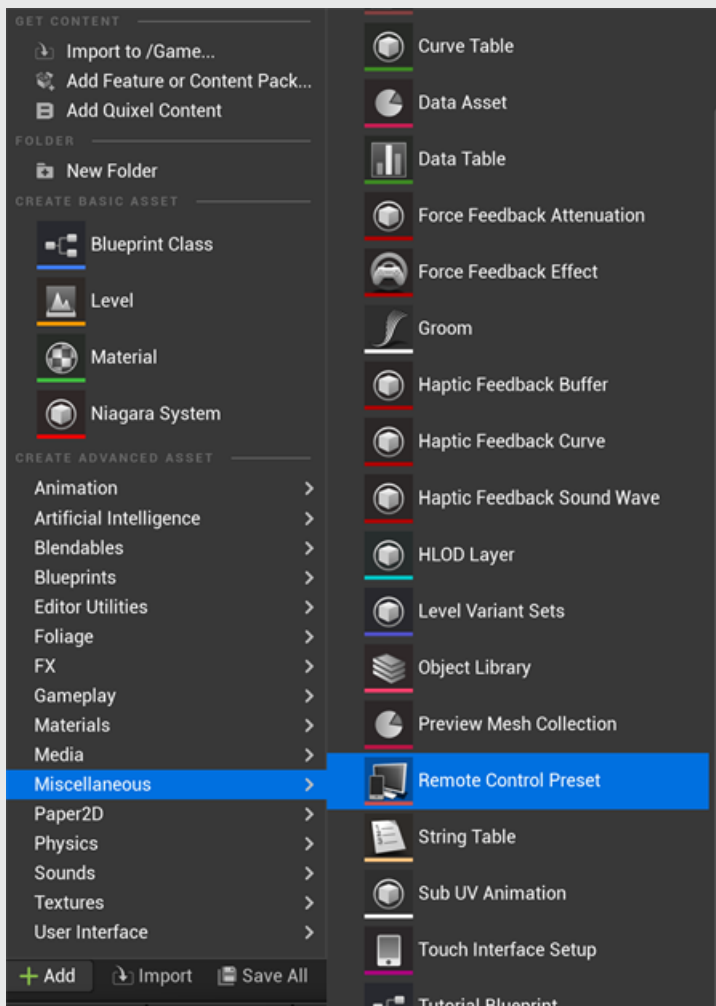

3. Double-click on the new **Remote Control Preset** in the **Content Browser** to open it.

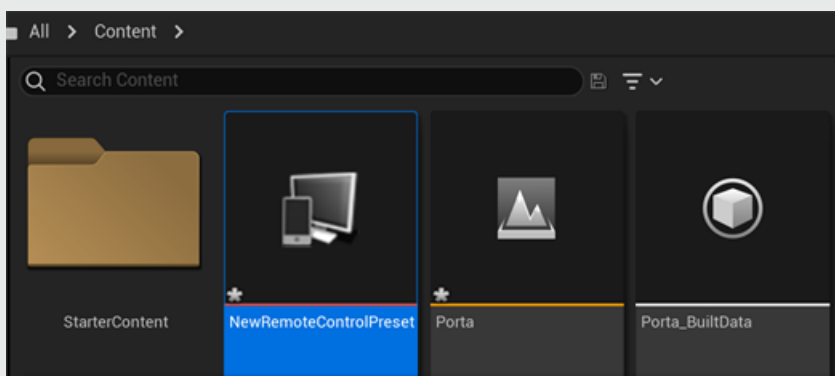

4. Select the **Text3D** asset in the Outliner.

- In the **Details** panel, click on the 3 vertical dots at the edge of the Text parameter to expand the toolbar.

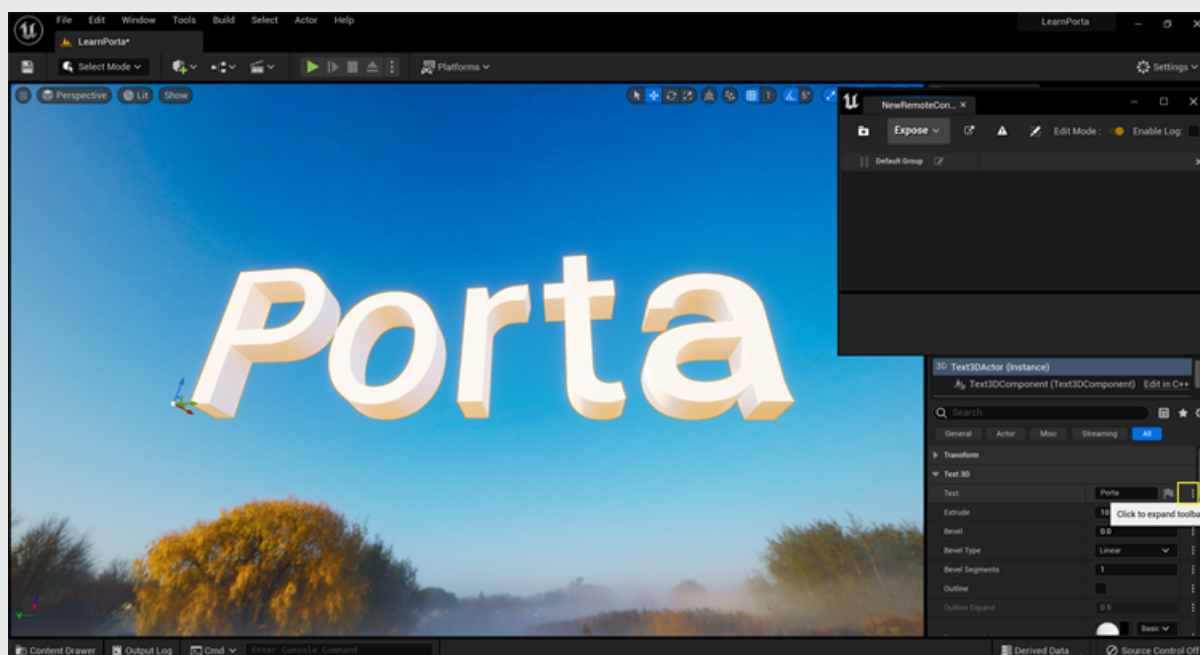

- Click **Expose property**.

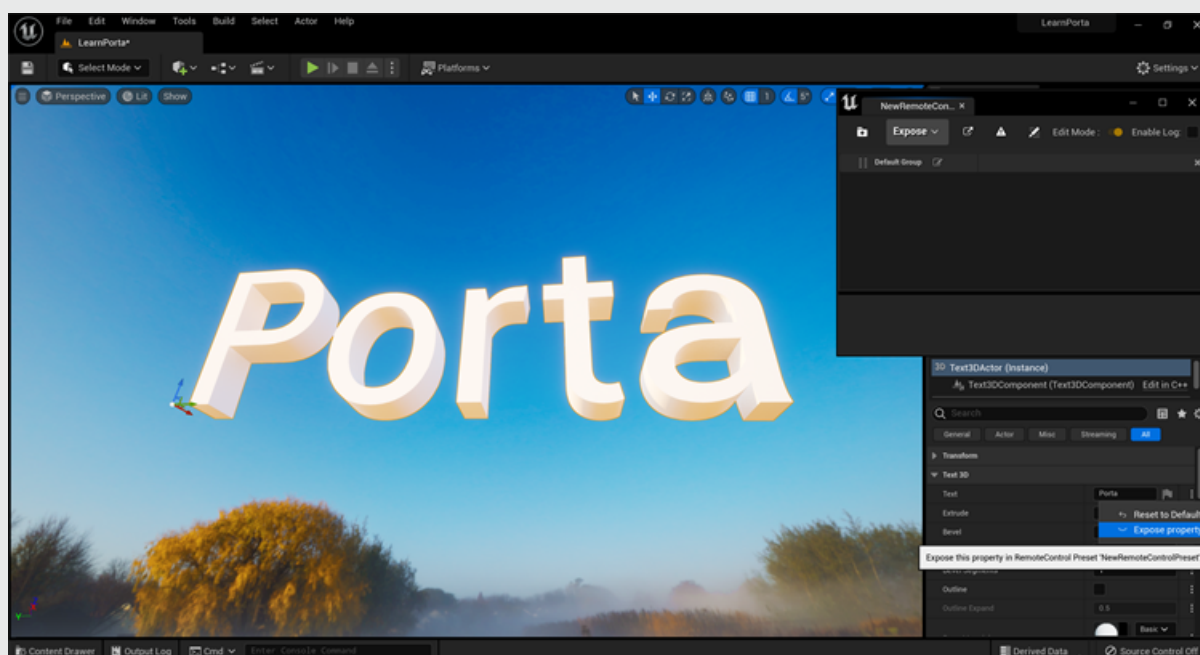

## Using the Demo\_Light project

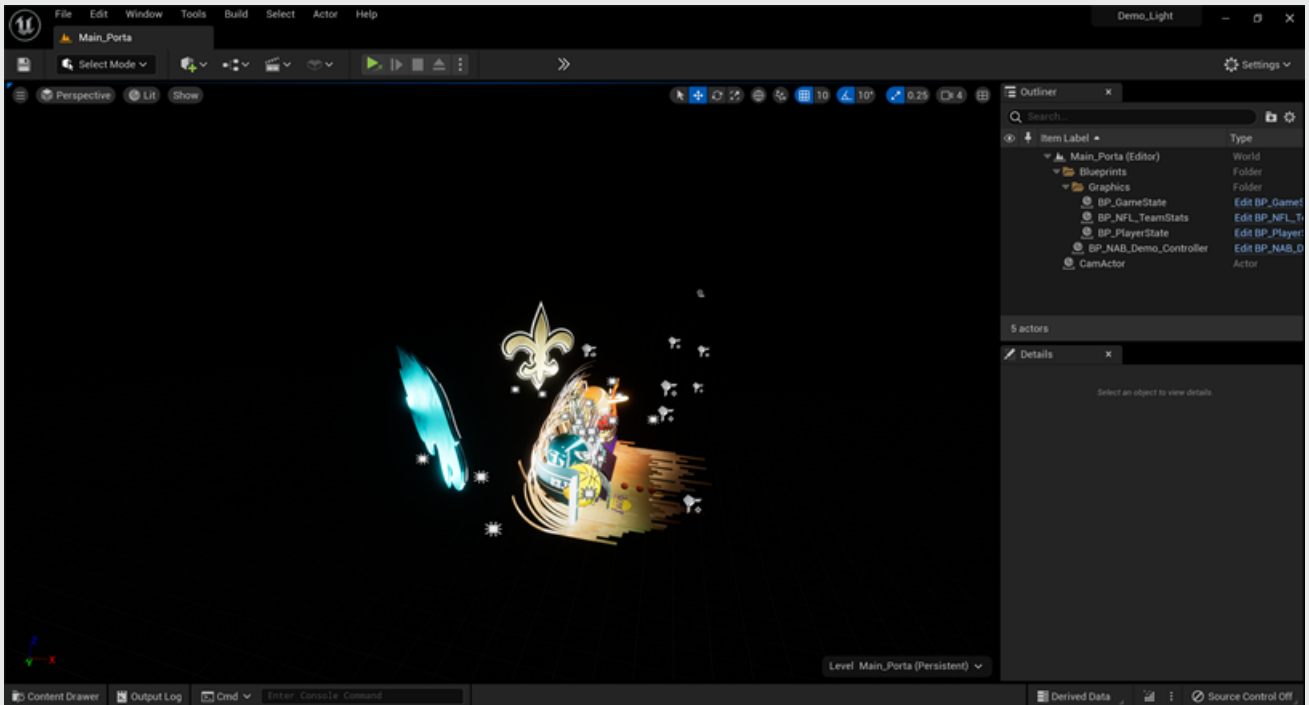

The team has put together the **Demo\_Light** sample project which you can use to connect with Porta. The project contains all of the configurations and plugins that you need to get started with Porta.

If you are using Unreal Engine by itself, the default location for the project folder is:

**C:\Users\UserName\Documents\Unreal Projects**

If you are using Unreal Engine with Designer, the default location is:

**C:\Users\UserName\Documents\RenderStream Projects**

The Demo\_Light sample project is configured to run in **Standalone** game mode.

Click the **play** button to play in Standalone mode.

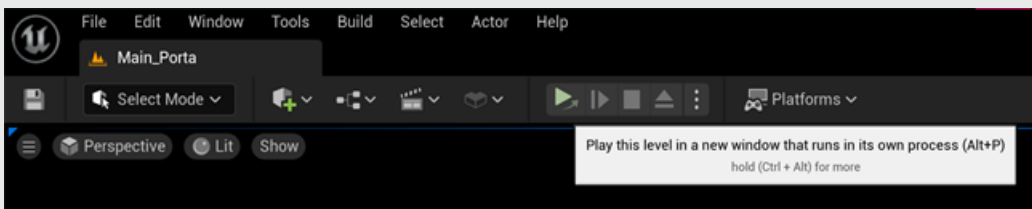



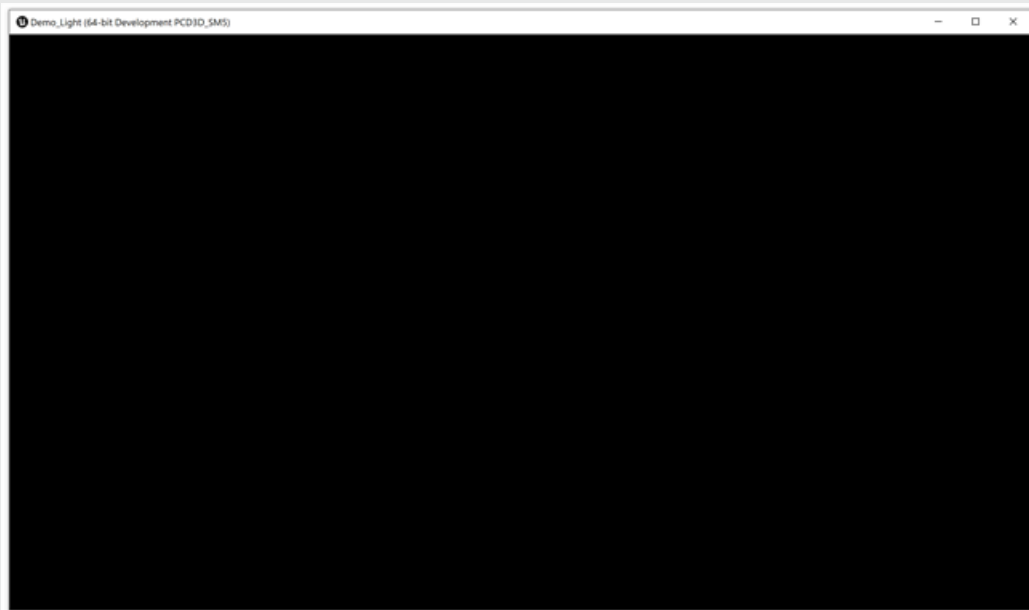

When Standalone mode plays the project the window is black. This is by design.  
The next step is to connect the project to Porta.

# Porta Workflow

Binding an Unreal project to Porta allows it to be remotely controlled from the browser. A Porta Config file enables any machine running an Unreal project to connect to an instance of Porta.

## Connect an Unreal Engine project to Porta

Confirm that the Unreal Engine project that you will be using with Porta is in your default Unreal Engine project folder.

If you are using Unreal Engine by itself, the default location for the project folder is:

**C:\Users\UserName\Documents\Unreal Projects**

If you are using Unreal Engine with Designer the default location is:

**C:\Users\UserName\Documents\RenderStream Projects**

Next, ensure there is a **PortaConfig.ini** file in the **Config** folder inside your project.

```
[Socket.IO]
SocketURL="[Porta URL]"
PortaChannel="[ComputerName]"

[Media]
AssetCacheFolder="C:\PortaCache"
```

Edit the PortaConfig.ini file adding the following information:

— [Porta URL]

This is the URL that you will use to access Porta, such as **https://[websiteName].porta.solutions**

— [ComputerName]

This is the name of your computer and will form the Channel ID in Porta. You can rename your computer before adding it to the .ini file to give it a uniquely recognizable name. For example:

```
PortaChannel="WendyA3ro"
```

`AssetCacheFolder`

Create an asset cache folder. For example using, the `C:\PortaCache`

If your project is on a different drive ensure the `AssetCacheFolder` in the `PortaConfig.ini` points at it.

The next step is to log in to Porta in your browser.

## Log in to Porta

1. Open the Porta login page in your browser.
2. Enter your user credentials.
3. Click the **Login** button.

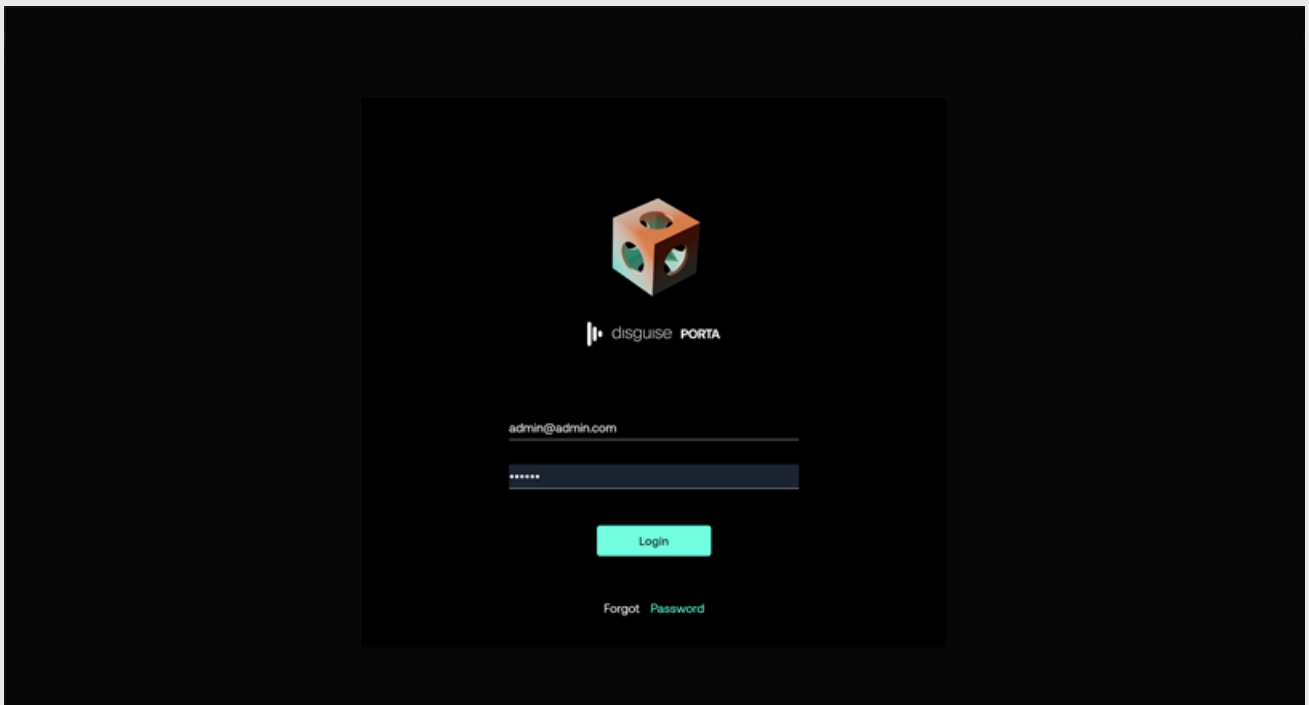

Over the next few sections, this guide will cover the key features of Porta 2.0.

## Create a project in Porta

All activity in Porta is project-based. The starting point for designers is to create a project.

There are two ways to create a new project:

1. Click on the **New Project** button in the menu ribbon.

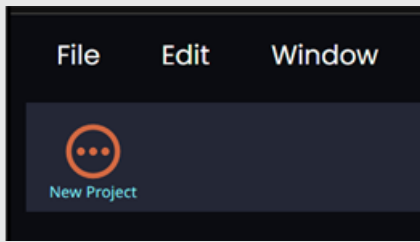

2. Or click on **File > New > New Project**.

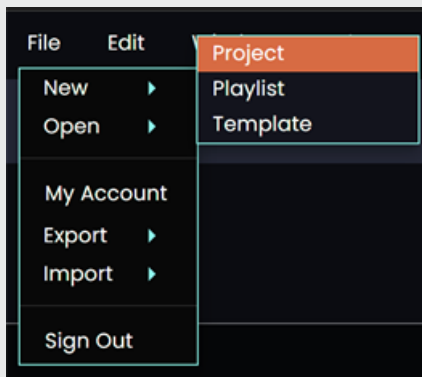

Next, add a name for the new project and click **Save**.

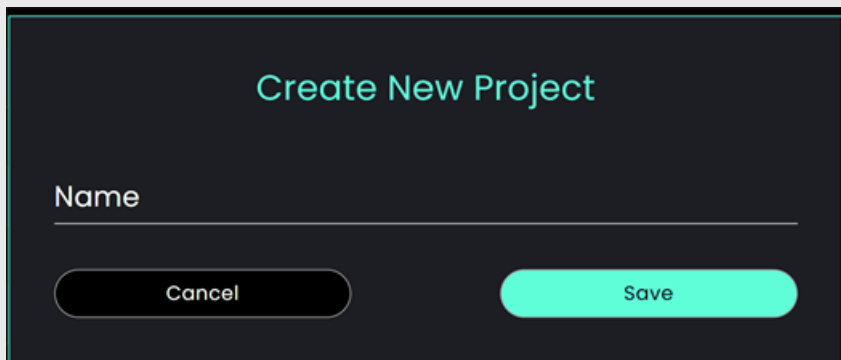

Note: creating a project will automatically create a playlist.

# Templates

## Introduction to Templates

A template allows designers and operators to control the properties in Unreal Engine from Porta. You can make a template with or without Unreal using the Template Builder. If you make a template without unreal it is essentially a form. In this way, if an Unreal Engine graphic isn't ready, the template can still be made and you can connect that binding between Porta and Unreal Engine at a later time.

Designers will test and revise templates until they are happy with them while setting up a project.

The templates need to be simple and easy to use by the operator. An operator rapidly navigates through different playlists and pages using keyboard shortcuts to trigger changes in a fast-paced work environment such as a broadcast studio, control room or newsroom.

Templates can be arranged in a grid, or in columns.

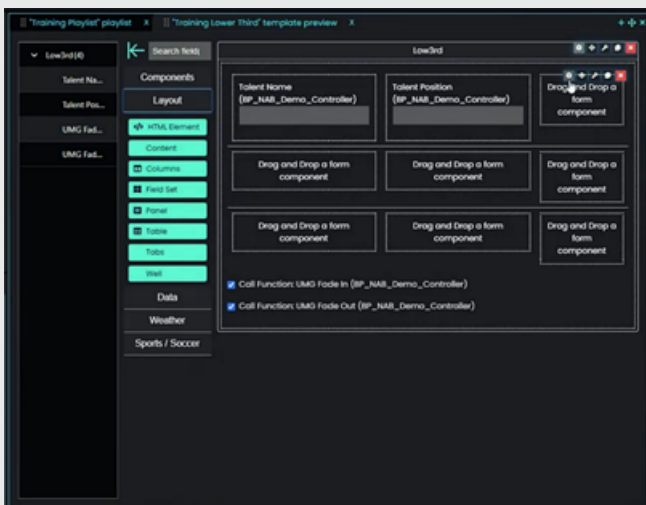

## Template Builder

Template Builder is a powerful tool for quickly creating templates. It enables designers to bring together key assets, sequences and settings in the Unreal Project that they can be triggered from Porta.

Templates create playlists, playlists organise pages, and pages include sequences and graphics that can be played simply and remotely.

# Open Template Builder

There are three different ways to open Template Builder:

1. *Open template builder from the main toolbar.*

Create a template from the quick access menu.

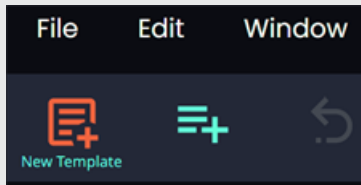

2. *To open template builder from the main menu*

From the main menu, select **File > New > Template**.

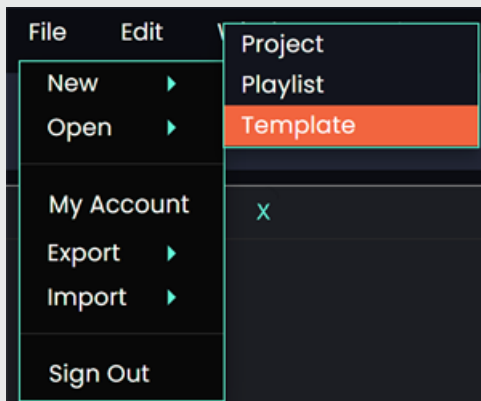

3. *To open template builder from any panel*

On the top right corner of any panel, select the + icon.

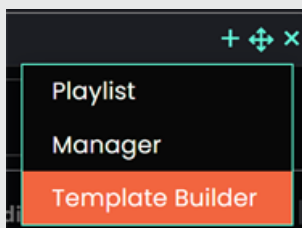

## Create an Unreal template using Template Builder

Ensure that the Unreal Engine Project has been made and is open.

1. Select **Unreal Template** from **Template Builder**.

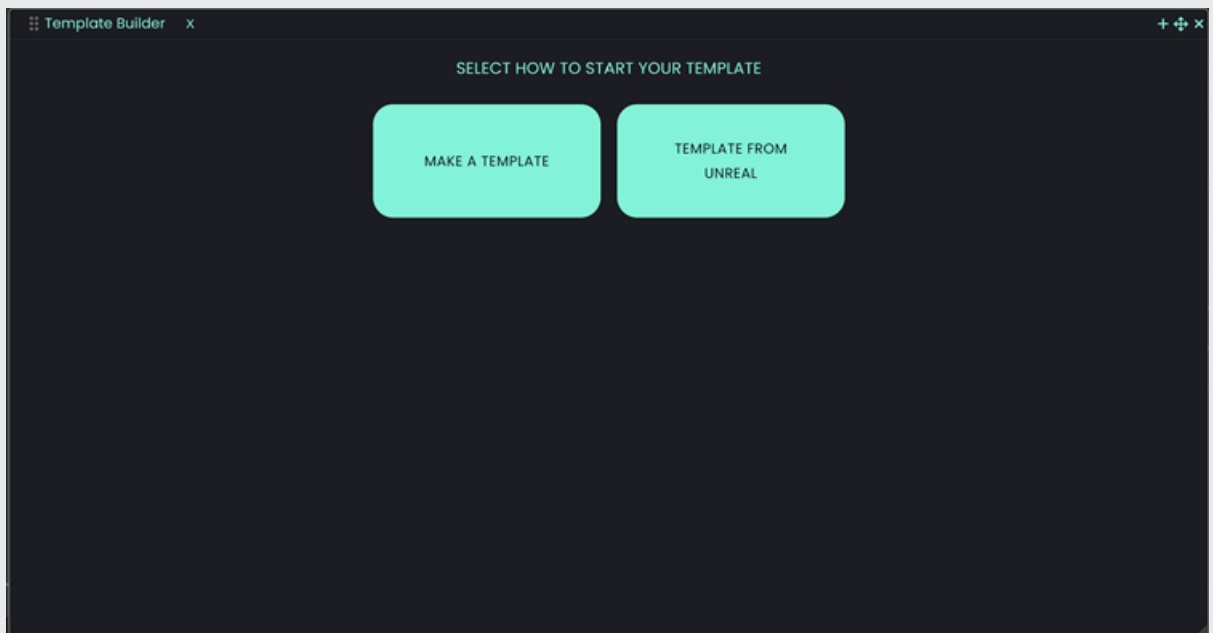

2. Select a row from the list to choose your engine to bind it to Porta and click **Next**.

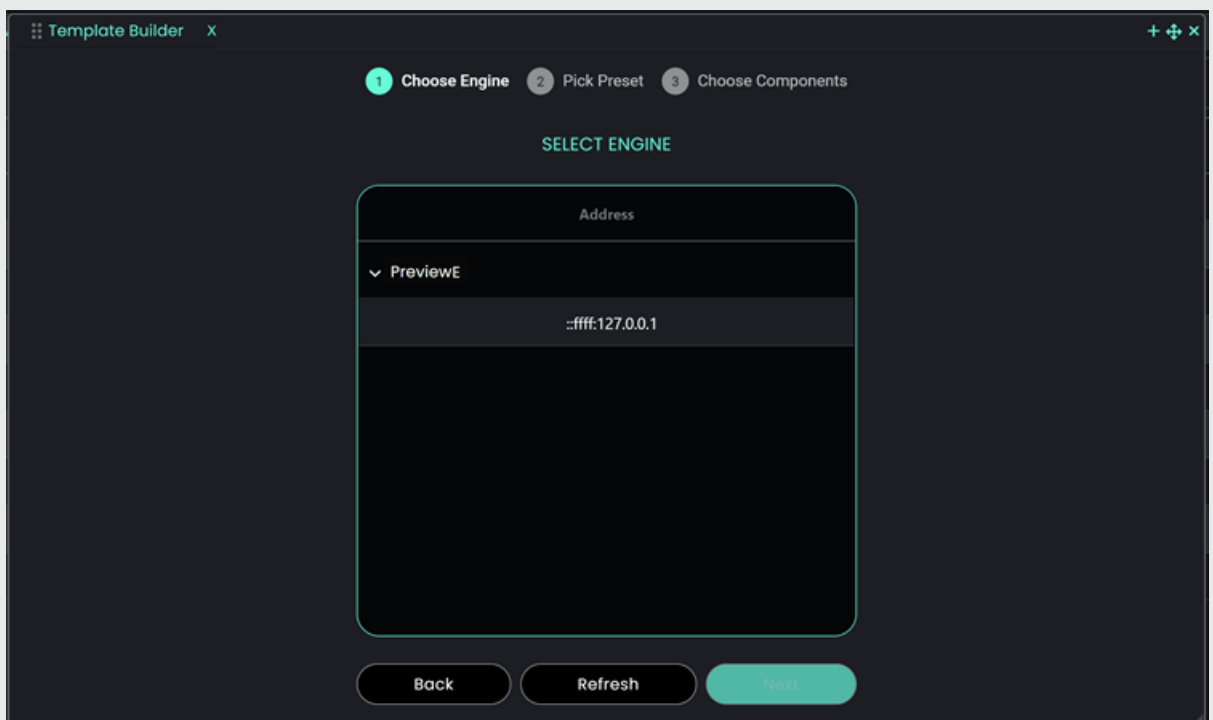

3. Select a preset from the list and click **Next**.  
With the current version of Porta, you can only connect to one Preset Template at a time to make an asset.

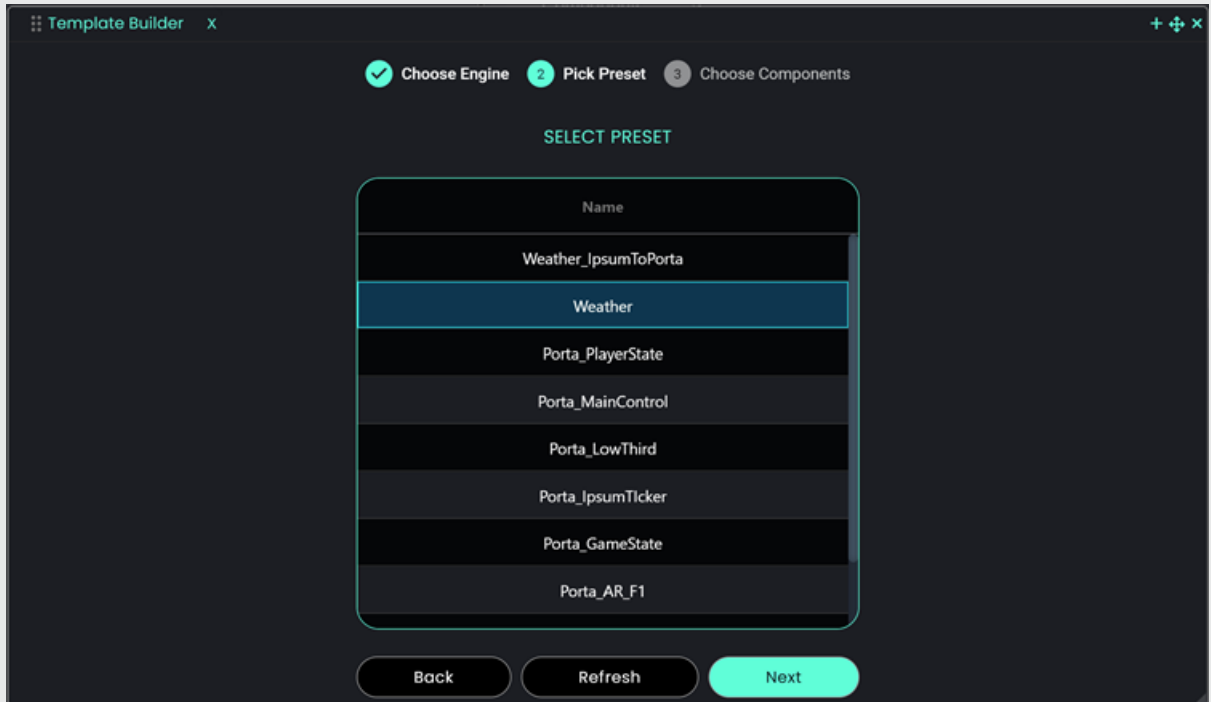

4. Select the components that you need using the checkboxes.  
A component is a property that has been exposed in Unreal Engine.

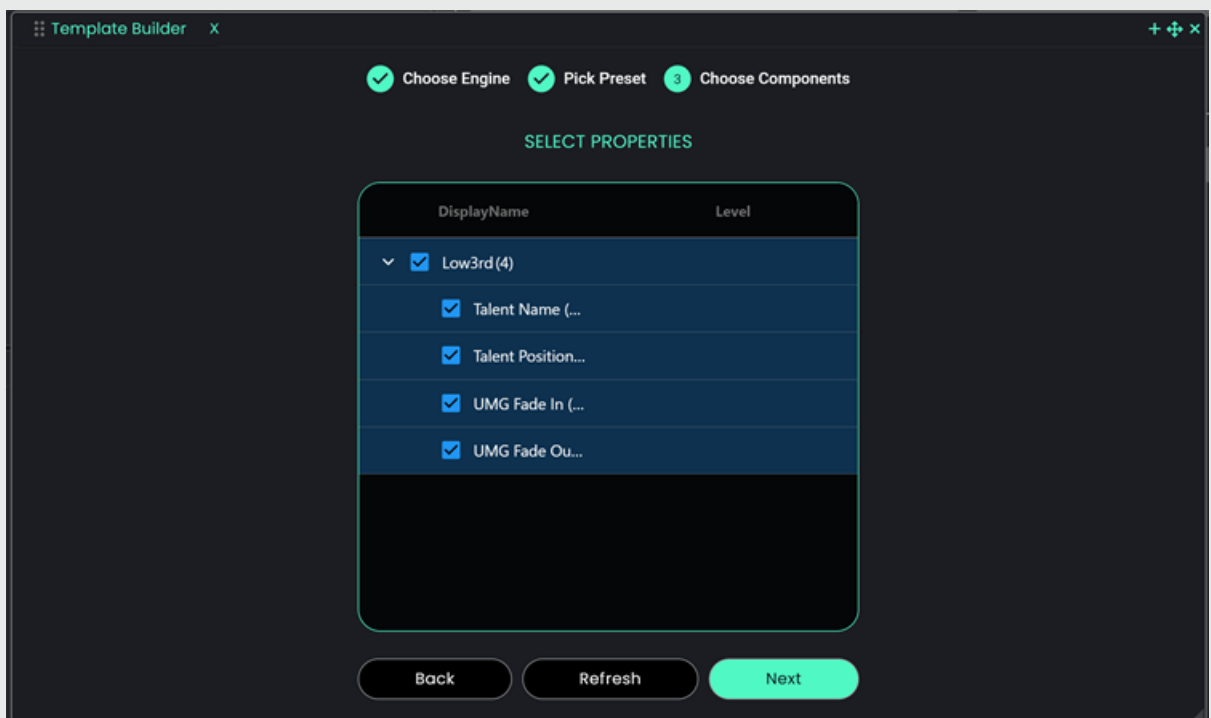

5. A form will load with all the exposed properties and functions in the UE project. This form is automatically generated to help users get started. Here you can see the Talent Name text field and the Talent Position text field. There are also two function calls that fade the content in and



out.

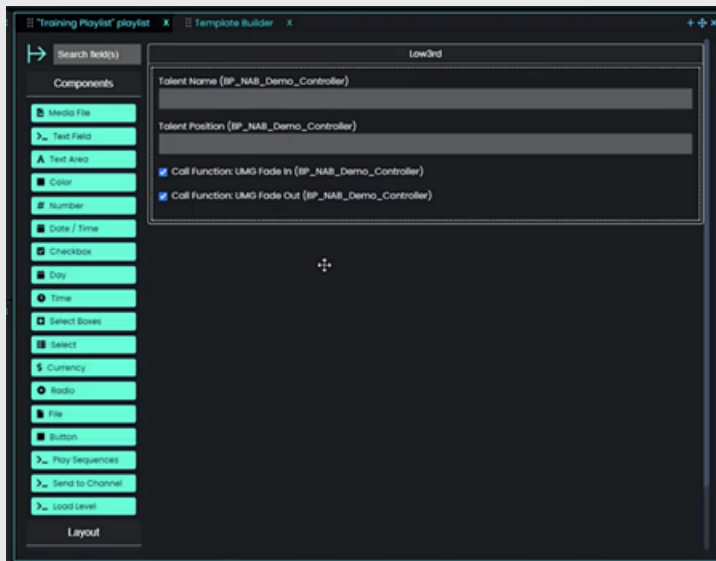

6. Maximise the Template Builder form by clicking the **Maximize** button positioned between the Add and Close buttons.



7. Click the |<- button to toggle the left sidebar panel. This panel lists all the available exposed presets in the Unreal project.

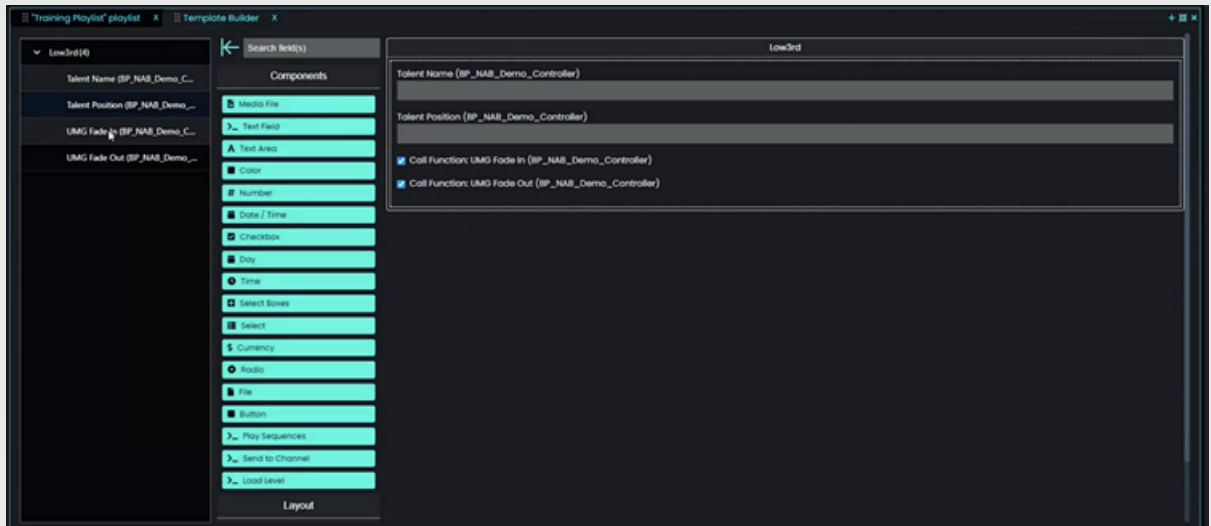

The example in the screenshot above is a Lower Third graphic component. As you can see there is a Talent Name text field and a Talent Position text field. There are also two function calls that fade the content in and out.

# Form Components

<u>Components</u>	<u>Description</u>
Media File	A Media File component allows users to select media from a media manager or upload it from a local drive.
Text Field	A Text Field can be used for short and general text input. There are options to define input masks and validations, allowing users to hold information into desired formats.
Text Area	A Text Area has the same options as the Text Field form component. The difference is that it will be a multi-line input field that allows for longer text.
Color	The color component produces a primary color fill.
Number	Number fields can be used whenever a field should be limited to a type of number value. There are options to set Thousands Separator, set Decimal Places and Require Decimals.
Date/Time	Date/Time form components can be used to input dates, times or both dates and times.
Checkbox	A check box can be used for boolean value input field. It can either be on or off. There are options to set Shortcut and Input Type.
Day	The Day component can be used to enter values for the Day, Month, and Year using a number or select type of field.
Time	The Time component can be used to input time using different time widgets you would like to use.
Select Boxes	The Select Boxes allows the user to check multiple values from list of options.
Select	The Select displays a list of values in a dropdown list to users. Users can select one of the values.
Currency	The Currency component should be used when a field should display currency amounts on a form. This component holds a numeric input mask that allows two decimal values and automatically adds commas as a user inputs a currency amount.
Radio	The Radio allows the user to check only one value from list of options.

File	A File component allows users to select media from a media manager or upload it from a local drive.
Button	Buttons can be added to perform various actions within the form.
Play Sequences	A Play Sequences component links to a media sequence and configures a trigger that will play it.
Send to Channel	A Send to Channel component...
Load Level	A Load Level component allows users to configure Unreal Engine levels so that they can be loaded on request.

## Supported file formats

The file formats currently supported are:

- Image: png, .jpg, .bmp, .webp, .gif
- Video: mp4, .mov, .ts, .avi, .y4m, .mkv
- Audio: .mp3, .wav
- 3D: .glb, .obj, .glTF, .fbx

Metadata tags can also be added.

## Template Builder buttons

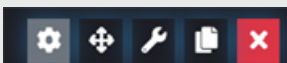

In template builder, the five buttons are:

- Edit
- Move
- Edit JSON
- Copy
- Remove

# Add a form component

Templates are built using form components and exposed properties.

For example:

1. To create a **Text Field**, drag the **Text Field** component from the list of components to the template.
2. To create a **dropdown** selection box, drag the **Select** component from the list of form components to the template.

# Remove a form component

To delete a form component from the template, hover over it. At the end of the input text field, sitting above it are 5 buttons, select the X to delete the component. When the preset has been disconnected it is highlighted orange-red.

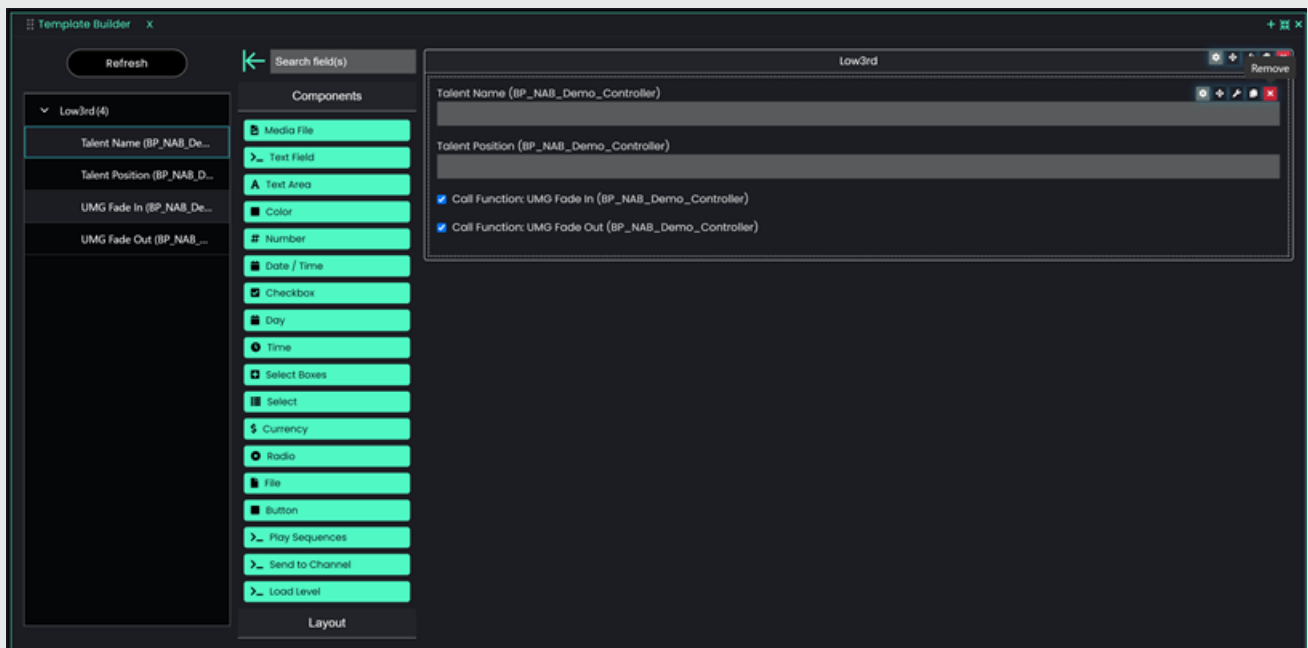

# Add a custom form component

Here is a list of other components that can be added to the template:

<https://help.form.io/userguide/forms/form-components>.

# Edit a template component

In this example, we have added a dropdown to the template using the **Select** component. The component is not connected to a preset and so it is highlighted orange/red.

1. Click on the settings edit button at the end of the component details box.

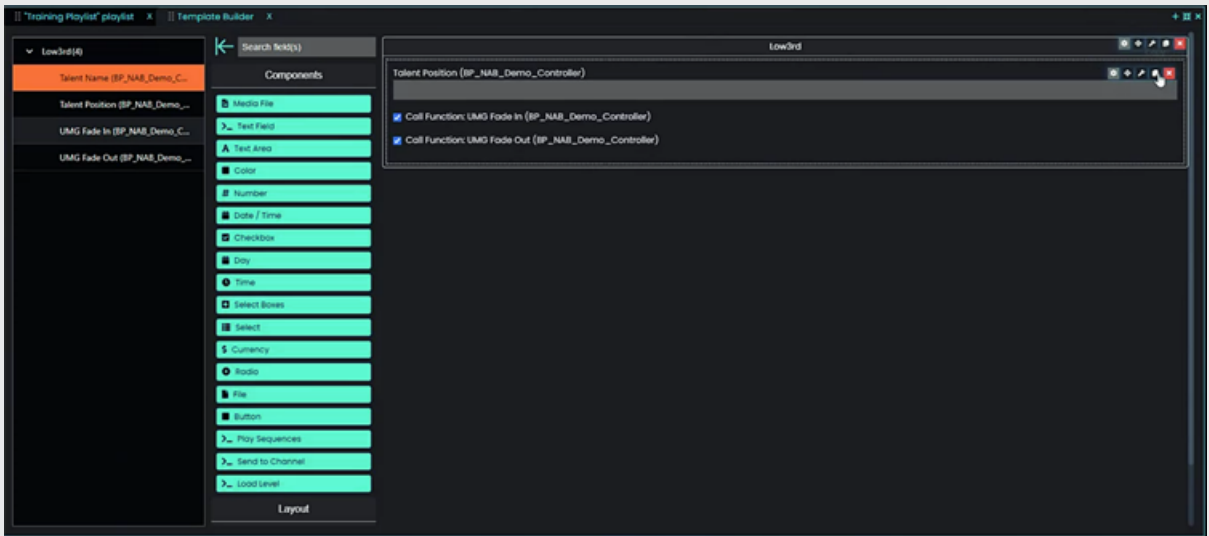
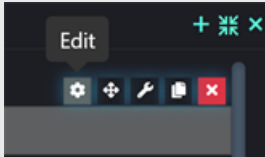

2. In **Edit** mode, select the Unreal project preset property from the list and click **Save**.

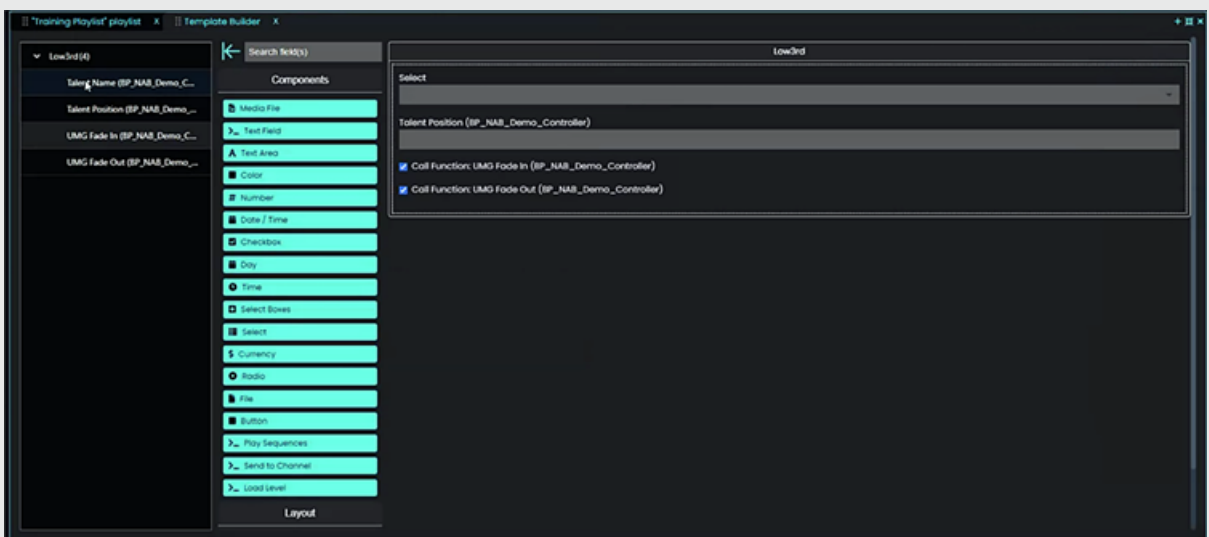

The **Talent Name** preset is now connected to the **Select** component.

Each preset component can be configured using multiple attributes:

Display - such as visible/invisible, positioning

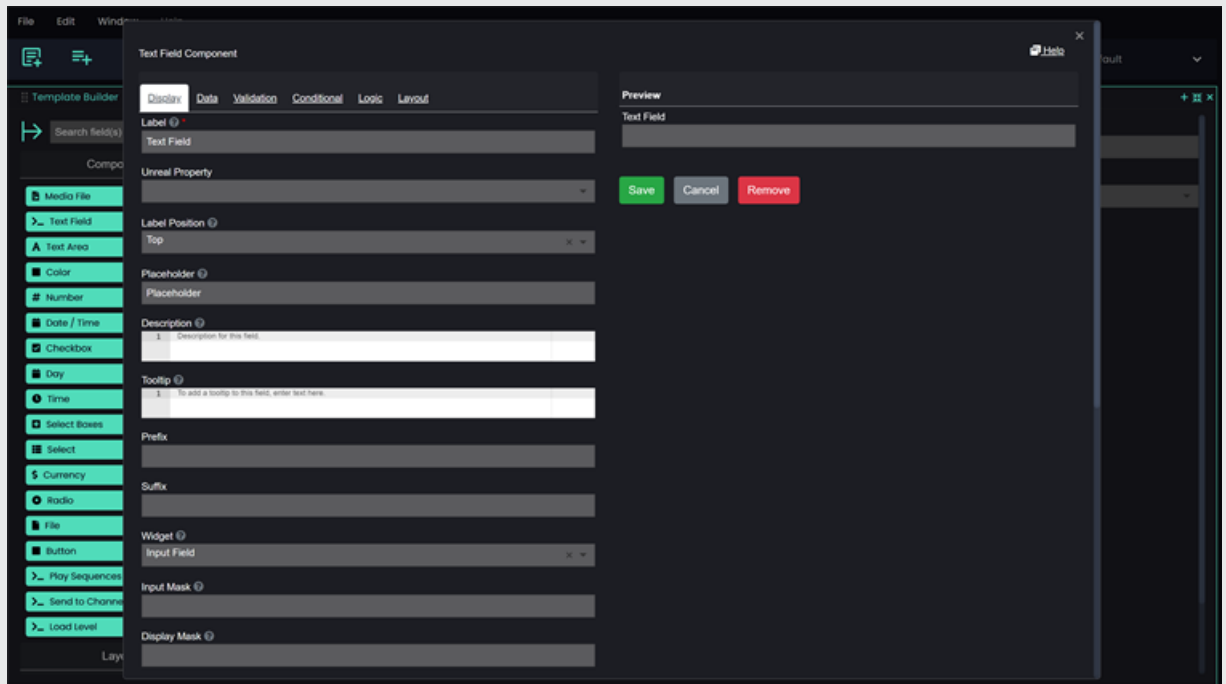

Data – such as text values

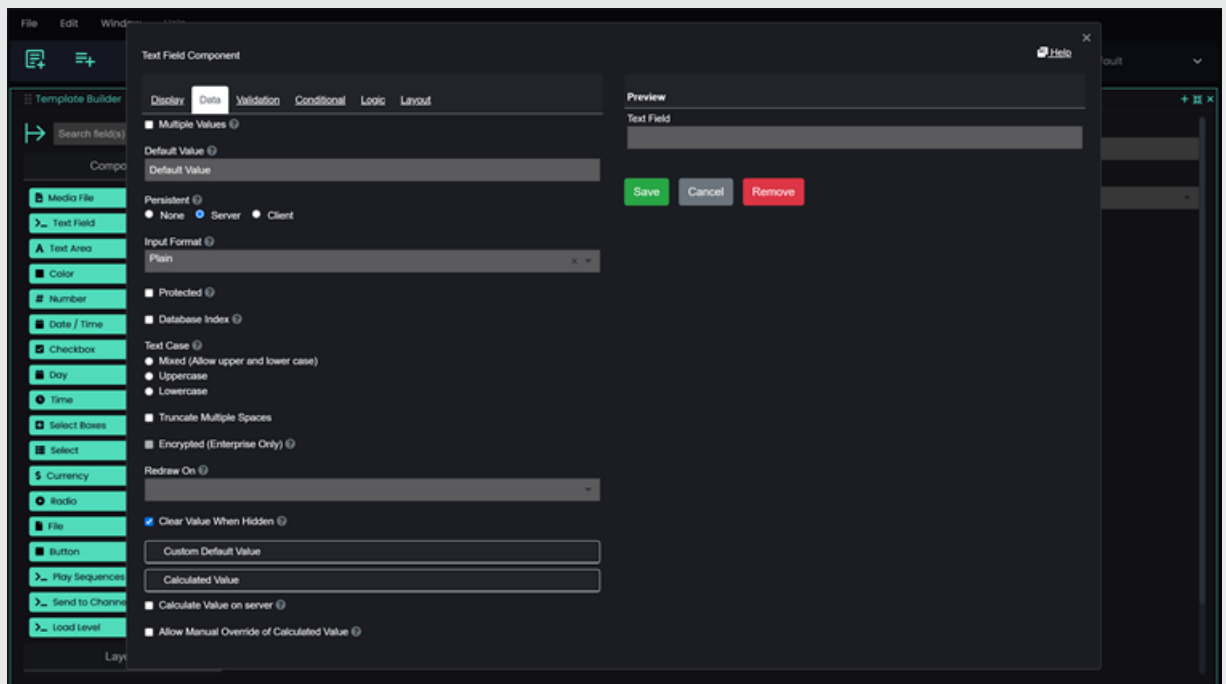

## Validation

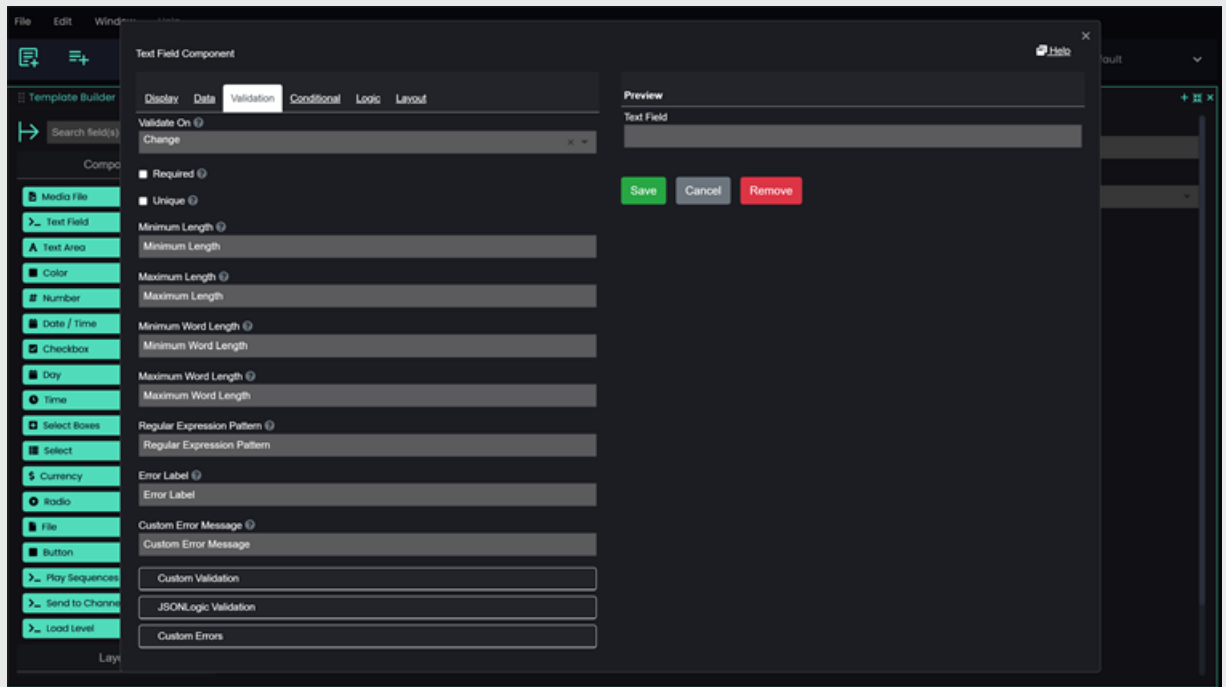

## Conditional

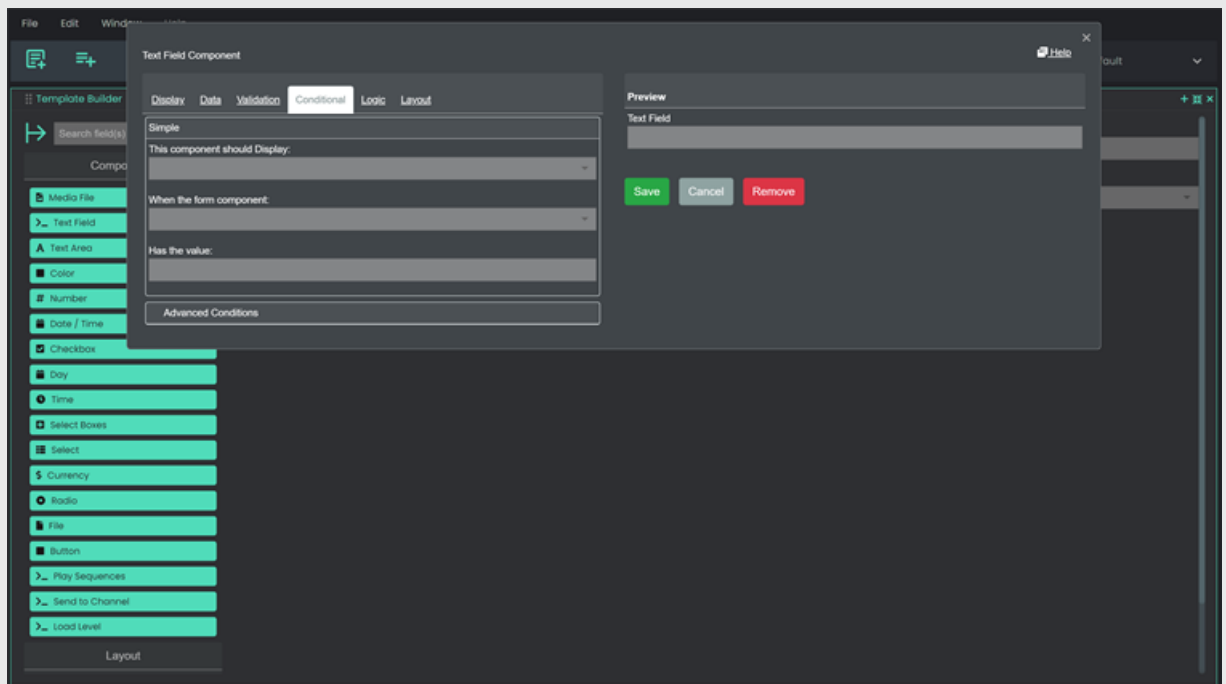

## Logic

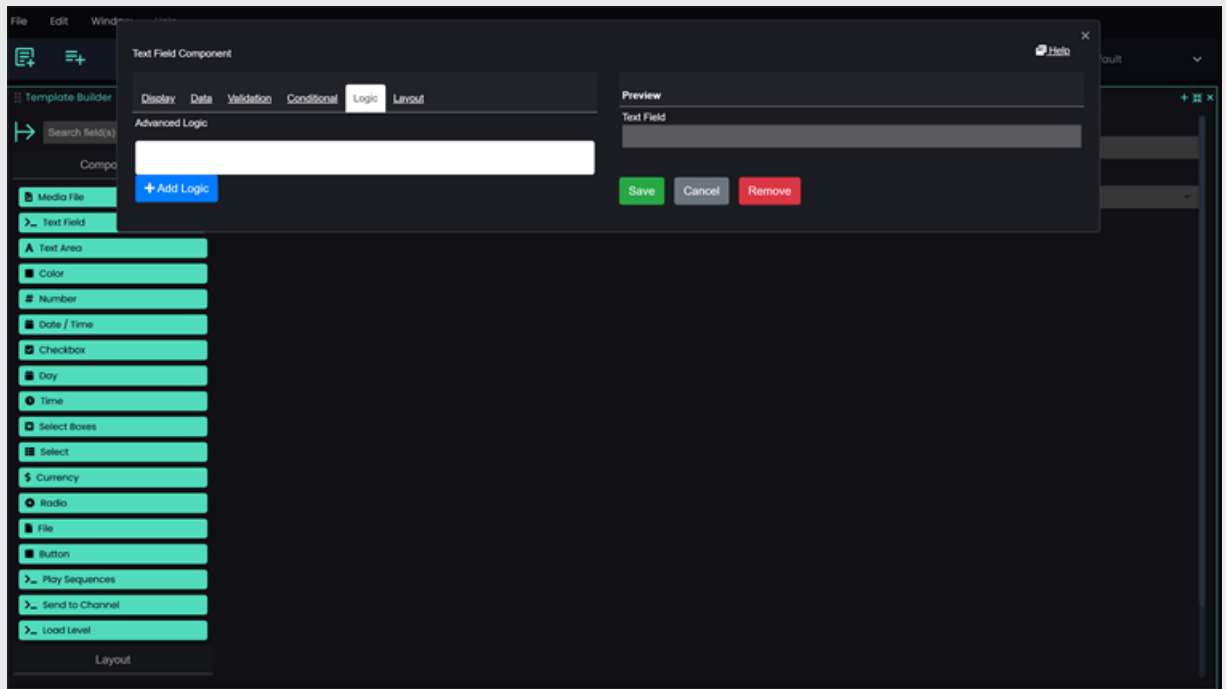

## Layout

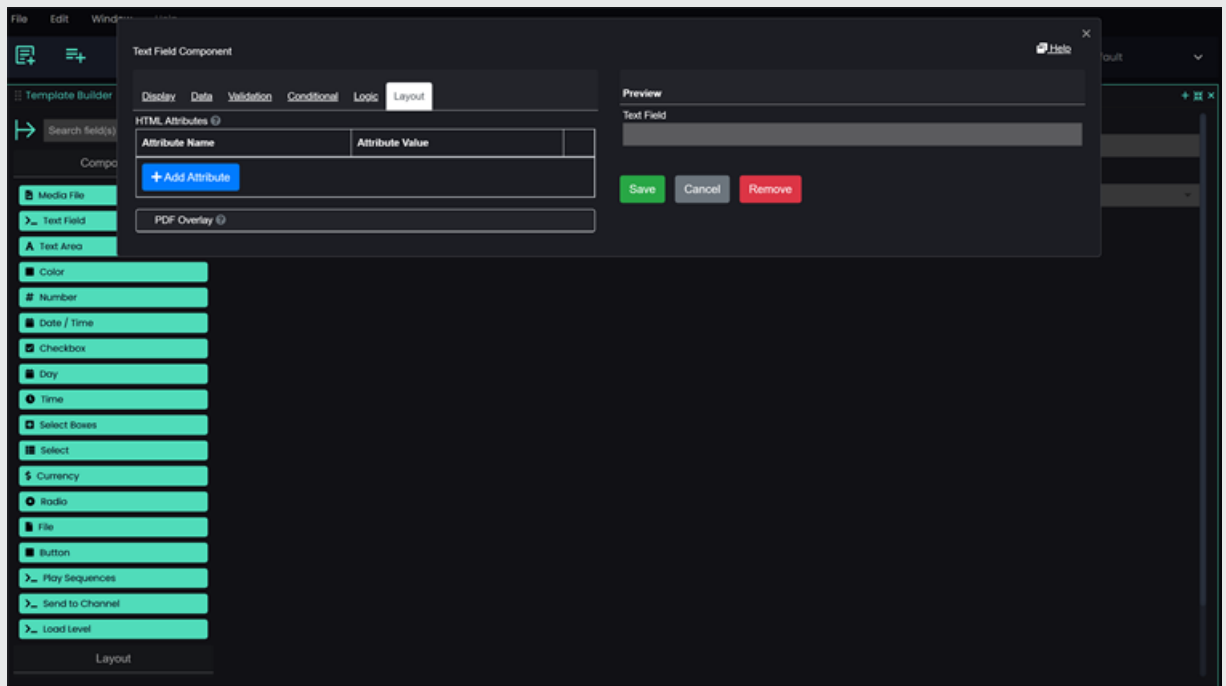



# Playlists

## Create a new playlist

When a project is created, a playlist will be automatically generated.

If you want to make additional playlists, you can use one of these three ways:

1. Click on the **New Playlist** button on the menu ribbon.

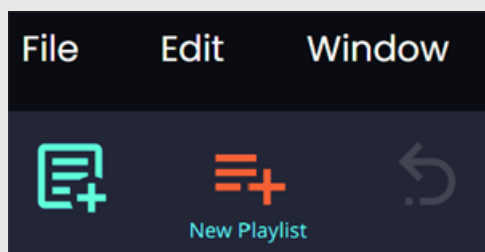

2. Click **File > New > Playlist**.

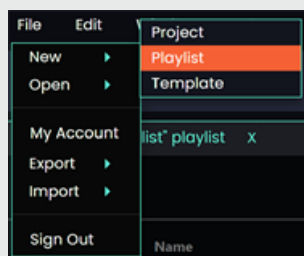

3. Click **+** to add and select **Playlist**.

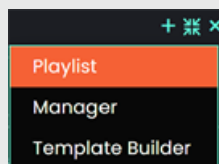

Next, enter the name of the new playlist, select a type from the dropdown menu and click **Save**.

Playlist type options are:

- **Manual** - this is the default setting
- **Number** - this allows operators to type a number to activate a preset.
- **MOS** - this integrates with newsroom control systems

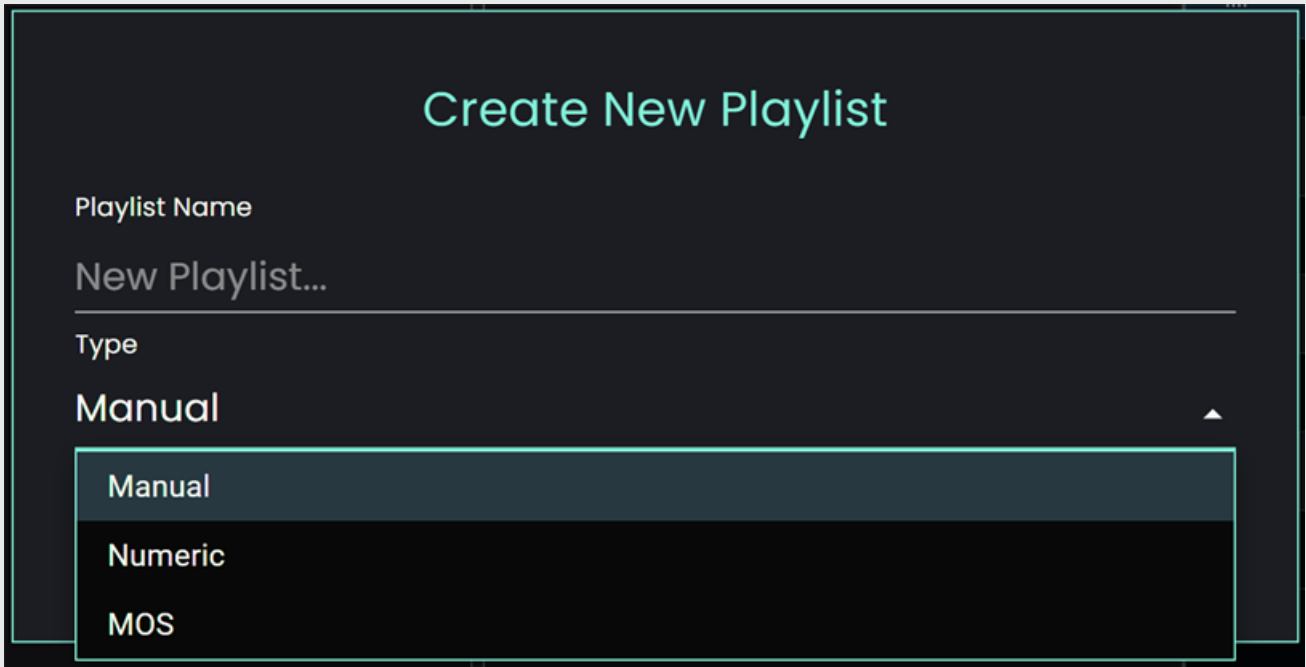

## Import playlists

Select **File > Import Playlist**.

## Export playlists

Select **File > Export Playlist**.

# Pages

This workflow allows for templates to be amended, so if a designer wants to make a change to the page, an amended template, when saved, will automatically update the page.

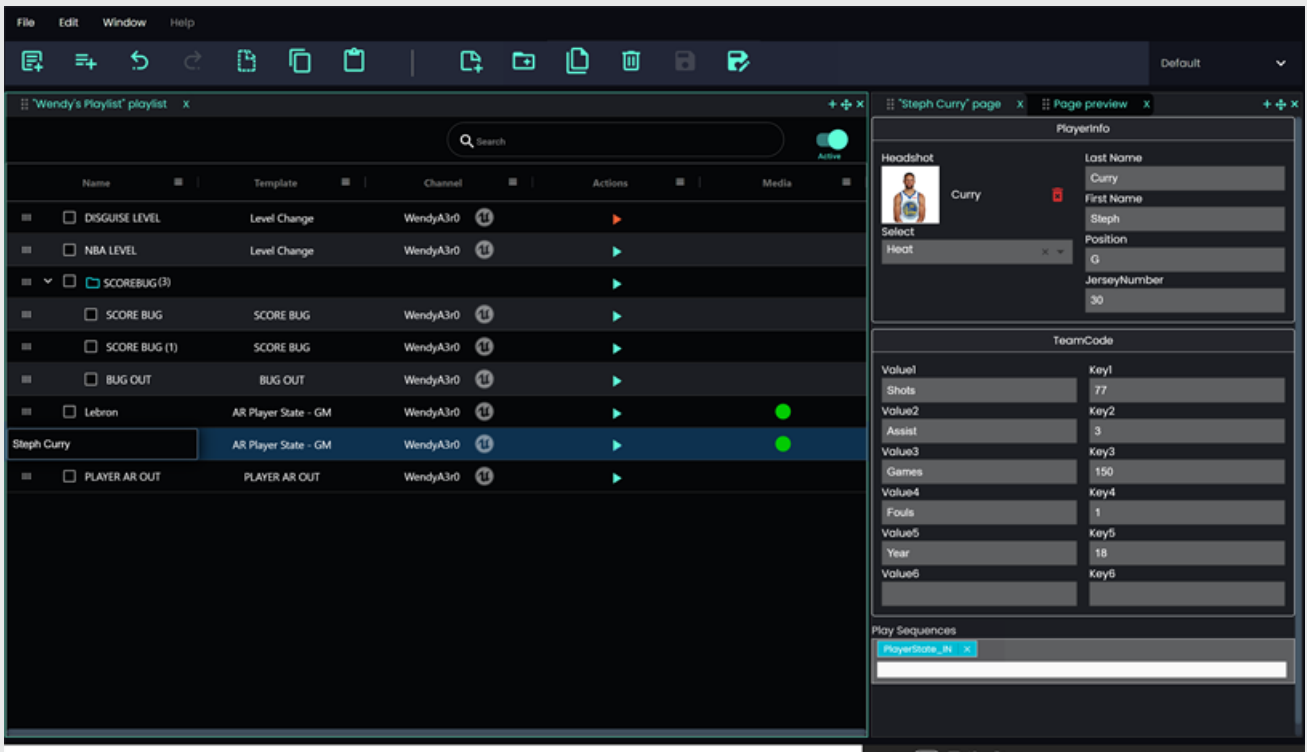

## Create a new page from a playlist

Select a playlist and click the **New Page** button.

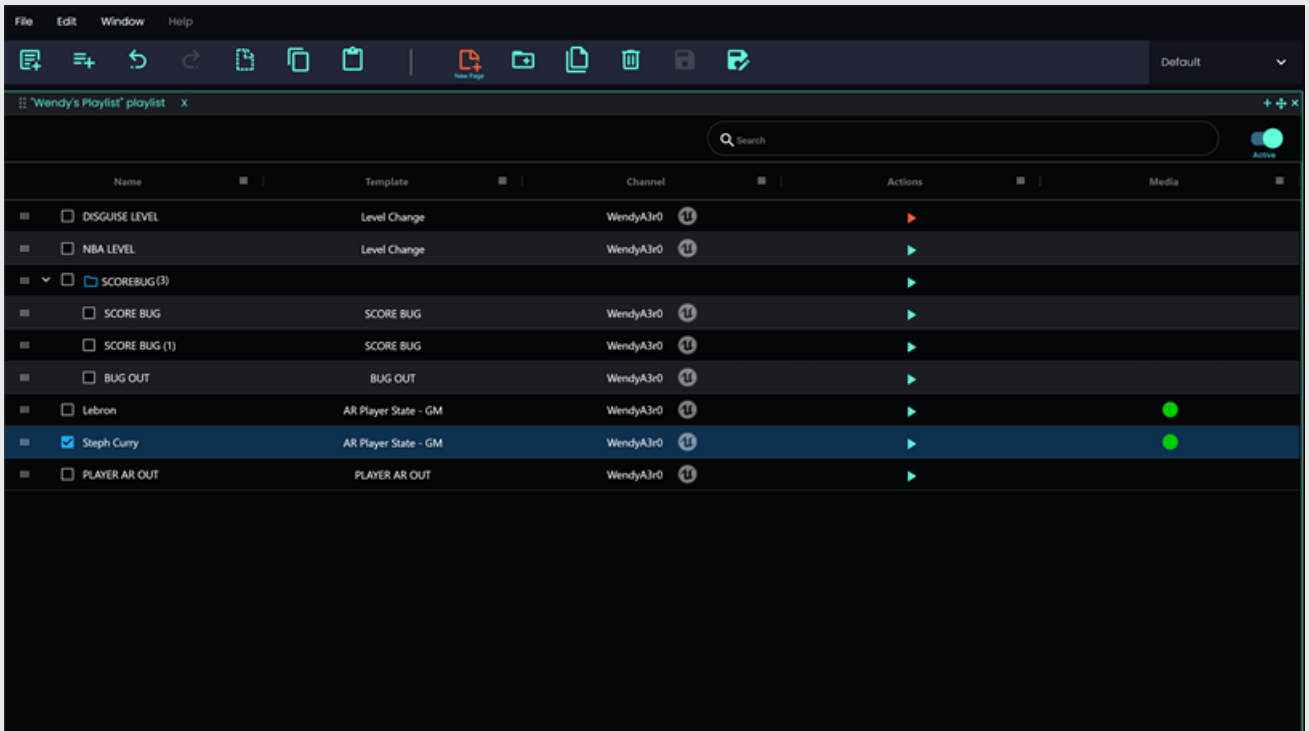

## Duplicate a page

To duplicate a page, select the page you want to duplicate and click the **Duplicate** button.

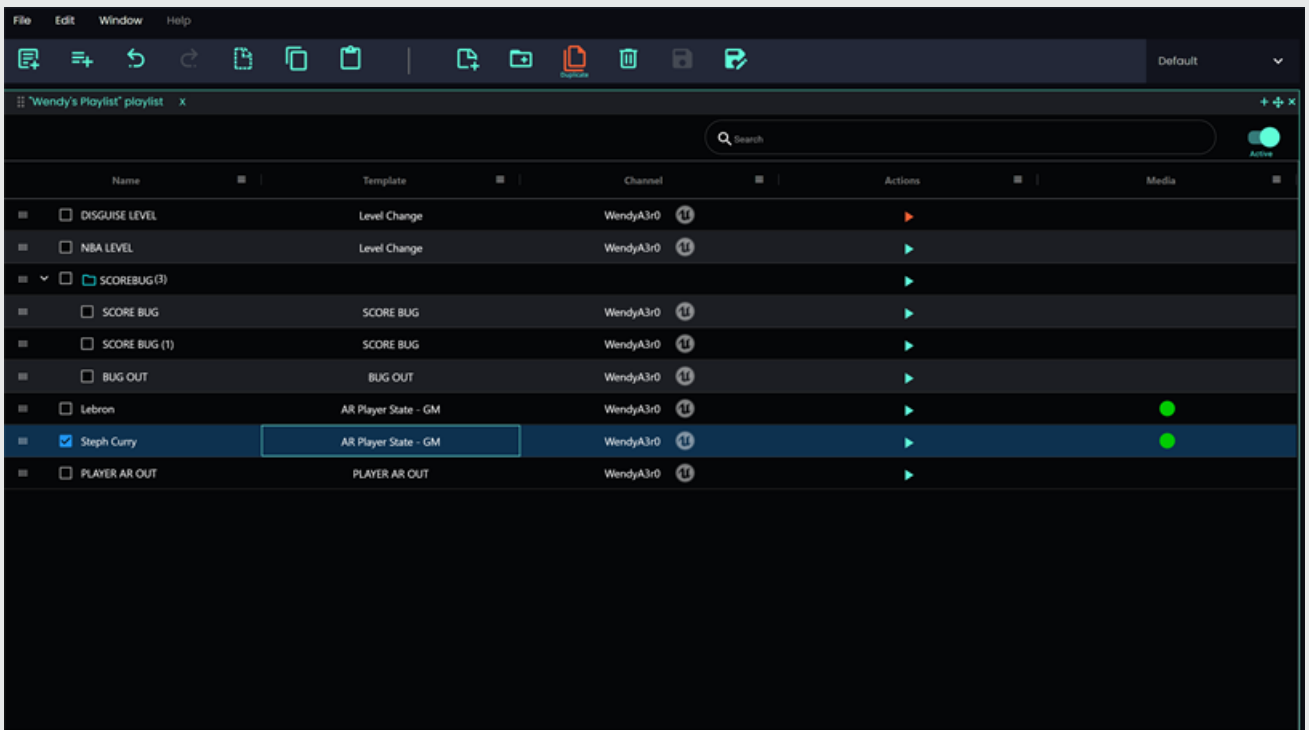

# Numeric pages

By default, pages use page names. As an operator, it can be much quicker to work with numbered pages as it is much quicker to type a number on a keyboard num pad to call up a page.

## Enable numeric pages

1. To enable numbered pages click on **Window > Manager**.
2. Click on **Playlists**.
3. Click on **Rename** in the main toolbar.

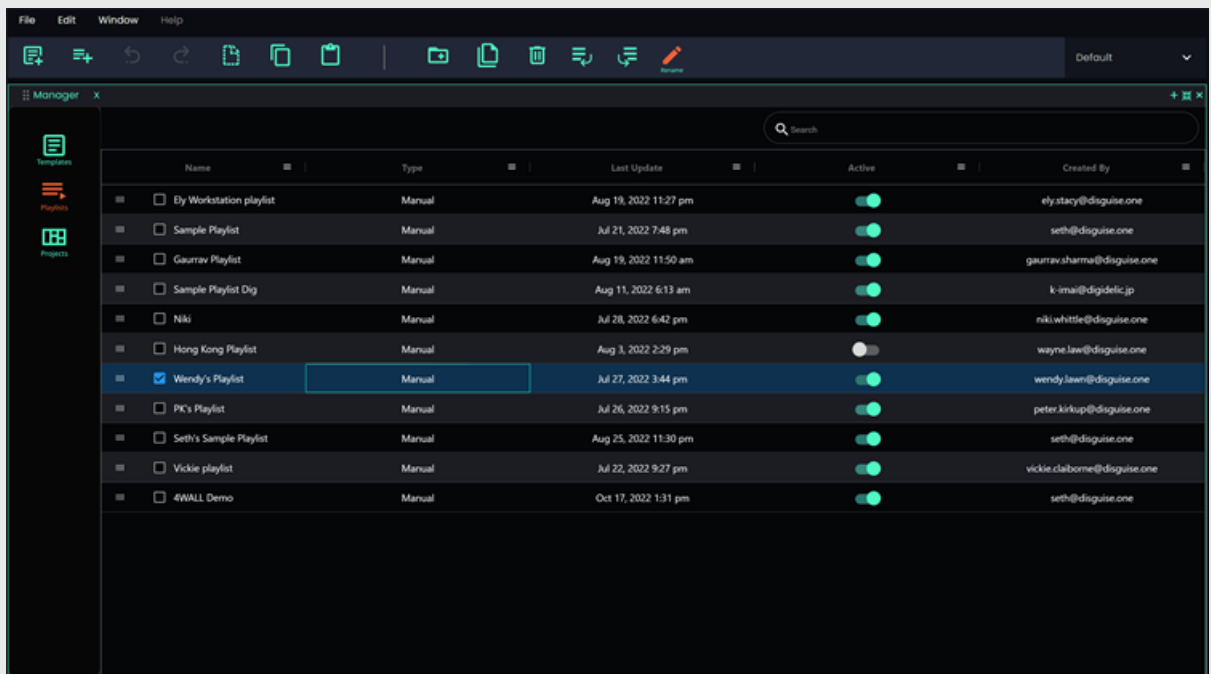

- Under Type, click on **Manual** and select **Numeric** from the dropdown list.

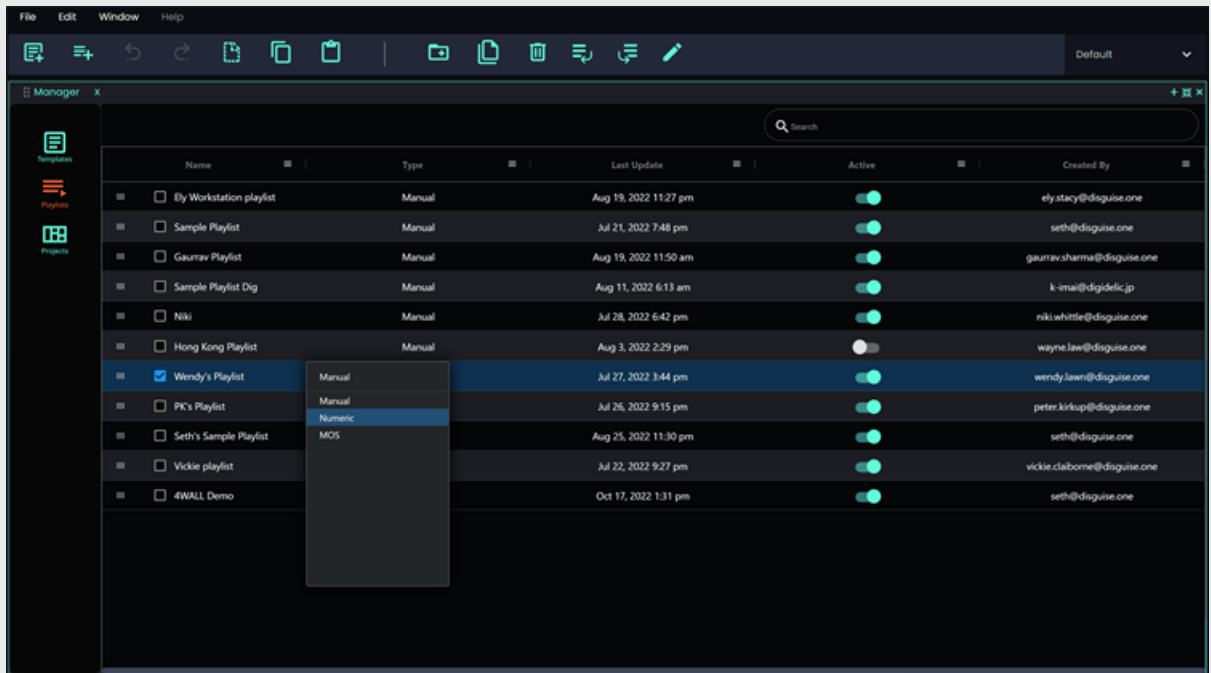

- Return to the playlist. You should find that the page names have been replaced with numbers.

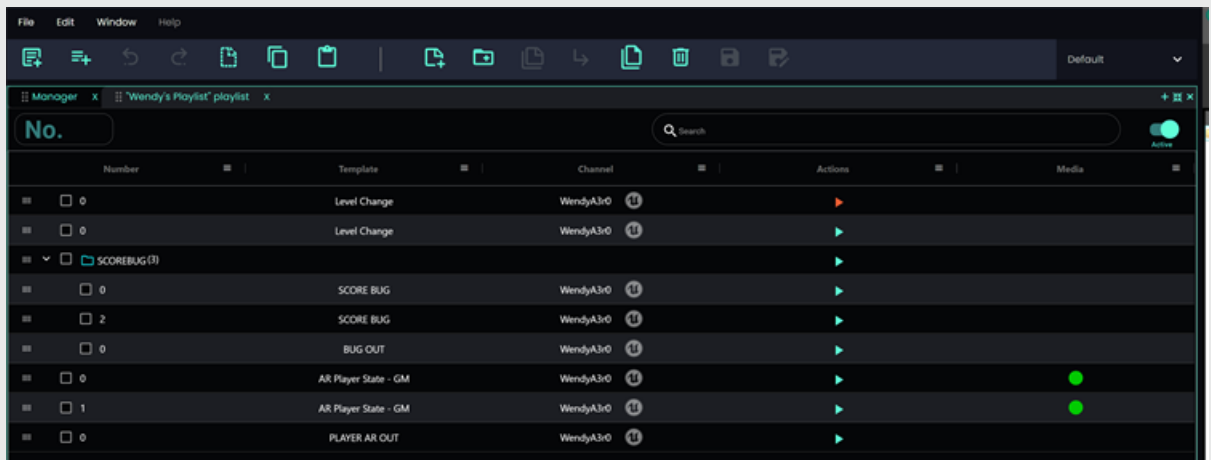

## Play a graphic

Play the Unreal project in Standalone mode and click on the play icon in the **Actions** column.

# Group page items

1. Highlight the items that you want to group.
2. Click the **folder+** icon.

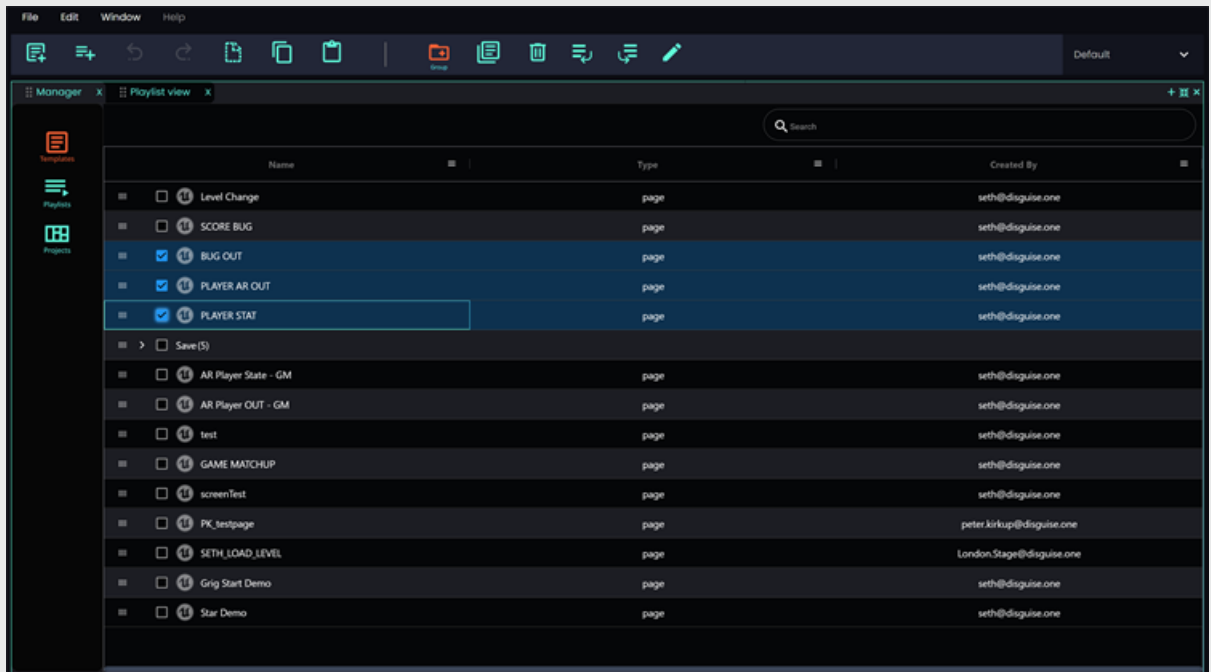

3. Enter a name for the new group and click **Save**.

# Channels

Channels reference the machine that runs the Unreal Engine project.

By assigning channels, users determine where content is played. Different channels can be selected for certain things based on a company's requirements.

## Assign a channel to a project

Select the output channel in the Channels column of the template. A dropdown lists all the available channels.

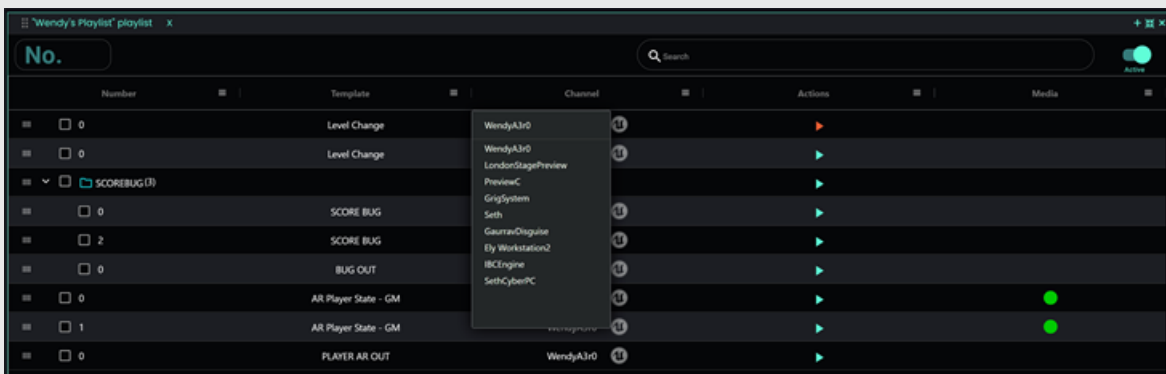

## Set a default channel for all projects

1. From the **Window** menu in Porta, click on **Settings**.
2. In the **Settings** panel, select **Channels**.
3. Here you can set your most frequently used channel as default by editing the **Default** column. The default channel will automatically be assigned to new playlists.

If a new channel has been added but does not appear in the list, click on the **Refresh** button.



Settings x + ✕

Keyboard Shortcuts ↻ 🔍 Search

Name	Default	Address	Type	Stream type	Stream url
<input type="checkbox"/> Default					
<input type="checkbox"/> VCBlade	No	::ffff:127.0.0.1	🔊	video	
<input type="checkbox"/> PK-laptop	No	::ffff:127.0.0.1	🔊	video	
<input type="checkbox"/> WendyA3r0	No	::ffff:127.0.0.1	🔊	video	wss://localhost
<input type="checkbox"/> LondonStage	No	::ffff:127.0.0.1, ::ff...	🔊	video	
<input type="checkbox"/> LondonStagePr...	No	::ffff:127.0.0.1	🔊	webrtc	wss://localhost
<input type="checkbox"/> Niki	No	::ffff:127.0.0.1	🔊	video	

Channels  
Integrations  
My Account  
Preference  
Users

# Page Preview

Designers can choose to expose properties, but they can also load levels. The Unreal level can load into Page Preview. If you have multiple levels in your Unreal project, the Load Level field will automatically list all levels in a dropdown field.

In this instance, the lower third will appear as an overlay on top of the level preview.

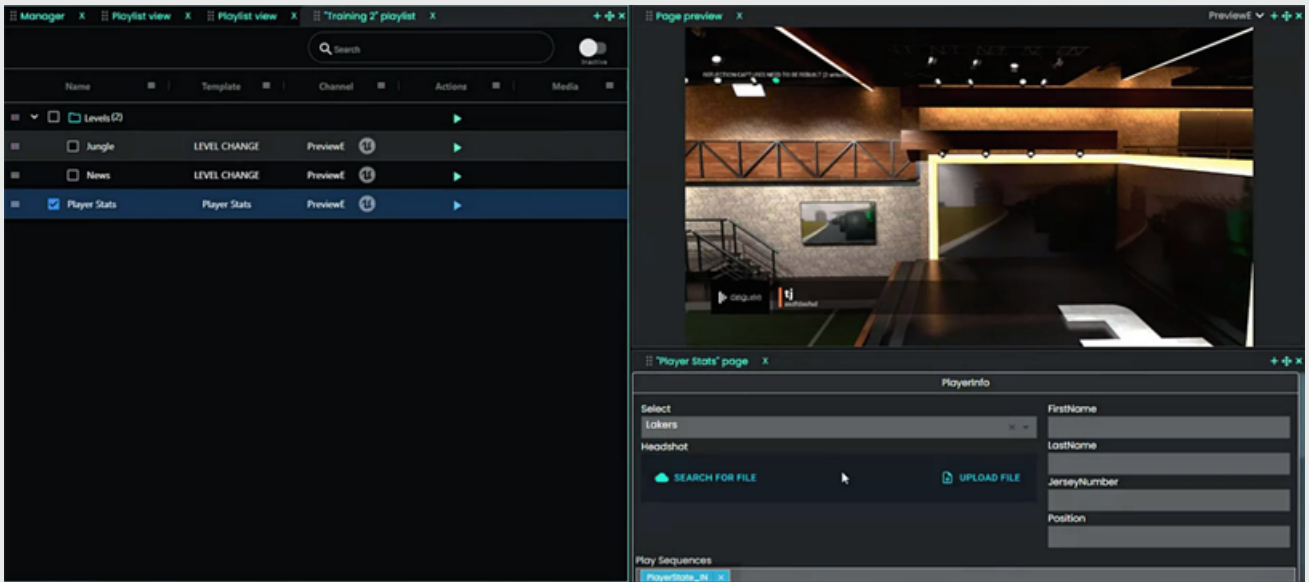
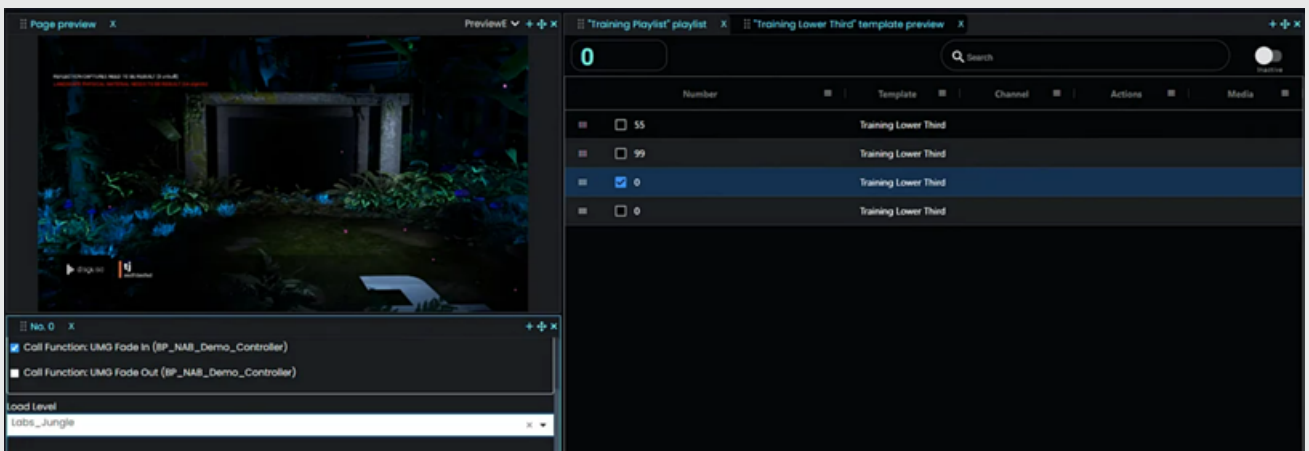

# Loading levels

Select the level from the **Load Level** dropdown list.

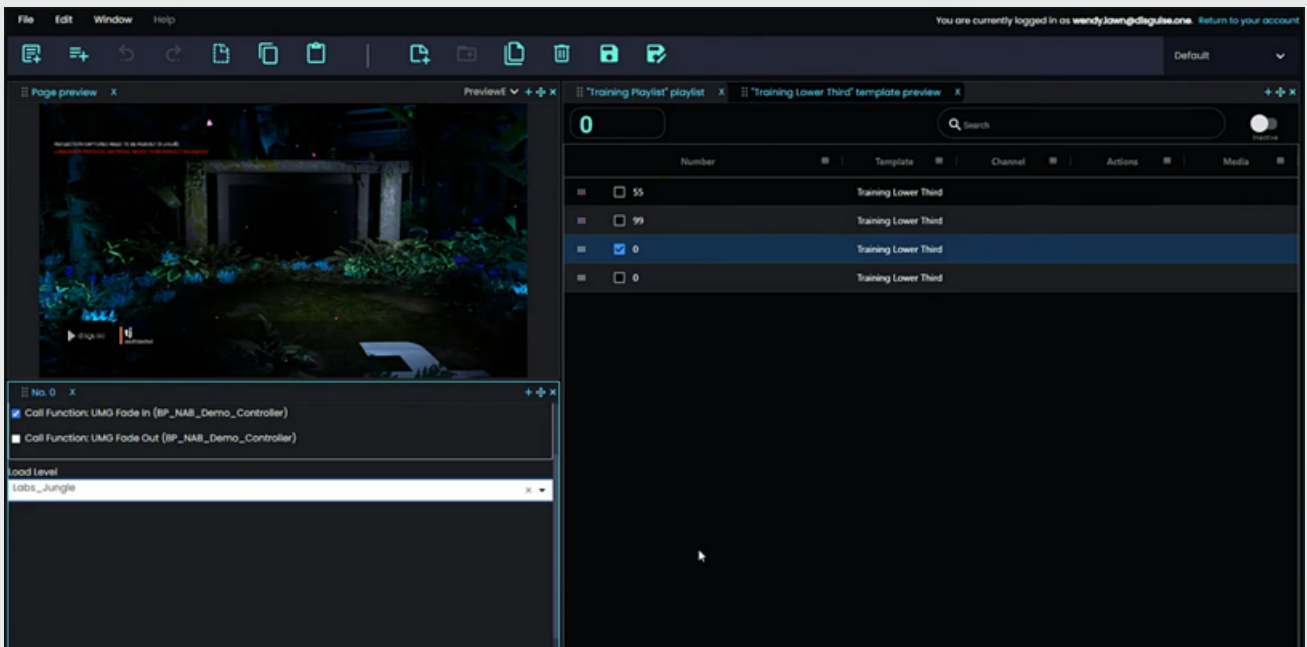
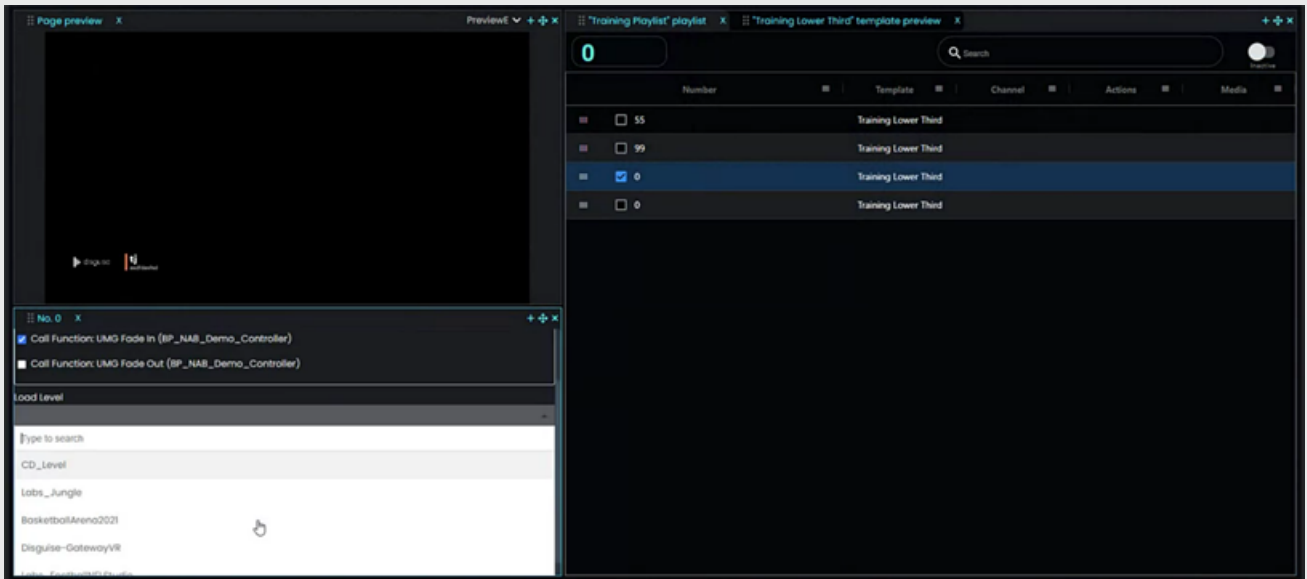

## Camera Switching

- Camera switching relies on exposing parameters on cameras in the Unreal Project.
- A designer would then connect the project presets and add the cameras to a template in Template Builder as a selection dropdown. It can be previewed here.
- The template is used to make a playlist.
- The camera options must be added to a page and any switching can be done from the page.

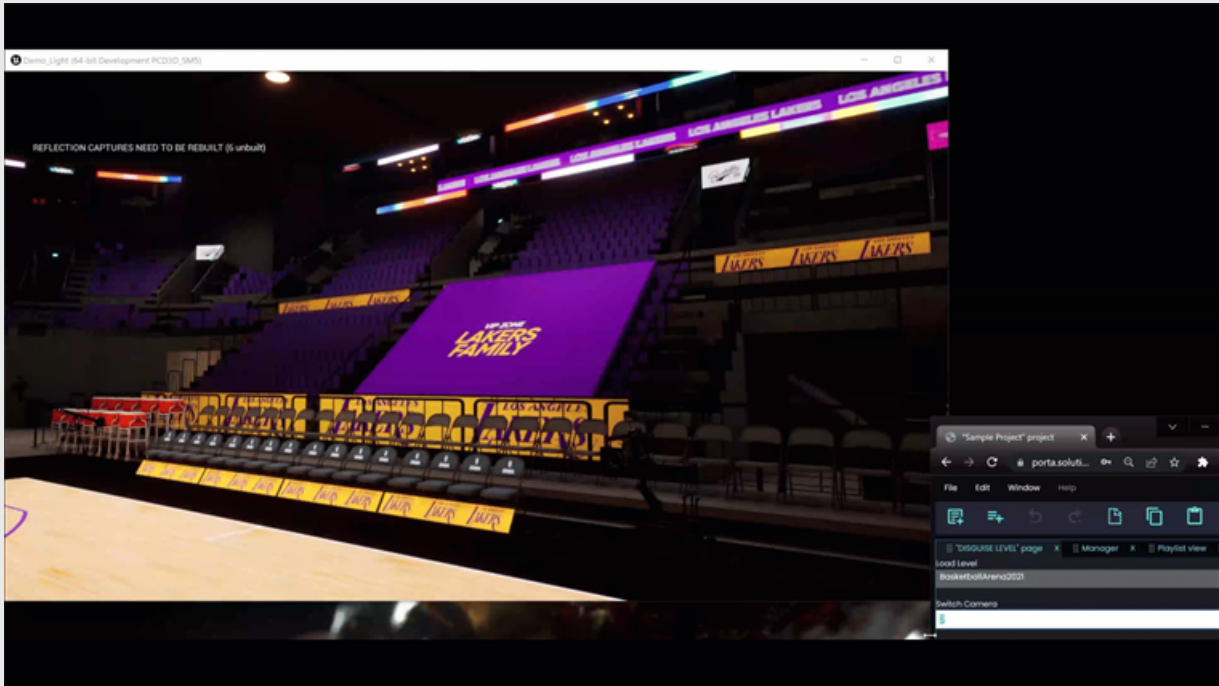

# Manager

The Manager shows you everything in Porta. It shows you all the templates, playlists, and pages that you have in your projects. You can manage them and open them from here, and when you open a template from the Manager, the Manager moves to a separate tab. The Manager is very useful when you have hundreds of templates that you need to keep organised.

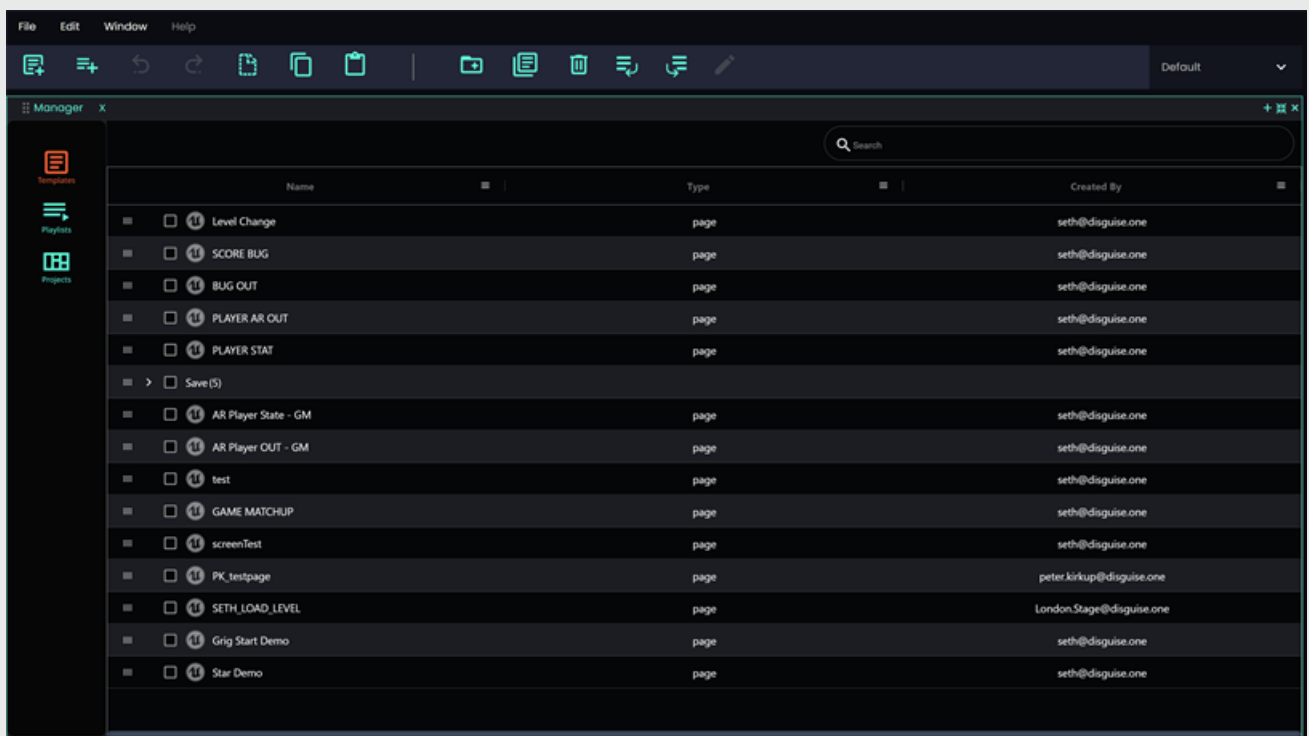

# Settings

With a few exceptions, settings in Porta are the domain of the engineer. Keyboard settings can be customised by designers and operators, but many items in the settings menu are managed by someone in the IT or engineering department. This includes configuring user accounts, adding channels, setting up any integrations, and connecting to data feeds. Admins also have the functionality to log in as a user and see Porta as that specific user would.

IT engineers or admins create new users and set user roles and permissions. Among admins, there might be a user admin who just creates users, while a system admin has greater control privileges and can determine precisely what the user can do, including which channels the user has access to, and configuring which API keys are assigned to users. In larger companies, this would include many different channels for different studios.

IT managers can set controls such as what happens in a preview and how is it previewing the graphics by type. Most customers use Web RTC for preview and then configure the URL when working locally within their network, or on their own pc. This uses your local host or your local IP. The demo preview project uses a public URL created specifically to control things from the cloud.

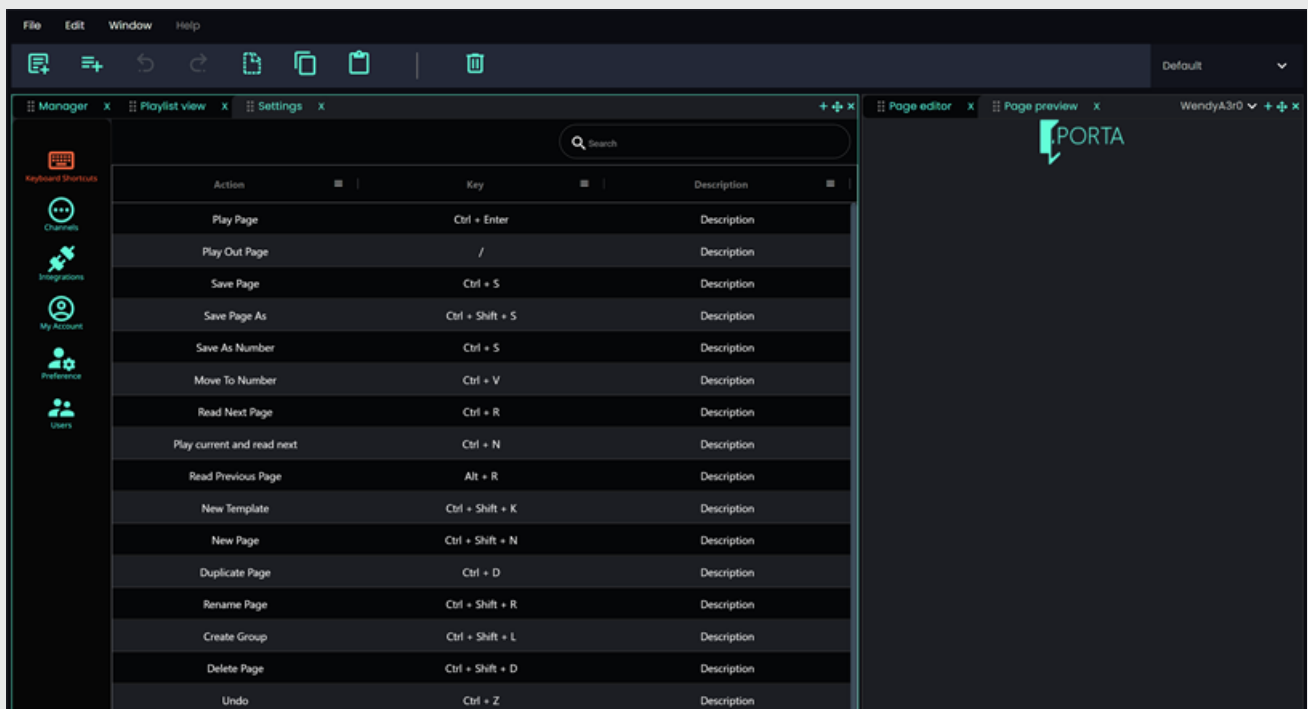

# Working with Designer

## Technical requirements

Designer installed on your machine

## Connect a Designer project to Porta

To set up a Channel and a playlist you will need to connect Designer on your machine to Porta.

1. Open the sample project in Designer using d3manager.

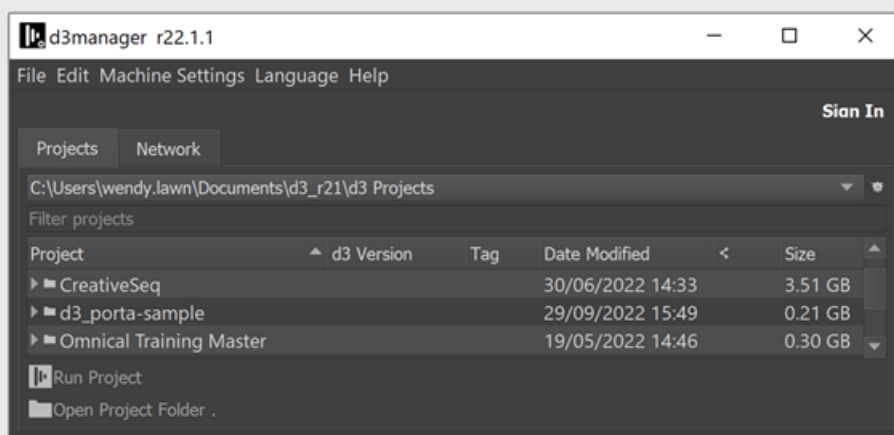

2. Open the IO Server application and add the URL of the Socket Server and click **Connect**.  
If a green square appears it has made a connection.
3. Add a Channel Name such as "Porta".

4. Type your IP address into the **D3 IP Address** text field and click **Add Channel**.

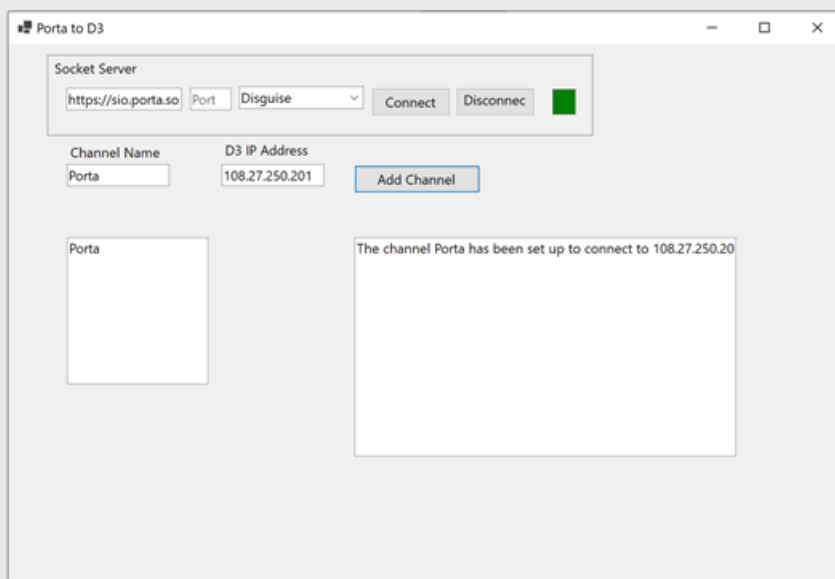

5. Log in to Porta in the browser and confirm that your channel has been set up correctly.

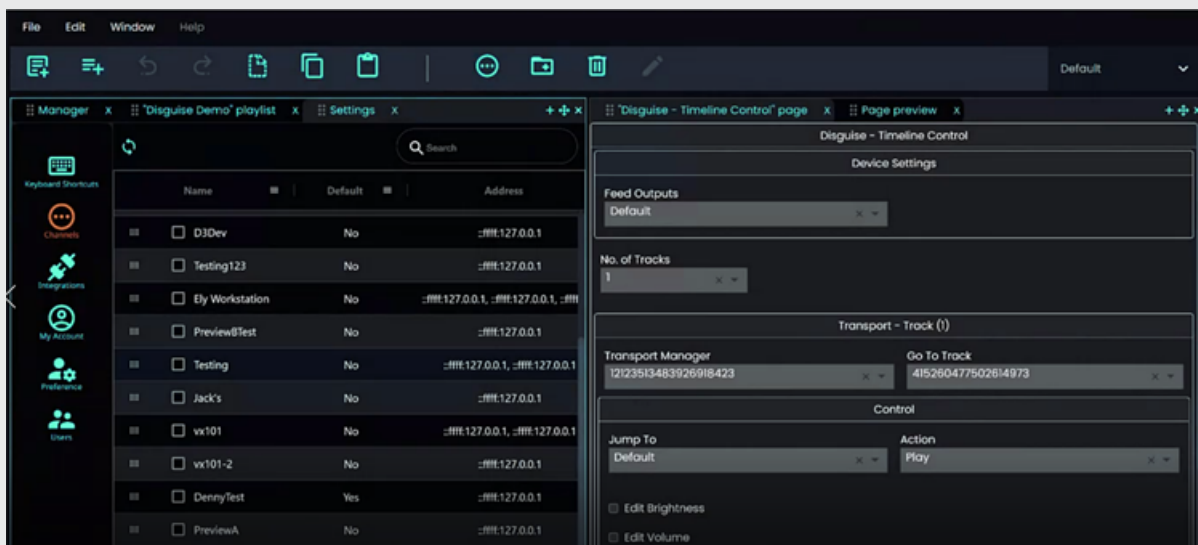



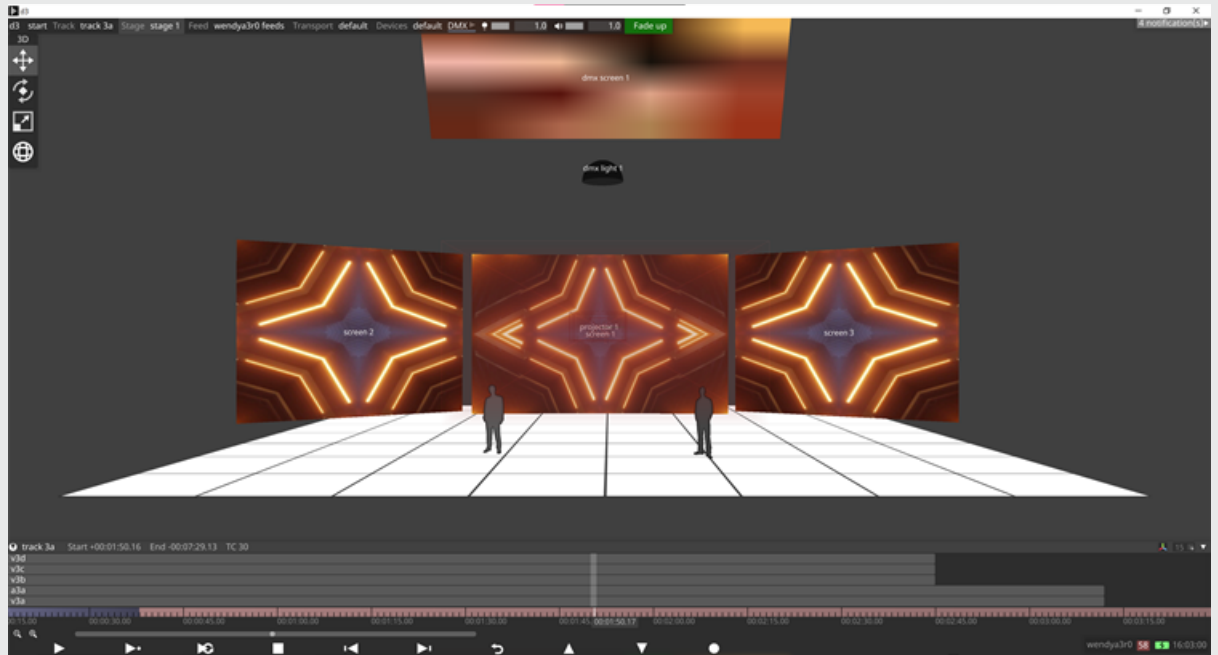

Designer is currently limited in Porta to:

- Timeline controls
- Indirections
- Animation sequences

As new APIs are released, more functionality will become available.

# Troubleshooting

## Help Menu

For support and documentation see the **Help** menu.

## Support Contact Form

If you have any issues with Porta that you are unable to resolve contact [support](#).

# Porta 2.1 Overview

## Porta 2.1

Porta is a cloud-native control system for broadcast that easily controls all show graphics and live content, as well as LEDs, tracking systems, tickers and scorebugs – all from a single interface that can be used by multiple operators simultaneously.

The Porta 2.1 News Room Computer System (NRCS) integration through MOS (Media Object Server) protocol connects with feeds from NBC, TUDN and TV Globo. With this new NRCS integration, Porta 2.1 users can control real-time graphics more intuitively through enhanced data sharing. Easy template creation tools mean graphics from the newsroom can be made without the help of a designer, and without Unreal Engine experience. Both in-house and remote teams can also take advantage of precise scheduling features. Manual tasks can be automated with macros. Porta allows the live previewing of Unreal Engine content using Pixel Streaming and remote control tools.



Porta 2.1 is also fully compatible with disguise's xR solutions, which can display realistic 8K content onto an LED set. Initially designed to help newsrooms, these tools and apps are perfect for virtual production studios providing full use of the Newsroom's system and scripts.

- MOS Gateway
- NewsRoom plugin
- Still Preview
- Scheduler
- Page Coloring
- Google APIs

# Porta 2.2 Overview

## Porta 2.2 Overview

New features and functionalities in Porta 2.2 include the following changes:

- **Native compatibility with Unreal 5.3**

Unreal Engine users can work with the Porta and the Unreal Motion Graphics BETA, previously known as 'Project Avalanche'. You can start creating graphics now in the Beta version.

- **Improved integration with Designer**

Users can fine-tune broadcast graphics with Designer while keeping everything running efficiently from the cloud-based control system.

- **Remote scheduler & media manager and remote monitoring**

Porta 2.2 has new workflows for transferring, scheduling and playing out media content. This is the first iteration of an ongoing improvement.

- **UI Improvements**

Further improvements to the UI have also been implemented.

- **Access via iPad**

Porta 2.2 browser access is now available for iPad, providing users with greater freedom while running the control system.

# px & px+

## Introduction to the px and px+

Engineered to power Unreal Engine vanilla graphics, the px and px+ are our high-performance render machines that work seamlessly with Porta to provide you with the assurance of best-in-class support and maintenance from disguise.



Find full technical specifications and diagrams below:

[px specification sheet](#)

[px+ specification sheet](#)

Find the px product page [here](#).

# Scheduling events

A Schedule is useful for long-term running or permanent installations. It allows you to schedule track change events that occur regularly over long periods of times (days, weeks or even months).

Please note: the Scheduler is merely a device for switching tracks based on the specified time. It is not a mechanism for powering down hardware or quitting Disguise software. It is possible to schedule a time for Disguise software to exit and close using the Scheduled Exit feature. For more information please see the [Running/ quitting](#) sub-chapter.

## How the Scheduler works

The scheduler behaves in the following manner:

1. the scheduler will go **down** the list of events to see what to do
2. the scheduler will keep going down the list until it finds an active event
3. as soon as it finds an event that is active it will switch to it
4. repeat from above

To move the events up/down the scheduler list, simply drag and drop them

# Create a schedule

1. Left-click the **schedule** property in the Transport Editor. This will open the **Schedules manager** which contains a list of all of the schedules available.
2. Type the name of the new Schedule into the **new schedule** text field.

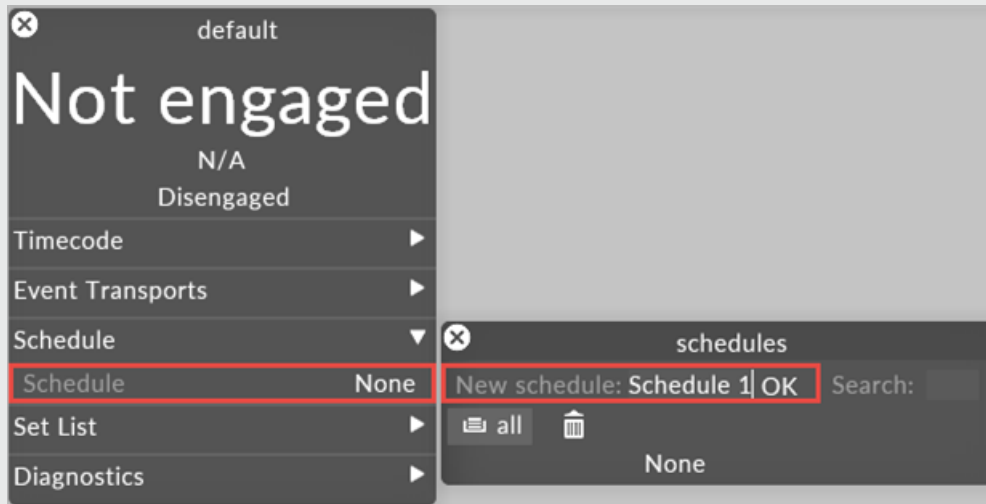

3. Hit **Enter**. This will create the new schedule, add it to the Schedules manager, and open the Schedule manager. The Schedule manager consists of an ordered list of **events**.

Events are also referred to as **schedule items**. A schedule item specifies a track trigger event. For example, a schedule item can say: trigger track X for Z seconds every Z seconds, between the hours of A and B and on dates C to D.



# Schedule manager properties

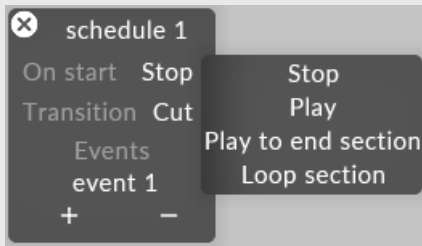

Interface of the Schedule manager

## On start

Specifies what type of playmode to be triggered when tracks are being triggered.

## Transition

Specifies the transition between tracks.

## Cut

Transitions the tracks with a hard cut.

## Fade

Transitions the tracks via fade to black.

## Events

Ordered list of all scheduleitems.

## Add a schedule item to the Schedule

1. Left-click **+**. This will open the **scheduleitems** manager which contains a list of all of the schedule items.

2. Type the scheduleitem name into the **new scheduleitem** text field, in this example the event **morning**.
3. Hit **Enter**. This will add the schedule item to the schedule menu and open the Scheduleitem editor.

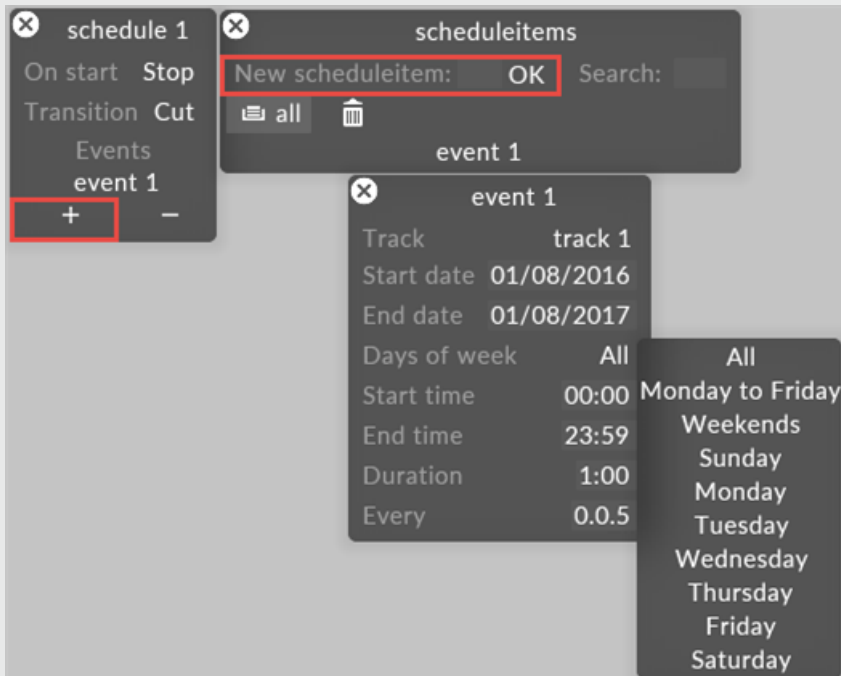

As an example, the Schedule object called **schedule 2** has been edited to contain one event called **morning**. Morning will be active for five minutes every hour, starting at 9am and ending at 4pm, between the 1st of November and the 15th of December, all days of the week.



**Warning:** Please ensure the Start time is earlier than the End time when scheduling events. If an event is running past midnight, please schedule it to stop at 23:59 and add a second event to start at 00:00.

# Schedule item properties

## Track

Specifies the track that will be triggered.

## Start date, end date

Specifies the dates on which the event will be active. The format must be dd/mm/yyyy.

## Days of week

Specifies if the scheduled item should be applied on **all** days, **weekdays** only, or **weekends** only.

## Start time/end time

Specifies the time range during the day that the event will be active. The format must be hh:mm.

## Duration

Specifies how long the event will be active when it is triggered. The format must be hh:mm.

## Every

Specifies the repeat cycle duration for the event. The format must be hh:mm.

If the Schedule contains more than one event, the first active event in the list will be triggered. This allows you to add highpriority events (such as a particular track played on the hour) that override other events.

Copyright 2024 Disguise. All rights reserved.

Information in this document is subject to change without notice. The software described in this document is furnished under a license agreement or nondisclosure agreement. The software may be used or copied only in accordance with the terms of those agreements. No part of this publication may be reproduced, stored in a retrieval system, or transmitted in any form or any means electronic or mechanical, including photocopying and recording for any purpose other than the purchaser's personal use without the written permission of Disguise.

Disguise

London HQ, 88-89 Blackfriars Road, London SE18HA

London, SE18HA

# Index

## 1

10 bit 1893

10bit 1893

## 2

2.5 2272

2.5D 2633

2x2plus 2272

## 3

3D model 355, 2790

3D object 355, 2790

3D object transform 2756

## 4

4K 2113, 2213

4x2 2272

4x4pro 2126, 2272, 2411

## A

aces 315

ACES 315

Adapter 1666

Adding Media 241

air filters 2593, 2601

Alembic 272

Alpha 2782

Analyzer 1754

API 1622, 1624  
aR 2786  
archive media 256  
Art-Net 927, 1758, 2983  
Assignment 218  
Audio 1626, 1662, 1754, 2227  
augmented 2786  
Automation 1715, 1717  
Autosaving 134  
Avolites 1925-1926, 2989-2990  
Axes 1717

## **B**

Backup 134  
Bookmark 162

## **C**

Calendar 3288  
Calibration 645, 651, 737, 2668, 2923  
Camera 162  
Camera Switching 2651  
Camera Tracking 1715, 2651  
CameraPlate 835, 842  
Chamsys 1925-1926, 2989-2990  
Checkpoint 138  
Child 258, 510  
Clarity 1925-1926, 2989-2990  
Classroom 1700  
Cluster 1018, 2696, 2698, 2705  
Cluster Assigner 2705  
Cluster Pool 2705

cluster rendering 1018, 2693, 2696, 2698

color 315

colour 315

Colour calibration 297, 2655

Colour Management 297

Colour Picker 305

Content 235

Control 1066, 1765

CPU 2609, 2628

Cylindrical 835, 842

## **D**

d3 manager 125

d3net 1669

d3Net 1666

d3State 193

DDC 2774

Delay 2677

delete media 256

Designer 74

destination 835, 842

Devices 1713

Direct 835, 842

display port 2113, 2213

DMX 1560, 1563, 1587, 1758, 1765, 2889, 2983, 3001, 3024, 3033

DVI matrix 1828

DVI matrix 1828

## **E**

EDID 2120, 2219, 2581, 2584

Education 1700

Effects 1115  
Element 1925-1926, 1971, 2989-2990  
Eos 1925-1926, 2989-2990  
ETC 1925-1926, 1971, 2989-2990  
EVO 2889, 3033  
EX 3 2258, 2267  
Exact 835, 842  
Exposed Parameter 2760  
Expressions 1843

## **F**

fabric 2523, 2525  
failover 1809  
Failover 2722  
Feed map 835, 842  
Feed Rectangle 1856, 1859  
Feed Scene 1859  
FFS 2120, 2219, 2584  
File Format 174  
Footprint 721  
Footprints 721  
Format 174  
Four Finger Salute 2120, 2219, 2584  
Framedrop 2609, 2628  
Frustum 2720

## **G**

GPU 2609, 2628  
GrandMA 1925-1926, 2989-2990  
Graph 2609, 2611, 2628  
gx 2037-2038



gx 2 2495, 2498

gx 2c 2071-2072

gx 2c Performance 2073

gx 3 2090, 2095

## **H**

hard drive 2130, 2141

hardware 2037-2038

Hardware 2105, 2233

HDR 1893

Hierarchy 258, 510

Histogram 324

History 134

Hog 1925-1926, 2989-2990

Hotkey 165, 218

## **I**

Indirection 1597

Indirections 1597

Ingestion 245

Ion 1925-1926, 1971, 2989-2990

IP-VFC 2540

IP VFC 2567

IPVFC 2540, 2567

## **J**

JSON 1769

## **K**

Keyboard 165

Keyframe 1511, 1516

Keyframe Editor 1511

Keyframing 1511

## **L**

Label 819

Layer Stack 910

Legacy 2272

Level Loading 2767

level sequencing 2762

Levels 2767

Licenses 70

Lighting 2889, 3033

Lightware 1826

LSC 1925-1926, 2989-2990

LUT 328

## **M**

Machine 1765

maintenance 2593, 2601

Management 2105, 2233

Map 835, 842

Mapping 831, 833, 835, 842

matrix 1809

Matrix 1826

MDC 1095

Media 245

media drive 2130, 2141

mellanox 2523, 2525

Mesh Mapping 2643

MGMT 2105, 2233

Missing media 247

Monitoring 2611

MRset 693  
Multi-edit 905  
Multi-layer 905  
Multi-user editing 2772  
Multi User 2772  
Multichannel 835, 842  
Multichannelmap 2705  
MultiLayer 905  
MultiLayerEditor 905

## **N**

ndi 1831  
NDI 1831  
Network 125, 1666  
Network Interface 1666  
Network Interface Card 1666  
newtek 1831  
Newtek 1831  
nic 1683  
NIC 1666  
Notch 2731  
Notes 819

## **O**

obj 355, 2790  
Object 220  
Observation 2659  
OLED 2105, 2233  
OmniCal 772, 787, 791, 795, 2955, 2970, 2974, 2978  
Optimization 2782  
Options 193

OSC 930, 1102, 1560, 1563, 1587, 1780, 3001, 3024

overview 61

## **P**

Parent 258, 510

Pelt 408, 2857

Performance 2095, 2411, 2498, 2609, 2628

Perspective 835, 842

plus 2037-2038

Port 1666

Position 162

Position Receiver 1715

Post Process 2782

power 2113, 2213

Previsualisation 1480

Pro 2037-2038, 2126

products 2037-2038

project 2752

Projector calibration 645, 651, 737, 2923

## **Q**

Quick Select 218

QuickCal 645, 651, 737, 2923

## **R**

r25 84, 102

Radial 835, 842

RAID 2462

redisguise 2267

Redisguise 2133, 2144, 2246, 2363, 2392, 2419, 2478, 2505

Region 835, 842

reimage 2267

image

re-image

factory

restore 2066, 2101, 2163, 2210, 2348

Reimage 2133, 2144, 2246, 2363, 2392, 2419, 2478, 2505

Remora 2105, 2233

Remote parameters 2766

Remote texture 2756, 2766

Remote textures 2764

Remove media 247

renderstream 2752, 2774

Renderstream 2750-2751, 2756, 2766-2767, 2782

RenderStream 1018, 2696, 2698, 2705, 2720, 2722, 2731, 2747, 2760, 2762, 2764, 2772

Reprojection 2686

Requirements 62

Reset EDID 2120, 2219, 2584

restore 2113, 2213, 2267

Restore 2133, 2144, 2246, 2363, 2392, 2419, 2478, 2505

rx 2242

rx II 2242

## **S**

sACN 927, 1758, 2983

Scene 2767

Scene Selector 2767

Schedule 3288

School 1700

server 2037-2038

Set Extension 2665

setup 2752

Shortcuts 165  
Shot Recorder 2645  
SingleLargeCanvas 518  
SLC 518  
Slot 218  
SMC 2105, 2233  
Sockpuppet 927, 930, 1560, 1563, 1587, 3001, 3024  
source 835, 842  
Spatial 835, 842, 2668, 2677  
Spherical 835, 842  
Splices 2705  
Splitting Strategy 2782  
SSD 2130, 2141  
storage 2130, 2141  
System 62, 2105, 2233

## **T**

Telnet 1828  
TelnetDVIMatrix 1828  
Template 118  
Text 1473  
text integration 1042  
Text parameter 2766  
Texture Sharing 2764  
time control 2762  
Toggle 1516  
Touch Designer 2747  
TouchDesigner 2747  
Track 808  
Tracker 2677  
Tracking Marker 1477

Tracking Source 220

TrackingMarker 1477

Transform 311

Transport 804

Transport controls 804

## **U**

University 1700

unreal 2752, 2774

Unreal 2750-2751, 2756, 2760, 2762, 2764, 2766-2767, 2772, 2782

update 2267

Update 2133, 2144, 2246

UVLookup 1316

## **V**

Vectorscope 331

Versioning 235

VFC 2528, 2540, 2569, 2571, 2575

Video input 2131, 2142, 2186

virtual production 2650, 2659, 2665, 2683, 2693

virtual zoom 2686

vx 2126

vx 1 2130-2131

vx 2 2141-2142

vx 4 2186

vx 4+ 2193, 2195, 2208

vx range 2113, 2213

vx4 2105, 2233

## **W**

Warp 619

Waveform 335

web 1042

What 84, 102

Wholehog 1925-1926, 2989-2990

Workload 2705

## **X**

xR 693, 2650-2651, 2655, 2659, 2665, 2668, 2677, 2683, 2686, 2693