

# PRODUCT DATA SHEET

**Product Description:** Universal application, non-handed door closer with an aluminum finish. Door closer is ANSI A156.3 Grade 1 certified and UL 10C fire rated. Product has a cast aluminum body. Adjustable power size 1-4 that requires less than 5 lbs of force to open. Standard features include: sweep and latching speeds and adjustable backcheck. Tri-packed for regular arm, top jamb and parallel arm application. 10 year limited warranty. ADA compliant. Ships with mounting hardware.

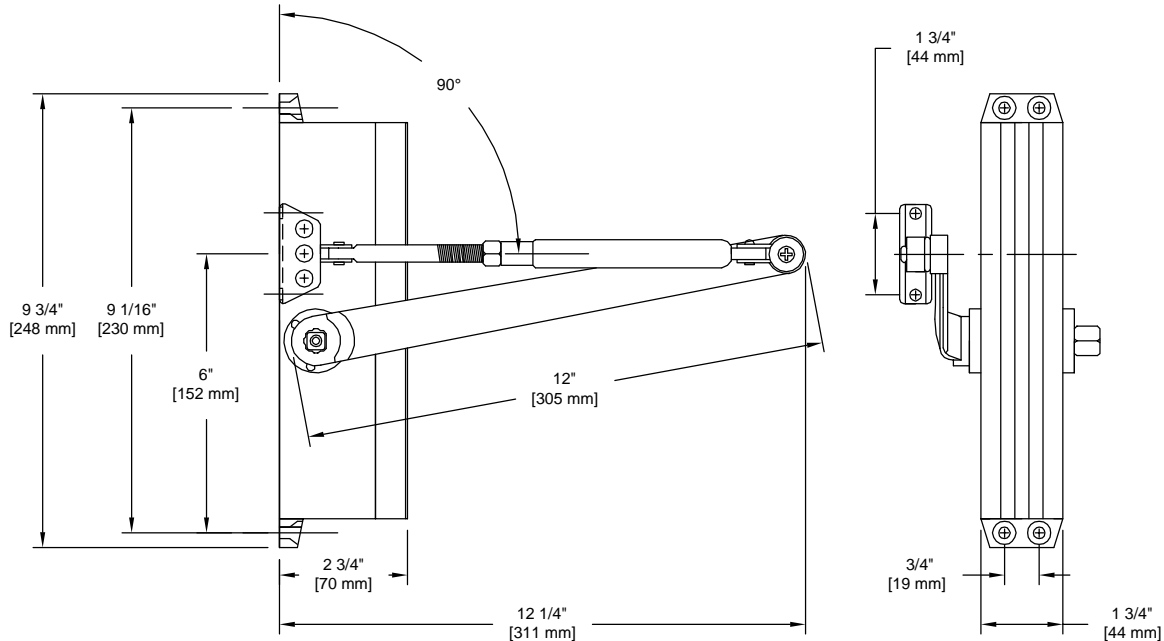

Regular & Top Jamb				Parallel Arm			Applicable Door Weight lbs (kg)
Maximum Size of Door							
Closer Size	Interior	Exterior Inswing	Exterior Outswinging	Closer Size	Interior	Exterior Outswinging	
1	28" (0.71 m)			1			33-66 (15-30)
2	36" (0.91 m)			2	30" (0.76 m)		66-99 (30-45)
3	42" (1.07 m)	30" (0.76 m)	36" (0.91 m)	3	36" (0.91 m)	30" (0.76 m)	99-143 (45-65)
4	48" (1.22 m)	36" (0.91 m)	42" (1.07 m)	4	42" (1.07 m)	36" (0.91 m)	143-187 (65-85)

**Overall Size:** 9 3/4" W X 1 3/4" H X 12 1/4" D

**Material:** Cast Aluminum

**Finish:** Aluminum

### Cross Reference

Manufacturer	Part Number	Manufacturer	Part Number	Manufacturer	Part Number
Global	TC200	Sargent	1130	Jackson	S395
LCN	1071-1075	Yale	51(BF)	Sentinel	S50
Norton	1601 (BF)	Arrow	1000 (BF)	Taco	N-TP200
Dorma	641/651	Cal-Royal	300/700	CRL.	PR40
Dor-O-Matic	SC61	International	650/680		

Description:

**Door Closer Kit,  
Universal, UL 10C, ANSI  
Grade 1, Spring 1-4**

Part Number:

**DC8900AL**

Date

09/16

Rev.

05

Sheet 1 of 1

