

PRODUCT DATA SHEET

Product Description: Entry set, ANSI Grade 3. Set includes passage pull with thumb latch, interior left lever. Pull fabricated from die cast zinc with a US11P venetian bronze finish. Ships with mounting hardware. Lock ships with mortise latch. Optional drive in latch (product #87396 and #87394) and UL10C fire rated latch (product #87375 and #87372) available.

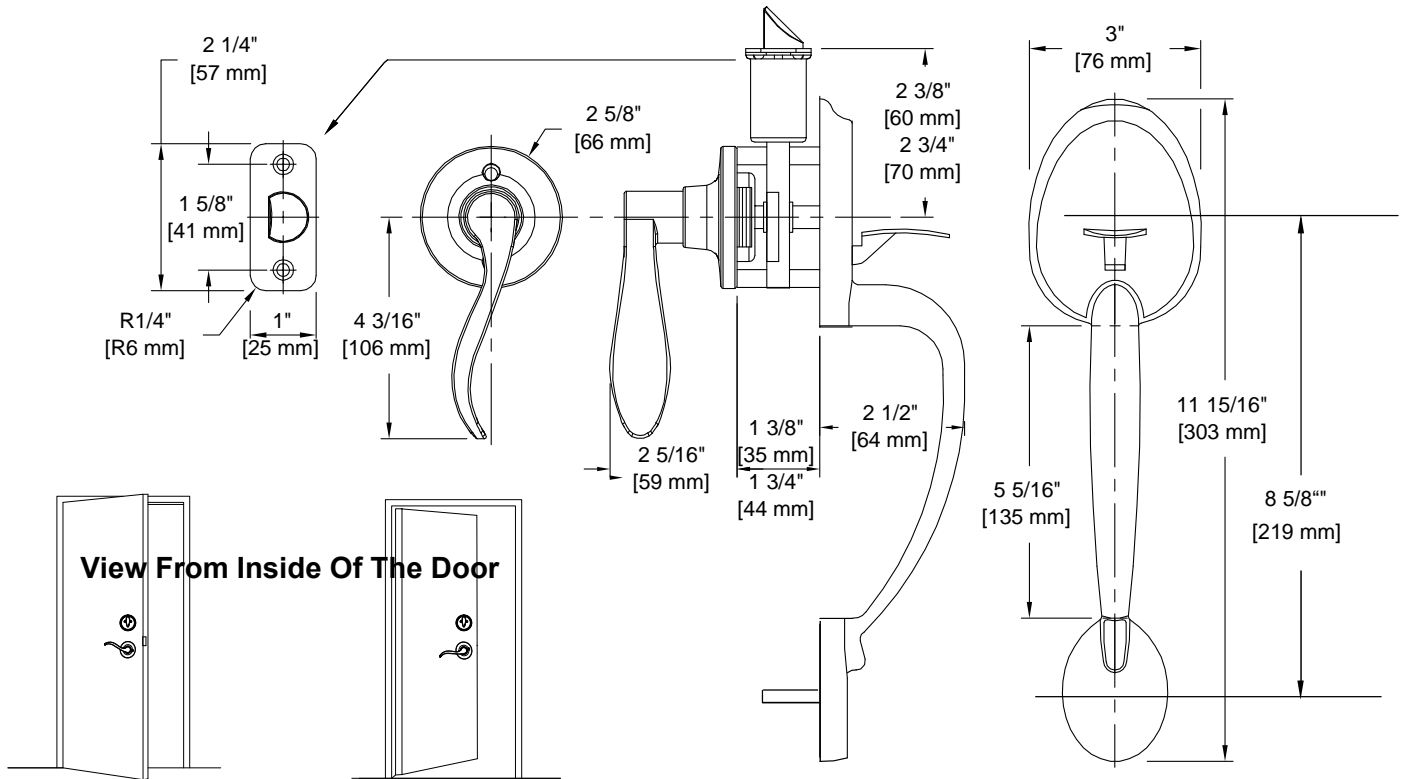

Door Prep: Cross Bore 2 1/8+, Edge Bore 1+, Mortise Latch Face 1" x 2 1/4", Optional Drive In Latch 1" Diameter Drilled Hole

Latches: Ships With Mortise Latch As Shown Above, Optional Drive In Or UL10C Fire Rated Latches Available

Backset: Adjustable Latch to 2 3/8+ or 2 3/4+

Door Thickness: Fit all 1 3/8" - 1 3/4" Standard Doors

Cylinder: Brass with Nickel Plated Brass Keys and 5 Pin Tumbler Kwikset KW1 Keyway

Strike Plate: 2 1/4" Full Lip Strike **Bolt:** 1/2" Throw

REKEY OPTIONAL



Overall Size: 3" W X 11 15/16" H X 2 1/2" D

Material: Die Cast Zinc

Finish: US11P Venetian Bronze

Cross Reference

Manufacturer	Part Number



Description:

Dakota Entry Set with Interior Left Lever, KW1, ANSI Grade 3

Part Number:

87369

Date

09/16

Rev.

03

Sheet 1 of 1