

PRODUCT DATA SHEET

Product Description: Stainless steel grab bar. 18"+grab bar with 1 1/2"+diameter tube. Fabricated from 18-gauge, type 304 grade stainless steel with a US32D brushed stainless steel finish. Welded, type 304 stainless steel mounting flanges. ADA compliant and designed to support loads in excess of 250 lbs when properly installed. Ships with mounting hardware.

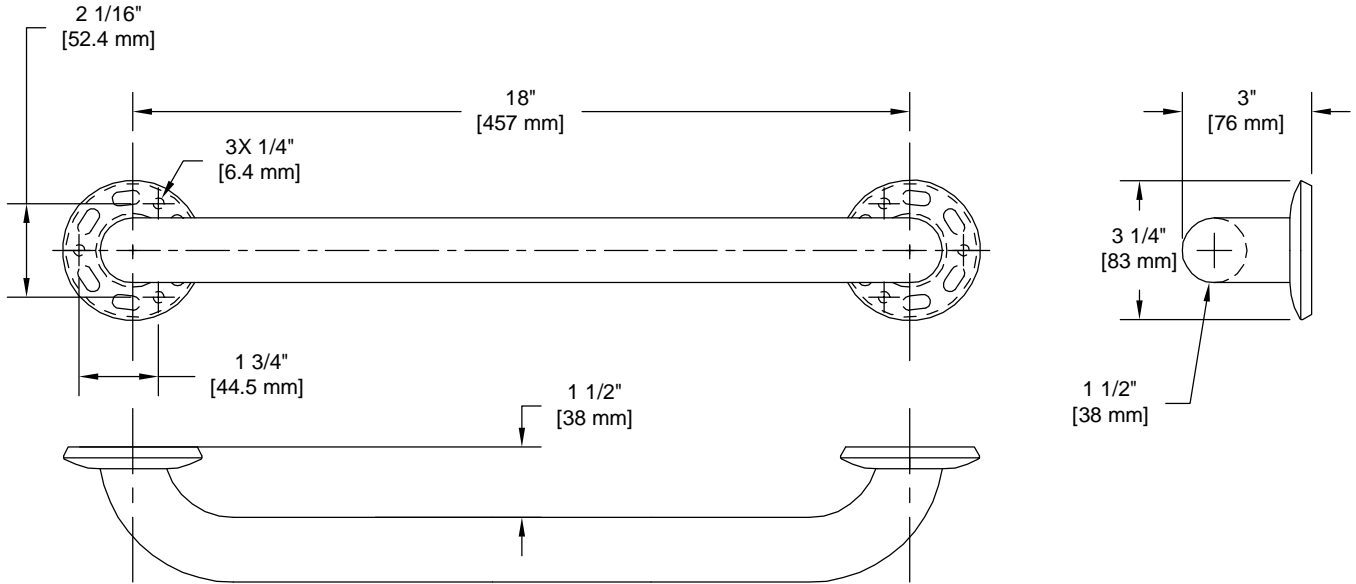

WITH MOUNTING
HARDWARE

ADA

304 STAINLESS

Overall Size: 21 1/4" W X 3 1/4" H X 3" D

Material: 304 Grade Stainless Steel

Finish: US32D Brushed Stainless Steel

Cross Reference

Manufacturer	Part Number
Bobrick	B-6806x18



Description:
Grab Bar, 18" Concealed Screw

Part Number: 71761	Date 09/16	Rev. 06
Sheet 1 of 1		