



VITREOUS CHINA

TOILET
21-500

LAVATORIES

TOILETS

BIDETS / URINALS

CAST IRON

VIPER™ Round Front Toilet

10" Rough-in



Features:

- Low Consumption 1.6 gpf (6.0 Lpf)
- Round Front Bowl
- Slim Line Tank
- Fluidmaster® Fill Valve HP-2 Technology
- Optional Right-handed Trip Lever Available
- Glazed Trapway
- Reverse Trap
- Dual Feed Jet
- Front Tank Lever
- Various Colors
- 2 Bolt Caps



Dimensions:

- Height28 9/16"
- Width18 3/4"
- Depth26 1/4"
- Rough-in10"
- Water Surface from Rim5 1/4"
- Trapway (min).....2"
- Water Surface 10" x 8"
- Water Seal2 3/4"
- Shipping Weight82 lbs

Specifications: Bowl—#21-552 Round Front
Seat not included

Tank—#28-595

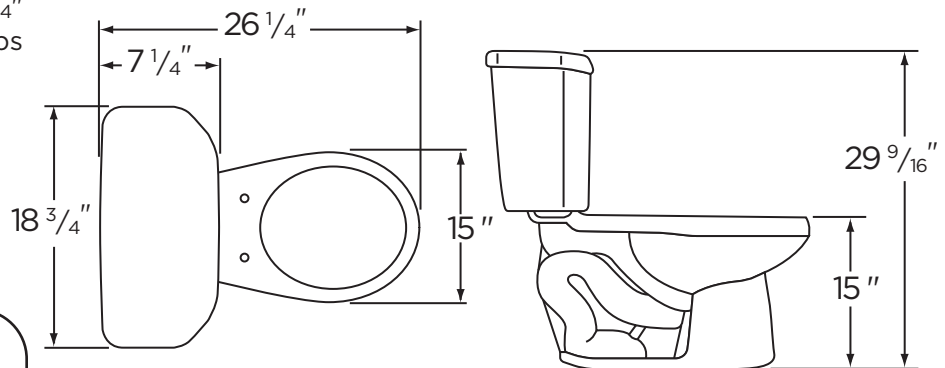

THIS FIXTURE QUALIFIES ACCORDING TO ASME TEST PROCEDURES AS A LOW CONSUMPTION WATER CLOSET WITH AN AVERAGE CONSUMPTION OF 1.6 GAL. OR LESS.



www.gerberonline.com

Job Name	
Date	
Model Specified	
Quantity	
Customer	
Contractor	
Architect/engineer	



1.6 gpf (6 Lpf) LOW CONSUMPTION VIPER™ TOILET

21-500
Round Front, 10" Rough-in
(Bowl 21-552 with Tank 28-595)

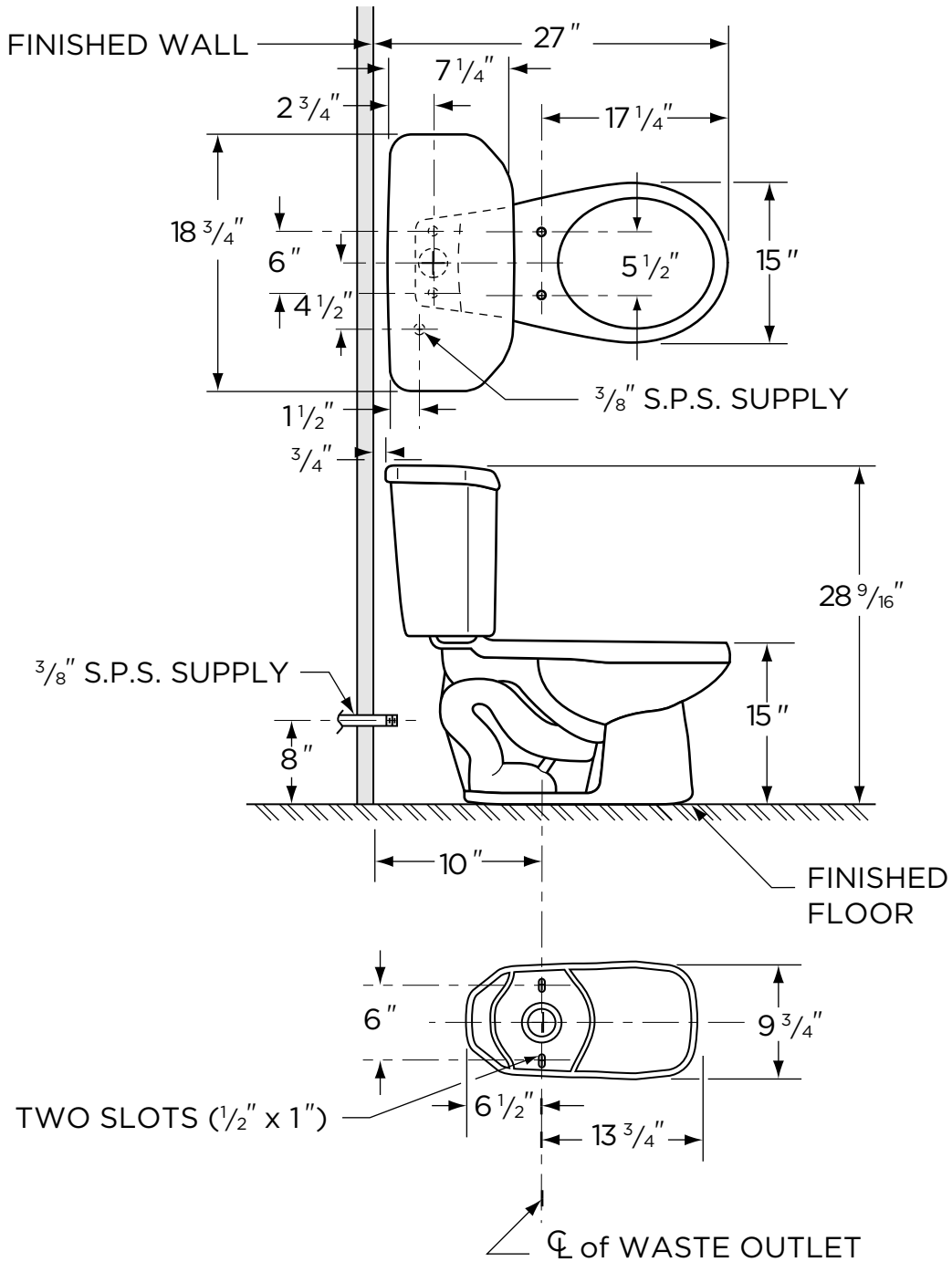

NOTES:
All dimensions are in inches.

Illustrations may not be drawn to scale.

IMPORTANT:

Dimensions of fixtures are nominal and may vary within the range of tolerances established by ASME Standard A 112.19.2.

THIS FIXTURE QUALIFIES ACCORDING TO ASME TEST PROCEDURES AS A LOW CONSUMPTION WATER CLOSET WITH AN AVERAGE CONSUMPTION OF 1.6 gpf (6 Lpf) OR LESS.