

GV-ABL2702 2MP H.265 Low Lux WDR Pro IR Bullet IP Camera



- 1/2.8" progressive scan low lux CMOS sensor
- Min. illumination at 0.002 lux
- Triple streams from H.265, H.264 or MJPEG
- Up to 30 fps at 1920 x 1080
- Intelligent IR
- IR distance up to 50 m (165 ft)
- Day and night function (with removable IR-cut filter)
- Ingress protection (IP67)
- Vandal Resistant (IK10 for metal casing)
- Built-in micro SD card slot (SD / SDHC / SDXC / UHS-I, Class 10) for local storage
- Two-way audio
- DC 12V / PoE (IEEE 802.3af)
- Wide Dynamic Range Pro (WDR Pro)
- Defog
- 3D noise reduction
- Motion detection
- Tampering Alarm
- Text overlay
- Privacy mask
- ONVIF (Profile G, S, T) conformant

Introduction

The Bullet IP Camera is an outdoor, fixed, network camera equipped with an automatic IR-cut filter and 3 IR LEDs for day and night surveillance. The camera supports H.265 video codec to achieve better compression ratio while maintaining high quality pictures at reduced network bandwidths. With Wide Dynamic Range Pro (WDR Pro), it can process scenes with contrasting intensities of light and produce clear image. The camera adheres to IK10 and IP67 standards and can be powered through PoE.

Active Tampering Alarm

Tampered



Focus Change

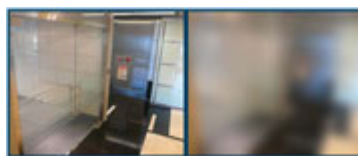

Camera Shift

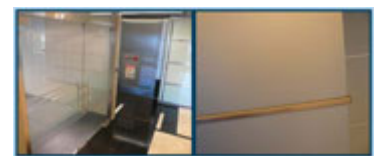

Dimensions

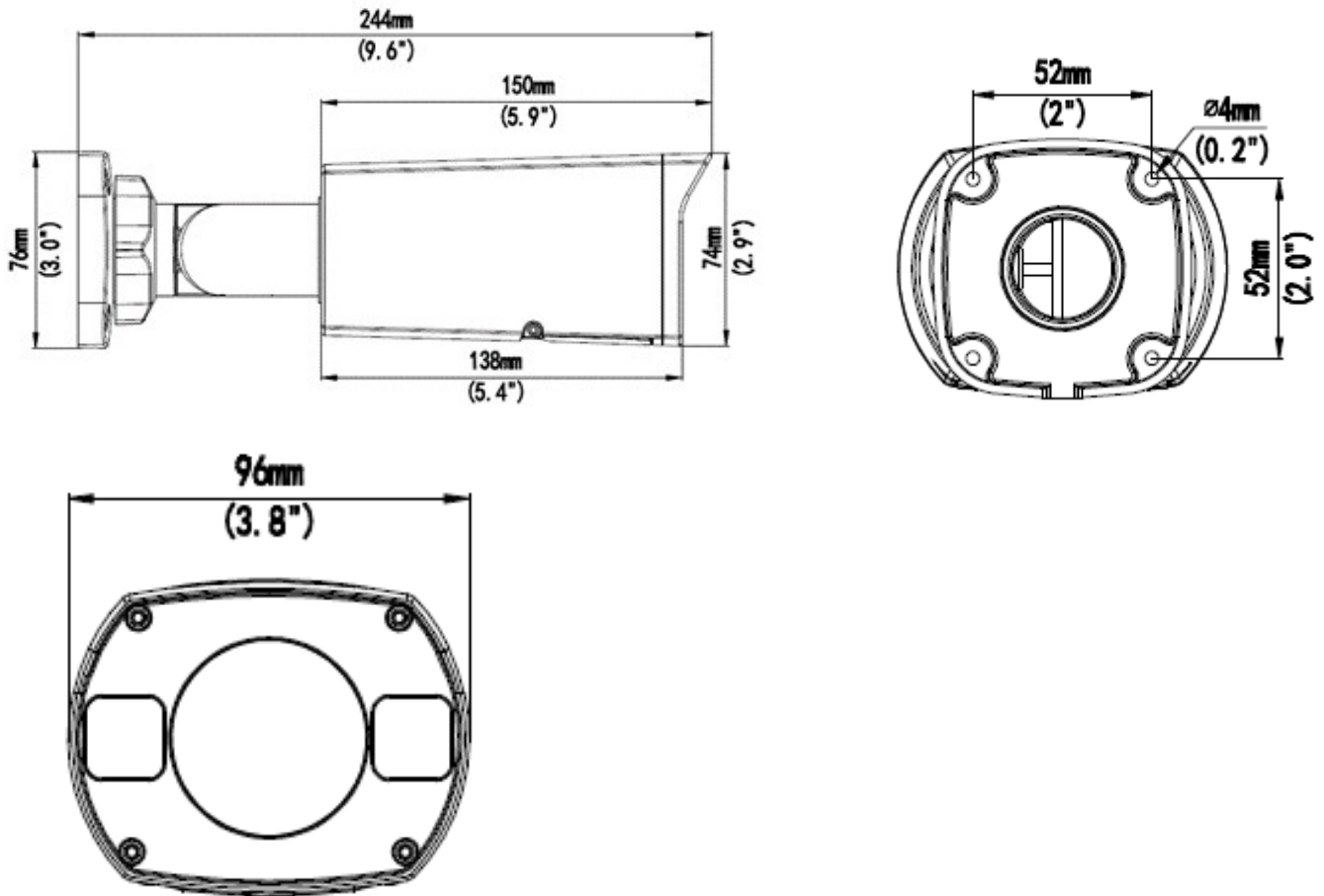

Specifications

Camera		
Image Sensor	1/2.8" progressive scan low lux CMOS	
Picture Elements	1920 (H) x 1080 (V)	
Minimum Illumination	Color	0.002 Lux (F1.6, AGC ON)
	IR ON	0 Lux
Shutter Speed	Auto / Manual (1/6 ~ 1/100000 sec)	
White Balance	Auto / Manual	
Gain Control	Auto / Manual	
S/N Ratio	52 dB	
WDR Pro	Yes	
Dynamic Range	Up to 120 dB	
Lens		
Megapixel	Yes	
Day / Night	Yes (with removable IR-cut filter)	
Lens Type	Varifocal lens	
Focal Length	2.8 ~ 12 mm	
Maximum Aperture	F/1.6	
Mount	Ø14 mm	
Horizontal FOV	92° ~ 34°	
Operation	Focus	Manual (with lock)
	Zoom	Manual (with lock)
	Iris	Fixed
IR LED Quantity	3 IR LED	
Max. IR Distance	50 m (165 ft)	
Operation		
Video Compression	H.265, H.264, MJPEG	

Video Streaming		Triple streams
Video Resolution	Main Stream	1920 x 1080 (Default)
	Sub Stream	1280 x 720, 720 x 576, 704 x 288, 640 x 360 (Default), 352 x 288
	Third Stream (Closed by Default)	720 x 576, 704 x 288, 640 x 360, 352 x 288
Frame Rate		30 fps at 1920 x 1080 (60 / 50 Hz) * The frame rate and performance may vary depending on the number of connections and data bitrates (different scenes).
Video Analytics		Motion Detection, Tampering Alarm, Audio Detection, Cross Line, Intrusion, Object Moving, Object Left, Defocus, Scene Change, Face Detection, People Counting *Tampering alarm, audio detection, cross line, intrusion, object moving, object left, defocus, scene change, face detection and people counting are only accessible through the camera's Web interface, which can be used to trigger alerts such as e-mail and FTP
Image Setting		Brightness, Contrast, Saturation, Sharpness, 3D Noise reduction, Image Orientation, Exposure Mode, Shutter Speed, Gain Control, Slow Shutter, Backlight Compensation (BLC), Metering Control, D/N Sensitivity, WDR, Smart Illumination, White Balance, Defog
Audio Compression		G.711
Audio Support		Two-way Audio (external microphone and speaker required)
Digital I/O	Input	1 Input, dry contact, NO / NC
	Output	1 Relay Output (1A 30V DC / 0.3A 125V AC)
Network		
Interface		10/100 Ethernet
Protocol		802.1x, ARP, DHCP, DDNS, DNS, DynDNS, FTP, HTTP, HTTPS, ICMP, IGMP, IPv4, NTP, PPPoE, QoS, RTCP, RTP, RTSP, SMTP, SNMP, TCP, UDP, UPnP, ONVIF (Profile G, S, T)
Mechanical		
Camera Angle Adjustment	Pan	0°~360°
	Tilt	0°~120°
	Rotate	0°~360°
Connectors	Power	DC Jack (DC 12V, 1A), PoE (IEEE802.3af)
	Ethernet	RJ-45 connector
	Audio	1 in (Audio In Wire); 1 out (Audio Out Wire) *The Audio In port only support microphones with power supply.
	Digital I/O	4-pin terminal block pitch 3.5 mm (0.14")
	Local Storage	Micro SD card slot (SD / SDHC / SDXC / UHS-I, Class 10) *UHS-II card type is not supported.
General		
Operating Temperature		-35°C ~ 60°C (-22°F ~ 140°F)
Humidity		0% to 95% (no condensation)
Power Source		12 V DC / PoE (IEEE802.3af)
Max. Power Consumption		9 W
Dimensions		244 × 96 × 74 mm (9.6" × 3.8" × 2.9")
Weight		0.58 kg (1.28 lb)
Ingress Protection		IP67
Vandal Resistance		IK10 for metal casing
Regulatory		FCC, UL, CE, RoHS compliant
Web Interface		
Installation Management		Web-based configuration
Maintenance		Firmware upgrade through Web Browser or Utility
Access from Web Browser		Live View, Video Recording, Change Video Quality, Bandwidth Control, Image Snapshot, Defog, Tampering Alarm, Text Overlay, Image Masking
Language		Czech, English, French, German, Hungarian, Italian, Japanese, Polish, Portuguese, Russian, Spanish, Traditional Chinese
Applications		
Software Supported		GV-DVR / NVR (V8.7.4.0), GV-VMS (V17.1), GV-Control Center (V3.5.0.0), GV-Edge Recording Manager (V1.3.0.0), GV-Recording Server / Video Gateway (V1.4.0.0), GV-Redundant / Failover Server (V1.1.0.0)
Smart Device Access		GV-Eye for iOS and Android
Live Viewing		Browser (IE, Edge, Chrome, Firefox, Safari), Mobile App





Note:

1. It is required to apply patch files to all the supported software.
2. Do not use clothes or any ordinary material to clean the camera cover since they may result in scratches.
3. Specifications are subject to change without notice.

Packing List

- | | |
|--|---|
| <ol style="list-style-type: none"> 1. IR Bullet IP Camera 2. Waterproof Rubber Set 3. Screw Kit | <ol style="list-style-type: none"> 4. Drill Template Paster 5. Download Guide 6. Warranty Card |
|--|---|

Accessories

Model No.	Name		Details
GV-Mount300-2	Convex Corner Mount		Dimensions: 137 x 233 x 160 mm (5.4" x 9.17" x 6.3") Weight: 1.65 kg (3.64 lb)
GV-Mount310-2	Concave Corner Mount		Dimensions: 111.2 x 369.9 x 210 mm (2.6" x 11.4" x 6.6") Weight: 1.65 kg (3.64 lb)
GV-Mount503	Wall Mount Bracket		Dimensions: 125 x 125 x 55 mm (4.9" x 4.9" x 2.2") Weight: 0.74 kg (1.63 lb)
GV-Mount420 (must be used with GV-Mount503)	Pole Mount Bracket		Dimensions: Ø 120 x 120 x 53.4 mm (4.7" x 4.7" x 2.1") Weight: 0.45 kg (0.99 lb) Steel Strap Diameter: Ø 67 ~ 127 mm (Ø 2.6" ~ 5")
GV-PA191	Power over Ethernet (PoE) Adapter		The GV-PA191 is a Power over Ethernet (PoE) adapter designed to provide power to the IP device through a single Ethernet cable.
GV-POE Switch	The GV-POE Switch is designed to provide power along with network connection for IP devices. The GV-POE Switch is available in various models with different numbers and types of ports.		
Power Adapter	Contact our sales representatives for the countries and areas supported.		