



STAINLESS STEEL  
**WORK TABLES**  
**SPEC-LINE Series - Flat Top - UNDERSHELF Style**



**Item #:** \_\_\_\_\_ **Qty #:** \_\_\_\_\_  
**Model #:** \_\_\_\_\_  
**Project #:** \_\_\_\_\_



No-Drip **DIE FORMED** EDGE offers the Ultimate in Design & Function.



Featuring as Standard: **"THE PROVEN"** ORIGINAL ADVANCE TABCO **Adjustable Undershelf with Die Cast Leg Clamp**

**FEATURES:**

Top is furnished with a 2" x 1" square die embossed NO-DRIP countertop edge with a 1/2" return on 4 sides.  
 To reinforce and maintain a level working surface, 24" wide tables are supplied with TWO hat channels and 30" and 36" wide tables are supplied with THREE hat channels.  
 Pre-engineered welded angle adapters insure ease of future drawer installation.

Aluminum die cast "leg-to-shelf" clamp secures shelf to leg eliminating unsightly nuts & bolts. Undershelf is adjustable.

**CONSTRUCTION:**

All TIG welded. Exposed weld areas polished to match adjacent surfaces.  
 Entire top mechanically polished to a satin finish. Countertop edge polished to a MIRROR finish.  
 Top is sound deadened.  
 Roll formed embossed galvanized hat channels are secured to top by means of structural adhesive and weld studs.  
 Gussets welded to support hat sections.

**MATERIAL:**

**VSS-SERIES: Stainless Steel Legs & Undershelf**  
**TOP:** 14 gauge stainless steel type "304" series.  
**SHELF:** 18 gauge stainless steel.  
**LEGS:** 1 5/8" diameter tubular stainless steel.  
 1" adjustable stainless steel bullet feet.  
 Stainless steel gussets.

**VLG-SERIES: Galvanized Legs & Undershelf**  
**TOP:** 14 gauge stainless steel type "304" series.  
**SHELF:** 18 gauge galvanized steel.  
**LEGS:** 1 5/8" diameter tubular galvanized steel.  
 1" adjustable plastic bullet feet.  
 Galvanized steel gussets.

**VSS-Series:**  
**Stainless Steel Legs & Undershelf**

L	24" Wide	30" Wide	36" Wide
30"	VSS-240	VSS-300	
24"	VSS-242	VSS-302	
36"	VSS-243	VSS-303	VSS-363
48"	VSS-244	VSS-304	VSS-364
60"	VSS-245	VSS-305	VSS-365
72"	VSS-246	VSS-306	VSS-366
84"	VSS-247	VSS-307	VSS-367
96"	VSS-248	VSS-308	VSS-368
108"	VSS-249	VSS-309	VSS-369
120"	VSS-2410	VSS-3010	VSS-3610
132"	VSS-2411	VSS-3011	VSS-3611
144"	VSS-2412	VSS-3012	VSS-3612



**VLG-Series:**  
**Galvanized Steel Legs & Undershelf**

L	24" Wide	30" Wide	36" Wide
30"	VLG-240	VLG-300	
24"	VLG-242	VLG-302	
36"	VLG-243	VLG-303	VLG-363
48"	VLG-244	VLG-304	VLG-364
60"	VLG-245	VLG-305	VLG-365
72"	VLG-246	VLG-306	VLG-366
84"	VLG-247	VLG-307	VLG-367
96"	VLG-248	VLG-308	VLG-368
108"	VLG-249	VLG-309	VLG-369
120"	VLG-2410	VLG-3010	VLG-3610
132"	VLG-2411	VLG-3011	VLG-3611
144"	VLG-2412	VLG-3012	VLG-3612

**Create Your Own Efficient Workstation with the Available Standard Accessories (Visit Section K)**



**NEW YORK**  
 (800) 645-3166  
 Fax: (631) 242-6900

**GEORGIA**  
 (800) 832-1218  
 Fax: (770) 775-5625

**TEXAS**  
 (800) 527-0353  
 Fax: (972) 932-4795

**NEVADA**  
 (800) 446-8684  
 Fax: (775) 972-1578

For Assistance with Smart Modifications & Accessories Call: **1-800-498-6634** Fax: 631-586-2933  
 smartfab@advancetabco.com

# DIMENSIONS and SPECIFICATIONS

ALL DIMENSIONS ARE TYPICAL TOL ± .500"

All Units Shipped Unassembled (KD) for Reduced Shipping Costs.

## VSS & VLG Series UNDERSHELF Style FLAT TOP

Finished size of undershelf = Length minus 5 3/4"  
Width minus 5 3/4"

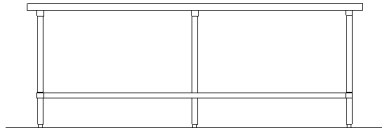

Units 8 ft. and larger are furnished with six (6) legs

### COUNTERTOP EDGE DETAIL

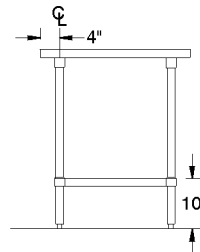
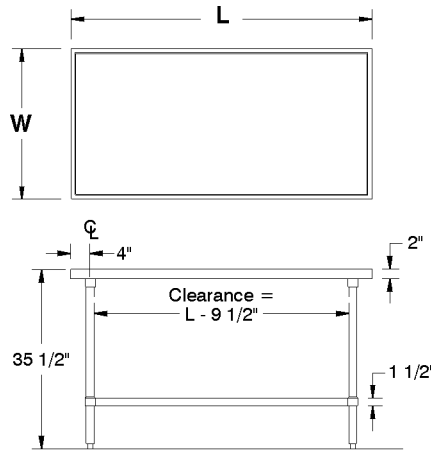
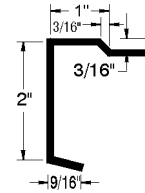

### VSS-Series: Stainless Steel Legs & Undershelf

L	24" Wide	Wt.	30" Wide	Wt.	36" Wide	Wt.
30"	VSS-240	49 lbs.	VSS-300	65 lbs.		
24"	VSS-242	31 lbs.	VSS-302	55 lbs.		
36"	VSS-243	64 lbs.	VSS-303	72 lbs.	VSS-363	88 lbs.
48"	VSS-244	79 lbs.	VSS-304	89 lbs.	VSS-364	98 lbs.
60"	VSS-245	92 lbs.	VSS-305	107 lbs.	VSS-365	118 lbs.
72"	VSS-246	109 lbs.	VSS-306	125 lbs.	VSS-366	138 lbs.
84"	VSS-247	130 lbs.	VSS-307	148 lbs.	VSS-367	164 lbs.
96"	VSS-248	145 lbs.	VSS-308	166 lbs.	VSS-368	184 lbs.
108"	VSS-249	161 lbs.	VSS-309	176 lbs.	VSS-369	190 lbs.
120"	VSS-2410	261 lbs.	VSS-3010	287 lbs.	VSS-3610	308 lbs.
132"	VSS-2411	293 lbs.	VSS-3011	324 lbs.	VSS-3611	358 lbs.
144"	VSS-2412	308 lbs.	VSS-3012	339 lbs.	VSS-3612	373 lbs.

### VLG-Series: Galvanized Steel Legs & Undershelf

L	24" Wide	Wt.	30" Wide	Wt.	36" Wide	Wt.
30"	VLG-240	49 lbs.	VLG-300	65 lbs.		
24"	VLG-242	31 lbs.	VLG-302	55 lbs.		
36"	VLG-243	64 lbs.	VLG-303	72 lbs.	VLG-363	88 lbs.
48"	VLG-244	79 lbs.	VLG-304	89 lbs.	VLG-364	98 lbs.
60"	VLG-245	92 lbs.	VLG-305	107 lbs.	VLG-365	118 lbs.
72"	VLG-246	109 lbs.	VLG-306	125 lbs.	VLG-366	138 lbs.
84"	VLG-247	130 lbs.	VLG-307	148 lbs.	VLG-367	164 lbs.
96"	VLG-248	145 lbs.	VLG-308	166 lbs.	VLG-368	184 lbs.
108"	VLG-249	161 lbs.	VLG-309	176 lbs.	VLG-369	190 lbs.
120"	VLG-2410	261 lbs.	VLG-3010	287 lbs.	VLG-3610	308 lbs.
132"	VLG-2411	293 lbs.	VLG-3011	324 lbs.	VLG-3611	358 lbs.
144"	VLG-2412	308 lbs.	VLG-3012	339 lbs.	VLG-3612	373 lbs.





STAINLESS STEEL  
**WORK TABLES**  
 PREMIUM Series - Flat Top - UNDERSHELF Style



**Item #:** \_\_\_\_\_ **Qty #:** \_\_\_\_\_  
**Model #:** \_\_\_\_\_  
**Project #:** \_\_\_\_\_

**FEATURES:**

Top is furnished with 1-5/8" sanitary rolled rim edges on front & back and square side edges.

To reinforce and maintain a level working surface, 24" wide tables are supplied with TWO hat channels and 30" and 36" wide tables are supplied with THREE hat channels.

Pre-engineered welded angle adapters insure ease of future drawer installation.

Aluminum die cast "leg-to-shelf" clamp secures shelf to leg eliminating unsightly nuts & bolts. Undershelf is adjustable.

**CONSTRUCTION:**

All TIG welded. Exposed weld areas polished to match adjacent surfaces.

Entire top mechanically polished to a satin finish.

Top is sound deadened.

Roll formed embossed galvanized hat channels are secured to top by means of structural adhesive and weld studs.

Gussets welded to support hat sections.



**NEW**  
 Rolled Rim Edges on  
 Front & Back and  
 Square Side Edges



Featuring as Standard:  
**"THE PROVEN"**  
 ORIGINAL ADVANCE TABCO  
**Adjustable Undershelf**  
 with Die Cast Leg Clamp

**MATERIAL:**

**SS-SERIES: Stainless Steel Legs & Undershelf**

**TOP:** 14 gauge stainless steel type "304" series.

**SHELF:** 18 gauge stainless steel.

**LEGS:** 1 5/8" diameter tubular stainless steel.  
 1" adjustable stainless steel bullet feet.  
 Stainless steel gussets.

**GLG-SERIES: Galvanized Legs & Undershelf**

**TOP:** 14 gauge stainless steel type "304" series.

**SHELF:** 18 gauge galvanized steel.

**LEGS:** 1 5/8" diameter tubular galvanized steel.  
 1" adjustable plastic bullet feet.  
 Galvanized steel gussets.

**SS-Series:**  
**Stainless Steel Legs & Undershelf**

L	24" Wide	30" Wide	36" Wide
30"	SS-240	SS-300	
24"	SS-242	SS-302	
36"	SS-243	SS-303	SS-363
48"	SS-244	SS-304	SS-364
60"	SS-245	SS-305	SS-365
72"	SS-246	SS-306	SS-366
84"	SS-247	SS-307	SS-367
96"	SS-248	SS-308	SS-368
108"	SS-249	SS-309	SS-369
120"	SS-2410	SS-3010	SS-3610
132"	SS-2411	SS-3011	SS-3611
144"	SS-2412	SS-3012	SS-3612

**GLG-Series:**  
**Galvanized Steel Legs & Undershelf**

L	24" Wide	30" Wide	36" Wide
30"	GLG-240	GLG-300	
24"	GLG-242	GLG-302	
36"	GLG-243	GLG-303	GLG-363
48"	GLG-244	GLG-304	GLG-364
60"	GLG-245	GLG-305	GLG-365
72"	GLG-246	GLG-306	GLG-366
84"	GLG-247	GLG-307	GLG-367
96"	GLG-248	GLG-308	GLG-368
108"	GLG-249	GLG-309	GLG-369
120"	GLG-2410	GLG-3010	GLG-3610
132"	GLG-2411	GLG-3011	GLG-3611
144"	GLG-2412	GLG-3012	GLG-3612



Create Your Own Efficient Workstation with the Available Standard Accessories (Visit Section K)



**NEW YORK**  
 (800) 645-3166  
 Fax: (631) 242-6900

**GEORGIA**  
 (800) 832-1218  
 Fax: (770) 775-5625

**TEXAS**  
 (800) 527-0353  
 Fax: (972) 932-4795

**NEVADA**  
 (800) 446-8684  
 Fax: (775) 972-1578

For Assistance with Smart Modifications & Accessories Call: **1-800-498-6634** Fax: 631-586-2933  
 smartfab@advancetabco.com

# DIMENSIONS and SPECIFICATIONS

ALL DIMENSIONS ARE TYPICAL TOL ± .500"

All Units Shipped Unassembled (KD) for Reduced Shipping Costs.

## SS & GLG Series Undershelf Style FLAT TOP

Finished size of undershelf = Length minus 5 3/4"  
Width minus 5 3/4"

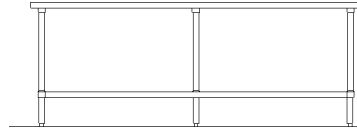

Units 8 ft. and larger are furnished with six (6) legs

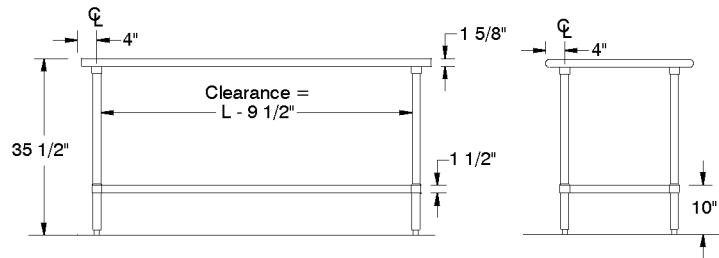
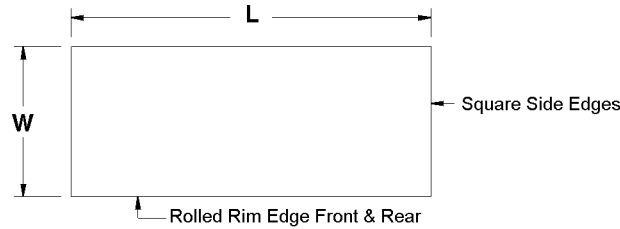

### SS-Series: Stainless Steel Legs & Undershelf

L	24" Wide	Wt.	30" Wide	Wt.	36" Wide	Wt.
30"	SS-240	49 lbs.	SS-300	65 lbs.		
24"	SS-242	31 lbs.	SS-302	55 lbs.		
36"	SS-243	64 lbs.	SS-303	72 lbs.	SS-363	88 lbs.
48"	SS-244	79 lbs.	SS-304	89 lbs.	SS-364	98 lbs.
60"	SS-245	92 lbs.	SS-305	107 lbs.	SS-365	118 lbs.
72"	SS-246	109 lbs.	SS-306	125 lbs.	SS-366	138 lbs.
84"	SS-247	130 lbs.	SS-307	148 lbs.	SS-367	164 lbs.
96"	SS-248	145 lbs.	SS-308	166 lbs.	SS-368	184 lbs.
108"	SS-249	161 lbs.	SS-309	176 lbs.	SS-369	190 lbs.
120"	SS-2410	261 lbs.	SS-3010	287 lbs.	SS-3610	308 lbs.
132"	SS-2411	293 lbs.	SS-3011	324 lbs.	SS-3611	358 lbs.
144"	SS-2412	308 lbs.	SS-3012	339 lbs.	SS-3612	373 lbs.

### GLG-Series: Galvanized Steel Legs & Undershelf

L	24" Wide	Wt.	30" Wide	Wt.	36" Wide	Wt.
30"	GLG-240	49 lbs.	GLG-300	65 lbs.		
24"	GLG-242	31 lbs.	GLG-302	55 lbs.		
36"	GLG-243	64 lbs.	GLG-303	72 lbs.	GLG-363	88 lbs.
48"	GLG-244	79 lbs.	GLG-304	89 lbs.	GLG-364	98 lbs.
60"	GLG-245	92 lbs.	GLG-305	107 lbs.	GLG-365	118 lbs.
72"	GLG-246	109 lbs.	GLG-306	125 lbs.	GLG-366	138 lbs.
84"	GLG-247	130 lbs.	GLG-307	148 lbs.	GLG-367	164 lbs.
96"	GLG-248	145 lbs.	GLG-308	166 lbs.	GLG-368	184 lbs.
108"	GLG-249	161 lbs.	GLG-309	176 lbs.	GLG-369	190 lbs.
120"	GLG-2410	261 lbs.	GLG-3010	287 lbs.	GLG-3610	308 lbs.
132"	GLG-2411	293 lbs.	GLG-3011	324 lbs.	GLG-3611	358 lbs.
144"	GLG-2412	308 lbs.	GLG-3012	339 lbs.	GLG-3612	373 lbs.





STAINLESS STEEL  
**WORK TABLES**  
 STANDARD Series - Flat Top - UNDERSHELF Style



Item #: \_\_\_\_\_ Qty #: \_\_\_\_\_  
 Model #: \_\_\_\_\_  
 Project #: \_\_\_\_\_

**FEATURES:**

Top is furnished with 1-5/8" sanitary rolled rim edges on front & back and square side edges.

To reinforce and maintain a level working surface, 24" wide tables are supplied with TWO hat channels and 30" and 36" wide tables are supplied with THREE hat channels.

Pre-engineered welded angle adapters insure ease of future drawer installation.

Aluminum die cast "leg-to-shelf" clamp secures shelf to leg eliminating unsightly nuts & bolts. Undershelf is adjustable.

**CONSTRUCTION:**

All TIG welded. Exposed weld areas polished to match adjacent surfaces.

Entire top mechanically polished to a satin finish.

Top is sound deadened.

Roll formed embossed galvanized hat channels are secured to top by means of structural adhesive and weld studs.

Gussets welded to support hat sections.



**NEW**  
 Rolled Rim Edges on  
 Front & Back and  
 Square Side Edges



Featuring as Standard:  
**"THE PROVEN"**  
 ORIGINAL ADVANCE TABCO  
**Adjustable Undershelf  
 with Die Cast Leg Clamp**

**MATERIAL:**

**MS-SERIES: Stainless Steel Legs & Undershelf**

**TOP:** 16 gauge stainless steel type "304" series.

**SHELF:** 18 gauge stainless steel.

**LEGS:** 1 5/8" diameter tubular stainless steel.  
 1" adjustable stainless steel bullet feet.  
 Stainless steel gussets.

**MG-SERIES: Galvanized Legs & Undershelf**

**TOP:** 16 gauge stainless steel type "304" series.

**SHELF:** 18 gauge galvanized steel.

**LEGS:** 1 5/8" diameter tubular galvanized steel.  
 1" adjustable plastic feet.  
 Galvanized steel gussets.

**MS-Series:**

**Stainless Steel Legs & Undershelf**

L	24" Wide	30" Wide	36" Wide
30"	MS-240	MS-300	
24"	MS-242	MS-302	
36"	MS-243	MS-303	MS-363
48"	MS-244	MS-304	MS-364
60"	MS-245	MS-305	MS-365
72"	MS-246	MS-306	MS-366
84"	MS-247	MS-307	MS-367
96"	MS-248	MS-308	MS-368
108"	MS-249	MS-309	MS-369
120"	MS-2410	MS-3010	MS-3610
132"	MS-2411	MS-3011	MS-3611
144"	MS-2412	MS-3012	MS-3612



**MG-Series:**

**Galvanized Steel Legs & Undershelf**

L	24" Wide	30" Wide	36" Wide
30"	MG-240	MG-300	
24"	MG-242	MG-302	
36"	MG-243	MG-303	MG-363
48"	MG-244	MG-304	MG-364
60"	MG-245	MG-305	MG-365
72"	MG-246	MG-306	MG-366
84"	MG-247	MG-307	MG-367
96"	MG-248	MG-308	MG-368
108"	MG-249	MG-309	MG-369
120"	MG-2410	MG-3010	MG-3610
132"	MG-2411	MG-3011	MG-3611
144"	MG-2412	MG-3012	MG-3612

Create Your Own Efficient Workstation with the Available Standard Accessories (Visit Section K)



**NEW YORK**  
 (800) 645-3166  
 Fax: (631) 242-6900

**GEORGIA**  
 (800) 832-1218  
 Fax: (770) 775-5625

**TEXAS**  
 (800) 527-0353  
 Fax: (972) 932-4795

**NEVADA**  
 (800) 446-8684  
 Fax: (775) 972-1578

For Assistance with  
 Smart Modifications & Accessories Call: >>>

1-800-498-6634 Fax: 631-586-2933  
 smartfab@advancetabco.com

# DIMENSIONS and SPECIFICATIONS

ALL DIMENSIONS ARE TYPICAL TOL ± .500"

All Units Shipped Unassembled (KD) for Reduced Shipping Costs.

## MS & MG Series UNDERSHELF Style FLAT TOP

Finished size of undershelf = Length minus 5 3/4"  
Width minus 5 3/4"

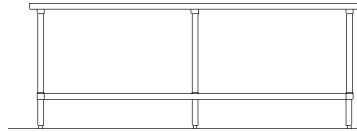

Units 8 ft. and larger are furnished with six (6) legs

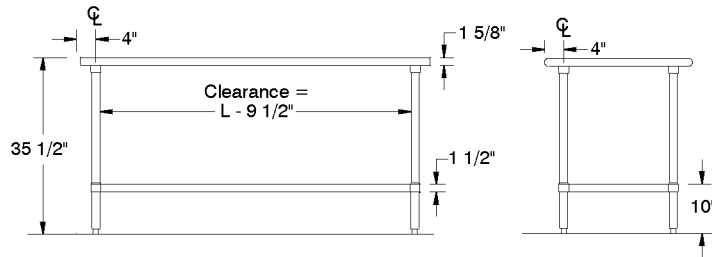
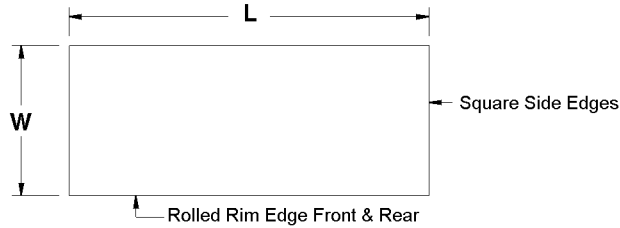

### MS-Series: Stainless Steel Legs & Undershelf

L	24" Wide	Wt.	30" Wide	Wt.	36" Wide	Wt.
30"	MS-240	49 lbs.	MS-300	65 lbs.		
24"	MS-242	31 lbs.	MS-302	55 lbs.		
36"	MS-243	64 lbs.	MS-303	72 lbs.	MS-363	88 lbs.
48"	MS-244	79 lbs.	MS-304	89 lbs.	MS-364	98 lbs.
60"	MS-245	92 lbs.	MS-305	107 lbs.	MS-365	118 lbs.
72"	MS-246	109 lbs.	MS-306	125 lbs.	MS-366	138 lbs.
84"	MS-247	130 lbs.	MS-307	148 lbs.	MS-367	164 lbs.
96"	MS-248	145 lbs.	MS-308	166 lbs.	MS-368	184 lbs.
108"	MS-249	161 lbs.	MS-309	176 lbs.	MS-369	190 lbs.
120"	MS-2410	261 lbs.	MS-3010	287 lbs.	MS-3610	308 lbs.
132"	MS-2411	293 lbs.	MS-3011	324 lbs.	MS-3611	358 lbs.
144"	MS-2412	308 lbs.	MS-3012	339 lbs.	MS-3612	373 lbs.

### MG-Series: Galvanized Steel Legs & Undershelf

L	24" Wide	Wt.	30" Wide	Wt.	36" Wide	Wt.
30"	MG-240	49 lbs.	MG-300	65 lbs.		
24"	MG-242	31 lbs.	MG-302	55 lbs.		
36"	MG-243	64 lbs.	MG-303	72 lbs.	MG-363	88 lbs.
48"	MG-244	79 lbs.	MG-304	89 lbs.	MG-364	98 lbs.
60"	MG-245	92 lbs.	MG-305	107 lbs.	MG-365	118 lbs.
72"	MG-246	109 lbs.	MG-306	125 lbs.	MG-366	138 lbs.
84"	MG-247	130 lbs.	MG-307	148 lbs.	MG-367	164 lbs.
96"	MG-248	145 lbs.	MG-308	166 lbs.	MG-368	184 lbs.
108"	MG-249	161 lbs.	MG-309	176 lbs.	MG-369	190 lbs.
120"	MG-2410	261 lbs.	MG-3010	287 lbs.	MG-3610	308 lbs.
132"	MG-2411	293 lbs.	MG-3011	324 lbs.	MG-3611	358 lbs.
144"	MG-2412	308 lbs.	MG-3012	339 lbs.	MG-3612	373 lbs.





STAINLESS STEEL  
**WORK TABLES**

**SUPER SAVER Series - Flat Top - UNDERSHELF Style**



Item #: \_\_\_\_\_ Qty #: \_\_\_\_\_  
 Model #: \_\_\_\_\_  
 Project #: \_\_\_\_\_

**FEATURES:**

Top is furnished with 1-5/8" sanitary rolled rim edges on front & back and square side edges.

To reinforce and maintain a level working surface, 24" wide tables are supplied with TWO hat channels and 30" and 36" wide tables are supplied with THREE hat channels.

Pre-engineered welded angle adapters insure ease of future drawer installation.

Aluminum die cast "leg-to-shelf" clamp secures shelf to leg eliminating unsightly nuts & bolts. Undershelf is adjustable.

**CONSTRUCTION:**

All TIG welded. Exposed weld areas polished to match adjacent surfaces.

Entire top mechanically polished to a satin finish.

Top is sound deadened.

Roll formed embossed galvanized hat channels are secured to top by means of structural adhesive and weld studs..

Gussets welded to support hat sections.



**NEW**  
Rolled Rim Edges on  
Front & Back and  
Square Side Edges

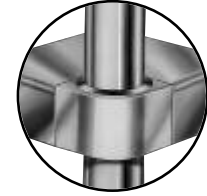

Featuring as Standard:  
**"THE PROVEN"**  
ORIGINAL ADVANCE TABCO  
**Adjustable Undershelf  
with Die Cast Leg Clamp**

**MATERIAL:**

**SAG-SERIES: Stainless Steel Legs & Undershelf**

**TOP:** 16 gauge stainless steel type "430" series.

**SHELF:** 18 gauge stainless steel.

**LEGS:** 1 5/8" diameter tubular stainless steel.  
1" adjustable **stainless steel** bullet feet.  
Stainless steel gussets.

**AG-SERIES: Galvanized Legs & Undershelf**

**TOP:** 16 gauge stainless steel type "430" series.

**SHELF:** 18 gauge galvanized steel.

**LEGS:** 1 5/8" diameter tubular galvanized steel.  
1" adjustable plastic bullet feet.  
Galvanized steel gussets.

**SAG-Series:  
Stainless Steel Legs & Undershelf**

L	24" Wide	30" Wide	36" Wide
30"	SAG-240	SAG-300	
24"	SAG-242	SAG-302	
36"	SAG-243	SAG-303	SAG-363
48"	SAG-244	SAG-304	SAG-364
60"	SAG-245	SAG-305	SAG-365
72"	SAG-246	SAG-306	SAG-366
84"	SAG-247	SAG-307	SAG-367
96"	SAG-248	SAG-308	SAG-368
108"	SAG-249	SAG-309	SAG-369
120"	SAG-2410	SAG-3010	SAG-3610
132"	SAG-2411	SAG-3011	SAG-3611
144"	SAG-2412	SAG-3012	SAG-3612



**AG-Series:  
Galvanized Steel Legs & Undershelf**

L	24" Wide	30" Wide	36" Wide
30"	AG-240	AG-300	
24"	AG-242	AG-302	
36"	AG-243	AG-303	AG-363
48"	AG-244	AG-304	AG-364
60"	AG-245	AG-305	AG-365
72"	AG-246	AG-306	AG-366
84"	AG-247	AG-307	AG-367
96"	AG-248	AG-308	AG-368
108"	AG-249	AG-309	AG-369
120"	AG-2410	AG-3010	AG-3610
132"	AG-2411	AG-3011	AG-3611
144"	AG-2412	AG-3012	AG-3612

**Create Your Own Efficient Workstation with the Available Standard Accessories (Visit Section K)**



**NEW YORK**  
(800) 645-3166  
Fax: (631) 242-6900

**GEORGIA**  
(800) 832-1218  
Fax: (770) 775-5625

**TEXAS**  
(800) 527-0353  
Fax: (972) 932-4795

**NEVADA**  
(800) 446-8684  
Fax: (775) 972-1578

For Assistance with Smart Modifications & Accessories Call: **1-800-498-6634** Fax: 631-586-2933  
 smartfab@advancetabco.com



# DIMENSIONS and SPECIFICATIONS

ALL DIMENSIONS ARE TYPICAL TOL ± .500"

All Units Shipped Unassembled (KD) for Reduced Shipping Costs.

## SAG & AG Series UNDERSHELF Style FLAT TOP

Finished size of undershelf = Length minus 5 3/4"  
Width minus 5 3/4"

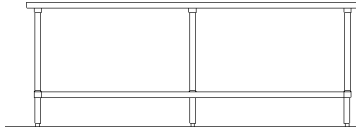

Units 8 ft. and larger are furnished with six (6) legs

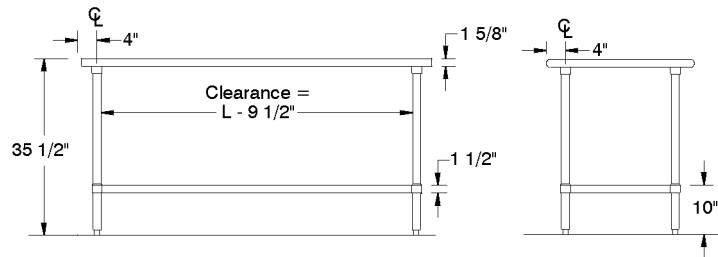
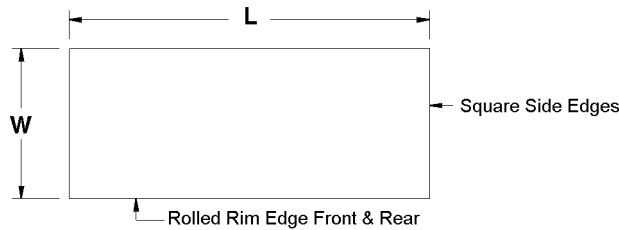

### SAG-Series: Stainless Steel Legs & Undershelf

L	24" Wide	Wt.	30" Wide	Wt.	36" Wide	Wt.
30"	SAG-240	49 lbs.	SAG-300	65 lbs.		
24"	SAG-242	31 lbs.	SAG-302	55 lbs.		
36"	SAG-243	64 lbs.	SAG-303	72 lbs.	SAG-363	88 lbs.
48"	SAG-244	79 lbs.	SAG-304	89 lbs.	SAG-364	98 lbs.
60"	SAG-245	92 lbs.	SAG-305	107 lbs.	SAG-365	118 lbs.
72"	SAG-246	109 lbs.	SAG-306	125 lbs.	SAG-366	138 lbs.
84"	SAG-247	130 lbs.	SAG-307	148 lbs.	SAG-367	164 lbs.
96"	SAG-248	145 lbs.	SAG-308	166 lbs.	SAG-368	184 lbs.
108"	SAG-249	161 lbs.	SAG-309	176 lbs.	SAG-369	190 lbs.
120"	SAG-2410	261 lbs.	SAG-3010	287 lbs.	SAG-3610	308 lbs.
132"	SAG-2411	293 lbs.	SAG-3011	324 lbs.	SAG-3611	358 lbs.
144"	SAG-2412	308 lbs.	SAG-3012	339 lbs.	SAG-3612	373 lbs.

### AG-Series: Galvanized Steel Legs & Undershelf

L	24" Wide	Wt.	30" Wide	Wt.	36" Wide	Wt.
30"	AG-240	49 lbs.	AG-300	65 lbs.		
24"	AG-242	31 lbs.	AG-302	55 lbs.		
36"	AG-243	64 lbs.	AG-303	72 lbs.	AG-363	88 lbs.
48"	AG-244	79 lbs.	AG-304	89 lbs.	AG-364	98 lbs.
60"	AG-245	92 lbs.	AG-305	107 lbs.	AG-365	118 lbs.
72"	AG-246	109 lbs.	AG-306	125 lbs.	AG-366	138 lbs.
84"	AG-247	130 lbs.	AG-307	148 lbs.	AG-367	164 lbs.
96"	AG-248	145 lbs.	AG-308	166 lbs.	AG-368	184 lbs.
108"	AG-249	161 lbs.	AG-309	176 lbs.	AG-369	190 lbs.
120"	AG-2410	261 lbs.	AG-3010	287 lbs.	AG-3610	308 lbs.
132"	AG-2411	293 lbs.	AG-3011	324 lbs.	AG-3611	358 lbs.
144"	AG-2412	308 lbs.	AG-3012	339 lbs.	AG-3612	373 lbs.

