

Parque Municipal
Guillermo Harnecker

TRUE NORTH 0 METERS 700



Field Papers



Untitled

<http://fieldpapers.org/atlas/5lo1ggls/A1>



Field Papers



Untitled

<http://fieldpapers.org/atlas/5lo1ggls/A2>



Field Papers

Untitled
<http://fieldpapers.org/atlas/5lo1ggl/A3>

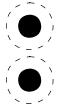
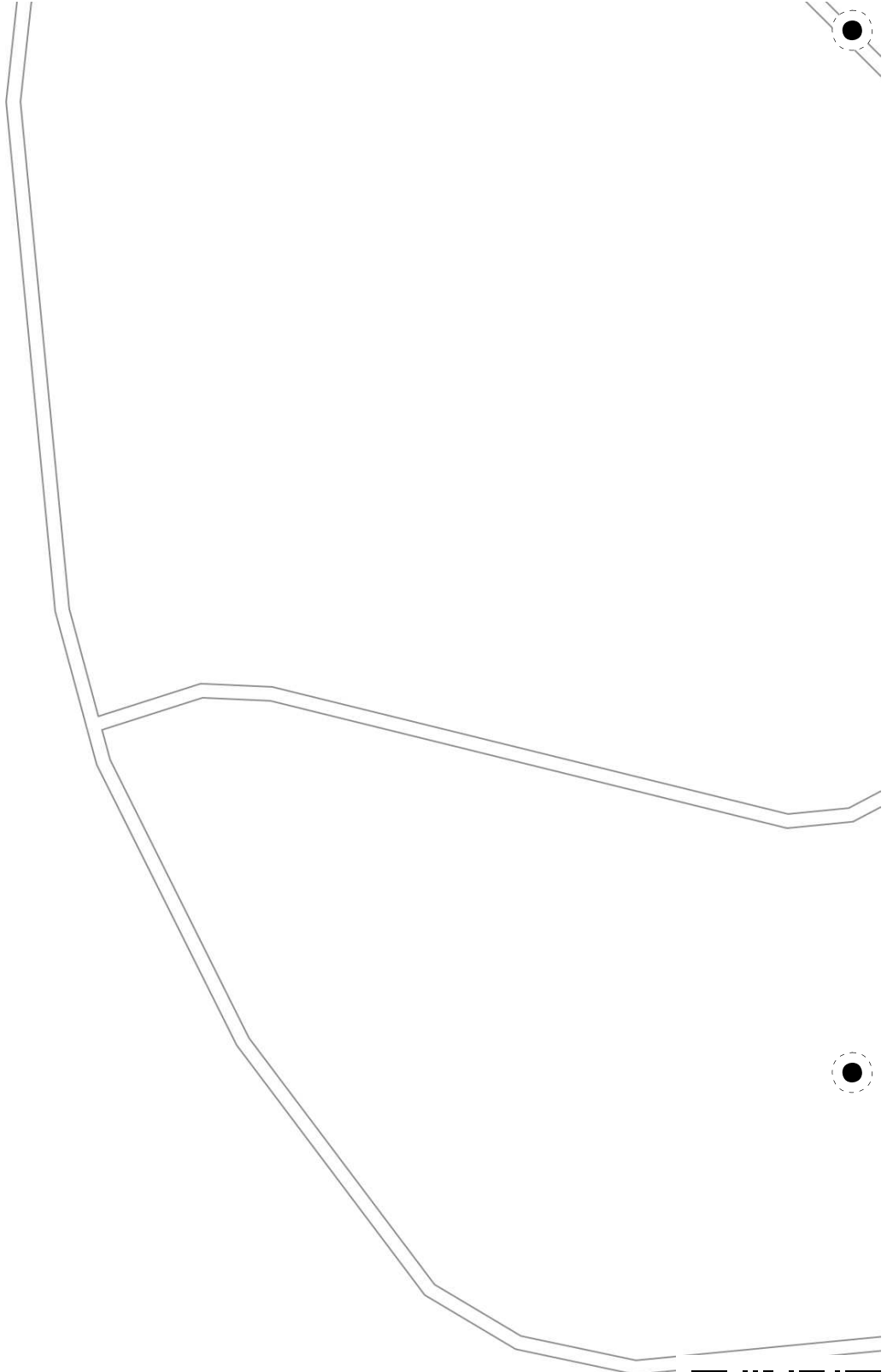

Field Papers

Untitled
<http://fieldpapers.org/atlas/5lo1ggl/A4>

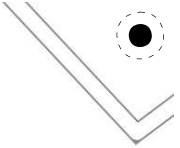

TRUE NORTH 0 METERS 100



Field Papers

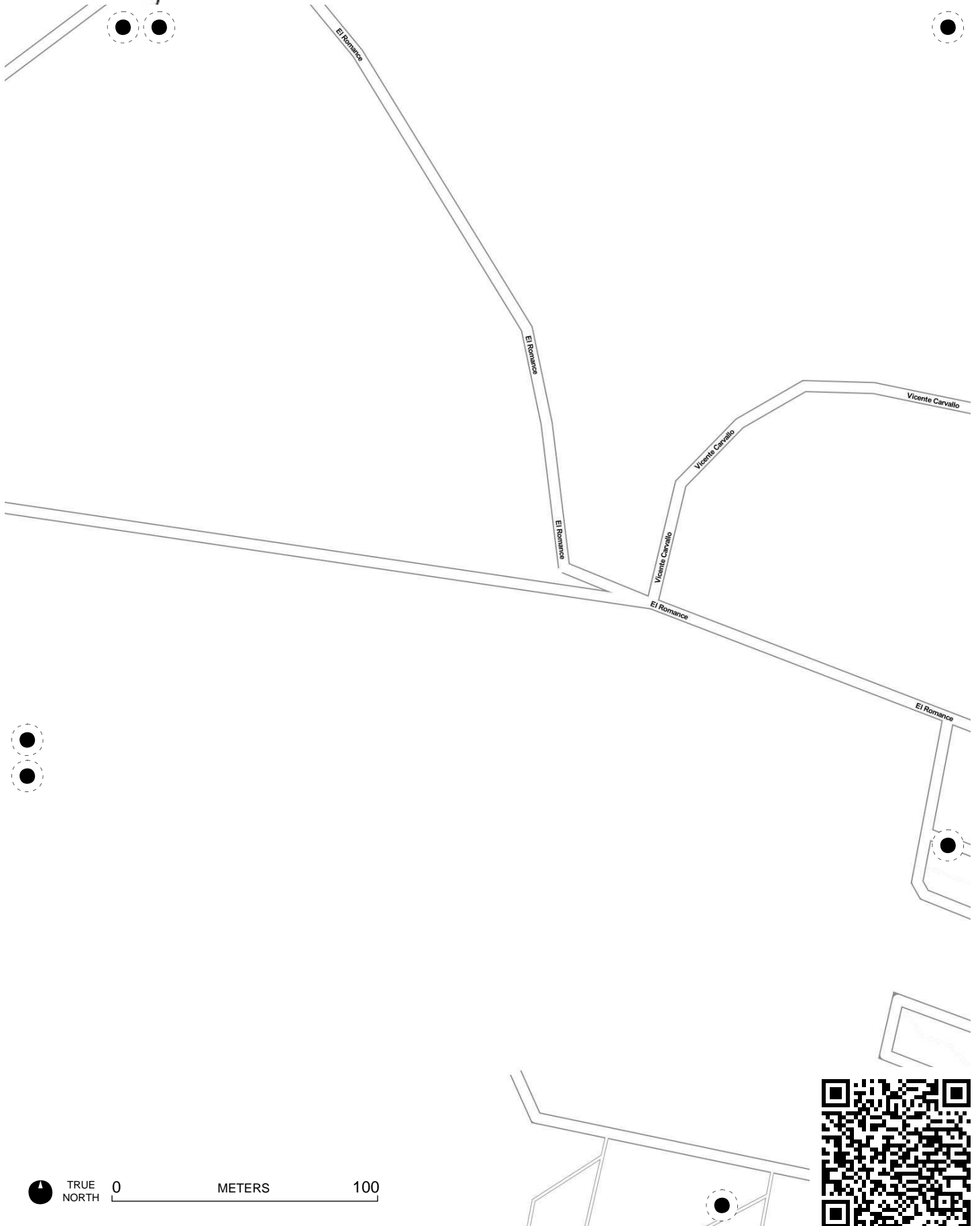

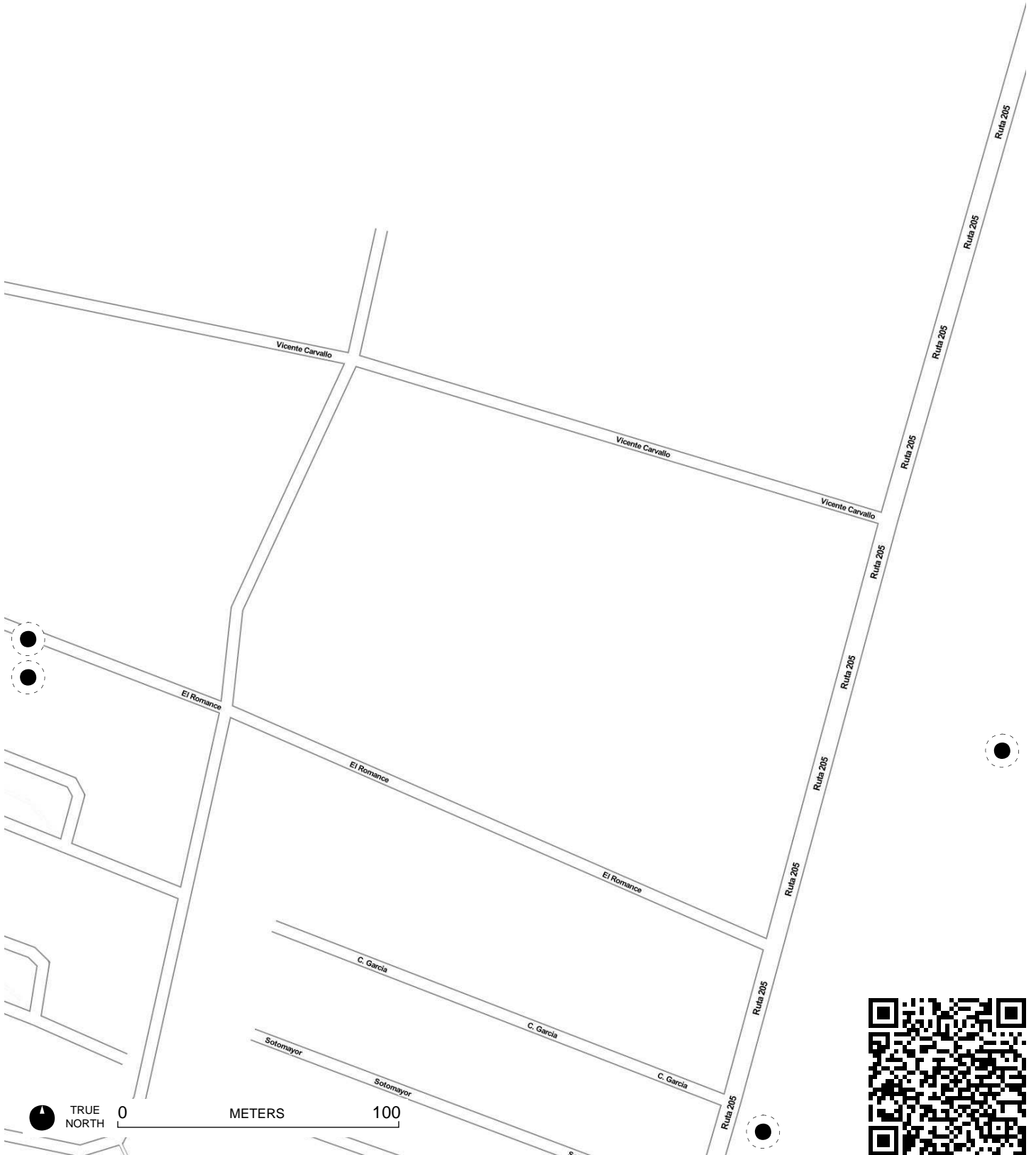

Field Papers

Untitled

<http://fieldpapers.org/atlas/5lo1ggl/A7>

Ruta 205
Ruta 205



TRUE NORTH 0 METERS 100



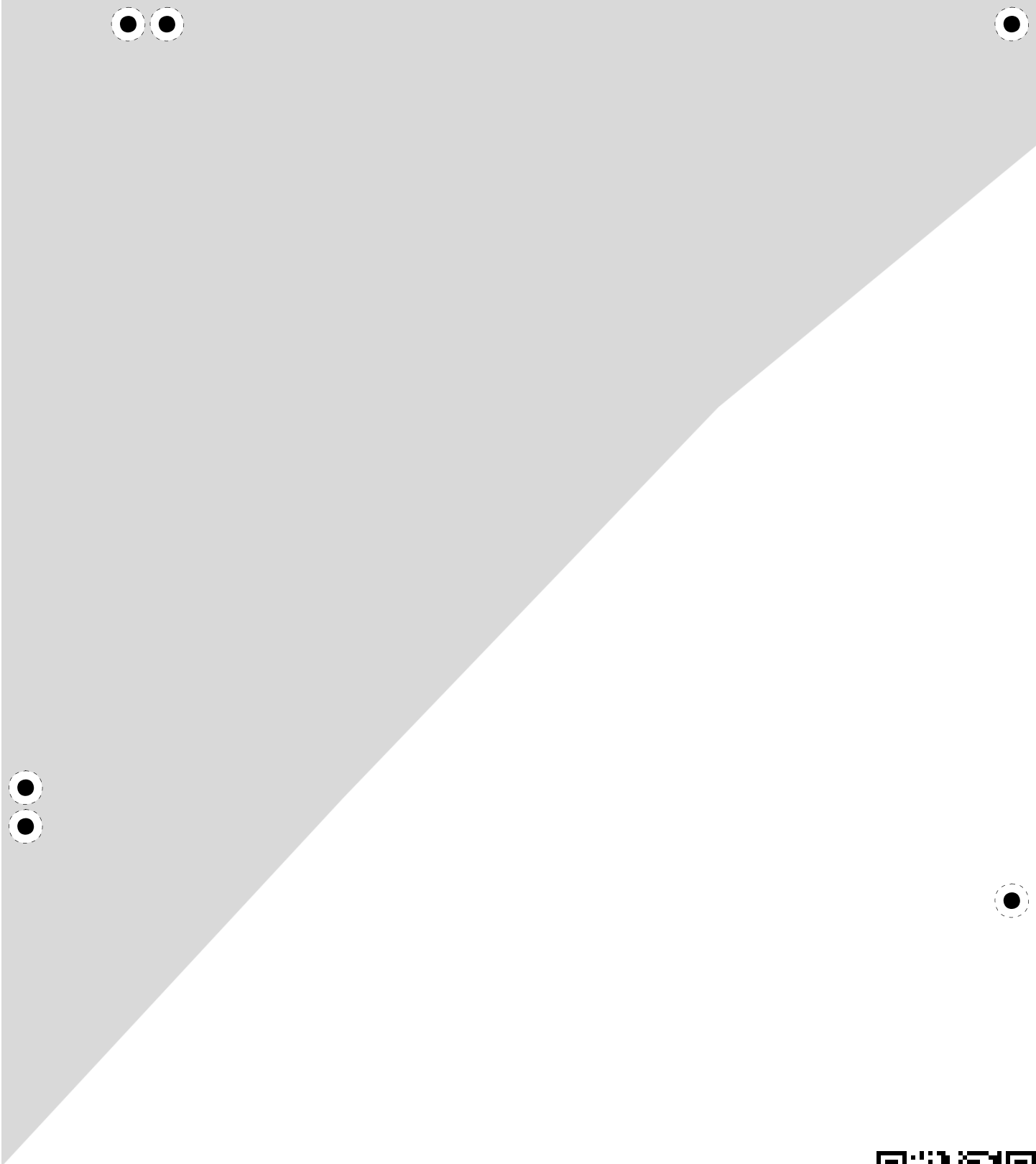

Field Papers



Untitled

<http://fieldpapers.org/atlas/5lo1ggls/B1>



Field Papers



Untitled

<http://fieldpapers.org/atlasses/5lo1ggls/B2>





Field Papers



Untitled

<http://fieldpapers.org/atlasses/5lo1ggls/B4>

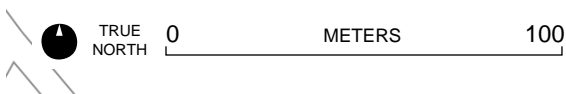

Field Papers

Untitled

<http://fieldpapers.org/atlasses/5lo1ggl/B5>

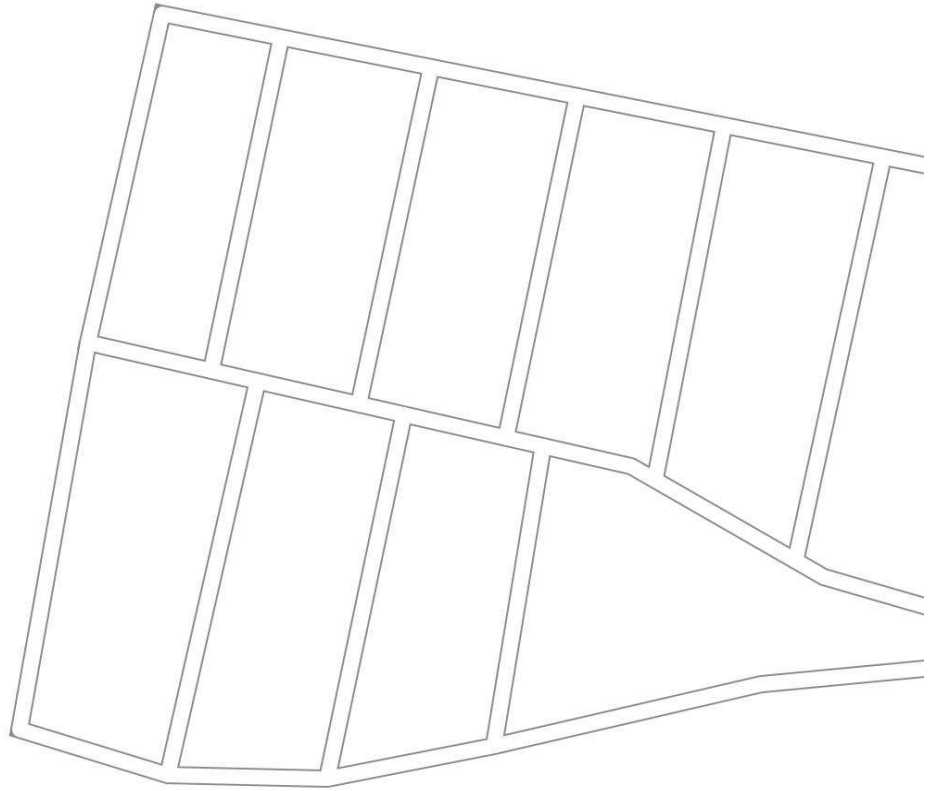
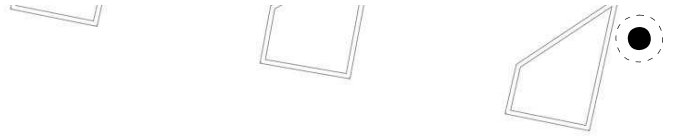

TRUE NORTH 0 METERS 100



Field Papers

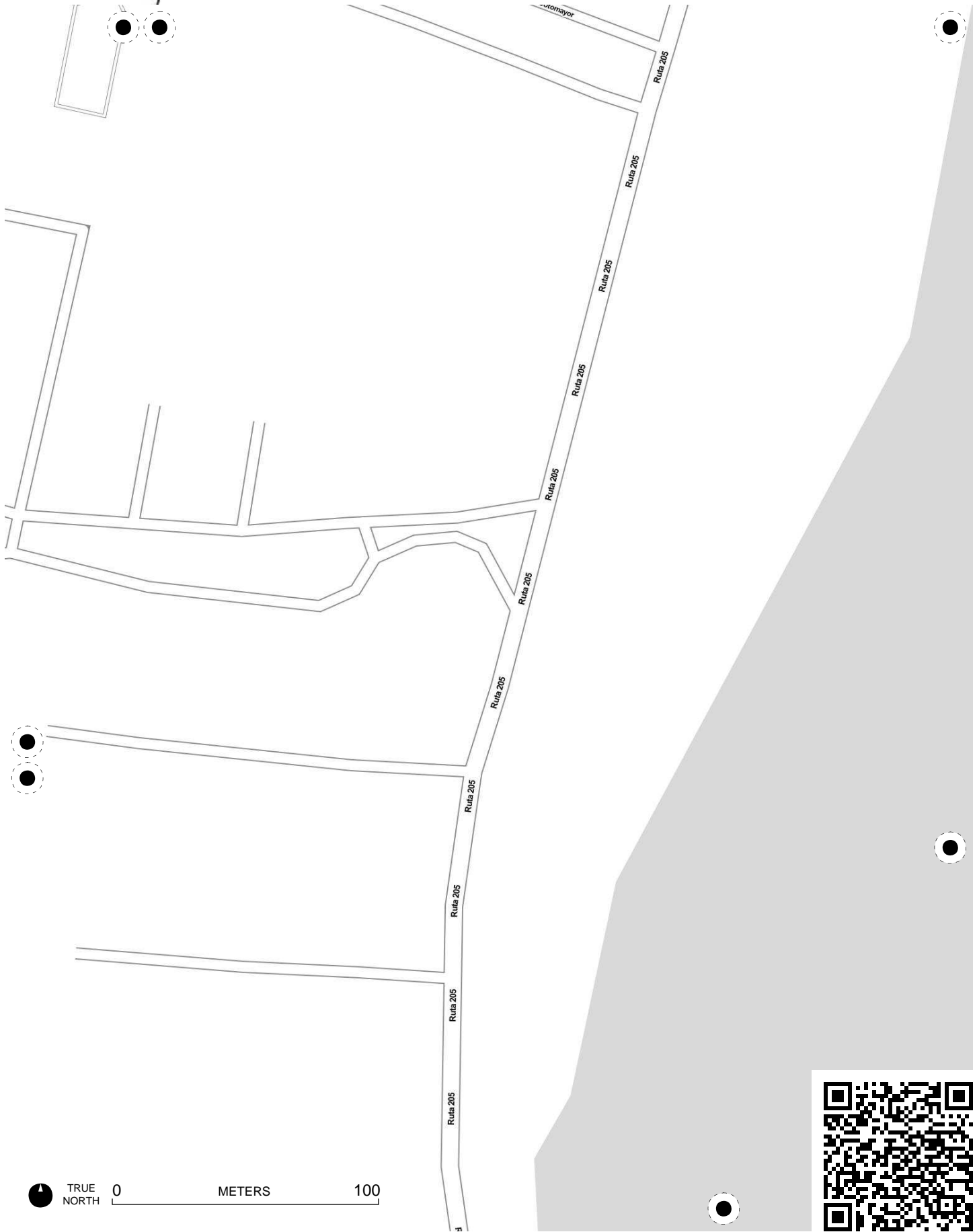

TRUE NORTH 0 METERS 100



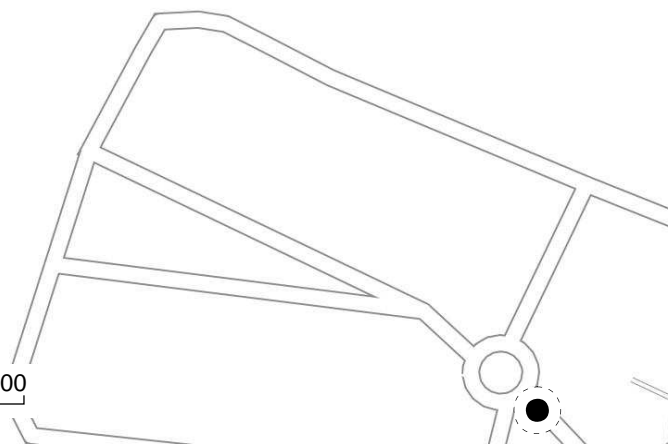

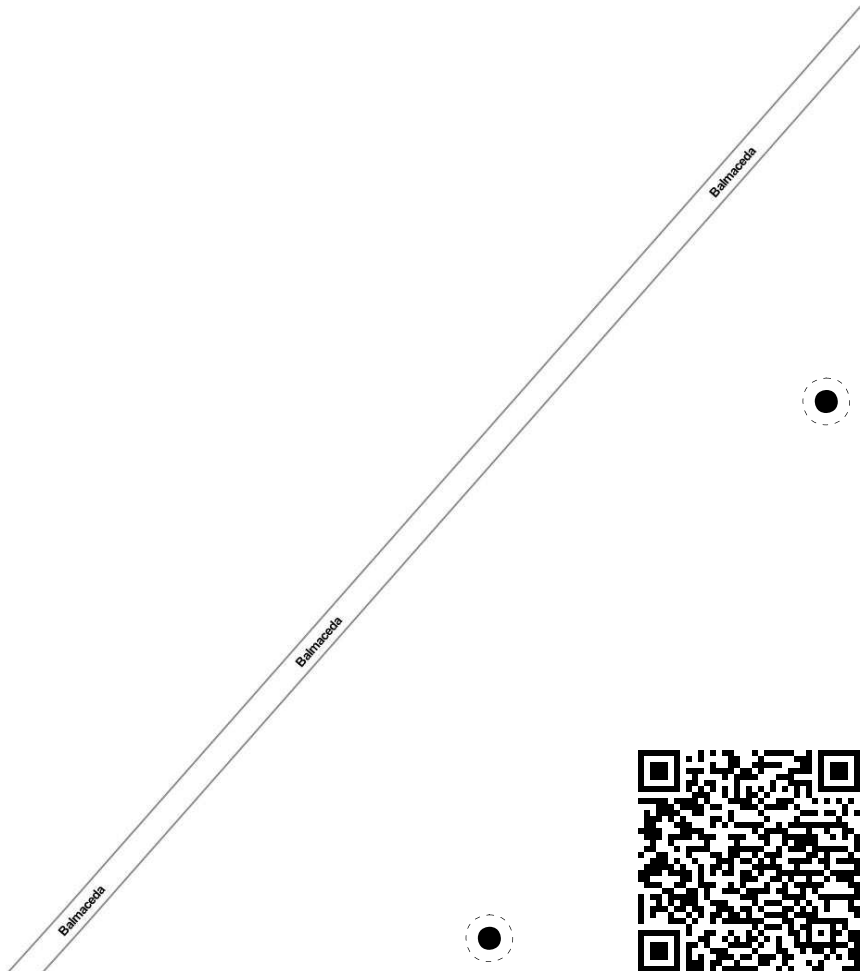

Field Papers



Untitled

<http://fieldpapers.org/atlas/5lo1ggls/C1>

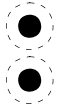

Field Papers



Untitled

<http://fieldpapers.org/atlasses/5lo1ggls/C2>



Field Papers

Untitled
<http://fieldpapers.org/atlasses/5lo1ggls/C3>

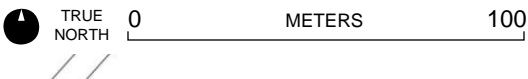

Field Papers

Untitled
<http://fieldpapers.org/atlas/5lo1ggls/C4>

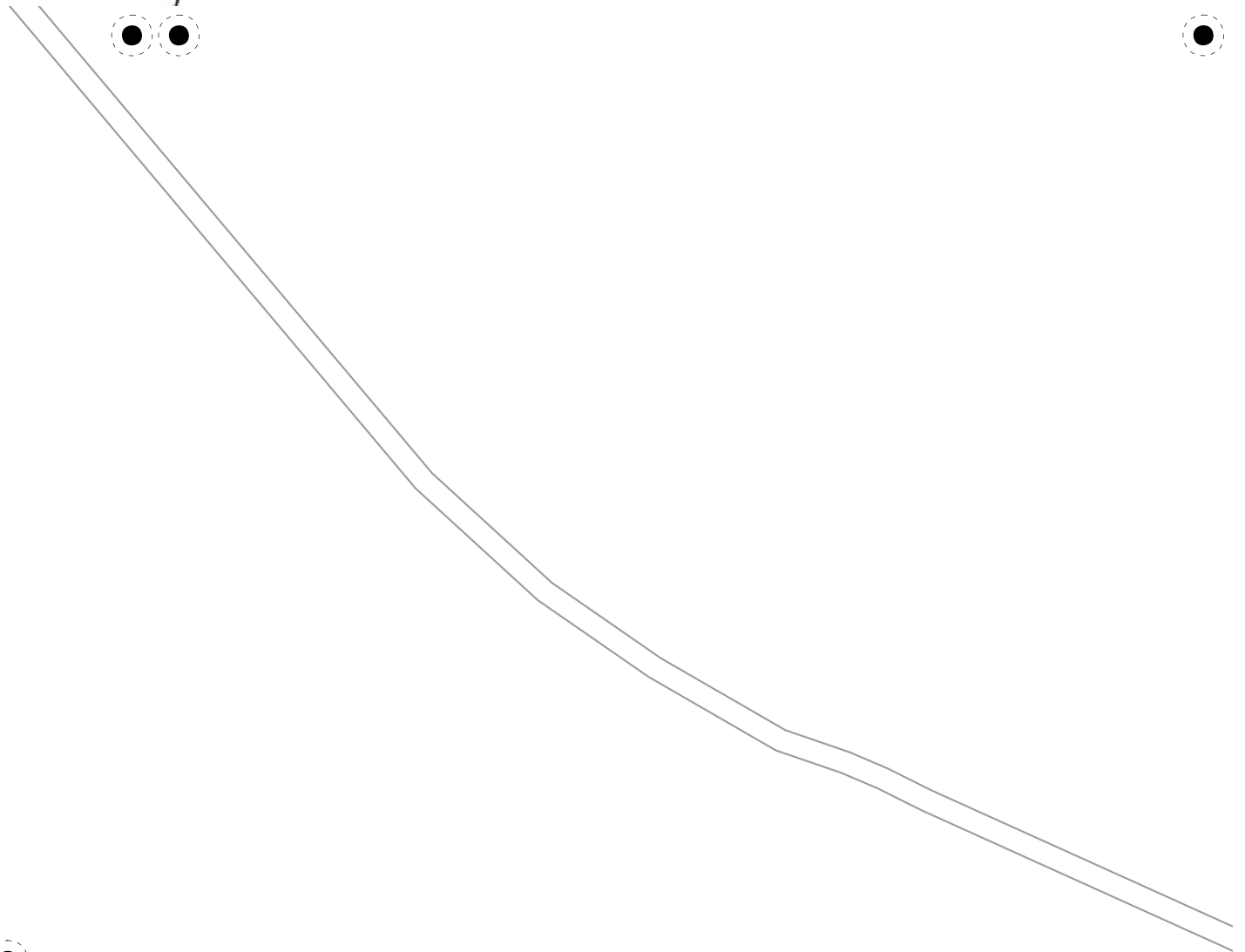

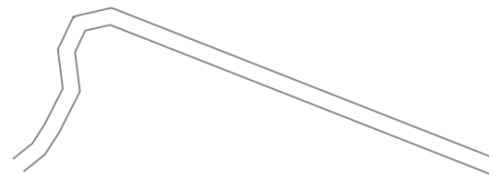

Field Papers

Untitled

<http://fieldpapers.org/atlasses/5lo1ggl/C6>

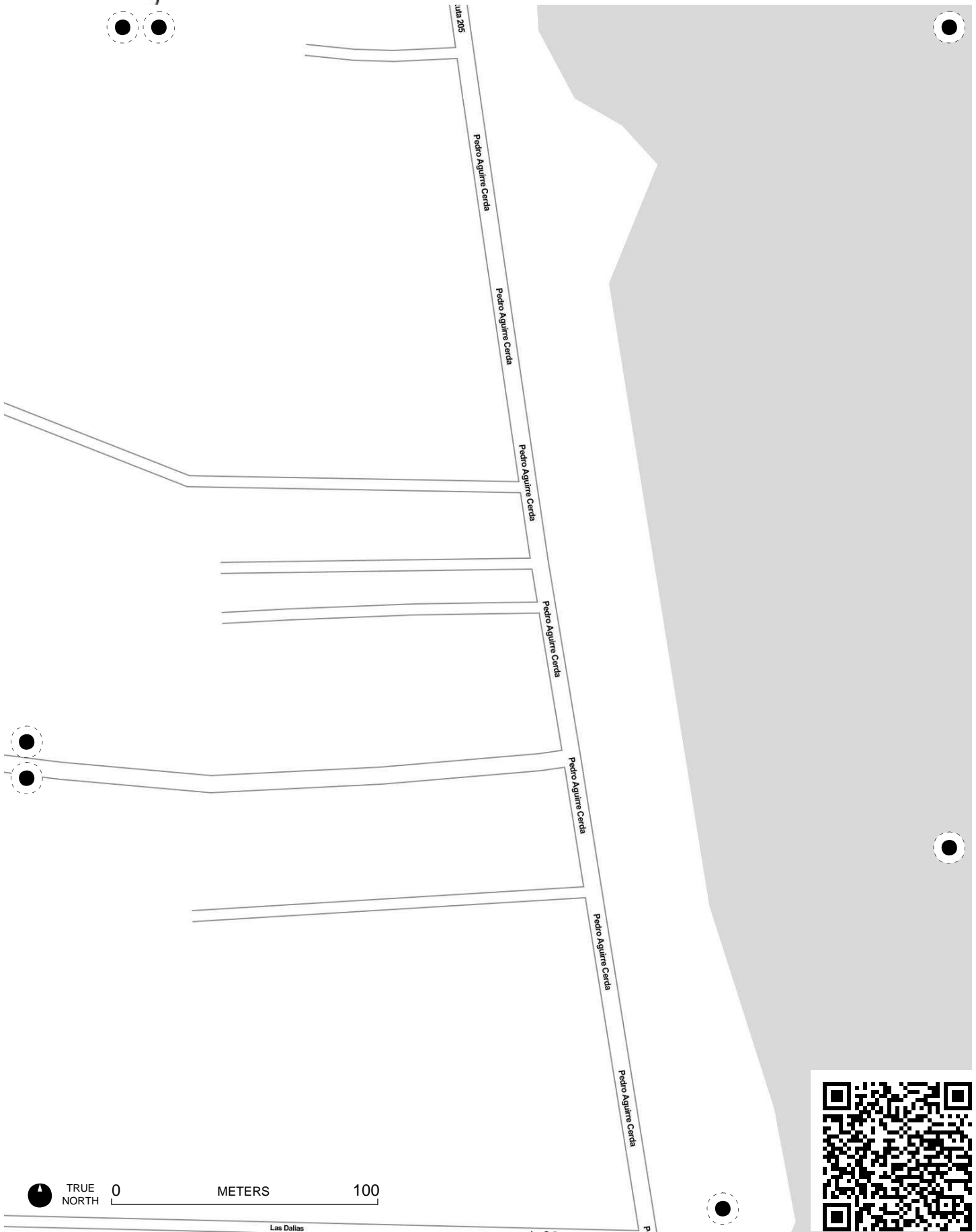

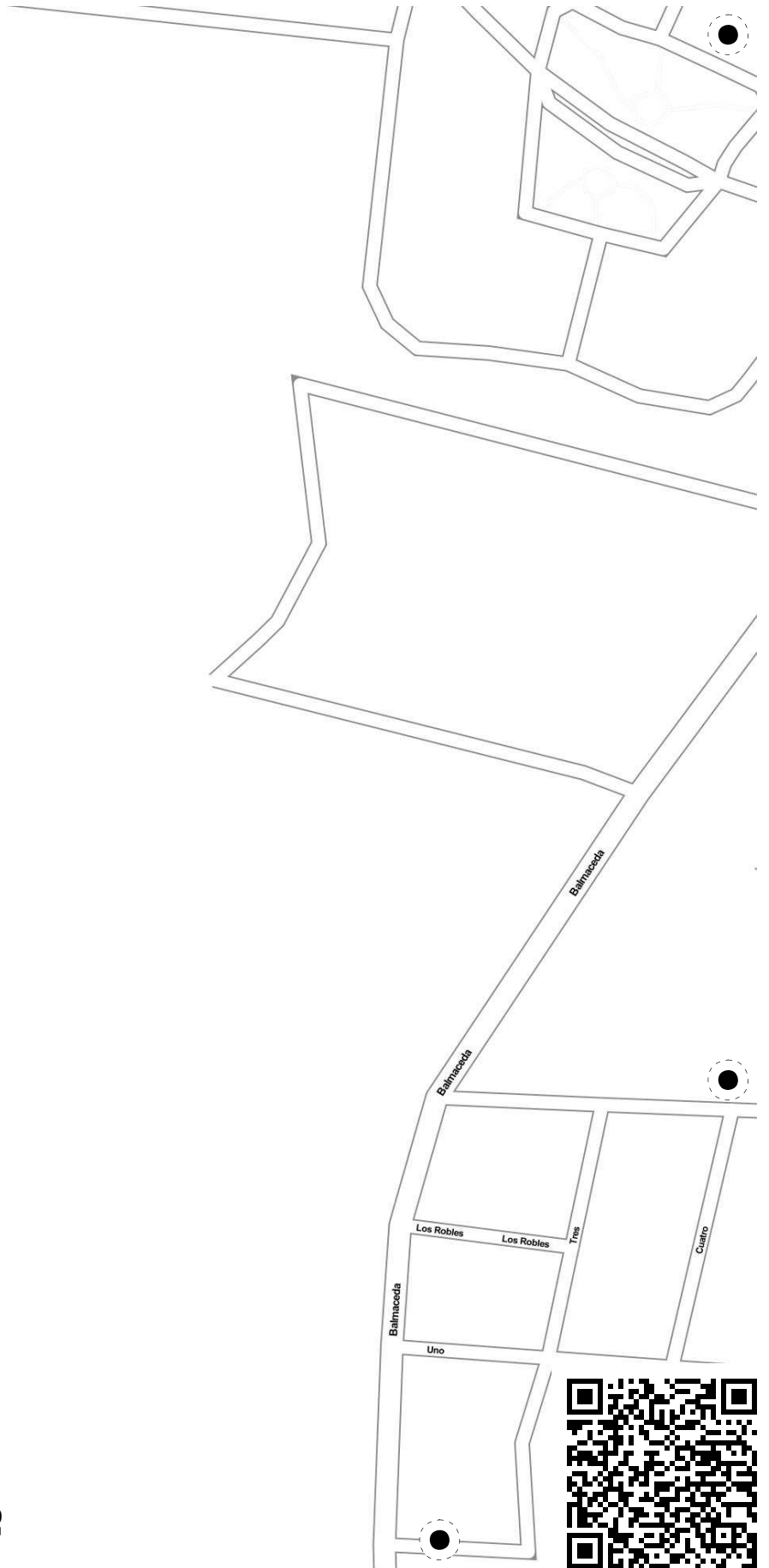
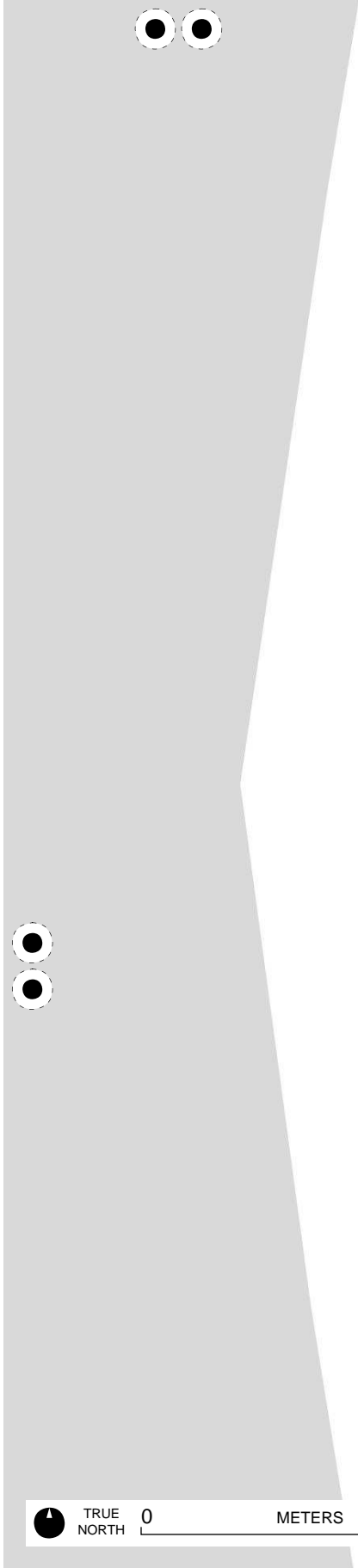

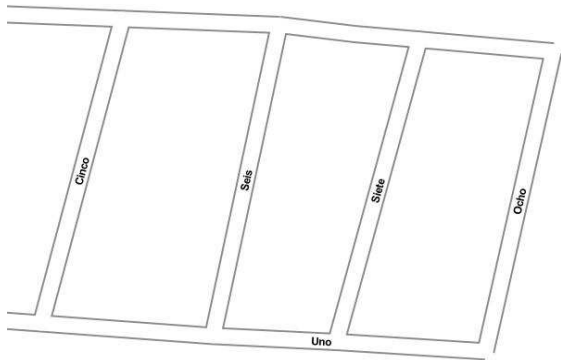
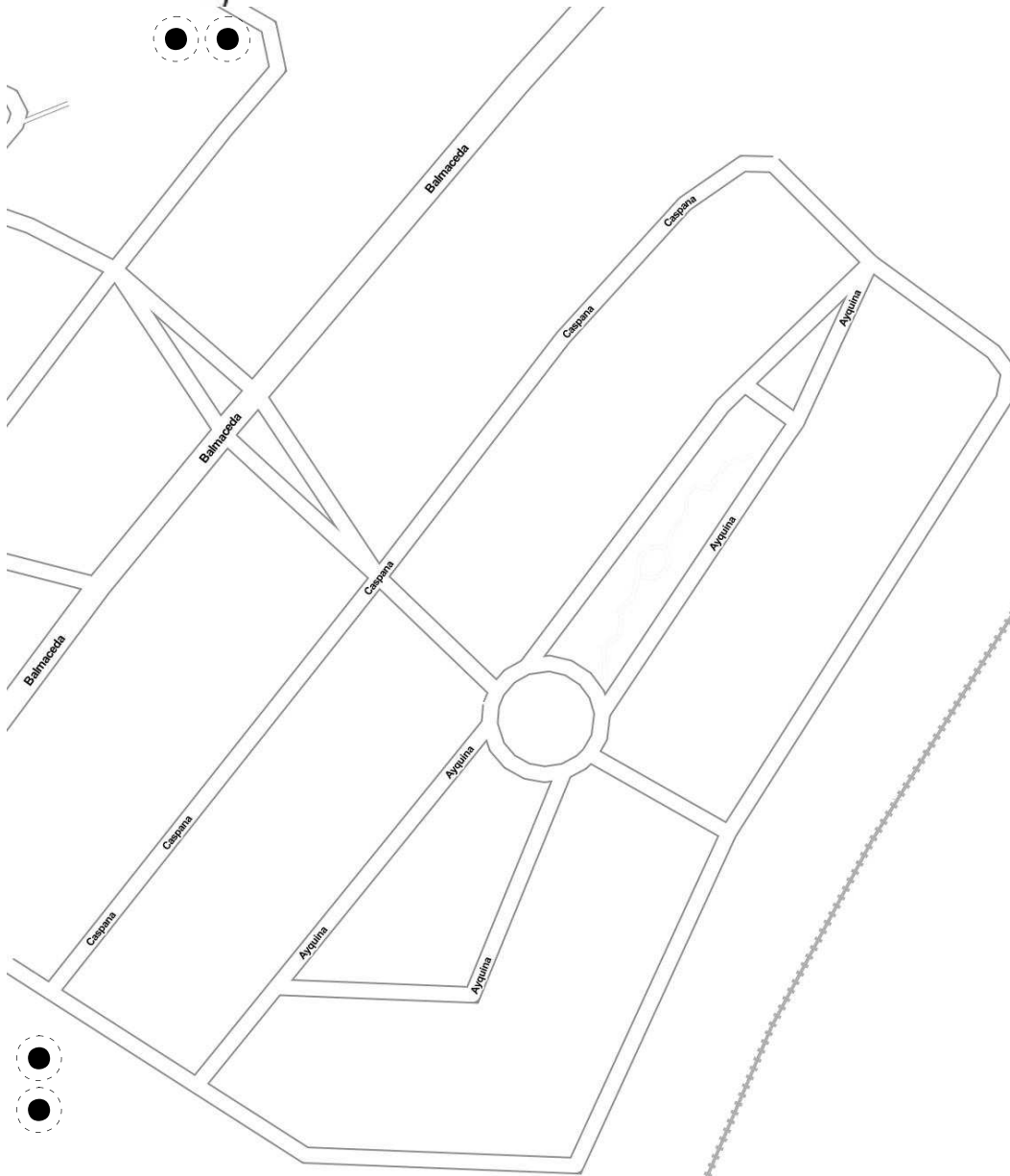

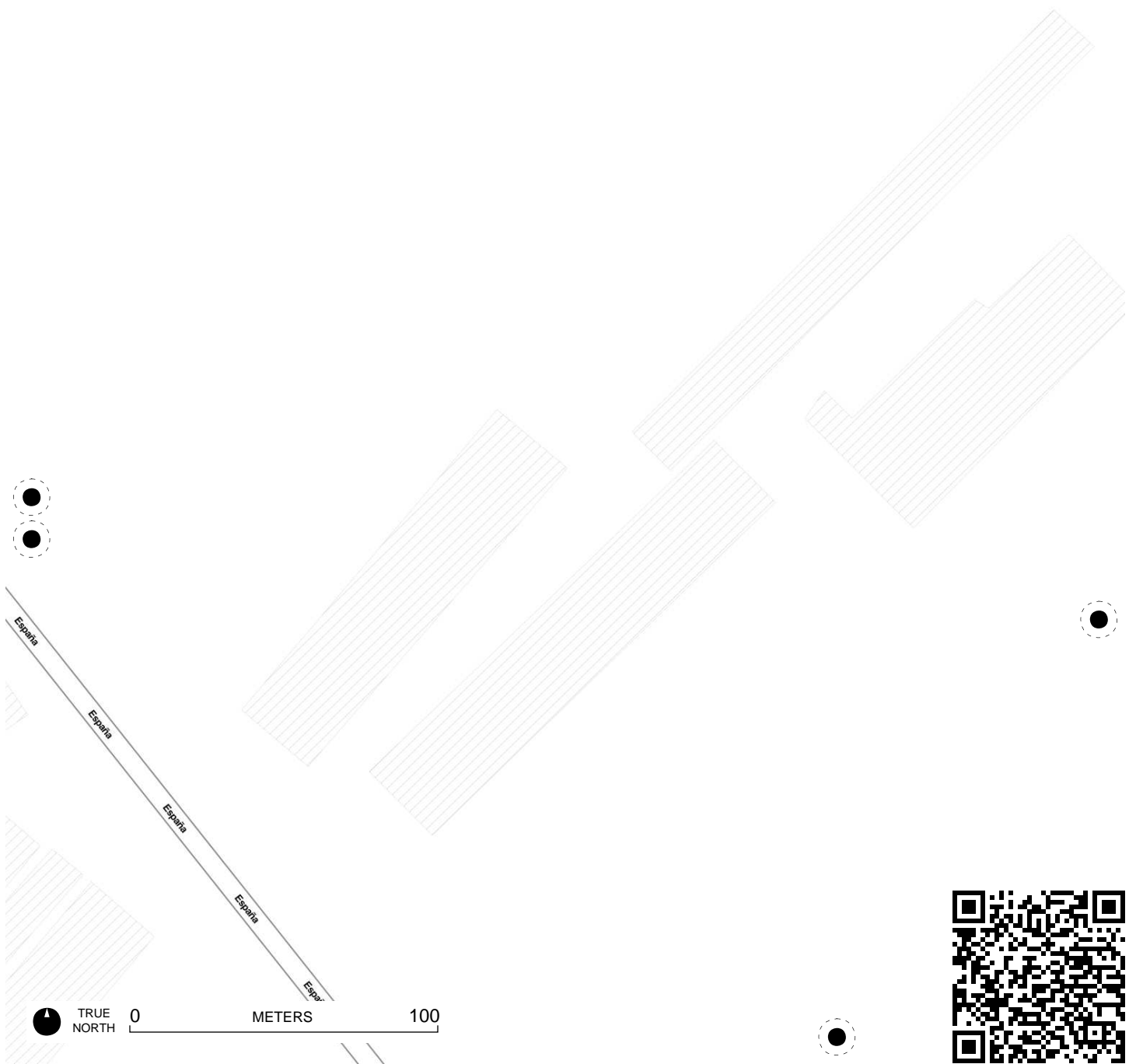

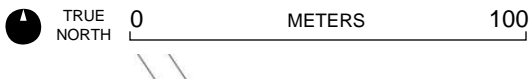

Field Papers

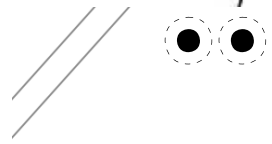

Untitled
<http://fieldpapers.org/atlasses/5lo1ggls/D3>



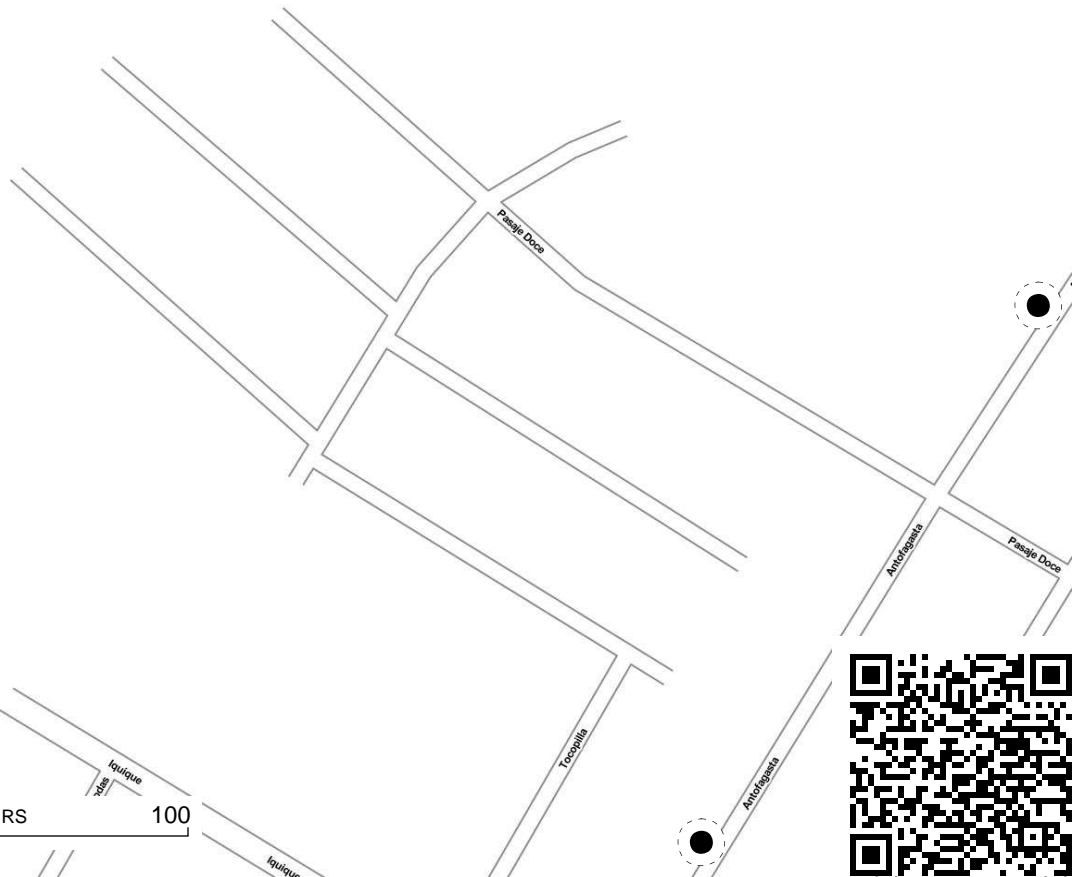

TRUE NORTH

0

METERS

100



Field Papers



Untitled
<http://fieldpapers.org/atlasses/5lo1ggl/D5>

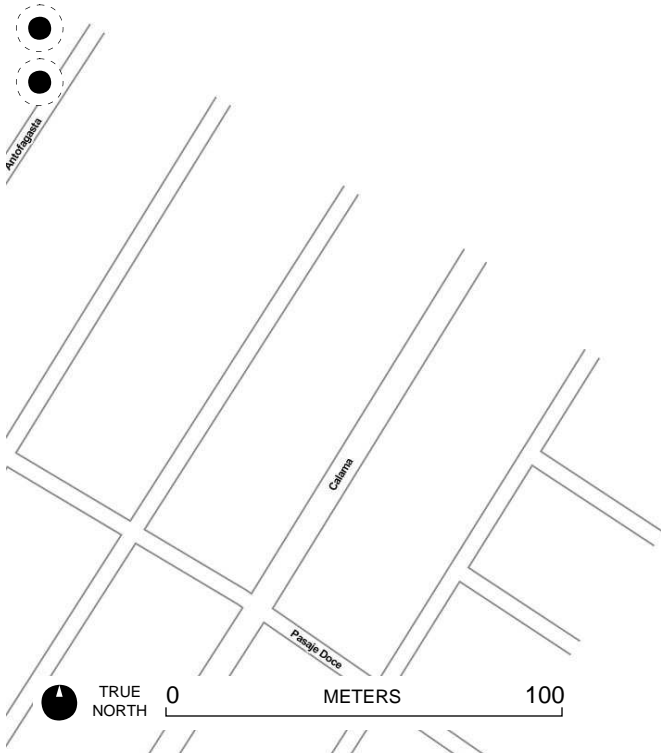
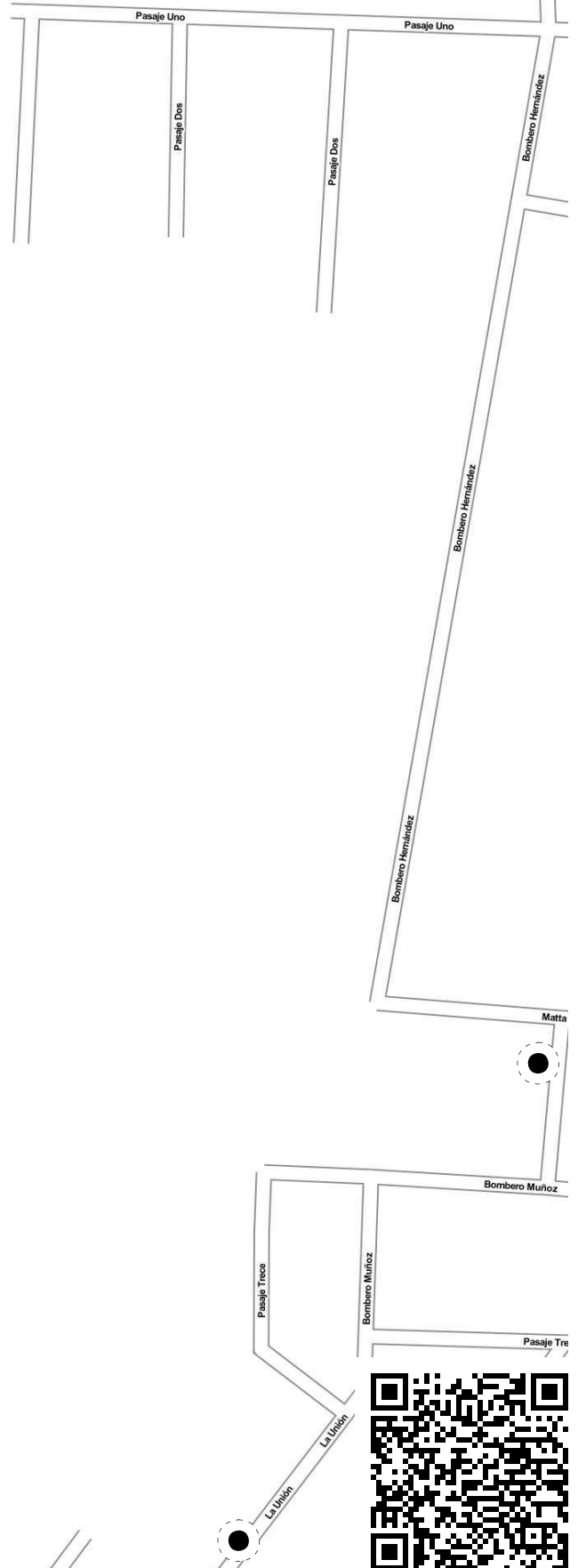

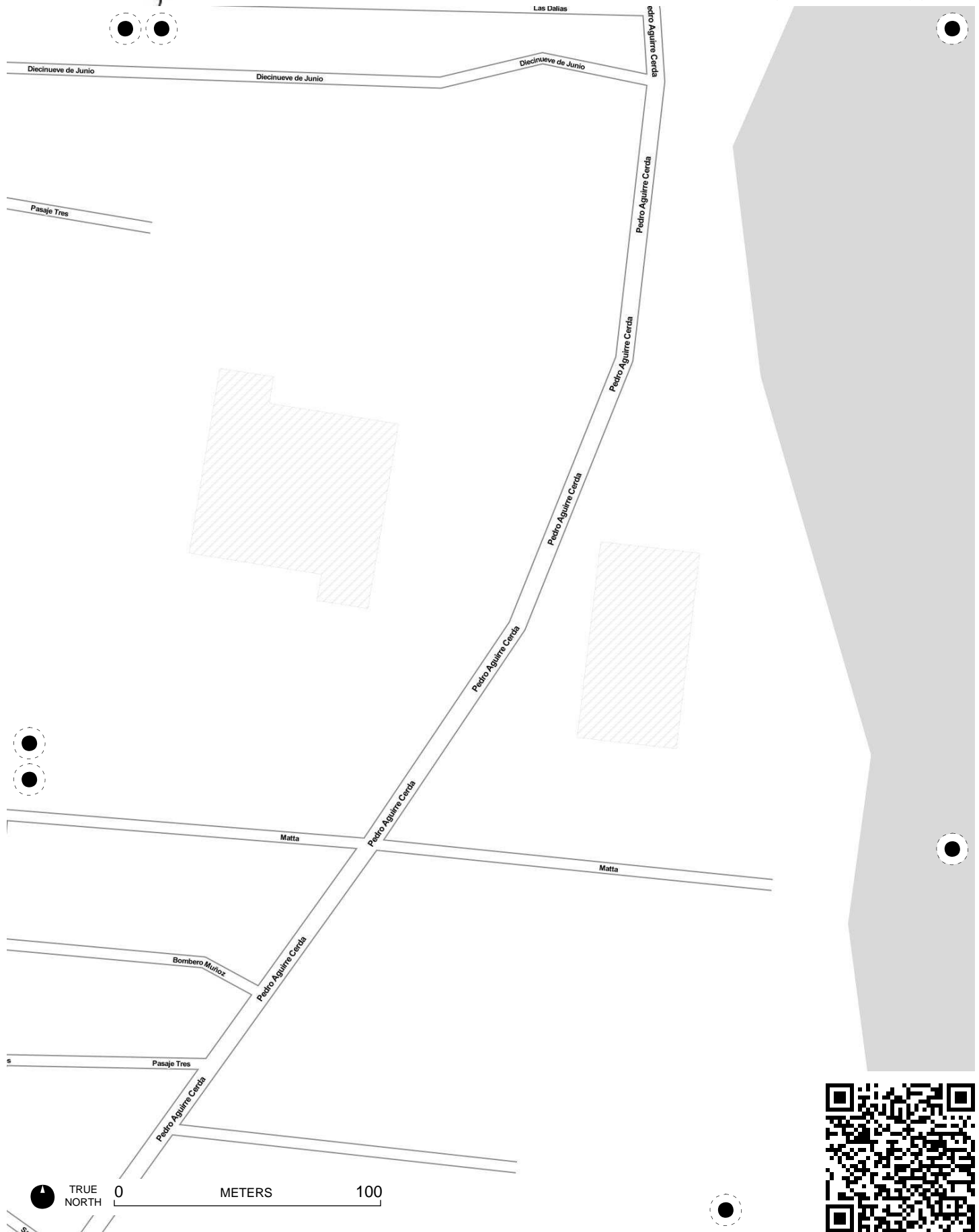

Field Papers

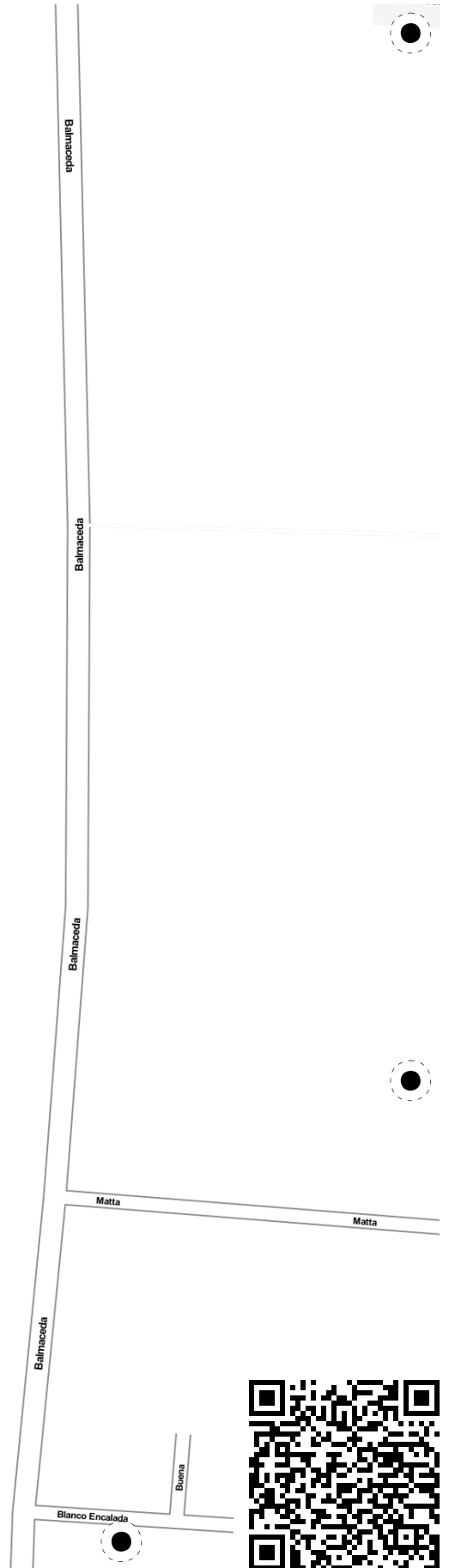
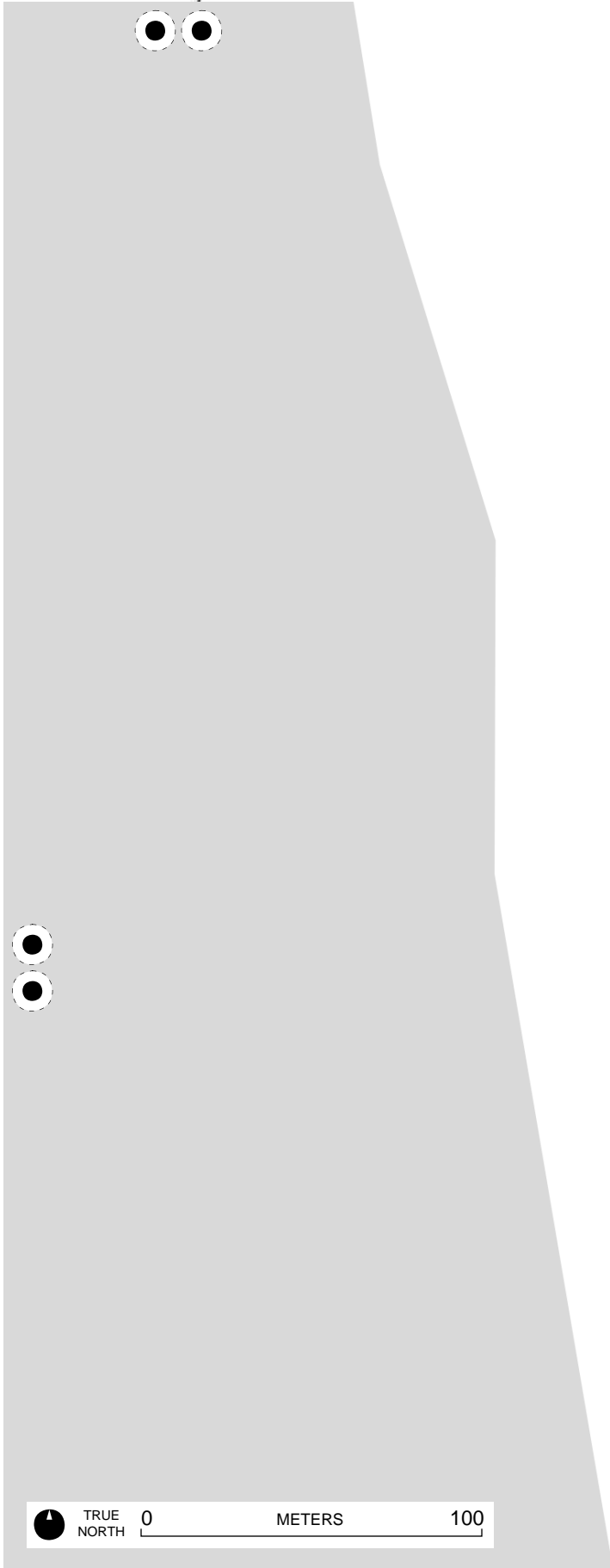

Field Papers

Untitled
<http://fieldpapers.org/atlasses/5lo1ggls/D8>



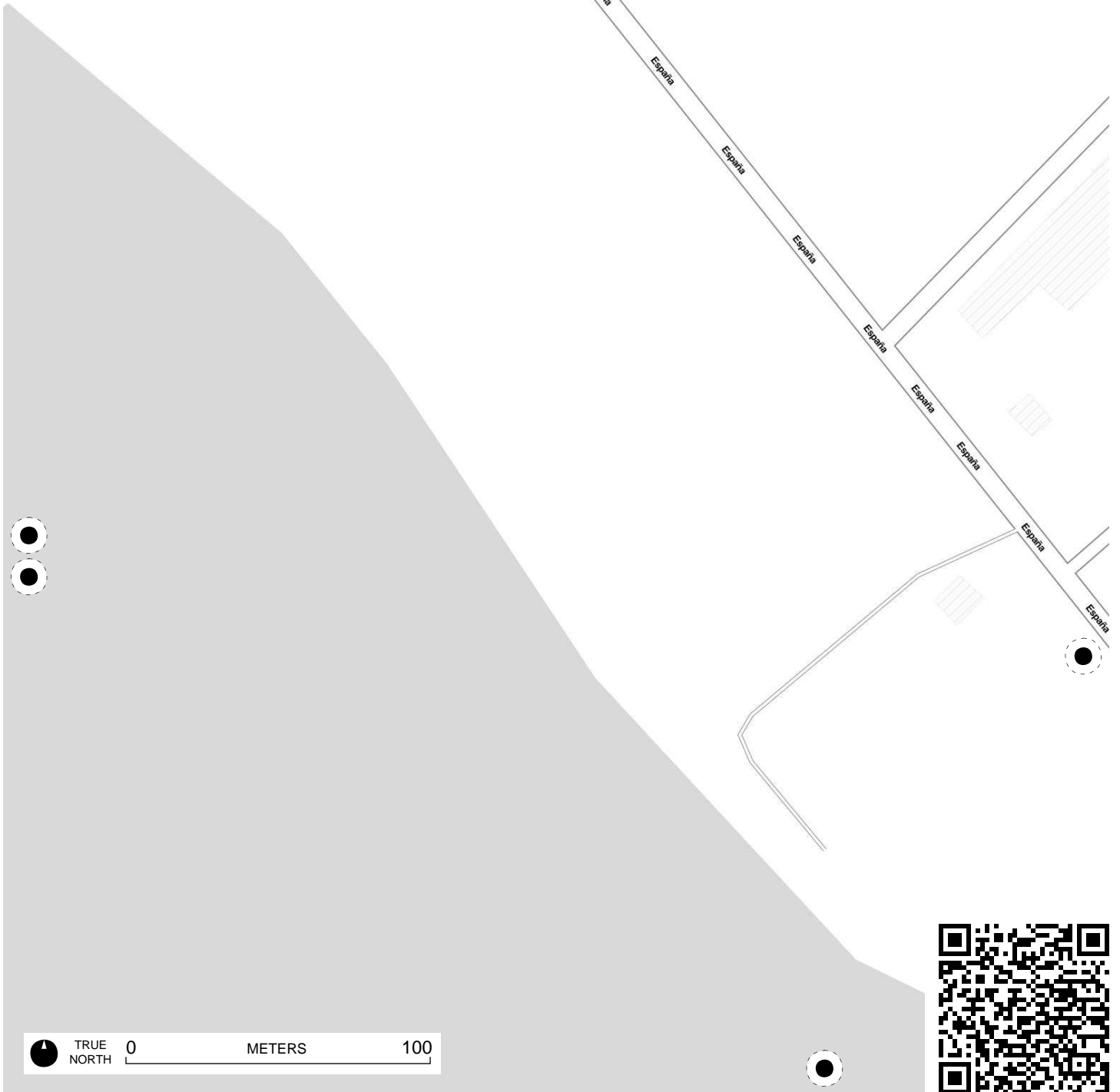

Field Papers

Untitled
<http://fieldpapers.org/atlas/5lo1ggl/E2>

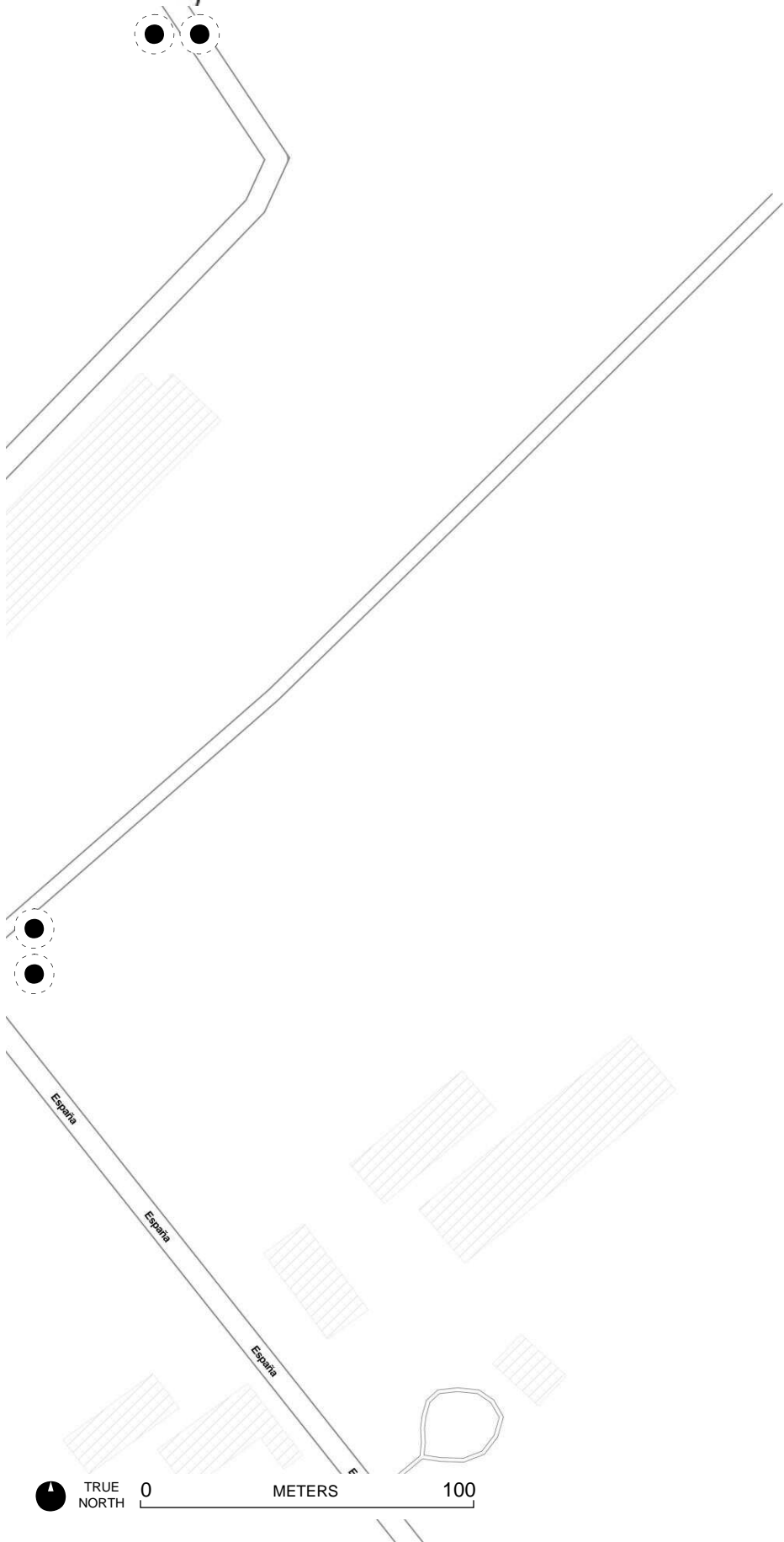

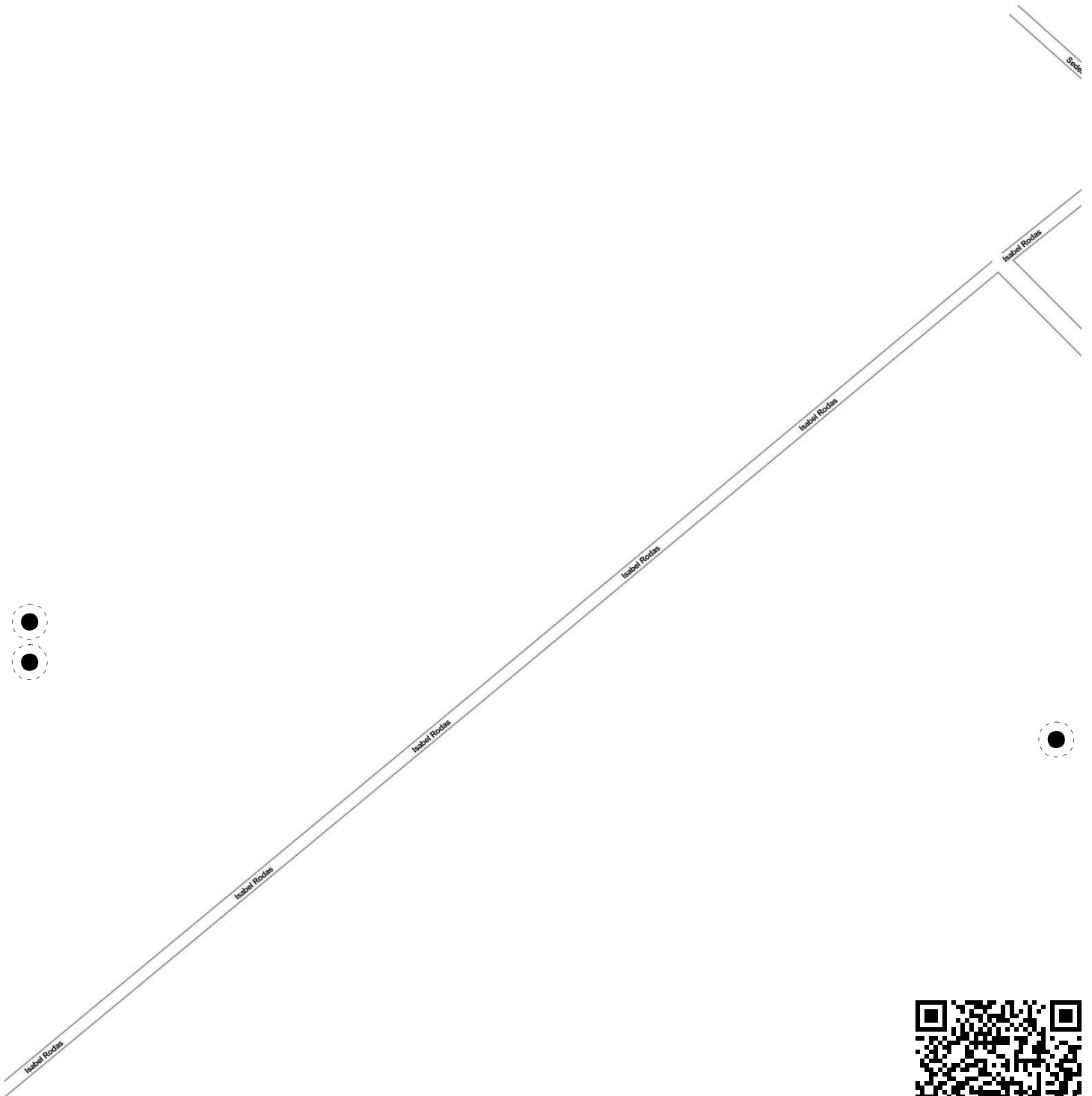

TRUE NORTH 0 METERS 100



Field Papers

Untitled

<http://fieldpapers.org/atlasses/5lo1ggl/E4>

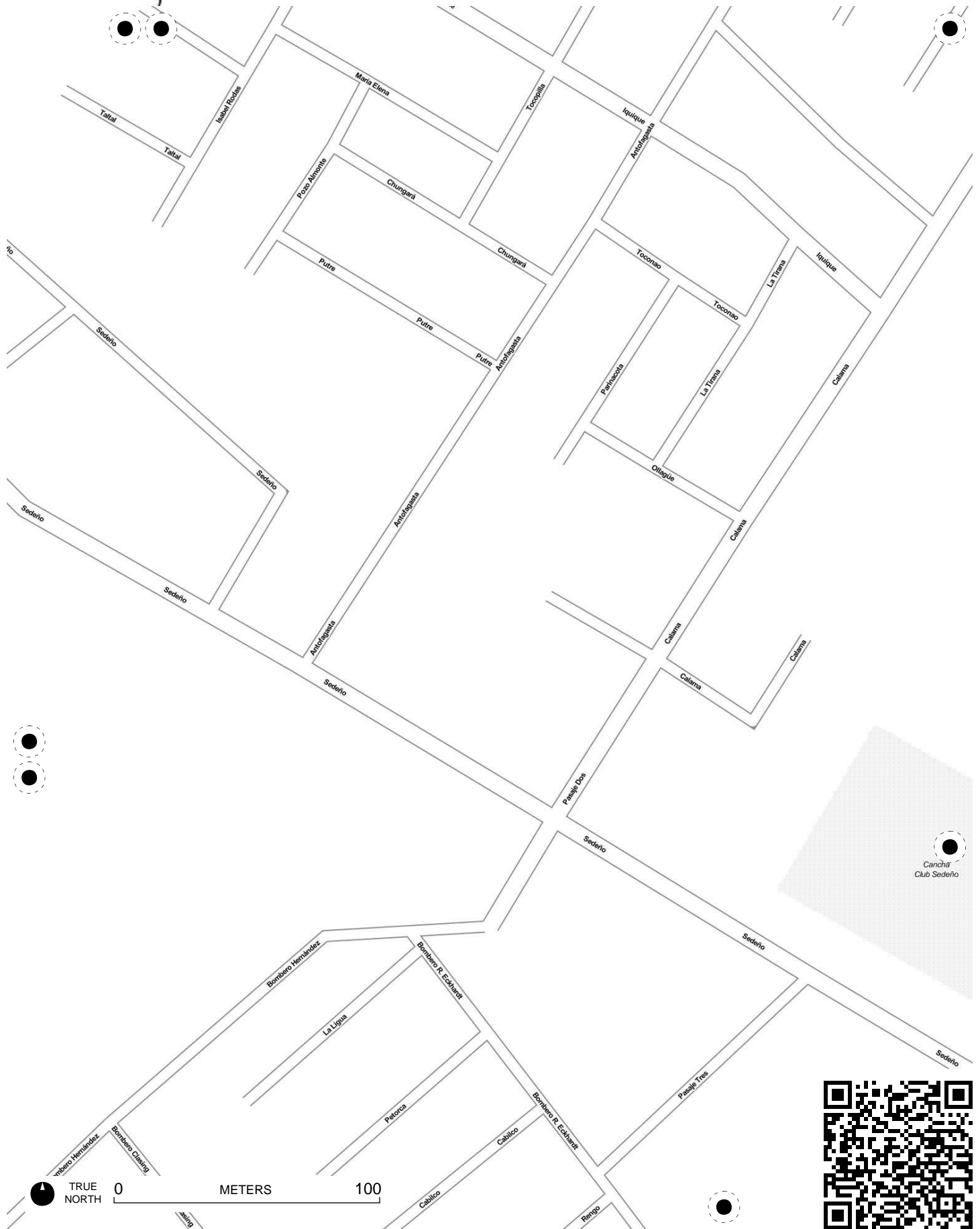

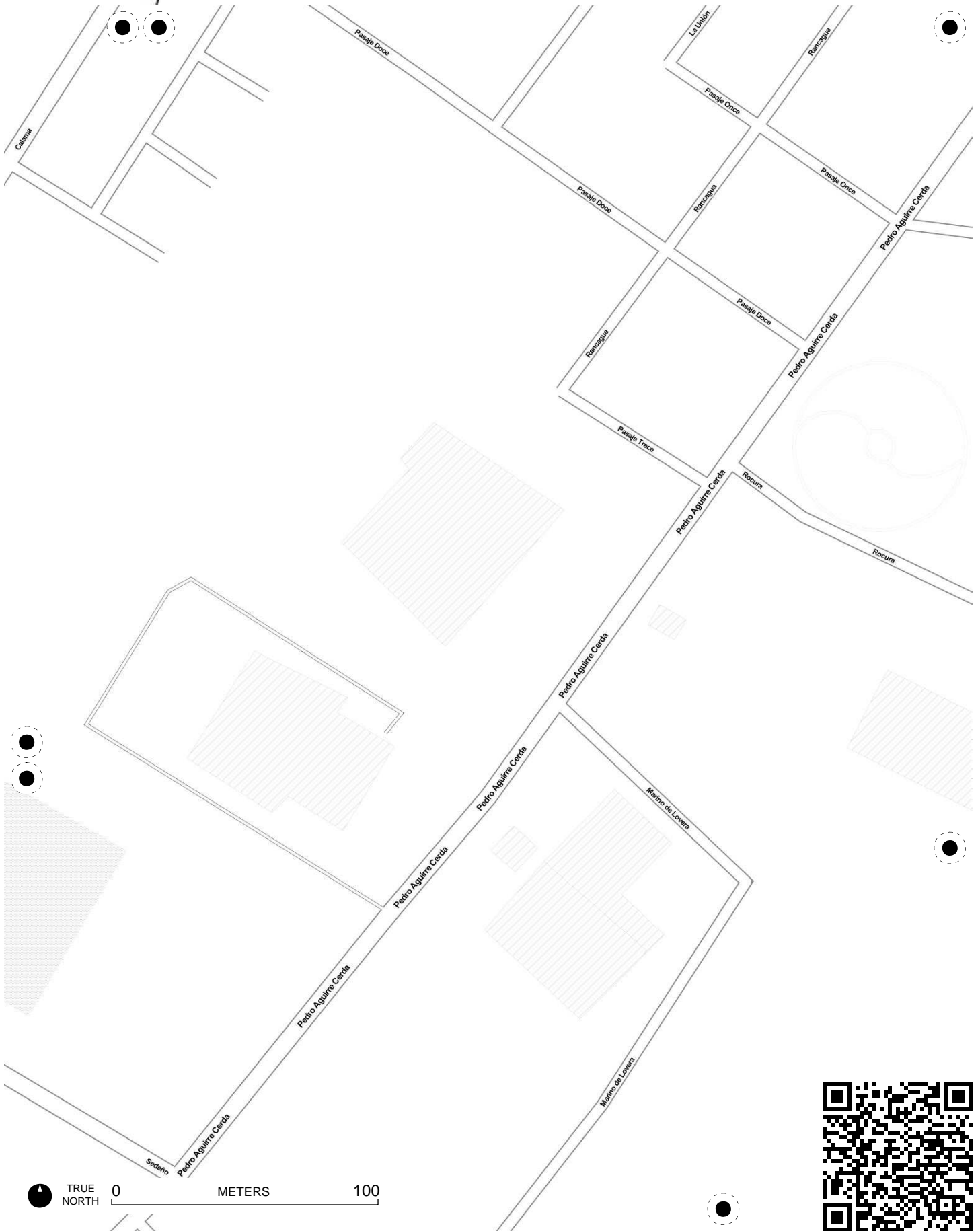

Field Papers

Untitled

<http://fieldpapers.org/atlasses/5lo1ggl/E7>

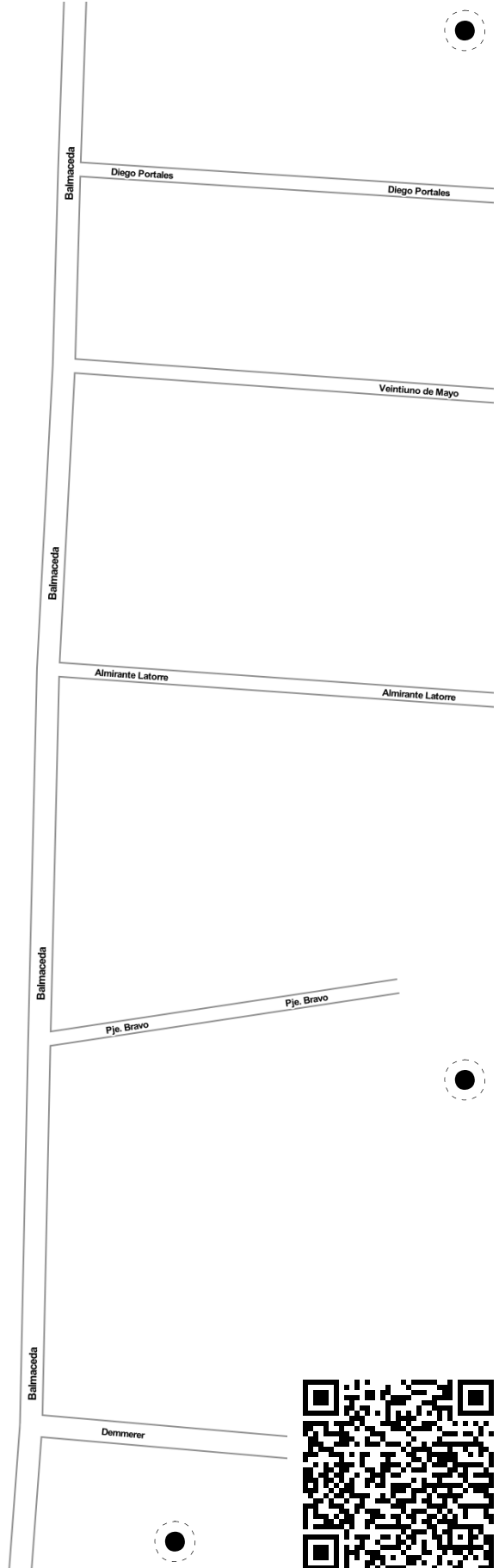
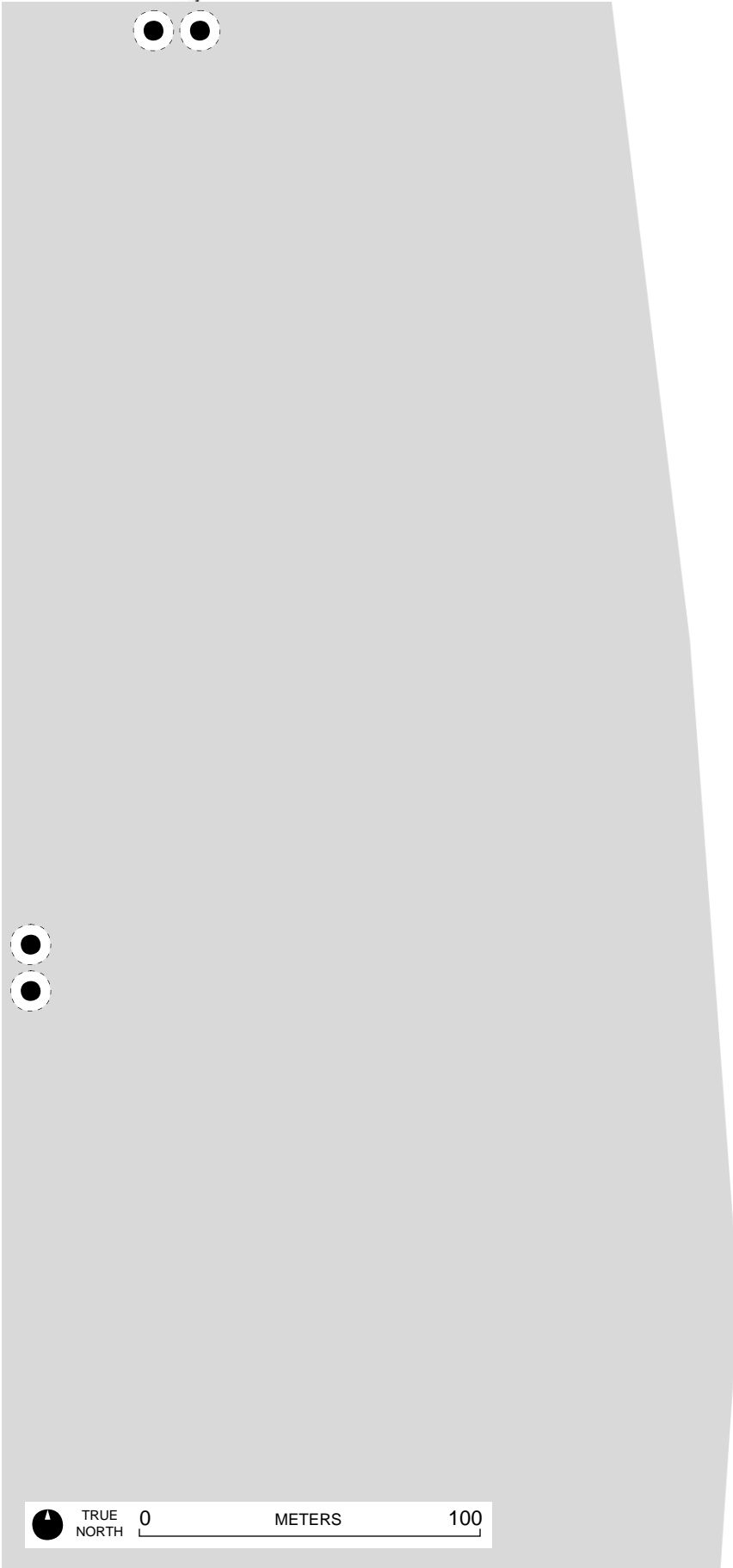

TRUE NORTH 0 METERS 100



Field Papers

Untitled
<http://fieldpapers.org/atlasses/5lo1ggls/E8>

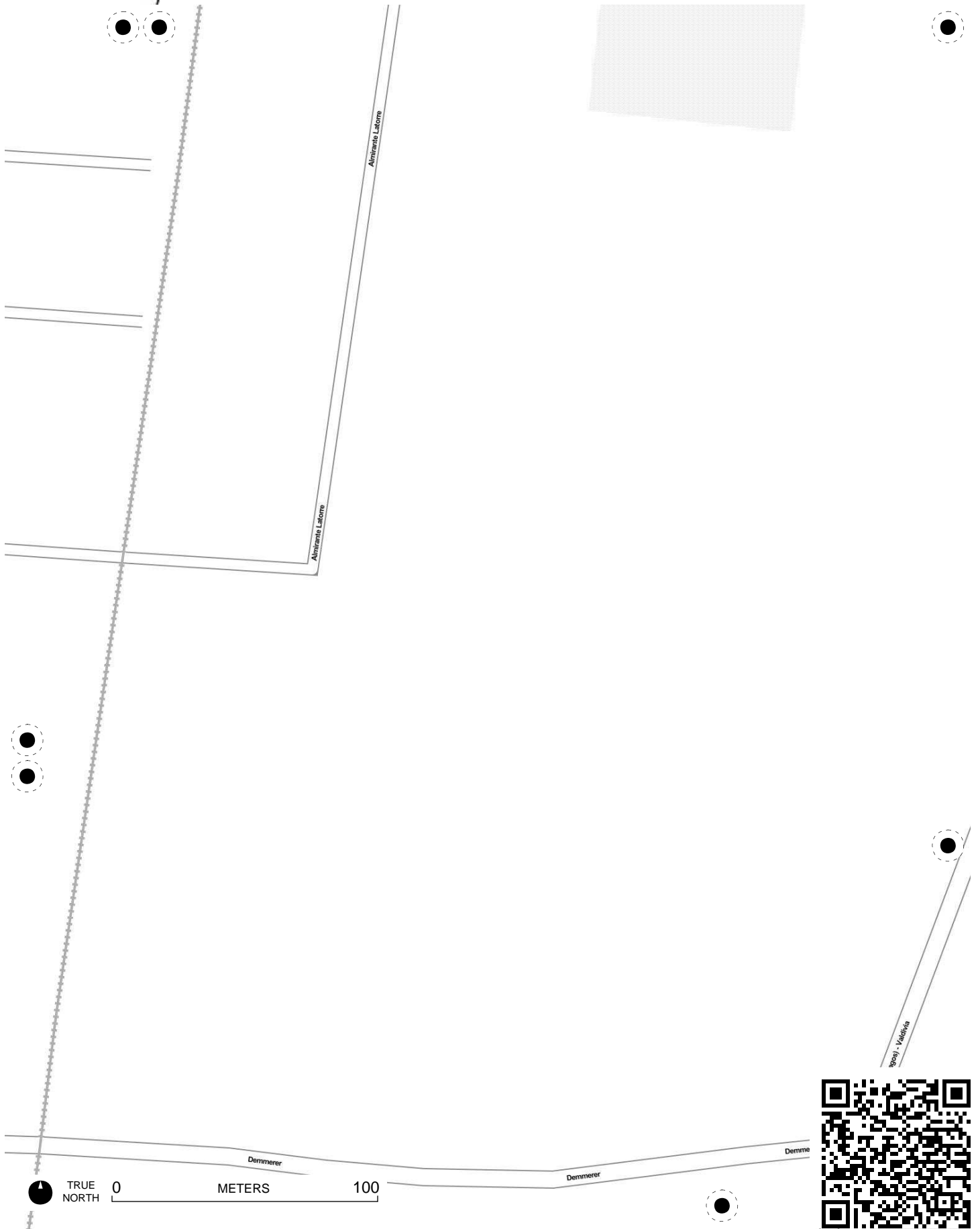

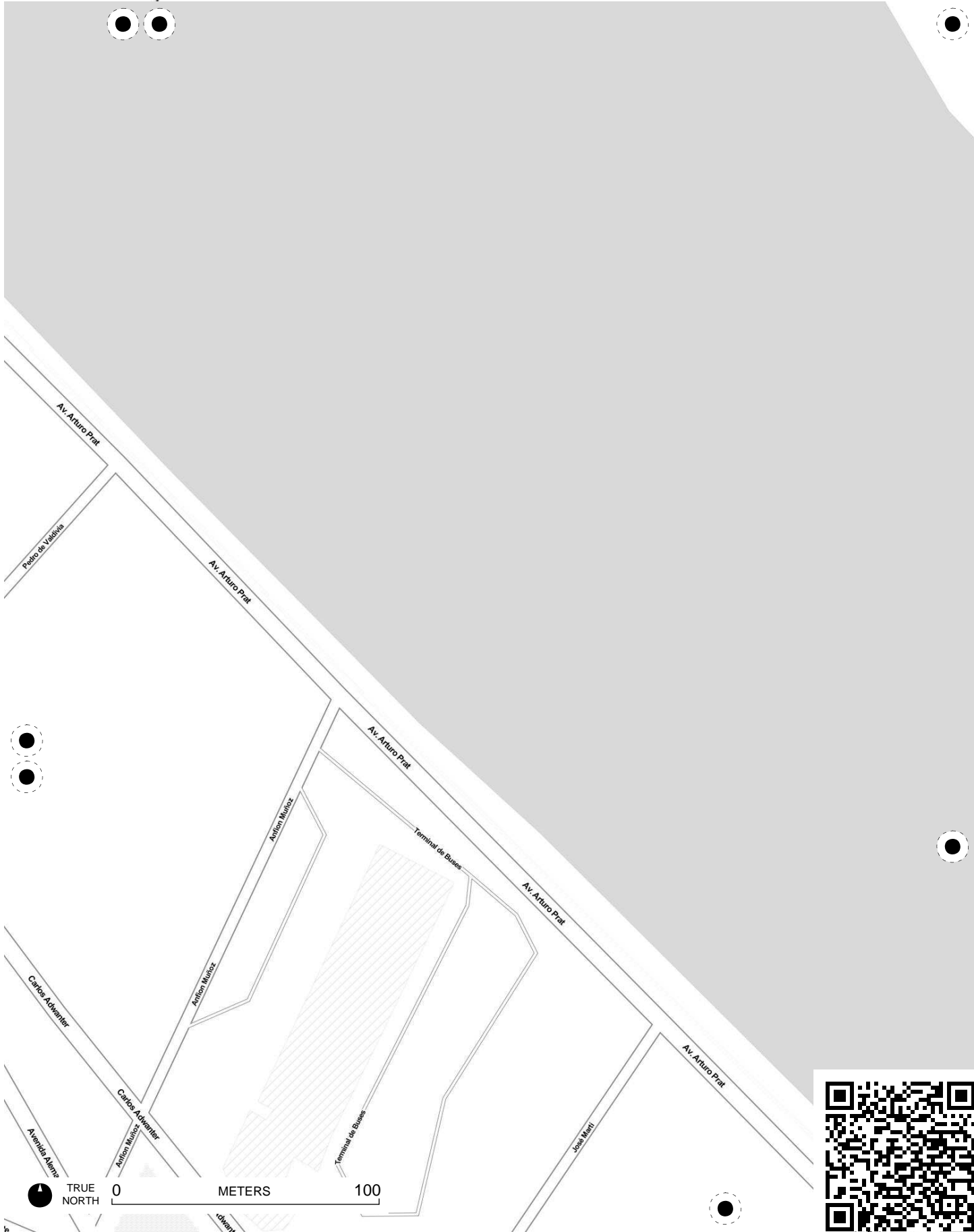



TRUE NORTH 0 METERS 100



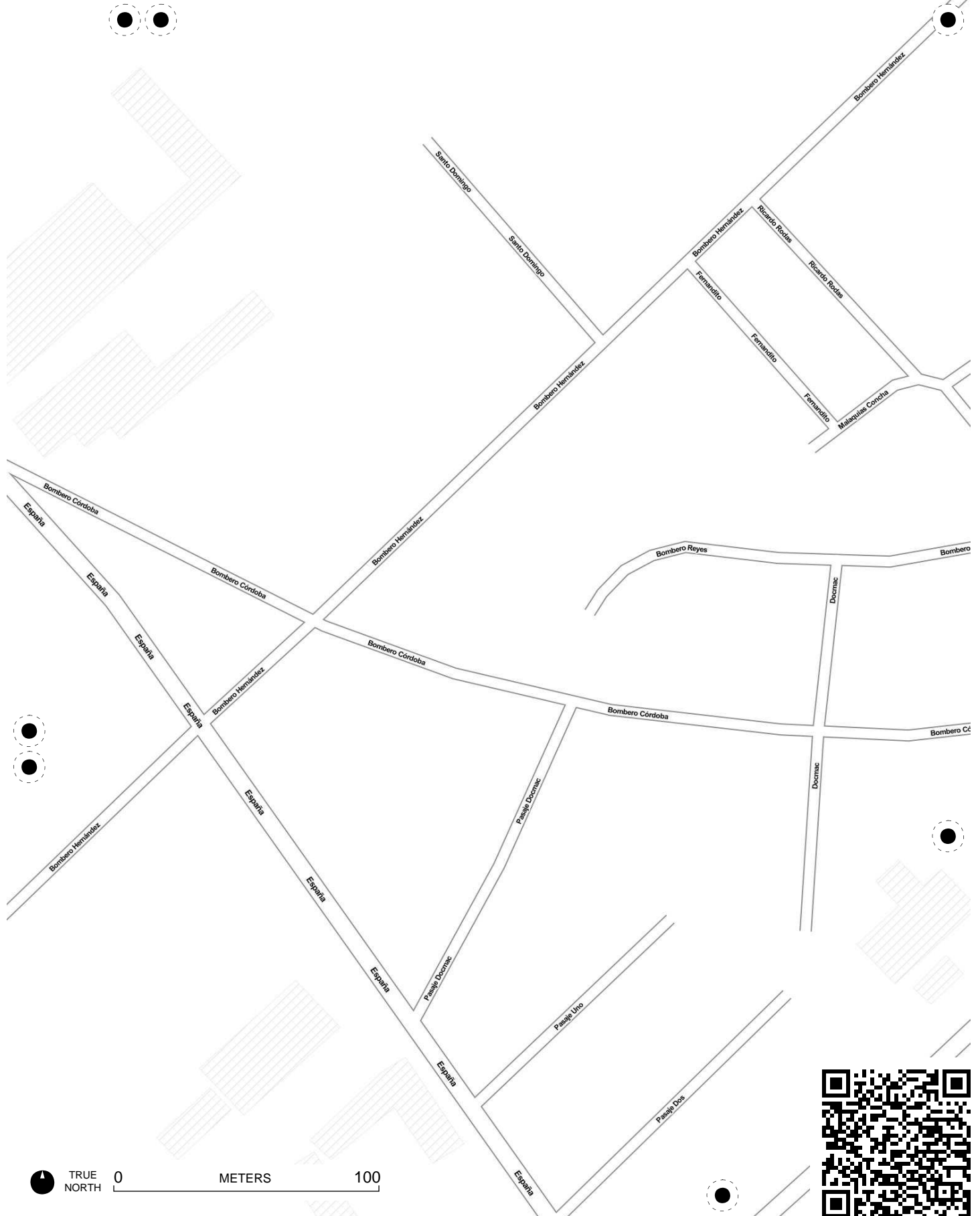



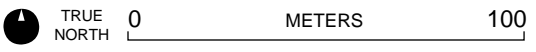

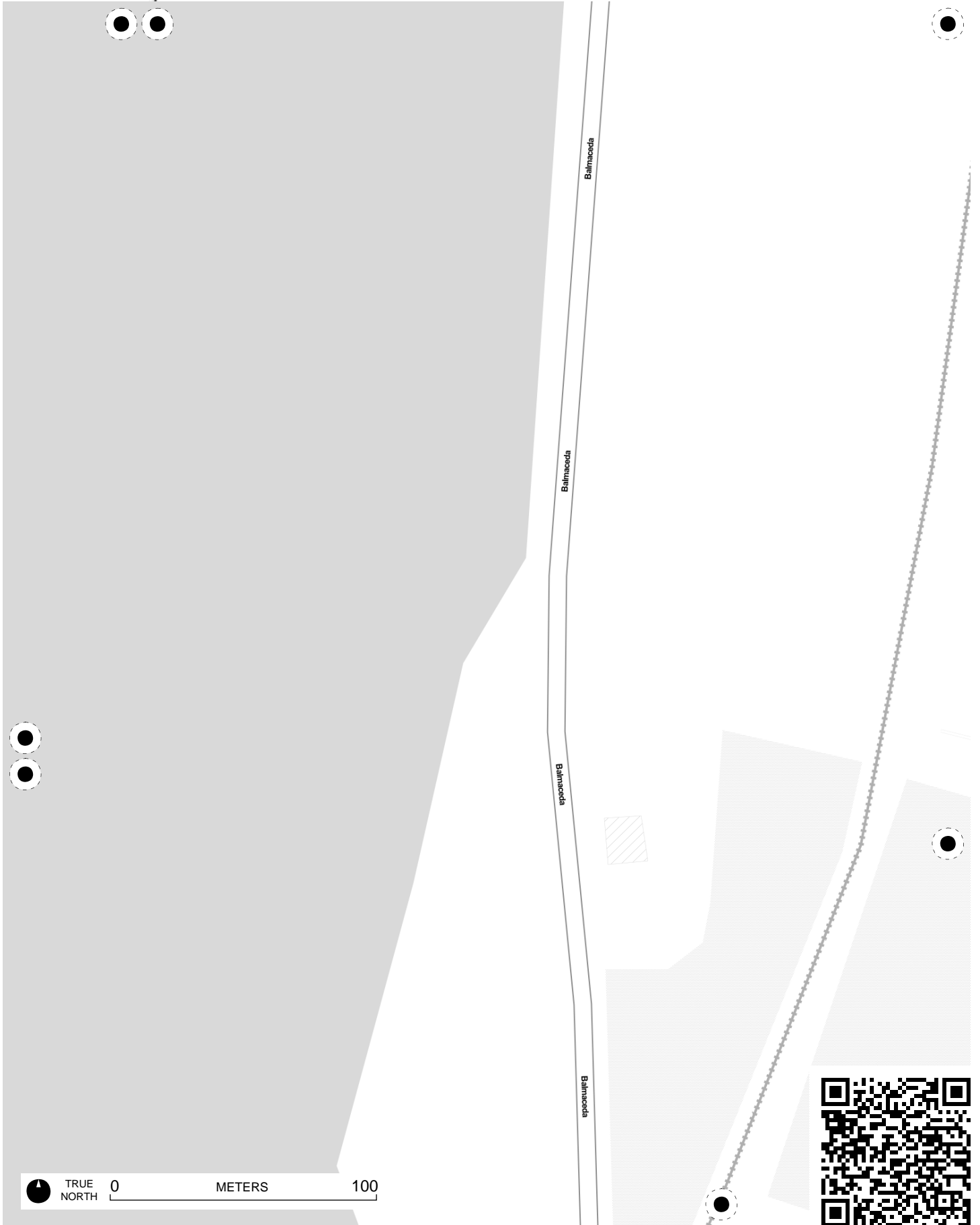

Field Papers

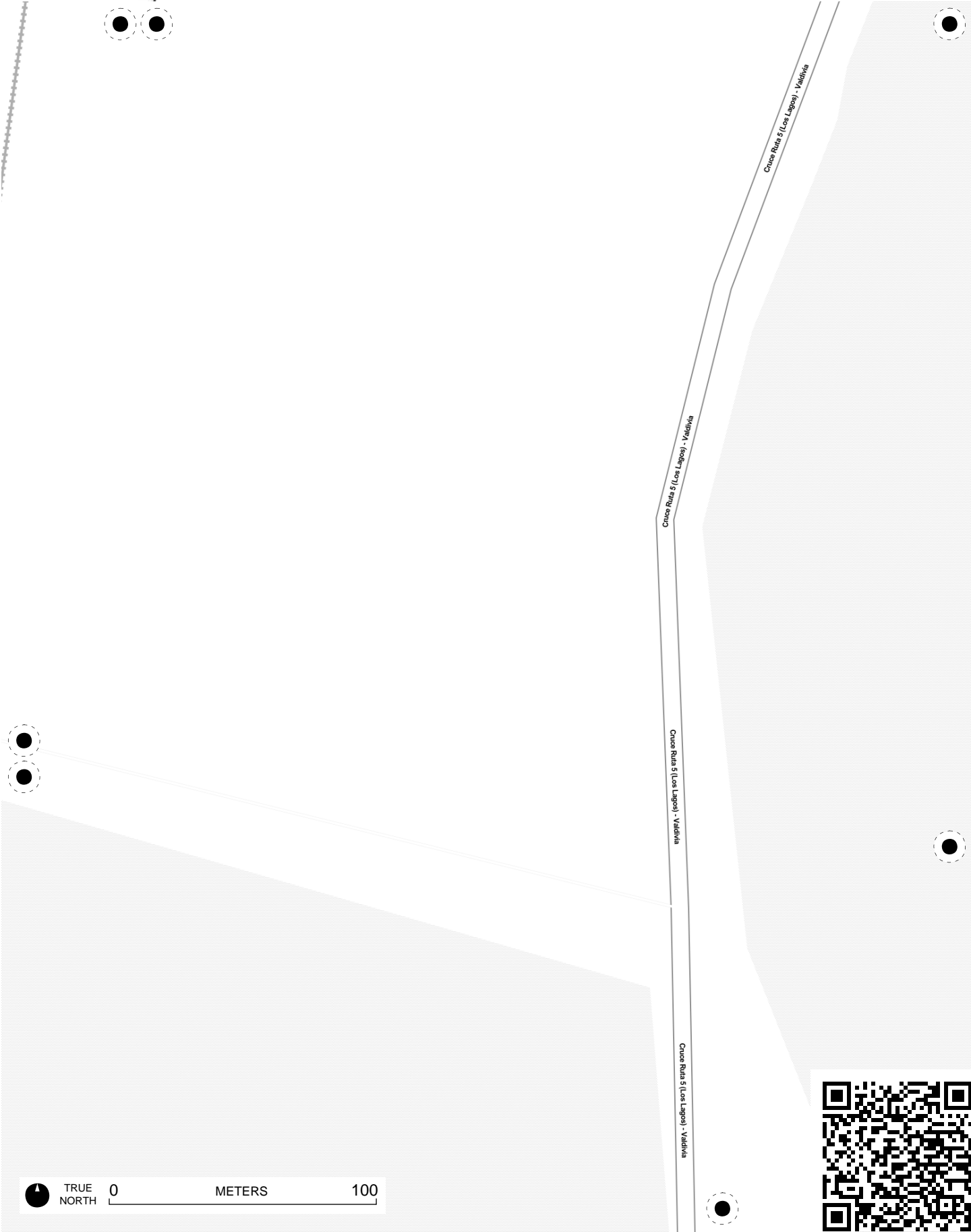

TRUE NORTH 0 METERS 100



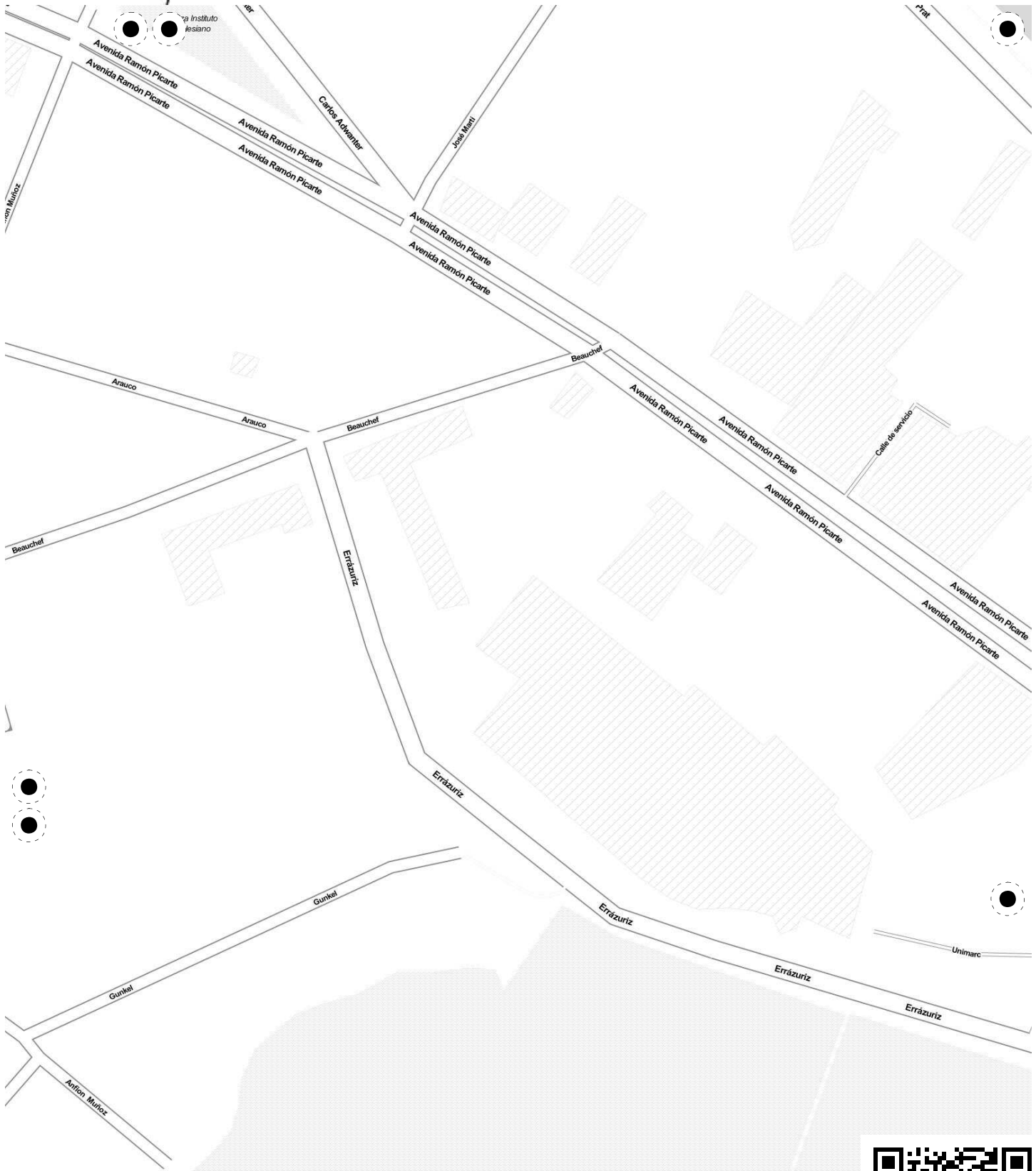

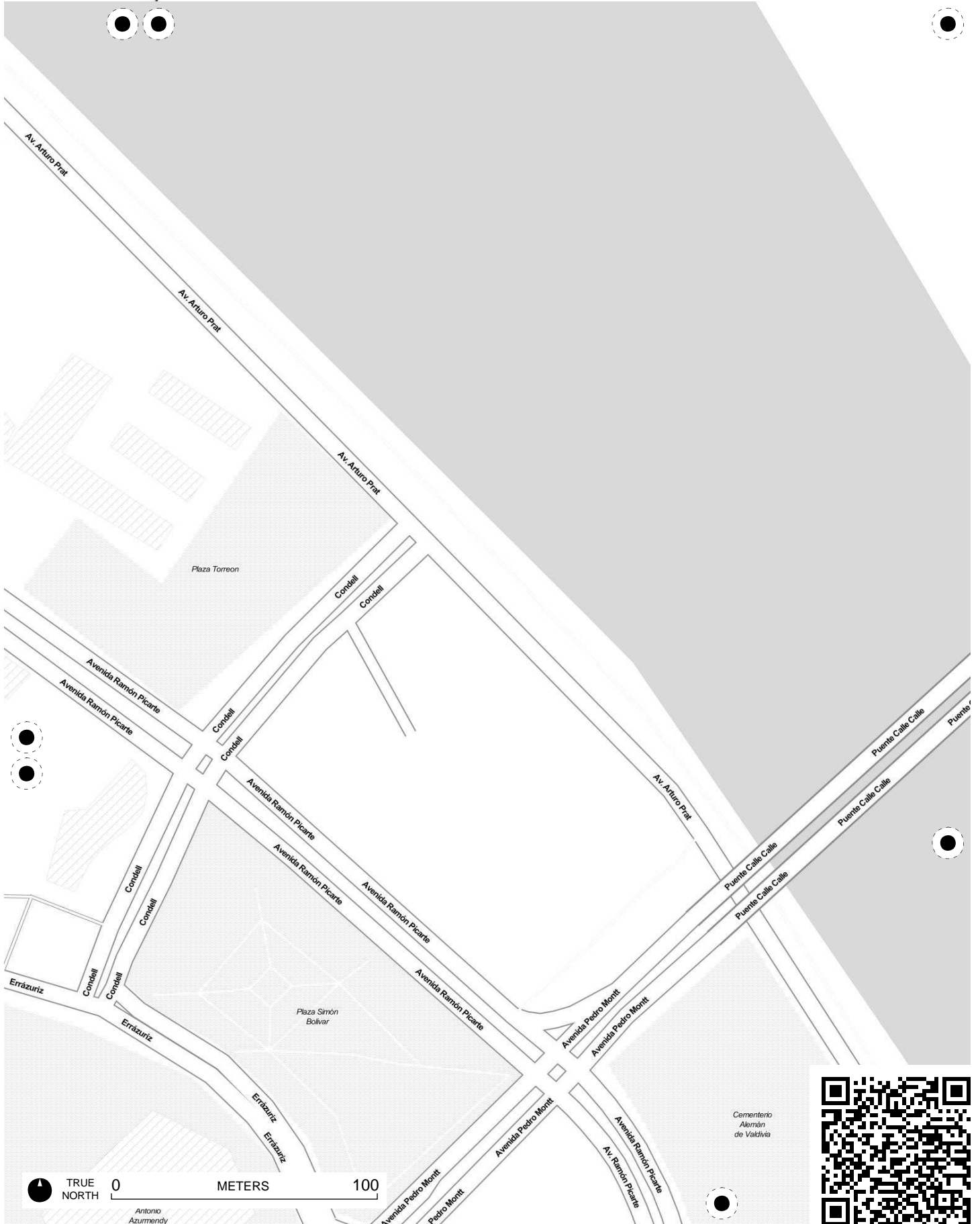

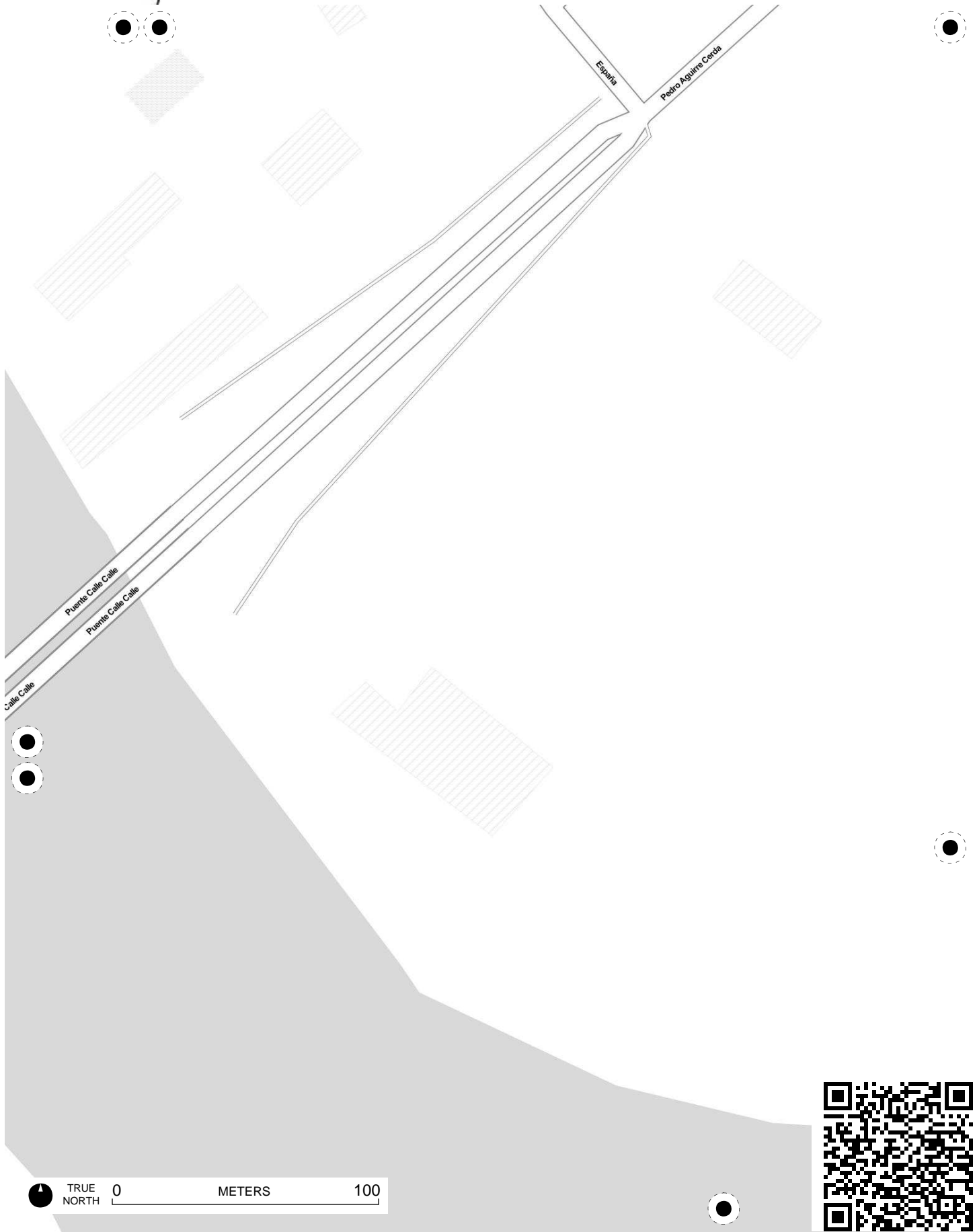

Field Papers

Untitled

<http://fieldpapers.org/atlasses/5lo1ggls/G4>

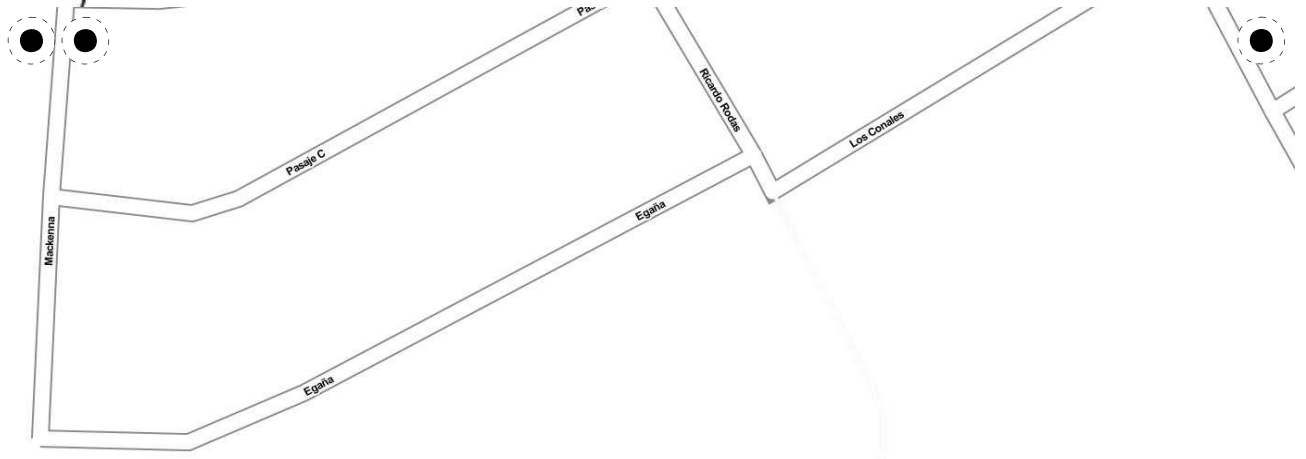

TRUE NORTH 0 METERS 100



Field Papers

Untitled

<http://fieldpapers.org/atlas/5lo1ggl/G5>

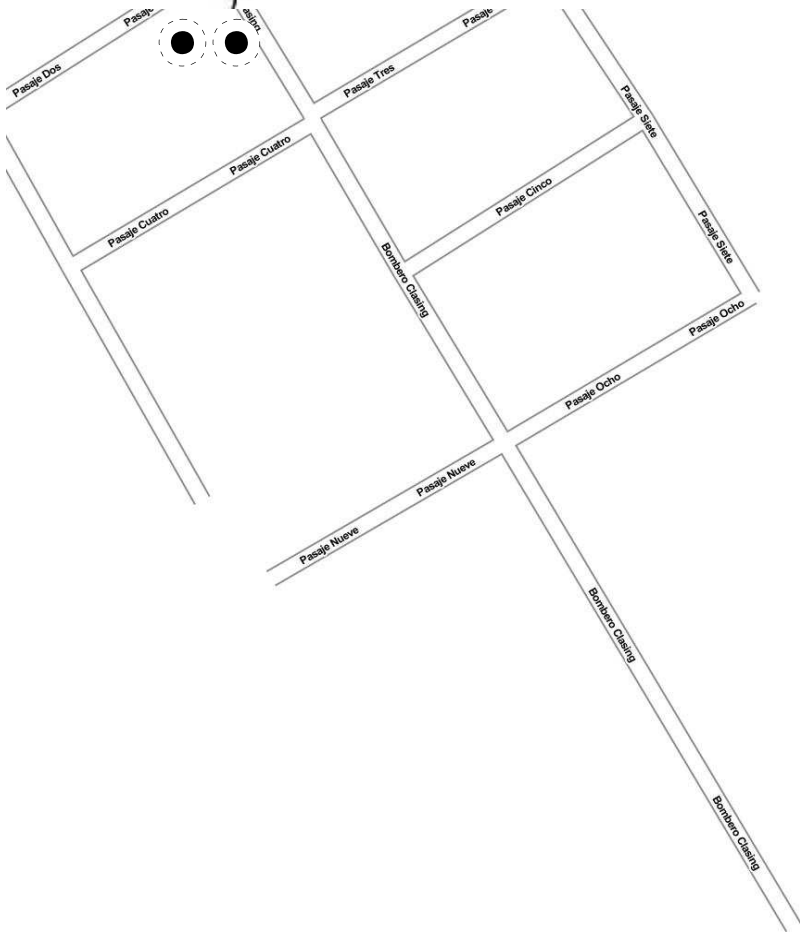

TRUE NORTH 0 METERS 100



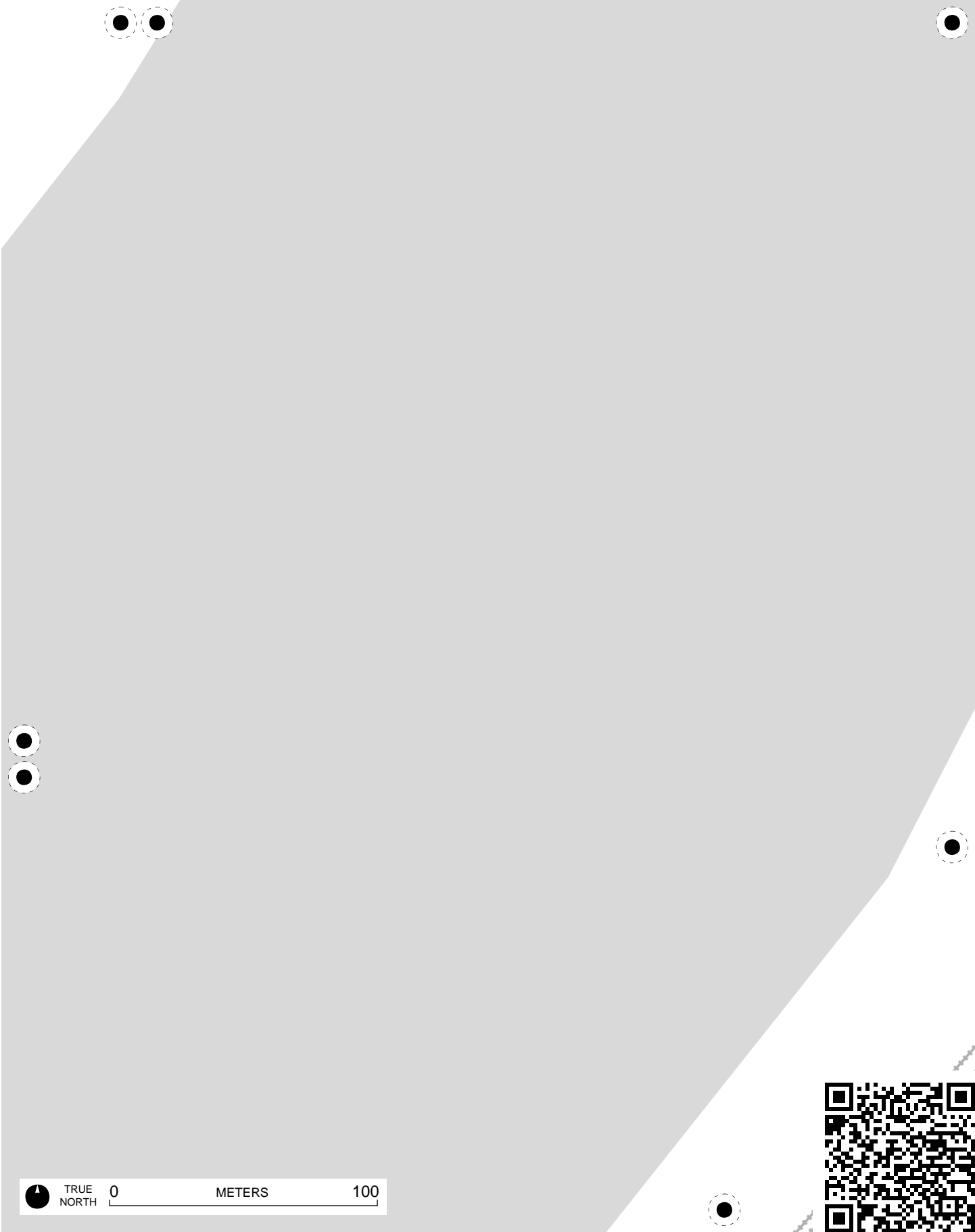

TRUE NORTH 0 METERS 100





