



FTTH Deployment Assessment

Prepared for: **CORNING**

October 13, 2009

"We Make Strategy Work"

Corning has engaged CSMG to analyze and provide comment on the investment required to deploy fiber-to-the-home (FTTH) networks in the US

Background and Objectives

- As a strategy consulting firm specialized in telecommunications and technology, CSMG has considerable knowledge and experience working with communication service providers across varied wireline and wireless network technologies and economic models
 - We have specific expertise building and evaluating models for FTTH economics and deployment
- Today we plan to present the results of our assessment of the following topics:
 - FTTH network architecture and drivers for investment required
 - Distribution of US households by density
 - CSMG’s investment estimate for deploying FTTH to US households
 - Comparison to the FCC’s recent investment estimates for providing universal availability of FTTH
- Please note: CSMG acknowledges the fundamental limitations of our analysis and commentary
 - Full detail on the FCC’s methodology for estimating FTTH deployment investment is not available. Our analysis of FCC estimates is therefore limited
 - The investment required to deploy FTTH in the least dense 20% of areas is difficult to estimate due to the lack of existing deployments and published data. We have therefore focused on the remaining 80% of HHs in our analysis and recommendations

Summary Findings

- CSMG suggests the following approach for estimating the investment required for widespread FTTH deployment in the US:
 - Considering households as the basis for connection, rather than housing units (which include secondary homes)
 - Accounting for existing FTTH builds and planned deployments through 2015
 - Assuming reasonable levels of service uptake for FTTH (42% of homes passed) in determining cost to connect to each home
 - Focusing on the 80% most dense US households for planned FTTH deployment
 - Reflecting cost and efficiency improvements achieved by FTTH vendors and service providers over the past 5 years



FTTH architectures are based on several components whose investment requirements vary based on the interplay of multiple factors

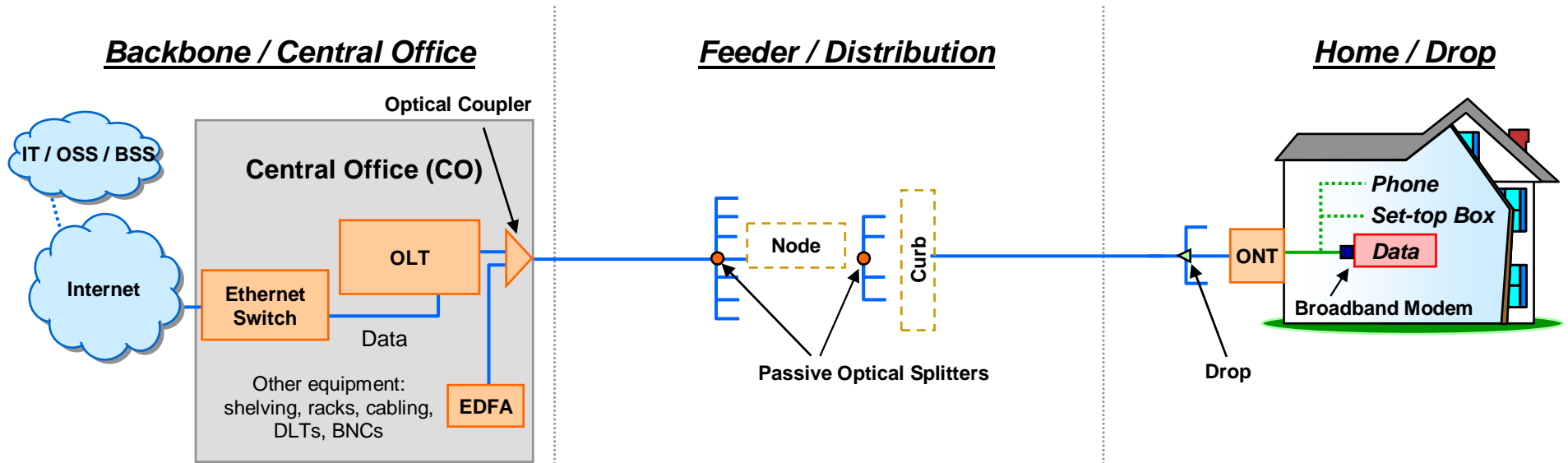

COST COMPONENT	<ul style="list-style-type: none"> • OLT • Backbone (allocation) • CO Labor (installation) • Other CO Equipment (passive and active components) 	<ul style="list-style-type: none"> • Feeder and Distribution Fiber Costs • Feeder and Distribution Fiber Labor Costs • Passive Optical Components 	<ul style="list-style-type: none"> • Drop Fiber Cost • Drop Fiber Installation Cost • ONT • Broadband Modem Cost
	COSTS VARY BY	<ul style="list-style-type: none"> • Homes per CO • Subscribers per CO • Labor and equipment cost/efficiency improvement over time 	<ul style="list-style-type: none"> • Length of feeder and distribution fibers • Extent of buried vs. aerial plant • Labor and equipment cost/efficiency improvement over time

Factors that increase the FTTH investment required include: lower household density, greater linear distance between households, fewer homes per CO, higher service uptake, more buried plant

Source: CSMG analysis

Note: The pictured architecture is not specific to any single vendor, but instead is representative of the topology for a typical FTTH build in the US

FTTH investment requirement estimates based on large-scale deployments and US averages place the cost to pass at ~\$700 per HH and cost to connect at an incremental ~\$650 per subscriber HH

2009 Benchmarks - FTTH Cost to Pass or Connect – Urban and Suburban Builds

Carrier / Analyst Estimate	Cost to Pass per HH	Incremental Cost to Connect Per HH
Verizon FiOS	\$ 700	\$ 650
Jaguar Communications (Minnesota) ¹	\$ 474	\$ 586
Hiawatha Broadband (Minnesota) ²	\$ 800	\$ 750
Analyst Estimate - SNL Kagan	\$ 697	\$ 412
VARIATION IN COST	\$474 - \$800	\$412 - \$750

1. Jaguar Communications market - Blooming Prairie City MN (their sole urban market)
 2. Hiawatha Broadband markets – Winona, Wabasha, St.Charles, Stockton, Lewiston, Rollingstone (all in MN)

2009 Benchmarks - FTTH Cost to Pass and Connect – National Large Scale FTTH Deployments and Estimates

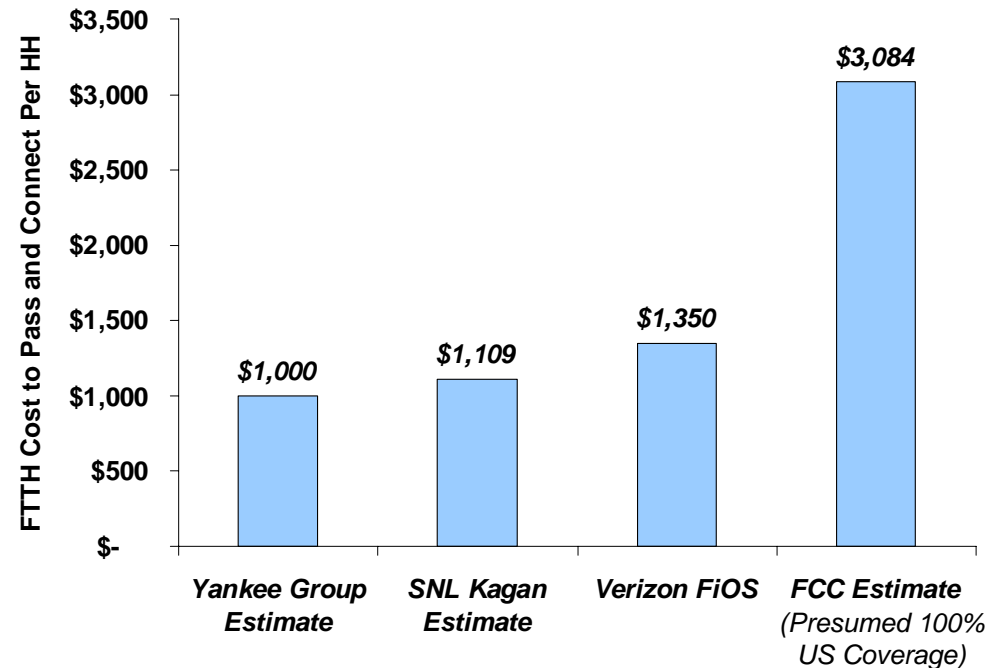

- These figures are representative of realized investment requirements for deployment in relatively dense territories, reflecting the focus of FTTH builds to date in the US
- Verizon’s original FiOS deployment was planned for 54% of VZ territory (prior to recent rural line divestitures); Verizon territory pre-divestiture compares roughly to the US as a whole in terms of population densities
- Deployment to more sparsely populated areas will likely surpass these levels of investment, though there are pockets of density and unit deployment costs are often much lower in rural areas
- Note that estimates of the cost to pass AND connect involve assumptions about service uptake rates, which may account for variation in these figures

Source: FCC Filings, SNL Kagan, Yankee Group, CSMG Analysis 1. FCC estimate per HH based on total cost of \$350B for universal availability to 113.5M housing units (mean of 111-116M)

Investment requirements for FTTH have decreased substantially over the past few years and vary considerably depending on the topography being served

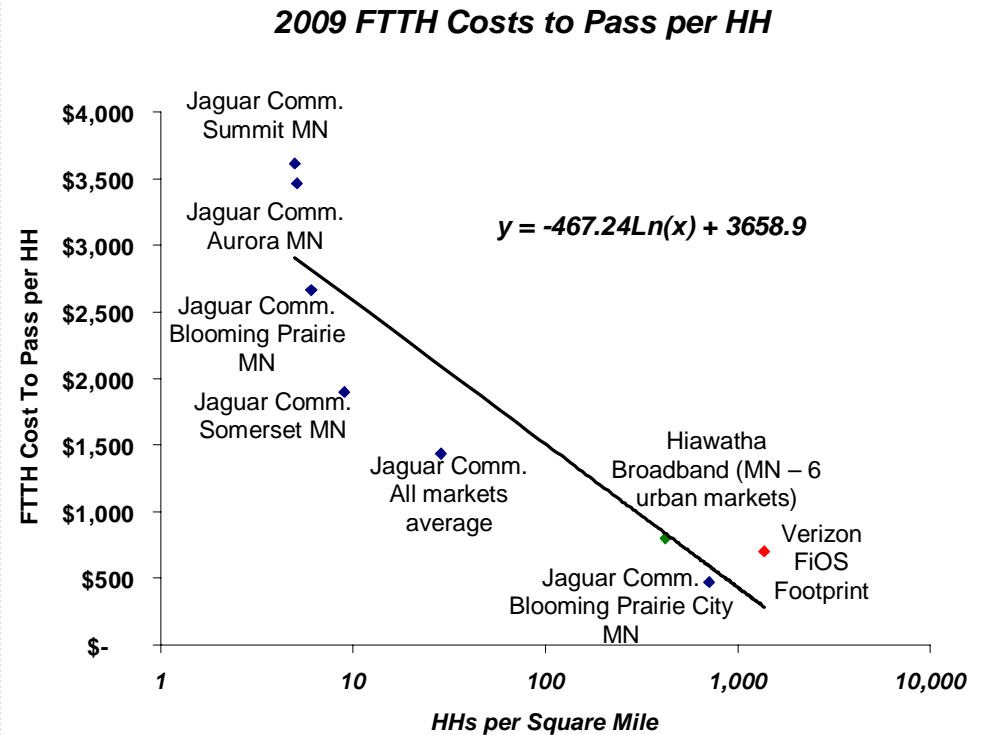
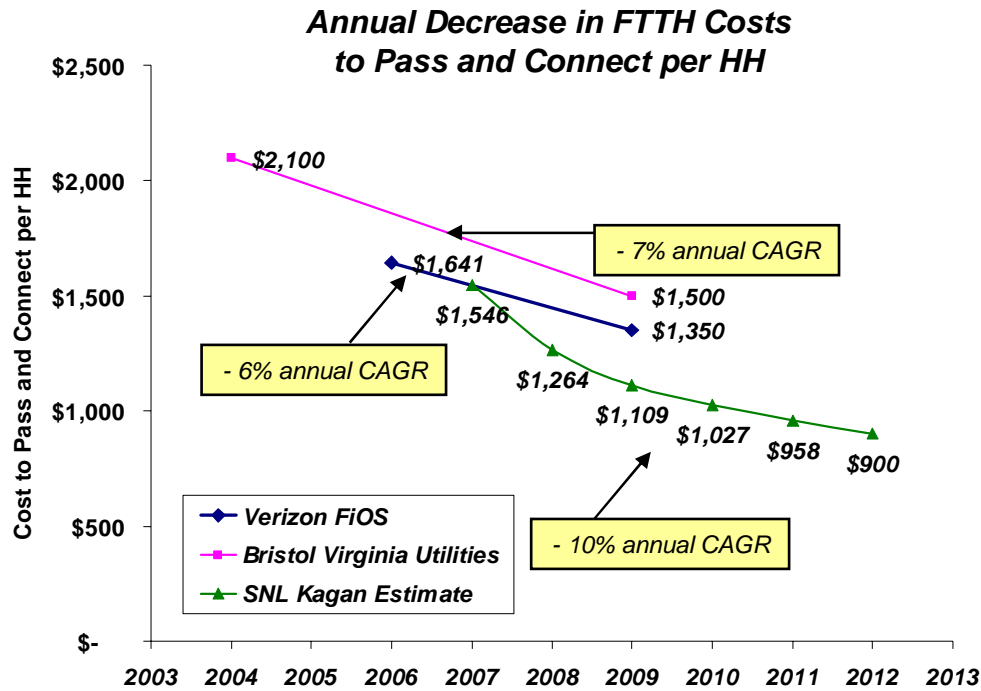

- These reductions in investment required over time are driven by three major factors:
 - Field efficiency improvements by service providers through improved procedures, training and use of innovative labor-saving methods
 - Materials cost reductions through increasing purchase volumes and manufacturing efficiency
 - Fixed cost allocation across a larger number of passed households and subscribers
- It is noteworthy that multiple service providers (not just Verizon) have achieved cost declines – we expect future deployments by other service providers to reap many of these benefits

- We observe a 5X difference in FTTH costs per HH passed over the range of HH densities with publicly reported data
- This range of densities represents a wide spectrum of HH densities from rural (5 HHs per sq. mile) to urban (1,375 HHs per sq. mile)

Source: FCC Filings, SNL Kagan, CSMG Analysis

The vast majority of US households exhibit similar density characteristics, with only ~10% likely to drive significantly higher network deployment investments

FCC – Distance Between US Housing Units

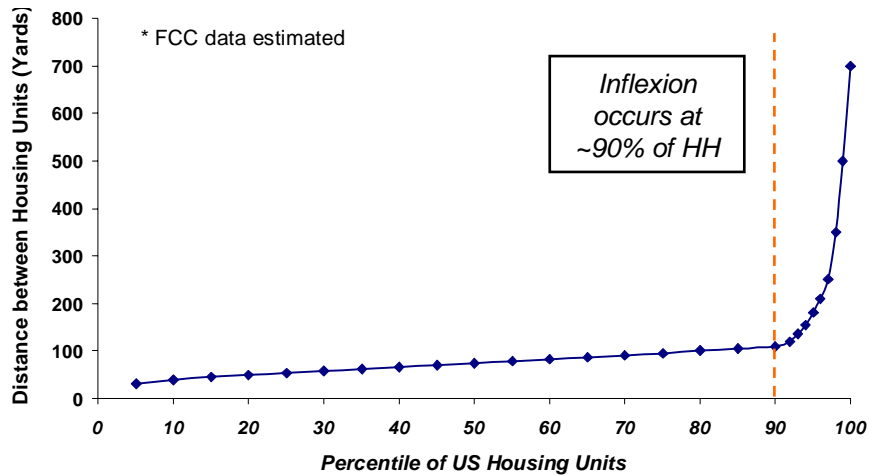

US Population & Land Distribution, 2000

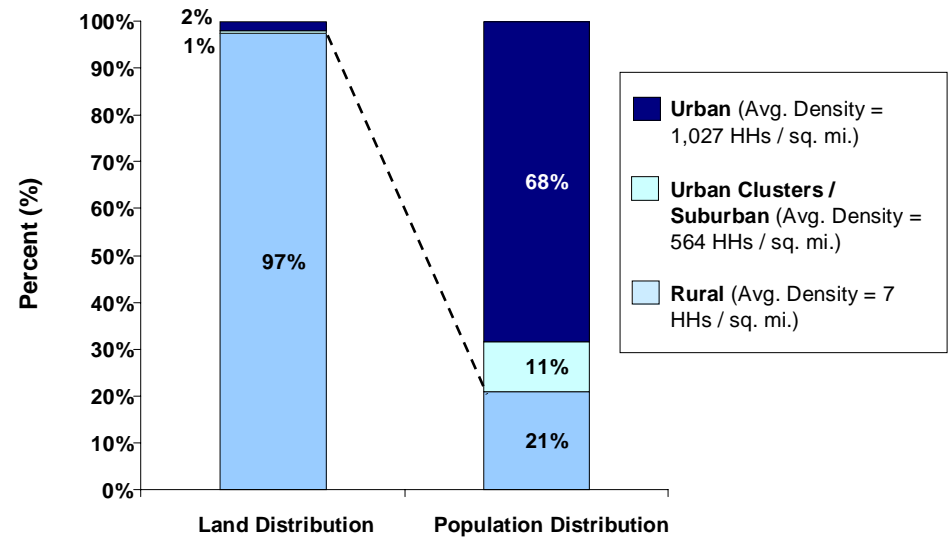

CSMG – US Wirecenter Coverage Area (Sq. Mi.) per HH

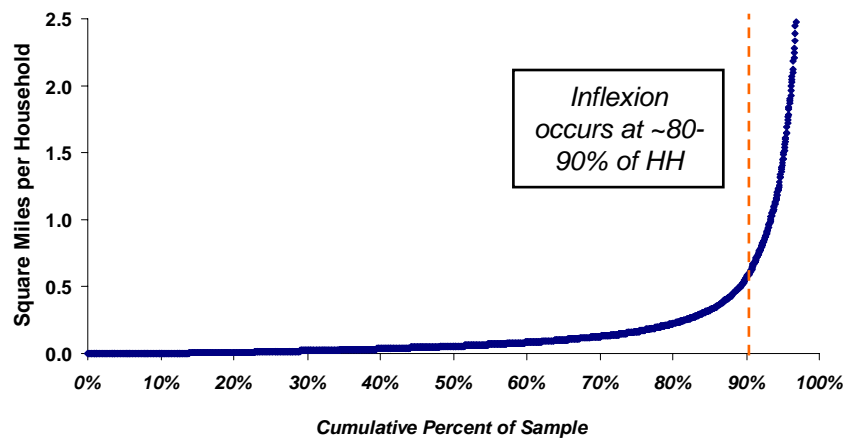

- Rural areas in the US contain 21% of the population, but cover 97% of the land. The urban population (79% of total) inhabits <3% of total land area
- A substantial proportion of FTTH build investment requirements are driven by household density and distance from CO
- CSMG and FCC data shows that US HHs are relatively evenly distributed, with only the most rural ~10% becoming significantly more sparse
 - Suggests the vast majority of HHs can be built out at reasonable cost

Source: US Census Bureau, FCC, CSMG Analysis

FTTH deployment investment requirements for rural areas are difficult to estimate due to variations in household distributions (clustering) within even the most sparsely populated areas

Example Rural Localities & Household Density

Example Locality	Burwell, NE	Lancaster, NH	Jamestown, TN
County Name	Garfield County, Nebraska	Coos County, New Hampshire	Fentress County, Tennessee
County HH Density	1.4 HHs per sq. mi.	7.8 HHs per sq. mi.	13.4 HHs per sq. mi.

- Broad classifications of locality type (rural vs. urban) and density metrics may be poor indicators of the investment required to deploy FTTH to a community, as population and households can exhibit differing levels of clustering
 - The highest-cost 20% of households to serve will largely but not uniformly be in rural areas

Source: Google Earth, US Census Bureau, CSMG Analysis

Estimated investment required for widespread FTTH deployment

- The basis for universal broadband service should be US households – not housing units
- There are currently 18 million US households with FTTH availability, plus an additional 16.5 million forecasted by 2015 funded by private capital. All 34.5 million should be considered in estimates for universal availability requirements
- Based on current FTTH build investment requirements (FiOS and rural providers), CSMG estimates that the average cost to pass and connect all but the 20% most expensive remaining non-FTTH households in 2015 is ~ \$1,704 per HH
- The incremental cost to connect will only be incurred for a subset of homes passed, reflecting FTTH service uptake levels. FTTH penetration short of 100% is recommended -- CSMG estimates 41.5% based on current benchmarks and forecasts
- The cost to pass and connect the most rural areas could be significantly higher than the cost of FTTH deployment in non-rural areas
- Though future efficiencies in deployment practices and technology are expected to decrease the cost to connect each FTTH HH, these have not been factored into the estimation for investment required

NOTES:

1. Current 2009 FiOS Cost to pass per HH
2. Current urban and rural FTTH costs to pass per HH benchmarks
3. 2009 urban and rural FTTH provider cost to connect per HH benchmarks
4. Analyst estimate of expected 2015 FTTH uptake rates

FTTH Network Deployment Costs per HH

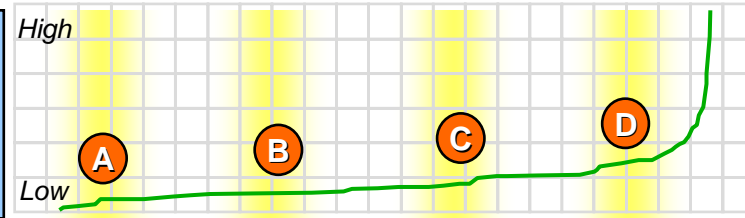

	Like FiOS to Date	More Costly	Significantly More Costly	Not Evaluated
# 2015 HHs not already Covered by FTTH (M)	34.3	19.1	14.0	25.4
Average HHs Per Sq. Mile	879.5	174.9	71.9	NA
Percentiles Covered	28-54%	55-69%	70-80%	81-100%
Modeled Cost to Pass per HH	\$700 ¹	\$1,246 ²	\$1,661 ²	NA
Incremental Cost to Connect per Sub³	\$650	\$650	\$650	NA
Assumed Penetration⁴	41.5%	41.5%	41.5%	NA
Cost to Pass (\$B)	\$24.0B	\$23.7B	\$23.2B	NA
Cost to Connect (\$B)	\$9.3B	\$5.1B	\$3.8B	NA
Total Investment Requirement (\$B)	\$33.3B	\$28.9B	\$27.0B	NA

Total Investment
\$89.2B

Comparable national programs are largely focused on deploying next generation broadband networks to 75%-90% of HHs

International Broadband Initiatives

Country	Date	Network Type	Speeds	Coverage
Australia	2009-2017	Fiber Backbone and Last Mile	100 Mbps download	90% homes and businesses
France	2009-2012	Fiber Backbone and Last Mile	NA	~33% homes and businesses
Germany	2009-2014	Universal Broadband Coverage	50 Mbps download	75% homes and businesses
Korea	2009-2012	Fiber Last Mile	1 Gbps download	100% homes and businesses
Malaysia	2007-2017	Fiber Backbone and Last Mile	10 Mbps+ download	38% homes and businesses
New Zealand	2009-2019	Fiber Backbone and Last Mile	100 Mbps download	75% homes and businesses
Singapore	2009-2015	Fiber Backbone and Last Mile	1 Gbps download	100% homes and businesses
UK	2009-2017	Next Generation FTTC	24-100 Mbps	75% homes and businesses

Most comparable programs target less than full deployment

Most comparable programs focus on enabling next-generation networks

Sources : SNL Kagan, AFP, NY Times, Australian and New Zealand Gov't websites, BSG, FTTH Council, Metro UK, Telekom Malaysia, Infocomm Development Authority of Singapore, Telecompaper, Screendigest, CSMG Analysis



A TMNG Global Company

**1 Boston Place, Floor 31
Boston, MA 02108 USA
+1 617 999.1000**

**Descartes House, 8 Gate Street
London WC2A 3HP UK
+44 207 430 7710**

www.csmg-global.com