

INSTALLATION INSTRUCTION

Item No. :867-4V

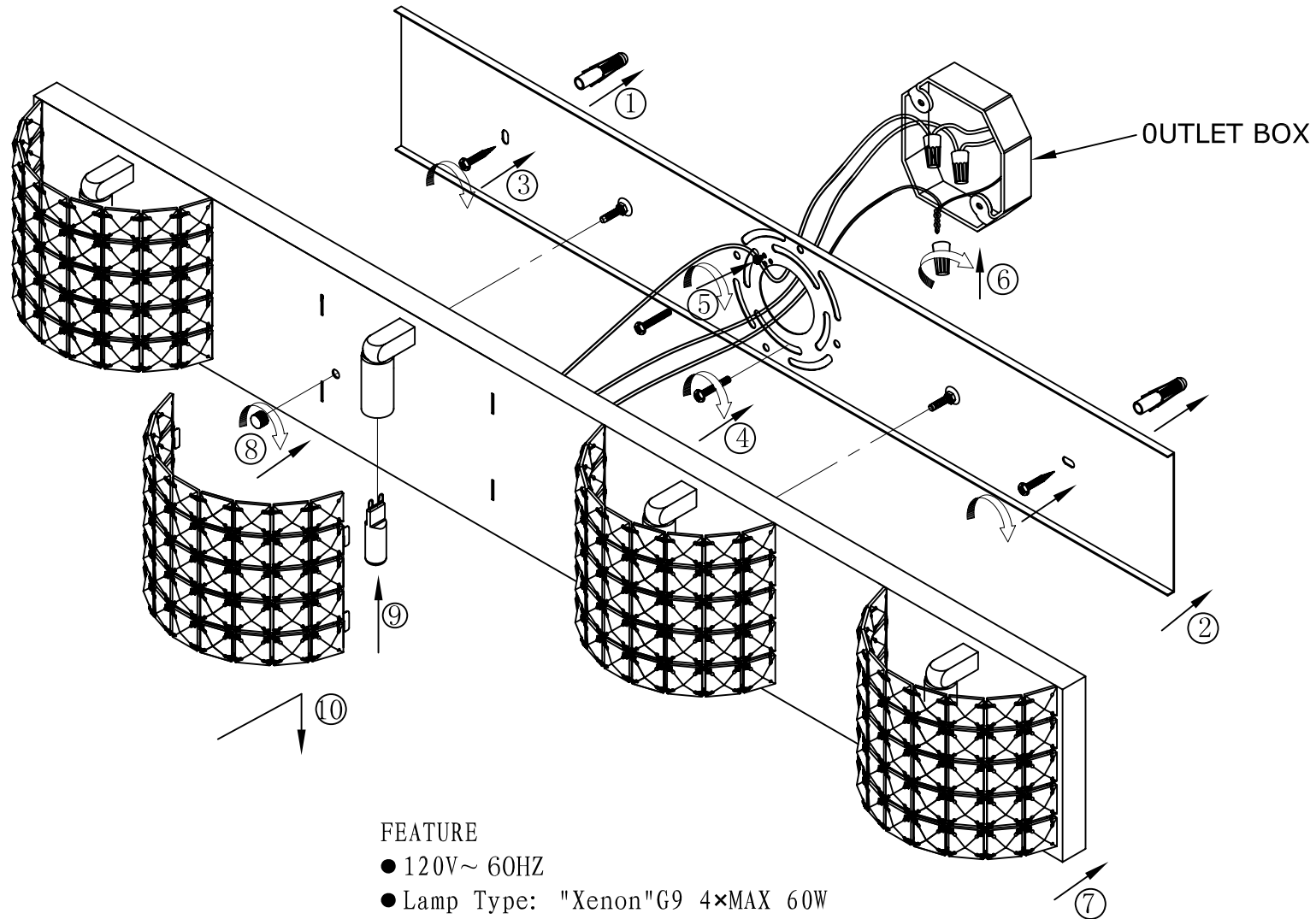

FEATURE

- 120V~ 60HZ
 - Lamp Type: "Xenon"G9 4×MAX 60W
- The lamp is for indoor use only